

LED Tail Lights - Model 234

PRODUCT INFORMATION

Description	12-24V DOT LED Heated Reverse Light
Height	42.55 mm / 1.68 in
Width	110.14 mm / 4.34 in
Depth	20.28 mm / 0.8 in
Shape	Round
Outer Lens Material	Polycarbonate
Outer Lens Color	Clear
Housing Material	Polycarbonate
Housing Color	Black
Connector or Wiring	AMP 282087-1
Mating Connector	None. 3-Pin AMP Connector (#282087-1) sold separately.
Product Weight	0.31 lbs / 0.14 kgs
Shipping Weight	1.10 lbs / 0.5 kgs



LED Tail Lights - Model 234

PRODUCT DIMENSIONS

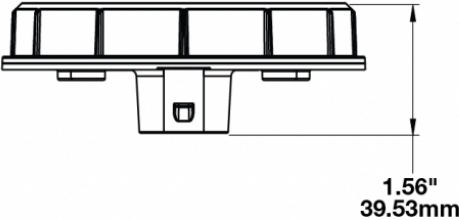
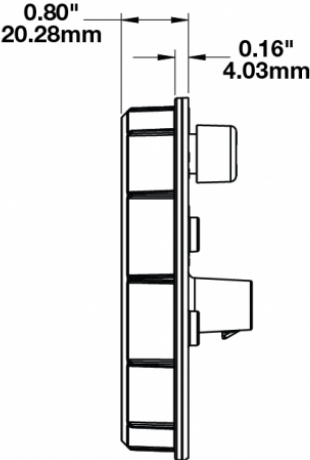
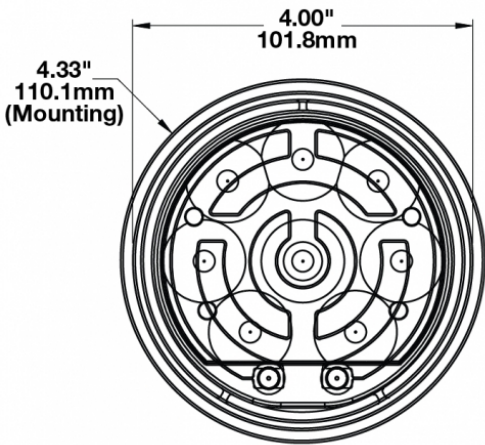

Pin Out Information

LIGHT (Socket shown ↑ top)

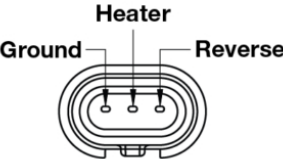

WIRE HARNESS*

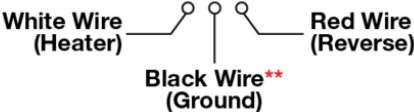

*Wire harness sold separately on Part # 0346471.
 Wire harness included on Part # 0346474.
 Also available as a single accessory (Part # 3270501)

**To operate heating circuit on the Reverse Lamp, a separate constant 12V DC power line must be wired.

LED Tail Lights - Model 234

ELECTRICAL SPECIFICATIONS

Input Voltage	12-24V DC
Operating Voltage	10-32V DC
White Wire	Ground
Black Wire	Heater
Red Wire	Turn
Current Draw	1.3A @ 12V DC (Reverse) 0.7A @ 24V DC (Reverse) 0.9A @ 12V DC (Heater) 0.5A @ 24V DC (Heater)

REGULATORY STANDARDS COMPLIANCE

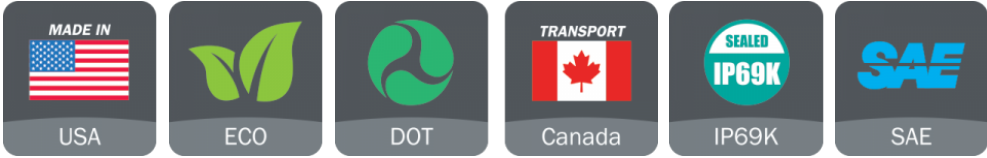

Buy America Standards
FMVSS 108 Table XII
SAE J593

Eco Friendly
IEC IP69K

PHOTOMETRIC SPECIFICATIONS

Effective Lumen Output 7

APPLICATIONS



LED Tail Lights - Model 234

SMARTHEAT™ HEATING SYSTEM

The SmartHeat™ heating system senses ambient temperature and turns the integrated heating system in the lens on & off. This system actually clears ice & snow twice as fast as conventional halogen lamps.

When does the heater turn on?

Heater turns on or off according to temperature changes and vehicle power:

- Heater will turn on when temperatures drop, generating enough heat to prevent ice build-up.
- Heater will turn on when powering up, de-icing the light as rapidly as possible.

When does the heater turn off?

Heater will turn off when it senses temperatures increase and are above the high temperature threshold.

See Additional Information on page 1 for heated wire installation

ACCESSORIES



Part Number
4242731
4" Round Rubber
Mounting Grommet
for Model 234



Part Number
5869401
4" Round Plastic
Mounting Flange for
Model 234

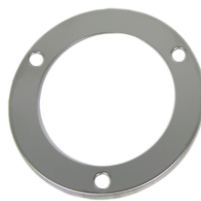

Part Number
8200441
4" Round Stainless
Steel Trim Ring for
Model 234



Part Number
8200451
4" Round Chrome
Plastic Trim Ring for
Model 234



Part Number
3270501
3-Pin AMP Connector
(#282087-1) Wire
Harness Assembly

LED Tail Lights - Model 234

RELATED PRODUCTS



Part Number
0346261
12-24V DOT LED
Heated Stop, Tail, &
Turn Light



Part Number
0346264
12-24V DOT LED
Heated Stop, Tail, &
Turn Light Kit with
Harness



Part Number
0346421
12-48V DOT LED Non-
Heated Stop & Tail
Light



Part Number
0346474
12-24V DOT LED
Heated Reverse Light
Kit with Harness



Part Number
0347811
12-24V DOT LED
Heated Turn Signal



Part Number
0347814
12-24V DOT LED
Heated Turn Signal Kit
with Harness



Part Number
0347861
12-24V DOT LED Non-
Heated Stop, Tail, &
Turn Light



Part Number
0347864
12-24V DOT LED Non-
Heated Stop, Tail, &
Turn Light Kit with
Harness