

KUKKO // *Pull forward*



# Product overview

## **BALL JOINTS EXTRACTOR**



# BALL JOINTS EXTRACTOR

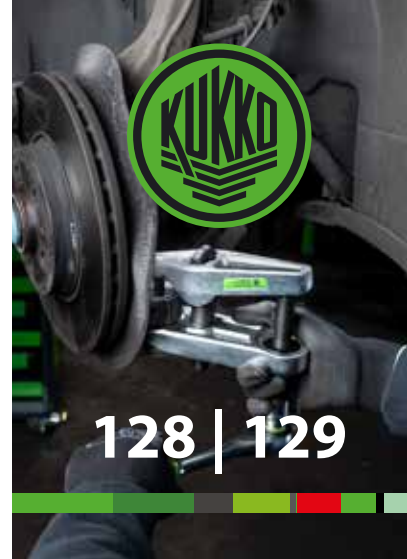
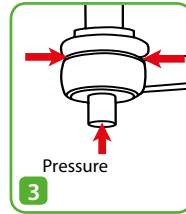
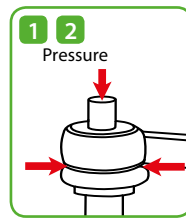
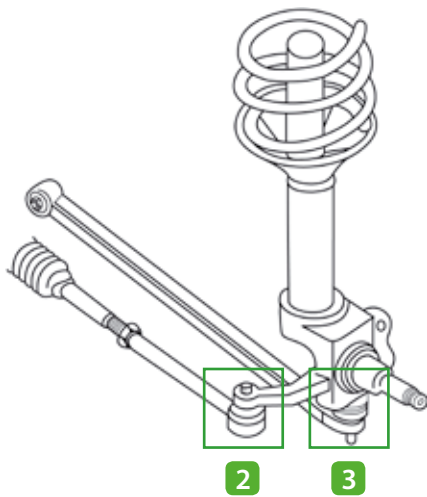
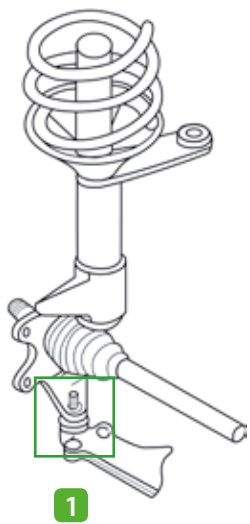

## 2 3 AREAS OF APPLICATION

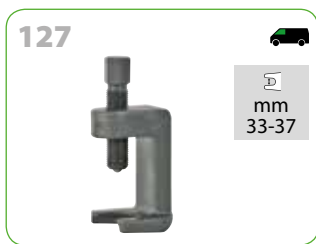

## 1 2 3 AREAS OF APPLICATION

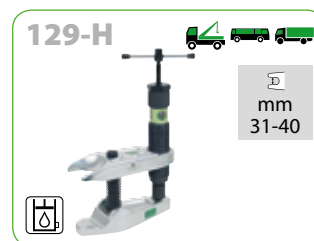

 35 - 45 mm

 120 mm

 40 mm

schwere LKW's,  
Busse,  
Niederflurbusse von  
DAF, IVECO, MAN,  
Mercedes, Renault,

 50 mm

für  
für

Scania, Volvo /  max. 210 Nm  
heavy trucks, busses,  
low-floor buses DAF,  
IVECO, MAN,  
Mercedes, Renault,  
Scania, Volvo

max. 10 t

 7.96 kg

metric  imperial

schwere LKW's,  
Busse,  
Niederflurbusse von  
DAF, IVECO, MAN,  
Mercedes, Renault,  
Scania, Volvo /  
heavy trucks, busses,  
low-floor buses DAF,  
IVECO, MAN,  
Mercedes, Renault,  
Scania, Volvo

 1 3/8 - 1 3/4  
inch

 4 3/4 inch

für  
für

Scania, Volvo /  
heavy trucks, busses,  
low-floor buses DAF,  
IVECO, MAN,  
Mercedes, Renault,  
Scania, Volvo

 max. 154.8 ft lb

max. 11 US t

metric  imperial

## Spare part

[1294514](#)

Frame

[1294531](#)

Clamping lever

[129456L](#)

Mechanical screw

[1294526L](#)

Screw with adapter

[129-5-45-ERS](#)

Spare part