

KUKKO // *Pull forward*



Product overview

BALL JOINTS EXTRACTOR



BALL JOINTS EXTRACTOR

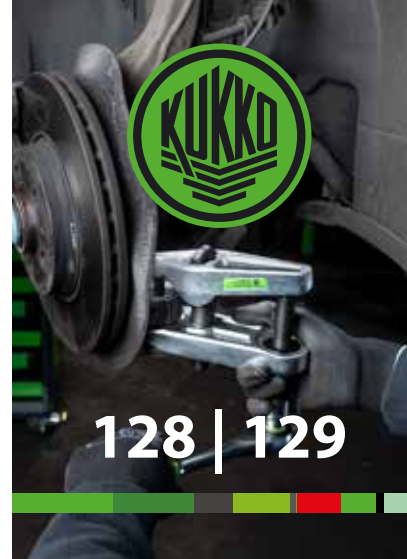
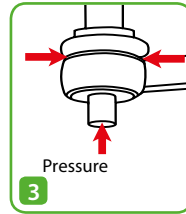
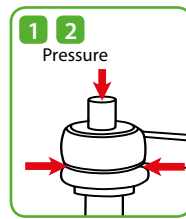
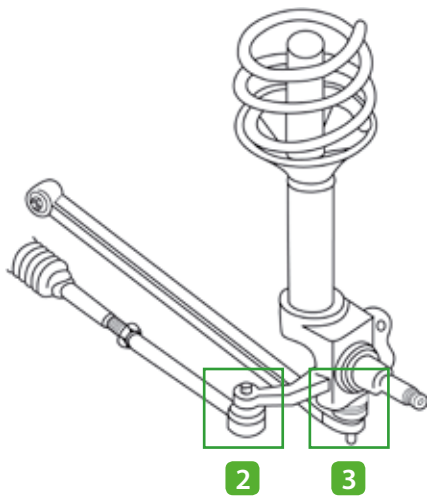
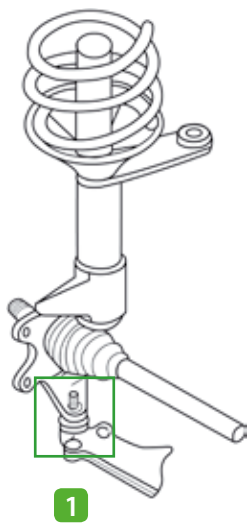

2 3 AREAS OF APPLICATION



1 2 3 AREAS OF APPLICATION

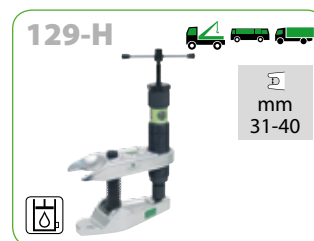

 50 mm

 120 mm

 50 mm

schwere LKW's,
Busse,
Niederflurbusse von
DAF, IVECO, MAN,
Mercedes, Renault,

 60 mm

für
für

Scania, Volvo /  420 Nm
heavy trucks, busses,
low-floor buses DAF,
IVECO, MAN,
Mercedes, Renault,
Scania, Volvo

max. 20 t

 6.84 kg

metric imperial

schwere LKW's,
Busse,
Niederflurbusse von
DAF, IVECO, MAN,
Mercedes, Renault,
Scania, Volvo /
heavy trucks, busses,
low-floor buses DAF,
IVECO, MAN,
Mercedes, Renault,
Scania, Volvo

 2 inch

 4 3/4 inch

für
für

Scania, Volvo /
heavy trucks, busses,
low-floor buses DAF,
IVECO, MAN,
Mercedes, Renault,
Scania, Volvo

max. 309.7 ft lb

max. 22 US t

metric imperial

Spare part

[1294531](#)

Clamping lever

[129456L](#)

Mechanical screw

[1294526L](#)

Screw with adapter

[129-5-45-ERS](#)

Spare part

[1295014](#)

Frame