

# mityvac®

**AUTOMOTIVE  
TEST & BLEED KIT  
MODEL MV8000**

---

## USER'S MANUAL



## CONTENTS

---

Service Parts & Accessories . . . . .	3
Optional Accessories . . . . .	4
The Pump . . . . .	5
The Automotive Vacuum System . . . . .	6
Diagnosing Mechanical Engine Conditions . . . . .	8
Positive Crankcase Ventilation System . . . . .	10
Fuel Pressure Regulator . . . . .	11
Exhaust Gas Recirculation (EGR) . . . . .	13
Spark Delay Valves (SDV) . . . . .	17
Electrical/Vacuum Solenoid . . . . .	18
Thermal-Controlled Vacuum Switching Valves . . . . .	18
Brake Bleeding . . . . .	20
Spanish Section . . . . .	24
French Section . . . . .	48

## SERVICE PARTS & ACCESSORIES

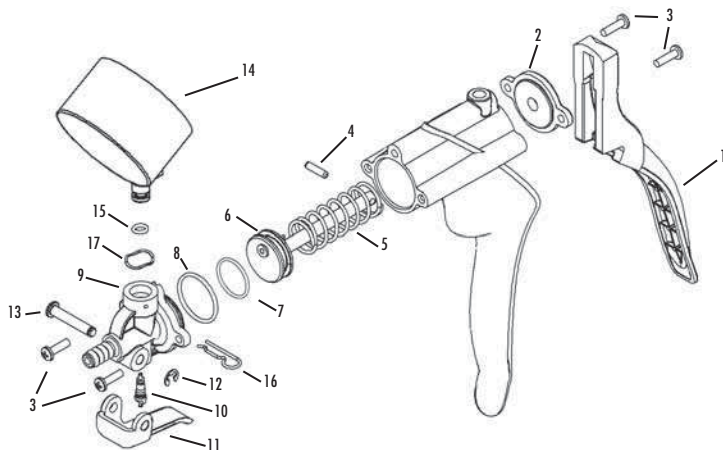

### PUMP SERVICE KITS

	824551	MVM8901	MVA6178	824552	824553	824493
1	X					
2					X	
3		X				
4		X				
5		X				
6		X				
7		X				
8		X				
9		X				
10		X				X
11				X		
12				X		
13				X		
14			X			
15			X			
16			X			
17			X			

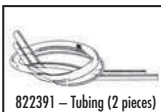

## OPTIONAL ACCESSORIES



MVA6825

MVA6832



MVA6834



MVA6000



MVA6005



MVA6845



MVA6001



MVA6007

MVA6179

MVA6180

The following optional accessories are designed to improve and expand the functionality and applications of Mityvac hand vacuum pumps.

### MVA6825 MASTER CYLINDER REFILL KIT

Automatically replenishes brake or clutch master cylinder with new fluid during vacuum bleeding procedure. Adapts to standard 12 oz and 32 oz brake fluid bottles.

### MVA6832 CLAMP-ON AUTO-REFILL KIT

Automatically replenishes brake or clutch master cylinder with new fluid during vacuum bleeding procedure. Includes 40 oz reservoir, or adapts to standard 12 oz and 32 oz brake fluid bottles. Offers improved features and functionality over MVA6825.

### MVA6834 PLATE-STYLE AUTO-REFILL UPGRADE KIT

Upgrades MVA6832 to include refill applications with limited master cylinder clearance or non-standard reservoir necks. Requires purchase of MVA6832.

### MVA6000 COMPLETE AUTOMOTIVE ACCESSORY KIT

Contains accessories for testing and diagnosing dozens of engine performance and automotive mechanical functions, and for one-person brake and hydraulic clutch bleeding.

### MVA6005 16 OZ. FLUID RESERVOIR KIT

Large 16 oz fluid reservoir kit for brake bleeding and collection and dispensing of fluids.

### MVA6845 MASON JAR KIT

Accessory kit for utilizing standard- and wide-mouth mason jars as fluid evacuation or pressure dispensing fluids.

### MVA6001 FLUID TRANSFER KIT

Contains accessories for siphoning, transferring, extracting, or dispensing fluids using a Mityvac hand vacuum and/or pressure pump.

### MVA6007 DUAL ADAPTER BLEED KIT

For simultaneous bleeding of motorcycle dual caliper brake systems.

### MVA6179 VACUUM GAUGE W/ MBAR SCALE

2-1/2" diameter gearless diaphragm gauge with 0 to -1000 millibar major scale and 0 to 30 inches Mercury scale.

### MVA6180 VACUUM GAUGE W/ KPA SCALE

2" diameter gearless diaphragm gauge with 0 to -100 kpa scale of measure.

# THE PUMP

---

The vacuum pump is an extremely versatile service tool that can be used to test a variety of automotive systems and perform a number of useful tasks. Though the pump has obvious uses for testing various vacuum motors, control valves and vacuum sources, its applications don't end there. Almost any part or system that requires proper sealing vacuum to operate can be tested with the vacuum pump. The pump and its accessories also transfer fluids, help to bleed brakes and aid in other tasks. The pump also meets diagnostic tool requirements when such tools are specified for some state vehicle inspection programs.

This section will describe the pump, give specifications, tell how to use the pump and provide some service tips to help you keep your pump in tip top-shape.

## DESCRIPTION

The hand-held vacuum pump is simple, accurate, easy to use, and has many applications. It consists of a pump body, moveable handle, vacuum gauge, and connection fitting. The pump is easily held in your hand, and when the handle is squeezed, vacuum is produced at the front fitting. If the front fitting of the pump is connected to a closed container or system, the gauge will show the vacuum level.

## VACUUM RELEASE

The vacuum can be released by lifting up on the Release Lever. This action allows air to enter the system, thus relieving the vacuum. Vacuum will also be released when the hose is detached from the front fitting.

## SPECIFICATIONS

Maximum Vacuum @ Sea Level:	Approx. 25" Hg (85 kPa)
Stroke Volume:	1 cu. in. (16cc)
Gauge Accuracy:	3%-2%-3% of full range

---

## USING THE PUMP

The pump is simple to use. In most cases, it's attached directly to a component, used in place of a vacuum line or connected into a vacuum circuit with a tee connector. The pump can be operated as a test instrument in two ways:

- 1) When vacuum is desired for a test, the movable handle of the pump is simply squeezed with your hand, as in clenching your fist. Continue strokes until desired vacuum is indicated on the gauge.
- 2) The pump can be connected into a vacuum circuit and used to measure existing amounts of vacuum, just as any vacuum gauge would be used. When used this way, do not pump the handle, or incorrect readings may result.

## PROPER CARE

Your pump is a sturdily built, precision test instrument. Do handle it carefully! Don't drop or handle roughly as the gauge accuracy may be affected. Care for your pump and it will give you years of trouble-free service.

## LUBRICATION

The factory-installed lubricant is silicone oil and should provide very long service. If you find it necessary to lubricate your pump, use silicone oil. If unavailable, you may use DOT 5 (not DOT 3) silicone-based brake fluid or a salad vegetable oil. Do not use petroleum based fluids or spray lubricants (WD-40, motor oil, etc.), as these will damage the pump.

# THE AUTOMOTIVE VACUUM SYSTEM

This manual deals with vacuum and pressure, how it is used in various automotive systems and how the vacuum pump can be used to test and diagnose these systems. This section discusses what vacuum is, how it is measured, where it comes from on an automobile, the system for distributing and using vacuum, and some troubleshooting basics.

## WHAT IS VACUUM?

Put simply, vacuum is empty space, and may exist as either a total or partial vacuum. Vacuum does not, of itself, create power. Rather, power for vacuum devices depends on the presence of atmospheric pressure. The atmosphere exerts a pressure of 14.7 pounds per square inch (psi) on everything at sea level. If a portion of the air is removed from one side of a diaphragm (partial vacuum), the atmospheric pressure will exert a force on the diaphragm. The force is equal to the pressure difference times the diaphragm area (FIGURE 1). Generally, the less air (greater vacuum) in a given space, the more the atmosphere tries to get in and the more force is created.

## HOW IS VACUUM MEASURED?

In the United States, vacuum is commonly measured in inches of Mercury (" Hg). It may also be measured in centimeters of Mercury (cm Hg) and kiloPascals (kPa). Atmospheric pressure will support a column of Mercury in a manometer gauge about 30 inches high or about 76 cm high. This is the barometric pressure in " Hg which varies as the weather changes. Vacuum readings in " Hg are really negative pressure readings. For example, 30" Hg vacuum would be a complete vacuum. Half of a complete vacuum would be 15" Hg. A gasoline engine at idle usually pulls about 16-22" Hg vacuum. On deceleration, because the throttle is closed, the vacuum will increase. The pump will pull about 25" Hg as indicated on its vacuum gauge which is calibrated in both " Hg and kPa.

## WHY ENGINES CREATE VACUUM

Vacuum is created when air is withdrawn from a given volume, or a sealed volume is increased. That is why vacuum is available in an engine. On the intake stroke, the piston moves down, this creates a partial vacuum because the volume of the

cylinder is increased. Air cannot rush through the intake system fast enough to totally fill the space created when the piston moves down (FIGURE 2). This is the most common automotive vacuum supply source.

## GASOLINE VS. DIESEL VACUUM

Because a diesel engine does not produce as much vacuum as a gasoline engine, a mechanical vacuum pump must be employed to operate vacuum devices. The pump is useful in testing devices on both types of engines.

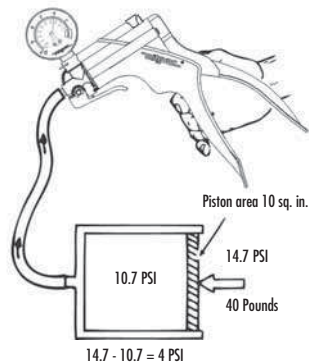

FIGURE 1:  
VACUUM VS. ATMOSPHERIC PRESSURE

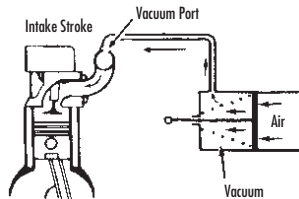

FIGURE 2: THE ENGINE AS A VACUUM SOURCE

# THE AUTOMOTIVE VACUUM SYSTEM

## VACUUM DISTRIBUTION

All modern automobiles have a vacuum distribution system (FIGURE 3), consisting of lines, hoses, fittings and vacuum devices. This system must be leak proof. If it is not, the engine air/fuel mixture will be leaned out by the extra air entering the system through the leaks, thus causing problems such as burned exhaust valves, uneven idle, stalling, pre-ignition, burned spark plugs, etc. Additionally, any vacuum operated device affected by the vacuum leak will not function properly.

A normal gasoline engine should develop 16-22" Hg of intake manifold vacuum at idle. This is an indication that the engine is breathing properly. If the vacuum is lower, the engine is running less efficiently. The lower the manifold vacuum, the less efficiently the engine is running and the lower the gas mileage will be.

The vacuum distribution system supplies vacuum to vacuum motors (servos) in the air conditioning, power brake booster, speed control servo, emission controls, manifold absolute pressure (MAP) sensor, and automatic transmission control systems. In older vehicles, vacuum is also supplied to the distributor vacuum advance or retard mechanism. These devices can be connected directly to manifold vacuum, or can be controlled through electric solenoids, thermostatic switches, or other vacuum controls.

## TROUBLESHOOTING THE VACUUM SYSTEM

Most vacuum problems can be traced to leaks, which occur in hoses, connectors, motor diaphragms or valves. Pinched lines or clogged valves will also not allow vacuum flow. Problems can also be traced to improper mechanical operation of devices driven by vacuum motors.

The vacuum pump can be used to measure the amount of vacuum in a hose. The vacuum gauge feature is very useful for detecting a fluctuating vacuum supply or a leaky hose. The vacuum pump feature enables you to check all types of vacuum operated devices.

On a vacuum motor, for example, the pump is used to evacuate the diaphragm chamber, which allows you to check the mechanical operation of the device as well as the amount of vacuum required to actuate it. Test for a leaking diaphragm by applying 10" Hg vacuum to the device (FIGURE 4). Observe the gauge to see if the needle drops after the actuator stops moving. If the needle continues to drop, a leaking diaphragm is indicated. If the diaphragm is okay, the vacuum should hold for one minute with the needle steady.

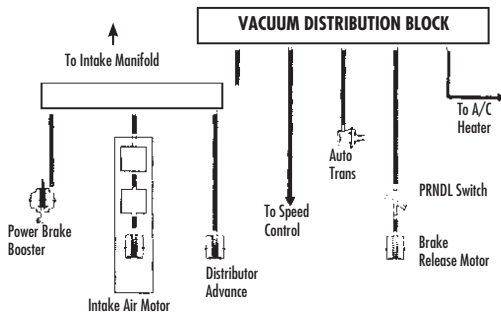

FIGURE 3: TYPICAL VACUUM DISTRIBUTION SYSTEM

# THE AUTOMOTIVE VACUUM SYSTEM

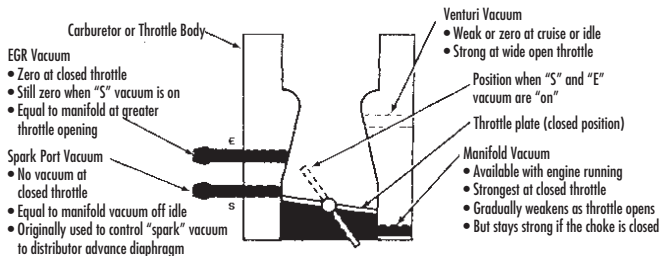

FIGURE 4: TYPICAL CARBURETOR VACUUM SUPPLY POINTS

## DIAGNOSING MECHANICAL ENGINE CONDITIONS

### VACUUM GAUGE CHECKS & DIAGNOSIS

The pump's vacuum gauge readings give indications of possible mechanical problems, but they are not foolproof. Observe the gauge carefully and follow the vacuum readings with further tests, where possible, to confirm your diagnosis.

Do not look for the engine to produce specific (numerical) amounts of vacuum. Much more important than specific numbers, are the range of the vacuum readings and the movement of the needle (FIGURE 5). Important things to notice about the needle movement are HOW the needle moves (in a smooth or jerky manner, erratic, etc.), what direction it moves, whether movement is regular or varying, and how far the needle moves.

The following gives some examples of what to look for and the meanings of a variety of vacuum gauge readings.

### NORMAL ENGINE

Run engine at idle and connect the pump to an intake manifold vacuum port. Watch the needle's movement on the gauge. At idle, the vacuum gauge reading should be 16-22" Hg and steady.

### BURNED OR LEAKING VALVE

At idle, burned or leaking valves will cause the pointer on the gauge to drop to a low reading and

return to normal at a regular interval. The needle will drop from 1 to 7" Hg at regular intervals whenever the defective valve attempts to close.

### STICKING VALVE

A sticking valve will exhibit a rapid, intermittent drop from the normal pointer indication. This is unlike the regular drop that characterizes a burned or leaking valve.

A sticking valve condition may be pin-pointed by directly applying lightweight oil to each valve guide. When the sticking valve is reached, the situation will be temporarily remedied.

### WEAK OR BROKEN VALVE SPRING

Weak valve springs are indicated when the pointer of the vacuum pump gauge fluctuates rapidly between 10" and 21" Hg at idle. The fluctuations will increase with engine speed. A broken valve spring will cause the needle to fluctuate rapidly at a regular interval. Again, this will occur every time the valve attempts to close.

### WORN VALVE GUIDES

Worn valve guides admit air which upsets the air/fuel mixture. The vacuum gauge reading will be lower than normal and will fluctuate rapidly in a range of about 3" Hg. As the speed of the engine is increased, the needle will steady.



## DIAGNOSING MECHANICAL ENGINE CONDITIONS

### LEAKING PISTON RING

Vacuum at idle will be low but steady at about 12 to 16" Hg. Open the throttle and allow the engine to pick up speed to about 2000 RPM, and then close the throttle quickly. The pointer should jump 2 to 5" Hg above its low steady reading. A lesser gain may indicate faulty rings, and a complete cylinder leakage or compression test should be done.

### BLOWN CYLINDER HEAD GASKET

At idle, the vacuum pump gauge pointer will fluctuate between normal and a low reading. The needle will drop sharply about 10" Hg from a normal reading and return each time the defective cylinder or cylinders reach firing position.

### EXHAUST RESTRICTION TEST

An exhaust restriction will cause normal or near normal performance at engine idle, but cause very poor engine performance under load or at higher speeds.

- 1) Connect the pump hose to an intake manifold vacuum fitting. Operate the engine at idle and note the vacuum reading and needle movement. Compare readings and movements against descriptions listed for burned valves and late ignition or valve timing.
- 2) Watch the vacuum gauge as engine speed is increased to approximately 2500 RPM.
- 3) An increase in vacuum over that obtained at idle indicates an exhaust system that is free of restrictions.

4) If the needle drops toward zero as engine RPM is increased, either an exhaust restriction or an over-active Exhaust Gas Recirculation (EGR) valve is causing the problem.

5) Test the EGR valve separately. If it is found to be in good condition, the problem is a restricted exhaust. Check and replace if necessary.

### INCORRECT IDLE AIR/FUEL MIXTURE

If the gauge needle drifts slowly back and forth at idle, over a range of 4 to 5" Hg, the fuel mixture is too rich. A lean mixture will cause an irregular drop of the needle over about the same range.

### INTAKE MANIFOLD OR AIR INDUCTION LEAKS

If there are any air leaks in the air induction system, the gauge needle will be about 3 to 9" Hg below normal, but will remain steady.

### LATE IGNITION OR VALVE TIMING

An extremely low but steady reading at idle indicates late ignition or valve timing, or a uniformly close setting of the valve lash. Perform separate tests to determine which of these problems, if any, have affected the engine.

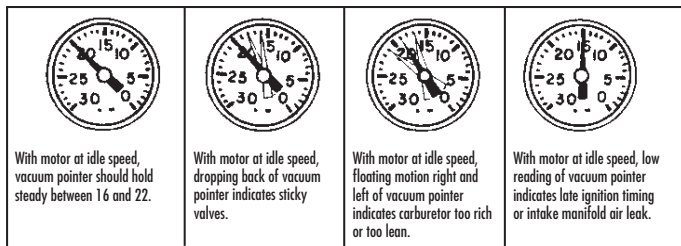

FIGURE 5: VACUUM GAUGE READINGS

## POSITIVE CRANKCASE VENTILATION SYSTEM

---

### SYSTEM OPERATION

The Positive Crankcase Ventilation (PCV) system is used on all modern engines to reduce air pollution by providing a more complete scavenging of crankcase vapors. Air is drawn through a filter located in the air cleaner, through a hose in the valve cover, into the crankcase, across and up into the rear of the intake manifold or opposite valve cover, through the PCV valve, through a hose, into the intake manifold. Intake manifold vacuum draws in all vapors from the crankcase to be burned in the engine.

When air flow through the carburetor or throttle body is high, added air from the PCV system has no effect on engine operation. However, at idle, air flow through the carburetor or throttle body is so low that any large amount added by the ventilation system would upset the air/fuel mixture, causing a rough idle. For this reason, the PCV valve restricts the ventilation system flow when intake manifold vacuum is high.

### SERVICE PROCEDURES

After a period of operation, the PCV valve may become clogged and reduce the amount of crankcase ventilation. The PCV valve should be replaced periodically to prevent the formation of acids in the crankcase, and the build up of excessive crankcase pressure, which could force engine oil out past the seals. Use the following procedure to check the PCV system using your pump:

- 1) Inspect the system for kinked, plugged or deteriorated hoses. Check to be sure all hoses are connected properly. Repair as necessary.
- 2) Connect your pump to an intake manifold port and check the vacuum reading of the warmed and idling engine.
- 3) Clamp off the vacuum hose to the PCV valve. The engine speed should decrease 100 RPM to indicate the loss of the calibrated air leak into

the intake manifold. The vacuum gauge reading should increase slightly, indicating that the vacuum leak has been plugged. If this does not happen, replace the PCV valve and/or replace any damaged, plugged or loose hoses.

- 4) If the engine is idling too slow or is rough, this may be caused by a clogged PCV valve or hose. Do not adjust the idle speed without first checking the PCV system.
- 5) After installing a new PCV valve, always adjust the idle speed, and if possible, the idle air mixture. The installation of the wrong valve may cause too much vapor to flow through the system if the calibrated bleed is too large. This will lean out the air/fuel mixture excessively. If the opening is too small, the plugging effect will be nullified, emissions will increase, acids will form and oil leaks may develop. Be sure you get the correct PCV valve for your car.

## FUEL PRESSURE REGULATOR

### SYSTEM OPERATION

Fuel pressure regulators are used to maintain fuel pressure at a steady level, consistent with the requirements of the engine. Automotive manufacturers employ different methods for controlling fuel pressure. Most utilize a mechanical spring and diaphragm style pressure regulator such as the one shown in figure 6. Mechanical regulators most often utilize engine vacuum and/or pressure to vary fuel pressure in response to immediate engine requirements. A vacuum or vacuum/pressure pump with appropriate gauge is required to properly diagnose these types of regulators.

Vacuum/pressure controlled fuel pressure regulators are commonly mounted on or immediately after the fuel rail, and inline with the flow of fuel. When the fuel pump is not operating, the spring causes the diaphragm to close so that no fuel can pass. Once the fuel pump is activated, the pressure it produces begins to overcome the spring force and the diaphragm opens to allow fuel to flow. The spring and diaphragm maintain a constant pressure on the flow of fuel. This creates back-pressure in the fuel system, which is commonly referred to as “fuel pressure”. The job of the fuel pressure regulator is to maintain the “fuel pressure” at a level specified by the vehicle manufacturer.

A vacuum/pressure-modulated fuel pressure regulator is connected to the intake manifold by a small hose. Vacuum from the manifold assists the spring in opening the diaphragm. When a load is placed on the powertrain, engine vacuum drops. This drop in vacuum causes the diaphragm to increase the resistance to fuel flow. The additional resistance increases the fuel pressure to the injectors to compensate for the higher fuel demand of the engine. On forced-air induction systems (turbochargers/superchargers), the boost pressure created in the manifold functions the opposite of the vacuum produced in normally aspirated systems. Under boost conditions, the pressure in the manifold causes the regulator to increase fuel pressure, resulting in a richer fuel mixture.

FIGURE 6:  
PRESSURE  
REGULATOR

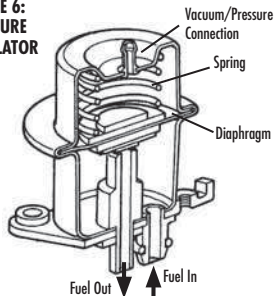

### SERVICE PROCEDURES

#### Visual Inspection

- 1) Consult the vehicle's service manual to determine if the pressure regulator is vacuum/pressure modulated, and to identify its location.
- 2) Inspect the exterior of the pressure regulator for fuel leaks, and the vacuum hose for visible damage or cracks. Replace if necessary.
- 3) Disconnect the vacuum hose from the fuel pressure regulator.
- 4) Check inside the hose for liquid fuel. If present, replace the regulator. If not present, reconnect the vacuum hose.

#### Diagnostics

- 5) Install a fuel pressure tester.
- 6) Start the engine and allow it to idle.
- 7) Disconnect the vacuum line from the fuel pressure regulator.
- 8) Fuel pressure should increase 8 to 12 psi when the line is disconnected. No change would indicate a faulty regulator, or leaky or plugged vacuum line.
- 9) Connect the vacuum pump to the vacuum hose extending from the manifold.

## FUEL PRESSURE REGULATOR

---

10) The pump gauge should indicate 16-22" Hg. Consult the vehicle's service manual for a more accurate specification. No reading or a low reading would indicate a leaky or plugged vacuum line, or more serious engine problem.

11) Disconnect the vacuum pump from the vacuum line, and plug the line temporarily. Connect the pump to the vacuum port on the regulator.

12) Use the pump to apply vacuum to the regulator while watching the gauge on the fuel pressure tester.

13) Fuel pressure should increase one pound for every two inches of Hg vacuum applied to the regulator. If not, replace the fuel pressure regulator.

## EXHAUST GAS RECIRCULATION (EGR)

An Exhaust Gas Recirculation (EGR) system is used on most modern engines to reduce Oxides of Nitrogen (NO<sub>x</sub>) emissions. During the combustion process, nitrogen, which makes up 80 percent of the air, will mix with oxygen at temperatures above 2,500°F. During the combustion process, temperatures in the cylinders go well above 3,500°F providing the ideal conditions for the formation of NO<sub>x</sub>.

### SYSTEM OPERATION

To reduce the formation of NO<sub>x</sub>, it is necessary to lower the combustion temperature. This is most often done by introducing exhaust gases back into the combustion chamber through the use of an EGR valve. The EGR valve (FIGURE 7) may be operated by ported vacuum from above the throttle plates, or by a sophisticated control system that modulates the amount of EGR depending on the temperature of the coolant, ambient air temperature, engine speed or load.

An EGR valve that does not have a sophisticated control system must be fully closed with a vacuum of less than 2" Hg and begin to open with 2 to 8.5" Hg of vacuum. At idle and wide-open throttle, the ported vacuum supply is low and the valve should be closed.

Some cars have a Back-Pressure Transducer Valve (BPV) to modulate the operation of the EGR system. Some cars have a Venturi Vacuum Amplifier (VVA) to do the same job. The effect is to modulate the amount of EGR according to the load on the engine. To improve cold drivability, most cars are equipped with some type of vacuum control device to shut off EGR while the engine is cold.

EGR systems fail in two ways. Either the valve may fail due to a fault of its own, such as a ruptured diaphragm, or due to a loss of control vacuum. Always check whether there is vacuum at the hose connected to the EGR valve, before replacing the valve. Connect the pump to the vacuum supply hose at the EGR valve and check whether at 2000 RPM there is at least 4 to 5" Hg vacuum available. Remember also that clogged exhaust passages that lead to or from the valve can restrict the flow even if the valve is opening.

An EGR valve that remains open will cause the engine to idle roughly, die at idle, and lose power and full-throttle smoothness. Dirt or damage in the valve seat area usually cause the valve to fail. An EGR valve can operate normally with the engine warm but remain open when the engine is cold. That condition could be caused by a faulty thermal switching device that does not cut off the vacuum supply when the engine is cold.

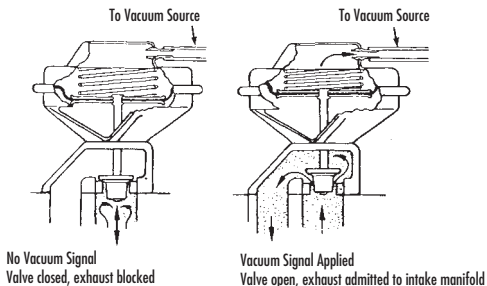

FIGURE 7: EGR VALVE OPERATION

## EXHAUST GAS RECIRCULATION (EGR)

### EGR SERVICE PROCEDURES/GENERAL TEST EXCEPT GM OR BACKPRESSURE CONTROLLED TYPE

If the symptoms of an engine lead you to believe that an EGR valve is staying open, follow this procedure:

- 1) Connect a tachometer to the engine and run the engine at idle speed until it reaches normal operating temperature. Use the pump to check for at least 10" Hg vacuum at the valve. Replace the hose and note the engine RPM.
- 2) Remove the vacuum hose from the valve and notice whether engine RPM increases.
- 3) If engine speed does increase, there may be some type of problem in the vacuum control circuit. Check the routing of all vacuum hoses.
- 4) If engine speed or the quality of idle changes, remove the valve and check the pintle and valve seat to make sure both are clean. If they are not, replace the valve, gasket and adapter if it is burned, warped or damaged.

If the engine symptoms lead you to believe that the EGR valve is staying closed, follow the procedure below:

- 1) Operate the engine at idle until it reaches full operating temperature. Use the pump to check for the presence of 10" Hg vacuum at the valve. Set the engine speed at approximately 2000 RPM. Plug the vacuum supply hose. Connect the vacuum pump to the EGR valve and apply 10 to 15" Hg vacuum.
- 2) The diaphragm should move to the open position and a decrease in engine RPM should be noted. If

not, the valve is defective or the manifold passages are plugged. Release the vacuum on the EGR valve.

- 3) The diaphragm should move to the closed position and an increase in engine RPM should be noted. Return the engine to idle and turn it off.
- 4) Connect the pump to the EGR valve and test by applying at least 9" Hg of vacuum to the diaphragm and watch the gauge carefully for any vacuum loss.
- 5) If the valve diaphragm does not move, or cannot hold vacuum, replace the EGR valve.

### GM EGR VALVES

General Motors produces three types of EGR valves. Each valve can be identified by the design of its diaphragm plate (FIGURE 8). The first valve is a ported vacuum EGR that has only a circular rib on the back of its diaphragm plate. The second is a positive backpressure valve with X-shaped ribs that are raised only slightly above the plate. Finally, there is a negative back-pressure valve with X-shaped ribs raised well above the diaphragm plate. Both the ported vacuum and negative back-pressure valves are tested the same way. A separate test is listed to check the positive back-pressure valve.

### GM PORTED VACUUM AND NEGATIVE BACK-PRESSURE EGR TEST

- 1) Make sure all vacuum hoses are routed according to the emission control label.
- 2) Check the vacuum connection to the EGR valve for obstructions.

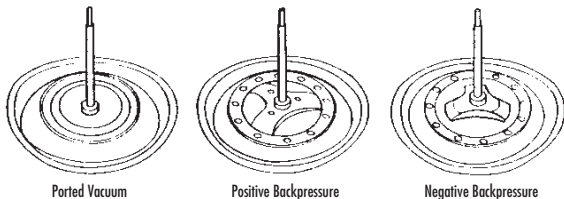

FIGURE 8: GM EGR DIAPHRAGMS

## EXHAUST GAS RECIRCULATION (EGR)

3) Connect the pump between the EGR valve and the carburetor or vacuum source. Start the engine and run it at idle until it reaches operating temperature (195°F approx.). Check for vacuum at 3000 RPM; it should be 5" Hg minimum.

4) If no vacuum is available in step 3, check for it between the EGR thermal vacuum switch (TVS) and the carburetor. If the vacuum is available there, replace the TVS.

5) If the vacuum supply between the EGR and the carburetor is adequate, connect the pump to the EGR valve inlet. Depress the valve diaphragm and apply approximately 10" Hg vacuum to the EGR. Release the diaphragm and record the time it takes for the diaphragm to return to its seated position.

6) If it takes less than 20 seconds for the valve to seat, replace the valve.

### GM POSITIVE BACKPRESSURE EGR TEST

1) Follow steps 1 through 4 of the ported vacuum and negative back-pressure EGR test.

2) Remove the EGR valve from the engine. Connect the pump to the EGR vacuum inlet and apply 10" Hg of vacuum. The valve should not open. If it does, replace the valve.

3) Continue the test by keeping the vacuum applied and shooting a low-pressure stream of air into the valve's exhaust inlet. The valve should now open. If it does not, replace the valve.

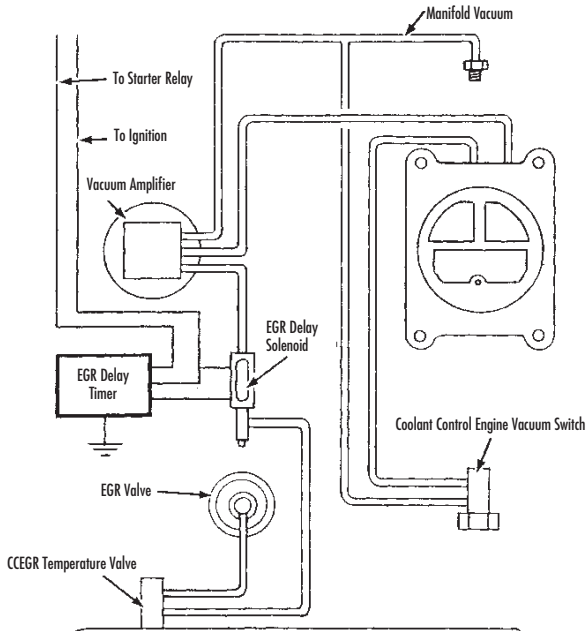

FIGURE 9: CHRYSLER VENTURI VACUUM-CONTROL EGR SYSTEM

## EXHAUST GAS RECIRCULATION (EGR)

### EGR VENTURI VACUUM AMPLIFIER

Some engines utilize a Venturi Vacuum Amplifier that uses the weak vacuum signal from the throat of the carburetor to allow the passage of the stronger intake manifold vacuum to operate the EGR valve. On most applications the amplifier provides a 2" Hg boost to the Venturi signal (FIGURE 9).

### SERVICE PROCEDURES

- 1) Start the engine, and run it at idle until it reaches normal operating temperature.
- 2) Make sure the intake manifold hose to the amplifier is properly connected. On those systems with a reservoir, remove the hose from the reservoir and use a tee connector to join the hose to the intake manifold vacuum hose.
- 3) With separate lengths of hose and different connectors, bypass any and all vacuum valves or coolant controlled valves between the amplifier and the EGR valve.
- 4) Use a tee connector to attach the pump into the vacuum line between the amplifier and EGR valve.
- 5) Increase engine speed to 1500 to 2000 RPM and release the throttle. Let the engine return to idle speed and remove the vacuum hose at the carburetor venturi. The vacuum reading should be within  $\pm 0.3"$  Hg of the specified boost for that amplifier if other than zero boost is specified. Zero boost may read from 0 to  $.5"$  Hg. Replace amplifier if it is out of specification.
- 6) Increase engine speed. Watching the vacuum gauge, release the accelerator after a speed of 1500 to 2000 RPM is reached. If the vacuum gauge reading shows an increase greater than  $1"$  Hg during acceleration period, the amplifier should be replaced.
- 7) Remove the pump from the output vacuum line and reconnect the hoses, but still bypass other valves. Connect the pump and apply 2 to 4" Hg of vacuum to port on the amplifier which is normally connected to intake manifold vacuum. The EGR valve should operate and engine idle should drop or become erratic. If the EGR valve fails to move, replace the amplifier.

### BACK-PRESSURE TRANSDUCER VALVE (BPV) OPERATION

The Back-pressure Transducer Valve (BPV) controls the amount of EGR according to the load on the engine. An exhaust pressure probe extends into the exhaust crossover passageway to sample the exhaust gas pressure. During light engine loads, the pressure in the exhaust passageway is relatively low, while during wide-open throttle operation (WOT), the pressure is highest. This pressure signal is transmitted to a diaphragm in the BPV and is used to control the amount of vacuum applied to the EGR valve (FIGURE 10).

### SERVICE PROCEDURES

- 1) Remove the air cleaner and plug the intake manifold fitting. Start the engine and bring it to normal operating temperature. Position the fast-idle cam follower on the second step of the fast-idle cam (to obtain about 1500 RPM), and then note engine speed on a tachometer. Use the pump to check the source vacuum at an intake manifold port (FIGURE 11). Note this reading.
- 2) Tee your pump into the vacuum passageway to the BPV and the reading should be 1 to 2" Hg of vacuum. Replace the BPV if it is not within specifications.
- 3) Leave the vacuum gauge at this location, remove the hose to the EGR valve, and plug the hose opening. Read the vacuum pump gauge, which should be the same as the intake manifold vacuum reading. If it is not within 2" Hg of the source vacuum, replace the BPV valve.

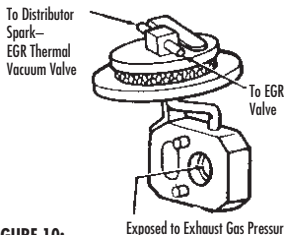

FIGURE 10:  
EXHAUST BACKPRESSURE TRANSDUCER VALVE



## SPARK DELAY VALVES (SDV)

### OPERATION

Spark Delay Valves (SDV) are used to delay vacuum to the distributor vacuum advance actuator during hard acceleration, to delay the action of the Thermactor Air Induction Reaction (AIR) system during prolonged engine idling, and to delay the application of vacuum to the automatic choke pull-down diaphragm during cold engine operation.

A sintered metal valve is installed in the vacuum advance (outer) diaphragm of the distributor control unit on some engines. The purpose of the valve is to delay the spark advance during rapid acceleration to minimize the formation of NOx. The sintered metal is porous and allows vacuum to bleed through the valve acting like an orifice of about 0.002" in diameter. Control is obtained by varying the number of discs in each valve assembly so that the time delay features can be tailored to the engine (FIGURE 12).

### SERVICE PROCEDURES

The time delay of the valve varies with engine application. The different valves may be identified by color and part number. Spark delay valves cannot be repaired and must be replaced every 12,000 miles because the pores of the sintered metal fill with dust, which can slow the performance of the valve. NOTE: The spark delay valve is a one-way unit that must be installed with the Black side facing the carburetor vacuum port.

To determine if a spark delay valve is operating correctly, the following service procedure should be used:

- 1) With the transmission in neutral, set the carburetor to the fast-idle position, remove the spark-delay valve and tee your vacuum pump into the hose leading to the carburetor spark port.
- 2) Record the vacuum reading, which should be between 10 to 16" Hg.
- 3) Pinch off the vacuum hose and observe if the gauge maintains the vacuum level. If the gauge shows that the vacuum drops with the hose pinched off, the gauge or vacuum hose has an external leak, which must be corrected.
- 4) Now, connect the black side of the spark-delay valve to the vacuum hose leading to the carburetor spark port. Connect a section of vacuum hose to your vacuum pump and attach the other end to the distributor end of the spark delay valve. Observe the time in seconds for the gauge to reach 6" Hg, with a 10 to 16" Hg vacuum source. If the vacuum reaches the 6" Hg level in less than two seconds, regardless of type, the SDV should be replaced. When checking the valve, care must be taken to prevent oil or dirt from getting into the valve as this will impair its function.

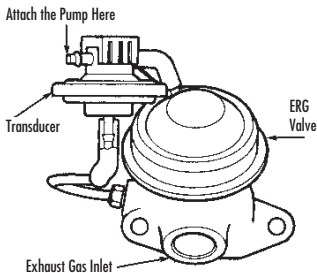

FIGURE 11: TEST THE VACUUM SOURCE FOR THE BPV WITH YOUR PUMP

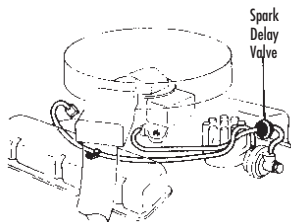

FIGURE 12: TYPICAL SPARK DELAY VALVE

## ELECTRICAL /VACUUM SOLENOID

### SERVICE PROCEDURES

1) Disconnect vacuum and electrical connectors from the solenoid. Connect the pump to port "B" and attempt to apply vacuum with pump. Vacuum should be released through port "A" (FIGURE 13).

2) Using jumper wires, connect negative solenoid terminal to ground and apply 12 volts to the positive terminal. Apply vacuum to port "B". Vacuum should hold and not bleed off. If the solenoid does not hold vacuum, replace solenoid.

3) With solenoid still energized, move vacuum pump to port "A". Attempt to apply vacuum. Vacuum should be released through the air filter and no vacuum should be present at port "B".

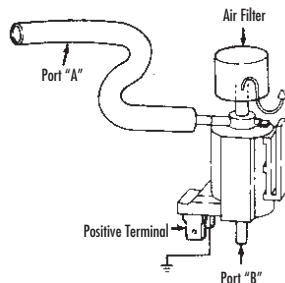

FIGURE 13: TYPICAL VACUUM SOLENOID

## THERMAL-CONTROLLED VACUUM-SWITCHING VALVES

### SERVICE PROCEDURES

These control valves are called Ported Vacuum Switches (PVS) when used on Ford engines. Thermal Ignition Control (TIC) valves when used on Chrysler products, and Distributor Thermal Vacuum-Switches (DTVS) when used on General Motors engines.

The two-port valve is used to stop EGR while the engine is cold. This type of thermal switch is needed to provide good drivability by limiting the entrance of EGR until the engine is warmed up.

The three-port valve is commonly called a cooling system PVS because it switches the vacuum source to the distributor from ported to full intake vacuum.

The four-port valve has been used in some Ford engines to bypass the spark delay valve and cut out the EGR system when the engine is cold.

### SERVICE PROCEDURES

Follow this procedure to test the two-port vacuum-switching valve:

1) Apply 10" Hg of vacuum to the bottom port of the valve with your vacuum pump and measure the results with a second vacuum gauge as shown in the accompanying illustration (FIGURE 14).

2) The valves are color-coded and the green valve should open and pass vacuum at 68°F, the black valve at 100°F.

Color Code	Coolant Above Temperature
Green	68°F
Black	100°F
Plain or Blue	133°F

RESULTS:	
No Vacuum	Replace the PVS valve
Vacuum	PVS valve is open
Vacuum when coolant is cold	Replace the PVS valve

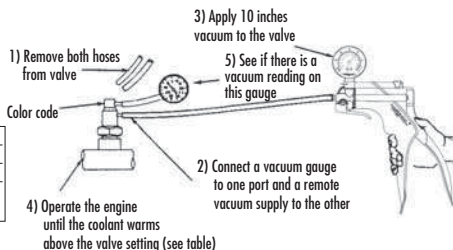

FIGURE 14: TESTING THE TWO-PORT PVS

## **THEMAL-CONTROLLED VACUUM-SWITCHING VALVES**

3) If full vacuum flows through the valve when heated, it is okay. If there is no vacuum flow or there is vacuum flow when the coolant is cold, replace the valve.

Follow this procedure to test the three-port vacuum-switching valve:

1) Apply 10" Hg of vacuum with your vacuum pump to the middle port of the valve with a vacuum gauge at each of the other two ports.

2) Refer to the same color-coded valves and same temperature specifications as for the two-port valve above. If the vacuum switches at the specified temperature, the valve is okay. If there is no vacuum to the lower port above the specified temperature, replace the valve.

The four-port valve must be tested two times, once at the top two ports and once at the bottom two ports as shown in the accompanying illustration (FIGURE 15).

1) Apply 10" Hg of vacuum with your vacuum pump to one of the top two ports. The valve should hold vacuum when above the specified operating temperature.

2) If flow occurs when the valve is warm, replace it.

3) For the lower two ports, vacuum must pass through the valve only when the engine is warm; otherwise, replace the valve.

### **4-PORT PVS TEST**

#### **UPPER VALVE FLOW**

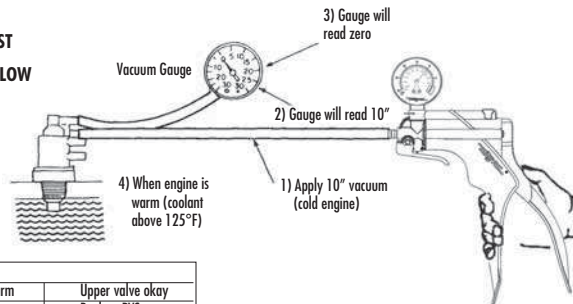

<b>RESULTS:</b>	
No vacuum when warm	Upper valve okay
Vacuum when warm	Replace PVS

#### **LOWER VALVE FLOW**

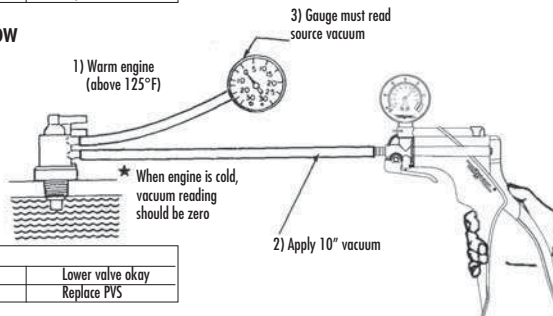

<b>RESULTS:</b>	
Vacuum when warm	Lower valve okay
No vacuum when warm	Replace PVS

**FIGURE 15: TESTING THE FOUR-PORT PVS**

## BRAKE BLEEDING

---

Many brake systems today feature Anti-Lock functions and electronic controls. Many of these systems use a high pressure electric pump to keep the system pressurized. When bleeding or servicing, these systems require special procedures and cautions.

- ALWAYS observe the following precautions when servicing Anti-Lock brake system:
- ALWAYS wear safety goggles when servicing high pressure brake systems.
- ALWAYS depressurize the ABS system prior to adding fluid or attempting service or repair.
- Unless instructed to by the manufacturer's procedure, NEVER open a bleeder valve or loosen a hydraulic line while the ABS system is pressurized.
- ONLY use recommended brake fluids. DO NOT use silicone brake fluid in ABS equipped vehicles.
- Always refer to an appropriate repair manual for additional information on Anti-Lock brake systems.

### DEPRESSURIZING ANTI-LOCK BRAKE SYSTEMS

Always refer to the vehicle owner's manual or appropriate service manual for additional information on depressurizing procedure. The procedure will work on most Anti-Lock brake systems. Ensure ignition switch is in the OFF position or disconnect the negative battery cable. Pump the brake pedal 25 to 40 times. A noticeable change is felt. Continue to pump the pedal a few additional times. This should eliminate most system pressure. Open fluid reservoir or brake lines carefully. Top off reservoir fluid and reconnect battery cable when finished.

### BLEEDING ANTI-LOCK BRAKE SYSTEMS

Always refer to the vehicle owner's manual or appropriate service manual for manufacturer's brake bleeding procedure. The front brakes on most Anti-Lock brake systems may be bled in the conventional manner. Most hydraulic pump/pressure accumulator units are fitted with a bleeder valve which must be bled when the system has lost fluid or

is being replaced. Some vehicles require that the system be pressurized when the rear brakes are bled.

Some automotive manufacturers use bleeding procedures which require specialized equipment.

### BRAKE LINE BLEEDING

Most low and soft pedal problems are caused by air in the hydraulic lines, which requires bleeding of the hydraulic system. By using the pump with brake bleeding accessories, the system can be bled easily. Follow a wheel-to-wheel sequence beginning with the wheel closest to the master cylinder.

The kit provides a simple, clean, and quick method for bleeding the fluid lines in the automotive brake system. The creation of a vacuum in the reservoir jar causes fluid to be drawn into the reservoir jar. It should be noted that a tiny stream of bubbles may be noticed in the hose after all of the air is bled from the lines. This is caused by air seeping around the threads of the loosened bleeder fitting and being drawn back through the fitting by the suction of the pump. Once the air is removed from within the system, these tiny bubbles will in no way jeopardize the bleeding operation, since they are present only at the fitting and do not enter the system. If you wish, you can put grease or Teflon tape around the threads of the fitting to eliminate most of the bubbles. The correct bleeding procedure follows:

- 1) Always make certain that the master cylinder reservoir is filled and that a supply of new, clean brake fluid of the proper type is on hand to top off the reservoir as the fluid level drops during bleeding. Make sure that all the bleeding fittings are clean prior to beginning of the bleeding procedure.
- 2) Bleed the hydraulic system in the following order:
  - A) Master cylinder bleeder fittings, if equipped. If installing a new or rebuilt master cylinder, follow the bench bleeding procedure which follows.

## BRAKE BLEEDING

- B) Bleeder fittings on the combination valve, if equipped.
- C) Wheel cylinders and calipers in succession beginning with the wheel closest to the master cylinder, and working to the farthest one.

**NOTE:** Follow manufacturer's recommended bleeding sequence (if known). The procedure given in this article specifies to begin bleeding the wheel closest to master cylinder. Regardless of sequence used, always ensure all air is purged from system.

- 3) Slip 1½" of tubing between the pump and the lid of reservoir jar at port marked "TO PUMP" (FIGURE 16).
- 4) Attach 3½" plastic hose to the bottom of the cap.
- 5) Affix at least a 12" piece of tubing to the other reservoir jar port. Be certain that the cover of the reservoir jar is secure, but don't over tighten.
- 6) Select the appropriate adapter(s). The L-shaped universal adapters should fit snugly over the brake bleeding fitting in order to seal properly. The tapered adapters fit inside the thru-hole of fitting and will generally seal well when inserted tightly with a pressing and twisting motion. Attach adapter to reservoir hose.

- 7) Place wrench on brake bleeding fitting. Attach adapter and pump assembly, and pump 10 to 15 times.

**NOTE:** If bubbles coming out of the fitting are very small and even in size, the air is probably coming from within the system. It is not necessary to eliminate these bubbles as they do not affect brake operation. If desired, these bubbles can generally be eliminated by placing grease or Teflon tape around the threads, to act as a seal.

- 8) Open fitting slightly, only enough to cause the fluid to enter jar, usually ¼ to ½ turn.
- 9) After evacuating about 2" of fluid into the jar, close the fitting and refill the master cylinder. Repeat all previous steps on all remaining wheels. If fluid is not drawn into the jar after opening the fitting, make certain the lid of the jar is tight. You will not be able to produce the necessary vacuum in the jar if the lid does not fit securely. Occasionally some dirt will get into the brake line, in which case the pump may not be totally effective. If this happens, have someone touch the brake pedal once lightly, with the bleeding valve open, then proceed to use the pump.

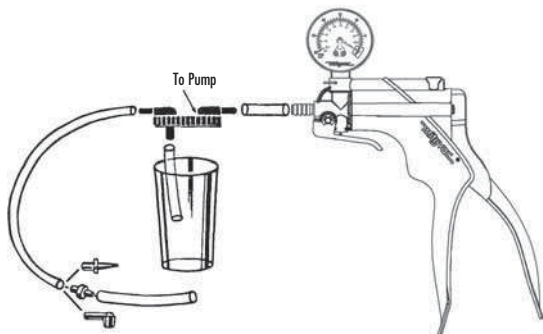

**FIGURE 16: BRAKE BLEEDING KIT**

## BRAKE BLEEDING

---

### MOTORCYCLE BLEEDING PROCEDURE

Before bleeding the system, ensure that:

- 1) The brake caliper pistons are free to move within the calipers.
- 2) The master cylinder piston is free to return to the end of its stroke, and
- 3) Inspect the line to ensure that all fittings are tight.

### FRONT BRAKE

- 1) Pump brake lever to seat caliper pads against rotor.
- 2) Cover gas tank with plastic protective sheet if using DOT 3 fluid (not necessary if using DOT 5 fluid).
- 3) Remove master cylinder reservoir cap and fill reservoir.
- 4) Select the appropriate adapter(s). The L-shaped universal adapters should fit snugly over the brake bleeding fitting in order to seal properly. The tapered adapters fit inside the thru-hole of fitting and will generally seal well when inserted tightly with a pressing and twisting motion. Attach adapter to reservoir hose.
- 5) Pump several times to create vacuum. Crack bleeder valve with box wrench, extracting fluid into reservoir. (Stop and add fluid when master cylinder begins to get low. Do not allow air to enter line.). At this point, all air should be out of system and line full of fluid. (Note: if air is entering the pump hose from around bleeder fitting, remove bleeder fitting and apply Teflon tape to threaded portion of bleeder screw only. This will prevent air seepage around threads of bleeder screw.)
- 6) While maintaining vacuum on the pump line, tighten bleeder fitting.
- 7) Top off reservoir and reinstall cover. Check brake by pumping lever several times. Pedal should have a positive, solid feel. If not, repeat bleeding process as more air may have entered the system. Inspect line to ensure all fittings are tight. If brake still feels slack, consult a service technician.

For dual disc front brakes, repeat bleeding process as though there are two separate systems.

### REAR BRAKE

Removing all air from the rear brake line is the same as for the front. The rear brake reservoir is usually located beneath one of the side covers.

- 1) Remove the master cylinder cap and fill to near full.
- 2) Attach the pump hose to the bleeder fitting and pump the handle several times to create a vacuum.
- 3) Crack the bleeder with a box wrench. Because of the short line, most of the air should be evacuated the first time.
- 4) By closing the valve and repeating the process, all of the air should be eliminated from the system. Stop and add more fluid when master cylinder gets low.
- 5) Top off and recap the reservoir.

### TROUBLESHOOTING

- 1) If, after bleeding procedure, the brake continues to be unresponsive, you may have water in the system, in which case it will need to be disassembled and cleaned by a qualified service technician.
- 2) If the brake squeaks slightly after bleeding, the disc and pads must be cleaned.
- 3) Although DOT 3 fluid is recommended by most manufacturers, it has a tendency to collect moisture, which causes the common discoloration you see - and that means decreased efficiency. DOT 5 is silicone based and does not have the same tendency to collect moisture. It also has a higher tolerance. DOT 5, however, is not always easy to find and the two types of fluid must not be mixed.
- 4) Rubber hoses are supplied stock on most motorcycles, but they have a tendency to expand, which may result in a spongy brake feel after a lot of riding. Braided steel line will not expand like this.

## BRAKE BLEEDING

### BENCH BLEEDING THE MASTER CYLINDER

Whenever a master cylinder has been removed from a vehicle or a new one is being installed, the master cylinder must be bench bled. Failure to bench bleed is the main reason for unsuccessful master cylinder replacement. Bench bleeding greatly decreases the chance that any air will be caught in the cylinder upon reinstallation. Follow this procedure:

- 1) Plug outlet holes of the master cylinder and gently clamp it in a vise with the push rod end slightly elevated. NOTE: Damage may result if master cylinder is clamped by the bore or if reservoirs are clamped too tightly.
- 2) Fill the master cylinder with an approved type brake fluid and keep it filled at all times during the procedures.
- 3) Remove a plug from the master cylinder and attach the proper adapter to this master cylinder outlet port. Connect the pump tube to the reservoir jar and the jar tube to the adapter (FIGURE 17).

- 4) Operate the pump and observe air and fluid flowing into the reservoir until clear, bubble-free fluid appears.
- 5) Plug the outlet tightly and repeat step 4 on the other outlet ports.
- 6) Clamp master cylinder in a vise with the push rod end down slightly. Slowly slide the master cylinder push rod back and forth about  $\frac{1}{8}$ ", until no air bubbles can be seen in the reservoirs.
- 7) Remount the master cylinder with the push rod end up and follow steps 3 & 4 on all outlet ports. Plug ports tightly. The master cylinder is now free of air and ready to install.

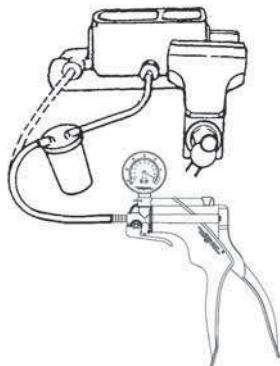

FIGURE 17: BENCH BLEEDING