

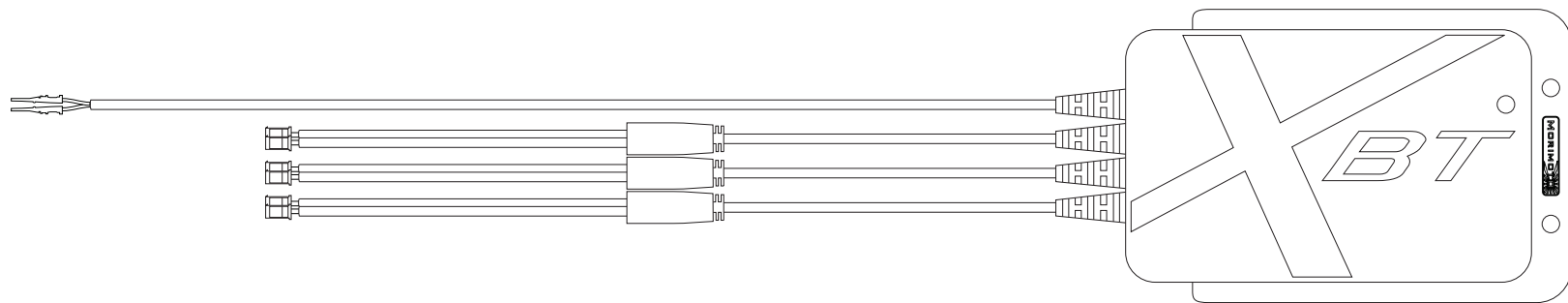

THE AUTOMOTIVE LIGHTING BENCHMARK



INSTALLATION GUIDE

XBT BLUETOOTH CONTROLLER



WARNING: By reading this document, I agree it is only to be used as an educational guide. Morimoto Lighting makes no guarantee on any finished results, nor are they to be held responsible for any damage, misuse, or personal injuries. Use at your own risk. If you are unable to clearly understand and adapt the information below, professional installation is recommended.

TABLE OF CONTENTS

CONTROLLER ASSEMBLY / INSTALLATION	P.3
USING THE MORIMOTO XBT APP	P.4
PAIRING THE DEVICE WITH THE CONTROLLER	P.4
CONTROL AND FUNCTION WITHIN THE APP	P.5
COLOR PICKER / HOME SCREEN	P.5
THEMES SCREEN	P.6
FAVORITES SCREEN	P.6
MENU SCREEN	P.6

KIT CONTENTS



1 X CONTROLLER



2X 9006 SOCKET GROMMETS



1 X 9006 CONNECTOR

FREE APP DOWNLOAD

TO CONTROL THE FUNCTION OF YOUR NEW XBT BLUETOOTH CONTROLLER, A FREE DOWNLOAD OF OUR PROPRIETARY APP IS REQUIRED. THIS APP CAN BE LOCATED SIMPLY BY SEARCHING THE WORD "MORIMOTO" ON YOUR IPHONE OR ANDROID PHONE APP STORE.

IPHONE VERSION

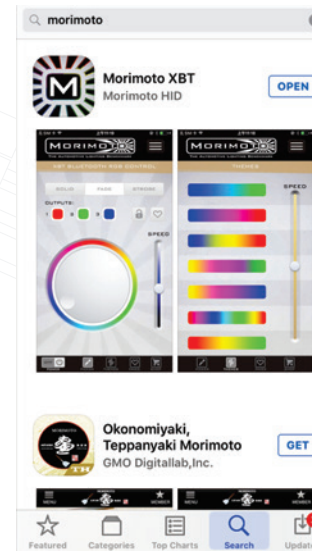

ANDROID VERSION

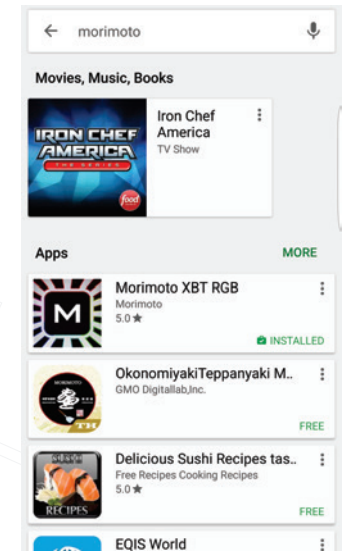

1

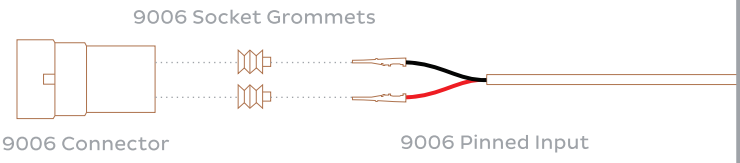

9006 Socket Grommets

9006 Connector

9006 Pinned Input

If the 9006 connector input is being used, insert the pins from the controller through the socket grommets and securely fastened into the 9006 connector. Note the wire orientation.

4

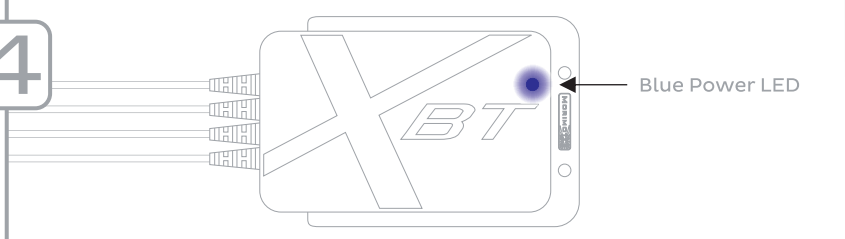

Blue Power LED

Once the input is properly wired and the controller is paired to the app, the blue LED on the box will illuminate, indicating it has power and is ready to use. The default output color is neutral white.

2

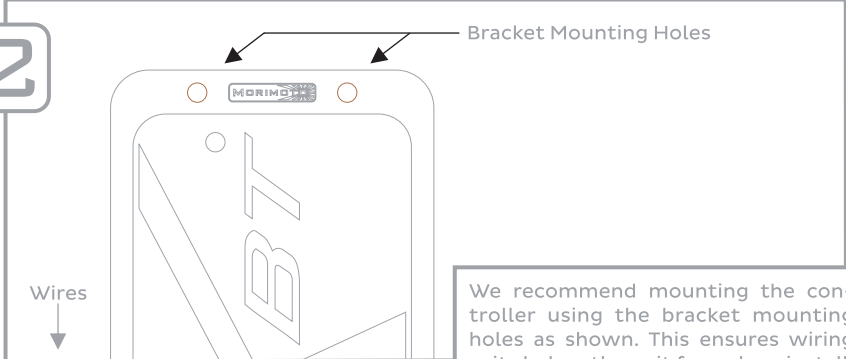

Bracket Mounting Holes

Wires

We recommend mounting the controller using the bracket mounting holes as shown. This ensures wiring exits below the unit for a clean install.

 Continue to Page 4

3

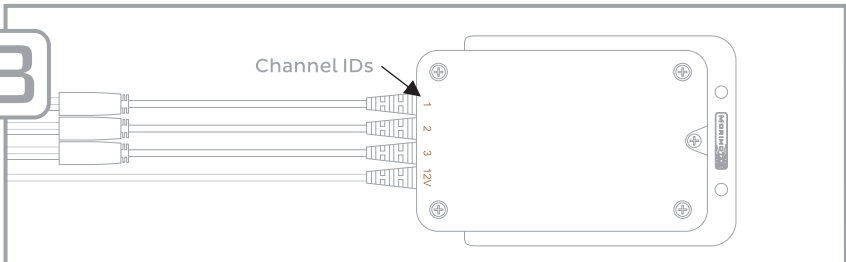

Channel IDs

1 2 3 12V

When connecting the XBT controller to your RGB components, reference the numbers on the back of the unit to ensure the preferred channel is used.

PAIRING THE DEVICE TO THE CONTROLLER

1



Open the Morimoto app. Touch "Pair Controller" to begin.

2

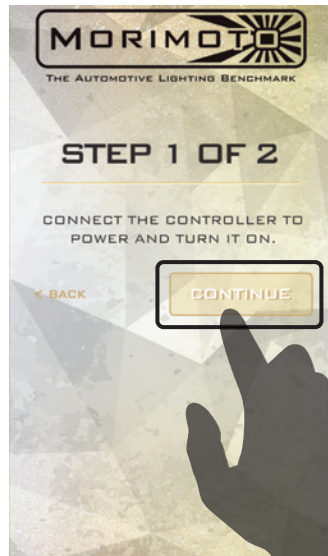

Ensure the blue power LED on the controller is lit. Touch "Continue."

3

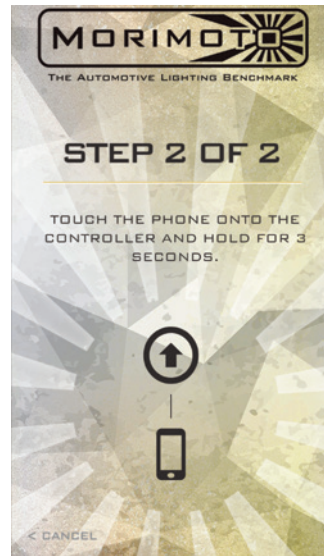

Touch the phone onto the XBT controller and hold steady.

4

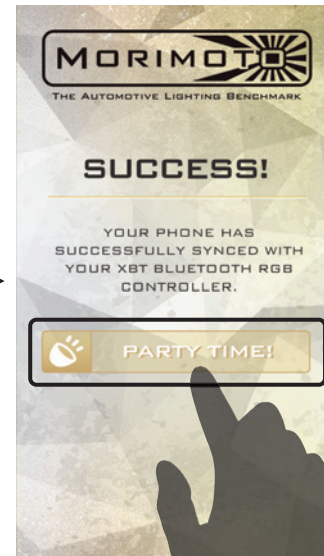

Once paired, let's party!

!

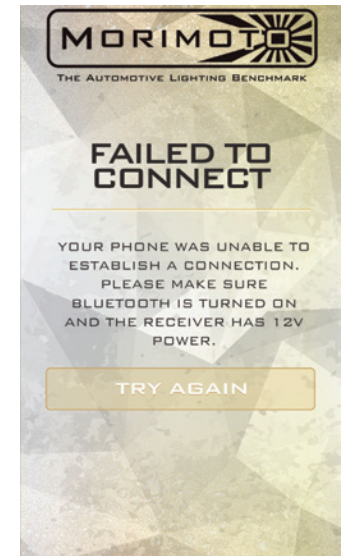

If the app fails to connect, this screen will be shown. Ensure the controller's blue power LED is lit and your phone's Bluetooth is turned on.

COLOR PICKER / HOME SCREEN



THEMES SCREEN

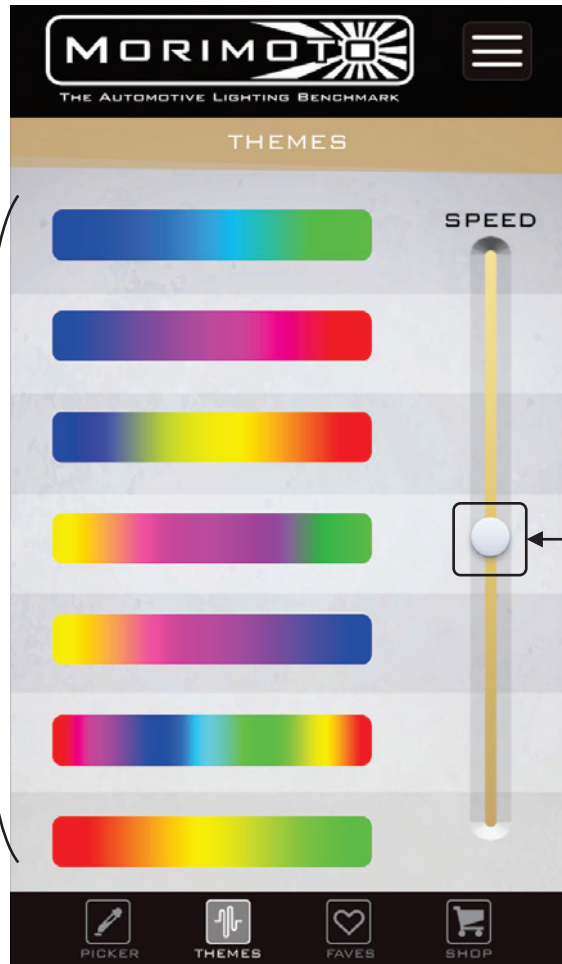

THEME OPTIONS

ADJUST THEME SPEED

FAVORITES SCREEN



MENU SCREEN

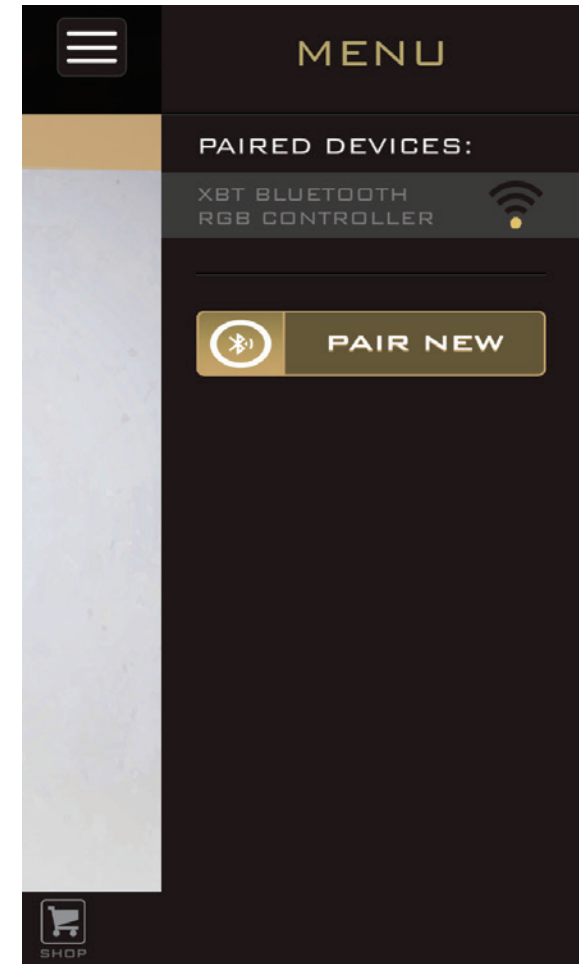

HAVING AN ISSUE PAIRING ON AN ANDROID? TRY THIS

1

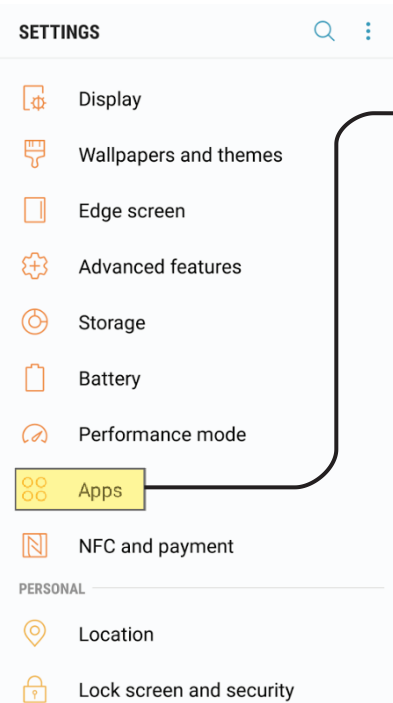

2

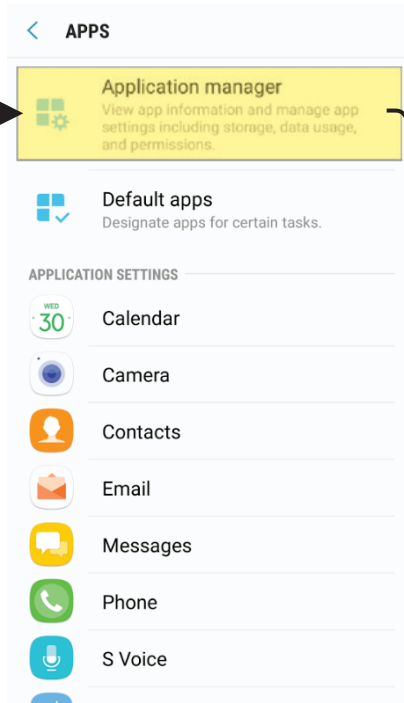

3

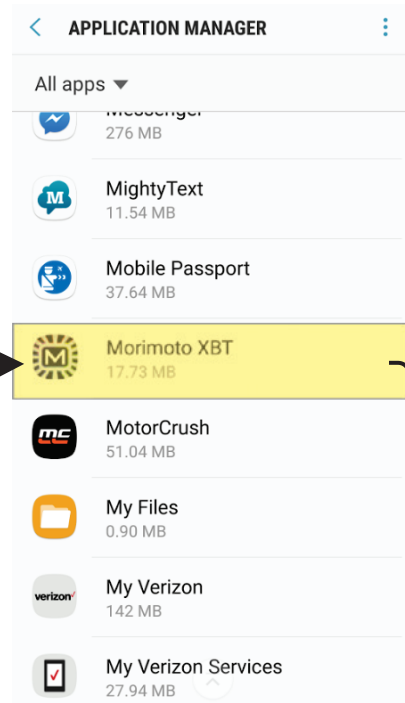

4

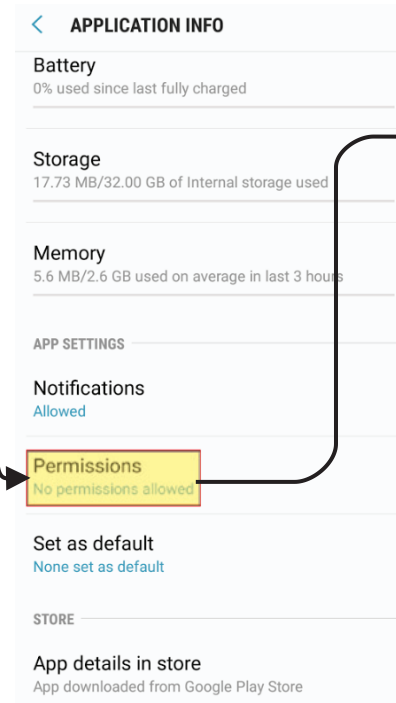

5

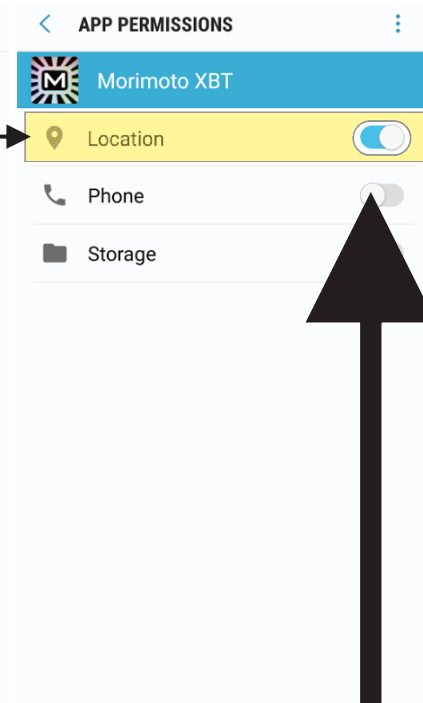

ENSURE LOCATION IS TURNED "ON"!

-END-