



5512-22

800W Peak Power Subwoofer

Parameters

Fs: 34 Hz
Qms: 3.4
Cms: 0.100 mm/N
Mms: 218 g
Rms: 13.724 kg/s
Vas: 1.57 ft³ (44.4 liters)
Xmax: 0.6 in (15.24 mm)
D: 10.55 in (267.9 mm)
Sd: 87.44 in² (564.1 cm²)
Vd: 52.46 in³ (0.859 liters)
Qes: 0.863
Re: 0.85 Ω
Bl: 6.8 Tm
Prms: 400 Watts
Qts: 0.69
n0: 0.196%
SPLo: 85.1 dB
SPL 2.83V/1m: 94.8 dB

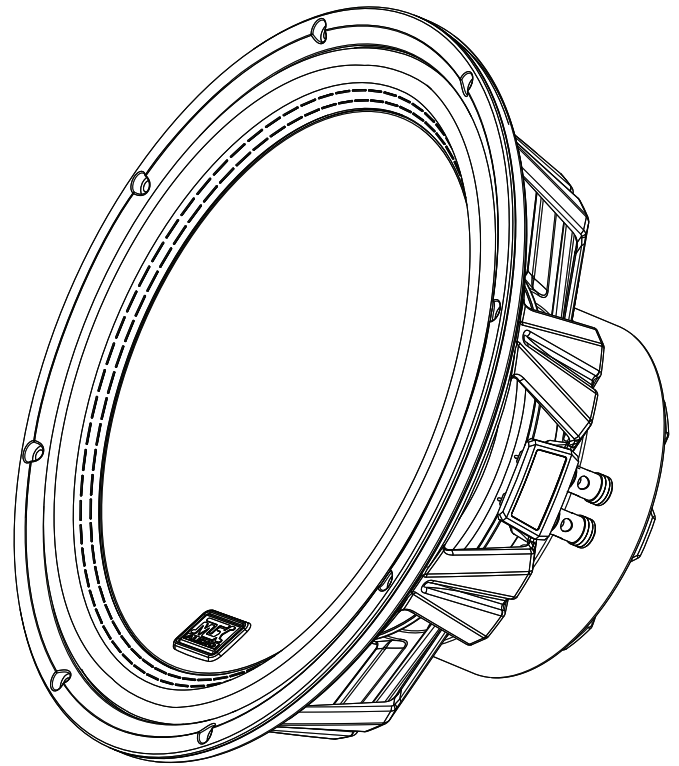

Specifications

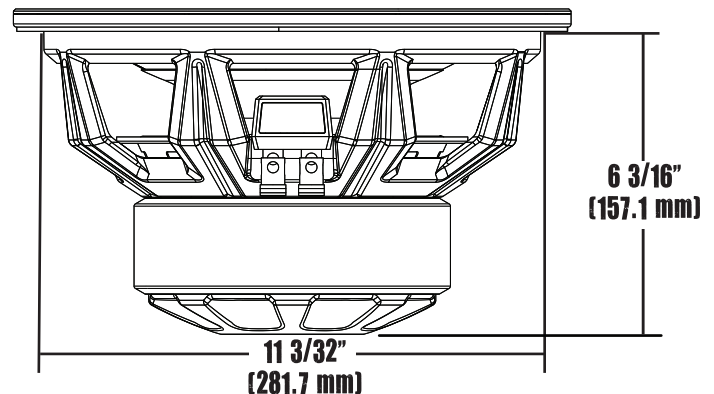
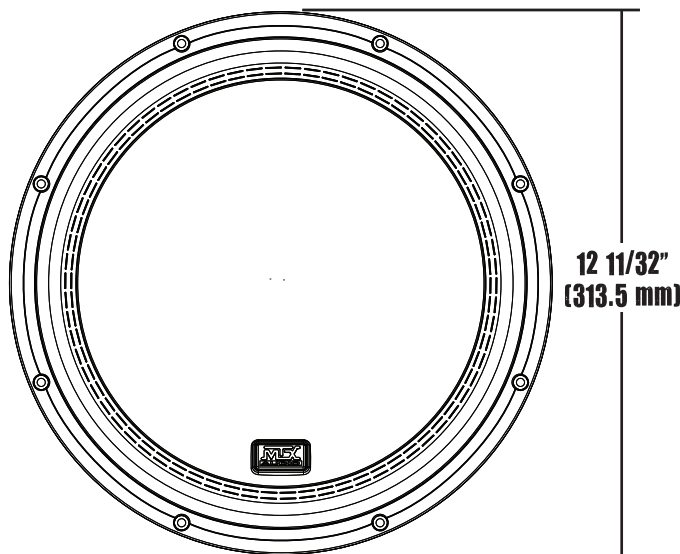

Recommended Power Rating of 200 - 400 Watts RMS

5512-22 Recommended Enclosures

For the best possible sound quality where space is a premium, MTX recommends using a sealed enclosure. For excellent sound quality with increased output compared to sealed enclosures (3dB or more), MTX recommends using a vented enclosure. All recommended enclosures have been designed and thoroughly tested by MTX.

For additional enclosure designs check the MTX website, the barcode will take you to the box design page.

Sealed Enclosure

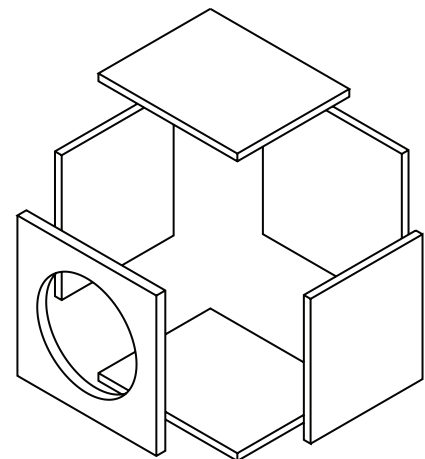
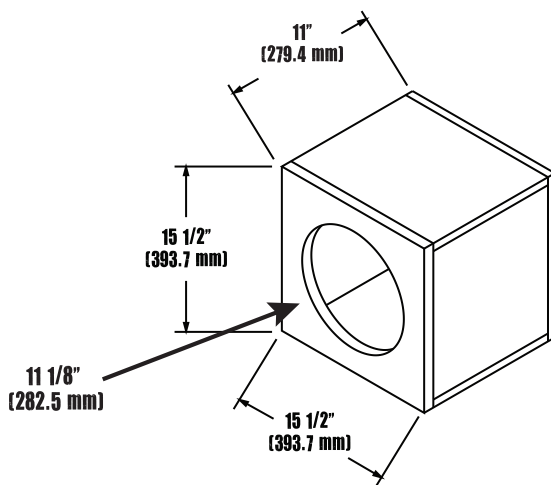

Net Internal Volume: 1.00 ft³

Vented Enclosure

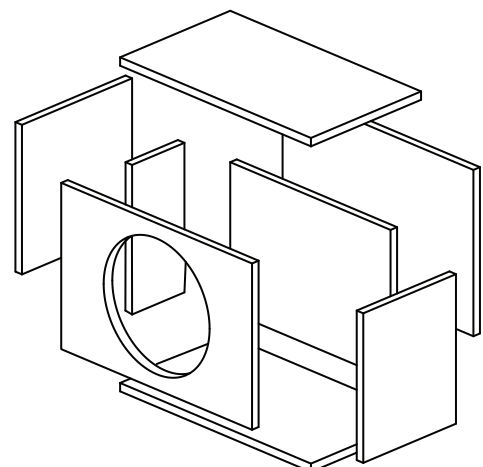
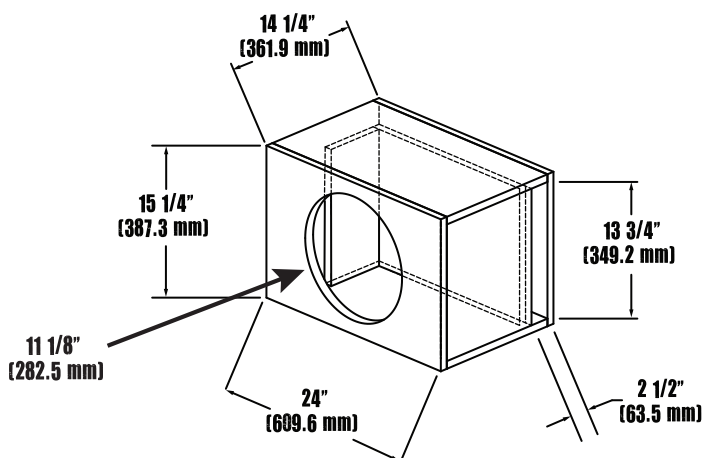

Net Internal Volume: 2.32 ft³