

Reshaping
your
world.

NORTON

SAINT-GOBAIN

CATALOG #7362

FULL-LINE STOCK CATALOG
ABRASIVE PRODUCTS FOR
THE INDUSTRIAL MARKET

BECAUSE **RIGHT CHOICES** MATTER™

SAINT-GOBAIN



Reshaping
your
world.

Our Mission

We offer powerful, precise, user-friendly solutions, which enable our customers to cut, shape and finish all materials even in the most complex and challenging applications. By working closely with end-users and our grinding expert partners, we design and provide customized solutions to secure the best option for performance, cost and safety.

Our Expertise

Norton is the leading brand of Saint-Gobain Abrasives, with more than 135 years of experience in manufacturing abrasives.

We are committed to providing access to our expert's knowledge whenever you need it. Whether it is through our Process Solutions Program (PSP), ongoing training programs, or through on-line expert articles and white papers you can stay up-to-date with Norton where and when you need it.

Bring us your grinding challenges, we have solutions!

Our Commitment

You be the final judge in performance! We are so confident of the superior performance of our abrasive products, as recommended for specific applications, that we invite in-plant tests against any other brand of abrasive product on the market.



Why Tiers Matter

At Norton we believe in delivering right choices that matter. Our abrasives are classified in BEST, BETTER, and GOOD performance/price tiers to help you choose the right product for your specific application every time.

BEST

Our BEST tier products are designed for the customer who is seeking the highest productivity at the lowest total cost.

BETTER

Our BETTER tier products provide an excellent blend of performance and price.

GOOD

And, our GOOD tier products promise the highest quality you expect from the Norton name with a low initial price.

METAL FAB CUTTING AND GRINDING

Rough Grinding	
Depressed Center Wheels	7
Cut-off Wheels	
Small Diameter Reinforced Cut-off	17
Circular Saw Reinforced Cut-off	24
Chop Saw Reinforced Cut-off	25
High-Speed Reinforced Cut-Off	28
Walk-Behind Reinforced Cut-off	30
Stationary Saw Reinforced Cut-off	31
Toolroom Cut-off	32
Metallurgical Non-Reinforced Cut-off	34
Rail Reinforced Cut-off	35
Foundry Wheels	
Foundry Cut-off	36
Portable Snagging	38
Floorstand and Swingframe Snagging	42

COATED AND NON-WOVEN ABRASIVES

Coated Abrasive Basics	45
Non-Woven Abrasive Basics	48
Discs	
Fiber Discs	50
Flap Discs	55
Non-Woven Discs	61
Non-Woven Depressed Center Discs	63
Non-Woven Standard Back-up Pad Discs	65
Non-Woven Speed-Change Discs	67
Non-Woven Hook and Loop Discs	68
Cloth PSA Discs and Accessories	69
Paper Discs	72
Mesh Discs	81
Film and Foam Finishing Discs	82
Flexible Diamond-Coated Discs	84
Sanding Accessories	85
Wheels	
Non-Woven Convolute Wheels	88
Belts	
File Belts	93
Portable Belts	96
Narrow Belts	98
Wide Belts	104
FastTrack Service Made-to-Order Belts	106
Non-Woven Belts	107
Rolls / Sheets	
Cloth Rolls and Sheets	109
Paper Rolls and Sheets	112
Non-Woven Rolls	121
Sponges / Hand Pads	
Abrasive Sponges	122
Non-Woven Hand Pads and Sponges	124
Foam Hand Pads	126
Flexible Diamond-Coated Hand Pads	127

PORTABLE TOOLS AND SPECIALTIES

Mini Angle Sander	129
Mini Flap Discs	130
Quick-Change Discs	131
Non-Woven Quick-Change Discs	139
Quick-Change Disc Accessories	147
Die Grinder	148
Cartridge Rolls	149
Spiral Rolls	152
Square/Cross Pads, Overlap Slotted Discs	155
Spiral Bands	159
Tapered Cone Points	162
Mandrels	163
Test Kits	164
Non-Woven Specialties	165
Flap Wheels	167
Non-Woven Flap Wheels	179
Arbor Hole (Gangable) Discs	181
Bore Polishers	182
FlexDrums	184
Non-Woven Unified Wheels	188
Mounted Points	192
Carbide Burrs	193

PRECISION OFFHAND/PORTABLE

Mounted Points	198
Sharpening Stones	204
Retail Dressing Sticks and Stones	217
Rubbing Bricks	218

PRECISION GRINDING WHEELS

Bonded Abrasives Basics	220
Bench and Pedestal Wheels	222
Sawgumming Wheels	226
Toolroom Vitrified Wheels	227
Large Surface Grinding Wheels	243
Surface Grinding Segments	244
Cylindrical Wheels	246
Centerless and Feed Wheels	250
Creepfeed Blank Stock FastTrack Service	254
Quantum Blank Stock FastTrack Service	256
55A Blank Stock FastTrack Service	257
Gear Wheel Blank Stock FastTrack Service	258
ID, Race and Superfinishing Wheels/Sticks	260

DRESSING SOLUTIONS

Diamond Stationary Dressing Tools	263
Diamond Stationary Fliesen Tools	281
Diamond Rotary Dressing Tools	284
Truing Devices	285
Dressing Sticks	286
Truing and Dressing Guide	288

DIAMOND AND cBN ABRASIVES

Diamond / cBN Basics	290
Diamond / cBN Wheels	295
B99 Express Resin Bond Wheels	305
Diamond / cBN CNC Wheels	307
Electroplated Products	313
Diamond Lapping Compound	322

CONSTRUCTION PRODUCTS

Diamond Blades	324
Diamond Cup Grinders	329
Diamond Core Bits	330
Equipment	331

WIRE BRUSHES

Wire Brush Basics	334
Wire Brushes	336
Nylon Brushes	347

MASKING PRODUCTS

Tape	349
Masking Film, Paper, and Sheeting	352
Micro-Fiber Cloths	353







SAFETY



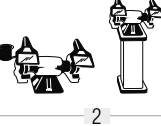

Safety Icons	6
Safety Leadership / References	354
Safety Icon Meanings	355
Coated Abrasive Do's and Don'ts	357
Portable Grinding Safety	358
Starting a Grinding Wheel / Ring Test	359
Wheel Speed Conversion Table	360
Silica Precautions	361

GENERAL INFORMATION

Catalog Navigation	4
Machine Index	4
Product Warranties	362
Trademarks	362
Contact Information	363
Abrasive Connection	363
Norton Tech	363
Merchandising	363

Machine Index and Catalog Navigation

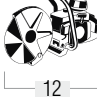
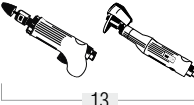
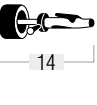
	1. Backstand Belt Grinders
	Coated Abrasive Backstand Belts 98–99, 103, 106
	Non-Woven Backstand Belts 107–108
	2. Bench and Pedestal Grinders
	Coated Abrasive Large Diameter Flap Wheels 175–177
	Non-Woven Convolute Wheels (6"–14" wheels) 88–92
	Non-Woven Discs (6"–12" discs) 181
	Non-Woven Flap Wheels (6"–8" wheels) 179–180
	Non-Woven Nylon Wheel Brushes 347
	Non-Woven Unified Wheels (6" wheels) 188–191
	Sand-O-Flex Wheels 178
	Vitrified Bench and Pedestal Wheels 222–225
	Wire Brushes 338–340
	3. Benchstand Grinders
	Coated Abrasive Benchstand Belts 98–102, 106
	Non-Woven Benchstand Belts 107–108
	4. Chop Saw Machines
	Chop Saw Reinforced Cut-off Wheels 25–27
	5. Circular Saws
	Circular Saw Diamond Blades 327
	Circular Saw Reinforced Cut-off Wheels 24
	6. Core Drills
	Diamond Core Bits 330
	7. Die and Pencil Grinders
	Carbide Burrs 193–196
	Coated Abrasive Small Diameter Flap Wheels 167–173, 177
	Coated Abrasive Specialties 130–138, 147, 148–164
	Mounted Points 192, 198–203
	Non-Woven Specialties 165–166
	Non-Woven Flap Wheels (2"–4" wheels) 179–180
	Non-Woven Nylon Twisted Brushes 347
	Non-Woven Surface Strip and Unified Wheels (1"–4" wheels) 188–191
	Wire Brushes 334–342
	8. Drills
	Sand-O-Flex Wheels 178
	Small Diameter Reinforced Cut-off Wheels (2" and 3" wheels with mandrel) 17–21

	9. Fixed Rail Saws
	Rail Reinforced Cut-off Wheels 35
	10. Flexible Shaft Motors
	Non-Woven Rapid Strip Wheels 188–189
	Non-Woven Unified Wheels 188–191
	11. Hand Finishing Applications
	Coated Abrasive Paper Discs 86
	Coated Abrasive Sheets, Rolls and Sponges 109–123
	Flexible Diamond Coated Hand Pads 127
	Micro-Fiber Cloths, Masking Tape 349–353
	Non-Woven Hand Pads, Rolls and Sponges 121, 124–126
	Sharpening Stones and Rubbing Bricks 204–218
	Dressing Sticks 286–287
	Diamond Lapping Compound 322
	Wire Brushes 346
	12. High-Speed Gas or Electric Saws
	High-Speed Reinforced Cut-off Wheels 28–29
	High-Speed Saw Diamond Blades 325–326
	High-Speed Saws 331
	13. Horizontal/Straight Shaft Portable Grinders
	Coated Abrasive Flap Wheels with Arbor Holes (3-1/2"–5" wheels) 174–175, 177
	Cones and Plugs 38–39, 41
	Mounted Points 192, 198–203
	Non-Woven Disc Wheels 181
	Non-Woven Flap Wheels 179–180
	Non-Woven Unified Wheels 188–191
	Snagging Straight Wheels 38–40
	14. In-Line Drum Sanders
	Coated Abrasive Portable Belts 96–97
	Non-Woven Portable Belts 107–108
	15. Jitterbug Sanders
	Coated Abrasive Sheets and Rolls 109–120
	Non-Woven Rolls 121
	Non-Woven Hand Pads 124–125

Easy-to-Follow Page Guide

Key Questions to Simplify Product Selection

Am I in the right section?

- A** Product
- B** Category overview
- C** General attributes
- D** Correct machine use

How do I narrow choices?

- E** Product design variations

How do I match my end-user needs?

- F** Application recommendations
- G** Best/Better/Good performance color coding
- H** Full application / grit guide

How do I match or upgrade from a competitive product?

- I** Cross reference guide



Machine Index and Catalog Navigation

     	<p>16. Masonry Saws Large, Compact, and Portable Masonry Saws 325</p> <p>17. Orbital Sanders Coated Abrasive Paper Discs 72-80 Coated Abrasive Small Diameter Cloth PSA Discs 69-70 Film and Foam Finishing Discs 82-83 Flexible Diamond Coated PSA Discs 84 Mesh Discs 81</p> <p>18. Portable Belt Sanders Coated Abrasive Portable Belts 96-97 Non-Woven Portable Belts 107-108</p> <p>19. Portable Cut-off Tool Small Diameter Reinforced Cut-off Wheels (1-1/2"-4" wheels) 17-21</p> <p>20. Portable File Belt Sanders Coated Abrasive File Belts 93-95 Non-Woven File Belts 107-108</p> <p>21. Right Angle/Vertical Shaft Portable Grinders Coated Abrasive Fiber Discs 50-54 Coated Abrasive Film and Foam Finishing Discs 82-83 Coated Abrasive Flap Discs 55-60 Coated Abrasive Paper Discs 72-80 Coated Abrasive Quick-Change Discs 131-138 Depressed Center Grinding Wheels, Notchers, Saucers and Type 29 Wheels 8-16 Diamond Blades 327 Flexible Diamond PSA & Quick-Change Discs 84 Non-Woven Depressed Center Discs 61-64 Non-Woven Discs 65-68, 139-147 Non-Woven Nylon Disc Brushes 347 Non-Woven Nylon Stem Mounted and End Brushes 341-345 Pneumatic Air Tool 129 Right Angle Grinder Reinforced Cut-off Wheels, Type 01/41 and Type 27/42 17-20, 22-23 Wire Brushes 338-340</p>	     	<p>22. Right Angle/Vertical Shaft Portable Cup Grinders Diamond Cup Grinders 329 Non-Woven Nylon Cup Brushes 347 Snagging Cup Wheels 38-40 Wire Cup Brushes 334-337</p> <p>23. Sanding Boards Sanding Boards and Coated Abrasive File Strips 115</p> <p>24. Saw Gumming Saw Gumming Wheels 226</p> <p>25. Stationary Chop Saws Large Diameter Reinforced Cut-off Wheels 31</p> <p>26. Stationary Disc Sanders Coated Abrasive Large Diameter Cloth PSA Discs (10"-24" discs) 69, 71</p> <p>27. Walk-Behind Saws Diamond Blades 328 Reinforced Cut-off Wheels 30 Walk-Behind Push Saws 331 Wire Brushes 339</p>
---	--	--	--

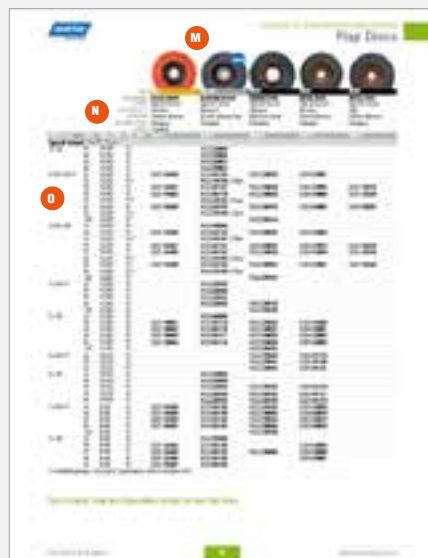

What are the Leading Products by Tier?

- J** Tiers by color-coding: Best, Better, Good
- K** Features and benefits
- L** New, improved, and/or expanded offering

How Do I Find What I Want Now That I Know What I Want?

- M** Visual identification
- N** Key product attributes
- O** Full specification and product number

⚠ WARNING

Improper use of abrasive products might cause grinding wheel breakage and serious injury. Comply with ANSI B7.1, OSHA and Safety Guide furnished with package. Don't overspeed, abuse, or drop wheel. Always use a guard, personal protective equipment and proper mounting procedures.



Speeds

Check machine spindle speed and speed listed on machine against safe maximum operating speed marked on the grinding wheel. Do not overspeed the wheel.

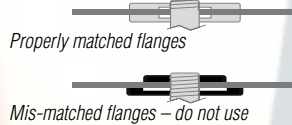

Flanges

When mounting most grinding wheels, use flanges of equal diameter and bearing surface. For exceptions, see ANSI B7.1.



Safety Gloves

Grinding applications are conducted in harsh environments. The use of proper fitting gloves is recommended.



Wheel Guard

Always use the wheel guard as supplied by the machine manufacturer, in the proper position.



Do Not Use Damaged Wheel

Always check each wheel for cracks or damage before use. Never use a damaged wheel.



Eye/Face Protection

Always wear government-approved face and eye protection when using abrasive products.



Hearing Protection

Use of abrasive products can create elevated sound levels. Hearing protection must be worn where required.



Safety Guides, SDS and Wheel Warning Messages

Before using any abrasive materials, READ:

- The Safety Guides
- Wheel Warning Messages
- Safety Data Sheets (SDS)

All Norton products provide information pertaining to safe use. Please take the time to read it carefully. Contact suppliers of the workpiece and abrasive materials for copies of the SDS if one is not readily available.



Dust Protection

Exposure to dust generated from workpiece and/or abrasive materials can result in lung damage and/or other physical injury.

Use dust capture or local exhaust as stated in the SDS. Wear government-approved respiratory protection and eye and skin protection. Failure to follow this warning can result in serious lung damage and/or physical injury.

This is a general dust warning and does not cover specific situations. For more information, refer to the SDS dust warning provided with your products, and workpiece.

Please see pages 354 - 360 for additional safety information



when the going
gets rough

**RELY ON
NORTON INNOVATION**

For stock removal, rough blending,
cleaning castings and welds...Norton
depressed center wheels are
constructed to tackle the demanding
work of all material types.



Depressed center wheels may also be referred to as raised hub wheels or by their shape designation of "Type", with Type 27 being the most popular. The depressed center design allows the flange/lock nut to recess within the wheel so that it can be used for various grinding and cutting applications. Depressed center wheels are designed to handle the most severe right angle grinding applications from heavy stock removal to rough blending. More recently, depressed center wheels have been designed to increase the utility of the tool for cut-off applications. While large right angle grinders (7" & 9") have been around for many years, small or mini grinders that handle 4", 4-1/2", 5", and 6" wheels have made this machine, and wheel category, the most popular in power tools.

- Applications:** Grinding, stock removal, edge chamfering, beveling, weld blending, and cutting-off
- Size Range:** 2" – 9"
- Thickness Range:** .040" – 1/4"
- Grit Range:** 24 – 46 grits for stock removal; 60, 80 grits for blending and finishing
- Abrasive Grain:** Ceramic Alumina, Diamond, Zirconia Alumina, Aluminum Oxide, Silicon Carbide
- Mounting Options:** Plain hole (3/8", 5/8" and 7/8") and discard mount (5/8"-11)
- Shape:** Type 27, Type 28, Type 29
- Machine Used:**



RIGHT ANGLE GRINDER

How to Pick the Right Wheel

DEPRESSED CENTER WHEEL DESCRIPTION CODES

BLANK = All Purpose ALU = Aluminum FC = Fast Cut HD = Heavy Duty INOX/SS = Contaminant Free LL = Long Life XXL = Extra Long Life
 ■ = Aluminum ■ = Foundry ■ = Masonry ■ = Stainless ■ = Steel / Metal

DESCRIPTION CODE DEFINITIONS

BLANK = All Purpose	Where an excellent blend of cut rate and life is needed.
ALU = Aluminum	Specially formulated bond for reduced loading and surface contamination while cutting aluminum and soft materials.
FC = Fast Cut	Where fast stock removal is needed, or the application only allows for low-pressure or under-horsepowered grinders.
HD = Heavy Duty	Triple reinforced for the most aggressive foundry applications
INOX/SS = Contaminate Free	Contain <0.1% iron, sulfur or chlorine for rust-free and corrosion-free results. Will not contaminate stainless steel.
LL = Long Life	Where durability is needed due to severe application, and when horsepower of the grinder allows for heavy pressure.
XXL = Extra Long Life	Offers 50% more life and metal removal than standard aluminum oxide wheels.

How to Pick the Right Mount

Most wheel sizes come with a plain hole or a discard mount option. While the plain hole has a small, initial cost advantage, the discard mount can provide a labor cost advantage with the quicker wheel change.

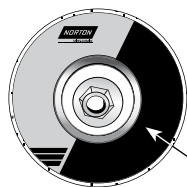

Mini-Mount Hub

Our unique, patented mini-mount hub used on 4-1/2" and 5" depressed center wheels provides up to 30% more wheel life because the hub covers just a small surface area, providing maximum grinding area exposure and usage.

Standard throw-away hub size

Why Choose Depressed Center Wheels?

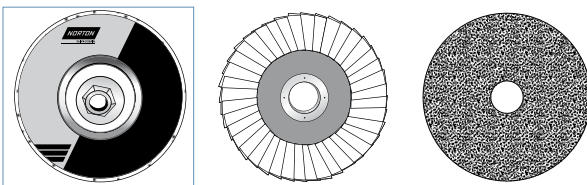

Depressed Center Wheels vs. Flap Discs or Fiber Discs

- Up to 5X life over flap discs, less downtime and inventory
- Up to 100X life over fiber discs, less downtime and inventory
- Rigidity for severe operations and high power grinders
- 1/8" wheels can be used for cutting and grinding
- Can be used to grind inside corners at outer edge of wheel

Type-To-Application Recommendation Guide

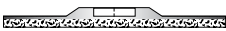
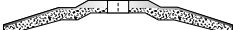
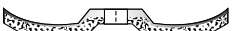
Wheel Type/Thickness	Applications	90° ANGLE	30° ANGLE	15° ANGLE
 TYPE 27 .040", .045", and 1/16" Type 27/42 RightCut 3/32" and .125" Type 27/42	Type 27 wheels are essentially straight wheels that have a "depressed center/ raised hub". Different types of fiberglass reinforcement mesh give the product stability for use on the periphery, on the face, or a combination of the two. Cutting only, where fast cutting and low kerf loss are desired	◆		
1/8" Type 27	For multiple applications ranging from cutting-off, notching and light-duty side grinding	◆	◆	
1/8" Pipe Notcher Type 27	2-1/2 pieces of reinforcement; durable face grinding; root pass grinding without removing pipe material	◆	◆	
1/8" Type 27 Flexible	For light stock/blending/finishing/polishing		◆	
.140" and 1/8" Type 27 Foundry Notchers	Triple-reinforced for grinding steel and dirty/scale-covered castings; removing and cleaning gates and risers	◆	◆	
1/4" Type 27 Foundry Snaggers	For light- to heavy-duty grinding on the bottom/face of the wheel Designed for cleaning parting lines, pads and slag		◆	
1/4" Type 27 Heavy-Duty Foundry	Triple-reinforced for the most aggressive foundry applications		◆	
 TYPE 28 1/4" Type 28 Saucers	Type 28 wheels are constructed with a downward angle built into the grinding section to facilitate a flatter grinding angle. These wheels can only be used on the face and never on the periphery for cutting-off. Smooth, gouge-free grinding at shallow angles			◆
 TYPE 29 1/8" Type 29 Flexible, AVOS	Type 29 wheels are constructed with an upward angle built into the grinding section to provide full face contact for light stock removal and blending operations. These wheels can only be used on the face and never on the periphery for cutting-off. Polishing and blending applications			◆

Material/Application-To-Product Recommendation Guide

	BEST		BETTER	GOOD		
	Quantum3	NorZon Plus	BlueFire	Gemini	Metal	Masonry
CUTTING						
Mild Carbon / High Tensile Steel	◆	◆	◆	◆	◆	
Stainless Steel / Alloys	◆	◆	◆	◆	◆	
Contaminate Free*			◆ FC/INOX/SS	◆ INOX/SS		
Cast Iron	◆	◆		◆		
Gray Iron						
Aluminum / Bronze / Brass				◆ ALU		
Asphalt / Brick / Concrete						◆
Fiberglass / Plastic						◆
NOTCHING						
Mild Carbon / High Tensile Steel	◆	◆	◆	◆	◆	
Stainless Steel / Alloys	◆	◆	◆	◆ INOX/SS		
Contaminate Free*			◆ FC/INOX/SS	◆ INOX/SS		
Cast Iron	◆	◆	◆ Foundry	◆		
GRINDING						
Mild Carbon / High Tensile Steel	◆	◆	◆	◆		
Stainless Steel / Alloys	◆		◆	◆		
Contaminate Free*	◆		◆ FC/INOX/SS	◆ INOX/SS		
Cast Iron		◆	◆ Foundry	◆		
Gray Iron	◆		◆ Foundry	◆		
Aluminum / Bronze / Brass				◆ ALU		
Asphalt / Brick / Concrete						◆
BLENDING						
Mild Carbon / High Tensile Steel				◆ Flexible		
Stainless Steel / Alloys				◆ Flexible		
Aluminum / Bronze / Brass				◆ Flexible		
Fiberglass / Plastic				◆		

Typical Steel, Stainless Steel, Cast Iron Products: Angle Iron, Bar Stock, Ductile Pipe, Channel Iron, Decking, Rebar, I-Beams, Rail Steel, Studs, Tubing, and Welds
 * For use in nuclear and food industry applications that require contaminant free (<0.1% iron, sulfur or chlorine)

Cross Reference Guides

Type 27 and 28 – 1/8" and 1/4"

NORTON	TOTAL PERFORMANCE						INITIAL PRICE				SPECIALTY		
	BEST		BETTER		GOOD		BETTER		GOOD				
	Quantum3	NorZon Plus LL	NorZon Plus	BlueFire	BlueFire FC/INOX/SS	Gemini XXL	Gemini	Gemini Fast Cut	Gemini SS	Metal	BlueFire Foundry	Gemini ALU	Masonry
3M	Cubitron II	-	-	-	-	High Perform., Green Corps	-	-	-	-	-	-	-
Arc	-	-	-	-	-	-	Predator A24R	-	-	-	-	-	-
Brilliant	-	-	-	-	Brill-Max Z24R	-	Brill-Tex A24UHPXL, A30T	Brill-Tex A24R Super-G	Brill-Tex A30P	Hornet Metal	-	Brill-Tex 30ALU	Brill-Tex C30P, Hornet Concrete
Bullard	-	-	TA24S	ZA24R Competitor	ZA24R	-	A24R	A24N	A46Q	A24R Competitor	-	AL36N	C24R
Camel	-	-	-	-	ZA24T	-	A24R	Ultra A24-N-BF, A24T Super Quickie Cut	WA24S	A24N, R&T Fast Cut	-	A30N, Fast Cut	C24R
DeWalt	-	XP Ceramic	-	XP	-	HP	-	-	HP SS	Metal	-	-	-
Flexovit	-	Flexon ZA24P ZA30T	Flexon ZA20Q	Metalhog, AXT24S	-	-	High Perform. A24/30T	High Performance A30S, Specialist A30Q & R	Free Grind A30Q	-	Flexon ZA16U	Specialist A24ALU	High Perform. C24/30P
Metabo	M-Calibur	-	-	ZA24T	-	-	A24R & T	A24N	A360	-	-	A36M	C24N
Pearl	-	-	-	-	Z24T	-	Premium Metal A24S, Redline Max A/WA24S	Premium Metal A24R, Redline Max A/WA24R	WA24R, SRT24	Silver Line A24R & S	-	D.A. Series AL24M	Silver Line C24S
Pferd	SG-Elastic Ceramic C024Q	-	-	ZA SGP, ZA T SGP	ZA R SGP, Z-SG	SG-Elastic	A-PS, A-SG	-	A-SG INOX, A-PS INOX	-	-	A-SG ALU	S-SG, Masonry
Sait	The Ultimate Grind	Saitech Ultimate Perform.	Saitech Attacker, Pipeline	Z24R Z-Tech	Stainless	-	A24R, A24Turbo	A24N	XA24Q	A24T	CA24R - Foundry	A46N-ALU	C24N
Tyrolit	-	-	-	ZA24P-BFX	ZA24N-BFX	-	A30S & Q-BFX	A30R-BFX	A30-BF INOX	A30-BF	ZZA24R-BFX	A36N-BFX WA46-BF	C30-BF
Walter	-	-	-	Allsteel XX	Double-X	Allsteel	HP	-	Stainless	-	-	-	-
Weiler	Tiger Ceramic	-	-	Tiger Zirc	Tiger Inox	Tiger LL	Wolverine A24R	-	-	Wolverine A24N	-	-	-

Type 27 – Flexible 1/8"

GOOD	
NORTON Gemini Flexible	
Brilliant	Brill-Flex
Bullard	Flexlite AC
Camel	FGF, Special Wheel
Flexovit	Flexcel
Metabo	Z-Plus
Pearl	Flexible AC
Pferd	SG-Flex
Sait	Challenger II
Walter	Flexcut





Best choice for stainless and carbon steel applications; efficiently grinds and cuts a variety of materials from alloys to gray iron

QUANTUM3 CERAMIC ALUMINA

- 100% next-generation, uniquely-shaped, ceramic alumina abrasive grain and tough new bond system result in 5-6 times the life of aluminum oxide wheels and up to 100% increase in performance and life over competitive ceramic wheels
- Significantly increase production, for the lowest total grinding cost of any wheel in the market place today
- Better operator control, improved comfort, and exceptional finished part quality with a more robust, sharper, yet smoother cutting action; wheels don't grab or dig



Best for metal plate, pipe, tubing, cast iron, carbon and mild steel, foundry and welding applications, and ceramics

DIALAST DIAMOND WHEELS

- A combination of high-quality diamond and advanced brazed single-layer bonding technology for extra-long life versus conventional abrasives or other vacuum-brazed diamond tools
- Retains diamond grains and wheel shape for full life with low sparks, while keeping a continuous grinding depth for exceptional wheel life; less blade changes reduce downtime and labor costs
- Environmentally friendly design generates minimal dust for less clean-up and safer working conditions



Better choice for stainless steel, carbon steel, alloys and gray iron

BLUEFIRE ZIRCONIA ALUMINA / A/O BLEND

- A blend of the most advanced zirconia alumina and premium aluminum oxide abrasives delivers 2 to 3 times the life of aluminum oxide wheels
- Broad utility; from light-to heavy-pressure applications
- Engineered specifically to deliver fast cut rate; excellent blend of performance and price



Good choice for steel and ferrous metals as well as specialty applications in aluminum and foundries

GEMINI ALUMINUM OXIDE

- Quality aluminum oxide for consistent performance at an economical price
- High-performance bond and wheel hardness are designed for fast cut while retaining excellent wheel life
- Versatile, general purpose specification for use on variety of materials including 400 series stainless, hard carbon steels, soft carbon steels
- Gemini XXL - fastest 100% aluminum oxide wheels on the market today with 50% more life and metal removal than standard aluminum oxide wheels



Good choice for steel/ferrous metal applications with low initial price

METAL ALUMINUM OXIDE

- Durable bond and wheel hardness are designed to provide a good mix of cut rate and life
- Good choice when low initial price is needed for small jobs or newer operators
- Metal (Aluminum Oxide) engineered for all steel/ferrous materials



Good choice for masonry applications with low initial price

MASONRY SILICON CARBIDE

- Durable bond and wheel hardness are designed to provide a good mix of cut rate and life
- Good choice when low initial price is needed for small jobs or newer operators
- Masonry (Silicon Carbide) for masonry materials such as concrete, brick and asphalt



TIER:	BEST	GOOD
TRADENAME:	NORZON PLUS	GEMINI XXL
SHAPE:	Type 27	Type 27
ABRASIVE:	Ceramic Alumina/ Zirconia Alumina	Aluminum Oxide
MATERIAL:	STAINLESS STEEL/METAL	STAINLESS STEEL/METAL

SIZE (D x T x H)	MAX. RPM	STD. PKG.	PART #	PART #
1/8" (5/32") – Pipe Notching – Type 27				
4-1/2 x 1/8 (5/32) x 5/8-11	13,580	10		662533 70272 XXL
4-1/2 x 1/8 (5/32) x 7/8	13,580	25		662533 70271 XXL
5 x 1/8 (5/32) x 5/8-11	12,225	10		662533 70273 XXL
5 x 1/8 (5/32) x 7/8	12,225	25		662528 42038 XXL
6 x 1/8 (5/32) x 5/8-11	10,185	10		662528 41193 XXL
6 x 1/8 (5/32) x 7/8	10,185	20		662528 35580 XXL
7 x 1/8 (5/32) x 5/8-11	8,600	10	662529 39184	662533 70274 XXL
7 x 1/8 (5/32) x 7/8	8,600	20		662528 35581 XXL
9 x 1/8 (5/32) x 5/8-11	6,600	10	662530 49066	662533 70275 XXL
9 x 1/8 (5/32) x 7/8	6,600	20		662533 70276 XXL

Pipe Notchers are to be used for cutting/notching only.

See Type 27 .040" – 1/4" Foundry, Type 28 Saucer, Type 27 Flexible, and Type 29 Blending Wheels at the end of this section.



TIER:	BEST	BEST	BETTER	GOOD	GOOD	GOOD
TRADENAME:	QUANTUM3	NORZON PLUS	BLUEFIRE	GEMINI	METAL	MASONRY
SHAPE:	Type 27	Type 27	Type 27	Type 27	Type 27	Type 27
ABRASIVE:	Ceramic Alumina	Ceramic Alumina/ Zirconia Alumina	Zirconia Alumina/ Aluminum Oxide	Aluminum Oxide	Aluminum Oxide	Silicon Carbide
MATERIAL:	STAINLESS STEEL/METAL	STAINLESS STEEL/METAL	STAINLESS STEEL/METAL	STAINLESS STEEL/METAL	STAINLESS STEEL/METAL	MASONRY

SIZE (D x T x H)	MAX. RPM	STD. PKG.	PART #	PART #	PART #	PART #
1/8" – Cutting / Notching / Light Grinding – Type 27						
3 x 1/8 x 3/8	18,000	25	662528 42177			
4 x 1/8 x 3/8	15,280	25	662528 42004	662528 43178	662528 42016	
4 x 1/8 x 5/8	15,280	25	662528 42005	662528 43176	662528 42017	662528 42014 662528 42013
4-1/2 x 1/8 x 5/8-11	13,580 10 13,580 10	662528 39423	662528 43323	662528 43211	662528 43590	662528 43609
4-1/2 x 1/8 x 7/8	13,580 25 13,580 25	662528 39424	662528 43324	662528 43191 FC/INOX/SS 662528 43212	662528 42029 ALU 46 662528 43591	662528 43611 662528 43601
5 x 1/8 x 5/8-11	12,225 10 12,225 10	662528 39425	662528 43330	662528 43215 662528 43195 FC/INOX/SS		662528 43615
5 x 1/8 x 7/8	12,225 25 12,225 25	662528 39426	662528 43331	662528 43216 662528 43194 FC/INOX/SS	662528 43596	662528 43616
6 x 1/8 x 5/8-11	10,185 10	662528 39427	662528 41891	662528 43199 FC/INOX/SS	662528 33965	
6 x 1/8 x 7/8	10,185 20 10,185 20	662528 39428		662528 43202 662528 43198 FC/INOX/SS	662528 01864	
7 x 1/8 x 5/8-11	8,600 10 8,600 10	662528 39429	662529 38855	662528 43233 662528 43183 FC/INOX/SS	662529 39259	07660 702678
7 x 1/8 x 7/8	8,600 20 8,600 25*	662528 39430	662529 38854	662528 43234	662529 39207	07660 775956 5-Pk
9 x 1/8 x 5/8-11	6,600 10 6,600 10	662528 39431	662530 48897	662528 43244 662528 43187 FC/INOX/SS	662530 48983	
9 x 1/8 x 7/8	6,600 20 6,600 20	662528 39432	662530 48896	662528 43245 662528 43186 FC/INOX/SS	662530 48994	

* 5-wheel Job Packs; wheels are packed 5 wheels/Pack, with 5 Job Packs/carton. Order per each wheel in standard package quantities of 25. Order in multiples of 25.

DEPRESSED CENTER WHEEL DESCRIPTION CODES

BLANK = All Purpose	ALU = Aluminum	FC = Fast Cut	HD = Heavy Duty	INOX/SS = Contaminant Free	LL = Long Life	XXL = Extra Long Life
■ = Aluminum	■ = Foundry	■ = Masonry	■ = Stainless	■ = Steel / Metal		



TIER:	BEST	BEST	BETTER	GOOD	GOOD
TRADENAME:	QUANTUM3	NORZON PLUS	BLUEFIRE	GEMINI / GEMINI XXL	METAL OR MASONRY
SHAPE:	Type 27	Type 27	Type 27	Type 27	Type 27
ABRASIVE:	Ceramic Alumina	Ceramic Alumina/ Zirconia Alumina	Zirconia Alumina/ Aluminum Oxide	Aluminum Oxide	Aluminum Oxide – Metal Silicon Carbide – Masonry
MATERIAL:	STAINLESS STEEL/METAL	STAINLESS STEEL/METAL	STAINLESS STEEL/METAL	STAINLESS STEEL/METAL	STAINLESS STEEL/METAL MASONRY

SIZE (D x T x H)	MAX. RPM	STD. PKG.	PART #	PART #	PART #	PART #	PART #
1/4" – Grinding – Type 27							
3 x 1/4 x 3/8	18,000	25		662528 42178		662528 42179	
4 x 1/4 x 3/8	15,280	25	662533 71180	662528 42002	662528 43179	662528 42018	
4 x 1/4 x 5/8	15,280	25	662533 71181	662528 42003	662528 43177	662528 42020 FC	662528 42011
	15,280	25				662528 42019	662528 42010 Masonry
	15,280	25				662528 42183 ALU 46	
4-1/2 x 3/16 x 7/8	13,580	25		662528 43592		662528 43593	
4-1/2 x 1/4 x 5/8-11	13,580	10	662533 70793	662528 43326	662528 43213	662528 43593	662528 43605
	13,580	10		662528 43327 LL	662528 43193 FC/INOX/SS	662528 43585 FC	662528 43599 Masonry
	13,580	10				662528 42032 INOX/SS	
	13,580	10				662528 43785 XXL	
	13,580	10				662528 42031 ALU 46	
	13,580	40					662528 19559
4-1/2 x 1/4 x 7/8	13,580	10 V		662528 29541 2-Pk	662528 42162 2-Pk	662528 42163 2-Pk	
	13,580	25	662533 70794	662528 43328	662528 43214	662528 43594	662528 43607
	13,580	25			662528 43192 FC/INOX/SS	662528 43584 FC	662528 43600 Masonry
	13,580	25				662528 42033 INOX/SS	
	13,580	25				662528 43784 XXL	
	13,580	25				662528 42034 ALU 46	
5 x 1/4 x 5/8-11	13,580	50					662528 36796
	13,580	10 V		662528 29540 2-Pk	662528 42164 2-Pk	662528 42165 2-Pk	
	12,225	10	662533 70795	662528 43332	662528 43217	662528 43597	662528 43613
5 x 1/4 x 7/8	12,225	10		662528 43333 LL	662528 43197 FC/INOX/SS	662528 43787 XXL	
	12,225	25	662533 70796	662528 43334	662528 43218	662528 43598	662528 43614
	12,225	25				662528 42040 INOX/SS	
	12,225	25				662528 43786 XXL	
6 x 1/4 x 5/8-11	12,225	25				662528 42039 ALU 46	
	10,185	10	662533 70797	662528 41920	662528 43224	662528 32390	
	10,185	10				662528 43789 XXL	
6 x 1/4 x 7/8	10,185	20	662533 70798	662528 09376	662528 43203	662528 01865	
	10,185	20				662528 43788 XXL	
	10,185	20				662529 40147 FC	
7 x 1/4 x 5/8-11	8,600	10	662533 70799	662529 17881	662528 43235	662529 40148 LL	662529 12633
	8,600	10		662528 35578 LL	662528 43185 FC/INOX/SS	662529 40148 LL	076607 75942 Masonry
	8,600	10				662528 43791 XXL	
	8,600	10				662529 40514 ALU 24	
	8,600	25*					076607 75940 5-Pk
7 x 1/4 x 7/8	8,600	20	662533 70800	662529 17880	662528 43236	662529 40098 LL	
	8,600	20				662528 43790 XXL	
	8,600	20				662529 40516 ALU 24	
	8,600	25*					076607 75936 5-Pk
9 x 1/4 x 5/8-11	6,600	10	662533 70801	662530 21634	662528 43246	662530 49105 FC	076607 75937 Masonry
	6,600	10		662528 30728 LL		662530 49104 LL	
	6,600	10				662528 43793 XXL	
	6,600	10				662530 49045 ALU 24	
	6,600	25*					076607 75938 5-Pk
9 x 1/4 x 7/8	6,600	20	662533 70802	662530 21633	662528 43247	662530 49077 FC	
	6,600	20		662530 49069	662528 43188 FC/INOX/SS	662530 48991 LL	

* 5-wheel Job Packs; wheels are packed 5 wheels/Pack. with 5 Job Packs/carton. Order per each wheel in standard package quantities of 25. Order in multiples of 25.
V Vendible 2-wheel Package. Ideal for vending machings and small jobs. 5 packs/carton. Order in multiples of 10.

See 1/4 inch thick Type 27 Foundry and Type 28 Saucer Wheels on the next page.

DEPRESSED CENTER WHEEL DESCRIPTION CODES							
BLANK = All Purpose	ALU = Aluminum	FC = Fast Cut	HD = Heavy Duty	INOX/SS = Contaminant Free	LL = Long Life	XXL = Extra Long Life	
■ = Aluminum	■ = Foundry	■ = Masonry	■ = Stainless	■ = Steel / Metal			



TIER:	BEST	BEST	BEST	BEST	BETTER	GOOD
TRADENAME:	QUANTUM3	NORZON PLUS	DIALAST	DIALAST	BLUEFIRE	GEMINI
SHAPE:	Type 28	Type 28	Type 29	Reversible	Type 28	Type 28
ABRASIVE:	Ceramic Alumina	Ceramic Alumina/ Zirconia Alumina	Diamond	Diamond	Zirconia Alumina/ Aluminum Oxide	Aluminum Oxide
MATERIAL:	STAINLESS STEEL/METAL	STAINLESS STEEL/METAL	STAINLESS STEEL/METAL	STAINLESS STEEL/METAL	STAINLESS STEEL/METAL	STAINLESS STEEL/METAL

SIZE (D x T x H)	MAX. RPM	STD. PKG.	PART #	PART #	PART #	PART #	PART #	PART #
1/4" – Grinding – Type 28 Saucer								
7 x 1/4 x 5/8-11	8,600	10	662533 70803	662529 05369		662528 43229	662529 40149	
7 x 1/4 x 7/8	8,600	20		662529 05368			662529 40095	
9 x 1/4 x 5/8-11	6,600	10	662533 70804	662530 06335		662528 43237	662530 49106	
9 x 1/4 x 7/8	6,600	20	662533 70805				662530 49081	
Light Grinding – Type 29								
4-1/2 x 5/8-11	13,600	1			662533 70009			
5 x 5/8-11	12,225	1			662533 70010			
6 x 5/8-11	10,200	1			662533 70011			
7 x 5/8-11	8,600	1			662533 70012			
1/4" – Grinding – Reversible Grinding Disc								
4-1/2 x 1/4 x 5/8-11	13,600	1				662533 70019		
7 x 1/4 x 5/8-11	8,600	1				662533 70020		



TIER:	BEST	BEST	BEST	BETTER
TRADENAME:	QUANTUM3	NORZON PLUS	DIALAST	BLUEFIRE
SHAPE:	Type 27	Type 27	Type 27	Type 27
ABRASIVE:	Ceramic Alumina	Ceramic Alumina/ Zirconia Alumina	Diamond	Zirconia Alumina/ Silicon Carbide
MATERIAL:	FOUNDRY	FOUNDRY	FOUNDRY	FOUNDRY

SIZE (D x T x H)	MAX. RPM	STD. PKG.	PART #	PART #	PART #	PART #	
.140", 1/8" – Cutting / Notching / Lt. Grinding – Type 27							
4-1/2 x 1/8 x 5/8-11	13,580	10				662528 43206	
4-1/2 x 1/8 x 7/8	13,580	25				662528 43204	
7 x .140 x 5/8-11	8,600	1			662533 70014		
7 x 1/8 x 5/8-11	8,600	10				662528 43232	
7 x 1/8 x 7/8	8,600	20				662529 15526	
9 x .140 x 5/8-11	6,600	1			662533 70015		
9 x 1/8 x 5/8-11	6,600	10				662528 43240	
9 x 1/8 x 7/8	6,600	20				662528 43238	
1/4" – Grinding – Type 27							
4 x 1/4 x 3/8	15,280	25				662528 43181	
4 x 1/4 x 5/8	15,280	25				662528 43180	
4-1/2 x 1/4 x 5/8-11	13,580	10				662528 43207	
4-1/2 x 1/4 x 7/8	13,580	25				662528 43205	
7 x 1/4 x 5/8-11	8,600	10				662528 43231	
7 x 1/4 x 7/8	8,600	20				662528 43230	
9 x 1/4 x 5/8-11	6,600	10	662533 70849 HD	662530 07014		662528 43241	
		10				662528 43261 HD	
9 x 1/4 x 7/8	6,600	20	662533 70848 HD	662530 07013		662528 43239	
		20				662528 43260 HD	

All Norton foundry wheels are designed and reinforced to withstand the most aggressive foundry applications.

DEPRESSED CENTER WHEEL DESCRIPTION CODES							
BLANK = All Purpose	ALU = Aluminum	FC = Fast Cut	HD = Heavy Duty	INOX/SS = Contaminant Free	LL = Long Life	XXL = Extra Long Life	
■ = Aluminum	■ = Foundry	■ = Masonry	■ = Stainless	■ = Steel / Metal			

Depressed Center Wheels



TIER:	GOOD	GOOD
TRADENAME:	GEMINI FLEXIBLE	GEMINI
SHAPE:	Type 27	Type 29
ABRASIVE:	Aluminum Oxide	Aluminum Oxide
MATERIAL:	ALUMINUM	ALUMINUM
	STEEL/METAL	STEEL/METAL

SIZE (D x T x H)	MAX. RPM	STD. PKG.	GRIT	PART #	PART #
1/8", 1/4" – Blending – Type 27 and 29					
2 x 1/8 x 3/8	30,560	25	60	662528 35632*	
	30,560	25	80	662528 35633*	
4 x 1/8 x 5/8	15,280	20	36	662435 29721#	
	15,280	20	60	662435 29722#	
4-1/2 x 1/8 x 5/8-11	12,000	10	36		662528 42203
4-1/2 x 1/8 x 7/8	12,000	25	36	662528 30424#	662528 42204
	12,000	25	60	662528 30425#	
5 x 1/8 x 7/8	12,225	25	36		662528 42205
7 x 1/8 x 5/8-11	8,600	10	36	662529 39024	662529 17052
7 x 1/8 x 7/8	8,600	20	36	662529 39028#	662529 17051

*5 wheels per display pack; 5 display packs per standard package.

These wheels are packed 20 per box, and must be used with this specific back plate. Two back plates are included in each box.



Depressed Center Adapter Kit

This reusable adapter kit contains everything you need to mount depressed center wheels and saucers with 7/8" center holes on to portable right angle or vertical shaft grinders. Adapter hubs are threaded for mounting on to standard 5/8"-11 NCRH spindles.

KIT NO.	WHEEL DIAMETER	WHEEL THICKNESS	PART #	STD. PKG.
114	6" thru 9"	1/16" thru 1/4"	076607 89275	1

DEPRESSED CENTER WHEEL DESCRIPTION CODES

BLANK = All Purpose	ALU = Aluminum	FC = Fast Cut	HD = Heavy Duty	INOX/SS = Contaminant Free	LL = Long Life	XXL = Extra Long Life
■ = Aluminum	■ = Foundry	■ = Masonry	■ = Stainless	■ = Steel / Metal		

no short cuts taken here
**SATISFY ALL YOUR
CUT-OFF REQUIREMENTS**

From small diameter portable cut-off wheels to large diameter foundry cut-off wheels; from portable high-speed gas saw wheels to precision toolroom and Metlab wheels, our Norton offering encompasses the broadest range of applications.



Small Diameter Reinforced Cut-off



The Norton small diameter cut-off wheel line consists of Type 01/41 straight and Type 27/42 depressed center cut-off wheels from 1-1/2" to 9" diameters. These wheels come in ultra thin .035" for quick burn-free and burr-free cutting to .125" for more durable applications. All are reinforced for the demanding nature of portable cut-off.

- Applications:** Cutting sheet metal, cutting pipe, and metal fabrication
- Size Range:** 1-1/2" - 9" diameter
- Thickness Range:** .035", .040", .045", .050", .060", 1/16", .090", 3/32" and .125"
- Abrasive Grain:** Ceramic Alumina / Zirconia Alumina, Zirconia Alumina / Aluminum Oxide, Aluminum Oxide, Silicon Carbide, Diamond
- Shape:** Type 01/41 Straight and Type 27/42 Depressed Center
- Machine Used:**

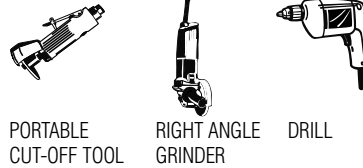

How to Pick the Right Wheel Type

CUT-OFF WHEEL DESCRIPTION CODES					
BLANK = All Purpose	ALU = Aluminum	FC = Fast Cut	INOX/SS = Contaminant Free	LL = Long Life	1-2-3 = Cutting/Notching/Grinding
■ = Masonry	■ = Stainless	■ = Steel / Metal			

DESCRIPTION CODE DEFINITIONS	
BLANK = All Purpose	Where an excellent blend of cut rate and life is needed
ALU = Aluminum	Specially formulated bond for reduced loading and surface contamination while cutting aluminum and soft materials
FC = Fast Cut	Where fast stock removal is needed, or the application only allows for low-pressure or under-horsepowered grinders
INOX/SS = Contaminate Free	Contain <0.1% iron, sulfur or chlorine for rust-free and corrosion-free results. Will not contaminate stainless steel
LL = Long Life	Where durability is needed due to severe application, and when horsepower of the grinder allows for heavy pressure
RightCut = Cutting-off Only	RightCut wheels for cutting only, provide noticeably longer life and faster cut rate versus competitive wheels, and less pressure is required for first cut
1-2-3 = Cutting/Notching/Grinding	Can be used in cutting, notching and grinding applications

Type-to-Application Recommendation Guide

Wheel Type/Thickness	Applications	
TYPE 01/41 	Type 01/41 straight cut-off wheels are designed for portable cut-off tool applications. All are supplied with full fiberglass reinforcing.	
.035, .040, .060, and 1/16 .125	Where fast cutting and low kerf loss are desired For tough cutting and notching applications where stability is important	◆ ◆
TYPE 01/41 RIGHTCUT 	Type 01/41 RightCut straight cut-off wheels are designed for use on right angle grinder cut-off applications. All are supplied with full fiberglass reinforcing.	
.035, .040, .045, .050, 1/16 3/32	Where fast cutting and low kerf loss are desired For tough cutting and notching applications where stability is important	◆ ◆
TYPE 27/42 RIGHTCUT 	Type 27/42 RightCut depressed center cut-off wheels are designed for use on right angle grinder cut-off applications. Their depressed center shape provides a recess for the hub, which allows flush cutting. All are supplied with full fiberglass reinforcing.	
.040, .045, 1/16 3/32, .125	Where fast cutting and low kerf loss are desired For tough cutting and notching applications where stability is important	◆ ◆

Small Diameter Reinforced Cut-off

Material-To-Product Recommendation Guide

	BEST		BETTER	GOOD		
	Quantum3	NorZon Plus	BlueFire	Gemini	Metal	Masonry
Mild Carbon / High Tensile Steel	◆	◆	◆		◆	
Stainless Steel / Alloys	◆	◆	◆	◆		
Contaminate Free*				◆ INOX/SS		
Cast Iron	◆	◆	◆	◆		
Aluminum / Bronze / Brass				◆ ALU		
Asphalt / Brick / Concrete						◆

* For use in nuclear and food industry applications that require contaminant free (<0.1% iron, sulfur or chlorine)

Cross Reference Guides

Type 01/41 .035" - .125" Reinforced Cut-off Wheels for Portable Cut-off Tools



NORTON	TOTAL PERFORMANCE ←				INITIAL PRICE →	
	BEST		BETTER	GOOD		
	NorZon Plus	BlueFire	Gemini Free Cut	Gemini Long Life	Metal	
Brilliant	—	Brill-Max ZA	—	—	Safe-Tex FC, LL	
Bullard	—	ZA46T, ZA60T	TA36T	TA46T, TA60T	A36T, A60T Comp.	
Camel	—	ZA60-TBF	A36 RBF	A60 RBF	Fast Cut RBF	
Flexovit	Flexon Fast Cut A46, 60	—	High Perf Fast Grind A36	High Perf Fast Cut A36, 46, 60	—	
Pearl	—	SRT, Zirconia	—	Premium	Silver Line	
Pferd	—	—	—	—	PSF-A	
Sait	Saittech	—	A60S	A24R, A36T, A60T	—	
Spedecut	—	—	—	—	A46, 60 TBXX	
Walter	—	—	A24 ZIP	A60 ZIP	—	

Type 01/41 and Type 27/42 .035" - .125" Reinforced Cut-off Wheels for Right Angle Grinders



90° angle

NORTON	TOTAL PERFORMANCE ←			INITIAL PRICE →		SPECIALTY →		
	BEST		BETTER	GOOD		GOOD		
	Quantum3 .045"	Quantum3 1/16"	BlueFire	Gemini Free Cut	Gemini	Metal	Gemini ALU	Gemini INOX/SS
3M	—	Cubitron II .045	—	—	—	—	—	—
Brilliant	—	—	—	Brill-Blade Extra FC	Brill-Blade Heavy Duty	Hornet Stinger	—	—
Bullard	—	—	ZA60T	SGA60U	TA46T, TA60T, TA60U	A46T, A60T Comp.	AL46N	—
Camel	—	—	ZA Quickie Cut	A36-S-BF	Super Quickie Cut	Quickie Cut	A46 Quickie Cut	A60-T-BF, WA60R, Quickie Cut
DeWalt	XP Ceramic 0.040	XP Ceramic 1/16", XP Ceramic 0.045	XP	—	HP	Metal	—	—
Flexovit	—	—	—	Razorblade A60SST	Razorblade A24T, 30V, 36T	—	Razorblade A30Q	—
Metabo	Slicer Limited Edition .040	M-Calibur 1/16	Super Slicer	—	Slicer-Plus, Original Slicer LL	Original Slicer	—	—
Pearl	—	—	Redline Max Slimcut	—	Slimcut	Slimcut Pro-V, Silverline	—	—
Pferd	SG Elastic, SG Plus 1mm	SG Plus 1.6, SG Elastic 1.6	—	—	—	PS-Forte	SG-ALU	—
Sait	—	The Ultimate Ceramic Cutoff .045, Saittech	Z-tech	SAIT.M.X	Sait .045, The Ultimate Cutoff	—	A46N	XA46R
SpedeCut	—	—	—	—	—	A46, 60 TBXX	—	—
Walter	Zip One	—	Zip+ Xtra	A-30-ZIP	A-60-ZIP	—	A-60-ZIP-ALU	A60-SS-ZIP
Weiler	Tiger Zirc Ultra Cut 1mm, Tiger INOX UltraCut 1mm	Tiger Ceramic .045, Tiger Zirc .045, Tiger INOX .045	—	—	Tiger	Wolverine	—	—

Small Diameter Reinforced Cut-off

SAFETY

Dangerous Pairing: Die Grinders and Cut-off Wheels

While die grinders and cut-off tools may look similar, they are not interchangeable. Small diameter cut-off wheels can be used only on portable cut-off tools. Several crucial differences exist between the two handheld machines.

- Small diameter cut-off wheels must be used on portable cut-off tools with guards for the safety of the operator and bystanders. Also, portable cut-off tool guards prevent use of an oversize wheel.
- These cut-off wheels must be mounted between proper flanges on portable cut-off tools as described in the national safety standard for abrasive wheels, ANSI B7.1. Die grinders make use of a collet for mounting.
- All cut-off wheels must be used at or below their maximum operating speed, marked clearly on the side of the wheel. Die grinders operate above cut-off wheel speeds. Excessive speed can result in breakage and serious personal injury.



It is the user's responsibility to refer to and comply with ANSI B7.1

TECH TIP

Measure Your Wheel's Thickness

Why should you measure your wheel thickness? Many competitors market their wheels as .045", but they are truly thicker. New Norton Quantum3 RightCut wheels are true to size so you can pick the right wheel for the job whether you need precision cutting or rugged durability. Compare our 1/16" Quantum3 with competitive 0.045" ceramic cut-off wheels and you will see the longest life and fastest cut on the market.



It is the user's responsibility to refer to and comply with ANSI B7.1

Norton Quantum3 RightCut Wheels

The Norton Quantum3 RightCut is our top tier cut-off wheel, available in 0.045" and 1/16" thickness. If you want speed of cut and work on thin or hollow materials, the 0.045" will get you there with comfort. If you are cutting thicker materials and life of the wheel is important, then the 1/16" is ideal. Whatever your pick is, experience the extra-smooth cutting action, thanks to our premium ceramic grain.



Norton Quantum3 RightCut: 0.045" versus 1/16"

How to match the wheel to the application

5" x .045" x 7/8"
125 x 1.2 x 22mm

5" x 1/16" x 7/8"
125 x 1.6 x 22mm

PRODUCT	0.045" (FAST CUTTING)	1/16" (LONGEST LIFE)
Abrasive:	Ceramic	Ceramic
Target application:	Thin metals and/or light-style cutting	Thick metals and/or aggressive-style cutting
Strengths:	Fast cutting, smooth easy feel, precise and maneuverable, reduced burrs	Long lasting, durable, aggressive easy feel, versatile across applications and metals

Small Diameter Reinforced Cut-off



NEW

Best choice for stainless steel and carbon steel applications

QUANTUM3 CERAMIC ALUMINA

- 100% advanced ceramic alumina grain with a special shape for comfort and performance guaranteeing 7X the life of aluminum oxide wheels and 3X the life of zirconia alumina wheels
- Unique bond system prevents premature grain release maximizing wheel life
- Available in type 01 straight and type 27 depressed center cut-off wheels from 4-1/2 inch to 6 inch diameters



Best for metal plate, pipe, tubing, cast iron, carbon and mild steel, foundry and welding applications, and ceramics

DIALAST DIAMOND WHEELS

- A combination of high-quality diamond and advanced brazed single-layer bonding technology for extra-long life versus conventional abrasives or other vacuum-brazed diamond tools
- Retains diamond grains and wheel shape for full life with low sparks, while keeping a continuous grinding depth for exceptional wheel life; less blade changes reduces downtime and labor costs
- Environmentally-friendly grinding for minimal dust, less clean-up and safer working conditions



Best choice for highest productivity for steel, stainless steel and all ferrous metals

NORZON PLUS CERAMIC / ZIRCONIA BLEND

- Patented Norton SG ceramic alumina and zirconia alumina grain blend delivers the fastest cutting wheel available on the market, up to 10X faster cutting versus aluminum oxide wheels on 400 series stainless and soft and hard carbon steels
- Ultra-thin side reinforcing creates maximum cut rate and minimum kerf loss; ideal when precise thin cut is desired
- High-performance resin bond adds a freer cut and longest life



Better choice for stainless steel, carbon steel, alloys and gray iron

BLUEFIRE ZIRCONIA ALUMINA / A/O BLEND

- A blend of the most advanced zirconia alumina and premium aluminum oxide abrasives delivers 2 to 3 times the life of aluminum oxide wheels
- Ultra-thin side reinforcing for maximum cut rate with minimum kerf loss; ideal when precise, thin cut is desired
- Broad utility from light-to heavy-pressure applications



Good, versatile choice for steel and ferrous metals

GEMINI ALUMINUM OXIDE

- Quality aluminum oxide for consistent performance at an economical price
- Designed for portable cut-off tool applications where a fast cut and minimum material loss are desired
- Durable bond designed for fast cut while retaining excellent wheel life



Good choice for grinding alloys, metals, steels, and ferrous metals

METAL ALUMINUM OXIDE

- Quality aluminum oxide abrasive for quick cutting action
- Resin bond provides free cutting action with long life
- Good choice when low initial price is needed for small jobs or newer operators

Small Diameter Reinforced Cut-off



TIER:	BEST	BETTER	BETTER	GOOD	GOOD	GOOD
TRADENAME:	NORZON PLUS	BLUEFIRE	A60-OBNA2	GEMINI	GEMINI LONG LIFE	METAL
SHAPE:	Type 01/41	Type 01/41	Type 01/41	Type 01/41	Type 01/41	Type 01/41
ABRASIVE:	Ceramic Alumina/ Zirconia Alumina	Zirconia Alumina/ Aluminum Oxide	Aluminum Oxide	Aluminum Oxide	Aluminum Oxide	Aluminum Oxide
MATERIAL:	STAINLESS STEEL/METAL	STAINLESS STEEL/METAL	STAINLESS STEEL/METAL	STAINLESS STEEL/METAL	STAINLESS STEEL/METAL	STAINLESS STEEL/METAL

SIZE (D x T x H)	MAX. RPM	STD. PKG.	PART #	PART #	PART #	PART #	PART #	PART #	
.035", .040", .060", 1/16" and .125" Type 01/41 – Cut-off									
1-1/2 x .035 x 1/16	40,745	25			662434 27764				
1-1/2 x .035 x 1/8	40,745	25			662434 27831				
1-1/2 x .035 x 1/4	40,745	25			662434 27875				
2 x .035 x 1/8	30,560	25				662434 11392 FC			
2 x .035 x 1/4	30,560	25			662434 28014	662434 11393 FC			
2 x .035 x 3/8	30,560	25				662434 11394 FC			
2 x .060 x 1/8	30,560	25			662434 28041				
2 x 1/16 x 1/4	30,560	25				662434 11395 FC			
2 x 1/16 x 3/8	30,560	25				662434 11396 FC			
2 x .125 x 1/4	30,560	25				662434 11402 FC			
2 x .125 x 3/8	30,560	25				662434 11403 FC			
2-1/2 x .035 x 1/8	30,560	25			662435 28476				
2-1/2 x .035 x 1/4	30,560	25			662435 28425				
2-1/2 x 1/16 x 1/4	30,560	25				662435 10640 FC			
2-1/2 x 1/16 x 3/8	30,560	25				662435 10641 FC			
3 x .035 x 1/4	25,465	25	662435 10668		662435 28573	662435 10627 FC			
	25,465	25*	662435 31753 5-Pk						
3 x .035 x 3/8	25,465	25	662435 10669	662528 43174	662435 28574	662435 10628 FC	662435 37271 LL	076607 89451	
	25,465	25*		662435 34821 5-Pk					
3 x 1/16 x 1/4	25,465	25	662435 10670		662435 28471	662435 10645 FC	662435 10649 LL		
3 x 1/16 x 3/8	25,465	25	662435 10671	662528 43175	662435 28552	662435 10647 FC	662435 10648 LL	662528 35553	
	25,465	25	662435 10835 LL						
	25,465	25*						076607 47767 5-Pk	
	25,465	100						076607 89012	
	25,465	10-Pk†						662528 43624	
								5 Whls & 1 Mandrel/ Pack	
3 x .125 x 1/4	25,465	25				662435 10650 FC			
3 x .125 x 3/8	25,465	25	662435 10673			662435 10651 FC	662435 10653 LL		
4 x .035 x 1/4	15,300	25			662435 29606				
	19,100	25				662435 10629 FC			
4 x .035 x 3/8	19,100	25	662435 10675	662528 43173	662435 29621	662435 10630 FC	662435 37273 LL	076607 89453	
4 x .035 x 1/2	19,100	25			662435 29622				
4 x .035 x 3/4	19,100	25			662435 29609				
4 x .040 x 3/8	19,100	25			662435 29516				
4 x 1/16 x 1/4	19,100	25	662435 10676			662435 10654 FC			
4 x 1/16 x 3/8	19,100	25	662435 10677	662528 43171		662435 10655 FC		662528 43848	
4 x 1/16 x 5/8	19,100	100			662435 27827				
					FabCut				
4 x .125 x 1/4	19,100	25				662435 10658 FC			
4 x .125 x 3/8	19,100	25	662435 10841	662528 43172		662435 10659 FC	662435 10661 LL		
	19,100	25	662435 10680 LL						

* 5-wheel Job Packs; wheels are packed 5 wheels/Pack, with 5 Job Packs/carton. Order per each wheel in standard package quantities of 25. Order in multiples of 25.
 † Order per number of pack, in multiples of 10 packs. Priced per pack.



Drill-Mount Mandrel

Used for mounting 2" and 3" x 3/8" hole cut-off wheels on to a drill

DESCRIPTION	STD. PKG.	PART #
Drill-Mount Mandrel	1	076607 47769



CUT-OFF WHEEL DESCRIPTION CODES

BLANK = All Purpose ALU = Aluminum FC = Fast Cut INOX/SS = Contaminant Free LL = Long Life 1-2-3 = Cutting/Notching/Grinding
 ■ = Masonry ■ = Stainless ■ = Steel / Metal

Small Diameter Reinforced Cut-off



TIER:	BEST	BEST	BEST	BETTER	GOOD	GOOD
TRADENAME:	QUANTUM3 RIGHTCUT	NORZON PLUS RIGHTCUT	DIALAST RIGHTCUT	BLUEFIRE RIGHTCUT	GEMINI RIGHTCUT	METAL RIGHTCUT
SHAPE:	Type 01/41	Type 01/41	Type 01/41	Type 01/41	Type 01/41	Type 01/41
ABRASIVE:	Ceramic Alumina	Ceramic Alumina/ Zirconia Alumina	Diamond	Zirconia Alumina/ Aluminum Oxide	Aluminum Oxide	Aluminum Oxide
MATERIAL:	STAINLESS	STAINLESS	STAINLESS	STAINLESS	STAINLESS	STAINLESS
	STEEL/METAL	STEEL/METAL	STEEL/METAL	STEEL/METAL	STEEL/METAL	STEEL/METAL

SIZE (D x T x H)	MAX. RPM	STD. PKG.	PART #	PART #	PART #	PART #	PART #	PART #
.035", .040", .045", .050", 1/16, and 3/32" Type 01/41 – RightCut Cut-off								
4 x .040 x 5/8	15,280	25						076607 01616
4 x .045 x 5/8	15,280	25					662435 27956	
4 x 3/32 x 5/8	15,280	25					662435 27955	
4-1/2 x .035 x 7/8	13,580	25						662528 43846
4-1/2 x .040 x 7/8	13,580	25					662528 43225	076607 01617
	13,580	50						662533 70222
	13,580	250+						662528 40001
	13,580	25*						662528 42158 5-Pk
4-1/2 x .045 x 7/8	13,580	25	662528 38454				662528 23602	
	13,580	25					662528 41994 ALU	
	13,580	25					662528 41997 INOX/SS	
	13,580	250+					662528 41213	
	13,580	25*					662528 42160 5-Pk	
4-1/2 x .050 x 7/8	13,580	1			662533 70016			
4-1/2 x 1/16 x 7/8	13,580	25	662528 38455			662528 43208		662528 43845
	13,580	25*				662528 42159 5-Pk		
	13,580	250+				662533 71660		
4-1/2 x 3/32 x 7/8	13,580	25					662528 23599	
5 x .040 x 5/8	12,225	25						662528 43847
5 x .040 x 7/8	12,225	25					662528 43226	076607 01618
5 x .045 x 7/8	12,225	25	662528 38460				662528 23603	
	12,225	25					662528 41995 ALU	
	12,225	250+					662528 41214	
	12,225	25*					662528 42170 5-Pk	
5 x .050 x 7/8	12,225	25		662528 09829 NZ ThinCut				
	12,225	1			662533 70017			
5 x 1/16 x 7/8	12,225	25	662528 38462			662528 43209		
	12,225	25*				662528 42169 5-Pk		
5 x 3/32 x 7/8	12,225	25					662528 23600	
6 x .040 x 7/8	10,185	25						076607 02757
	10,185	50						662533 70223
	10,185	250+						662528 41212
6 x .045 x 7/8	10,185	25					662528 23604	
	10,185	25					662528 41996 ALU	
	10,185	25					662528 41999 INOX/SS	
	10,185	250+					662528 41215	
	10,185	25*				662528 42174 5-Pk	662528 42175 5-Pk	
6 x .050 x 7/8	10,185	1			662533 70018			
6 x 1/16 x 7/8	10,185	25	662528 38465			662528 43210		
	10,185	250+				662533 71662		
6 x 3/32 x 7/8	10,185	25					662528 23601	
7 x .045 x 7/8	8,600	25					662528 32323	
	8,600	20					662528 42000 INOX/SS	
7 x 1/16 x 7/8	8,600	25		662529 00652				
	8,600	1				701846 94055		
9 x .060 x 7/8	6,600	1				701846 94056		

RightCut wheels are to be used for cutting only

* 5-wheel Job Packs; wheels are packed 5 wheels/Pack, with 5 Job Packs/carton. Order per each wheel in standard package quantities of 25. Order in multiples of 25.

+ Bulk packed 250 Wheels/carton; 5 inner boxes of 50 wheels each. Order in multiples of 250 wheels.

CUT-OFF WHEEL DESCRIPTION CODES

BLANK = All Purpose ALU = Aluminum FC = Fast Cut INOX/SS = Contaminant Free LL = Long Life 1-2-3 = Cutting/Notching/Grinding
 ■ = Masonry ■ = Stainless ■ = Steel / Metal

Small Diameter Reinforced Cut-off



TIER:	BEST	BEST	BETTER	GOOD	GOOD
TRADENAME:	QUANTUM3	NORZON PLUS	BLUEFIRE	GEMINI	METAL
SHAPE:	Type 27/42	Type 27/42	Type 27/42	Type 27/42	Type 27/42
ABRASIVE:	Ceramic Alumina	Ceramic Alumina/ Zirconia Alumina	Zirconia Alumina/ Aluminum Oxide	Aluminum Oxide	Aluminum Oxide
MATERIAL:		STAINLESS STEEL/METAL	STAINLESS STEEL/METAL	STAINLESS STEEL/METAL	STAINLESS STEEL/METAL
				ALUMINUM	

SIZE (D x T x H)	MAX. RPM	STD. PKG.	PART #	PART #	PART #	PART #	PART #
.040, .045, 1/16" – RightCut Cut-off – Type 27/42							
4 x .045 x 5/8	15,280	25				662528 42180	076607 05249
4-1/2 x .040 x 5/8-11	13,580	10				662528 43227	
4-1/2 x .045 x 5/8-11	13,580	10				662528 42025	
	13,580	10				662528 41913 INOX/SS	
4-1/2 x .045 x 7/8	13,580	25				662528 42026	662528 43604
	13,580	25				662528 41912 INOX/SS	
	13,580	25				662528 41909 ALU 36	
	13,580	25*				662528 42161 5-Pk	
	13,580	250				662533 70065 250-Pk	
4-1/2 x 1/16 x 5/8-11	13,580	10	662528 38457		662528 43223		
4-1/2 x 1/16 x 7/8	13,580	10			662528 43219		
	13,580	25	662528 38456				
5 x .040 x 5/8-11	12,225	10				662528 43228	
5 x .045 x 5/8-11	12,225	10				662528 41939	
5 x .045 x 7/8	12,225	25				662528 42036	662528 43849
	12,225	25				662528 41914 INOX/SS	
	12,225	25				662528 41910 ALU 36	
	12,225	25*				662528 42171 5-Pk	
	12,225	250				662533 70066 250-Pk	
5 x 1/16 x 7/8	12,225	25	662528 38464		662528 43220		
6 x .045 x 5/8-11	10,185	10		662528 42007		662528 30587	
6 x .045 x 7/8	10,185	25				662528 42202	662528 42015
	10,185	25				662528 41916 INOX/SS	
	10,185	25				662528 41911 ALU 36	
	10,185	25*				662528 42176 5-Pk	
	10,185	250				662533 70067 250-Pk	
6 x 1/16 x 7/8	10,185	25	662528 38466		662528 43221		
7 x .045 x 5/8-11	8,600	10				662528 41919 INOX/SS	
7 x .045 x 7/8	8,600	20				662529 12626	
	8,600	20				662528 41918 INOX/SS	
7 x 1/16 x 7/8	8,600	10					076607 05251
9 x 1/16 x 5/8-11	6,600	10				662530 19115	
9 x 1/16 x 7/8	6,600	10				662530 17734	
<i>RightCut wheels are to be used for cutting only.</i>							
3/32", .125" – Cut-off – Type 27/42							
4 x .125 x 3/8	15,280	25		662528 42001			
4-1/2 x 3/32 x 5/8-11	13,580	10				662528 41903	
	13,580	10				662528 42027 INOX/SS	
4-1/2 x 3/32 x 7/8	13,580	25				662528 41940	
	13,580	25				662528 42028 INOX/SS	
	13,580	25				662528 43582 1-2-3	
4-1/2 x .125 x 5/8-11	13,580	10	662528 43321			662528 43588	
4-1/2 x .125 x 7/8	13,580	25	662528 43322			662528 43589	
5 x 3/32 x 5/8-11	12,225	10				662528 41904	
5 x 3/32 x 7/8	12,225	25				662528 42037 INOX/SS	
	12,225	25				662528 43587 LL	
5 x .125 x 7/8	12,225	25				662528 43595	
6 x 3/32 x 5/8-11	10,185	10				662528 41905	
6 x 3/32 x 7/8	10,185	25				662528 41906	
	10,185	25				662528 32487 INOX/SS	
6 x .125 x 5/8-11	10,185	10				662528 41192	
6 x .125 x 7/8	10,185	25				662528 42021	
7 x 3/32 x 5/8-11	8,600	10				662528 41907	
7 x 3/32 x 7/8	8,600	20				662528 41908	
	8,600	20				662529 14638 INOX/SS	
7 x .125 x 5/8-11	8,600	10		662529 12625			
7 x .125 x 7/8	8,600	20		662529 12624		662529 00619	
9 x 3/32 x 5/8-11	6,600	10			662528 42378		
9 x 3/32 x 7/8	6,600	20			662528 42343		

*These wheels are to be used for cutting only. * 5-wheel Job Packs; wheels are packed 5 wheels/Pack, with 5 Job Packs/carton. Order per each wheel in standard package quantities of 25. Order in multiples of 25.*

Circular Saw Reinforced Cut-off

A circular saw uses an abrasive wheel to cut different materials using a rotary motion spinning around an arbor. Norton Circular Saw abrasive cut-off wheels are ideal for use in deburring, cleaning, slotting and cutting all types of metal and masonry.

Applications:

Deburring, cleaning, slotting and cutting

Size Range:

6" - 9" diameter

Thickness Range:

.035", .060", 1/16", 1/8", and .125"

Abrasive Grain:

Zirconia Alumina / Aluminum Oxide, Aluminum Oxide, Silicon Carbide, Diamond

Shape:

Type 01/41 Straight

Machine Used:



CIRCULAR SAW



TIER:	BEST	BETTER	GOOD	GOOD	GOOD
TRADENAME:	DIALAST	CHARGER	GEMINI	METAL	MASONRY
SHAPE:	Type 01/41	Type 01/41	Type 01/41	Type 01/41	Type 01/41
ABRASIVE:	Diamond	Zirconia Alumina/ Aluminum Oxide	Aluminum Oxide	Aluminum Oxide	Silicon Carbide
MATERIAL:	STAINLESS	STEEL/METAL	STEEL/METAL	STEEL/METAL	MASONRY

SIZE (D x T x H)	MAX. RPM	STD. PKG.	PART #	PART #	PART #	PART #	PART #
Type 01/41 – Circular Saw							
6 x .035 x 5/8	10,185	25		662528	09714		
6 x 1/16 x 5/8	10,185	25		662528	09718		
6-1/2 x .125 x DM-5/8	9,405	10				076607	89098
7 x 1/16 x 5/8	8,730	25		662529	05957		
7 x .060 x 7/8	8,600	1	701846	94055			
7 x 1/8 x DM-5/8	8,730	25				076607	89097
8 x 1/16 x 5/8	7,640	25		662530	17771 LL	662530	07025
	7,640	10				662530	17795
8 x 1/8 x DM-5/8	7,640	10				076607	89096
9 x .060 x 7/8	6,600	1	701846	94056			



DM Denotes Diamond Mount; 5/8" hole bushings included

CUT-OFF WHEEL DESCRIPTION CODES

BLANK = All Purpose FC = Free Cut LL = Long Life ■ = Masonry ■ = Stainless ■ = Steel / Metal

Chop Saw Reinforced Cut-off



A chop saw is a light, low-horsepower portable machine. Although very similar to a compound miter saw, it is designed for cutting denser materials, like metal bar, tubing or pipe. Chop saw cut-off wheels are designed specifically for this machine with finer grit, softer grades, and reinforcement layers that match the application.

- Applications:** Cutting small-diameter metal pieces, bar stock, metal pipe, tubing, decking, cable, drywall studs, and metal plate dimensioning
- Size Range:** 10" - 16" diameter
- Thickness Range:** 3/32" and 7/64"
- Abrasive Grain:** Zirconia Alumina / Aluminum Oxide Blend, Aluminum Oxide, and Diamond
- Shape:** Type 01/41 Straight
- Reinforcement Type:** Side reinforced, centrally reinforced
- Machine Used:**



Cross Reference Guide

	TOTAL PERFORMANCE			INITIAL PRICE			SPECIALTY	
	BETTER			GOOD			GOOD	
NORTON	BlueFire Free Cut	BlueFire Rapid Cut	BlueFire Long Life	Gemini Free Cut	Gemini Rapid Cut	Gemini Long Life	Stud Cutter	Gemini Aluminum
Brilliant	—	—	—	Super-G	Tube/Pipe	—	Drywall Stud	Aluminum
Bullard	ZA36T	—	—	TA36T A46T The Competitor	A36R The Competitor	A36R Ironmaster	A46T Studmaster	AL36R
Camel	—	—	ZA24-S	A36-P, WA36-P	—	A36-S	A30-R Mr. Stud	A30-N
Dewalt	—	—	XP	GP, Stainless Fabrication	—	—	Stud Cutting	—
Flexovit	—	—	—	A30R Fast Cut A30-Q Free Cut	—	A30S Long Life	A30T Drywall Stud	—
Makita	—	—	—	—	General Purpose	—	—	—
Pearl	SRT36	—	—	A36P Premium	A30P Silver Line	—	A46S Stud Cutting	—
Pferd	—	—	—	A 36 K SG CHOP	PSF CHOP	—	A 36 K SG-STUD	—
Sait	Saitech Steel Worker	Z-tech	—	EZ-Chop	EZ-Chop Attacker	Iron Worker	Stud King	Aluminum
Walter	—	—	—	—	A-30	A-30-HC+	—	A30-ALU

Application-to-Product Recommendation Guide

Wheel Type/Reinforcement

TYPE 01/41 STRAIGHT SIDE-REINFORCED CUT-OFF WHEEL

Side-reinforced wheels have two full layers of reinforcing and are designed for a fast cut and the most aggressive applications. All Purpose, Free Cut, and Long Life are side reinforced.



TYPE 01/41 STRAIGHT CENTRALLY-REINFORCED CUT-OFF WHEEL

Centrally-reinforced wheels have a single layer of reinforcing with exposed rough sides for free-cutting, non-binding applications where minimal burr and burn are the key requirements. Rapid Cut wheels are centrally reinforced.



How to Pick the Right Bond Type

DESCRIPTION CODE DEFINITIONS

BLANK = All Purpose	Where an excellent blend of cut rate and life is needed
FC = Free Cut	Used when fast, burn-free cutting is desired or when cutting pieces with larger cross sections
LL = Long Life	Where durability is needed due to severe application, and when cutting parts with small cross sections
RC = Rapid Cut	Where a free cutting, non-binding wheel is needed for burn-free and burr-free cuts
STUD = High-Performance	High-performance aluminum oxide/resin bond combination designed for cleaner cuts and longer life when cutting steel studs
ALU = Aluminum	Specially formulated bond for reduced loading/surface contamination when cutting aluminum/soft materials

Chop Saw Reinforced Cut-off

Designed for cutting steel, metal studs, stainless steel, non-ferrous materials, tile, brick, plastic and much more



DIALAST DIAMOND

- A combination of high-quality diamond and advanced brazed single-layer bonding technology for extra-long life versus conventional abrasives or other vacuum-brazed diamond tools
- Retains diamond grains and wheel shape for full life with low sparks, while keeping a continuous grinding depth for exceptional wheel life; less blade changes reduce downtime and labor costs
- Environmentally-friendly grinding for minimal dust, less clean-up and safer working conditions

Better choice for steel, stainless steel and all other ferrous metals



BLUEFIRE ZIRCONIA ALUMINA / A/O BLEND

- Durable, latest generation zirconia alumina and premium aluminum oxide abrasive blend outperforms competitive chop saw zirconia wheels by 20 percent
- Delivers twice the life and cut rate of aluminum oxide wheels on difficult to cut metals
- High performance resin bond is designed for free cut and long life

Good choice for all steel and ferrous metals as well as specialty applications in aluminum



GEMINI ALUMINUM OXIDE

- Durable, versatile aluminum oxide abrasive engineered for consistent performance and economical price on chop saw cut-off machine applications
- Abrasive and bond combination designed for smooth clean cut on low HP machines
- Good choice for consistent performance at an economical price

Good choice for drywall studs



METAL ALUMINUM OXIDE

- Quality aluminum oxide abrasive designed for cutting alloys, steels and ferrous metals including 400 series stainless, soft and hard carbon steels
- Designed with finer grit and softer grades, specifically for chop saw machines that typically have lower horsepower
- Constructed with full fiberglass reinforcing; Stud Cutter version designed specifically for cutting steel studs

Chop Saw Reinforced Cut-off



TIER:	BEST	BETTER	BETTER	GOOD	GOOD	GOOD	GOOD
TRADENAME:	DIALAST	BLUEFIRE	BLUEFIRE	GEMINI	GEMINI	METAL	METAL
SHAPE:	Type 01/41	Type 01/41	Type 01/41	Type 01/41	Type 01/41	Type 01/41	Type 01/41
ABRASIVE:	Diamond	Zirconia Alumina/ Aluminum Oxide	Zirconia Alumina/ Aluminum Oxide	Aluminum Oxide	Aluminum Oxide	Aluminum Oxide	Aluminum Oxide
REINFORCING:		Side	Central	Side	Central	Side	Central
MATERIAL:	STAINLESS	STAINLESS	STAINLESS	STAINLESS	STAINLESS	STAINLESS	STAINLESS
		STEEL/METAL	STEEL/METAL	STEEL/METAL	STEEL/METAL	STEEL/METAL	STEEL/METAL

SIZE (D x T x H)	MAX. RPM	STD. PKG.	PART #	PART #	PART #	PART #	PART #	PART #			
Type 01/41 Straight Cut-off											
10 x 7/64 x 1	6,110	10				662531	06109 LL				
12 x 7/64 x 1	5,095	10		662528	43250		662532	07554 LL	662532	14561 RC	
	5,095	5							076607	89400	
14 x 3/32 x 1	4,365	10				662533	06627 FC	662533	13588 RC	662528	35554
	4,365	10				662533	06626 LL		076607	89405	
										STUD	
	4,365	5 V								076607	89399
14 x 7/64 x 1	4,365	10		662528	43252 FC	662528	43254 RC	662533	14816 ALU		
	4,365	10		662528	43253 LL						
	4,365	25								076607	03970 5-Pk
14 x .155 x 1	5,400	1	701846	94053							
16 x 7/64 x 1	3,820	10		662528	43256 FC		662534	10198 LL			
	3,820	10		662528	43257 LL						



V Vendible 2-wheel Package. Ideal for vending machings and small jobs. 5 packs/carton. Order in multiples of 10.

CUT-OFF WHEEL DESCRIPTION CODES					
BLANK = All Purpose	ALU = Aluminum	FC = Free Cut	LL = Long Life	RC = Rapid Cut	STUD = Stud Cutter
■ = Masonry	■ = Stainless	■ = Steel / Metal			



High-Speed Reinforced Cut-off



Norton high-speed cut-off abrasive wheels provide the industry's leading performance in all high-speed gas and electric-powered applications.

Applications:

Metalworking: steel, stainless, ductile, cast iron, rail steel and metal decking
 Non-Metal Building Materials: concrete, brick, masonry, asphalt aggregate, stone and schedule 40 and 80 PVC pipe

Rescue and Demolition: steel, acrylic, fiberglass, rubber, glass, wood, concrete, brick and asphalt

Size Range:

12" – 16" diameter

Thickness Range:

1/8" and 5/32"

Abrasive Grain:

Aluminum Oxide, Silicon Carbide, Silicon Carbide / Aluminum Oxide Blend

Shape:

Type 01/41 Straight

Reinforcement:

Wheels are offered in standard two-layer reinforcement as well as three-layer reinforcement for higher-speed saws and heavy-duty applications.

Arbor:

Wheels are offered with patented universal arbor that accommodates both 20mm and all other machines with 1" arbors.

Machine Used:



HIGH-SPEED GAS
OR ELECTRIC SAW

Material / Application-to-Product Recommendation Guide

Icon		Application
	Metal	High-performance aluminum oxide grain wheels designed for general purpose cutting of all steel and stainless parts including rebar, steel pipe, structural steel, sheet metal, cable and small to medium diameter solid pieces.
	Metal Decking	High-performance aluminum oxide abrasive combined with a thicker wheel (5/32") that stands up to the sharp edges of sheet metal and roof decking.
	Ductile/Cast Iron	A special blend of silicon carbide abrasive for cutting and aluminum oxide abrasive for life, designed to cut ductile and cast iron pipe, concrete-lined water pipes, sewer construction and heavy duty PVC.
	Rescue	For ventilation, forcible entry, rescue and demolition. A versatile abrasive formula that can be used on a wide range of materials including all types of metals and masonry.
	Concrete	Coarse grit silicon carbide abrasive provides a low initial cost solution for cutting brick, block, concrete or other masonry materials. For higher-production applications that require optimum speed of cut and product life, please see our complete selection of high-speed diamond wheels in our Norton Construction diamond product line.
	Asphalt	A special blend of extra coarse silicon carbide abrasive grains provides a low initial cost solution for cutting asphalt, green concrete, asphalt over concrete, a wide range of aggregates and abrasive materials.

Cross Reference Guide

NORTON	SPECIALTY				
	GOOD Gemini Metal	GOOD Gemini Metal Decking	GOOD Gemini Ductile	GOOD Gemini Concrete	GOOD Gemini Asphalt
Abmast	A 24 R, Kompetitor Metal	A 24 T	AC 24 R, Kompetitor Ductile Iron	C 24 R, Kompetitor Concrete	C 16 T, Kompetitor Asphalt
Brilliant	Metal/Stainless	—	—	Concrete/Masonry	—
Bullard Blaze & Road Warrior	A24R, ZA24Q, The Competitor	TA24R	AC24R	C24R, The Competitor	CC20R
Camel	A24-R	A24-T	AC24-R	C24-R	C16-U
Flexovit	A24/30SB	A24TB	AC24SB	C30UB	C16UB
Husqvarna	Blue XHS, Blue QMS-CM, Blue EHS	Grey QMS-CM	Green QMS-CM, Green EHS	Red XHS, Red QHS-CM, Red EHS	Black QMS-AS
Pearl	SRT, Premium A36S, Silver Line A30R	—	AC30S	Premium C36S, Silver Line C24R	—
Pferd	A 24 R SG	A 24 Q SG-RAIL	AC 24 Q SG	C 24 R SG	—
Sait	A24R, A30S, XFC	Brute	Ductile	C24R	Big M.A.C, XFC
Tyrolit	A30P, A30BF	—	AC24, AC30BF	1C24, C30BF	—
Virginia Abrasives	Metal	—	Ductile	Concrete	Asphalt
Walter	A-24	—	—	—	—

High-Speed Reinforced Cut-off

How to Pick the Right Reinforcement

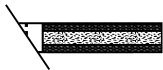

Two full layers of reinforcing are offered for lower power machines, and light-to-medium applications where speed of cut is the primary selection criterion.

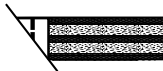

Three full layers of reinforcing are recommended for high-speed, high-power machines where the application is heavy-duty, and durability is the primary selection criterion.



TIER:	GOOD	GOOD	GOOD	GOOD
TRADENAME:	GEMINI METAL HD	GEMINI METAL	GEMINI METAL DECKING	GEMINI RESCUE
SHAPE:	Type 01/41	Type 01/41	Type 01/41	Type 01/41
ABRASIVE:	Aluminum Oxide	Aluminum Oxide	Aluminum Oxide	Silicon Carbide/ Aluminum Oxide Blend
REINFORCING:	3 Layers	2 Layers	2 Layers	2 Layers
MATERIAL:				

SIZE (D x T x H)	MAX. RPM	STD. PKG.	PART #	PART #	PART #	PART #
Type 01/41 Cut-off – for Gas & Electric-Powered Saws						
12 x 1/8 x 1" / 20mm	6,300	10	662528 36708	662528 37838		
14 x 1/8 x 1" / 20mm	5,400	10	662528 35386	662528 37841		662435 78262
14 x 5/32 x 1" / 20mm	5,400	10			662528 32521	
16 x 1/8 x 1" / 20mm	4,800	10		662528 30886		

See additional Rail Cut wheels on the next page for larger-volume jobs.



TIER:	GOOD	GOOD	GOOD	GOOD	GOOD
TRADENAME:	GEMINI DUCTILE HD	GEMINI DUCTILE	GEMINI CONCRETE HD	GEMINI CONCRETE	GEMINI ASPHALT
SHAPE:	Type 01/41	Type 01/41	Type 01/41	Type 01/41	Type 01/41
ABRASIVE:	Silicon Carbide / Aluminum Oxide Blend	Silicon Carbide / Aluminum Oxide Blend	Silicon Carbide	Silicon Carbide	Silicon Carbide
REINFORCING:	3 Layers	2 Layers	3 Layers	2 Layers	2 Layers
MATERIAL:					

SIZE (D x T x H)	MAX. RPM	STD. PKG.	PART #	PART #	PART #	PART #	PART #
Type 01/41 Cut-off – for Gas & Electric-Powered Saws							
12 x 1/8 x 1" / 20mm	6,300	10		662528 37840		662528 37839	701846 70243
14 x 1/8 x 1" / 20mm	5,400	10	662528 35388	662528 37843	662528 35387	662528 37842	701846 72877
16 x 1/8 x 1" / 20mm	4,800	10				701846 23029	



Universal Arbor

Two Blade Sizes in One

Our Norton patented 1"/20mm knock-out arbor fits all gas and electric high-speed saws. A 20mm bushing is pre-mounted into the 1" molded arbor hole. The wheel, with the 20mm bushing, can be mounted directly on any 20mm arbor high-speed saw. With the bushing removed, exposing the 1" arbor hole, the wheel can be mounted on any 1" arbor high-speed saw. Combining this arbor, with heavy-duty triple reinforcing results in a higher performing, extra strong, longer lasting cutting wheel. Once the 20mm bushing is removed, it cannot be replaced.

Walk-Behind Reinforced Cut-off



These powerful, self-propelled machines are designed to cut concrete slabs and asphalt and are normally fitted with diamond blades. For inexperienced operators or small jobs, the machines can accommodate these low initial cost, conventional abrasives wheels.

- Applications:** Cutting straight sections of concrete surfaces
- Size Range:** 14" and 18" diameter
- Thickness Range:** 3/16" – 3/8"
- Abrasive Grain:** Silicon Carbide
- Bond:** Hot Pressed (HP) – for higher-horsepower machine applications where additional durability is needed, may be used wet or dry
Cold Pressed (CP) – for lower-horsepower machines, which need a free-cutting wheel
- Shape:** Type 01/41 Straight
- Arbor:** All are 1" with a drive pin
- Machine Used:**



FLAT SAW /
WALK-BEHIND SAW

Cross Reference Guide

NORTON	SPECIALTY		
	BETTER	GOOD	GOOD
	Gemini Asphalt / Green Concrete – HP	Gemini Asphalt - CP	Gemini Concrete - CP
Abmast	—	C 16 T. Kompetitor Asphalt/Concrete	C 24 R
Bullard Blaze & Road Warrior	—	C16R & T, C16R3	—
Camel	—	C16-U	C24-R
Flexovit	HPC16AG	C16 G.P. C16UB	C20SB/C16TB
Husqvarna	Red GC-7A	Black EWC	Gold RTC, Blue RTC, Blue EWC
Pearl	—	—	Premium C36S, Silver Line C24R
Pferd	—	C 24 R SG ASP	C 24 R SG GP
Sait	Street Runner	C16	C24R, Street Walker
Tyrolit	Concrete/Asphalt CHP	Asphalt CP	Concrete CP
Virginia Abrasives	—	GC/Asphalt	Concrete
Walter	—	—	C-24



TIER:	BETTER	GOOD	GOOD
TRADENAME:	GEMINI ASPHALT - HP	GEMINI ASPHALT - CP	GEMINI CONCRETE - CP
SHAPE:	Type 01/41	Type 01/41	Type 01/41
ABRASIVE:	Silicon Carbide	Silicon Carbide	Silicon Carbide
BOND:	Hot Pressed - Long Life	Cold Pressed - Free Cut	Cold Pressed - Free Cut

MATERIAL:



SIZE (D x T x H)	MAX. RPM	STD. PKG.	PART #	PART #	PART #
Type 01/41 Cut-off – For Walk-Behind Saws					
14 x 3/16 x 1 Pin Hole	4,365	10		701846 80324	701846 80323
14 x 1/4 x 1 Pin Hole	4,365	5			701846 70533
18 x 1/4 x 1 Pin Hole	4,250	5	701846 70103		

Stationary Saw Reinforced Cut-off



The Norton stationary saw reinforced cut-off wheel line consists of Type 01/41 straight 10" - 24" wheels, designed to fit on fixed-base stationary saws that are free-standing or mounted on a workbench.

Applications:

Primary applications are cutting of all metal parts (flat stock, bars, studs, pipes, tubes, angle iron, cable), wire rope and hydraulic hose used in fabrication, construction and plant maintenance.

Size Range:

10" - 20" diameter

Thickness Range:

3/32", 1/8", 5/32", 3/16"

Abrasive Grain:

Zirconia Alumina / Aluminium Oxide Blend, Aluminum Oxide, Silicon Carbide

Shape:

Type 01/41 Straight

Machine Used:



STATIONARY SAW

Cross Reference Guide

NORTON	TOTAL PERFORMANCE				INITIAL PRICE	SPECIALITY
	BETTER	GOOD	GOOD	GOOD		
	BlueFire	Gemini Free Cut	Gemini Long Life	Gemini Rapid Cut*	Norton Masonry	Foundry Cut**
Abmast	Z 24 R3	A 30 R	—	—	—	AC 24 R3
Brilliant	—	GP Fast Cut	GPX Long Life	XL , XLX	—	—
Bullard	—	A30-R	A30-T	A300	C20R	—
Camel	ZA24-R	A24-R, A46-T	—	—	C24-R	WA24-S
Flexovit	—	A30RB Multi Purpose	A30SB Long Life, A24TB Long Life	—	C24RB	AC24PB Heavy Duty
Metabo	—	A30N, A30R	A30S, A30V	—	C30S	—
Pearl	SRT36	A30P Premium, A30Q Silver Line	A30S Premium, A36R Premium	—	C24 Silver Line	—
Pferd	ZA 24 Q/R SG-HD	A 24 N/P SG-HD	A 24 Q/S SG-HD	—	C 24 0 SG	—
Sait	—	A24N, A36R	A24R	—	C24R	—
Tyrolit	—	A30BF	—	—	C30BF	—
Walter	—	A-24-FC	A-24-RIP	—	—	—

*For Burr-Free applications, please see centrally-reinforced BlueFire Rapid Cut and Gemini Rapid Cut wheels in Chop Saw cut-off wheel section.

** For Foundry and other cut-off wheels, please refer to that section of this Norton Full Line Catalog #7362.



TIER:	BETTER	GOOD	GOOD	GOOD
TRADENAME:	BLUEFIRE	GEMINI FREE CUT	GEMINI LONG LIFE	MASONRY
SHAPE:	Type 01/41	Type 01/41	Type 01/41	Type 01/41
ABRASIVE:	Zirconia Alumina/ Aluminum Oxide	Aluminum Oxide	Aluminum Oxide	Silicon Carbide
MATERIAL:	STAINLESS	STAINLESS	STAINLESS	MASONRY
	STEEL/METAL	STEEL/METAL	STEEL/METAL	

SIZE (D x T x H)	MAX. RPM	STD. PKG.	PART #	PART #	PART #	PART #
Type 01/41 Straight Cut-Off						
10 x 3/32 x 5/8	6,110	10	662528 43248	662531 06101 FC	662531 06102 LL	
	6,110	5				076607 89391
12 x 1/8 x 1	5,095	10	662528 43249		662532 07548 LL	
	5,095	5				
14 x 1/8 x 1	4,365	10	662528 43251	662533 06609 FC	662533 06611 LL	
	4,365	5				
16 x 5/32 x 1	3,820	10	662528 43255	662534 10183 FC	662534 10184 LL	
18 x 5/32 x 1	3,015	10		662534 10185 FC		
20 x 5/32 x 1	2,710	5	662528 43258 FC	690786 09031 FC	690786 09032 LL	
	2,710	5	662528 43259 LL			
20 x 3/16 x 1	2,710	5		690786 09033 FC	690786 09034 LL	

CUT-OFF WHEEL DESCRIPTION CODES

BLANK = All Purpose FC = Free Cut LL = Long Life ■ = Masonry ■ = Stainless ■ = Steel / Metal

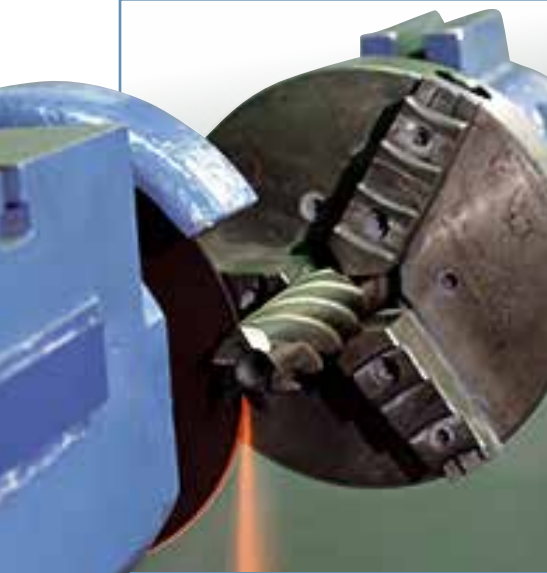

Reinforced and non-reinforced engineered cut-off wheels for cutting all types of tool steel with fixed-based cut-off machines.

Applications:

Reinforced cut-off wheels are designed to resist breakage caused by severe cross-bending and are required on any operation where the work is not securely clamped.

Non-Reinforced cut-off wheels are designed for use on fixed-based machines where the work is securely clamped, guarded, and where the wheel operates on a controlled cutting plane.

Size range:

6" – 12" diameter

Grit range:

36 – 90 grit

Abrasive grain:

Aluminum Oxide

Bond:

Resinoid, Rubber, and Shellac

Shape:

Type 01/41 Straight

Cross Reference Guide

NORTON	BETTER		
	Reinforced A60-QBNA2	Reinforced 57A364-TB25N	Non-Reinforced 57A60-M8B
Bates	A602-T-BF	A36-R-BF	-
Buffalo	A60-R-BF2	-	-
Dia. Tool	A80-SP	A46-SP	-
Radiac	A54-N6-B20	-	A54-N6-B20
Tyrolit	A60-QBF38A2	-	-

TECH TIP

- Smooth side pattern – Used when a precise thickness tolerance is needed
- Rough (R) side pattern – Abrasive particles protrude from sides of wheel

Troubleshooting Guide

PROBLEM	POSSIBLE CAUSES	SUGGESTED CORRECTION
Poor cut rate	Insufficient power used	Increase feed or pressure to full power
	Wheel too hard	Use softer grade, or thinner wheel
	Contact area too large	Reduce contact area
	Wheel too coarse	Use finer grit
	Wheel side out of truth	Check spindle runout
Non-square cuts	Work not clamped properly	Check clamp and clean to remove swarf
	Misaligned spindle bearings	Check for bearing truth and alignment
	Poor coolant distribution	Ensure equal volume of coolant to each wheel side
	Wheel is too hard	Use softer acting wheel: softer grade, or finer grit
Workpiece burn	Insufficient feed rate	Work machine to maximum power available
	Poor coolant flow	Increase volume and direct at cutting point
	Wheel is too coarse	Use finer grit or more machine power
	Wheel is too hard	Use softer grade wheel
	Wheel is running out	Check spindle and flanges
	Wheel speed is too slow	Ensure tight flanges and maximum safe operating speed being used
Poor finish	Too much burr	Use finer grit, or softer grade
	Wheel too coarse	Use finer grit

TECH TIP

- Wheels with a "W" reinforcement (reinforcement around the hole) are not considered to be truly reinforced.
- Clamp or fixture the workpiece for straightest cuts.
- Run wheels at the highest possible speed marked on the wheel and make cuts as quickly as possible. Do not overspeed wheels.
- It is recommended that a cut-off machine should have 1 horsepower for every inch of wheel diameter. For less than this, we recommend using a softer specification.
- Using a harder grade wheel increases wheel life, but it also increases burn, power required and decreases cut rate.
- Using a coarser grit wheel increases wheel life and cut rate, but it also increases burr and power required.

Better choice for cutting tool steel on fixed-based machines when work is not securely clamped



TOOLROOM REINFORCED ALUMINUM OXIDE

- Tough, versatile aluminum oxide grain for toolroom cut-off applications
- Constructed with full diameter fiberglass reinforcement on each side of wheel, to provide greatest possible resistance to side pressure and bending
- OBNA2 full side reinforced, resin bond; yields maximum cut rate and minimum kerf loss; ideal when thin cut is desired
- B25N full side reinforced, resin bond; versatile; durable, free cutting; offer greatest stiffness

SIZE (D x T x H)	MAX. RPM	STD. PKG.	TIER: BETTER	PART #
			SPEC.	
Type O1/41 Straight Cut-off – Reinforced				
6 x .035 x 1/2	10,190	25	A60-OBNA2	662528 35053
6 x .035 x 1-1/4	10,190	25	A60-OBNA2	662528 35055
6 x .060 x 1/2	10,190	25	A60-OBNA2	662528 35164
6 x .060 x 1/2	10,190	25	57A364-TB25N	662528 22969
6 x .060 x 1-1/4	10,190	25	A60-OBNA2	662528 35165
7 x .035 x 1/2	8,730	25	A60-OBNA2	662529 38786
7 x .035 x 1-1/4	8,730	25	A60-OBNA2	662529 38788
7 x .060 x 1/2	8,730	25	A60-OBNA2	662529 38816
7 x .060 x 1-1/4	8,730	25	A60-OBNA2	662529 38796
7 x .060 x 1-1/4	8,730	25	57A364-TB25N	662529 22676

SIZE (D x T x H)	MAX. RPM	STD. PKG.	TIER: BETTER	PART #
			SPEC.	
Type O1/41 Straight Cut-off – Reinforced				
8 x .035 x 1/2	7,640	25	A60-OBNA2	662530 43014
8 x .035 x 1-1/4	7,640	25	A60-OBNA2	662530 42980
8 x .060 x 1/2	7,640	25	A60-OBNA2	662530 43009
8 x .060 x 1-1/4	7,640	25	A60-OBNA2	662530 42983
8 x .060 x 1-1/4	7,640	25	57A364-TB25N	662530 22705
10 x .060 x 5/8	6,110	25	A60-OBNA2	662531 49317
10 x .060 x 1-1/4	6,110	25	A60-OBNA2	662531 49186
12 x .060 x 1	5,095	10	A60-OBNA2	662532 61811
12 x .075 x 1	5,095	10	A60-OBNA2	662532 61910
12 x .075 x 1-1/4	5,095	10	A60-OBNA2	662532 61858

Better choice for cutting tool steel on fixed-based machines when the work is securely clamped



TOOLROOM NON-REINFORCED ALUMINUM OXIDE

- Tough, durable and versatile aluminum oxide grain for toolroom cut-off applications
- Non-reinforced, use on fixed-based machines where the work is securely clamped
- B bond (smooth sides); a mild acting resin bond for light cut-off applications
- B25 bond (smooth sides); a versatile, free-cutting, more durable resin bond; ideal for dry cutting metal in high production runs
- E7 bond (smooth sides); a shellac bond with very mild cutting action, recommended for highly critical applications where no burr, heat checks, or discoloration is permitted
- R30 bond (smooth sides); mild acting rubber bond primarily for wet, ultra-thin cutting

SIZE (D x T x H)	MAX. RPM	STD. PKG.	TIER: BETTER	PART #
			SPEC.	
Type O1/41 Straight Cut-off – Non-Reinforced				
6 x .015 x 1-1/4	6,370	25	57A90-ROR30	662528 22953
6 x .020 x 1-1/4	6,370	25	57A90-ROR30	662528 22954
6 x .035 x 1-1/4	6,370	25	57A60-M8B	662528 22958
6 x .060 x 1/2	7,640	25	57A541-RB25	662528 22970
6 x .060 x 1-1/4	7,640	25	57A60-M8B	662528 22975
7 x .035 x 1-1/4	5,460	25	57A60-M8B	662529 22983
			57A60-O8B	662529 22986
			57A60-Q8B	662529 22987
7 x .035 x 1-1/4	5,460	25	57A601-PB25	662529 22988
			57A601-RB25	662529 22989
7 x .035 x 1-1/4	5,185	25	57A60-OE7	662529 22985
			23A601-PB25	662529 38701
7 x .050 x 1-1/4	5,460	25	23A601-PB25	662529 38724*
7 x .060 x 1/2	6,550	25	57A60-O8B	662529 22672

*Exception: rough sides

SIZE (D x T x H)	MAX. RPM	STD. PKG.	TIER: BETTER	PART #
			SPEC.	
Type O1/41 Straight Cut-off – Non-Reinforced				
7 x .060 x 1-1/4	6,550	25	57A46-M8B	662529 22677
			57A60-M8B	662529 22681
			57A60-O8B	662529 22684
			57A60-OE7	662529 22683
7 x .090 x 1-1/4	6,550	25	57A60-M8B	662529 22690
7 x .125 x 1-1/4	6,550	25	57A60-M8B	662529 22692
8 x .035 x 1-1/4	4,775	25	57A60-N8B	662530 22694
8 x .060 x 1/2	5,730	25	57A60-M8B	662530 22702
8 x .060 x 1-1/4	5,730	25	57A60-M8B	662530 22708
8 x .060 x 1-1/4	4,540	25	57A60-OE7	662530 22709
10 x .060 x 5/8	4,585	25	57A46-Q8BW	662531 22816
			57A60-M8BW	662531 22818
10 x .090 x 5/8	4,585	25	57A60-M8BW	662531 22824

Metallurgical Non-Reinforced Cut-off



The Norton metallurgical line of Type 01/41 straight cut-off wheels was developed specifically for sectioning off metal samples; burr-free cutting, minimal burn and distortion.

Applications:

Designed specifically for cutting off metal samples ranging from mild steel to super alloys on fixed-based machinery by scientists, engineers, and lab technicians.

Size range:

9" – 13.75" diameter

Cross Reference Guide

SIZE	MATERIAL CUT	NORTON		BUEHLER		LECO		STRUERS	
		SPEC.	PART #	METABRASE PART #	BUEHLERMET II PART #	PART #	PART #	PART #	AXITOM/-5 PART #
9 x .063 x 1-1/4 (229mm x 1.6mm x 32mm)	Very Hard Steels (Rc 55 - 68)	ML-109	662531 17874	10-4110-010					60A24*
	Medium Steels (Rc 30 - 40)	ML-309	662531 17877	10-4116-010	10-5112-010	811-043-010			40A24*
	Soft Steels (Rc 20 - 30)	ML-409	662531 17828	10-4120-010	10-5116-010	811-049-010			30A24*
10 x .063 x 1-1/4 (254mm x 1.6mm x 32mm)	Very Hard Steels (Rc 55 - 68)	ML-110	662531 17879	10-4210-010		808-673	812-231		60A25•
	Hard Steels (Rc 40 - 55)	ML-210	662531 17880	10-4212-010	10-5210-010	811-059-010	810-310-010		54A25•
	Medium Steels (Rc 30 - 40)	ML-310	662531 17881	10-4216-010	10-5212-010	811-067-010	810-310-010		40A25•
	Soft Steels (Rc 20 - 30)	ML-410	662531 17830	10-4220-010	10-5216-010	811-073-010			30A25•
12 x .078 x 1-1/4 (305mm x 2.0mm x 32mm)	Very Hard Steels (Rc 55 - 68)	ML-112	662533 22151	10-4410-010		808-674	811-065-010		60A30†
	Hard Steels (Rc 40 - 55)	ML-212	662533 22152	10-4412-010	10-5410-010	811-081-010	810-311-010		50A30†
13.75 x .098 x 1-1/4 (350mm x 2.5mm x 32mm)	Very Hard Steels (Rc 55 - 68)	ML-114	662533 22863	10-4310-010		808-675	812-232		60A35▲ 50A35
	Hard Steels (Rc 40 - 55)	ML-214	662533 22156	10-4312-010	10-5310-010	809-346	811-977-010		50A35▲ 40A35

*Discotom/Labotom • Discotom-5/-6/Labotom-3 †Unitom/Discotom-50/-60/-65 ▲ Exotom/Unitom-2/-5/-50

Best choice for wet use when you want burn-free cuts and ultra-clean samples



METLAB 38A ALUMINUM OXIDE

- Quality aluminum oxide abrasive wheel designed specifically for burr-free cutting of soft carbon steels, tool steels, super alloys for microscopic metal analysis
- Superior bond system generates pure cuts for sectioning off samples while minimizing wheel wear and odor
- Designed to work on Buehler®, LECO® and Struers® machinery

SIZE (D x T x H)	MAX. RPM	STD. PKG.	PRODUCT #	APPLICATION	TIER: BEST
					PART #
Type 01/41 Straight Cut-off – Non-Reinforced					
9 x .063 x 1-1/4 (229mm x 1.6mm x 32mm)	4,025	10	ML-109	Very Hard Steels (Rc 55 - 68)	662531 17874
	4,025	10	ML-309	Medium Steels (Rc 30 - 40)	662531 17877
	5,085	10	ML-409	Soft Steels (Rc 20 - 30)	662531 17828
10 x .063 x 1-1/4 (254mm x 1.6mm x 32mm)	3,500	10	ML-110	Very Hard Steels (Rc 55 - 68)	662531 17879
	3,500	10	ML-210	Hard Steels (Rc 40 - 55)	662531 17880
	3,500	10	ML-310	Medium Steels (Rc 30 - 40)	662531 17881
	4,585	10	ML-410	Soft Steels (Rc 20 - 30)	662531 17830
12 x .078 x 1-1/4 (305mm x 2.0mm x 32mm)	3,820	10	ML-112	Very Hard Steels (Rc 55 - 68)	662533 22151
	3,820	10	ML-212	Hard Steels (Rc 40 - 55)	662533 22152
13.75 x .098 x 1-1/4 (350mm x 2.5mm x 32mm)	2,770	10	ML-114	Very Hard Steels (Rc 55 - 68)	662533 22863
	2,770	10	ML-214	Hard Steels (Rc 40 - 55)	662533 22156

TIER: BETTER				
SIZE (D x T x H)	MAX. RPM	STD. PKG.	SPEC.	PART #
Type 01/41 Straight Cut-off – Non-Reinforced				
10 x 1/16 x 1-1/4	4,585	5	88A901-HB82 Metlab	662531 49449
12 x 1/16 x 1-1/4	3,820	5	88A901-HB82 Metlab	662532 62172



The Norton RailCut line is designed for high-speed fixtured hydraulic or gas-powered rail saws.

- Applications:** Fixed rail track cutting
- Size range:** 14" and 16" diameter
- Thickness range:** 1/8"
- Grit range:** 14 – 16
- Abrasive grain:** Zirconia Alumina / Aluminum Oxide Blend, Zirconia Alumina, and Aluminum Oxide
- Shape:** Type 01/41 Straight
- Reinforcement:** Side reinforced with R (rough) sides
- Speed rating:** All wheels are rated for 20,000 SFPM applications
- Machines Used:**



FIXTURED HYDRAULIC OR
GAS-POWERED RAIL SAW

Cross Reference Guide and Machine-to-Product Recommendation Guide

NORTON	BEST	BETTER	GOOD	GOOD
	RailCut X	RailCut NorZon III	RailCut A30X	RailCut Metal
Bullard Abrasive	Trackmaster Pro ZA24 Q-BF (Blue)	Trackmaster Pro ZA24 Q-BF (Blue)	Trackmaster A30 R-BF (Red)	—
DiaTool	—	—	—	RailMaster Rail Cut 27
Flexovit USA	—	—	A30-PB	—
Giesmar	AM303-R	AM303-R	NR242-Q	NR242-Q
Klingspor	A 24 SX Special	A 24 SX Special	—	—
Portaco	A30 R-BF	A30 R-BF	—	—
Racine Kwik Kut	A24R	A24R	—	—

	BEST	BETTER	GOOD	GOOD
	RailCut X	RailCut NorZon III	RailCut NorZon III FastCut	RailCut A30X
HYDRAULIC SAW	◆	—	—	◆
GAS SAW	—	—	—	—
High-Horsepower / Newer Machine	◆	◆	—	◆
Low-Horsepower / Older Machine	◆	◆	◆	◆



Best choice for high-performance cutting of rails on applications where the hydraulic or gas saw is fixtured and has adequate power

RAILCUT X ZIRCONIA ALUMINA / A/O BLEND

- Highest-performance zirconia alumina and engineered aluminum oxide abrasive blend expertly cuts a broad range of rail material
- Rough sides enable fastest cutting and longest lasting wheels
- Achieve highest productivity with lowest total abrasive costs



Good choice for price-sensitive jobs with lowest initial price

RAILCUT METAL ALUMINUM OXIDE

- Quality aluminum oxide abrasive wheels designed for jobs where low initial price is a key purchasing criterion
- Side reinforced with rough sides; rated for 20,000 SFPM applications
- Designed for multi-purpose use; great versatility on a variety of rail materials



SIZE (D x T x H)	MAX. RPM	STD. PKG.	TIER: BEST	BETTER	BETTER	GOOD	GOOD
			TRADENAME: RAILCUT X	RAILCUT NORZON III	RAILCUT NORZON III FASTCUT	RAILCUT A30X	RAILCUT METAL
ABRASIVE:			Zirconia Alumina/ Aluminum Oxide Blend	Zirconia Alumina	Zirconia Alumina	Aluminum Oxide	Aluminum Oxide
TYPE 01/41 Cut-Off			PART #	PART #	PART #	PART #	PART #
14 x 1/8 x 1	5,400	10	662533 37716	662533 60493	662533 63694	662532 60462	662434 82068
16 x 1/8 x 1	4,800	10	662533 35024	662534 64607	662534 64415	662532 59935	662434 82066



Foundry cut-off wheels are designed with abrasives, bonds and reinforcement types specific to foundry machine parameters and materials. Most of the specifications are non-stock. This stock listing is designed to provide popular size and starting specifications.

- Size Range:** Reinforced: 14" – 30" diameter; Non-reinforced: 12" – 20" diameter
- Grit Range:** 24 – 46 grit
- Abrasive Grain:** Ceramic Alumina (Norton Quantum; non-stock only), Zirconia Alumina, Aluminum Oxide
- Reinforcement:** Reinforced: Engineered with strengthening fabric or filaments, which make wheels resistant to cross-bending breakage. All portable cut-off, swingframe, locked-head push-through and foundry chop stroke operations require reinforced cut-off wheels.
- B:** One or more full diameter pieces of filament molded inside each wheel. This construction leaves the abrasive exposed on the side of the wheel, improving freeness of cut. Used for fixed work operations with low probability of side pressure.
- N:** Full diameter pieces of reinforcement on the side of the wheel. Offers greatest possible resistance to side pressure and bending.
- Non-Reinforced:** Designed for use on fixed-base types of machines where the work is securely clamped and guarded, and where the wheel operates on a controlled cutting plane.
- W:** Reinforcement around the center hole only. These wheels are not considered to be truly reinforced.
- Side Patterns:** Smooth sides: Used for precision cutting applications
 Rough (R) sides: Abrasive particles protrude from sides of wheel
 Used wet or dry on most metals

Material-to-Product Recommendation Guide

	BEST	BETTER	GOOD	GOOD
	Foundry X Quantum*	Foundry X BlueFire	Foundry X	Foundry Metal
INVESTMENT CAST ALLOYS				
Stainless Steel	◆	◆	◆	◆
Titanium	◆	◆	◆	◆
CAST IRON				
	◆	◆	◆	◆
CAST STEEL				
Carbon and Low Alloy	◆	◆	◆	◆
Stainless Steel and High Alloy	◆	◆	◆	◆
Aluminum Alloy	◆	◆	◆	◆
Copper Alloys, Brass, Bronze	◆	◆	◆	◆

*Foundry X Quantum wheels are non-stock, custom-made to your requirements

Cross Reference Guide

	TOTAL PERFORMANCE ←		→ INITIAL PRICE	
	BEST	BETTER	GOOD	GOOD
NORTON	Foundry X Quantum and B97 (Non-stock; custom-made to your exact requirements)	Foundry X BlueFire	Foundry X	Foundry Metal
Allison	TA362 R6 8045HA, YW462 MR B2HA	TA302-T6-B6HA, A46-T6-BX5T6A, HF 1247 K – CHALLENGER	—	Economiser
Avery	—	TA30-V680	A 3226 C7A, C11922 W071	92871H
Buckeye	—	Steel Shark	—	—
DiaTool	BV1734R 710	BV 1397-5284-C	—	—
Flexovit	—	ZAX30TB	A24PB, A30RB	—
Klingspor	20A24-QBF	—	—	—
NATAB	—	—	T 1584 HA	—
Rappold	—	6Z30U-B3F2	—	—

Better choice on stainless steel, aerospace alloys, cast iron, and steel



FOUNDRY X BLUEFIRE REINFORCED

- Next generation self-sharpening zirconia alumina abrasive provides fast cuts on foundry cut-off applications
- Improved durability and heat resistance result in longer abrasive life
- More aggressive; can withstand very demanding applications



Good choice on general purpose applications

FOUNDRY X ALUMINUM OXIDE

- Durable, versatile aluminum oxide abrasive engineered for consistent performance and economical price on foundry cut-off applications
- Advanced bond technology with improved thermal stability and mechanical strength
- Excellent value on stainless steel and exotic aerospace alloys



Good choice for price-sensitive jobs with lowest initial price

FOUNDRY METAL ALUMINUM OXIDE

- Great versatility from multi-purpose aluminum oxide abrasive formulated specifically for typical foundry applications
- Bond and reinforcement engineered to foundry market machine parameters and materials
- Good choice for small jobs and quick applications where performance is not measured

Reinforced



TIER:	BETTER	GOOD	GOOD
TRADENAME:	FOUNDRY X BLUEFIRE	FOUNDRY X	FOUNDRY METAL
ABRASIVE:	Zirconia Alumina / Aluminum Oxide	Aluminum Oxide	Aluminum Oxide

SIZE (D x T x H)	MAX. RPM	STD. PKG.	SPEC.	PART #	SPEC.	PART #	SPEC.	PART #
Type 01/41 Straight Cut-off – Foundry Reinforced								
14 x 1/8 x 1	4,365	10	NV24-TB75N	662533 47674	U57A30-TB75N	662533 45779	Side Reinforced	662434 85918
	4,365	10	NV24-VB75N	662531 79193	U57A30-VB75N	662531 79191		
	4,365	10	NV24-YB97N	662533 47698				
16 x 5/32 x 1	3,820	10	NV24-TB75N	662533 47676	U57A30-TB75N	662533 45781	Side Reinforced	662434 85919
	3,820	10	NV24-VB75N	662531 79147	U57A30-VB75N	662531 79148		
	3,820	10	NV24-YB97N	662533 47693				
20 x 5/32 x 1	2,710	10	NV24-TB75N	662533 47683	U57A30-TB75N	662533 47546	Side Reinforced	662434 85920
	2,710	10	NV24-VB75N	662531 79363	U57A30-VB75N	662531 79364		
	2,710	10	NV24-YB97N	662533 47694	U57A30-YB97N	662533 47701		
20 x 3/16 x 1	2,710	10	NV24-TB75B	662533 47684	U57A30-TB75B	662533 47547	Centrally Reinforced	662434 85921
	2,710	10	NV24-VB75B	662531 79366	U57A30-VB75B	662531 79367		
	2,710	10	NV24-YB97B	662533 47699	U57A30-YB97B	662533 47702		
24 x 7/32 x 1-3/4	2,260	10	NV24-TB75B	662533 47685				
	2,260	10	NV24-VB75B	662531 79374	U57A30-VB75B	662531 79375		
	2,260	10	NV24-YB97B	662533 47697				
30 x 1/4 x 1-3/4	1,810	10	NV24-TB75B	662533 47722	U57A30-TB75B	662533 47720		
	1,810	10	NV24-YB97B	662533 47723	U57A30-YB97B	662533 47721		

Specifications ending in "B" are centrally reinforced; specifications ending in "N" are side reinforced.

Non-Reinforced



TIER:	BETTER	GOOD
TRADENAME:	U57A	GEMINI
ABRASIVE:	Aluminum Oxide	Aluminum Oxide

SIZE (D x T x H)	MAX. RPM	STD. PKG.	SPEC.	PART #	SPEC.	PART #
Type 01/41 Straight Cut-off – Foundry Non-Reinforced R-Sides						
12 x 3/32 x 1	5,095	10	U57A461-PB25	662532 61887		
16 x 1/8 x 1	3,820	10			AP	662534 22942
20 x 1/8 x 1	2,710	10	U57A304-VB25W	690786 65497		

Ask your Norton representative about our custom, made-to-order Norton Foundry X Quantum ceramic alumina wheels for high alloys, stainless steel, and aerospace applications.

CUT-OFF WHEEL DESCRIPTION CODES

AP = All Purpose

Where a good blend of cut rate and life is needed



For consistent, quality performance in foundries, welding shops, fabrication facilities, steel mills and shipyards, Norton portable snagging wheels maximize your productivity. Used on horizontal/straight shaft grinders or right angle portable cup grinders.

- Applications:** Removing flaws, cracks, gates, risers and parting lines, smoothing weld seams, cleaning castings, and rough beveling
- Size Range:** Type 01 Straight Wheels: 2-1/2" – 8" diameter
Type 06 and 11 Cup Wheels: 4" – 6" diameter
Cones and Plugs: Type 16, 17, 17R, 18 and 18R
- Grit Range:** 14 – 24
- Abrasive Types:** Zirconia Alumina NZ and NV; Zirconia Alumina / Silicon Carbide Blend NVC; Aluminum Oxide 57A and Metal; Aluminum Oxide / Silicon Carbide Blend 57AC, Silicon Carbide 37C and Masonry

Machine Used:



Material-To-Product Recommendation Guide

	BEST	BETTER	GOOD	
	NorZon Plus	BlueFire	Gemini	Metal
IRON				
Gray	◆ NZ14-R	◆ NV16-Q	◆ 57A16-Q	◆
Ductile/Malleable	◆ NZ14-R	◆ NV16-Q	◆ 57A16-Q	◆
Dirty/Scale-covered		◆ NVC16-Q	◆ 57AC16-Q	
STEEL				
Carbon and Low Alloy	◆ NZ14-Q	◆	◆ 57A16-Q	◆
Stainless and High Alloy	◆ NZ14-P	◆	◆ 57A16-Q	◆
ALUMINUM, COPPER, BRASS, & BRONZE ALLOYS		◆ NVC16-Q	◆ 57AC16-Q	

NOTE: Grade, Grit and Abrasive tuning may be necessary to obtain optimum performance

Cross Reference Guide for Type 01, 06 and 11 Wheels

NORTON	TOTAL PERFORMANCE ←			→ INITIAL PRICE	
	BEST	BETTER	GOOD		
Brilliant	—	ZA16QB	A16QB	—	C16QB
Bullard	—	ZA16PB	A16R	AC16	C16P
Camel	—	—	A	CA	C
Flexovit	ZA16PB	—	A16QB	AC16QB	C16PB
Gulf States	Zirconium	—	A16	—	C16
Pacific	Z, Z-GPC	—	A	CA	—
Pearl	—	—	A16Q	—	C16-Q
Pferd	ZA 16 Q SG	—	A 16 Q SG	—	C 16 Q SG
Sait	—	Z16	A16, 20	CA16	C16
Tyrolit	—	—	A16PB	—	C16PB
Walter	—	—	A	—	C

Best choice for heavy-duty stock removal on medium- and high-horsepower grinders



NORZON PLUS ZIRCONIA ALUMINA

- Tough, durable, premium zirconia alumina grain provides 10X life and 50% faster grinding versus aluminum oxide products
- Engineered to excel on the toughest foundry snagging applications
- Best performance on a wide variety of materials; 300 and 400 series stainless, soft and hard carbon steels, tool steels, titanium, super alloys, soft metals, and cast, ductile and gray iron

Better choice for stock removal on high- and medium-horsepower grinders



BLUEFIRE ZIRCONIA ALUMINA

- Friable zirconia alumina grain and durable resin bond technologies deliver sharper grain longer, for extended wheel life, higher metal removal rates, and faster, freer cutting action than standard zirconia alumina blends
- Ideal for foundry snagging, tool sharpening, portable grinding and stock removal applications on high- and medium-horsepower grinders
- Strong operator preference for these smooth-acting wheels that require less pressure and exertion, while improving productivity
- NVC – zirconia alumina / silicon carbide blend is highly effective on dirty, scale-covered castings
- Available with low odor bond to help reduce odors associated with portable grinding when used in confined spaces

Good choice for steel and ferrous metals as well as specialty applications in aluminum and foundries



GEMINI ALUMINUM OXIDE

- Tough, durable aluminum oxide abrasive for heavy-duty work including foundry snagging, tool sharpening, and stock removal
- Work well with a variety of machines, horsepower, and operations
- Good general-purpose choice for numerous small jobs
- Available with low odor bond to help reduce odors associated with portable grinding when used in confined spaces

Good choice for steel/ferrous metal applications with low initial price



METAL ALUMINUM OXIDE

- Tough, durable aluminum oxide abrasive for heavy-duty work including foundry snagging, tool sharpening, and stock removal
- Work well with a variety of machines, horsepower, and operations
- Good general-purpose choice for numerous small jobs on 300 and 400 series stainless, soft and hard carbon steels, tool steels, titanium, super alloys, soft metals, and cast, ductile and gray iron

Good choice for masonry applications with low initial price



MASONRY ALUMINUM OXIDE

- Sharp silicon carbide abrasive for small-volume snagging jobs
- Delivers rapid stock removal in small areas on a portable cup grinder
- Versatile; good starting specification where initial price is a primary purchasing consideration, especially nonferrous and masonry



TIER:	BEST	BETTER	GOOD	GOOD
TRADENAME:	NORZON PLUS	BLUEFIRE	GEMINI	METAL/MASONRY
SHAPE:	Type 01 and 11	Type 01, 06, and 11	Type 01 and 11	Type 11
ABRASIVE:	Premium Zirconia Alumina	Zirconia Alumina NV Zirconia Alumina/ Silicon Carbide NVC	Aluminum Oxide 57A, Silicon Carbide 37C, Aluminum Oxide/ Silicon Carbide 57AC	Metal – Aluminum Oxide Masonry – Silicon Carbide

SIZE (D x T x H)	MAX. RPM	STD. PKG.	SPEC	PART #	SPEC	PART #	SPEC	PART #	SPEC	PART #
Type 01 Straight										
2-1/2 x 1/2 x 3/8	21,700	20					57A24-R	662435 22381		
3 x 1/4 x 3/8	20,370	25			NV20-T	662533 43872*	57A24-T	662435 28831		
3 x 3/8 x 3/8	18,080	10					57A24-R	662435 22415		
3 x 1/2 x 3/8	18,080	10					57A24-P	662435 22417		
4 x 1/4 x 3/8	15,280	10			NV20-T	662533 44098	57A24-R	662435 22221		
6 x 1 x 5/8	8,000	5			NV14-R	662531 98589	57A16-QS	662528 09563		
S Webs	8,000	5			NZ III 14-Q	662528 38075				
	8,000	5			NZ III 14-R	662528 37961				
8 x 3/4 x 5/8	6,000	10			NV14-S	662533 44347				
S Webs										
8 x 1 x 5/8	6,000	5	NZ IV 16-Q	662530 30778	NV16-Q	662531 98590				
S Webs	6,000	5	NZ IV 16-Q	662530 44532						
	6,000	10			NV14-R	662533 44355				
	6,000	10			NV14-T	662533 44365				
	6,000	10			NVC16-Q	662531 98592				
Type 06 Straight Cup										
6 x 2 x 5/8-11	6,000	5			NZ III 16-R	662528 38577				
Rim 2" Back 3/4"										
Type 11 Flaring Cup										
4/3 x 2 x 5/8-11	9,070	10	NZ IV 16-Q	662435 30761	NV16-Q	662531 98583	57A16-Q	662435 10512	Masonry C16-Q	076607 89431
Rim 3/4" Back 3/4"										
5/3-3/4 x 2 x 5/8-11	7,260	5			NV16-Q	662531 46918	57A16-Q	662528 09598	Metal 16-Q	076607 89430
Rim 1" Back 3/4"	7,260	5			4NZ16-Q RB	690786 40233	57AC16-Q RB	690786 40234		
6/4-3/4 x 2 x 5/8-11	6,000	5			NV16-Q	662531 46925	57A16-Q	662528 25201		
Rim 1" Back 3/4"	6,000	5			NZ III 16-Q	662528 38568				
6/4-3/4 x 2 x 5/8-11	6,000	5	NZ IV 16-P	662528 30765	NV14-R	662533 44371	37C16-P	662528 09609		
Rim 1-1/2" Back 3/4"	6,000	5			NV16-Q	662531 98584	57A16-Q	662528 09618		
	6,000	5			NVC16-Q	662531 46922	57AC16-Q	662528 09608		
	6,000	5			4NZ16-Q RB	690786 40484	9CA16-Q RB Ti	690786 40488		
							57AC16-Q RB	690786 40485		
Type 11 Flaring Cup with Steel Back										
4/3 x 2 x 5/8-11	9,070	10			NV16-Q	662531 46917				
Rim 3/4" Back 3/4"										
5/3-13/16 x 2 x 5/8-11	7,260	10			NV16-Q	662531 46920				
Rim 1" Back 3/4"										
6/4-13/16 x 2 x 5/8-11	6,000	5			NV14-R	662533 44373	57A16-Q	662528 09599		
Rim 1-1/2" Back 3/4"	6,000	5			NV16-Q	662531 98586	57AC16-Q	662528 09600		
	6,000	5			NVC16-Q	662531 46929	57AC16-Q RB	690786 40486		
	6,000	5			4NZ16-Q RB	690786 40487	9CA16-Q RB Ti	690786 40489		

* Std. Pkg. = 50

RB = Low odor bond. Note: Ti formulation optimized for grinding Titanium

TECH TIP

Norton BlueFire and Gemini Type 11 cup wheels now available in new RB low odor bond to help reduce odors associated with portable grinding when used in confined spaces.



TIER:	BEST	BETTER	GOOD	GOOD
TRADENAME:	NORZON PLUS	BLUEFIRE	GEMINI	METAL
ABRASIVE:	Zirconia Alumina	Zirconia Alumina/Aluminum Oxide	Aluminum Oxide	Aluminum Oxide

SIZE (D x T x H)	MAX. RPM	STD. PKG.	SPEC	PART #	SPEC	PART #	SPEC	PART #	SPEC	PART #
Type 16 Cones										
1 x 3 x 3/8-24 (ME 107019)	36,290	10			NV20-S	662533 44376	57A24-R	614636 22342	Metal 24	662533 49752
1-1/2 x 2-1/2 x 3/8-24 (ME 44436)	24,190	10					57A24-R	614636 22349	Metal 24	662533 49754
1-1/2 x 2-1/2 x 5/8-11 ME 171651	24,190	10					57A24-R	690786 40166	Metal 20	690786 40046
1-1/2 x 3 x 3/8-24 (ME 139029)	24,190	10			NV20-S	662533 44377				
1-1/2 x 3 x 3/8-24 (ME 171652)	24,190	10							Metal 20	690786 40215
1-1/2 x 3 x 5/8-11 (ME 70535)	24,190	10	NZ IV 20-R	614636 44231	NV20-S	662533 44379	57A24-R	614636 22190	Metal 24	662533 49757
1-3/4 x 3 x 3/8-24 (ME49226)	20,735	10					57A24-R	614636 14503	Metal 24	662533 49840
1-3/4 x 3 x 5/8-11 (ME 33432)	20,740	10					57A24-R	614636 22195	Metal 24	662533 49841
2 x 3 x 3/8-24 ME 157287	18,145	10							Metal 24	662534 76413
2 x 3 x 5/8-11 (ME 28229)	18,145	10	NZ IV 20-R	614636 44232	NV20-S	662533 44381	57A24-R	614636 22218	Metal 24	662533 49846
2-3/4 x 3-1/2 x 5/8-11 (ME 18265)	13,195	10			NV20-S	662533 44383	57A24-R	614636 22387	Metal 24	662533 49855
3 x 3 x 5/8-11 (ME70537)	12,100	10							Metal 24	662434 96885
Type 17 Cones, Square Tip										
1-1/2 / 1/2 x 3 x 3/8-24	24,190	10					57A24-R	614636 22194	Metal 24	662533 49753
1-1/2 / 1/2 x 3 x 5/8-11	24,190	10					57A24-R	690786 40225	Metal 20	690786 40224
2 / 1/2 x 3 x 5/8-11	18,145	10					57A24-R	614636 15722	Metal 24	662533 49845
Type 17R Cones, Round Tip										
2 / 3/4 x 3 x 5/8-11 (ME 151373)	18,145	10			NV20-S	662533 44384				
Type 18 Plugs, Square Tip										
1-1/2 x 2-1/2 x 3/8-24	24,190	10					57A24-R	614636 22217	Metal 24	662533 49755
	24,190	1 V					57A24-R	662533 25902		
1-1/2 x 2-1/2 x 5/8-11	24,190	10	NZ IV 20-R	614636 44224	NV20-S	662533 44385	57A24-R	614636 22351	Metal 20	690786 40226
	24,190	1 V					57A24-R	662533 25905		
1-1/2 x 3 x 5/8-11	24,190	10			NV20-S	662533 44386	57A24-R	614636 22191	Metal 24	662533 49838
	24,190	1 V					57A24-R	662533 25909		
2 x 3 x 5/8-11	18,145	10	NZ IV 20-R	614636 44234	NV20-S	662533 44387	57A24-R	614636 22219	Metal 24	662533 49847
	18,145	10					NV24-S	662533 44391		
2 x 4 x 5/8-11	18,145	10					57A24-R	614636 22366	Metal 24	662533 49850
Type 18R Plugs, Round Tip										
1-1/2 x 2-1/2 x 3/8-24	24,190	10					57A24-R	690786 40230	Metal 20	690786 40229
1-1/2 x 2-1/2 x 5/8-11	24,190	10					57A24-R	690786 40228	Metal 20	690786 40227
1-1/2 x 3 x 3/8-24	24,190	10					57A24-R	614636 22192	Metal 24	662533 49756
1-1/2 x 3 x 5/8-11	24,190	10							Metal 24	662434 95628
2 x 3 x 5/8-11	18,145	10			NV20-S	662533 44389	57A24-R	614636 22220	Metal 24	662533 49849
3 x 3 x 3/8-24	12,095	10					57A24-R	690786 40232		
3 x 3 x 5/8-11	12,095	10							Metal 20	690786 40231

V = Vendible Package. Ideal for vending machines and small jobs.

Core Files

These files consist of coarse grit silicon carbide abrasive in a hard grade, resin-bonded to a reinforcing rod. Half-round in shape, they are a frequent choice for easy cleaning of rough castings.



TIER: **GOOD**
ABRASIVE: Silicon Carbide

SIZE (T x W x L)	STD. PKG.	SPEC.	PART #
Stock Resinoid Core Files – Silicon Carbide			
1/2 x 1 x 10	5	37C24-SB	614636 10314

Floorstand and Swingframe Snagging



Norton snagging wheels maximize your productivity in foundries, welding shops, fabrication facilities, steel mills, and ship yards.

- Applications:** Removing unwanted metal on castings, removing flaws and cracks, removing gates, risers and parting lines
- Size Range:** 24" and 30" diameters in stock; other diameters available as made-to-order
- Abrasive Grain:** Zirconia Alumina, Zirconia Alumina/Silicon Carbide blend, Aluminum Oxide
- Shape:** Type 01 Straight
- Reinforcement:** Strong fiberglass webbing and steel rings for maximum strength

Floorstand Snagging Wheel Material-to-Product Recommendation Guide

	BEST					BETTER		GOOD
	4ZF1434-R5B38S	4ZF1434-Q5B38S	4NZ1434-R5B38S	4NZ1434-Q5B38S	ZI/25-R	ZI/26-Q	Charger	Gemini All Purpose
IRON								
Gray	◆				◆	◆	◆ Long Life	◆
Ductile/Malleable		◆			◆	◆	◆ Long Life	◆
STEEL								
Carbon and Low Alloy			◆				◆ Free Cut	◆
Stainless and High Alloy				◆			◆ Free Cut	◆

Note: Grade, Grit and Abrasive tuning may be necessary to obtain optimum performance

Swingframe Snagging Wheel Material-to-Product Recommendation Guide

	BEST				GOOD	
	4ZF1234-R5B38S	4ZF1434-R5B38S	NZC142-R5B38S	ZI/25-R	ZI/26-Q	Gemini All Purpose
IRON						
Gray		◆			◆	◆
Ductile/Malleable		◆			◆	◆
STEEL						
Carbon and Low Alloy			◆			◆
Stainless and High Alloy						◆
ALUMINUM ALLOY						
COPPER ALLOYS / BRASS / BRONZE						

Note: Grade, Grit and Abrasive tuning may be necessary to obtain optimum performance

Troubleshooting Guide

PROBLEM	POSSIBLE CAUSES	SUGGESTED CORRECTION
Poor stock removal	Insufficient pressure applied	Increase pressure to use all available power
	Wheel too coarse or hard	Use finer grit and/or softer grade wheel
	Inadequate abrasive	Try NorZon, 4ZF, or ZI/25 specification
Grinding costs too high	Wheel acting too soft	Use harder and/or coarser wheel
	Low performance specification	Try NorZon or ZI products
Wheel loading or glazing	Grade too hard	Try softer grade
	Grit too coarse	Try finer grit
	Dirty, scale-covered parts	Try NZC wheels
Wheels "dusty"	Wheel too soft	Try harder grade
Wheel doesn't hold corner or wheel spalling	Wheel too coarse	Use finer grit and/or 2 grit combination
	Wheel too soft	Use harder grade
Burning the workpiece	Wheel too hard	Use softer grade
	Wheel glazed or loaded	Dress the wheel face
	Grinding pressure too low	Increase grinding force
	Grinding pressure too high	Reduce grinding force
Surface finish too rough	Wheel too coarse	Try finer grit or try ZI/26 specification
	Wheel speed too slow	Try higher speed machine (Do not exceed maximum operating speed of wheel)
	Worn machine bearings	Rebuild machine
Vibration	Wheel worn out of round	Try truing the wheel
	Faulty flanges	Check flanges for flatness and burrs (see ANSI B7.1)
	Bent machine spindle	Check spindle run-out
	Worn machine bearings	Rebuild machine
Wheel stalls or slows	Grinding force too high	Reduce pressure or contact area
	Wheel too hard	Use softer grade wheel
	Machine power too low	Replace machine with higher power grinder

Best choice for demanding applications

4ZF, 4NZ, ZI, AND NZC ZIRCONIA ALUMINA

- Zirconia alumina abrasive engineered for high-pressure, heavy duty, snagging operations including foundry snagging and stock removal
- These wheels have high-speed steel rings with fine centers and reinforcing webs for added safety
- 4ZF – zirconia alumina grain for exceptional wheel life; engineered for high-pressure, heavy-duty, snagging operations, particularly on iron
- 4NZ – zirconia alumina grain for sharpness and an exceptionally high cut rate; developed for low- to medium-pressure operations, especially on steel and steel castings; the most operator-friendly wheels
- ZI – zirconia alumina grain stays sharper, longer, making it the choice for iron castings: ZI/25 for tough metal removal, ZI/26 for finer surface finish
- NZC – zirconia alumina and silicon carbide blend is ideal for dirty, scale-covered castings

Better choice for strong performance to price ratio

CHARGER ZIRCONIA ALUMINA

- Strong, free-cutting aluminum oxide abrasive for foundry snagging and stock removal
- These wheels have high-speed steel rings with fine centers and reinforcing webs for added safety
- Good, general-purpose choice for heavy-duty stock removal on low- to medium-horsepower machines

Good choice for numerous small jobs

5ZF ZIRCONIA ALUMINA AND GEMINI ALUMINUM OXIDE

- These wheels have high-speed steel rings with fine centers and reinforcing webs for added safety
- Ideal for lower horsepower machines or low-pressure applications
- 5ZF - Versatile, good quality zirconia alumina abrasive for foundry snagging and stock removal
- Gemini – versatile aluminum oxide formulation works well with a variety of machines, horsepowers, and operations

SIZE (D x T x H)	MAX. RPM	TIER: BEST			BETTER		GOOD	
		STD. PKG.	SPEC.	PART #	SPEC.	PART #	SPEC.	PART #
Type O1 Straight								
24 x 3 x 12	1,990	1	4ZF1234-R5B38S	690831 66310			5ZF14-QS	690831 66858
HS Steel Rings with Fine Centers, S Webs	1,990	1					Gemini All Purp.	690831 67173
30 x 2 x 12	1,595	1	4NZ1634-Q5B38S	692104 21412	Charger Free Cut	692104 21417	5ZF14-R	692104 67105
HS Steel Rings with Fine Centers, S Webs	1,595	1	4ZF1434-R5B38S	692104 66458	Charger Long Life	692104 21418	Gemini All Purp.	692104 17463
	1,595	1	4ZF1634-Q5B38S	692104 66460				
	1,595	1	ZI/25-R	662531 19636				
	1,595	1	ZI/26-Q	662531 19638				
	1,595	1	NZC142-R5B38S	692104 21414				

For your safety: all floorstand and swingframe wheels have strong fine centers, steel rings and high-strength fiberglass reinforcement construction.

TECH TIP

- Always ensure proper mounting of floorstand and swingframe wheels by mounting with arrow down as marked on wheel
- Always use safety guard
- Always run wheel for 1 minute before grinding
- For optimum performance, ensure adequate air pressure and air volume when using pneumatic machines
- Use constant surface foot per minute machines for highest efficiency
- Do not overdress the wheel face
- Avoid loading or glazing by changing the contact angle
- Use pressure assist whenever possible to obtain maximum cut rate



It is the user's responsibility to refer to and comply with ANSI B7.1

the brightest product
solutions from
**A TOTAL SPECTRUM
OF INNOVATION**

For everything from heavy-to-medium stock removal, to fine finishing, to light blending and polishing, abrasive products are available in many shapes, abrasive grains, specialty coatings and backing configurations to meet many application needs.

Coated Abrasives

A coated abrasive product is made up of three basic raw materials: an abrasive grain, the backing onto which the abrasive is applied, and an adhesive bond.

Abrasive Types

Emery (6)

Emery is a dark gray, round-shaped grain which tends to polish rather than abrade a work surface.

- For polishing and cleaning metal only



Garnet (5)

Garnet is reddish brown in color. This natural abrasive is medium hard and relatively sharp, but not as durable as synthetic abrasives.

- For use on wood only
- Particularly good for soft woods such as pine
- Produces an excellent finish



Silicon Carbide (4)

Silicon carbide is the hardest and sharpest of the manufactured abrasives. Because of its extreme sharpness, this bluish-black abrasive grain permits fast stock removal and cool cut.

- Cast iron
- Non-ferrous metals, i.e. brass, aluminum and bronze
- Non-metallics, i.e. glass, rubber, plastic and stone
- Final finish on wood and stainless steel
- Abrasive planing particleboard



Light Brown Aluminum Oxide (2)

Light brown aluminum oxide is a tough, yet sharp synthetic abrasive characterized by cool cut, long life and the ability to break down under pressure, producing new cutting edges.

- Production wood sanding
- Non-ferrous metal finishing



Brown Aluminum Oxide (2, 7)

Brown aluminum oxide is a tough, durable, synthetic abrasive characterized by the long life and wear resistance of its cutting edges. It offers enormous penetrating strength, even at high speeds.

- Ferrous metals
- Aluminum
- Hardwood



Heat-treated Aluminum Oxide (2)

Heat-treated aluminum oxide is a tough but cool cutting abrasive which gives both long life and freeness of cut on a wide range of materials.

- Ferrous metals
- Wood sanding



Zirconia Alumina (8)

Zirconia alumina is an ultra-tough, synthetic abrasive which provides a free, cool cut for high stock removal applications. It is tougher and sharper than aluminum oxide. It has a micro-crystalline structure which allows for controlled breakdown and self-sharpening.

- Heavy-duty snagging and grinding of all ferrous and non-ferrous metals
- Abrasive planing of wood, plywood and particleboard
- Grinding fiberglass, rubber and plastics



Ceramic Alumina (9)

The sub-micron structure of ceramic alumina allows each grain to continually expose sharp cutting points, resulting in a cooler cutting action and an extended life.

- All ferrous/non-ferrous metals, carbon steel and exotic alloys



Backing Types

Backings are the base for the abrasive minerals and, combined with the adhesive bond, support and anchor the abrasive mineral. The backings used in the manufacture of coated abrasives are:

Paper

Due to the fine surface of paper, a consistent finish is produced. Paper weights include *A, B, C, D, E* and *F* weights with *A* being the lightest and most flexible and *F* being the heaviest and least flexible. *A, B, C* and *D* weight papers are used for hand sanding and light mechanical operations in the form of sheets, PSA (pressure sensitive adhesive) and hook and loop discs and sheet rolls. *E* and *F* weight papers are primarily used for more aggressive mechanical operations in the form of belts and discs.

Cloth

Cloth backings used for coated abrasives are identified by weight. Cloth backings are filled or "finished" with a variety of materials (glues or resins) to create various backing characteristics, most notably flexibility. Several cloth types are used: cotton, polyester, polyester/nylon and polyester/cotton blends, and rayon.

There are three basic weights of cloth: J-weight or "jeans" is the lightest and most flexible. X-weight or "drills" is a heavier cloth that ranges in flexibility, strength and durability and is used on the broadest range of applications. Y-weight is a heavyweight drills cloth used on heavy-duty, high stock removal operations.

Fiber

Vulcanized fiber (cotton fibers which are chemically treated and then pressed under temperature and pressure to form a very durable backing) is used exclusively as the backing for resin fiber discs.

Film

Polyester film backing comes in 3 mil. and 5 mil. thicknesses, which have high strength and surface smoothness. They are used primarily in disc and roll applications requiring consistent surface finish, including powertrain applications.

Foam

Primarily used as backing for sponges, finer grit finishing discs, and buffing and polishing pads for cleaning and moist finishing applications.

Mesh

Mesh matrix backing comprised of thousands of tiny holes allowing for maximum dust extraction.

Bond Types

An adhesive bond system is required to secure the abrasive mineral to the backing. All coated abrasive products are made with a two stage bonding process, the *make coat* and the *size coat*.

The *make coat* is the first layer of bond applied to the backing. The make coat provides the adhesive base between the abrasive mineral and the backing.

The *size coat* is the second coat, which is applied over the abrasive mineral and make coat to anchor the abrasive mineral and provide the desired physical strength of the finished product.

Glue, urea resin, and phenolic resin are the three basic bonding agents most commonly used. There are many size coat and make coat combinations, such as *glue over glue, urea over glue, and resin over resin*. *Glue over glue* is the most flexible bond while *resin over resin* bond is moisture-resistant, harder, less flexible, heat-resistant and has superior grain retention.

Coating Types

There are two types of abrasive coatings used in the manufacturing of coated abrasives: *open coat* and *closed coat*.

Open Coat

With an open coat, 50% to 75% of the surface is covered by abrasive grain. There are evenly spaced voids between the particles of grain, helping reduce the effect of loading caused by wood dust or metal particles.



OPEN COAT
(1/3 LESS GRAIN THAN CLOSED)

Closed Coat

With a closed coat, the entire surface is covered with abrasive grain, with no voids between the particles. This is the most typical coating, permitting the greatest degree of stock removal and longest product life.



CLOSED COAT

Super Size Coating

The Super Size coat is an optional final coat and grinding aid applied over the size coat to help maintain low grinding temperatures and prevent loading.

How to Read a Coated Abrasive Specification

The Norton coated abrasive marking system includes both a generic and a technical marking, which identifies the actual components which make up the product. The markings identify the tradename, abrasive type, bond, backing, and any special features. An example would be: Norton Blaze R980P.

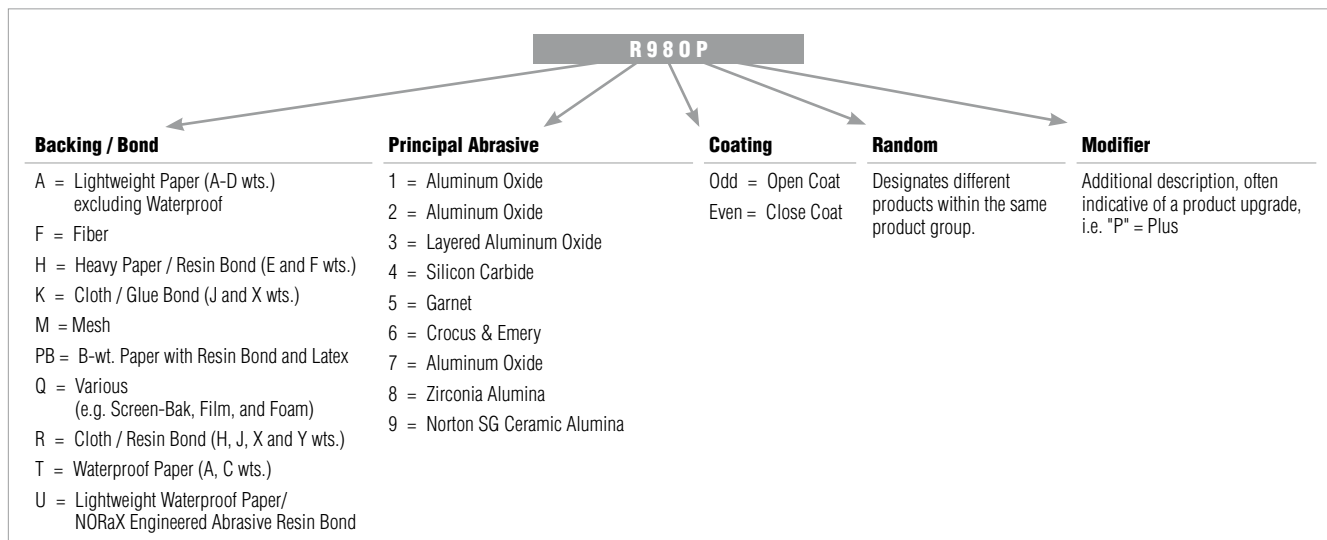

Coated Abrasive Grit Comparison Chart

AVERAGE PARTICLE SIZE IN MICRONS	GRADING SYSTEMS (OTHER THAN EMERY)			EMERY PRODUCTS
	ANSI	FEPA	JIS	
5.0	-	-	-	-
6.0	-	-	3000	-
6.5	1200	-	2500	4/0
8.4	-	P2500	-	-
8.5	-	-	2000	-
9.2	1000	-	-	3/0
10.3	-	P2000	-	-
10.5	-	-	1500	-
12.2	800	-	1200	-
12.6	-	P1500	-	-
15.0	-	-	-	-
15.3	-	P1200	1000	-
16.0	600	-	-	2/0
18.3	-	P1000	800	-
19.7	500	-	-	0
20.0	-	-	-	-
21.8	-	P800	-	-
23.6	400	-	600	-
25.0	-	-	-	-
25.75	-	P600	-	-
28.8	360	-	500	-
30.0	-	P500	-	-
35.0	-	P400	400	-
36.0	320	-	-	-
40.0	-	-	360	-
40.5	-	P360	-	-
44.0	280	-	-	1
45.0	-	-	-	-
46.2	-	P320	320	-
50.0	-	-	-	-
52.5	-	P280	280	-
53.5	240	-	-	-
55.0	-	-	-	-
58.5	-	P240	-	-
60.0	-	-	240	-
64.0	-	-	-	2
65.0	-	P220	220	-
66.0	220	-	-	-
78.0	180	P180	180	-
79.0	-	-	-	3
93.0	150	-	150	-
95.0	-	-	-	FINE
97.0	-	P150	-	-
116.0	120	-	120	-
127.0	-	P120	100	-
136.0	-	-	-	MEDIUM
141.0	100	-	-	-
156.0	-	P100	-	-
189.0	-	-	-	COARSE
192.0	80	-	80	-
197.0	-	P80	-	-
260.0	-	P60	-	-
268.0	60	-	60	-
326.0	-	P50	50	-
341.0	-	-	-	EX. COARSE
351.0	50	-	-	-
412.0	-	P40	40	-
428.0	40	-	-	-
524.0	-	P36	-	-
535.0	36	-	36	-
622.0	-	P30	-	-
638.0	30	-	30	-
715.0	24	-	-	-
740.0	-	P24	24	-
905.0	20	-	-	-
984.0	-	P20	20	-
1320.0	16	-	16	-
1324.0	-	P16	-	-
1764.0	-	P12	-	-
1842.0	12	-	-	-

Coated Abrasive Storage

Stored under proper conditions, coated abrasives will retain their efficiency and usefulness over long periods. Improper or inadequate storage can introduce problems of weakened bond, curl, brittleness, and breakage.

Temperature and humidity are the two most important climatic factors influencing coated abrasive performance. Backings and adhesives are sensitive to climatic changes and will gain or lose moisture according to the relative humidity of their surroundings.

Excessive humidity may cause a softening of some types of adhesive bonds so that the product quickly fills and clogs, or loses its grain during use. Excessive dryness may cause brittleness, reduced flexibility, and distortion of product shapes.

As moisture in the coated abrasive product increases or decreases, dimensional changes can occur. When the backing changes more than the adhesive bond, it causes cupping. High and low humidity can cause concave and convex cupping respectively.

The newer synthetic-backed belts are not affected by moisture. Broad temperature swings will not permanently harm these products either, but cold temperatures will cause a "cold set" condition. Consequently, these products should be allowed to come to room temperature before use.

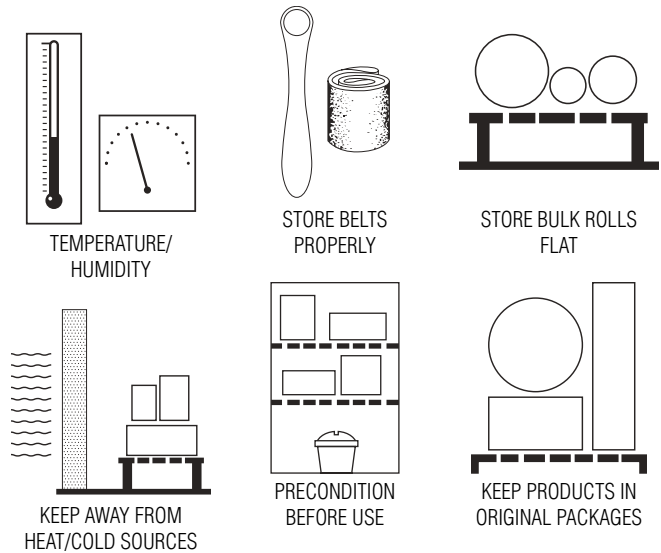

Storage Facilities

The ideal storage (stock) room for coated abrasives would be one in which all the walls are inside partitions, rather than the outside walls of the building.

- Constant levels of humidity and temperature should be maintained. Stockroom temperature should be 60-degrees to 80-degrees F and relative humidity between 35 and 50%.
- Cartons should be kept away from damp or cold walls and floors, where they might absorb moisture.
- Store coated abrasives away from heat sources – steam heated radiators, steam pipes, hot air inlets, heat ducts, or rooms near furnaces or ovens.
- Keep products in original packages. These packages facilitate handling and can be stacked in the most practical and convenient manner.
- Bulk rolls should not be allowed to stand on edge after they have been unpacked. Store flat on shelves or pallets.
- Narrow belts which have been removed from the carton should be rolled up and stored on edge on a clean shelf. Belts may be draped over a large cylinder, such as a gallon can, brake drum, or flanged hanger of the type used for a garden hose. Never hang a belt from a nail – the backing will crease and the abrasive belt might crack. Wide belts should be hung over a tube of at least 4" diameter. Center the belt joint over the tube and add a light weight (such as old packaging tubes) to the bottom loop of the belt to aid in removing set. Condition for 24 hours prior to use.
- For maximum product efficiency, precondition coated abrasive products in a chamber of controlled temperature and humidity before use.

Introduction

Most Norton Bear-Text products consist of a non-woven web of nylon fibers impregnated throughout with abrasive grain and bonded with synthetic resins. This design produces a cushioned, three-dimensional material that is extremely pliable and long lasting. The uniform dispersion of abrasive throughout the web provides a continuous supply of new grain as the old grain and fibers wear away during use.

Norton Bear-Text products, with their open mesh construction, are waterproof, washable, resilient, conformable, non-loading, non-conductive, non-metallic and non-rusting. Non-woven wheels are easily pre-formed to conform to special-shaped work pieces.

Since non-woven products are designed for use where stock removal is not required, they begin where other abrasives leave off. The relatively non-aggressive nature of nylon and grit inherent in the material makes it ideal as a finishing tool. While 60 to 80 grits are considered intermediate sizes in other products, they are considered coarse for non-woven items.

Used wet or dry, Norton Bear-Text non-woven products offer the following advantages: controlled cut (with little or no stock removal) allows for increased productivity, consistent, uniform finish, ability to automate operations, minimized smearing and reduced operator training. These advantages make our non-woven products an excellent alternative to bristle brushes, set-up wheels, greaseless compounds and steel wool.

Product Identification System

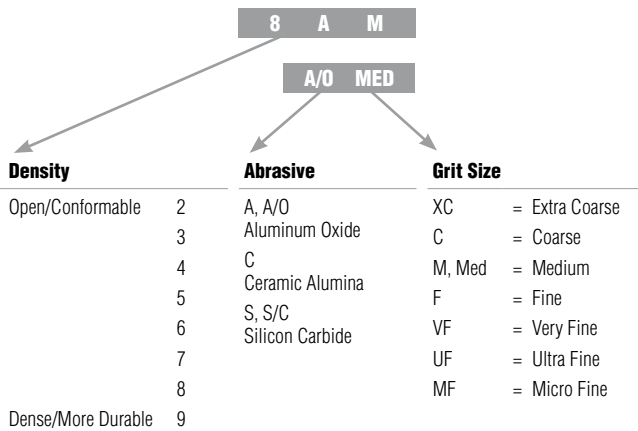

Abrasives

Ceramic alumina, silicon carbide and aluminum oxide abrasives are offered. Ceramic alumina cuts the fastest and is the most cost effective on large-volume applications. Silicon carbide is sharper, cuts faster than aluminum oxide, and produces finer scratch patterns on most surfaces. Aluminum oxide is more durable and tends to last longer. It causes less discoloration on aluminum, and is more aggressive on certain applications such as hardened steel parts. Norton Bear-Text hand pads are also available in a non-abrasive material.

Grits

Grit refers to the size of the abrasive grain impregnated into the nylon web. The coarser the grit, the more aggressive the cut, the rougher the finish. The finer the grit, the less aggressive the cut and the resulting surface finish will be finer, if all other conditions are equal.

GRIT DESIGNATIONS	GRIT SIZE
Extra Coarse (XC)	50
Coarse (C)	60 – 80
Medium (M)	100 – 150
Fine (F)	180 – 220
Very Fine (VF)	240 – 360
Super Fine (SF)	400
Ultra Fine (UF)	600
Micro Fine (MF)	800 – 1200

Densities

The product "density" refers to the number of fibers which have been compressed into the nylon web material. Under identical conditions, harder density wheels cut faster, last longer and produce finer finishes than softer density wheels. Softer density wheels offer greater conformability and have less tendency to load or burn the work piece.

Fiber Sizing

Several nylon fiber sizes are used in the manufacture of Norton Bear-Text and Merit web material because the fiber size is a significant factor in the coating process, as each produces distinct cutting characteristics.

Bonding Agents

Waterproof resins are used in the manufacture of Norton Bear-Text and Merit web material to bond the nylon fibers together and to firmly anchor the abrasive grains throughout the web.

Conventional Finishing Methods Versus Norton Bear-Text Non-Woven Products

The following chart outlines the advantages achievable when using our products as alternatives to other cleaning, blending, deburring and finishing methods. These products are listed in the sequence of normal preference for the application stated. However, because of the numerous variables, only testing can ensure selection of the most cost-effective product.

CONVENTIONAL FINISHING METHOD	KEY APPLICATION	NORTON/MERIT PRODUCT ALTERNATIVES	ADVANTAGES OF NORTON/MERIT PRODUCT VERSUS ALTERNATE FINISHING METHODS
Bristle Brushes	Cleaning	Rapid Strip, Convolute Wheels, and Rapid Prep Discs	Superior cleaning performance Higher productivity No slurry or compound required More consistent finish Eliminate compound dust
Greaseless Compounds	Finishing	Flap Wheels Convolute Wheels Unified Wheels Rapid Prep Discs	Reduced maintenance No compound, instant set-up Elimination of compound dust More uniform finish More consistent work rate
Set-up Wheels	Blending/ Deburring	Convolute Wheels Unified Wheels XHD Discs Rapid Prep Discs	No break-in time required More consistent cut More uniform finish Maintain geometry Safer, no flying wheel pieces
Steel Wool	Cleaning	Rolls Discs Hand Pads	Faster, longer life Less pressure required Non-rusting, cleaner Safer, no splinters

Getting the Most Out of Norton Bear-Tex Wheels

Maximum wheel life and best surface conditioning results can be achieved by closely adhering to the following recommendations.

1) Wheel Direction

Convolute, interleaf flap wheels, and conventional flap wheels must always run in the direction indicated by the arrow printed on the side of each wheel. Unified wheels can be run in either direction.

2) Wheel Speed

Wheel speed is an important factor in that it affects product finish, rate of cut, and wheel life. In general, fast wheel speeds give harder action and a finer finish; whereas, slower speeds give a softer action and a coarser finish for the same wheel density.

The following are recommended operating speeds for the most common applications.

APPLICATION	RECOMMENDED SPEED
Cleaning and upgrading of surface conditions	2200 to 6000 SFPM
Cut-buffing on metal surfaces	6500 to 8000 SFPM
Deburring	5500 to 8000 SFPM
Decorative finishing	500 to 3000 SFPM
Imparting decorative finishes	900 to 3000 SFPM
Oxide removal	3500 to 6500 SFPM

Testing might show that a slower or faster speed is desirable for specific operations. Never exceed the maximum RPM rating of the wheel.

3) Pressure

Light to medium pressure is recommended for most operations. Flap wheels require much lighter pressure to perform properly than other non-woven wheels; unified wheels can withstand much higher pressures in order to perform deburring jobs. In all cases, avoid excessive pressure which might result in wheel deformation and damage to the work surface.

4) Feed Speed

Low feed speed reduces the number of workpieces completed, while producing a shorter scratch pattern. Slow feed speed allows for longer dwell time and permits more work to be done on each piece. Conversely, a fast feed speed increases the number of workpieces completed, while producing a longer scratch pattern.

5) Oscillation

Oscillation may be used to break up scratch lines and produce a more uniform finish. Additionally, an increase in cut might be experienced.

A general starting point for oscillation is 3/8" amplitude at 200 cycles per minute.

6) Lubricants

Lubricants, such as water, water soluble oil, and straight oil, will decrease the heat generated while running, improve the luster, and reduce the surface finish. The higher the viscosity of the lubricant, the lower the surface finish (RMS value) produced.

Factors in Wheel Choice

This chart provides a relative comparison of other Norton Bear-Tex wheel variables. It can serve as a useful guide in choosing the most suitable product for a given application. However, as many other factors affect wheel performance, this chart can only be general in nature. The most cost-effective results can always be obtained by wheel testing on the application.

1 Wheel Conformability	MOST CONFORMABLE (SOFT)						LEAST CONFORMABLE (HARD)	
	←	Flap Wheels	Clean & Finish	Metal Finishing	Rapid Finish GP 7 Density	Rapid Finish GP 8 & 9 Density	Series 4000	→
2 Wheel Openness	OPEN MESH						CLOSED MESH	
	←		Clean & Finish	Metal Finishing	Rapid Finish GP 7 Density	Rapid Finish GP 8 & 9 Density	Series 4000	→
3 Wheel Aggressiveness	MOST AGGRESSIVE						LEAST AGGRESSIVE	
	←		Metal Finishing		Clean & Finish	Rapid Finish GP	Flap Wheels	→
4 Finishing Action	COARSER						FINER	
	←		Metal Finishing	Clean & Finish	Series 4000	Rapid Finish GP Series 4000	Flap Wheels	→
5 Pressure for Best Results	LIGHTER						HIGHER	
	←	Flap Wheels	Clean & Finish	Metal Finishing Rapid Finish GP 7 Density		Rapid Finish GP 8 & 9 Density	Series 4000	→

* On steel surfaces, silicon carbide wheels will produce a brighter finish than aluminum oxide wheels.

Surface Finish Variables

Changes in any one of many factors can affect the surface finish on the work piece. This chart shows the effect on surface finish by changes in single factors of product specifications. Arrows have been used to signify the trend direction. The arrow length does not signify that the effect of each factor is equal.

Variable Factor	Rough Finish High RMS Reading	Smooth Surface Lower RMS Reading
1 Grit Size	Coarse ←	→ Very Fine
2 Wheel Grade	Soft ←	→ Hard
3 Wheel Speed	Slow ←	→ Fast
4 Feed Speed	Faster (Long Scratch) ←	→ Slower (Short Scratch)
5 Oscillation	No Oscillation ←	→ Oscillation
6 Lubricants and Compounds	Dry ←	→ Straight Oil
	← Water	→ Soluble Oil
	←	→ Compounds



The strongest of coated abrasive discs with resin-over-resin construction on heavy-duty fiber backing. Designed for applications ranging from heavy stock removal to surface blending. Used with back-up pads on portable angle grinders.

- Applications:** Stock removal, edge chamfering, weld blending, deburring/deflashing, rust removal, cleaning and finishing
- Size Range:** 4" x 5/8" hole, 4-1/2" – 9-1/8" x 7/8" and 5/8"-11 hole
- Grit Range:** 16 – 120
- Abrasive Grain:** Ceramic Alumina, Zirconia Alumina Blend, and Aluminum Oxide
- Product Options:** Conventional, Speed-Change hubs (5/8"-11), and AVOS technology
- Accessories:** Air-cooled, smooth-faced, and AVOS back-up pads
- Machines Used:**

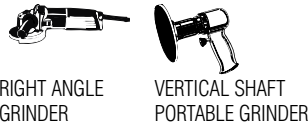

Material-to-Product Recommendation Guide

	BEST		BETTER	GOOD	
	BlazeX F970	Blaze F980	BlueFire F826P	Gemini F726	Metal F240
Stainless Steel / Titanium / Super Alloys*		◆	◆	◆	◆
Mild Carbon Steel / Welds	◆		◆	◆	◆
Ferrous Metals / Cast Iron	◆		◆	◆	◆
Brass / Bronze / Aluminum				◆	◆

*Nickel/Cobalt Based – Hastelloy, Inconel, Waspalloy



Application/Grit Recommendation Guide

COARSER (GRINDING) ←										FINER (FINISHING) →									
16	24	30	36	40	50	60	80	100	120	16	24	30	36	40	50	60	80	100	120
Stock Removal																			
		Edge Chamfering																	
			Weld Blending																
				Deburring/Deflashing															
						Rust Removal													
								Cleaning and Finishing											

Cross Reference Guide

	TOTAL PERFORMANCE ←				INITIAL PRICE →	
	BEST		BETTER	GOOD		
NORTON	BlazeX F970	Blaze F980	BlueFire F826P	Gemini F726	Metal F240	
3M	782C, 982C, 988C	785C, 787C, 985C, 987C	501C	381C	—	
Camel	—	Ceramic	Zirconia	A/O	—	
Flexovit	CG	CG+	ZA	A	—	
GemTex	PMD, Gem Supreme	PMD Supreme, PMD Supreme Plus	Zee-Type, Zee Supreme, Gem Supreme	C-Type	A-Type	
Hermes	—	CR456	RB414X, RB414X Procut	RB514J	RB314	
Klingspor	FS964 ACT	FS966	CS565, CS570	FS764 ACT	CS561	
Metabo	CER	CER	ZA	—	A/O	
Mirka	—	—	Blue, Gold	—	Red	
Pearl	Red Line	—	FZ	Premium A/O	Silver Line	
Pferd	CO-PMD	CO Cool	Z, Z Cool	A Cool	A	
United Abrasives/Sait	7S, 7A-S, 7-11	9S, 9-11	3Z, Z, AZX	3A	A/O, 2A	
SIA	4515, 4580	4515, 4560,	4815, 4819	4924	4919, 4961	
Standard	Ceramic	Ceramic Pro	Zirconia	—	A/O	
VSM	XF760	AF890, AF799, XF885, XF870, XF850	ZF713, ZF714, ZF844	KF808	KF708	
Walter	Walter Coolcut XX	Walter Coolcut XX	Walter Topcut	Walter Coolcut	—	
Weiler	—	Tiger Ceramic	Tiger Zirc, Wolverine Zirc	Tiger A/O	Wolverine A/O	



Best choice for carbon steel and other soft-to-grind materials

BLAZEX F970 CERAMIC ALUMINA

- Improved ceramic alumina micro-fracturing grain constantly exposes sharper grain edges to significantly increase cut rate and life over competitive blended/low-ratio ceramic alumina discs
- Heavier fiber backing for additional strength and tear resistance
- Non-supersized design for cool cutting and long life on carbon steel and other soft-to-grind materials



Best choice for stainless steel, titanium, and super alloys

BLAZE F980 CERAMIC ALUMINA

- 100% ceramic alumina micro-fracturing grain constantly exposes sharper grain edges to significantly increase cut rate and life over competitive blended/low-ratio ceramic alumina discs
- Self-lubricating grinding aid treatment delivers the coolest cut on stainless steel, high alloy steels, super alloys, titanium, and other difficult to grind materials
- Heavier fiber backing for additional strength and tear resistance

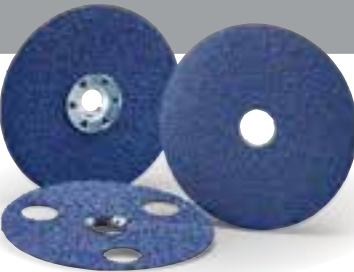

Better choice for stainless, super alloys, steel, cast iron and high-pressure applications

BLUEFIRE F826P ZIRCONIA ALUMINA

- High-performance zirconia alumina abrasive blend provides 15% faster cut and longer life with less power draw than conventional zirconia discs
- Advanced resin bond technology with enhanced grain adhesion for extended life
- Heavier fiber backing for additional strength and tear resistance



Good choice for carbon steel and aluminum applications

GEMINI F726 ALUMINUM OXIDE

- Premium aluminum oxide blend for aggressive cut and longer life than competitive aluminum oxide discs
- Full resin bond for strength and durability
- Heavier fiber backing for additional strength and tear resistance



Good choice for small jobs, applications where performance is not measured, and price-sensitive operations

METAL F240 ALUMINUM OXIDE

- Versatile, multi-purpose aluminum oxide abrasive provides consistent performance on numerous materials and small jobs
- Full resin bond for strength and durability
- Heavier fiber backing for additional strength and tear resistance; low initial price



TIER:	BEST	BEST	BETTER	GOOD	GOOD
TRADENAME:	BLAZEX F970	BLAZE F980	BLUEFIRE F826P	METAL F240	GEMINI F726
ABRASIVE:	Ceramic Alumina	Ceramic Alumina	Zirconia Alumina Blend	Aluminum Oxide	Aluminum Oxide
OTHER:		Supersize			

SIZE (D x H)	GRIT	STD. PKG.	PART #	PART #	PART #	PART #	STD. PKG.	PART #
4 x 5/8	24	25				055395 10595	10	666233 95000
	36	25				055395 10594	10	666233 95001
	50	25					10	666233 95002
	60	25				055395 10592		
	80						10	666233 95004
4-1/2 x 7/8	24	25		699573 98000	662611 38457	666233 53309	10	666233 95007
	36	25	699573 70193	699573 98001	662611 38456	666233 53306	10	666233 95008
	36	50 V			666233 77276			
	50	25	699573 70194	699573 98002	662611 38454	666233 53310	10	666233 95009
	60	25	699573 70195	699573 98003	662611 38453	666233 53311	10	666233 95010
	60	50 V			666233 77278			
	80	25	699573 70196	699573 98004	662611 38452	666233 53312	10	666233 95011
	80	50 V			666233 77279			
	100	25				666233 53313	10	666233 95012
	120	25		662544 25332		666233 53314	10	666233 95013
5 x 7/8	16	25				055395 10684		
	24	25		699573 98005	662611 38563	666233 57276	10	666233 95016
	36	25	699573 70197	699573 98006	662611 38562	666233 57277	10	666233 95017
	36	50 V			666233 77283			
	50	25	699573 70198	699573 98007	662611 38561	666233 57278	10	666233 95018
	60	25	699573 70199	699573 98008	662611 38601	666233 57279	10	666233 95019
	80	25	699573 70200	699573 98009	662611 38600	666233 57280	10	666233 95020
	100	25				666233 57281	10	666233 95021
120	25		662544 09084		666233 57282	10	666233 95022	
6 x 7/8	24	25		662611 60033				
	36	25		662611 60034				
	50	25		662611 60035				
	80	25		662611 60037				
	100	25						
7 x 7/8	16	25				055395 10693		
	24	25		699573 98010	662611 38594	666233 57283	10	666233 95029
	36	25	699573 70201	699573 98011	662611 38593	666233 57284	10	666233 95030
	36	50 V			666233 77287			
	50	25	699573 70202	699573 98012	662611 38592	666233 57285	10	666233 95031
	60	25	699573 70203	699573 98013	662611 38591	666233 57286	10	666233 95032
	80	25	699573 70204	699573 98014	662611 38590	666233 57287	10	666233 95033
	100	25				666233 57288	10	666233 95034
	120	25		662544 11528		666233 57289	10	666233 95035
	9-1/8 x 7/8	24	25		699573 98015	662611 38584	055395 10702	10
	36	25		699573 98016	662611 38583	055395 10701	10	666233 95037
	50	25		699573 98017	662611 38582		10	666233 95038
	60	25				055395 10699	10	666233 95039
	80						10	666233 95040
	100						10	666233 95041
	120						10	666233 95042

Note: Fiber discs must be used with back-up pads shown on the last page of this section.
V = Vendible Package. Ideal for vending machines and small jobs. 10 discs/package.

Speed-Change Fiber Discs

These fiber discs feature Norton quick, tool-free, twist-on and -off Speed-Change fasteners. Discs lock to standard back-up pads with a unique nut design and are easily removed, increasing your productivity with more time to grind.



TIER:	BEST	BEST	BETTER	GOOD
TRADENAME:	BLAZEX F970	BLAZE F980	BLUEFIRE F826P	GEMINI F726
ABRASIVE:	Ceramic Alumina	Ceramic Alumina	Zirconia Alumina Blend	Aluminum Oxide
OTHER:		Supersize		

SIZE (D x H)	GRIT	STD. PKG.	PART #	PART #	PART #	STD. PKG.	PART #
4-1/2 x 5/8-11	24	25		662610 23269		10	776960 09702
	36	25	699573 70205	662611 85294		10	776960 09703
	50	25	699573 70206			10	776960 09704
	60	25	699573 70207	662610 42247			
	80	25	699573 70208	666233 28529		10	776960 09715
	120					10	776960 09723
5 x 5/8-11	24	25		662544 25336	662611 38797		
	36	25	699573 70209	662611 85801	662611 38796	10	666233 95014
	50	25	699573 70210				
	60	25	699573 70211	662611 85803		10	666233 95015
	80	25	699573 70212	666233 16697		10	776960 09728
7 x 5/8-11	24	25		699573 49782	662611 38819	10	666233 95023
	36	25	699573 70213	662610 29863	662611 38818	10	666233 95024
	50	25	699573 70214		662611 38817	10	666233 95025
	60	25	699573 70215	662610 42249	662611 38816		
	80	25	699573 70216	662544 74373		10	666233 95026
	100					10	666233 95027
120					10	666233 95028	

Note: Speed Change fiber discs must always be used with smooth face back-up pads, see next page for details.

Blaze Fiber Disc Test Kits NEW

- Each kit contains one box of 25 BlazeX F970 (36 grit) fiber discs and one box of 25 Blaze F980 (36 grit) fiber discs. Test them for yourself!



TIER:	BEST
TRADENAME:	BLAZEX F970 & BLAZE F980 TEST KITS
ABRASIVE:	Ceramic Alumina

SIZE	GRIT	STD. PKG.	PART #
4-1/2	36	1	776960 95018
5	36	1	776960 95019
7	36	1	776960 95020

AVOS Fiber Discs

- Patented, see-through design allows interrupted cut which reduces heat up to 30% over standard discs
- The scooped holes create air flow to pull swarf away from grinding zone; cool cutting and extended product life
- 15° back-up pad for full utilization of discs – no gouging
- Quick, tool-free, twist-on and -off Speed-Lok fasteners



TIER:	BEST	BETTER
BRAND:	Norton	Norton
TRADENAME:	BLAZE F980	BLUEFIRE F826P
ABRASIVE:	Ceramic Alumina	Zirconia Alumina Blend

SIZE	GRIT	STD. PKG.	PART #	PART #
4-1/2 Speed-Lok (3 hole)	24	10	662544 68389	662611 29718
	36	10	662544 68390	662611 29719
	50	10	662544 68391	662611 29720
	60	10	662544 68392	662611 29721
	80	10	662544 68393	662611 29722
5 Speed-Lok (3 hole)	24	10	662544 68385	662611 26556
	36	10	662544 68386	662611 26557
	50	10	662544 68387	662611 26558
	60	10	662544 68388	662611 26559
7 Speed-Lok (6 hole)	24	10	662544 68381	662611 37454
	36	10	662544 68382	662611 37455
	50	10	662544 68383	662611 37456
	60	10	662544 68384	
	80	10		662611 37458

Note: AVOS fiber discs must be used with AVOS Speed-Lok back-up pads, see next page for details.

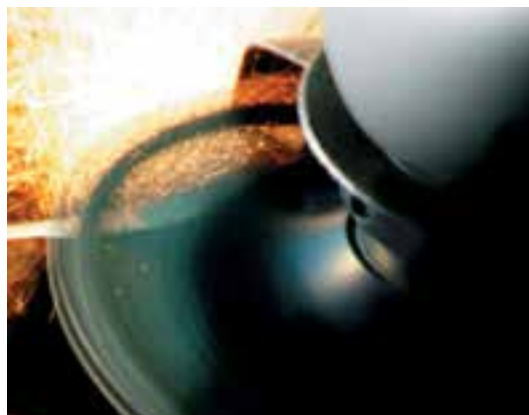

Fiber Disc Accessories



Fiber Disc Baling Unit

- Places 100 discs on a spindle between two plates
- Locks down with a pinch screw
- Maintains the shape of the discs by maintaining pressure to minimize curl
- User-friendly and reusable



Air-Cooled Standard Back-up Pad

Slotted hub design and curved ribs draw heat away from the grinding zone, reducing disc loading and increasing life. All pads have a 5/8"-11 threaded female hub for mounting. We also offer a no-nose pad for shorter-shafted right angle grinders.



Smooth Face Speed-Change Back-up Pad

Molded rubber back-up pads with a smooth face.

- Hard density pads are for aggressive cutting action
- Medium density pads are for all-purpose applications



AVOS Fiber Disc Back-up Pad

- Patented, see-through design allows interrupted cut which reduces heat up to 30% over standard discs
- The scooped holes create air flow to pull swarf away from grinding zone
- 15° back-up pad for full utilization of discs – no gouging
- Quick, tool-free, twist-on and -off Speed-Lok fasteners

DESCRIPTION	MAX. RPM	STD. PKG.	PART #
Fiber Disc Baling Unit			
5"	—	1	776960 01065
7"	—	1	776960 01066
Rubber Back-up Pads			
Air-Cooled Standard for 7/8 Hole Fiber and Non-Woven Discs			
4" Medium	12,000	5	636425 04918
4-1/2" Medium	11,000	5	636425 02122
5" Medium	10,000	5	636425 43421
7" Hard	8,600	5	636425 43425
7" Medium	8,600	5	636425 43422
9" Hard	6,600	5	636425 43426
9" Medium	6,600	5	636425 43423
<i>Note: Retainer nuts are not included with back-up pads. These must be ordered separately.</i>			
Air-Cooled No-Nose			
4-1/2" Medium	11,000	5	636425 04872
5" Medium	10,000	5	636425 03000
Smooth Face for Fiber and Non-Woven Speed-Change Discs			
4-1/2" Medium	20,000	5	662544 92277
5" Medium	12,000	5	636425 43235
7" Hard	8,600	5	636425 43240
7" Medium	8,600	5	636425 43245
7" Soft	8,600	5	636425 43250
9" Medium	7,000	5	636425 43270
AVOS Speed-Lok Back-up Pads			
AVOS Triangular Speed-Lok Back-up Pads			
4-1/2" x 5/8-11	13,000	5	636425 02985
5" x 3/8-24 Pistol Grip*	20,000	5	636425 03029
5" x 5/8-11	13,000	5	636425 02517
5" x 5/8-11 Thicker	13,000	5	636425 03663
5" x 7/16-20 Pistol Grip*	20,000	5	636425 03030
<i>*Use on air pneumatic and high-speed pistol grip sanders</i>			
AVOS Round Speed-Lok Back-up Pads			
7" x 5/8-11 Hard	8,600	5	636425 04873
Tools			
#103 Retainer Nut	—	10	636425 43463
Spanner Wrench	—	5	636425 43005
66NS Short Retainer Nut	—	10	636425 43461

All fiber disc back-up pads are packed in individual boxes within the shipping carton. Each box can be used in a vending machine.



Corner Store Convenience – Right on the Floor

Industry's best selection of vendible abrasive solutions

See the many popular products conveniently pre-packed in small quantity packages

- Perfect for vending machines, pegboards, new test orders, small orders and jobs, and carrying cleanly to job site
- Available in fiber, flap, paper, and quick-change discs, belts, hand pads, depressed center, cut-off and bench wheels, mounted points, cones and plugs, and sharpening stones



Flap discs are versatile grinding and finishing tools having four main components: abrasive flaps, flap density (how the flaps are stacked), backing plate shape (flat or conical), backing plate material (fiberglass or plastic). All flap discs have flaps that are overlapped and glued to the backing plate. The flaps wear during use, exposing new abrasive grain. The different variations of the components above provide a variety of application choices ranging from heavy stock removal to blending to finishing. Flap discs are designed for portable grinder applications and can be the preferred choice over depressed center wheels or fiber discs.

- Applications:** Grinding, stock removal, edge chamfering/beveling, weld blending, deburring/deflashing, rust removal, blending, cleaning and finishing
- Size Range:** 4" : 5/8" hole
4-1/2" - 7" : 5/8"-11 discard mount, 7/8" hole, and 2" - 3" quick-change
- Grit Range:** 24 - 120
- Abrasive Grain:** Ceramic Alumina, Zirconia Alumina, and Aluminum Oxide
- Abrasive Flaps:** Polyester, Cotton/Poly Blend
- Flap Disc Shape:** Type 27 Flat and Type 29 Conical
- Abrasive Flap Density:** Standard or high
- Backing Plate Material:** Fiberglass and plastic
- Machine Used:** RIGHT ANGLE GRINDER

Flap Disc Shapes

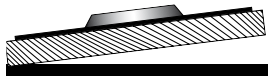

GRIND AT FLATTER ANGLES:
0° - 15°

Type 27 Flat – The Best Choice for Finishing

- Used primarily on flat surfaces
- The best choice for blending and smooth finishing

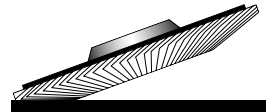

GRIND AT STEEPER ANGLES:
15° - 25°

Type 29 Conical – The Best Choice for Aggressive Stock Removal

- Conical flap discs have angled flaps and may be used on both contoured and edge work
- The angle provides greater surface contact for stock removal on flat surfaces
- The best choice when speed and stock removal are primary considerations

Abrasive Flap Densities



Standard Density

- Excellent for heavy-duty applications and rapid stock removal



High Density

- Ideal when working on uneven or curved surfaces, as well as finer grit blending

Backing Plate Materials

All flap discs are a combination of abrasive flaps adhered to a rigid backing plate. It is the backing plate that provides stability during operation. There are two main materials used: fiberglass and plastic. The fiberglass backing plate, along with the flap shape, helps to absorb vibration and is consumed during use with no smearing. Fiberglass is the most popular material because of its high strength and light weight. The plastic backing plate offers some additional conformability and is trimmable.

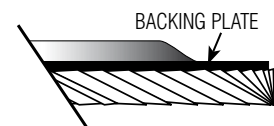

Why Choose Flap Discs?

Flap discs replace both grinding wheels and fiber discs. The same flap disc can be used for applications ranging from stock removal to blending.

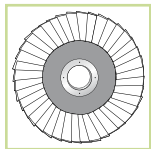

Flap Discs vs. Grinding Wheels

- Faster stock removal
- Smoother finish, no gouging
- Cooler cutting, less glazing
- Lightweight, easier to control
- Less vibration, less operator fatigue
- Reduced noise

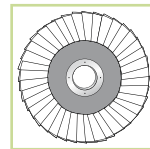

Flap Discs vs. Fiber Discs

- 20X longer life, reduced abrasive cost
- Fewer disc changes, reduced labor cost
- More consistent finish
- No back-up pad required
- Easier storage, no curling
- Reduced loading
- Use flap discs one grit size coarser than fiber discs, except in 36 grit

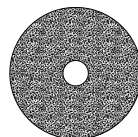

Material-to-Product Recommendation Guide

	BEST	BETTER	GOOD	
	Blaze R980P	BlueFire R884P	Gemini R766	Metal R828
TYPE 29 FOR STOCK REMOVAL				
Stainless Steel / Titanium / Super Alloys	◆	◆	◆	◆
Mild Carbon Steel / Welds		◆	◆	◆
Ferrous Metals / Cast Iron		◆	◆	◆
Brass / Bronze / Aluminum		◆		
TYPE 27 FOR BLENDING AND FINISHING				
Stainless Steel / Titanium / Super Alloys	◆	◆	◆	◆
Mild Carbon Steel / Welds		◆	◆	◆
Ferrous Metals / Cast Iron		◆	◆	◆
Brass / Bronze / Aluminum		◆	◆	◆

Application/Grit Recommendation Guide

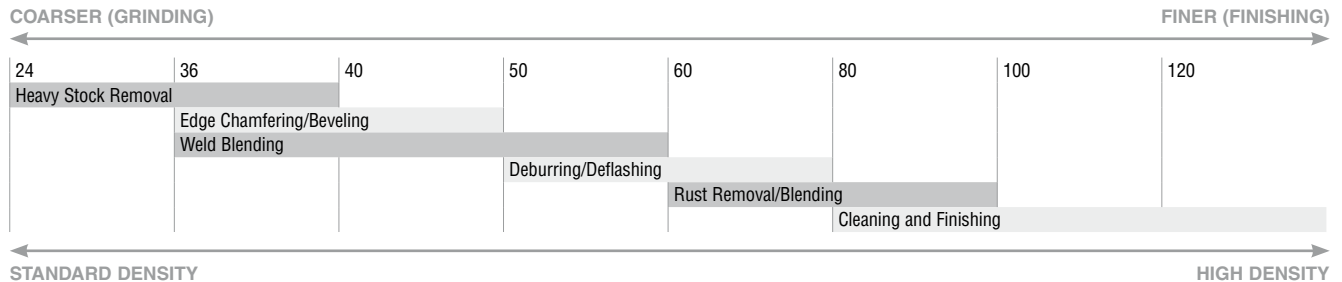

Cross Reference Guide

	TOTAL PERFORMANCE		INITIAL PRICE	
NORTON	BEST	BETTER	GOOD	
	Blaze R980P	BlueFire R884P	Gemini R766	Metal R828
3M	747D, 947D, 967A, 969F	546D, 566A, 577F	—	—
Camel	Ceramic Pro	ZA Pro	A Pro	ZA
CGW/Pasco	Ceramic	Zirconia	A/O	—
DeWalt	XP Ceramic	HP Zirconia	Zirconia	FlexVolt
Flexovit	Zircotex Ceramic	Zircotex, Ziromax, Tornado	—	—
Garryson	CeramiQ	Zirc+	Zirconium	A/O
GemTex	Ceramic Flaptec	Zirconia Flaptec	A/O Flaptec	—
Hermes	—	FL390	RB48024YX, RB48624YX	Webrax-AN 701
Klingspor	SMT656	SMT624, SMT626, SMT627, SMT630	SMT627	—
Metabo	Flexiamant Super Ceramic	Flexiamant Zirconia, Novoflex	—	—
Mirka	—	—	Blue	—
Pearl	Redline Maxidics, Stainlessmax Maxidics	Zirconia Maxidisc, Silver Line Zirconia	A/O Maxidisc	Silver Line A/O
Pferd	Polifan Z-SG, Polifan SG-CO	Polifan SG Zirkon, Polifan SG ZA, SGP, PSF Zirc	Polifan SG A, A-Cool	Polifan PSF A/O
United Abrasives/Sait	Encore Ceramic, Ovation Ceramic	Ovation, Saitlam U	Ovation Attacker	Encore
SIA	—	—	2824 SIAFlap	—
Standard	Ceramic Pro, Ceramic	Zirconia HP, Zirconia AP	Zirconia GP	—
Tyrolit	Cerabond Ceramic, Premium Ceramic	Fastcut, Premium Longlife	Premium A/O	Basic, Standard
VSM (Lehigh Valley)	Ceramic	Zirconia	A/O	—
Walter	Enduro-Flex Turbo	Enduro-Flex, Enduro-Flex Stainless	Enduro-Flex Alu.	Flexsteel
Weiler	Tiger Ceramic, Tiger X, Tiger Saber Tooth	Tiger Paw, Wolverine	Tiger Premium	Tiger

Best/highest productivity for stainless steel, titanium, and super alloys



BLAZE R980P CERAMIC ALUMINA

- Premium ceramic alumina abrasive grain lasts 50% – 200% longer than many flap discs on stainless steel, cobalt, chrome, inconel, titanium and other hard-to-grind materials
- Y-weight polyester flaps with a supersize grinding aid significantly improve life, grain retention, and fray resistance while providing a cool, noticeably fast cut rate
- High-strength fiberglass back on Type 29 and Type 27 High Density is durable, lightweight, and absorbs vibration; Black, flexible plastic backing plate on Type 27 Quick Trim allows for trimmability of the plate

Better choice for mild carbon steel, and welds



BLUEFIRE R884P ZIRCONIA ALUMINA

- High performance zirconia alumina plus abrasive for aggressive cut and long life, with up to 30% longer life than competitive zirconia alumina products
- Polyester/cotton flaps with semi-open coat provide improved durability and reduces loading on aluminum
- High-strength fiberglass back on Type 29 and Type 27 High Density is durable, lightweight, and absorbs vibration; blue, flexible plastic backing plate on Type 27 Quick Trim allows for trimmability of the plate
- Vendible 2-disc package is ideal for vending machines, small jobs, or carrying to a job site

Good choice for carbon steel and aluminum applications



GEMINI R766 ALUMINUM OXIDE

- Alternating zirconia alumina and aluminum oxide flaps provide higher performance than aluminum oxide while retaining an economical price
- Polyester/cotton flaps are the best choice when speed of job completion and stock removal are primary considerations
- Type 27 Flat with quick trim, flexible plastic backing plate or high-density fiberglass back; Type 29 conical with durable, fiberglass back

Good consistent performance with low initial price



METAL R828 ZIRCONIA ALUMINA

- Durable zirconia grain provide good cut rate and life with consistent finish
- Fiberglass/resin backing plates with high strength, light weight, ability to absorb vibration, and operator comfort
- Good choice for coarse grit blending, deburring, and stock removal



TIER:	BEST	BETTER	GOOD	GOOD	GOOD
TRADENAME:	BLAZE R980P	BLUEFIRE R884P	GEMINI R766	METAL R828	METAL R828
SHAPE:	Type 29 Conical	Type 29 Conical	Type 29 Conical	Type 29 Conical	Type 29 Conical
FLAP DENSITY:	Standard	Standard	Standard	Standard	High
ABRASIVE:	Ceramic Alumina	Zirconia Alumina Plus	Aluminum Oxide	Zirconia Alumina	Zirconia Alumina
BACKING PLATE:	Fiberglass	Fiberglass	Fiberglass	Fiberglass	Fiberglass
OTHER:	Supersize				

SIZE (D x H)	GRIT	MAX. RPM	STD. PKG.	PART #	PART #	PART #	PART #	PART #
Type 29 Conical								
4 x 5/8	36	15,300	10		666233 99049			
	40	15,300	10		666233 99050			
	60	15,300	10		666233 99051			
	80	15,300	10		666233 99052			
4-1/2 x 5/8-11	36	13,300	10	662611 83490	662544 61165	666233 99028	662544 19991	
	36	13,300	10 V		666233 41104 2-Pack			
	40	13,300	10	662611 83491	662544 61167	666233 99029	662544 19994	662611 32535
	60	13,300	10	662611 83492	662544 61170	666233 99030	662544 19996	662611 32536
	60	13,300	10 V		666233 41105 2-Pack			
	80	13,300	10	662611 83493	662544 61173	666233 99173	662544 19997	662611 32537
	80	13,300	10 V		666233 41106 2-Pack			
	120	13,300	10			666233 99174		
4-1/2 x 7/8	24	13,300	10		666233 99204			
	36	13,300	10	662611 83486	662544 61155	666233 99032	662544 19963	
	36	13,300	10 V		666233 41107 2-Pack			
	40	13,300	10	662611 83487	662544 61161	666233 99033	662544 19978	662611 32538
	60	13,300	10	662611 83488	662544 61163	666233 99034	662544 19984	662611 32539
	60	13,300	10 V		666233 41108 2-Pack			
	80	13,300	10	662611 83489	662544 61164	666233 99035	662544 19987	662611 32540
	80	13,300	10 V		666233 41109 2-Pack			
5 x 5/8-11	36	12,000	10		666233 99189			
	40	12,000	10		666233 99190			
	60	12,000	10		666233 99191			
	80	12,000	10		666233 99192	666233 99179		
5 x 7/8	120	12,000	10			666233 99180		
	24	12,000	10		666233 99206			
	36	12,000	10	662611 90001	662544 61174	666233 99036	662544 19998	
	40	12,000	10	662611 90002	662544 61176	666233 99037	662544 20001	
	60	12,000	10	662611 90003	662544 61177	666233 99038	662544 20002	
	80	12,000	10	662611 90004	662544 61178	666233 99039	662544 20003	
	120	12,000	10			666233 99181		
	6 x 5/8-11	40	10,200	10		666233 99040	662544 91779	
60	10,200	10		666233 99041	662544 91780			
80	10,200	10		666233 99042	662544 91781			
6 x 7/8	24	10,200	10		666233 99066			
	36	10,200	10		666233 99298			
	40	10,200	10		666233 99193	666233 99182	662544 91776	
	60	10,200	10		666233 99194	666233 99183	662544 91777	
	80	10,200	10		666233 99195	666233 99184	662544 91778	
7 x 5/8-11	36	8,600	10	662611 83498	662544 61188	666233 99185	662544 20009	
	40	8,600	10	662611 83499	662544 61190	666233 99043	662544 20010	
	60	8,600	10	662611 83500	662544 61192	666233 99044	662544 20012	
	80	8,600	10	662611 83501	662544 61193	666233 99045	662544 20013	
	120	8,600	10			666233 99186		
7 x 7/8	24	8,600	10		666233 99196			
	36	8,600	10	662611 83494	662544 61180		662544 20004	
	40	8,600	10	662611 83495	662544 61183	666233 99046	662544 20006	
	60	8,600	10	662611 83496	662544 61185		662544 20007	
80	8,600	10	662611 83497	662544 61186				

V = Vendible package. 2 discs/pack; 5 packs/carton. Order in multiples of 10.

See Portable Tools and Specialties section for mini flap discs.



TIER:	BEST	BEST	BETTER	BETTER	GOOD	GOOD	GOOD
TRADENAME:	BLAZE R980P	BLAZE R980P	BLUEFIRE R884P	BLUEFIRE R884P	GEMINI R766	GEMINI R766	METAL R828
SHAPE:	Type 27 Flat	Type 27 Flat	Type 27 Flat	Type 27 Flat	Type 27 Flat	Type 27 Flat	Type 27 Flat
FLAP DENSITY:	Standard	High	Standard	High	Standard	Standard	Standard
ABRASIVE:	Ceramic Alumina	Ceramic Alumina	Zirconia Alumina Plus	Zirconia Alumina Plus	Aluminum Oxide	Aluminum Oxide	Zirconia Alumina
BACKING PLATE:	Quick Trim Plastic	Fiberglass	Quick Trim Plastic	Fiberglass	Quick Trim Plastic	Fiberglass	Fiberglass
OTHER:	Supersize	Supersize					

SIZE (D x H)	GRIT	MAX. RPM	STD. PKG.	PART #	PART #	PART #	PART #	PART #	PART #	
Type 27 Flat										
4-1/2 x 5/8-11	36	13,300	10		662544 99894	666233 99136		666233 99125	666233 99205	662544 72655
	36	13,300	10 V			666233 41086	2-Pk			
	40	13,300	10	662544 00257	662610 98290	666233 99137	776960 90086	666233 99000	666233 99059	662544 37013
	60	13,300	10	662544 00258	662610 96435	666233 99138	776960 90087	666233 99001	666233 99060	662544 72656
	60	13,300	10 V			666233 41087	2-Pk			
	80	13,300	10	662544 00259	662610 96436	666233 99139	776960 90088	666233 99002	666233 99061	662544 72657
4-1/2 x 7/8	120	13,300	10	662544 00261				666233 99003		
	36	13,300	10	636425 01865	662610 97678	666233 99140	776960 90081	666233 99126	666233 99062	662544 72653
	40	13,300	10	662544 00253	662610 20628	666233 99141	776960 90082	666233 99004	666233 99063	662544 37004
	60	13,300	10	662544 00254	662610 20633	666233 99142	776960 90083	666233 99005	666233 99064	662544 48989
	80	13,300	10	662544 00255	662610 20634	666233 99143	776960 90084	666233 99006	666233 99065	662544 48990
5 x 5/8-11	120	13,300	10	662544 00256			776960 90085	666233 99007		
	36	12,000	10			666233 99144		666233 99127		
	40	12,000	10	776960 90141		666233 99145		666233 99128	666233 99208	
	60	12,000	10	776960 90142		666233 99146		666233 99130	666233 99209	
	80	12,000	10	776960 90143		666233 99147		666233 99131	666233 99210	
5 x 7/8	120	12,000	10					666233 99132		
	36	12,000	10			666233 99148		666233 99133	666233 99211	
	40	12,000	10	662544 00262		666233 99149		666233 99008	666233 99212	662544 72660
	60	12,000	10	662544 00264		666233 99150		666233 99009	666233 99213	662544 72661
	80	12,000	10	662544 00265		666233 99151		666233 99010	666233 99214	662544 72662
6 x 5/8-11	120	12,000	10	662544 00519				666233 99011		
	40	10,200	10	662611 32128	662611 32145				666233 99219	662544 91773
	60	10,200	10	662611 32129	662611 32146				666233 99220	662544 91774
	80	10,200	10	662611 32130	662611 32147				666233 99221	662544 91775
	120	10,200	10						666233 99215	
6 x 7/8	36	10,200	10							
	40	10,200	10	662611 32123		666233 99152		666233 99012	666233 99216	662544 91770
	60	10,200	10	662611 32124	662611 32136	666233 99153		666233 99013	666233 99217	662544 91771
	80	10,200	10	662611 32125		666233 99154		666233 99014	666233 99218	
	120	10,200	10					666233 99015		
7 x 5/8-11	36	8,600	10			666233 99155		666233 99134	666233 99222	662544 72669
	40	8,600	10	662544 61066	662611 32148	666233 99156	776960 90092	666233 99016	666233 99067	662544 72670
	60	8,600	10	662544 61067	662611 32168	666233 99157	776960 90093	666233 99017	666233 99068	662544 72671
	80	8,600	10	662544 61068		666233 99158	776960 90094	666233 99018	666233 99069	662544 72672
	120	8,600	10	662544 61069				666233 99019		
7 x 7/8	36	8,600	10	636425 01866		666233 99159		666233 99135	666233 99070	
	40	8,600	10	662544 61059	662611 32138	666233 99160	776960 90089	666233 99020	666233 99071	662544 72665
	60	8,600	10	662544 61060	662611 32139	666233 99161	776960 90090	666233 99021		662544 72666
	80	8,600	10	662544 61061		666233 99162	776960 90091	666233 99022		662544 72667
	120	8,600	10	662544 61063				666233 99023		

V = Vendible package. Ideal for vending machines & small jobs. 2 Flap Discs/pack, 5 packs/carton. Order in multiples of 10.

See Portable Tools and Specialties section for mini flap discs.

Packaged for retail / walk-in selling / small jobs



BLUEFIRE R884P ZIRCONIA ALUMINA

- Zirconia alumina plus abrasive for aggressive cut and long life
- Individual hang cards provides product selling points; ships in merchandise display case of small quantities
- Available wire rack (with header card) allows merchandising of 4" and 4-1/2" product three ways: hung on pegboard, mounted on an upright, or placed on a shelf/counter



WIRE RACK (WITH HEADER CARD)
ALLOWS MERCHANDISING OF 4"
AND 4-1/2" PRODUCT THREE WAYS:
HUNG ON PEGBOARD, MOUNTED ON
AN UPRIGHT, OR PLACED ON A
SHELF/COUNTER

TIER: **BETTER**
TRADENAME: **BLUEFIRE R884P**
SHAPE: Type 29
FLAP DENSITY: Standard
ABRASIVE: Zirconia Alumina Plus
BACKING PLATE: Fiberglass

SIZE (D x H)	GRIT	MAX. RPM	STD. PKG.	PART #
4 x M-10	40	15,300	5	076607 03214
	60	15,300	5	076607 03215
	80	15,300	5	076607 03216
4-1/2 x 5/8-11	40	13,300	5	076607 03211
	60	13,300	5	076607 03212
	80	13,300	5	076607 03213
7 x 5/8-11	40	8,600	5	076607 03205
	60	8,600	5	076607 03206
	80	8,600	5	076607 03207
Wire Rack			2	076607 04157



See Portable Tools and Specialties section for mini flap discs.



Non-woven depressed center discs have three components: strong synthetic fiber mesh and quality abrasives, bonded together by a smear-resistant adhesive. Rapid Strip discs have an open web construction that enables aggressive cutting action while maintaining a cool, non-loading surface. Rapid Blend discs have a unitized construction with varying weave – from open to tighter – for deburring and finishing. Rapid Prep discs have a more open weave that excels in surface preparation and cleaning. Each product provides excellent cutting action while improving surface finish.

Applications:

Medium-to-light material removal, deburring, blending, cleaning, finishing, and polishing

Size Range:

4-1/2" - 7"

Grit Range:

X-Coarse, Coarse, Medium, Fine, Very Fine

Abrasive Grain:

Ceramic Alumina, Silicon Carbide, Engineered Aluminum Oxide, Aluminum Oxide

Machine Used:



RIGHT ANGLE GRINDER



VERTICAL SHAFT PORTABLE GRINDER

Material/Application-To-Product Recommendation Guide – For All Discs Used on Right Angle Grinders

Stripping Discs

	BEST Blaze Rapid Strip Ceramic	BETTER Rapid Strip Silicon Carbide
Removing scale and coarse welding marks	◆ XC	◆ XC
Removing coatings, epoxy/glue, paint and other clogging material	◆ XC	◆ XC
Removing rust, oxidation, corrosion and residue	◆ XC	◆ XC
Removing parting lines and seams on fiberglass parts	◆ XC	◆ XC
Removing paint/graffiti from concrete/stone	◆ XC	◆ XC

Deburring, Blending, Finishing Discs

	BEST Vortex Rapid Blend	BETTER Vortex Rapid Prep	BETTER Rapid Blend	BETTER Rapid Prep
Removing weld marks and weld spatter	◆ C		◆ C	
Stainless steel deburring and cleaning	◆ C		◆ C	
Removing small flashings and parting lines	◆ C		◆ C	
Surface preparation before coatings/plating		◆ C		◆ C
Light cleaning		◆ F		◆ F
Cleaning and prepping welds		◆ M		◆ M
Removing blemishes after welding stainless		◆ M		◆ M
Blending and finishing all metal parts	◆ VF		◆ VF	
Creating decorative finishes on stainless steel	◆ VF		◆ VF	
Final finishing and polishing	◆ VF		◆ VF	
Final finishing/polishing where high conformability is needed				◆ VF

XC - Extra Course, C - Coarse, M - Medium, F - Fine, VF - Very Fine

Application/Product Recommendation Guide – For All Discs Used on Right Angle Grinders

MOST AGGRESSIVE / LEAST CONFORMABLE ←

→ LEAST AGGRESSIVE / MOST CONFORMABLE

	Blaze Rapid Strip	Vortex Rapid Blend A/O Med. Rapid Blend A/O Coarse	Rapid Blend A/O Medium	Rapid Blend S/C Fine	
Depressed Center Discs					
Discs With Back-Up Pad		Vortex Rapid Prep Rapid Prep A/O Coarse	Rapid Prep A/O Medium	Rapid Prep A/O Fine	Rapid Prep Very Fine
Scale Removal	Best Choice	Second Choice			
Stock Removal	Best Choice	Best Choice			
Heavy Deburring	Second Choice	Best Choice			
Light Deburring		Best Choice	Second Choice		
Light Finishing		Second Choice	Best Choice		
Blending			Best Choice	Second Choice	
Finishing			Second Choice	Best Choice	
Polishing				Best Choice	Second Choice

Cross Reference Guide – For All Discs Used on Right Angle Grinders

	STRIPPING (EXTRA COARSE)		SURFACE FINISHING (COARSE – MEDIUM – FINE)		SURFACE PREP (VERY FINE)	
	BEST	BETTER	BEST	BETTER	BEST	BETTER
NORTON	Blaze Rapid Strip	Rapid Strip	Vortex Rapid Blend	Rapid Blend	Vortex Rapid Prep	Rapid Prep
3M	Clean & Strip XT PRO, Clean & Strip XT PRO Extra Cut	Clean & Strip X	Debur and Finish PRO, Cut and Polish	EXL	SE, Duraflex	SC, PD, AI, LS
Bibielle	—	SDR Strip-It/Red	—	BUR Unitized	SCHD	SCLS, SCD, SCSB
Camel	—	EZ Strip Black/Red	—	—	—	—
Flexovit	—	Clean & Strip	—	—	—	—
Hermes	Strip Discs	Webrax	—	—	—	—
Pearl	—	S/C Stripping	—	—	—	Surface Preparation
Pferd	—	Policlean	—	Poliflex PUR	—	—
Sait	—	Sait-Strip	—	Unitized	7S, 8S	3Z
SIA	SiaStrip	—	—	—	6260	6250
Standard	—	Cleaning	700/800/900 Series	700/800/900 Series	FE, GP	FE, GP, RC
Superior	—	Stripping	—	XL Unitized	—	FD, GD, CC
Walter	—	FX Cleaning	—	—	—	Blendex Surface Conditioning

Why Choose Non-Woven Depressed Center Discs?

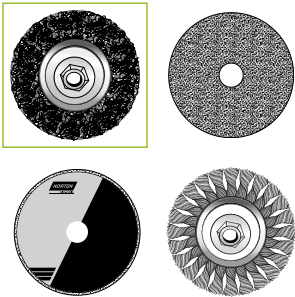

Non-Woven Right Angle Discs vs. Fiber Discs, Wire Wheels, and Depressed Center Wheels

- Deburring, blending and finishing done with one product to reduce the number of steps
- To provide a controlled, sustained finish
- To prevent undercutting and gouging
- To provide a cooler grinding action to lessen the chance of warping or discoloration
- When loading is an issue with fiberglass, adhesives and soft metals
- For stripping coatings and paint off of hard materials like concrete, cement and stone
- Less vibration and quieter for high operator acceptance
- To provide an alternative to wire brushes



Blaze Your Way to Greatest Productivity

Norton Blaze Rapid Strip Type 27 Depressed Center Discs

Strip/clean Cast Iron, Steels, Aluminum, Fiberglass and composites

- Open structure; will not load on sticky coatings, adhesives, and soft metals (e.g. aluminum), or snag and shed like a cloth or fiber disc might
- Norton Blaze ceramic alumina grain provides 2X cut rate and life over silicon carbide
- Will not shed on heavily rust-encrusted pieces
- Extremely versatile; use one disc; stiff enough to stand abuse, but soft enough to prevent gouging and rework
- Use on edge for blending weld root forms
- Apply some pressure to strip or remove coatings; lighter pressure finishes like a surface finishing disc
- Fewer safety, ergonomic, and environmental issues due to fewer change-outs, less downtime, and less production waste/landfill scrap



Rapid Strip

Best choice for quick and easy rough cleaning and stripping of all materials



BLAZE RAPID STRIP CERAMIC ALUMINA

- Blaze ceramic grain provides 2X plus faster, consistent rate and life than silicon carbide discs, leaves a thoroughly cleaned surface, ensuring excellent adhesion in subsequent processes such as painting and soldering
- Open web construction for minimal loading; does not shed or snag on rusty pieces; prevents gouging and rework
- Rapid Strip material provides a unique combination of aggressive performance, long life, and improved finish

Better choice for use on a variety of materials, including metal, fiberglass and stone



RAPID STRIP SILICON CARBIDE

- Sharp silicon carbide abrasive provides fast aggressive cutting action
- Advanced resin bond prevents shedding, snagging, gouging, and rework
- Open web construction for minimal loading; great alternative to wire brushes



		TIER: BEST		TIER: BETTER		
		BLAZE RAPID STRIP		RAPID STRIP		
<i>TRADENAME:</i>		Ceramic Alumina		Silicon Carbide		
<i>ABRASIVE:</i>		36-50		36-50		
<i>GRIT SIZE:</i>		X-Coarse		X-Coarse		
<i>GRADE:</i>		Type 27/Fiberglass		Type 27/Fiberglass		
<i>TYPE/BACKING:</i>		SIZE (D x H)	MAX. RPM	STD. PKG.	PART #	PART #
		4-1/2 x 5/8-11	12,000	10	662544 98101	662610 09585
		4-1/2 x 7/8	12,000	10	666233 03783	662610 09649
		5 x 5/8-11	11,000	10	666233 03915	
		5 x 7/8	11,000	10	666233 03916	
		7 x 5/8-11	8,000	10	666233 03919	662610 09650
		7 x 7/8	8,000	10	666233 03920	662610 09586

Rapid Blend

Best choice with revolutionary technology for heavy deburring and finishing



VORTEX RAPID BLEND ALUMINUM OXIDE

- Proprietary engineered Vortex aluminum oxide agglomerated grain performs the medium to fine grit steps of traditional aluminum oxide discs
- Thick nylon web for 2X longer life and faster finishing vs. traditional aluminum oxide discs, with minimal shedding
- Special resin chemistry resists shedding when used on sharp edges, making it ideal for deburring; no smearing

Better choice for surface prep, deburring, blending and removing parting lines, rust, and coatings



RAPID BLEND NEX A/O / S/C

- Premium aluminum oxide or silicon carbide grain for consistent performance
- Uniform construction extends life and maintains part tolerance; prevents cutting and gouging
- Resin formula produces consistent, smear-free finishes

Consistent smear free performance with low entry price



RAPID BLEND ALUMINUM OXIDE

- Premium aluminum oxide grain; engineered for more demanding applications
- Uniform construction maintains part tolerance; prevents cutting and gouging
- Smear-free bond excels at producing light satin finishes

MOST AGGRESSIVE / LEAST CONFORMABLE ← → LEAST AGGRESSIVE / MOST CONFORMABLE



	BEST		BETTER		BETTER		BETTER		BETTER	
	VORTEX RAPID BLEND		RAPID BLEND NEX		RAPID BLEND NEX		RAPID BLEND NEX		RAPID BLEND	
TRADENAME:	Engineered A/O		Aluminum Oxide		Aluminum Oxide		Silicon Carbide		Aluminum Oxide	
ABRASIVE:	100-120		150-180		220-280		320-400		150-180	
GRIT SIZE:	Vortex 5AM		NEX-2AM		NEX-2AF		NEX-2SF		High Strength Medium	
SPECIFICATION:	Type 27/Fiberglass		Type 27/Fiberglass		Type 27/Fiberglass		Type 27/Fiberglass		Type 27/Fiberglass	
TYPE/BACKING:	PART #		PART #		PART #		PART #		PART #	
SIZE (D x H)	MAX. RPM	STD. PKG.	PART #		PART #		PART #		PART #	
4-1/2 x 5/8-11	12,000	10	662544 29243		662610 23947		662610 23946		662610 23943	
4-1/2 x 7/8	12,000	10	662544 29268		662610 20548		662610 20547		662610 20546	

Rapid Prep
7/8" Center Hole

Best choice for aggressive stock removal and blending in one step



RAPID PREP XHD

- Coarse and Medium discs solve your most aggressive stock removal and blending challenges; remove weld lines, weld spatter, weld discoloration and blend surfaces in a single step
- Improve cut control and surface blending over traditional coated flap discs and fiber discs from our unique combination of a conformable fiber matrix and premium ceramic grain
- XHD Coarse discs for aggressive weld removal and surface blending on steels and Medium discs on softer metals/alloys



TIER: **BEST**
 TRADENAME: **RAPID PREP XHD**
 ABRASIVE: Ceramic Alumina

SIZE (D x H)	STD. PKG.	PART #
Coarse		
4-1/2" x 7/8"	40	662611 70275
5" x 7/8"	40	662611 70279
7" x 7/8"	25	662611 70280
Medium		
4-1/2" x 7/8"	40	662611 70282
5" x 7/8"	40	662611 70283
7" x 7/8"	25	662611 70284

All Vortex and Rapid Prep 7/8 hole discs are non-stock. Contact your Norton representative for current order quantities, and lead-times.

Note: Max RPM is determined by corresponding back up pad.

Norton Rapid Prep Surface Conditioning Products

The Perfect Abrasive, Coating, and Bond Built into Every Disc and Belt

- Available in premium Vortex aluminum oxide aggregate grain and Norton aluminum oxide grain; ideal for many aerospace, metal and stainless steel fabrication, and MRO applications
- Our proprietary coating method extends life and delivers consistent finishes by creating a thick layer of grain throughout the product; grain does not sit on top of fibers as other competitive products can
- Our new Clean Bond resin system guarantees smear-free finishes, even on high nickel content alloys; will not load on aluminum and soft metals, as competitive products can



Non-Woven Standard Back-up Pad Discs

Rapid Prep
7/8" Center Hole

Best choice for finishing and blending applications



VORTEX RAPID PREP ALUMINUM OXIDE DISCS

- High-performing, patented Vortex agglomerated aluminum oxide grain provides the cutting power of a coarser grit with the finish of finer grits
- Premium high-loft nylon fiber bonded to a strong nylon scrim backing allows a thick layer of resin bond and grain for extended life and provides added durability and stiffness
- Proprietary Clean Bond resin technology guarantees smear-free finishes even on high nickel content alloys and reduces loading on aluminum and other soft metals

Better choice for high nickel content alloys, aluminum and other soft metals



RAPID PREP ALUMINUM OXIDE

- Quality aluminum oxide abrasive grain coating provides up to 20% higher cut rate and 50% better performance than competitive products
- Premium high-loft nylon fiber bonded to a strong nylon scrim backing allows a thick layer of resin bond and grain for extended life, added durability and stiffness
- Proprietary Clean Bond resin technology guarantees smear-free finishes even on high nickel content alloys and reduces loading on aluminum and other soft metals



	TIER: BEST		BETTER	
	TRADENAME: VORTEX RAPID PREP		RAPID PREP	
	ABRASIVE: Engineered Aluminum Oxide		Aluminum Oxide	
SIZE (D x H)	STD. PKG.	PART #		PART #
Extra Coarse				
4-1/2" x 7/8"	25			666233 26070
5" x 7/8"	25	666233 34975		
7" x 7/8"	25	666233 41360		
Coarse				
4-1/2" x 7/8"	25	666233 34944		662544 73868
5" x 7/8"	25	666233 34946		662610 08293
7" x 7/8"	25	666233 41362		666233 25138
Medium				
4-1/2" x 7/8"	25	666233 33612		666233 25915
5" x 7/8"	25	666233 34963		662610 17124
7" x 7/8"	25	666233 41364		666233 25919
Fine				
4-1/2" x 7/8"	25	666233 33608		666233 25153
5" x 7/8"	25	666233 34954		662544 69132
7" x 7/8"	25	666233 41366		666233 25897
Very Fine				
4-1/2" x 7/8"	25	666233 33616		
5" x 7/8"	25			666233 25943
7" x 7/8"	25	666233 41368		666233 25959

All these discs are non-stock. Contact your Norton representative for current order quantities, and lead-times.

Note: Max RPM is determined by corresponding back-up pad.

See page 54 for 7/8" Hole Air Cooled Back-up Pads

Rapid Prep

Speed Change 5/8"-11

- These discs feature Norton quick, tool-free, twist-on and -off Speed-Change fasteners. Discs lock to standard back-up pads with a unique nut design and are easily removed, increasing your productivity with more time to grind.



TIER: **BEST**
 TRADENAME: **RAPID PREP XHD**
 ABRASIVE: Ceramic Alumina

SIZE (D x H)	STD. PKG.	PART #
Coarse		
4-1/2" x 5/8-11"	25	662611 70060
5" x 5/8-11"	25	662611 70061
7" x 5/8-11"	25	662611 70288
Medium		
4-1/2" x 5/8-11"	25	662611 70062
5" x 5/8-11"	25	662611 70063
7" x 5/8-11"	25	662611 70289

Max RPM is determined by corresponding back up pad.



TIER: **BEST** | **BETTER**
 TRADENAME: **VORTEX RAPID PREP** | **RAPID PREP**
 ABRASIVE: Engineered Aluminum Oxide | Aluminum Oxide

SIZE (D x H)	STD. PKG.	PART #	PART #
Extra Coarse			
4-1/2" x 5/8-11"	25	666233 73667	666233 73690
5" x 5/8-11"	25	666233 73669	
7" x 5/8-11"	25	666233 73670	666233 73692
Coarse			
4-1/2" x 5/8-11"	25	666233 73671	666233 73693
5" x 5/8-11"	25	666233 73674	662544 98516
7" x 5/8-11"	25	666233 73675	662611 92908
Medium			
4-1/2" x 5/8-11"	25	666233 73678	666233 08157
5" x 5/8-11"	25	666233 73679	666233 73694
7" x 5/8-11"	25	666233 73680	662611 92913
Fine			
4-1/2" x 5/8-11"	25	666233 73681	
5" x 5/8-11"	25	666233 73682	666233 73695
7" x 5/8-11"	25	666233 73684	
Very Fine			
5" x 5/8-11"	25	666233 73686	666233 73699
7" x 5/8-11"	25	666233 73687	666233 73700

Note: Speed Change discs must always be used with smooth face back-up pads.
 Max RPM is determined by corresponding back-up pad.

AVOS Non-Woven Speed-Lok

- Patented hole design allows for interrupted cut, reducing heat up to 30% over standard surface preparation discs for cooler cutting and longer life
- With complete vision into the grinding zone, operators can grind more accurately with less re-work; scooped holes create air glow to pull loose abrasive and swarf away from work surface grinding zone – resulting in extended disc life
- The 15° angle back-up pad lets you grind at 5° - 15° angle allowing for greater utilization of disc surface and eliminates gouging of workpiece

See page 54 for Speed Change and AVOS Back-up Pads



TIER: **BETTER**
 TRADENAME: **RAPID PREP AVOS**
 ABRASIVE: Aluminum Oxide

SIZE (DIAMETER)	STD. PKG.	PART #
Coarse		
4-1/2	10	662610 10447
5	10	666233 74818
Medium		
4-1/2	10	662610 10448
5	10	666233 74819
Very Fine		
4-1/2	10	666233 74823
5	10	666233 74824

Note: AVOS discs must be used with AVOS Speed-Lok back-up pads.
 Max RPM is determined by corresponding back up pad.

Non-Woven Hook and Loop Discs

Rapid Prep

Non-Woven Hook and Loop Discs



TIER: **BEST**
 TRADENAME: **RAPID PREP XHD**
 ABRASIVE: Ceramic Alumina

SIZE (DIAMETER)	STD. PKG.	PART #
Coarse		
4-1/2	40	662611 70179
5	40	662611 70181
7	25	662611 70182
Medium		
4-1/2	40	662611 70183
5	40	662611 70185
7	25	662611 70186

Max RPM is determined by corresponding back-up pad.
 * Standard Package = 80

Back-up Pads

Hook & Loop Back-up Pads

PAD DIAMETER	SPINDLE OR HOLE SIZE	MAX. RPM	3M EQUIVALENT	STD. PKG.	PART #
Back-up Pads for Hook and Loop Discs					
2	1/4 Steel Shank	23,000	922	5	662610 59352
3	1/4 Steel Shank	20,000	923	5	662610 59354
4	1/4 Steel Shank	18,000	924	5	662610 59356
	5/8-11	13,000	914	5	662610 59304
	M10 x 1.250	13,000		5	662610 59305
4-1/2	5/8-11	10,000	9145	5	662610 06948
5	5/16-24 Male	10,000	905	5	662610 59360
	5/8-11	10,000	915	5	662610 59310
6	5/8-11	8,000	916	5	662610 59312
7	5/8-11	6,000	917	5	662610 59368
8	5/8-11	4,500	918	5	662610 59372

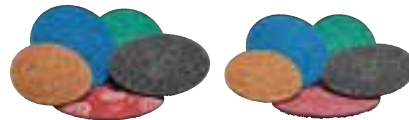

TIER: **BEST** **BETTER**
 TRADENAME: **VORTEX RAPID PREP** **RAPID PREP**
 ABRASIVE: Engineered Aluminum Oxide Aluminum Oxide

SIZE (DIAMETER)	STD. PKG.	PART #	PART #
Extra Coarse			
2	50		662610 17900
3	25	666233 33620	
4-1/2	25	666233 34972	662610 17906
5	25	666233 34974	662610 17215
7	25	666233 34976	662611 92846
Coarse			
2	50	666233 34882	662610 04431 *
3	25	666233 34883	662610 55015
4-1/2	25	666233 34943	662610 17806
5	25	666233 34945	662610 04435
7	25	666233 34951	662610 55027
Medium			
2	50	666233 34958	662610 04441
3	25	666233 34956	662610 04442
4-1/2	25	666233 34961	662610 04444
5	25	666233 34962	662610 55022
7	25	666233 34965	662610 17813
Fine			
2	50	666233 33604	666233 25141
3	25	666233 33605	666233 25143
4-1/2	25	666233 33607	666233 25147
5	25	666233 33609	666233 25154
7	25	666233 34955	662611 99465
Very Fine			
2	50	666233 33613	666233 25926
3	25	666233 33614	666233 25934
4-1/2	25	666233 33615	666233 25936
5	25	666233 33617	666233 25941
7	25	666233 34969	662610 19990

Max RPM is determined by corresponding back-up pad.
 * Standard Package = 80





Norton PSA (pressure sensitive adhesive) individual cloth discs are used on four different types of machines and the application changes depending on which machine they are used on.

Applications: Pneumatic and Electric Dual-Action (DA) and Electric Random Orbital Sanders – for use on contours or flat surfaces for light- to medium-pressure grinding, blending, leveling, and finishing applications.

Size Range: 5" – 24" diameter

Grit Range: 24 – 180

Abrasive Grain: Ceramic Alumina, Zirconia Alumina, Aluminum Oxide

Back-up Pads: Rubber, with hardness variations for different applications, for portable machines. Steel for stationary disc sanders.

Machine Used:



ORBITAL SANDER



STATIONARY DISC SANDERS



Best choice for all hard-to-grind high alloy steels



BLAZE R980P CERAMIC ALUMINA

- 100% ceramic alumina micro-fracturing grain constantly exposes sharper grain edges to provide fastest cut rate and longest life over competitive blended/low-ratio ceramic alumina discs
- Strong resin bond and heavy-duty Y-weight polyester backing for consistent cut, better grain adhesion, edge-tear resistance, and durability
- Self-lubricating grinding aid treatment delivers the coolest cut on stainless steel, high alloy steels, super alloys, titanium, and other difficult to grind materials

Better choice for grinding and deburring stainless steel



BLUEFIRE R821P ZIRCONIA ALUMINA

- Latest generation of self-sharpening, zirconia alumina abrasive for cooler cut and extended life over aluminum oxide discs
- Heavy-duty Y-weight cotton backing for edge-tear resistance and durability
- Pressure sensitive adhesive makes for easy application and removal

Good choice for general-purpose metalworking



GEMINI R228 ALUMINUM OXIDE

- Premium aluminum oxide abrasive gives an excellent initial cut rate
- Durable X-weight cotton backing makes these discs a good blend of flexibility and life
- The cotton backing provides good resistance to heat

Good option for light- to medium-pressure grinding, blending, leveling and finishing applications



METAL R243 ALUMINUM OXIDE

- Aluminum Oxide grain provides consistent cut for general purpose use
- Improved resin bond system provides longer life
- Flexible J-weight cotton backing for added conformability, tabs allow for easy liner removal

Cloth PSA Discs for Dual-Action and Random Orbital Sanders



TIER:	BEST	GOOD	GOOD
TRADENAME:	BLAZE R980P	GEMINI R228	METAL R243
ABRASIVE:	Ceramic Alumina	Aluminum Oxide	Aluminum Oxide
ATTACHMENT:	PSA Discs	PSA Discs	PSA Discs
OTHER:	Supersize		

SIZE (D)	GRIT	PKG./CASE	PART #	PART #	PART #
5	36	50/250	662544 61506*	662611 36589	
	40	50/250	662544 61507	662611 36588	
	50	50/250	662544 61508	662611 36587	
	60	50/250	662544 61509	662611 36586	
	80	50/250	662544 61510	662611 36585	699573 39967
	100	50/250		662611 36584	699573 39968
	120	50/250	662544 61512	662611 36583	699573 39969
	150	50/250		662611 36582	699573 39970
	180	50/250		662611 36581	699573 39971
	6	60	50/250		662611 36596
80		50/250		662611 36595	699573 39973
100		50/250		662611 36594	699573 39977
120		50/250		662611 36593	699573 39978
150		50/250			699573 39979
180		50/250		662611 36592	699573 39986
8	36	50/250		662611 36350	
	40	50/250		662611 36351	
	50	50/250		662611 36352	
	60	50/250		662611 36356	
	80	50/250		662611 36354	
	120	50/250		662611 36355	

*PKG./Case: Blaze R980P 5" 36 grit discs = 50/200



Back-up Pads for Cloth PSA Discs

DESCRIPTION	MAX. RPM	STD. PKG.	PART #
Back-up Pads for Cloth PSA Discs			
5" Diameter – Low Profile – Soft	12,000	5	636425 06126
5" Diameter – Low Profile – Medium	12,000	5	636425 06131
5" Diameter – Tapered – Medium	12,000	5	636425 06139
6" Diameter – Low Profile – Soft	10,000	5	636425 06127
6" Diameter – Low Profile – Med	10,000	5	636425 06133
6" Diameter – Tapered – Medium	10,000	5	636425 06141
8" Diameter – Tapered – Medium	6,000	5	636425 43112

Large Diameter Cloth PSA Discs

Used on stationary disc machines for dimensioning and finishing metal workpieces and woodworking. Pressure sensitive adhesive offers fast, convenient mounting. Made without center holes for full-face usage.



TIER:	BEST	BETTER	GOOD
TRADENAME:	BLAZE R980P	BLUEFIRE R821P	GEMINI R228
ABRASIVE:	Ceramic Alumina	Zirconia Alumina	Aluminum Oxide
ATTACHMENT:	PSA	PSA	PSA
OTHER:	Supersize		

SIZE (D)	GRIT	PKG./CASE	PART #	PART #	PART #
10	36	25/50			662611 36606
	40	25/50		662611 38314	662611 36604
	50	25/50			662611 36607
	60	25/50		662611 38316	662611 36602
	80	25/50		662611 38317	662611 36601
	100	25/50			662611 36600
12	24	25/50		662611 38318	
	36	25/50	662544 16171	662611 38319	662611 36635
	40	25/50	662544 16172	662611 38320	662611 36630
	50	25/50	662544 16173	662611 38321	662611 36625
	60	25/50	662544 16174	662611 38322	662611 36620
	80	25/50	662544 16175	662611 38323	662611 36615
	100	25/50			662611 36614
	120	25/50	662544 16176		662611 36613
15	36	25/50			662611 36666
	60	25/50			662611 36663
	80	25/50			662611 36662
16	36	25/50			662611 36700
	40	25/50			662611 36685
	50	25/50			662611 36684
	60	25/50		662611 38334	662611 36683
	80	25/50			662611 36701
18	36	25/50			662611 36720
	60	25/50			662611 36696
	80	25/50			662611 36723
20	36	25/50	662544 16165	662611 38343	662611 36710
	40	25/50		662611 38344	662611 36709
	50	25/50	662544 16167		662611 36711
	60	25/50	662544 16168	662611 38346	662611 36712
	80	25/50	662544 16169		662611 36706
	120	25/50	662544 16170		
24	36	10/10			662611 36718
	40	10/10			662611 36717
	50	10/10			662611 36725
	60	10/10			662611 36726
	80	10/10			662611 36727



For use on dual action and random orbital sanders. The industry's highest performing and broadest selection of paper discs in PSA (pressure sensitive adhesive) disc rolls and individual discs, and hook and loop discs.

- Applications:** Stripping and preparing primed and painted surfaces for finishing, sanding of plastics, fiberglass and composites, bare wood sanding, light weld blending, preparing and finishing metal, and sanding of all gel coat and body filler compounds.
- Size Range:** 3" – 8"
- Grit Range:** 36 – 1500
- Abrasive Grain:** Ceramic Alumina, Zirconia Alumina, Aluminum Oxide, Silicon Carbide
- Attachment Systems:** PSA (pressure-sensitive adhesive), hook and loop
- Paper Weights:** Heavyweight – E and F; Lightweight – B, C, and D
- Vacuum Holes:** See product availability charts
- Machine Used:**



ORBITAL SANDER



VERTICAL SHAFT PORTABLE GRINDER

Material/Application-to-Product Recommendation Guide

	BEST			BETTER		GOOD	
	Heavy-Medium Stock Removal	Light Stock Removal Finishing		Heavy-Medium Stock Removal		Light Stock Removal Finishing	Light Stock Removal Finishing
	SG H920	Blaze A995	Dry Ice A975	BlueFire H875P	BlueFire H822	A2750P	Gold Reserve A296
Primed, Painted Surfaces		◆	◆	◆		◆	◆
Fiberglass / Composites / Gel Coats		◆	◆	◆		◆	◆
Wood		◆	◆	◆		◆	◆
Metal	◆	◆	◆		◆	◆	◆
Body Fillers / Compounds / Plastics		◆	◆	◆		◆	◆

Application/Grit Recommendation Guide

COARSER (GRINDING)										FINER (FINISHING)									
36	40	60	80	100	120	150	180	220	240	280	320	360	400	500	600	800	1000	1200	1500
Roughing to Intermediate				Intermediate to Finishing						Fine Finishing				Ultra Fine Finishing					

Cross Reference Guide

	TOTAL PERFORMANCE						INITIAL PRICE		
	BEST			BETTER			GOOD		
NORTON	F-Weight SG H920	X-Weight Blaze A995	B- & C-Weight Dry Ice A975	F-Weight BlueFire H822	E-Weight BlueFire H875P	B-Weight A275 OP	B-Weight Durite A475	C-Weight A290	B-Weight Gold Reserve A296
3M	763U	732U, 737U, 755L 775L	334U, 734U, 735U	—	740I, 745I, 750U, 751U, 751I	216U, 255L, 236U, 260L, 334U	405N, 414N, 415U, 426U, 435U	236U, 316U, NX	216U, 236U
Hermes	BW114, CR116	CR116	—	BW115, BW184	BW110, VC153	VC154-LL	SF168	VC151-LL, VC152, WA flex 28	—
Indasa	—	HT Line	HT Line, RedLine	—	HeavyLine	PlusLine	—	WhiteLine, YellowLine	—
Klingspor	PS61	—	PS36	PS21	PS36	PS33, PS73W	PL35, PS14	PS33	PL36
Mirka	—	—	—	—	Royal CRS. Cut	Q-Silver, Royal Micro	CaratFlex, PolarStar	Bulldog Gold, Basecut	Bulldog Gold
SIA	—	—	Siaprime 5550, 1958	1820	1820, 1919, 1948	1940, 1944, 1950	1748	1947, 1960	—
VSM	—	—	—	—	KP510E, KP709	—	CP131A	KP911	—

Heavyweight Paper Discs

Best choice for most demanding stock removal applications



SG H920 CERAMIC ALUMINA

- Durable and friable Norton seeded gel ceramic alumina abrasive ensures fast, aggressive, yet cool cutting action and maximum life
- Strong F-weight paper, synthetically-coated, provides maximum durability and resistance to edge chipping and shedding
- Closed coat and sharp grain make this a premiere product for metal fabricating and blending; ideal for soldered and welded areas

Better choice for aggressive metalworking applications



BLUEFIRE H822 ZIRCONIA ALUMINA

- Patented zirconia alumina abrasive provides 2X-3X life over aluminum oxide products
- Strong F-weight paper, synthetically-coated for excellent durability and chip resistance; pressure sensitive adhesive and linked disc roll format allow easy application, removal, and dispensing
- Non-stearated (no anti-loading agents) for non-contaminating; often required for prime auto and aerospace paint applications

Better choice for soft material and wood applications



BLUEFIRE H875P ZIRCONIA ALUMINA

- Next-generation, self-sharpening zirconia alumina abrasive provides 2-3 times the life of aluminum oxide discs, longer life versus original zirconia alumina discs, improved cut rate, and minimal heat
- Strong E-weight latex/paper backing resists tearing while staying conformable and flexible
- Open coat contributes to minimized loading

Stick & Sand (PSA)
Heavyweight Disc Rolls
Non-Vacuum

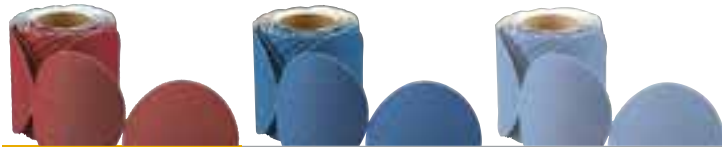

				TIER: BEST	BETTER	BETTER
				TRADENAME: SG H920	BLUEFIRE H822	BLUEFIRE H875P
				ABRASIVE: Ceramic Alumina	Zirconia Alumina	Zirconia Alumina
				PAPER BACKING WEIGHT: F-Weight	F-Weight	E-Weight
				FASTENING: PSA	PSA	PSA
SIZE	GRIT	ROLLS/STD. PKG.	DISCS/ ROLL	PART #	PART #	PART #
5	60	4	100	662611 49873	662611 37310	
	80	4	100	662611 49872	662611 37309	662611 24977
	100	4	100	662611 49871	662611 37308	
	120	4	100	662611 49870	662611 37307	
6	60	4	100		662611 37323	
	80	4	100	662611 49876	662611 37322	662611 25573
	120	4	100	662611 49874		
8	100	4	50	662611 49879		
	120	4	50		662611 37333	

Refer to the Sanding Accessories section for back-up pads and accessories.

Heavyweight Paper Discs

Stick & Sand (PSA)
Individual Discs
Non-Vacuum and Vacuum



TIER:	BETTER	BETTER
TRADENAME:	BLUEFIRE H875P	BLUEFIRE H875P
ABRASIVE:	Zirconia Alumina	Zirconia Alumina
PAPER BACKING WEIGHT:	E-Weight	E-Weight
FASTENING:	PSA	PSA Vacuum

SIZE	GRIT	PKG./CASE	PART #	PART #
5	36	50/200	662611 25436	
	40	50/200	662611 25307	
	80	50/200	662611 25244	

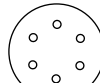

6" x 6 Hole
Die #3371

6	36	50/200	662611 23575	
	40	50/200	662611 23574	662611 23580
	80	50/200	662611 23573	

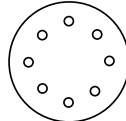

8" x 8 Hole
Die #3370

8	36	25/100	662611 23578	662611 23584
	40	25/100	662611 23577	
	80	25/100	662611 23576	662611 23582

Hook & Loop
Individual Discs
Non-Vacuum and Vacuum



TIER:	BEST	BETTER	BETTER
TRADENAME:	SG H920	BLUEFIRE H875P	BLUEFIRE H875P
ABRASIVE:	Ceramic Alumina	Zirconia Alumina	Zirconia Alumina
PAPER BACKING WEIGHT:	F-Weight	E-Weight	E-Weight
FASTENING:	Hook & Loop	Hook & Loop	Hook & Loop
OTHER:			Vacuum

SIZE	GRIT	PKG./CASE	PART #	PART #	PART #
5	40	25/100		662611 25684	
	60	50/250	662611 49864		
	80	50/250	662611 49865	662611 25444*	
	100	50/250	662611 49866		
	120	50/250	662611 49867		
6	36	25/100		662611 23590	
	40	25/100		662611 23589	
	80	25/100		662611 23588	

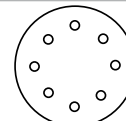

8" x 8 Hole
Die #3370

8	36	25/100		662611 23593	662611 23598
	40	25/100		662611 23592	
	80	25/100		662611 23591	662611 23596

Packaging Standards: Min. / Std. Pkg. * H875P = 25/100

Lightweight Paper Discs

Less dust; more productivity



MULTI-AIR CYCLONIC HOOK & LOOP VACUUM

- Multi-Air Cyclonic precision laser-cut, spiral vacuum hole design maximizes dust extraction for cleanest work environment and less potential for contamination, while delivering coolest, fastest, most consistent cut rate, and longest life of any paper disc
- Water-based, non-pigmented stearate No-Fil coating and open coat provide maximum load resistance and no color transfer to work
- Exceptional choice for the most demanding paper disc sanding applications; hook and loop back for easy disc mounting and changing



TIER:	BEST	BEST
TRADENAME:	BLAZE A995 NO-FIL	DRY ICE A975 NO-FIL
ABRASIVE:	Ceramic Alumina	Ceramic Alumina
PAPER BACKING WEIGHT:	C- & D-Weight	B- & C-Weight
FASTENING:	Hook & Loop	Hook & Loop
OTHER:	P-Graded	P-Graded



SIZE	GRIT	PKG/CASE	PART #	PART #
3 x 0	80	50/200		776960 95005
	120	50/200		776960 95006
	150	50/200		776960 95007
	180	50/200		776960 95008
	220	50/200		776960 95009
	240	50/200		776960 95010
	320	50/200		776960 95011
	400	50/200		776960 95012
	500	50/200		776960 95013
	600	50/200		776960 95014
5 x 11/16 (125mm x 18mm)	800	50/200		776960 95015
	1000	50/200		776960 95016
	80	50/200	636425 97500	776960 07745
	120	50/200	636425 97501	776960 07753
	150	50/200	636425 97502	776960 07755
	180	50/200	636425 97503	776960 07756
	220	50/200	636425 97504	776960 07757
	240	50/200		776960 07760
	280	50/200		776960 07762
	320	50/200		776960 07763
6 x 11/16 (150mm x 18mm)	400	50/200		776960 07765
	500	50/200		776960 07768
	600	50/200		776960 07791
	800	50/200		776960 07793
	1000	50/200		776960 07795
	80	50/200	636425 97505	776960 07770
	120	50/200	636425 97506	776960 07773
	150	50/200	636425 97507	776960 07774
	180	50/200	636425 97508	776960 07775
	220	50/200	636425 97509	776960 07776
240	50/200		776960 07777	
280	50/200		776960 07778	
320	50/200		776960 07781	
400	50/200		776960 07784	
500	50/200		776960 07785	
600	50/200		776960 07786	
800	50/200		776960 07787	
1000	50/200		776960 07788	

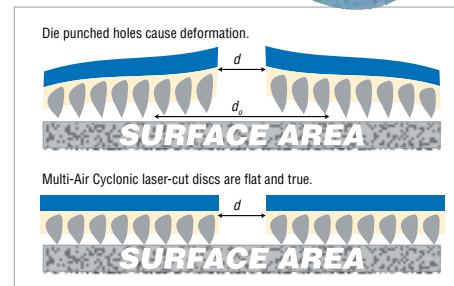

Improved Dust Extraction / Increased Productivity

The upgrade to precise, flat, laser-cut holes instead of die-punched holes, dramatically increases surface area contact allowing Norton Multi-Air Cyclonic discs to improve productivity by 32% versus conventional multi-hole sanding and by 60% versus non-vacuum sanding.

The end result is more holes for dust extraction, more abrasive coverage for a better cut and no deformation – for full surface contact utilizing all the cutting power of the premium ceramic grain.

Refer to the Sanding Accessories section for back-up pads and accessories.

Lightweight Paper Discs



Best choice for the most demanding coarse grit stripping, blending, and sanding applications

BLAZE A995 NO-FIL CERAMIC ALUMINA

- P-graded, next-generation sharper-edged ceramic aluminum oxide abrasive ensures fastest cut rate and longest life of any paper disc
- Unique polyester-reinforced, D-weight latex saturated backing provides maximum tear strength while retaining flexibility
- Water-based, non-pigmented stearate No-Fil coating and open coat provide maximum load resistance and no color transfer to work



Best choice for the most demanding sanding applications

DRYICE A975 NO-FIL CERAMIC ALUMINA

- P-graded seeded-gel ceramic alumina abrasive for fastest cut rate and longest life of any paper disc
- Unique fiber reinforced, flexible B or C-weight latex saturated backing delivers 50% - 60% improvement in tear strength while retaining flexibility
- Water-based, non-pigmented stearate No-Fil coating and open coat provide maximum load resistance and no color transfer to work



Better choice for high-performance dry finishing on all materials

A2750P NO-FIL ALUMINUM OXIDE

- Premium P-graded, heat treated, toughened aluminum oxide abrasive delivers superior life, fast cut rate, consistent finish
- Unique fiber reinforced, flexible B-weight latex saturated backing provides 50% - 60% improvement in tear strength while retaining flexibility
- Water-based, non-pigmented stearate No-Fil coating and open coat provide maximum load resistance and no color transfer to work
- 5" and 6" individual PSA discs in fine grits have a tabbed, white translucent liner to protect the PSA adhesive from airborne contaminants; the tab allows easier removal of the paper liner



Better choice for hard-to-sand surfaces and wood applications

DURITE A475 NO-FIL SILICON CARBIDE

- Sharp and hard, P-graded, silicon carbide abrasive easily penetrates the hardest material and veneers to create finer finishes where finish is critical
- Flexible, B-weight fiber reinforced, latex paper backing provides flexibility and resistance to tearing
- Water-based, non-pigmented stearate No-Fil coating and open coat provide maximum load resistance and no color transfer to work



Good choice for sanding a broad range of substrates including primed or painted surfaces, wood, composites, aluminum, and ferrous metals

GOLD RESERVE A296 NO-FIL ALUMINUM OXIDE

- P-graded premium aluminum oxide abrasive produces a quick, cool cut and a more consistent surface finish
- Strong B-weight latex/paper backing resists tearing while staying conformable and flexible
- Water-based, non-loading (No-Fil) stearate coating minimizes clogging and increases disc life

Lightweight Paper Discs

Stick & Sand (PSA)
Lightweight Disc Rolls
Non-Vacuum



TIER:	BEST	BETTER	BETTER	GOOD	GOOD
TRADENAME:	DRYICE A975 NO-FIL	A2750P NO-FIL	DURITE A475 NO-FIL	GOLD RESERVE A296 NO-FIL	A290 NO-FIL
ABRASIVE:	Ceramic Alumina	Aluminum Oxide	Silicon Carbide	Aluminum Oxide	Aluminum Oxide
PAPER BACKING WEIGHT:	B- & C-Weight	B-Weight	B-Weight	B-Weight	C-Weight
FASTENING:	PSA	PSA	PSA	PSA	PSA
OTHER:	P-Graded	P-Graded	P-Graded	P-Graded	P-Graded

SIZE	GRIT	ROLLS/ STD. PKG.	DISCS/ ROLL	PART #	PART #	PART #	PART #	PART #
3-1/2	80	4	100		662611 36376			
	120	4	100		662611 36375			
	180	4	100		662611 36373			
	220	4	100		662611 36372			
	280	4	100		662611 36370			
	320	4	100		662611 36369			
	400	4	100		662611 36368			
5	60	4	100					662611 49831
	80	4	100	662611 40502	662611 131464 *	662544 87415	662611 183806	662611 49830
	100	4	100	662611 40501	662611 131463 *	662544 87417	662611 183807	662611 49829
	120	4	100	662611 40500	662611 131462 *	662544 87418	662611 183808	662611 49828
	150	4	100	662611 40499	662611 131461 *	662544 87440	662611 183809	662611 49827
	180	4	100	662611 40498	662611 131460 *	662544 87441	662611 183810	662611 49826
	220	4	100	662611 42474	662611 131459 *	662544 87442	662611 183811	662611 49825
	240	4	100	662611 55380	662611 131458 *	662544 87443		662611 49824
	280	4	100	662611 55379	662611 131457 *			662611 49823
	320	4	100	662611 55378	662611 131456 *	662544 87444	662611 183813	662611 49822
	400	4	100	662611 55377	662611 131454 *	662610 65293	662611 183814	662611 49821
	500	4	100		662611 131453 *			
	600	4	100	666233 05608	662611 131452 *	662544 21217		
	800	4	100	662544 80230	662611 131451 *			
6	60	4	100					662611 49847
	80	4	100	662611 40512	662611 131481 *	662544 87446	662611 183815	662611 49842
	100	4	100	662611 40511	662611 131480 *		662611 183816	662611 49841
	120	4	100	662611 40510	662611 131479 *	662544 87447	662611 183817	662611 49840
	150	4	100	662611 40509	662611 131478 *		662611 183818	662611 49839
	180	4	100	662611 40508	662611 131477 *	662544 87448	662611 183819	662611 49838
	220	4	100	662611 48340	662611 131476 *	662544 87449	662611 183820	662611 49837
	240	4	100	662611 55376	662611 131475 *		662611 183821	662611 49836
	280	4	100		662611 131474 *			662611 49835
	320	4	100	662611 55374	662611 131473 *	662544 87450	662611 183822	662611 49834
	400	4	100	662611 55373	662611 131471 *		662611 183823	662611 49833
	500	4	100	636425 06198	662611 131470 *			
	600	4	100	636425 06199	662611 131469 *		662610 40261	
	800	4	100	636425 06200	662611 131468 *		636425 06164	
8	80	4	100		662611 131617			
	120	4	100		662611 131615			
	150	4	100		662611 131614			
	180	4	100		662611 131613			
	220	4	100		662611 131612			
320	4	100		662611 131609				

* Packaging Standards A275 = 6/100

Refer to the Sanding Accessories section for back-up pads and accessories.

Lightweight Paper Discs

Stick & Sand (PSA)
Lightweight Disc Rolls
Vacuum



TIER: **BETTER**
 TRADENAME: **A2750P NO-FIL**
 ABRASIVE: Aluminum Oxide
 PAPER BACKING WEIGHT: B-Weight
 FASTENING: PSA
 OTHER: P-Graded





TIER: **GOOD**
 TRADENAME: **A290 NO-FIL**
 ABRASIVE: Aluminum Oxide
 C-Weight
 PSA
 P-Graded



Stick & Sand (PSA)
Individual Discs
Non-Vacuum



TIER: **BETTER**
 TRADENAME: **A2750P NO-FIL**
 ABRASIVE: Aluminum Oxide
 PAPER BACKING WEIGHT: B-Weight
 FASTENING: PSA Tabbed
 OTHER: P-Graded

SIZE	GRIT	ROLLS/ STD. PKG.	DISCS/ ROLL	PART #	ROLLS/ STD. PKG.	DISCS/ ROLL	PART #	
								
				5" x 5 Hole Die #3329				
								
				5" x 5 Hole Die #3329				
5	60				4	100	662611 30266	
	80	6	100	662611 31498	4	100	662611 30265	
	100	6	100	662611 31497				
	120	6	100	662611 31496	4	100	662611 30263	
	150	6	100	662611 31495	4	100	662611 30262	
	180	6	100	662611 31494	4	100	662611 30261	
	220	6	100	662611 31493	4	100	662611 30260	
	240	6	100	662611 31492				
	320	6	100	662611 31490	4	100	662611 30258	
	400	6	100	662611 31488				

SIZE	GRIT	MIN./ STD PKG.	PART #
5	1000	100/400	662611 31450
	1200	100/400	662611 31449
6	1000	100/400	662611 31467
	1200	100/400	662611 31466
	1500	100/400	662611 31465

SIZE	GRIT	ROLLS/ STD. PKG.	DISCS/ ROLL	PART #	ROLLS/ STD. PKG.	DISCS/ ROLL	PART #	
								
				6" x 6 Hole Die #3333				
								
				6" x 6 Hole Die #3333				
6	80	6	100	662611 31515	4	100	662611 30276	
	100	6	100	662611 31514	4	100	662611 30275	
	120	6	100	662611 31513	4	100	662611 30274	
	150	6	100	662611 31512	4	100	662611 30273	
	180	6	100	662611 31511	4	100	662611 30272	
	220	6	100	662611 31510	4	100	662611 30271	
	240	6	100	662611 31509				
	280	6	100	662611 31508				
	320	6	100	662611 31507	4	100	662611 30268	
	400	6	100	662611 31505				
	600	6	100	662611 31503				

Refer to the Sanding Accessories section for back-up pads and accessories.

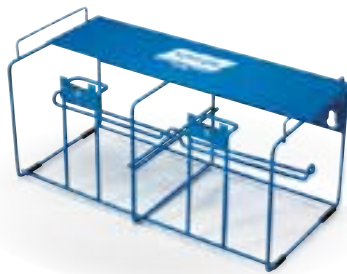

PSA Disc Roll Dispenser

- Norton disc roll dispensers feature heavy-duty construction and a rubberized finish to protect your product, as well as the finish on your workpiece
- These versatile dispensers are designed to accommodate any 5" or 6" disc roll or sheet roll
- They can be attached to a wall or stacked for multi-grit or multi-diameter operations
- Discs are individually dispensed and removed from the roll by a cutter bar

DESCRIPTION	STD. PKG.	PART #
PSA Disc Roll Dispenser		
Single Disc Roll Dispenser	1	636425 42772
Double Disc Roll Dispenser (shown)	1	636425 02981

Lightweight Paper Discs

Hook & Loop
Individual Discs
Non-Vacuum



TIER:	BEST	BEST
CAP CODE:	BLAZE A995 NO-FIL	DRY ICE A975 NO-FIL
ABRASIVE:	Ceramic Alumina	Ceramic Alumina
PAPER BACKING WEIGHT:	D-Weight	B- & C-Weight
FASTENING:	Hook & Loop	Hook & Loop
OTHER:	P-Graded	P-Graded

TIER:	BETTER	BETTER	GOOD	GOOD
CAP CODE:	A2750P NO-FIL	DURITE A475 NO-FIL	GOLD RESERVE A296 NO-FIL	A290 NO-FIL
ABRASIVE:	Aluminum Oxide	Silicon Carbide	Aluminum Oxide	Aluminum Oxide
PAPER BACKING WEIGHT:	B-Weight	B-Weight	B-Weight	C-Weight
FASTENING:	Hook & Loop	Hook & Loop	Hook & Loop	Hook & Loop
OTHER:	P-Graded	P-Graded	P-Graded	P-Graded

SIZE	GRIT	PKG/CASE	PART #	PART #	PKG/CASE	PART #	PART #	PART #	PART #
3	80				50/200	662611 31532			
	100				50/200	662611 44926			
	120				50/200	662611 28688			
	150				50/200	662611 40385			
	180				50/200	662611 31528			
	220				50/200	662611 31527			
	240				50/200	662611 31526			
	320				50/200	662611 31524			
	400				50/200	662611 36995			
	500				50/200	662611 31521			
	600				50/200	662611 36996			
	800				50/200	662611 31519			
	1000				50/200	662611 35900			
	1500				50/200	662611 47434			
	5	60				100/400			
80		50/200		662611 40522	100/400	662611 31549		666233 77539	662611 49907
100		50/200		662611 40521	100/400	662611 31548			662611 49906
120		50/200		662611 40520	100/400	662611 31547		666233 77541	662611 49905
150		50/200		662611 40519	100/400	662611 31546		666233 77542	662611 49904
180		50/200		662611 40518	100/400	662611 31545		666233 77543	662611 49903
220		50/200		662611 49541	100/400	662611 31544		666233 05637	662611 49902
240		50/200		662611 49540	100/400	662611 31543			
280					100/400	662611 31542			
320		50/200		662611 49538	100/400	662611 31541		666233 05638	662611 49900
400		50/200		662611 49537	100/400	662611 31539	662610 52270	666233 05639	662611 49899
500		50/200		662544 80233	100/400	662611 31538			
600					100/400	662611 31537		662611 105390	
800		50/200		662544 80232	100/400	662611 31536	662610 52267	666233 77544	
1000					100/400	662611 31535	662610 52254		
1200				100/400	662611 31534				
1500				100/400	662611 31533				
6	80	50/200	636425 97510	662611 40532	100/400	662611 31566		636425 06236*	662611 49916
	100	50/200		662611 40531	100/400	662611 31565		636425 06235*	662611 49915
	120	50/200	636425 97511	662611 40530	100/400	662611 31564		636425 06234*	662611 49914
	150	50/200	636425 97512	662611 40529	100/400	662611 31563		636425 06233*	662611 49913
	180	50/200	636425 97513	662611 40528	100/400	662611 31562		636425 06232*	662611 49912
	220	50/200	636425 97514	662611 49546	100/400	662611 31561		636425 06231*	662611 49911
	240				100/400	662611 31560		636425 06225*	
	280				100/400	662611 31559			
	320	50/200		662611 49543	100/400	662611 31558		636425 06230*	662611 49909
	400	50/200		662611 49542	100/400	662611 31556		636425 06229*	662611 49908
	500	50/200		636425 06202	100/400	662611 31555		636425 06228*	
	600	50/200		636425 06203	100/400	662611 31554		636425 06227*	
	800	50/200		636425 06204	100/400	662611 31553		636425 06226*	
	1000	50/200		636425 06375	100/400	662611 31552	662610 52255		
	1200	50/200		636425 06376	100/400	662611 31551			
1500	50/200		636425 06377	100/400	662611 31550				
8	120				100/400	662611 31662			
	180				100/400	662611 31661			

Packaging Standards: PKG/CASE A296 = 50/250

Refer to the Sanding Accessories section for back-up pads and accessories.

Lightweight Paper Discs

Hook & Loop
Individual Discs
Vacuum



		BEST		BETTER		GOOD		GOOD		GOOD	
		DRY ICE A975 NO-FIL		A2750P NO-FIL		GOLD RESERVE A296 NO-FIL		A290 NO-FIL		A290 NO-FIL	
		Ceramic Alumina		Aluminum Oxide		Aluminum Oxide		Aluminum Oxide		Aluminum Oxide	
		B- & C-Weight		B-Weight		B-weight		C-Weight		C-Weight	
		Hook & Loop		Hook & Loop		Hook & Loop		Hook & Loop		Hook & Loop	
		P-Graded		P-Graded		P-Graded		P-Graded		P-Graded	
SIZE	GRIT	PKG./CASE	PART #	PART #	PART #	PART #	PART #	PART #	PART #	PART #	PART #
5	60	100/400					662611 30236*	662611 30245*			
	80	100/400	662611 40517*	662611 31583			662611 30235*	662611 30244*			
	100	100/400		662611 31582			662611 30234*	662611 30243*			
	120	100/400	662611 40515*	662611 31581			662611 30233*	662611 30242*			
	150	100/400		662611 31580			662611 30232*	662611 30241*			
	180	100/400		662611 31579			662611 30231*	662611 30240*			
	220	100/400		662611 31578			662611 30230*	662611 30239*			
	320	100/400		662611 31575			662611 30227*	662611 30238*			
	400	100/400		662611 31573			662611 30226*				
	600	100/400		662611 31571							
6	80	100/400	662611 40527*	662611 31600			666233 34786*	662611 30255*			
	100	100/400		662611 31599			666233 34787*				
	120	100/400		662611 31598			666233 34788*	662611 30253*			
	150	100/400		662611 31597							
	180	100/400		662611 31596			666233 34790*	662611 30251*			
	220	100/400		662611 31595			666233 34791*	662611 30250*			
	280	100/400		662611 31593							
	320	100/400		662611 31592			666233 34793*				
	400	100/400		662611 31590			666233 34794*				
	600	100/400		662611 31588			666233 34796*				
	800	100/400		662611 31587			666233 34797*				
	1000	100/400		662611 31586							
	1500	100/400		662611 31584							

Packaging Standards: * A975 Vacuum, A296 Vacuum, A290 Vacuum = 50/200

Refer to the Sanding Accessories section for back-up pads and accessories.



NEW

An alternative to traditional perforated paper discs, mesh discs are a multi-functional abrasive, designed with thousands of holes, created by the unique mesh matrix structure. For use with random orbital and rotary sanders, superior performing mesh discs are engineered for maximum dust extraction on composite, automotive, and other fine finishing applications. Norton mesh discs produce superior finishes with virtually dust free sanding.

- Applications:** Surface preparation, Sanding, Finishing
- Size Range:** 5", 6"
- Grit Range:** 80-400
- Machine Used:**



ORBITAL SANDER

Powerful Dust Extraction Means a Cleaner, Safer Work Environment

We've answered the demands for a cleaner and safer working environment with Norton MeshPower discs. The open construction of the mesh backing allows dust particles to flow freely through the thousands of tiny holes, creating a virtually dust free sanding environment. Better for your health, better for your application and better for your business!

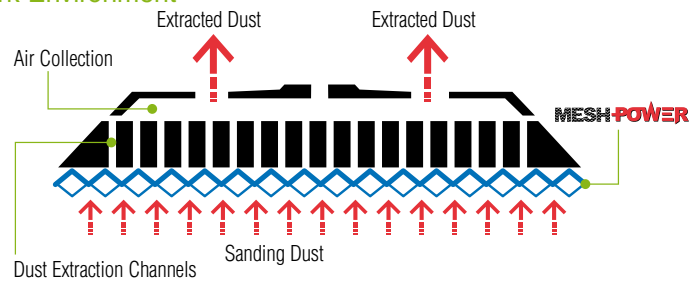

NEW

Good choice for sharp cutting along with powerful dust extraction

MESHPower ALUMINUM OXIDE

- Mesh matrix backing with thousands of tiny holes offers powerful dust extraction for a cleaner, healthier working environment
- Norton No-Fil technology prevents clogging and creates a consistent cut throughout the product life
- Self-grip backing with no designated hole pattern is quick and easy to align to any backing pad – just apply and go!

TIER: **GOOD**
 TRADENAME: **MESHPower**
 ABRASIVE: Aluminum Oxide

SIZE	GRIT	PKG./CASE	PART #
5	80	50/200	636425 06451
	120	50/200	636425 06452
	180	50/200	636425 06453
	220	50/200	636425 06454
	240	50/200	636425 06455
	320	50/200	636425 06456
6	400	50/200	636425 06457
	80	50/200	636425 06458
	120	50/200	636425 06459
	180	50/200	636425 06460
	220	50/200	636425 06461
	240	50/200	636425 06462
	320	50/200	636425 06463
	400	50/200	636425 06464

Contact your Norton representative for more information on additional grit sizes.

TECH TIP

Increase performance even further by using the Norton MeshPower discs with the Norton Multi-Air back-up pads - it's the ultimate dust extraction experience!



For use on random orbital and rotary sanders. The industry's highest performing film and foam finishing discs are engineered for composite, automotive, and other fine finishing applications. Norton microfinishing film discs produce superior finishes dry without sacrificing cut rate while Norton foam finishing discs are used moist to produce a semi-polished surface to reduce buffing time.

Applications:

Film discs: final dry finishing of primed and painted surfaces, varnishes, composites, and gel coats before buffing

Foam finishing discs: final moist finishing of clear coat, varnishes, composites, and gel coats before buffing

Compounds and buffing pads: removes swirl marks and sand scratches

Size Range:

3", 5" and 6"

Grit Range:

Film Discs: P80-P1500

Foam Discs: P1500, P2000, P3000

Machine Used:



ORBITAL SANDER



VERTICAL SHAFT PORTABLE GRINDER



MINI ANGLE SANDER

Finishing Film

Best choice for final dry finishing of primed and painted surfaces, varnishes, composites, and gel coats



PURE ICE Q175 A/O FINISHING FILM

- White aluminum oxide grain and patented resin system for better life, cut rate, and finish
- 3 mil polyester film backing for better flexibility and flatness of discs; hook and loop attachment for easy mounting and removal
- Color-coded backprint by grit size

Good choice for dry sanding applications, especially uneven, hard-to-sand surfaces



Q275 NO-FIL A/O FINISHING FILM

- Sharp, P-graded, heat-treated premium aluminum oxide grain ensures faster, yet cooler, cut for a longer life
- 3-mil polyester film backing delivers unmatched durability and tear strength with exceptional flatness for a flawless surface finish and reduced leveling and rework; hook and loop attachment for easy mounting and removal
- Water-based stearated No-Fil coating provides maximum load resistance when sanding dry for extended life

Finishing Foam

Best choice for moist finishing of clear coats, varnishes, composites, and gel coats



ICE Q255 A/O FINISHING FOAM

- Premium, P-graded fine grit aluminum oxide grain
- Conformable, integrated foam backing eliminates pigtails and costly rework; produces a semi-polished finished that can be quickly buffed out; hook and loop attachment
- Open mesh design distributes pressure evenly for quicker sanding and uniform scratch patterns
- Color coded abrasive face by grit size for easy grit identification



TIER:	BEST	GOOD
TRADENAME:	PURE ICE Q175	Q275 NO-FIL
ABRASIVE:	Aluminum Oxide	Aluminum Oxide
BACKING WEIGHT:	3 mil Polyester Film	3 mil Polyester Film
OTHER:	P-Graded	P-Graded

TIER:	BEST
TRADENAME:	ICE Q255
ABRASIVE:	Aluminum Oxide
BACKING WEIGHT:	Foam
OTHER:	P-Graded

SIZE	GRIT	PKG./CASE	COLOR	PART #	PART #	PKG./CASE	COLOR	PART #
3	P800	50/200	Black	776960 88701				
	P1000	50/200	Red	776960 88702				
	P1200	50/200	Green	776960 88703				
	P1500	50/200	Blue	776960 88704		6/24	Blue	636425 06022
	P2000					6/24	Magenta	636425 06021
	P3000					6/24	Green	636425 06020
5	P80	50/200			662611 01614			
	P120	50/200			662611 01613			
	P180	50/200			662611 01610			
	P220	50/200			662611 01609			
	P240	50/200			662611 01608			
	P320	50/200			662611 01607			
	P400	50/200			662611 01606			
	P600	50/200			662611 01604			
	P1200	50/200			662611 01601			
6	P80	50/200			662611 01628			
	P120	50/200			662611 01627			
	P180	50/200			662611 01625			
	P220	50/200			662611 01624			
	P320	50/200			662611 01622			
	P800	50/200	Black	776960 88713	662611 01618			
	P1000	50/200	Red	776960 88714	662611 01617			
	P1200	50/200	Green	776960 88715	662611 01616			
	P1500	50/200	Blue	776960 88716	662611 01615	15/60	Blue	636425 06015
	P2000					15/60	Magenta	636425 06014
	P3000					15/60	Green	636425 06013

Refer to the Sanding Accessories section for back-up pads and accessories.



Norton flexible diamond coated discs combine the durability and aggressiveness of diamond, on a flexible backing.

Applications:

Grinding ceramic, glass, composites, carbide and ceramic coatings, fiberglass, and reinforced plastics; removing rust and scale on other materials; producing metallurgical stamps and coupons

Size Range:

PSA (Pressure Sensitive Adhesive) Discs: 2" – 6"

Quick-Change TR (Type III) Discs: 2" and 3"

Grit Range:

60 – 1500

Abrasive Types:

Diamond

Backing Color:

Color-coded backings for easily distinguished grit size selection

Machine Used:



ORBITAL SANDER



VERTICAL SHAFT PORTABLE GRINDER

Better choice for grinding glass, ceramics and composites, removing rust and scale, and producing metallurgical stamps and coupons

D71S PSA DISCS

- Combines the durability and aggressiveness of a unique diamond abrasive face pattern with a flexible backing, to significantly increase life and lower costs versus standard coated and diamond discs
- Cloth backing provides strength, tear resistance, and flexibility
- Color-coded, PSA backing for quick, easy mounting and removal and identification of coarse grit sizes/applications

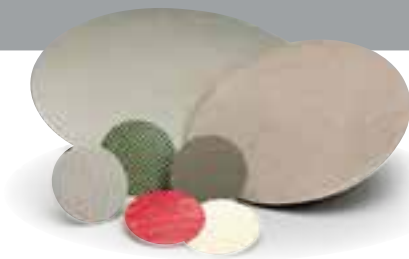

SIZE (D)	COLOR	GRIT	STD. PKG.	TIER: BETTER	
				PART #	
Flexible Diamond Coated PSA Discs					
2	Green	60	1	662603	08159
	Black	120	1	662603	07722
	Red	200	1	662603	07723
	Yellow	400	1	662603	08160
	White	800	1	662603	07012
5	Green	60	1	662603	07839
	Black	120	1	662603	07838
	Red	200	1	662603	07019
	Yellow	400	1	662603	07960

SIZE (D)	COLOR	GRIT	STD. PKG.	TIER: BETTER	
				PART #	
Flexible Diamond Coated PSA Discs					
6	Green	60	1	662603	06381
	Black	120	1	662603	06382

See Page 70 – Coated Abrasive Cloth PSA Disc section for back-up pads.

Better choice for improved cut rate and finish on ceramics, glass, fiberglass, composites, carbide, and other tough metals and coatings

D7210 QUICK-CHANGE TR (TYPE III) DISCS

- Unique, durable diamond abrasive pattern increases life and lowers costs versus standard coated and diamond discs; color-coded backing for easy grit/application identification
- Better choice for improved cut rate and finish on ceramics, glass, fiberglass, composites, carbide, and other tough metals and coatings
- Removes rust and scale on other material; producing metallurgical stamps and coupons

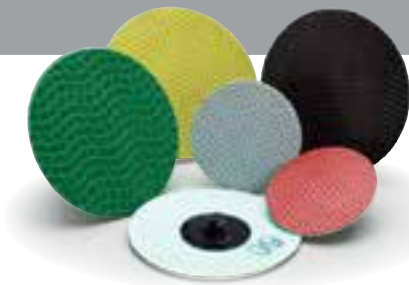

SIZE (D)	COLOR	GRIT	STD. PKG.	TIER: BETTER	
				PART #	
Flexible Diamond Coated Quick-Change TR (Type III) Discs					
2	Green	60	12	662603	11778
	Black	120	12	662603	11779
	Red	200	12	662603	11780
	Yellow	400	12	662603	11781
	White	800	12	662603	11782

SIZE (D)	COLOR	GRIT	STD. PKG.	TIER: BETTER	
				PART #	
Flexible Diamond Coated Quick-Change TR (Type III) Discs					
3	Green	60	12	662603	11783
	Black	120	12	662603	11784
	Yellow	400	12	662603	11786

See Page 147 – Quick-Change Disc Accessories section for back-up pads.

Multi-Air Foam Interface Pads

- Designed for use with fine grit Multi-Air Cyclonic hook and loop sanding discs to improve both surface finish and cut rate
- Use with Multi-Air hook and loop disc back-up pads
- Align the interface pad with the Multi-Air back up pad then simply attach the disc to the interface pad because the holes do not have to be lined up
- Ideal for use with new Mesh discs



SIZE (D x T)	DESCRIPTION	STD. PKG.	PART #
Multi-Air Foam Interface Pads with Vacuum Holes			
5 x 1/2	Multi-Air Hook & Loop Interface Pad	8	636425 85864
6 x 1/2	Multi-Air Hook & Loop Interface Pad	12	076607 19359

Multi-Air Hook & Loop Back-up Pads with Vacuum Holes

- Innovative design optimized for maximum air flow and powerful dust extraction
- Pads are engineered with a durable urethane foam, heat-resistant plastic, a molded-in 5/16"-24 spindle, and hooked face
- Holes in the disc do not have to be matched up with the holes in the pad, so changeover is fast and easy
- Ideal for use with new Mesh discs



SIZE (D)	DESCRIPTION	MAX. RPM	STD. PKG.	PART #
Multi-Air Hook & Loop Back-up Pads with Vacuum Holes				
5" (125mm) with 5/16"-24 Shank	Medium-Density Urethane Pad	15,000	5	666233 76000
6" (150mm) with 5/16"-24 Shank	Medium-Density Urethane Pad	15,000	5	636425 06160

Low-Profile Pads for Dual Action / Random Orbital Sanders

- Soft density low-profile pads utilize 1/2" thick foam for fine finish sanding and offer moderate conformability
- Medium low-profile pads have 1/2" thick urethane foam for intermediate and finish sanding
- Available with PSA (pressure sensitive adhesive) or hook and loop faces; both designs are shock resistant and have a fiberglass backing plate with a riveted 5/16"-24 threaded shank for added strength and increased heat resistance
- Available with standard hole patterns for vacuum-assist sanding



SIZE (D)	DESCRIPTION	MAX. RPM	STD. PKG.	PART #
Low Profile Pads for DA/Random Orbital Sanders				
3	Hook & Loop Soft Low-Profile	12,000	10	636425 06128
3-1/4	Hook & Loop Buffing Pad		5	662610 85302
5	PSA Soft Low-Profile	12,000	5	636425 06126
5	PSA Medium Low-Profile	15,000	5	636425 06131
5 x 5 holes	PSA Medium Low-Profile	15,000	5	636425 06132
5	Hook & Loop Soft Low-Profile	12,000	5	636425 06129
5	Hook & Loop Medium Low-Profile	15,000	5	636425 06135
5 x 5 holes	Hook & Loop Medium Low-Profile	15,000	5	636425 06136
6	PSA Soft Low-Profile	12,000	5	636425 06127
6	PSA Medium Low-Profile	15,000	5	636425 06133
6	Hook & Loop Soft Low-Profile	12,000	5	636425 06130
6	Hook & Loop Medium Low-Profile	15,000	5	636425 06137
6 x 6 holes	Hook & Loop Medium Low-Profile	15,000	5	636425 06138
8 x 8 holes, 5 screws	Hook & Loop Medium Low-Profile	1,500	5	636425 43712
8 x 8 holes, 6 screws	Hook & Loop Medium Low-Profile	1,500	5	636425 43714

Packed in individual clamshell

Tapered Pads for Dual Action / Random Orbital Sanders

- Designed with medium density polyurethane foam and a tapered edge for conformability, these pads are firm enough for flat surfaces, yet soft enough for severe curves and contours
- Available with either PSA (vinyl, pressure sensitive adhesive) or hook and loop faces in vacuum or non-vacuum
- The 5" and 6" pads are shock resistant and have a fiberglass backing plate with a riveted 5/16"-24 threaded shank for use on random orbital or dual action sanders
- The 8" pads have a 5/8"-11 threaded female hub



SIZE (D)	DESCRIPTION	MAX. RPM	STD. PKG.	PART #
Tapered Pads for DA/Random Orbital Sanders				
5	PSA Medium Tapered	15,000	5	636425 06139
5 x 5 holes	PSA Medium Tapered	15,000	5	636425 06140
5	Hook & Loop Medium Tapered	15,000	5	636425 06143
5 x 5 holes	Hook & Loop Medium Tapered	15,000	5	636425 06144
6	PSA Medium Tapered	15,000	5	636425 06141
6 x 6 holes	PSA Medium Tapered	15,000	5	636425 06142
6	Hook & Loop Medium Tapered	15,000	5	636425 06145
6 x 6 holes	Hook & Loop Medium Tapered	15,000	5	636425 06146
8	PSA Medium Tapered	6,000	5	636425 43112
8	Hook & Loop Medium Tapered	3,200	5	636425 43704

Packed in individual clamshell

Hook & Loop Foam Interface Pads

- Designed for use with our fine grit hook and loop sanding discs
- Improve both surface finish and cut rate
- Use with hook and loop back-up pads



SIZE (D x T)	DESCRIPTION	STD. PKG.	PART #
Foam Hook & Loop Interface Pads			
3 x 1/2	Interface Pad	10	636425 05457
6 x 1/2	Interface Pad	5	636425 42089
5 x 3.4	Interface Pad	2	636425 02161
6 x 3/4	Interface Pad	2	636425 02162

Half Moon Hand Pad

- The unique half moon pad takes a standard 5" hook and loop disc folded in half, which adheres to the hooks on the pad face
- The straight edge of the pad allows the operator to sand corners, contours, narrow crevices and minute imperfections without over-sanding

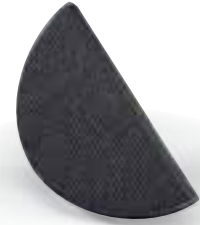

SIZE (D)	DESCRIPTION	STD. PKG.	PART #
Half Moon Hand Pad			
5	Hook & Loop	10	636425 02768

Polishing Adapter Pad

- Converts your standard hook and loop pad into a soft polishing pad
- The foam adapter is 3/8" thick and is excellent for fine grits where minimal removal is required
- It is ideal for either flat or contour surfaces



SIZE	DESCRIPTION	MAX. RPM	STD. PKG.	PART #
Polishing Adapter Pad				
5	Hook & Loop Adapter Pad	3,786	10	636425 03121

Ergonomic Hand Sanders

- The ergonomic palm sander is uniquely designed to be user-friendly, with finger indentations for the operator
- It quickly converts standard 5" and 6" hook and loop discs into hand sanders for finishing flat surfaces



SIZE (D)	DESCRIPTION	STD. PKG.	PART #
Ergonomic Hand Sander			
5	Hook & Loop	5	636425 03147
6	Hook & Loop	5	636425 03726

Disc Hand Pads

- Hand pads eliminate finger sanding
- The ultra-thin 3/16" thick pad is composed of a single layer of neoprene foam and is designed for maximum flexibility – producing excellent finishes
- The 1" thick pad is composed of two layers, neoprene and polyester foam, for excellent conformability and softness, resulting in fine finishes
- Each pad has an elastic hand strap to hold it firmly in place
- Available with either PSA (vinyl, pressure sensitive adhesive) faces or hook and loop face



SIZE (D x T)	DESCRIPTION	STD. PKG.	PART #
Disc Hand Pads			
5 x 3/16	Soft Foam PSA	10	636425 03111
5 x 1	Soft Foam PSA	10	636425 02842
5 x 1	Soft Foam Hook & Loop	10	636425 03117

Panel and Adhesive Cleaner

- Removes adhesives, tar, grease, wax, body sealers, undercoating sprays, and silicone from most surfaces
- Aggressive cleaner is safe to use on most paint applications
- Packaged with squirt dispenser
- Use as directed



SIZE/DESCRIPTION	STD. PKG.	PART #
Panel and Adhesive Cleaner		
Quart Can	12	076607 82780

Liquid Ice Extra-Cut Compound

- Water soluble; easy to use and easy to clean up
- Engineered to be used with a selection of 3 pads, depending on the finish required



SIZE	DESCRIPTION	STD. PKG.	STD. CASE	PART #
Quart	Liquid Ice Extra-Cut Compound	1	4	636425 97116

Liquid Ice Clean-up / Detailer Spray

- The spray detailer easily cleans up excess buffing residue and produces paint protection
- Spray it on and wipe off with a Norton Microfiber cloth ("Masking Products" section)



SIZE	DESCRIPTION	STD. PKG.	STD. CASE	PART #
32 oz.	Spray Bottle Clean-up Detailer	1	4	636425 42082

Liquid Ice Ultra-Fine Machine Glaze

- Use on its own for fine scratch removal or as Step 3 in place of Norton Liquid Ice Extra-Cut Compound to eliminate swirl marks and produce a high gloss finish
- Ideal for dark-colored vehicles



SIZE	DESCRIPTION	STD. PKG.	STD. CASE	PART #
Quart	Liquid Ice Ultra-Fine Machine Glaze	1	4	636425 06092

8" Hook & Loop Buffing/Polishing Waffle Pads

- These pads can be used with Norton Liquid Ice Extra-Cut Compound

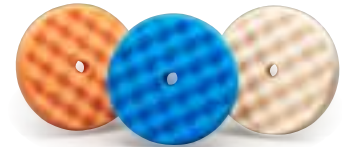

SIZE (D)	DESCRIPTION	STD. PKG.	STD. CASE	PART #
8	Orange Waffle Foam pad - Step 1	1	6	636425 06379
8	Blue Waffle Foam Pad - Step 2	1	6	636425 06380
8	White Waffle Foam Pad - Step 3	1	6	636425 06381

8" and 9" Hook & Loop Buffing/Polishing Pads

- These pads can be used with Norton Liquid Ice Extra-Cut Compound following the step numbers



SIZE (D)	DESCRIPTION	STD. PKG.	STD. CASE	PART #
8	Super Cut Wool Pad - Step 1	1	6	636425 42077
9	Blue Cutting Foam Pad - Step 2	1	6	636425 42078
9	White Finishing Foam Pad - Step 3	1	6	636425 42079

3" Hook & Loop Buffing/Polishing Pads

- For small spot repair



SIZE (D)	DESCRIPTION	STD. PKG.	STD. CASE	PART #
3	Super Cut Wool Pad - Step 1	10	40	636425 43832
3	Blue Cutting Foam Pad - Step 2	10	40	636425 05459
3	White Finishing Foam Pad - Step 3	10	40	636425 05460

Hook & Loop Back-up Pads for 8" and 9" Buffing Pads

- Black plastic back-up plate with hook and loop face. Molded-in 5/8"-11 threaded female hub



SIZE (D)	DESCRIPTION	STD. PKG.	STD. CASE	PART #
8 and 9	Hook & Loop Back-up Pad	1	3	636425 42080

Black Lambswool Hook & Loop Polishing Pads

- Distributing and applying material evenly and consistently, these dense, durable, lambswool pads are designed to repair clearcoat finishes



SIZE	DESCRIPTION	STD. CASE	PART #
3	Pad with Loop - 3/4" nap	40	636425 03670
4	Pad with Loop - 3/4" nap	250	636425 03671



Made from non-woven synthetic fiber mesh, which is impregnated with abrasives and bound with resins, non-woven wheels are designed to create desired surface finish where little or no stock removal is required. Non-woven wheels have an open mesh construction that is waterproof, washable, conformable and non-loading.

Non-Woven Convolute wheels are formed by wrapping and bonding web material impregnated with abrasive grain and resin around a center core.

Applications:

- Burr and flashing removal
- Surface roughness reduction
- Blending weld areas on stainless steel
- Blending scratch patterns
- Weld polishing
- Removing rust and oxides
- Applying decorative finishes including antique patterns

Abrasive Grain:

Aluminum Oxide, Silicon Carbide

Grit Range:

Medium (M), Fine (F), Very Fine (VF)

Machine Used:



BENCH GRINDER



PEDESTAL GRINDER

Application/Grit Recommendation Guide

NORTON	Rapid Finish GP Convolute Wheels	Metal Finishing Convolute Wheels	Clean & Finish Convolute Wheels	Light Finishing Convolute Wheels
Scale Removal				
Stock Removal	Second Choice			
Heavy Deburring	Second Choice			
Decorative Finishing		Best Choice	Second Choice	
Blending	Best Choice	Second Choice		
Cleaning		Second Choice	Best Choice	
Light Deburring	Second Choice			Best Choice
Light Finishing	Second Choice			Best Choice
Polishing				Best Choice
Buffing				

Surface Finish Variables

Changes in any one of many factors can affect the surface finish on the workpiece. This chart shows the effect on surface finish by changes in single factors of product specifications. Arrows have been used to signify the trend direction. The arrow length does not signify that the effect of each factor is equal.

Variable Factor	Rough Finish High RMS Reading	Smooth Surface Lower RMS Reading
1. Wheel Speed	Slow ←	→ Fast
2. Feed Speed	Faster (Long Scratch) ←	→ Slower (Short Scratch)
3. Oscillation	No Oscillation ←	→ Oscillation
4. Lubricants	Dry ←	→ Water ← → Soluble Oil ← → Straight Oil
		← → Compounds →

Non-Woven Marking System

ABRASIVE	SILICON CARBIDE	ALUMINUM OXIDE		
	← SHARPER, FINER/BRIGHTER SCRATCH PATTERN	→ MORE DURABLE, LONGER LASTING, POLISHED FINISH		
GRIT SIZE	XC (50)	C (60-80)	M (100-150)	F (180-220)
	← FASTER, AGGRESSIVE CUT, ROUGHER FINISH	→ REDUCED CUT RATE, FINER FINISH		
DENSITY	2	9		
	← SOFT, OPEN, CONFORMABLE, LESS BURNING/LOADING	→ HARDER, MORE DURABLE, FASTER CUTTING, BETTER FINISH		

Cross Reference Guide

NORTON	BEST	BETTER	BETTER	GOOD	GOOD	GOOD
3M	Rapid Finish P 3M EXL, General Purpose	Series 1000 EXL Deburring	Metal Finishing Metal Finishing	Series 4000 EX2 & EX3	Light Finishing Light Deburring	Clean & Finish Multi Finishing
Standard	General Purpose Plus, Light Deburring	Deburring Convolute	Metal Finishing	GP Plus	LDW	Multi Finishing

Aggressive Deburring

Good choice for heavy deburring applications



SERIES 4000 ALUMINUM OXIDE & SILICON CARBIDE

- High-quality synthetic web provides long life for heavy deburring, edge-breaking, and parting line removal on exotic metals
- Advanced resin bond system ensures free cutting action
- Use both wet and dry

TIER: **GOOD**
TRADENAME: **SERIES 4000**

SIZE (D x T x H)	ABRASIVE	GRIT	MAX. RPM	STD. PKG.	8 DENSITY PART #	9 DENSITY PART #
6 x 1/2 x 1	S/C	F	6,000	4		6626100 4021
6 x 1 x 1	A/O	M	6,000	3	6626100 4208	
	S/C	F	6,000	3	6626100 4142	6626100 4141
8 x 1 x 3	A/O	M	4,500	3	6626100 4165	
	S/C	F	4,500	3	6626100 4123	6626100 4135
12 x 1 x 5	S/C	F	3,000	2	6626100 4284	6626100 4148
12 x 2 x 5	S/C	F	3,000	1		6626100 4011

General Duty



Best choice for broad range of applications: general deburring, blending, and finishing on all materials including metals, wood, glass

RAPID FINISH GENERAL PURPOSE A/O & S/C

- Eliminate smearing and loading on a wide range of workpieces (from high-nickel-content alloys to aluminum and other soft metals with patent-pending Norton Clean Bond resin technology)
- Increase throughput with a 30% faster finish through new Norton grain/bond configuration, decrease wheel changes with a 10-30% longer life, provided by a new fiber and the high-temperature resin bond
- Ease wheel selection with color-coding wheel to match the primary use (maroon for General Purpose), and fiberglass core to match the abrasive (black for silicon carbide and white for aluminum oxide)

TIER: **BEST**
TRADENAME: **RAPID FINISH GENERAL PURPOSE**

SIZE (D x T x H)	ABRASIVE	GRIT	MAX. RPM	STD. PKG.	PRODUCT CODE	6 DENSITY PART #	7 DENSITY PART #	8 DENSITY PART #	9 DENSITY PART #
6 x 1/2 x 1	A/O	M	6,000	4	C2315		662611 34177	662611 34178	662611 34179
	S/C	M	6,000	4	C4315				662611 08076
	S/C	F	6,000	4	C4415		662611 33213	662611 06732	662611 12985
6 x 1 x 1	A/O	M	6,000	3	C2315	662611 34180	662611 34181	662611 34182	662611 34183
	A/O	F	6,000	3	C2408	662611 32100	662611 32322	662611 32324	
	S/C	M	6,000	3	C4315		662611 08074	662611 33215	662611 08075
	S/C	F	6,000	3	C4415	662611 14475	662611 19988	636425 77269	636425 81587
	S/C	VF	6,000	3	C4515	662611 31970			
	S/C	M	6,000	2	C2315		662611 34184		
6 x 2 x 1	S/C	M	6,000	2	C4315		662611 14471		
	S/C	F	6,000	2	C4415		662611 32325		
	S/C	M	4,500	3	C4315		662611 08066	662611 08069	
8 x 1 x 3	S/C	F	4,500	3	C4415	662611 08064	662611 08065	636425 53754	636425 76004
	S/C	VF	4,500	3	C4515				662611 33209
	S/C	M	4,500	2	C4315		662611 14473		
8 x 2 x 3	S/C	F	4,500	2	C4415		662611 14480	662611 14483	662611 14486
	S/C	VF	4,500	2	C4515				662611 33210
	A/O	M	3,600	3	C2315		662611 34185		
10 x 1 x 5	S/C	F	3,600	3	C4415			662611 06554	662611 14488
	S/C	F	3,600	1	C4415			636425 81044	662611 14489
12 x 1 x 5	A/O	M	3,000	2	C2315				662611 34186
	S/C	F	3,000	2	C4415	662611 08053	662611 14481	662611 14484	662611 14074
	S/C	VF	3,000	2	C4515				662611 34187
12 x 2 x 5	S/C	F	3,000	1	C4415		662611 14482	662611 12766	662611 14490

General Duty *continued*



Better choice for general deburring, blending, and final finishing

SERIES 1000 LONG LIFE A/O & S/C

- Offered in variety of web densities: more open, cool-cutting 7 density for light deburring, 8 to 9 density a good starting point for deburring, blending, polishing, and finishing
- Smear- and heat-free resin bond guarantees consistent, high-quality results; uniform grain dispersion and coating clean and condition without gouging or changing dimensions of workpiece
- Conformable and flexible for less operator fatigue

TIER: **BETTER**
TRADENAME: **SERIES 1000 LONG LIFE**

SIZE (D x T x H)	ABRASIVE	GRIT	MAX. RPM	STD. PKG.	7 DENSITY PART #	8 DENSITY PART #	9 DENSITY PART #
6 x 1/2 x 1	A/O	M	6,000	4	662610 18857		662610 18650
	S/C	M	6,000	4			662610 19540
	S/C	F	6,000	4	662610 18628		662610 18629
6 x 1 x 1	A/O	M	6,000	3	699573 97884	662610 18636	662610 19337
	S/C	M	6,000	3	699573 97882	699573 97883	662610 18630
	S/C	F	6,000	3	662610 18631	662610 18774	662610 18632
8 x 1 x 3	A/O	M	4,500	3	699573 97885	662610 18855	662610 18633
	S/C	M	4,500	3	699573 94610	662610 18673	662610 18997
	S/C	F	4,500	3	662610 18639	662610 18640	662610 18641
12 x 1 x 5	A/O	M	3,000	2	699573 97887		662610 18896
	S/C	M	3,000	2		662610 18786	662610 18908
	S/C	F	3,000	2			662610 18626

Aesthetic Finishing



Better choice for decorative finishing, blending, and final finishing

METAL FINISHING ALUMINUM OXIDE

- Premium, medium grit aluminum oxide grain generates uniform distinct satin and antique finishes
- Dense, very durable web allows these wheels to be used for blending applications; strong resin binder provides resiliency and long life
- Uniform grain dispersion and coating clean and condition without gouging or changing dimensions of workpiece

TIER: **BETTER**
TRADENAME: **METAL FINISHING**

SIZE (D x T x H)	ABRASIVE	GRIT	DENSITY	MAX. RPM	STD. PKG.	PART #
6 x 1 x 1	A/O	M	5	6,000	3	662610 07936
	A/O	M	6	6,000	3	662610 10148
6 x 2 x 1	A/O	M	5	6,000	2	662610 07957
	A/O	M	6	6,000	2	662610 09635
8 x 1 x 3	A/O	M	5	4,500	3	662610 07831
8 x 2 x 3	A/O	M	5	4,500	2	662610 07904
	A/O	M	6	4,500	2	662610 12971
12 x 1 x 5	A/O	M	5	3,000	2	662610 07434
	A/O	M	6	3,000	2	662610 09481
12 x 2 x 5	A/O	M	5	3,000	1	662610 07212
14 x 2 x 8	A/O	M	5	2,550	1	662610 07817

Aesthetic Finishing *continued*

Good choice for light deburring, polishing, and fine finishing applications



LIGHT FINISHING SILICON CARBIDE

- Advanced manufacturing process produces a consistent web and grain distribution for a consistent finish on intricate polishing applications
- Superior form holding for consistent, reliable edge breaking and finishing with minimal wheel dressing and reshaping; less dust and shedding with more uniform wear
- Controlled cut rate prevents “over benching”, deburrs and polishes without altering geometry

TIER: **GOOD**

TRADENAME: **LIGHT FINISHING**

SIZE (D x T x H)	ABRASIVE	GRIT	MAX. RPM	6 DENSITY PART #	7 DENSITY PART #	8 DENSITY PART #
6 x 1/2 x 1	S/C	F	6,000	662610 92322	662610 92324	662544 21572
6 x 1 x 1	S/C	F	6,000	662544 03708	662544 03709	662544 21573
8 x 1/2 x 3	S/C	F	4,500	662544 03707	662544 09698	662544 21575
8 x 1 x 3	S/C	F	4,500	662610 95702	662544 09924	662544 21577

All Light Finishing convolute wheels are non-stock. Ask your Norton representative for current lead-times and order quantities.

Good choice for fine finishing with light pressure



CLEAN & FINISH SILICON CARBIDE

- Sharp, more aggressive silicon carbide abrasive leaves a fine/brighter scratch pattern
- Conformable to intricate shapes and contours without changing the workpiece dimension
- Open web construction makes these ideal for low-to moderate-pressure, low speed applications

TIER: **GOOD**

TRADENAME: **CLEAN & FINISH**

SIZE (D x T x H)	ABRASIVE	GRIT	DENSITY	MAX. RPM	STD. PKG.	PART #
4 x 1 x 1	S/C	M	4	4,000	10	662610 58502
		F	4	4,000	10	662610 58501
6 x 1 x 1	S/C	M	4	3,000	4	662610 58507
		F	4	3,000	4	662610 58506
6 x 2 x 1	S/C	M	4	3,000	2	662610 58510
		F	4	3,000	2	662610 58509
6 x 3 x 1	S/C	M	4	3,000	1	662610 58512
6 x 4 x 1	S/C	M	4	3,000	1	662610 58514
8 x 1 x 3	S/C	M	4	2,500	3	662610 58518
8 x 2 x 3	S/C	M	4	2,500	2	662610 58521
8 x 3 x 3	S/C	M	4	2,500	1	662610 58524
8 x 4 x 3	S/C	M	4	2,500	1	662610 58526

Aluminum Reducing Bushings for Flap and Convolute Wheels



- Durable, aluminum one-piece-design flanges with integrated contact washer
- Snug fit; extended usable life
- Available in stock and non-stock sizes in many combinations of ID hole reduction

WHEEL CENTER HOLE	BUSHING REDUCES HOLE SIZE TO	FOR WHEEL DIAMETER	STD. PKG.	PART #
1	3/8	4 - 6	1 Pair	662610 80522
	1/2	4 - 6	1 Pair	662610 80523
	5/8	4 - 6	1 Pair	662610 80524
	3/4	4 - 6	1 Pair	662610 80525
2	7/8	4 - 6	1 Pair	662610 80526
	1/2	6	1 Pair	662610 80527
	5/8	6	1 Pair	662610 80528
3	1	6	1 Pair	662610 80529
	1-1/4	8	1 Pair	662610 80531
5	1	8	1 Pair	662610 80532
	1-1/4	10 and 12	1 Pair	662610 80533
	3	10 and 12	1 Pair	662610 80534
8	1-1/4	14	1 Pair	662610 80535

TECH TIP

- Convolute wheels must always run in the direction indicated by the arrow printed on the side of each wheel.
- Light to medium pressure is recommended. Excessive pressure may result in part damage.
- Lubricants such as water-soluble oil and straight oil will decrease the heat and improve the surface finish and lustre.



It is the user's responsibility to refer to and comply with ANSI B7.1

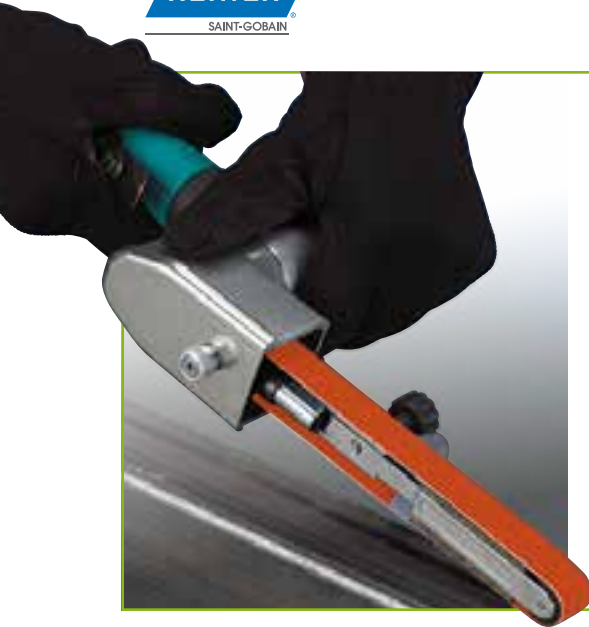

Portable file belt sanders have replaced tedious hand filing and sanding. First introduced in pneumatic, they are now also available in electric. Increasingly, tool manufacturers are introducing additional fixtures for additional applications. The belts listed are popular stock sizes, but additional sizes, specifications, backing materials, and edge scallops are available made-to-order.

Applications:

Light weld removal and blending, shape and contour sanding, surface preparation prior to coating and plating, removing cutting tool marks from molds and dies, general clean-up and finishing

Size Range:

1/8" to 1" wide, 12" to 30" long

Grit Range:

40 – 120

Abrasive Grain:

Ceramic Alumina, Zirconia Alumina, Aluminum Oxide

Machine Used:



PORTABLE FILE BELT SANDER

Cross Reference Guide

	BEST	BEST	BETTER	GOOD	GOOD
NORTON	Blaze R980P	RedHeat R983	BlueFire R887D/R823P	Gemini R766	Gemini R283
3M	963G/H, 966F, 967F, 997F, 984F, 784F, 947A	747D, 777F, 778F, 784F, 987F, 977F	577F, 551E	361F, 363F	241E, 244E, 251E, 261E
Hermes	CR456	—	RB48624YX, RB48644Z	RB377XY, SB378	RB530J, RB304J, RB306J
Klingspor	CS610	CS912	CS411X, CS416, CS409	CS412, CS413	CS412
SIA	2515, 2503	—	2800,2803, 2815, 2829, 2824	—	—
VSM	XK875X, XK885Y, XK880Y	XK870X, XK870X	ZK713X, ZK713T, KK715X	LK719X, KK711X	KK711E
Sait	—	—	AZ-X	1AX, 2AX	LA-X
Sunmght	—	—	—	P656W	—

Material-to-Product Recommendation Guide

	BEST	BEST	BETTER	GOOD	GOOD	
	Blaze R980P	RedHeat R983	BlueFire R887D	BlueFire R823P	Gemini R766	Gemini R283
Carbon Steel	◆	◆	◆	◆	◆	◆
Stainless Steel / Alloys	◆	◆	◆	◆	◆	◆
Cast Iron	◆	◆	◆	◆	◆	◆
Brass / Bronze	◆	◆	◆	◆	◆	◆
Aluminum	◆	◆	◆	◆	◆	◆



Best for stainless, cobalt, chrome, inconel, titanium, mild and carbon steel

BLAZE R980P CERAMIC ALUMINA

- Next-generation cooler cutting Norton SG ceramic alumina grain lasts 50% to 200% longer on mild and carbon steel, stainless, cobalt, chrome, inconel and titanium with better metal integrity
- Durable Y-weight polyester, waterproof cloth backing for improved grain adhesion, reduced edge-fray, and better body retention, resulting in longer life and product consistency
- Lubricating grinding aid coating means cooler cut, burn-free grinding of heat-sensitive materials, minimized loading, and improved part finish and integrity



Exceptional performance, especially on hard-to-grind alloys

REDHEAT R983 CERAMIC ALUMINA

- Premium ceramic abrasive provides sharp cutting, exceptional life and value, especially on hard-to-grind alloys
- "Supersize" grinding-aid for longer life, cooler cut and minimized loading
- Strong Y-weight polyester, waterproof cloth backing for improved grain adhesion, reduced edge-fray and better body retention, resulting in longer life and product consistency

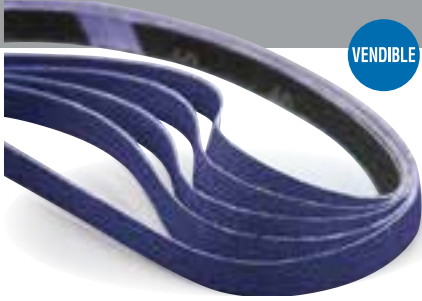

VENDIBLE

Better choice for stainless and carbon steel

BLUEFIRE R887D/R823P ZIRCONIA ALUMINA

- Strong, self-sharpening zirconia alumina abrasive for fast, aggressive cut and 30% longer life than competitive zirconia belts
- Durable resin bond for excellent grain retention and product life
- Strong Y-weight polyester backing - R887D for heavy-duty stock removal applications; flexible X-weight polyester backing - R823P for moderate- to light-pressure applications



Good choice for difficult-to-grind materials (aluminum, brass, bronze, stainless, carbon steel, titanium, etc.)

GEMINI R766 ALUMINUM OXIDE

- Premium aluminum oxide abrasive blend is ideal when primary purchasing criteria is a good-performing, economically-priced, general-purpose belt
- Y-weight waterproof polyester backing withstands light- to moderately-demanding applications and provides extended life on dry grinding applications
- Resin bond system provides improved edge retention and 30% plus improvement in life versus key competitors



Good choice for stainless and carbon steel applications when initial price is the primary purchasing factor

GEMINI R283 ALUMINUM OXIDE

- P-graded premium aluminum oxide abrasive for consistent, cool cut
- Strong, semi-flexible, smooth X-weight rayon waterproof backing is designed for light- to moderate- pressure applications
- Durable resin coating provides excellent grain retention and product life



TIER:	BEST	BEST	BETTER	GOOD	GOOD
TRADENAME:	BLAZE R980P	REDHEAT R983	BLUEFIRE R887D/R823P	GEMINI R766	GEMINI R283
ABRASIVE:	Ceramic Alumina	Ceramic Alumina	Zirconia Alumina	Aluminum Oxide Blend	Aluminum Oxide
BACKING:	Y-Weight Polyester	Y-Weight Polyester	Y- or X-Weight Polyester	Y-Weight Polyester	X-Weight Rayon
OTHER:	Supersize	Supersize			

SIZE (W x L)	GRIT	STD. PKG.	PART #	PART #	PART #	PART #	PART #	
12" Belts								
1/8 x 12	40	50				666233	90000	
	60	50	662544	05345	662544	91522	662610	93029
	80	50			662544	91523		
	120	50	662544	91519	662544	91524		
1/4 x 12	40	50	662544	91520		666233	90003	
	60	50	662611	96480	780727	58896		
	80	50			662544	91526	780727	82621
1/2 x 12	120	50	662610	63632	662544	91527	780727	82622
	40	50	699573	98018	662544	91528	662544	92522
	50	50	662610	43759	780727	18700	666233	90006
	60	50	699573	98019	780727	18701	780727	28745
	60	25 V					666233	90008
	60	25 V	699573	98020	780727	18702	780727	28744
1 x 12	80	50				666233	73753	
	80	25 V				666233	73754	
	100	50	662610	1081180	662544	91529	662544	91534
	120	50	662610	42909	780727	00518	780727	28742
	120	25 V					666233	73755
	120	25 V					780727	53073
			662610	63641			780727	73813

Additional sizes, grits and scalloped edge belts are available MTO (made-to-order). Contact your Norton representative for availability, order quantities and lead-times.

40 and 50 grit BlueFire belts are furnished in BlueFire R887D (Y-weight Polyester); 60-120 grits are supplied in BlueFire R823P (X-weight Polyester).

Joints - All belts are PG jointed; a butt joint joined with flexible tape for contour grinding.

V = Vendible package. Ideal for vending machines and small jobs. 5 belts per pack / 5 packs per carton. Order in multiples of 25.

continued



TIER:	BEST	BEST	BETTER	GOOD	GOOD
TRADENAME:	BLAZE R980P	REDHEAT R983	BLUEFIRE R887D/R823P	GEMINI R766	GEMINI R283
ABRASIVE:	Ceramic Alumina	Ceramic Alumina	Zirconia Alumina	Aluminum Oxide Blend	Aluminum Oxide
BACKING:	Y-Weight Polyester	Y-Weight Polyester	Y- or X-Weight Polyester	Y-Weight Polyester	X-Weight Rayon
OTHER:	Supersize	Supersize			

SIZE (W x L)	GRIT	STD. PKG.	PART #	PART #	PART #	PART #	PART #
13" Belts							
3/8 x 13	60	50	699573 45359	780727 45459	780727 40295	666233 90011	780727 32112
	80	50	699573 92150	780727 74916	780727 36062	666233 90012	780727 71323
18" Belts							
1/8 x 18	40	50	662544 75211		662544 91535	666233 90014	
	60	50	662610 80010		780727 60595	666233 90015	
	80	50	662610 89120	780727 89083	780727 60595		
	120	50	662544 75215	780727 89084	636425 95221		
1/4 x 18	40	50	662610 27923	662611 98953	662544 92525	666233 90016	662544 91543
	60	50	699573 47249	780727 74684	780727 43583	666233 90017	780727 71000
	60	25 V			666233 73747		
	80	50	699573 46155	780727 03284	780727 53075		780727 73921
	80	25 V			666233 73748		
	120	50	662610 85071	780727 85655	780727 73764		
1/2 x 18	40	50	699573 98021	780727 66018	662544 44193	666233 90019	780727 27561
	60	50	699573 98022	780727 18704	780727 28569	666233 90020	780727 27560
	60	25 V			666233 73756		
	80	50	699573 98023	780727 18705	780727 28568	666233 90021	780727 27559
	80	25 V			666233 73757		
	120	50	662610 41384	780727 18706	780727 28567		780727 27558
3/4 x 18	40	50	699573 98027	780727 62476	662544 92526	666233 90022	780727 81797
	60	50	699573 98028	780727 45691	780727 09590	666233 90023	780727 39966
	60	25 V			666233 73762		
	80	50	699573 98029	780727 56309	780727 58953	666233 90024	780727 32289
	80	25 V			666233 73763		
	120	25 V			666233 73764		
20-1/2" Belts							
3/4 x 20-1/2	40	50	699573 98030	780727 14398	662544 57869	666233 90025	780727 27573
	50	50	699573 44982	780727 18714	662544 92527	666233 90026	662544 91544
	60	50	699573 98031	780727 18715	780727 28560	666233 90027	780727 27571
	60	25 V			666233 73765		
	80	50	699573 98032	780727 18716	780727 28559	666233 90028	780727 27570
	80	25 V			666233 73766		
	100	50	662610 55516	780727 71151	662610 38911		780727 27569
	120	50	662610 44755	780727 27380	780727 28557		780727 27575
24" Belts							
1/4 x 24	40	50	662611 98631	780727 47823	662544 73499		662544 01929
	60	50	699573 45451	780727 56534	780727 28552	666233 90030	780727 27548
	60	25 V			666233 73750		
	80	50	636425 96940	780727 18340	780727 67713		
1/2 x 24	120	50	662610 80367	780727 70718	780727 28550		
	40	50	699573 98024	780727 60092	662544 92528	666233 90032	780727 27568
	50	50	662610 43757	780727 18707	662544 52237	666233 46910	780727 27567
	60	50	699573 98025	780727 18708	780727 28564	666233 90033	780727 27566
	60	25 V			666233 73759		
	80	50	699573 98026	780727 18709	780727 28566	666233 90034	780727 27565
	80	25 V			666233 73760		
	100	50	662610 42203	780727 45021	780727 53076		662544 91545
120	50	662610 42565	780727 18710	780727 28565		780727 27564	
1 x 24	40	50	699573 50019	662544 91531			
	50	50	699573 44889	780727 10374			662544 91547
	60	50	699573 53375				
	80	50	699573 45419	780727 72209	780727 76498	666233 34206	662610 85068
120	50	662610 85067	662544 91532	780727 30029		662610 85069	
30" Belts							
1 x 30	40	50	662610 53470		662544 78257	666233 90038	662611 89958
	60	50	699573 45985		780727 28583	666233 90039	662544 91549
	80	50	699573 46105	780727 64439	780727 28582	666233 90040	780727 27579
	120	50	662611 93676	780727 81197	780727 66992		780727 27577

Additional sizes, grits and scalloped edge belts are available MTO (made-to-order). Contact your Norton representative for availability, order quantities and lead-times.
40 and 50 grit BlueFire belts are furnished in BlueFire R887D (Y-weight Polyester); 60-120 grits are supplied in BlueFire R823P (X-weight Polyester).

Joints - All belts are PG jointed; a butt joint joined with flexible tape for contour grinding.

V = Vendible package. Ideal for vending machines and small jobs. 5 belts per pack / 5 packs per carton. Order in multiples of 25.



Portable belts are ideal for all your metal and woodworking applications. Choose 36 – 50 grits for rough/heavy-duty applications, 60 – 100 for intermediate, and 100 – 220 for finishing/polishing applications.

The belts listed are popular stock sizes, but additional sizes, specifications, and backing materials, are available made-to-order.

Applications:

Grinding and finishing all metals, blending welds, sanding and finishing wood, glass seaming, and polishing

Size Range:

3" to 4" wide, 15-1/2" to 24" long

Grit Range:

36 – 220

Abrasive Grain:

Ceramic Alumina, Zirconia Alumina, Aluminum Oxide

Machine used:

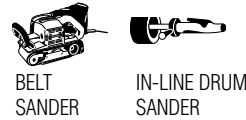

BELT SANDER

IN-LINE DRUM SANDER

Cross Reference Guide

	BEST	BETTER	GOOD
NORTON	RedHeat R983	BlueFire R831	Gemini R215/ Metalite R255
3M	747D, 777F, 778F, 784F, 987F, 977F	577F	240DZ, 340A, 340D
Hermes	—	RB480	RB320
Klingspor	CS912	CS411	LS309XH
Sait	—	Z-H	1A-X, 2A-X, AO-X, LA-X
SIA	—	2800, 2829, 2925	2920, 2928, 2921, 2951, 2925
VSM	XK870X, XK870X	ZK713X	KK504X, KP510E

Material-to-Product Recommendation Guide

	BEST	BETTER	GOOD
	RedHeat R983	Bluefire R831	Gemini R215 Metalite R255
Wood		◆	◆
Carbon Steel / Stainless Steel	◆	◆	
Brass / Bronze / Aluminum		◆	◆

Exceptional performance, especially on hard-to-grind alloys



REDHEAT R983 CERAMIC ALUMINA

- Premium ceramic abrasive provides sharp cutting, exceptional life and value, especially on hard-to-grind alloys
- "Supersize" grinding-aid for longer life, cooler cut and minimized loading
- Strong Y-weight polyester, waterproof cloth backing for improved grain adhesion, reduced edge-fray and better body retention, resulting in longer life and product consistency

Better choice for stainless steel and wood



BLUEFIRE R831 ZIRCONIA ALUMINA

- Premium, self-sharpening zirconia alumina abrasive provides superior cut on all surfaces, lasts substantially longer, and cuts faster than the next leading competitor in side-by-side comparisons
- Proprietary patented grain technology produces one of the finest scratch patterns in the industry for finer looking finish; open-coat design and strong Y-weight cotton backing for reduced loading and extended life
- Reversible butt splice allows belt to be used in either direction for longer life

Good choice to minimize loading on wood and soft metals - where initial price is the main concern

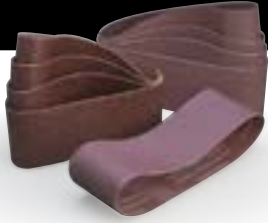

GEMINI R215 / METALITE R255 ALUMINUM OXIDE

- Premium aluminum oxide abrasive for fast initial cut rate
- Heavy, durable X-weight cotton backing is ideal for heat sensitive applications
- Strong butt joint that allows the belt to be run in either direction

Portable Belts for Belt Sanders



TIER:	BETTER	GOOD
TRADENAME:	BLUEFIRE R831	GEMINI R215
ABRASIVE:	Zirconia Alumina	Aluminum Oxide
BACKING:	Y-Weight Cotton	X-Weight Cotton
JOINT:	Plyweld	Plyweld
GRAIN COATING:	Open Coat	Open Coat
OTHER:		



GOOD	GOOD
GEMINI R215	METALITE R255
Aluminum Oxide	Aluminum Oxide
X-Weight Cotton	X-Weight Cotton
Plyweld	Plyweld
Open Coat	Open Coat
	UPC Bar Coded

SIZE (W x L)	GRIT	PKG./CASE	PART #	PART #	STD. PKG.	PART #	PART #
3 x 18	36				5		780727 80447
	50	5/25*	076607 49259	076607 00964	10		780727 27994
	80	5/25*	076607 49258	076607 00968	10		780727 27993
	120	5/25*	076607 49256	076607 00969	10		780727 27992
3 x 21	36	5/25*	076607 49266	076607 01741			
	40				10		780727 27927
	50	5/25*	076607 49265	076607 01740	10		780727 27926
	60				10	780727 27925	
	80	5/25*	076607 49264	076607 02064	10		780727 27924
	100	5/25*	076607 49263		10		780727 27923
	120	5/25*	076607 49262	076607 02062	10		780727 27922
	220	5/25*		076607 05287			
3 x 24	36	5/25*	076607 49272	076607 01743	5		780727 81847
	40				10		780727 27937
	50	5/25*	076607 49271	076607 01742	10		780727 27936
	60				10	780727 27935	
	80	5/25*		076607 02067	10		780727 27934
	100	5/25*	076607 49269	076607 02066	10		780727 27933
	120	5/25*	076607 49268	076607 02065	10		780727 27932
	180	5/25*	076607 49278	076607 01745	5		780727 80438
4 x 24	36	5/25*	076607 49278	076607 01745	5		780727 80438
	40				10		780727 27947
	50	5/25*	076607 49277	076607 01744	10		780727 27946
	60				10	780727 27945	
	80	5/25*	076607 49276	076607 02069	10		780727 27944
	100	5/25*			10		780727 27943
	120	5/25*	076607 49274	076607 02068	10		780727 27942
	180	5/25*		076607 05285			

*Job Pack packing standards: 5 belts/Job Pack; 5 Job Packs per case. Order by number of packs, in multiples of 5 packs.

Portable Belts for Pneumatic In-Line Drum Sanders

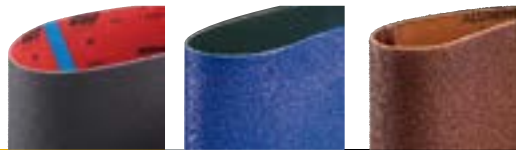

TIER:	BEST	BETTER	GOOD
TRADENAME:	REDHEAT R983	BLUEFIRE R823P	GEMINI R215
ABRASIVE:	Ceramic Alumina	Zirconia Alumina	Aluminum Oxide
BACKING:	Y-Weight Polyester	X-Weight Polyester	X-Weight Cotton
JOINT:	Plyweld	Plyweld	Plyweld
GRAIN COATING:	Closed Coat/Supersize	Closed Coat	Open Coat

SIZE (W x L)	GRIT	STD. PKG.	PART #	PART #	PART #
3-1/2 x 15-1/2	36	10	780727 00783		780727 21997
	60	10	780727 18750		780727 22000
	80	10	780727 18751	780727 53074	780727 21995
	120	10	780727 18753		



A broad selection of sizes and grits for most dimensioning, intermediate grinding and polishing applications.

The belts listed are popular stock sizes, but additional sizes, specifications, and backing materials, are available made-to-order.

Applications:

Benchstand and Backstand Belts: grinding and deburring of all metals, heavy stock removal, blending, dimensioning and shaping, polishing.

Centerless, Conveyor and Platen Belts: intermediate grinding stainless and carbon, moderate-pressure applications, dimensioning and finishing.

Size Range:

1" to 10" wide, 36" to 132" long

Grit Range:

24 – 320

Abrasive Grain:

Ceramic Alumina, Zirconia Alumina, Aluminum Oxide

Machine Used:



BACKSTAND
BELT GRINDER



BENCHSTAND
GRINDER

Cross Reference Guide

	BEST	BEST	BETTER	BETTER	BETTER	GOOD	GOOD
NORTON	Blaze R980P	RedHeat R983	BlueFire R821P	BlueFire R823P	BlueFire R884P	Gemini R766	Gemini R228
3M	963G/H, 966F, 967F, 997F, 984F, 784F, 947A	747D, 777F, 778F, 784F, 987F, 977F	—	551E	561D	361F, 363F	241D, 251D, 341D
Hermes	CR454, CR456	CN464	—	RB486 X, RB346, RB486	RB48024YX, RB48444Z, RB485Z	RB377XY, SB378, RB34MJ	RB320X, HSB
Klingspor	CS610	CS912	CS411X	CS411X, CS416	CS411	CS412, CS413	CS310
SIA	2515, 2503	—	—	—	2820	—	2918, 2928
VSM	XK875X, XK885Y, XK880Y	XK870X, XK870X	—	ZK713X, KK715X	KK716, ZK713T	LK719X, KK711X	KK511X, KK711

Material-to-Product Recommendation Guide

	BEST	BETTER	BETTER	BETTER	GOOD	GOOD
	Blaze R980P	BlueFire R884P	BlueFire R823P	BlueFire 821P	Gemini R766	Gemini R228
Aluminum		◆	◆		◆	
Cast Iron	◆		◆		◆	
Brass / Bronze		◆	◆		◆	
Die Castings	◆		◆		◆	
Carbon Steel	◆		◆		◆	◆
Glass / Ceramics	◆			◆	◆	
Stainless Steel and Alloys	◆	◆	◆		◆	
Wood		◆			◆	

Grit Selection Recommendation Guide

STOCK REMOVAL	INTERMEDIATE	FINISHING
24 – 50 grit	60 – 100 grit	120 – 320 grit

TECH TIP

Troubleshooting Guide

Problem	Correction	Problem	Correction
Loading	Decrease infeed pressure or belt speed	Belt breakage	Reduce belt tension
Shedding	Reduce applied pressure		Use less aggressive contact wheel
	Use a less aggressive contact wheel		Check tracking mechanism for belts tracking erratically
	Dress contact wheel if worn or damaged		
	Use entire surface of belt		



Best for mild and carbon steel, stainless, cobalt, chrome, inconel, titanium

BLAZE R980P CERAMIC ALUMINA

- Next-generation cooler cutting Norton SG ceramic alumina grain lasts 50% to 200% longer on mild and carbon steel, stainless, cobalt, chrome, inconel and titanium with better metal integrity
- Durable Y-weight polyester, waterproof cloth backing for improved grain adhesion, reduced edge-fray, and better body retention, resulting in longer life and product consistency
- Lubricating grinding aid coating means cooler cut, burn-free grinding of heat-sensitive materials, minimized loading, and improved part finish and integrity



Exceptional performance, especially on hard-to-grind alloys

REDHEAT R983 CERAMIC ALUMINA

- Premium ceramic abrasive provides sharp cutting, exceptional life and value, especially on hard-to-grind alloys
- "Supersize" grinding-aid for longer life, cooler cut and minimized loading
- Strong Y-weight polyester, waterproof cloth backing for improved grain adhesion, reduced edge-fray and better body retention, resulting in longer life and product consistency



Better choice for heaviest-pressure applications

BLUEFIRE R821P/R823P/R884P ZIRCONIA ALUMINA

- Strong, self-sharpening zirconia alumina abrasive for fast, aggressive cut and 30% longer life than competitive zirconia belts
- Durable resin bond for excellent grain retention and product life
- R821P Y-weight cotton backing provides durability and even wear on coarser grit stock removal applications;
- R823 has flexible X-weight polyester waterproof backing to excel on light- to moderate-pressure, applications
- R884P has a durable Y-weight polyester waterproof cloth backing that excels on medium- to high pressure applications



Good choice for difficult-to-grind materials (aluminum, brass, bronze, stainless, carbon steel, titanium, etc.)

GEMINI R766 ALUMINUM OXIDE

- Premium aluminum oxide abrasive blend is ideal when primary purchasing criteria is a good-performing, economically-priced, general-purpose belt
- Y-weight waterproof polyester backing withstands light- to moderately-demanding applications and provides extended life on dry grinding applications
- Resin bond system provides improved edge retention and 30% plus improvement in life versus key competitors



Good choice for fine grit metalworking blending and polishing where initial price is the main concern

GEMINI R228 ALUMINUM OXIDE

- Premium aluminum oxide abrasive delivers fast initial cut rate
- Heavy, durable X-weight cotton backing is ideal for heat sensitive applications
- Strong butt joint that allows the belt to be run in either direction

1" to 6" wide, 36" to 72" long



TIER:	BEST	BETTER	BETTER	GOOD	GOOD
TRADENAME:	BLAZE R980P	BLUEFIRE R821P	BLUEFIRE R823P	GEMINI R766	GEMINI R228
ABRASIVE:	Ceramic Alumina	Zirconia Alumina	Zirconia Alumina	Aluminum Oxide Blend	Aluminum Oxide
BACKING:	Y-Weight Polyester	Y-Weight Cotton	X-Weight Polyester	Y-Weight Polyester	X-Weight Cotton
OTHER:	Supersize				

SIZE (W x L)	GRIT	STD. PKG.	PART #	PART #	PART #	PART #	PART #
1 x 42	36	50	662544 76825				780727 91710
	40	50	699573 45887	780727 26905			780727 20910
	50	50	662544 76826	780727 26904		666233 90042	780727 20905
	60	50	699573 45486	780727 26903	780727 28596	666233 34502	780727 20900
	80	50	662610 41539	780727 26902	780727 28594	666233 90043	780727 20895
	100	50	662610 43462		780727 28592		780727 20890
	120	50	662610 38660		780727 28590		780727 20885
	150	50			780727 28588		780727 20880
	180	50			780727 28586		780727 20875
	220	50			780727 00001		780727 20871
	240	50					780727 20870
	320	50					780727 20865
	1-1/2 x 60	36	10	699573 45578			
40		10	636425 95003				
50		10					780727 87807
60		10	699573 45631			666233 90045	
80		10	699573 45579			666233 90046	
100		10			780727 65077		699573 51736
120		10	662610 56493		780727 26984		
2 x 48	24	10					780727 26130
	36	10	636425 92057	780727 27103		666233 90047	780727 21255
	40	10	699573 45193	780727 27102		666233 90048	780727 21250
	50	10	699573 46716	780727 27101			780727 21245
	60	10	699573 44423	780727 27100	780727 28621	666233 90050	780727 21240
	80	10	699573 45100	780727 27099	780727 28619	666233 90051	780727 21235
	100	10	662610 52522		780727 28617		780727 21230
	120	10	662610 52520		780727 28615		780727 21225
	150	10			780727 28613		780727 23246
	180	10			780727 28611		780727 21223
	220	10			780727 28609		780727 63677
	320	10					780727 46387
	2 x 60	24	10				
36		10	699573 45196			666233 90052	780727 01170
40		10	699573 94425	780727 27124			780727 21300
50		10	699573 46149				780727 62537
60		10	699573 44901	780727 27122		666233 90055	780727 21290
80		10	636425 92574	780727 27121		666233 90056	780727 21285
100		10	662610 52222		662610 82976		780727 21280
120		10	662610 42738		780727 61958		
150		10					780727 44018
180		10			780727 02695		780727 20441
220		10			780727 06282		780727 44020
240		10					780727 61862
320		10					780727 02825
2 x 72	24	10	662544 33969				
	36	10	699573 45460	780727 27147		666233 90057	780727 21335
	40	10	699573 46729	780727 27146		666233 90058	780727 21332
	50	10	699573 44966	780727 27145			780727 84894
	60	10	699573 45157	780727 27144	780727 28645	666233 90060	780727 21325
	80	10	699573 44961	780727 27142	780727 28643	666233 34237	780727 21320
	100	10	662610 41897		662610 25537		780727 23235
	120	10	662610 44095		780727 28639		780727 21318
	150	10			780727 61770		780727 61973
	180	10			780727 63853		780727 18488
	220	10			780727 28633		780727 65601
	320	10					780727 21308

* Std. Pkg. = 20 Belts
Continued

1" to 6" wide, 36" to 72" long *continued*

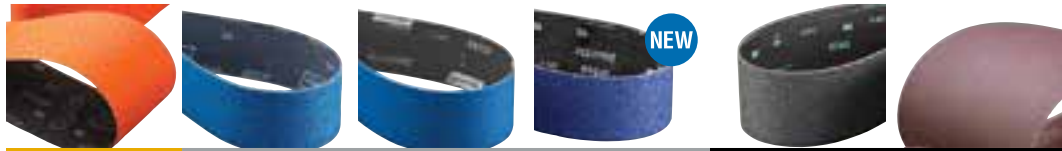

TIER:	BEST	BETTER	BETTER	BETTER	GOOD	GOOD
TRADENAME:	BLAZE R980P	BLUEFIRE R821P	BLUEFIRE R823P	BLUEFIRE R884P	GEMINI R766	GEMINI R228
ABRASIVE:	Ceramic Alumina	Zirconia Alumina	Zirconia Alumina	Zirconia Alumina	Aluminum Oxide Blend	Aluminum Oxide
BACKING:	Y-Weight Polyester	Y-Weight Cotton	X-Weight Polyester	Y-Weight Polyester	Y-Weight Polyester	X-Weight Cotton
OTHER:	Supersize					

SIZE (W x L)	GRIT	STD. PKG.	PART #	PART #	PART #	PART #	PART #	PART #
2-1/2 x 48	36	10					666233 90061	780727 21540
	50	10		780727 27213				780727 21530
	60	10					666233 90064	780727 21525
	80	10					666233 90065	780727 21520
2-1/2 x 60	24	10				780727 37759		780727 08296
	36	10	699573 44963	780727 27235			666233 90066	780727 21610
	40	10	699573 46523	780727 27234			666233 90067	780727 21605
	50	10	699573 45300	780727 27233			666233 90068	780727 21600
	60	10	699573 45002	780727 27232	780727 28692	780727 21383	666233 90069	780727 21595
	80	10	699573 46095	780727 27231	780727 28690		666233 90070	780727 21590
	100	10	662610 41380		780727 68991			780727 21585
	120	10			780727 28686			780727 21580
	180	10			780727 28682			780727 21570
	220	10			780727 78217			780727 21565
4 x 36	36	10					666233 90071	780727 22110
	40	10						780727 22105
	50	10		780727 27475			666233 90073	780727 22100
	60	10			780727 28827		666233 90074	780727 22095
	80	10		780727 27473	780727 28825		666233 90075	780727 22090
	100	10			780727 28823			780727 22085
	120	10			780727 28821			780727 22080
	150	10						780727 22079
	180	10						780727 22075
	240	10						780727 22926
4 x 54	320	10						780727 22071
	36	10						780727 22185
	40	10						780727 22180
	50	10					666233 90078	780727 22175
	60	10	662610 63419	780727 27518	780727 25116			780727 22170
	80	10	699573 45139		780727 82996			780727 22165
	100	10						780727 22160
4 x 60	120	10			780727 28847			780727 22155
	150	10						780727 28381
	24	10	662544 61488					780727 72342
	36	10	699573 45298			780727 37955		780727 05189
	40	10	699573 91732					780727 44693
	50	10	699573 46715					780727 61630
	60	10	636425 94485		780727 74790			780727 62861
4 x 72	80	10	699573 45099		780727 65086			780727 84685
	100	10						780727 63161
	120	10	662544 16188		780727 66229			780727 87840
	36	10				780727 25984		
	6 x 48	36	10	699573 45143	780727 27698			666233 90081
40		10		780727 27697			666233 90082	
50		10		780727 27696			666233 90083	780727 22580
60		10	699573 44422	780727 27695*	780727 28937*		666233 90084	
80		10		780727 27694*	780727 28935*		666233 90085	780727 22570
100		10			780727 28933*			780727 22565
120		10			780727 28931*			780727 22560
150		10			780727 70042			780727 22555
180		10						780727 22550
220		10						780727 22545
240		10						780727 22540
320		10						780727 22543

* Std. Pkg. = 20 Belts
Continued

1" to 6" wide, 36" to 72" long *continued*



TIER:	BEST	BETTER	BETTER	BETTER	GOOD
TRADENAME:	BLAZE R980P	BLUEFIRE R821P	BLUEFIRE R823P	BLUEFIRE R884P	GEMINI R228
ABRASIVE:	Ceramic Alumina	Zirconia Alumina	Zirconia Alumina	Zirconia Alumina	Aluminum Oxide
BACKING:	Y-Weight Polyester	Y-Weight Cotton	X-Weight Polyester	Y-Weight Polyester	X-Weight Cotton
OTHER:	Supersize				

SIZE (W x L)	GRIT	STD. PKG.	PART #	PART #	PART #	PART #	PART #
6 x 54	60	10				780727 46982	
6 x 60	36	10					780727 22680
	40	10		780727 27762			780727 22679
	60	10	699573 45149	780727 28957*			780727 22665*
	80	10			780727 28955		780727 22660*
	100	10	662544 77452				
	120	10					780727 63882

* Std. Pkg. = 20 Belts

Belt Cleaning Stick



- This solid, rubber cleaning stick is designed to remove wood and other non-metallic materials that build up on belt surface during use
- Apply it to the face of the belt, while running, to remove unwanted materials and prolong the overall life of the belt up to 10 times

DESCRIPTION	STD. PKG.	PART #
1-3/8 x 1-3/8 x 6	10	076607 01717

TECH TIP

A light-bodied grease applied to a benchstand belt surface will reduce loading and greatly enhance the belt life and performance when grinding soft, malleable nonferrous materials such as aluminum, brass, bronze and copper.



For non-stock belts, FastTrack Service offers all the benefits of an ISO 9001 quality manufacturer and the advantages of a coated abrasives express belt service. As the industry's leading producer of abrasive material and backings, our FastTrack service offers an extensive range of Norton made-to-order belts including Blaze ceramic alumina, BlueFire zirconia alumina, and versatile aluminum oxide and silicon carbide belts.

Manufacturing Lead-times:

- Narrow belts: (1/2" – 12" wide) two days
- Wide belts (14" – 52" wide) three days

Size Availability:

- Maximum width: 52"
- 1/2" and greater widths; 25" and greater lengths

Please see the FastTrack Service Made-to-Order Belts section of this catalog for complete details.

2" to 10" wide, over 70" long

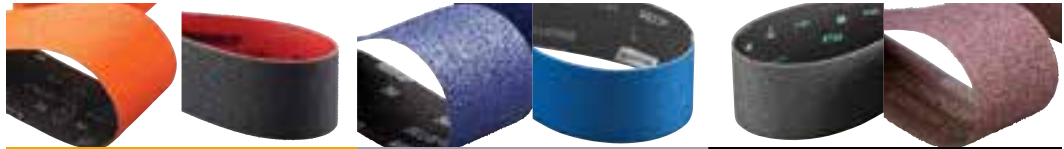

TIER:	BEST	BEST	BETTER	BETTER	GOOD	GOOD
TRADENAME:	BLAZE R980P	REDHEAT R983	BLUEFIRE R884P	BLUEFIRE R823P	GEMINI R766	GEMINI R228
ABRASIVE:	Ceramic Alumina	Ceramic Alumina	Zirconia Alumina	Zirconia Alumina	Aluminum Oxide Blend	Aluminum Oxide
BACKING:	Y-Weight Polyester	Y-Weight Polyester	Y-Weight Polyester	X-Weight Polyester	Y-Weight Polyester	X-Weight Cotton
OTHER:	Supersize	Supersize				

SIZE (W x L)	GRIT	STD. PKG.	PART #	PART #	PART #	PART #	PART #	PART #
2 x 132	36	10		780727 53086	780727 50016		666233 47337	
	40	10			780727 50015		666233 90089	
	50	10		780727 40771	780727 50013		666233 90090	
	60	10			780727 50011		666233 90091	780727 21445
	80	10		780727 01958	780727 50008		666233 90092	780727 21440
	120	10				780727 28662		
3 x 79	50	10	662610 90276					
	60	10			780727 48280			
3 x 90	36	10	699573 46319					780727 85831
3 x 132	24	10			780727 50140			
	36	10	699573 44710	780727 53087	780727 50138 RR		666233 90093	780727 21900
	36	10			780727 50139 L			
	40	10	699573 44964	780727 01614				
	50	10	699573 44763	780727 03709	780727 50135			780727 21890
	60	10	699573 44958			780727 28794	666233 90096	780727 21885
	80	10	699573 44764			780727 28792	666233 90097	780727 21880
	100	10				780727 28790		
	120	10				780727 28789		780727 21870
	180	10				780727 28785		780727 21860
4 x 79	36	10		662610 22622				
	40	10			780727 74955			
4 x 100	36	10			780727 68679			
4 x 132	24	10			780727 50289			
	36	10	699573 43852	780727 39662	780727 50287		666233 26093	
	40	10					666233 90098	
	60	10			780727 50281			
	80	10			780727 50279			780727 22385
	120	10						780727 22375
6 x 78-3/4	40	10			780727 25150			
6 x 79	36	10			780727 38105			
	80	10			780727 79322			
8 x 107	36	10						780727 22795
	50	10						780727 49887
	60	10						780727 22780*
	80	10						780727 22775*
10 x 70-1/2	36	10						780727 22840
	40	10						780727 22835
	50	10						780727 22830
	60	10					666233 47345	780727 22825
	80	10					666233 47346	780727 22820

* Std. Pkg. = 20 Belts



A small selection of stock products in popular sizes are available for wide belt woodworking and metalworking applications.

Applications:

Metalworking

Metalworking wide belts are used for plate dimensioning, slag grinding, machining, deburring, and other general metalworking applications. They are usually cloth and are closed coat.

Woodworking

Cloth woodworking wide belts are used for rough stock removal and dimensioning. Paper woodworking belts are used to upgrade the finish on furniture and other wood components.

Size Range:

Stock: 25" – 52" wide, 48" to 103" long

Grit Range:

Stock: 36 – 220

Abrasive Grain:

Zirconia Alumina, Aluminum Oxide

Metalworking Cloth Belt Recommendation Guide/Cross Reference

	TOTAL PERFORMANCE								INITIAL PRICE	
	BEST				BETTER					GOOD
	H-wt. Polyester	Y-wt. Polyester	H-wt. Polyester	Y-wt. Polyester	X-wt. Polyester	Y-wt. Polyester	X-wt. Polyester	X-wt. Cotton		
NORTON	Blaze R940P	Blaze R980P	BlueFire R840P	BlueFire R887D/R884P	BlueFire R823P	Gemini R766	Gemini R766X	Gemini R228		
3M	966F, 984F, 994F, 997F	963G/H, 966F, 967F, 997F, 984F, 784F, 947A	561F	577F, 561D	551E	361F, 363F	353F, 384F	241D, 251D, 341D		
Ekamant/ Uneeda	—	PS991, PS992	PZ628	PZ528, PZ633	XZ677	PA631, PG730, PG830	XA911	XA167		
Hermes	CB441Z	CR456	SB488YR	RB48624YX, RB48644Z, RB48024YX, RB48444Z, RB485Z	RB486	RB377XY, SB378	RB377XY	RB320X, HSB		
Klingspor	—	CS610	CS811	CS409, CS411	CS411X, CS416	CS412, CS413	CS341, CS710	CS310		
SIA	—	2515, 2503	C888DP	2803, 2815, 2829, 2824, 2820	—	—	2820	2918, 2928		
VSM	XK888Z, XK877Z	XK875X, XK885Y, XK880Y	KK717	KK716	ZK713X, ZK713T, KK715X	LK719X, KK711X	LK719X, KK711X	KK511X		

Woodworking Cloth and Paper Belt Recommendation Guide/Cross Reference

	TOTAL PERFORMANCE						INITIAL PRICE
	BEST		BETTER		GOOD		
	Y-wt. Cotton	F-wt. Paper	Y-wt. Cotton	X-wt. Cotton	F-wt. Paper	F-wt. Paper	
NORTON	Dust-Less SG R963	Dust-Less SG 975	BlueFire R831	Gemini R215	Dust-Less H295	Dust-Less H275	
3M	960G, 970DZ, 990FZ, 991FZ	966UZ	—	240DZ, 340A, 340D	260UZ	364UZ	
Ekamant/ Uneeda	—	—	XZ677	RKX, RKXO	—	ARKFO, EKA1000, EKABlack	
Hermes	—	CB115	RB480	RB320	BW114	BW110, BW114, CB115	
Klingspor	—	—	C409, CS411	LS309XH	PS22	PS29	
SIA	—	—	2803, 2820, 2829	2920, 2928, 2921, 2951	1919	1909, 1918, 1919 CRS, 1993	
VSM	XK760X, XK760Y	XP760	KK713X, KK715X	KK504X, KP510E	KK508E	KP709, KP520, KP508E, KP510E	

Better choice for all metal and wood applications due to the cut rate and life of the proprietary Norton BlueFire grain

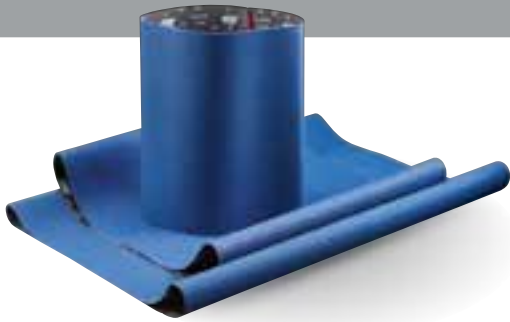

BLUEFIRE R884P/R823P ZIRCONIA ALUMINA CLOTH

- Strong, self-sharpening zirconia alumina abrasive for fast, aggressive cut and 30% longer life than competitive zirconia belts
- Durable resin bond for excellent grain retention and product life
- R884P has a durable Y-weight polyester waterproof cloth backing that excels on medium- to high pressure metal applications
- R823 has flexible X-weight polyester waterproof backing to excel on light- to moderate-pressure metal applications

Good choice for abrasive planing and dimensioning of glued-up stock and banded particleboard



GEMINI R215 ALUMINUM OXIDE CLOTH

- Premium aluminum oxide abrasive for fast initial cut rate
- Heavy, durable X-weight cotton backing is ideal for heat sensitive applications
- Strong butt joint that allows the belt to be run in either direction



		TIER: BETTER		TIER: BETTER		TIER: GOOD	
		BLUEFIRE R884P		BLUEFIRE R823P		GEMINI R215	
		ABRASIVE: Zirconia Alumina		ABRASIVE: Zirconia Alumina		ABRASIVE: Aluminum Oxide	
		BACKING: Y-Weight Polyester Cloth		BACKING: X-Weight Polyester Cloth		BACKING: X-Weight Cotton Cloth	
		JOINT/FLEX: Plyweld, RR		JOINT/FLEX: Plyweld, RR		JOINT/FLEX: Plyweld, RR	
SIZE (W x L)	GRIT	STD. PKG.	PART #	PART #	PART #	PART #	PART #
25 x 48	80	3		699573 44781			
25 x 60	80	3		699573 28117			
	120	5		699573 28115			
25 x 75	120	5		699573 44791			
36 x 75	36	2	699573 50934				
	60	3	699573 50931				
	120	5		699573 29014			
37 x 60	180	5		699573 44869			
	50	3	699573 06219				
	80	3		699573 29019		699573 25709	
	100	5		699573 28103		699573 25708	
37 x 75	120	5		699573 29018		699573 25707	
	150	5		699573 28102		699573 02955	
	180	5		699573 28101			
	220	5		699573 28100			
	36	2	699573 50959				
	50	3	699573 05107				
52 x 75	80	3	699573 50955			699573 25957	
	100	5				699573 23880	
	120	5		699573 07358		699573 25760	
	150	5				699573 05737	
	180	5		699573 06734			
120	5		699573 13510				

Due to the wide varieties of machines and applications, the majority of wide belts are non-stock. Our FastTrack belt service is available on the majority of products with 3-day lead-time on orders up to two cases quantity.

TECH TIP

6" wide belts can be used on machines that normally use 37" wide belts.

FastTrack Service Made-to-Order Belts

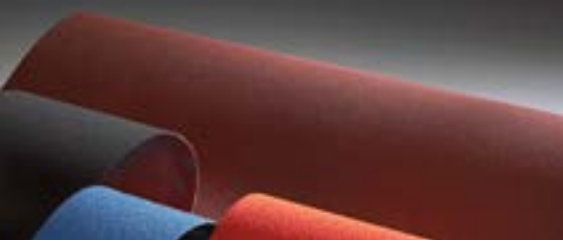

For many non-stock belts, our FastTrack belt service offers all the benefits of an ISO 9001 quality manufacturer and the advantages of a coated abrasives express belt service. As the industry leader of abrasive belts, our FastTrack belt service has an extensive range of Norton made-to-order belts including Blaze ceramic alumina, BlueFire zirconia alumina, versatile aluminum oxide, and silicon carbide belts.

Manufacturing lead-time is two days for narrow belts (1/2" – 12" wide) and three days for wide belts (14" – 52" wide). Please see the FastTrack belt service chart below for complete details on availability and lead-time.

FastTrack Availability* and Lead-time Information

WIDTH	GRIT SIZE	MINIMUM ORDER QUANTITY	CASE QUANTITY	MAXIMUM ORDER QUANTITY (EQUALS 2 CASES)	CONVERSION LEAD-TIMES
Narrow Belts					
1/2" through 1"	All	50	200	400	2
Over 1" through 5"	All	10	50	100	2
Over 5" through 9"	All	10	20	40	2
Over 9" through 14"	All	10	10	20	2
Wide Belts					
Over 14" through 20"	All	5	10	20	3
Over 20" through 52"	36 & coarser	2	2	4	3
Over 20" through 52"	40-80	3	3	6	3
Over 20" through 52"	100 & finer	5	5	10	3

* FastTrack belt service applies to belts 25" and greater in length.

How to Place a FastTrack Belt Order

- Check the FastTrack belt availability
- Include a full description of belt: quantity, size, Norton CAP code, and grit size
- Send order electronically, fax, or phone to customer service
- When ordering a belt that does not have an existing part number, please call Customer Service to expedite part number creation

TIER	PRODUCT CAP CODE	SHAPE AVAILABILITY	GRIT SIZE	ABRASIVE GRAIN	BACKING	APPLICATIONS
Metalworking						
Best	R980P	Narrow, Wide	24-120	Blaze Ceramic Alumina	Y-wt. Polyester	Latest-generation Norton SG grain, supersized and designed for high-performance grinding on stainless and other alloys
Best	R984	Narrow, Wide	36-120	SG Ceramic Alumina	Y-wt. Polyester	Norton SG grain for medium-pressure grinding and finishing heat-sensitive alloys
Best	R983	Narrow	P36-P120	Red Heat Ceramic Alumina	Y-wt. Plus	P-graded ceramic alumina abrasive with lubricating supersize coat; engineered for maximum productivity on mild carbon steel, ferrous metal, and cast iron applications
Better	R884P	Narrow, Wide	24, 36-80	BlueFire Zirconia Alumina	Y-wt. Polyester	High-performance zirconia alumina grain designed for medium- to high-pressure grinding
Better	R887D	Narrow, Wide	24, 36-120	BlueFire Zirconia Alumina	Y-wt. Polyester	High-performance zirconia alumina grain, supersized and designed for medium- to high-pressure grinding of heat-sensitive alloys
Better	R823P	Narrow, Wide	60-220	BlueFire Zirconia Alumina	X-wt. Polyester	High-performance zirconia alumina grain on lighter backing designed for light to medium grinding
Good	R766	Narrow	P24-80	Gemini Aluminum Oxide Blend	Y-wt. Polyester	Premium aluminum oxide blend product designed for a variety of applications including soft metals to hard-to-grind stainless and carbon steel
Good	R766X	Narrow, Wide	P60-P400	Gemini Aluminum Oxide Blend	X-wt. Polyester	Quality, P-graded aluminum oxide and broad grit range for stock removal to finer finishing
Good	MX240	Narrow, Wide	P80-P150	Aluminum Oxide	X-wt. Poly/Cotton	P-graded, heat-treated aluminum oxide X-weight cloth with strong, but flexible, cotton/ polyester backing making it an ideal multi-purpose product
Good	R245	Narrow	P80-P240, P320, P400	Aluminum Oxide	J-wt. Polyester	Aluminum oxide on flexible, lightweight polyester backing for moderate- to light- pressure applications on mild steel
Good	KF376	Narrow	P80-P320, P400, P600	Aluminum Oxide	J-wt. Cotton	P-graded, heat-treated aluminum oxide with ceramic coating on a very flexible backing for use wherever flexibility and conformability are needed
Good	R445	Narrow	60-220	Silicon Carbide	X-wt. Polyester	Sharp, silicon carbide grain on medium polyester backing for grinding very hard materials – glass, stone, solid surface
Good	U243	Narrow, Wide to 24"	X80, X65, X45, X30, X22, X16	NORaX Aluminum Oxide	J-wt. Cotton	High-performance, multi-layered NORaX grain on very flexible backing for dry polishing applications
Woodworking						
Best	R963	Narrow, Wide	24-60, P80 100-150	SG Ceramic Alumina	Y-wt. Polyester	Norton SG ceramic alumina grain with anti-static coating for forest product applications (MDF, particleboard, plywood)
Best	R955	Narrow	P36-P120	Red Heat Ceramic Alumina	Y-wt. Cotton	100% ceramic alumina abrasive with Y-weight cloth backing for dimensioning, intermediate sanding of wood
Better	R831	Narrow, Wide	24, 36-120	BlueFire Zirconia Alumina	Y-wt. Cotton	Norton BlueFire open-coat product recommended for dry low-pressure applications or where loading is a problem
Good	R215	Narrow, Wide	50-180	Gemini Aluminum Oxide	X-wt. Cotton	Initial starting specification for woodworking applications where loading is a problem, and initial cost a primary concern
Good	R490	Narrow, Wide	P36-P150	Silicon Carbide	Y-wt. Polyester	Anti-static product for forest product applications (MDF, particle board, plywood) where loading is an issue
Good	R422	Narrow	50-120	Silicon Carbide	X-wt. Cotton	Initial starting specification for woodworking applications where loading is not an issue
Best	H975	Narrow, Wide	60-220	Red Heat Ceramic Alumina	F-wt. Paper	Ceramic alumina grain, antistatic coating, and open coat; the best choice for applications where loading is a problem (soft woods, etc.)
Better	H831	Wide	24,36-120	BlueFire Zirconia Alumina	F-wt. Paper	Durable zirconia alumina grain, antistatic coating, and open coat: the better choice for applications where loading is a problem (soft woods, etc.)
Good	H275B	Narrow, Wide	P60-P220	Aluminum Oxide	F-wt. Paper	Quality aluminum oxide grain, antistatic coating, and open coat make these an economical choice for all heavy-weight paper belt jobs
Better	H475	Narrow, Wide	P120-P400	Onyx Silicon Carbide	F-wt. Paper	Sharp silicon carbide and antistatic coating create finer finishes on hard materials and veneers where finish is critical



Norton non-woven belts are a combination of strong synthetic mesh and quality abrasive, bonded together by a smear-resistant adhesive. The open construction of non-woven material enables aggressive cutting action and improved surface finish while maintaining its non-loading feature.

Watch for new and improved narrow belt and file belt joints.

Applications:

Removing surface defects, light edge burrs, parting lines, flashing, rust, oxides, corrosion, paints, and scale; blending mill marks, tool marks, uneven edges, and applying decorative finishes.

Abrasive Grain:

Engineered Aluminum Oxide, Aluminum Oxide

Grit Range:

Extra Coarse (Black), Coarse (Brown), Medium (Maroon), Fine (Green), Very Fine (Blue)

Machine Used:



Application/Grit Recommendation Guide

	EXTRA COARSE	COARSE	MEDIUM	FINE	VERY FINE
	BEST Choice - Vortex Rapid Prep				
	BETTER Choice - Rapid Prep				
Scale Removal	◆				
Stock Removal		◆			
Heavy Deburring		◆			
Light Deburring			◆		
Light Finishing			◆		
Blending				◆	
Finishing					◆

Vortex Rapid Prep Pump Sleeve Belts

Best choice for finishing and blending applications



VORTEX RAPID PREP ALUMINUM OXIDE

- Patented Vortex agglomerated aluminum oxide grain produces the most consistent cutting and finishing action combining the cutting power of a coarser grit with the finish of finer grits
- Premium high-loft nylon fiber bonded to a strong nylon scrim backing allows a uniformly thick layer of resin bond and grain for extended life, durability, and stiffness
- Proprietary Clean Bond resin technology and open coat guarantee smear-free finishes even on high nickel content alloys and minimize loading on aluminum and other soft metals

	EXTRA COARSE	COARSE	MEDIUM	FINE	VERY FINE
GRIT/COLOR:	EXTRA COARSE	COARSE	MEDIUM	FINE	VERY FINE
TIER:	BEST	BEST	BEST	BEST	BEST
TRADENAME:	VORTEX RAPID PREP	VORTEX RAPID PREP	VORTEX RAPID PREP	VORTEX RAPID PREP	VORTEX RAPID PREP
ABRASIVE:	Engineered A/O	Engineered A/O	Engineered A/O	Engineered A/O	Engineered A/O
WIDTH	3-1/2	3-1/2	3-1/2	3-1/2	3-1/2
LENGTH	15-1/2	15-1/2	15-1/2	15-1/2	15-1/2
STD. PKG.	8	8	8	8	8
PART #	66623333725	66623335042	66623335118	66623333665	66623335139

Rapid Prep File and Narrow Belts

Better choice for finishing and blending applications



RAPID PREP ALUMINUM OXIDE

- Premium aluminum oxide abrasive grain coating provides up to 20% higher cut rate versus other surface conditioning belts
- Durable nylon fiber bonded to a strong Y-weight polyester backing with extremely low stretch is ideal for applications where low-stretch and durability are necessary
- Proprietary Clean Bond resin technology and open coat guarantee smear-free finishes even on high nickel content alloys and minimize loading on aluminum and other soft metals

GRIT/COLOR:	EXTRA COARSE	COARSE	MEDIUM	FINE	VERY FINE
TIER:	BETTER	BETTER	BETTER	BETTER	BETTER
TRADENAME:	RAPID PREP	RAPID PREP	RAPID PREP	RAPID PREP	RAPID PREP
ABRASIVE:	Aluminum Oxide	Aluminum Oxide	Aluminum Oxide	Aluminum Oxide	Aluminum Oxide

WIDTH	LENGTH	STD. PKG.	PART #	PART #	PART #	PART #	PART #
File Belts							
1/4	18	24		66261011420	66261012524	66623333424	66623333511
	24	24		69957392606	66261097565	66623333425	66623333512
1/2	12	24		66261003177	66261006465	66623318175	66254499884
	18	24		66261055309	66261055310	66623333426	66261055311
	24	24		66261055312	66261008972	66254490859	66261019876
3/4	18	12		66261002111	66261015808	66254490858	66261003622
	20-1/2	12		66261083899	66261003260		66623333515
1	18	12		66261007023	66261017898	66623333429	66623333518
	21	12		66623333412	66623336005	66623333430	66623333519
Narrow Belts							
3/4	80	12		66623333411	66623333505	66623333428	66623333516
1	30	12		66261019801	66623336006	66623333431	66261001972
	42	12		66261008317	66254441289	66623333432	66623333521
	60	12					66261055412
	64	12		66623333414	66623301513	66623333434	66261055413
	72	12		66261194240	66261006378	66254493830	66261005583
	132	8		66623314981			
132	10			66261011414	66254436886	66623333525	
1-1/2	60	8		66623333415	66261007644		66623303624
2	18-15/16	12	66261018226		66623333507	66623333436	66623333528
	34	12		66261063309		66623333437	66623333529
	48	10		66261006504	66261006648	66623333438	66623333531
	60	8		66623333416	66261189669	66623333439	66623333532
	72	8		66261002571	66261007757	66623333440	66261002307
	132	6				66261069525	66623333533
2-1/2	60	6		66254429365	66254441491	66623333441	66623333534
2-3/4	15-1/2	10	66623333578	66623333417	66623333508		66623333535
3	10-11/16	12	66623333580	66261018076	66261067469	66623333443	66623333536
	18	10	66254428772	66254496043	66254428776	66623333444	66261019836
	21	10	66623333584	66623333418	66261010870	66623333445	66623333537
	24	10	66254433359	66623314158		66623333446	66261055593
	72	6		66623333419	69957396833	66623333447	66261003176
	80	4		66623333420	66261007149	66623333448	66623333542
	90	4		66623333421		66623333449	66623333541
	118	4		66623333422	66623333510	66623333450	66261047121
	132	4		66254490470	66261055322	66623333451	66623333543
	3-1/2	15-1/2	8	66623333595	66261055324	66254444576	66623333452
4	24	8	66623333596	66254495931	66261031667		
	36	6			66261002321	66623333454	66623333546
	132	2		66261009056	66261006898	66623333455	66623333547
	168	2		63642576650	66261009174	66623333456	66623333548
6	48	4		66261055330	66261055331	66623333457	66261055332

Most Narrow belts are also available in our Vortex grain. If you do not see the Rapid Prep belts you need in our stock offering contact your Norton Representative for made-to-order availability.



Engineered for flexibility and fast cutting, cloth sheets and rolls have a longer life than paper. They tear cleanly and straight without shedding and are packed in a protective dispenser to eliminate waste and damage.

Categories:

All purpose, fine finishing, and screen-back

Applications:

Scouring and light deburring, scale and rust removal, blending and fine sanding, polishing lathe turnings, rolls and cylinders, and blending machine tool marks

Size Range:

Sheets: 9" x 11"

Rolls: 1" x 10 yds., 1-1/2" – 2" x 25 yds., 1" – 4" x 50 yds.

Grit Range:

40 – 600, extra coarse, coarse, medium, fine

Abrasive Grain:

Aluminum Oxide, Silicon Carbide, Emery

Machine Used:

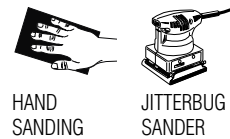

HAND
SANDING

JITTERBUG
SANDER

Cross Reference Guide

	GOOD			
NORTON	Gemini K225	Metal R243	K622 Emery	Screen-Bak Q421
3M	011K	211K, 314D	011K, Emery Cloth	481W, 483W
Hermes	RB317	RB232J	—	GS91350, GS92400
Klingspor	LS309	KL361, LS309	KL371X	—
Sait/United Abrasives	DA-F	EA-F	—	Sait-Screen
SIA	2915	2601, 2915, 2936	1600, 2601	SIA-Screen
VSM	KK114F	KK505J, KK504X	—	—

Application/Starting Recommendation Guide

Durability/Stock Removal	Conformability	Slower Cut	Waterproof
Fast Cut	Excellent Finish	Fine Finish	Load Resistant
Gemini K225	Metal R243	K622 Emery	Screen-Bak Durite Q421

Good choice for general-purpose metal and woodworking applications

GEMINI K225 ALUMINUM OXIDE

- Premium P-graded aluminum oxide abrasive for greater cut rate on general purpose metalworking application
- Flexible J-weight backing for superior conformability to complex surfaces and better finishes
- Advanced full resin bond system for exceptional grain adhesion for longer life

Good choice for small-volume metal and woodworking applications at a low initial price

METAL R243 ALUMINUM OXIDE

- Quality P-graded aluminum oxide abrasive grain delivers fast cut rate and consistent finish on metals
- Smooth, flexible J-weight cotton backing provides superior conformability to complex surfaces and better finishes
- Advanced full resin bond system provides exceptional grain adhesion for longer life on aluminum, fiberglass, composites, hard woods and soft woods



Good choice for removing rust, paint and scale from metal surfaces

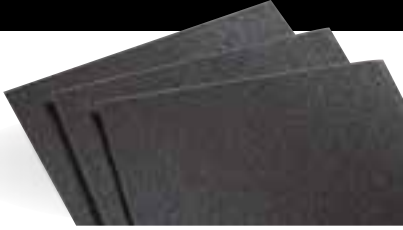

K622 EMERY

- Natural emery abrasive for scouring and polishing non-rated metals and utensils
- Abrasive is durabonded onto a flexible cloth backing for durability
- Close coat for the greatest degree of stock removal and longest life

Good choice for sanding softer materials where loading is a major problem such as plastic, copper, brass, plaster, wood, and drywall

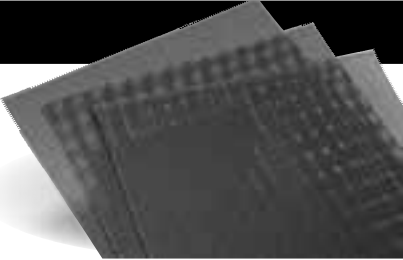

SCREEN-BAK Q421 SILICON CARBIDE

- P-graded silicon carbide for excellent cutting and non-loading properties
- Open weave screen for extreme resistance to loading when removing scale, rust and corrosion
- Open mesh design is waterproof and washable, allowing you to rinse and reuse

Cloth and Screen Rolls



TIER: GOOD		TIER: GOOD		TIER: GOOD		TIER: GOOD		TIER: GOOD	
TRADENAME: GEMINI K225		TRADENAME: GEMINI K225		TRADENAME: GEMINI K225		TRADENAME: GEMINI K225		TRADENAME: GEMINI K225	
ABRASIVE: Aluminum Oxide		ABRASIVE: Aluminum Oxide		ABRASIVE: Aluminum Oxide		ABRASIVE: Aluminum Oxide		ABRASIVE: Aluminum Oxide	
BACKING: J-Weight Cotton		BACKING: J-Weight Cotton		BACKING: J-Weight Cotton		BACKING: J-Weight Cotton		BACKING: J-Weight Cotton	
SIZE: 1" x 10 yds		SIZE: 1" x 50 yds		SIZE: 1-1/2" x 50 yds		SIZE: 2" x 50 yds		SIZE: 4" x 50 yds	
GRIT	STD. PKG.	PART #	PART #	PART #	PART #	PART #	PART #	PART #	PART #
40	1		66261058716+	66261058715+	66261058714+				
50	1		66261127728+	66261127730+	66261127732+				
60	1		66261127729+	66261127731+	66261127733+				
80	1	66261134298	66261126276	66261126288	66261126299				
100	1	66261134299	66261126275	66261126287	66261126298				
120	1	66261134300	66261126274	66261126286	66261126297			66261127285*	
150	1	66261134301	66261126273	66261126285	66261126296				
180	1	66261134302	66261126272	66261126284	66261126295				
220	1		66261126271	66261126283	66261126294				
240	1	66261134303	66261126270	66261126282	66261126293				
280	1		66261126269	66261126281	66261126292				
320	1	66261134304	66261126268	66261126280	66261126291				
400	1		66261126267	66261126279	66261126290				
600	1		66261126266	66261126278	66261126289				

+ 40 - 60 grit, are supplied in durable, but flexible X-weight cotton backing

* Packaging Standards: 4" Roll Std. Pkg.: 6 rolls



TIER: GOOD		TIER: GOOD		TIER: GOOD		TIER: GOOD		TIER: GOOD	
TRADENAME: METAL R243		TRADENAME: METAL R243		TRADENAME: METAL R243		TRADENAME: SCREEN-BAK Q421		TRADENAME: SCREEN-BAK Q421	
ABRASIVE: Aluminum Oxide		ABRASIVE: Aluminum Oxide		ABRASIVE: Aluminum Oxide		ABRASIVE: Silicon Carbide		ABRASIVE: Silicon Carbide	
BACKING: J-Weight Cotton		BACKING: J-Weight Cotton		BACKING: J-Weight Cotton		BACKING: Mesh		BACKING: Mesh	
SIZE: 1" x 50 yds		SIZE: 1-1/2" x 50 yds		SIZE: 2" x 50 yds		SIZE: 1-1/2" x 25 yds		SIZE: 2" x 25 yds	
OTHER:						Waterproof		Waterproof	
GRIT	STD. PKG.	PART #	PART #	PART #	PART #	PART #	PART #	PART #	PART #
60	1	66261136178	66261136190	66261136203					
80	1	66261136179	66261136192	66261136204		66261107275*			
100	1	66261136180	66261136194	66261136205					
120	1	66261136181	66261136195	66261136206		66261107270*		66261149811*	
150	1	66261136182	66261136196	66261136207					
180	1	66261136186	66261136199	66261136208		66261107265*			
240	1	66261136187	66261136200	66261136209					
320	1	66261136188	66261136201	66261136210					
400	1	66261136189	66261136202	66261136211					

* Packaging Standards: Screen-Bak Q421 Std. Pkg.: 10 rolls

Cloth Sheets



TIER:	GOOD	GOOD	GOOD	GOOD
TRADENAME:	GEMINI K225	METAL R243	K622 EMERY	SCREEN-BAK Q421
ABRASIVE:	Aluminum Oxide	Aluminum Oxide	Emery	Silicon Carbide
BACKING:	J-Weight Cotton	J-Weight Cotton	J-Weight Cotton	Mesh
OTHER:				Waterproof

SIZE (W x L)	GRIT	PKG./CASE	PART #	PART #	PART #	PKG./CASE	PART #
9 x 11	40	25/125	66261 058713+				
	50	25/125	66261 101862+				
	60	25/125	66261 101861+				
	80	25/125	66261 126340	66261 179998		25/125	66261 100960
	100	50/250	66261 126339	66261 181503		25/125	66261 100955
	120	50/250	66261 126338	66261 181504		25/125	66261 100950
	150	50/250	66261 126337	66261 181505		25/125	66261 100945
	180	50/250	66261 126336	66261 180005		25/125	66261 100940
	220	50/250	66261 126335			25/125	66261 100935
	240	50/250	66261 126334	66261 181507			
	280	50/250	66261 126333				
	320	50/250	66261 126332	66261 180006		25/125	66261 100920
	400	50/250	66261 126331	66261 181509		25/125	66261 100915
	600	50/250	66261 126330				
	Extra Coarse	25/125					66261 101255
	Coarse	25/125					076607 01307
	Medium	50/250					076607 01309
	Fine	50/250					076607 01308

+ 40 - 60 grit are supplied in durable, but flexible X-weight cotton backing





Paper sheets and rolls are engineered for optimum performance when sanding metal, wood, composites and painted surfaces. The sheets are packed in protective packaging to eliminate waste and permit easy, neat storage.

Categories:

Applications:

Size Range:

Grit Range:

Abrasive Grain:

Paper Weights:

Machine Used:

All purpose, wood sanding, stearated (non-loading), waterproof, and heavyweight
 Light-duty metal sanding, primer sanding, defect removal from painted surfaces, filler sanding, sanding and finishing of composites and fiberglass, bare wood sanding, sanding between sealer coats
 Full Sheets, Cut Sheets, File Strips and Rolls
 36 – 2500
 Ceramic Alumina, Zirconia Alumina, Aluminum Oxide, Silicon Carbide, and Garnet
 Heavyweight – E; Lightweight – A through D



HAND
SANDING



JITTERBUG
SANDER



SANDING
BOARD

Material-to-Product Recommendation Guide

	BEST			BETTER			GOOD						
	Blaze A995	Dry Ice A975	A2750P	Black Ice T214	Black Ice T401	A259PS	Durite A475	Blue-Bak T414	Gold Reserve A296	PB273	Garnet	TufBak T461	Other
Unfinished Metal	◆	◆	◆						◆	◆			
Primed / Painted Surfaces / Between Coats	◆	◆	◆				◆		◆	◆			
Fiberglass / Composites	◆	◆	◆				◆		◆	◆			
Bare Wood	◆	◆	◆								◆		
											A511, A513, A514		
Clear Coat Sanding				◆	◆								◆
Sealer Sanding	◆	◆	◆				◆		◆	◆			
Lacquer Sanding				◆	◆			◆					◆
Wet Sanding				◆	◆			◆					◆
Paint Stripping	◆	◆	◆				◆						A290
All Purpose	◆	◆	◆				◆						A212, A213, A211

Cross Reference Guide

NORTON	3M	Hermes	Klingspor	Mirka	SIA	VSM
STEARATED (NON-LOADING)						
Blaze A995	732U, 737U, 755L, 775L	CR116	—	—	—	—
Dry Ice A975	334U	—	PS36	—	Siaprime 5550	—
A2750P	216U, 255L, 236U, 260L, 334U	VC154-LL	PS33, PS73W	Q-Silver, Royal Micro	1940, 1944, 1950	—
A259PS	216U, 255L, 236U, 260L, 334U	—	—	—	—	—
Durite A475	405N, 414N, 415U, 426U, 435U	SF168	PL35, PS14	CaratFlex, PolarStar	1748	CP131A
Gold Reserve A296 / PB273	216U, 236U, 316U, 315U, NX	VC154-LL	PS33, PS73W	Q-Silver, Royal Micro, Bulldog Gold	19,401,950	MP10
WATERPROOF						
Blue Ice T214	213Q	WAFlex28	—	—	1913, 1951, 1600	—
Blue Ice T401	401Q, 414Q, 486Q	WSFlex16	PL35	Waterproof (A)	—	CP918A
Blue-Bak T414	413Q	WSFlex 16	PS14	Waterproof (A)	—	CP918A/C
TufBak T461	431Q	WSFlex 18	PS14	—	1727	CP918A/C
ALL PURPOSE/WOOD						
A211	230U, 240N, 346U	—	—	—	—	—
A212	210N	—	PL31	—	—	—
A213	230N	—	PL31	—	—	—
Garnet A511	110N	—	PS10	—	1400	—
Garnet A513	130N	GCAB	—	—	—	—
Garnet A514	140N	GCAB	—	—	—	—
HEAVYWEIGHT PAPER						
BlueFire H875P	740I, 745I, 750U, 751U, 751I	BW110	PS36	Royal CRS. Cut	1820, 1919, 1948	KP510E, KP709

Application/Grit Recommendation Guide

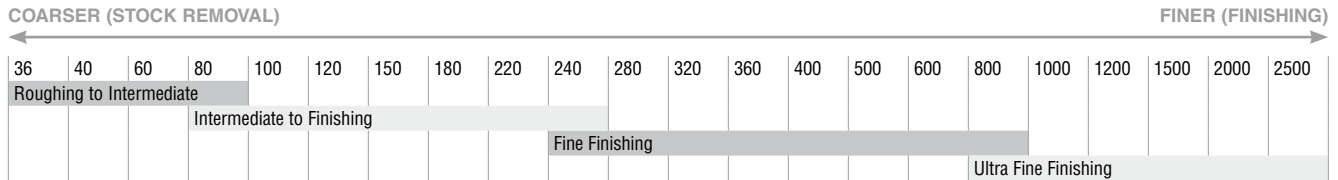

Recommended Backing Weight

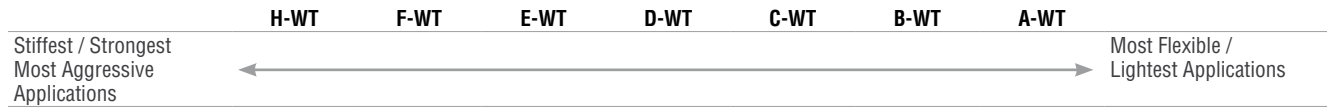

Paper Rolls

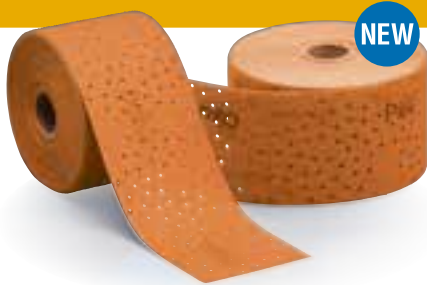

Best choice for fast cut rate and maximum dust extraction

BLAZE A995 MULTI-AIR CYCLONIC CERAMIC ALUMINA

- P-graded next-generation ceramic aluminum oxide abrasive for fastest cut rate and longest life with innovative spiral hole design to optimize dust extraction
- Proprietary D-weight Polyester-reinforced, flexible latex-saturated backing for 100% improvement in tear strength and edge durability providing longer life in all applications
- Waterbased, non-loading (No-Fil) stearate resists clogging and increases roll life; hook and loop (NorGrip) back for easy mounting and changing



Best choice for the most demanding dry sanding applications

DRYICE A975 CERAMIC ALUMINA

- P-graded, 100% SG ceramic alumina abrasive delivers fastest cut rate and longest life of any paper roll; available in Multi-Air Cyclonic version with laser-cut, spiral, vacuum-hole design to maximizes dust extraction
- Unique fiber reinforced, flexible B-wt. latex saturated paper backing for 50% - 60% improvement in tear strength while retaining flexibility; perforated for easy sizing
- Water-based non-pigmented stearate No-Fil coating provides improved load resistance and no color transfer to work



Better choice for high performance dry sanding applications

A2750P ALUMINUM OXIDE

- Premium P-graded, heat treated, toughened aluminum oxide abrasive delivers superior life, fast cut rate, consistent finish
- Unique fiber reinforced, flexible B-weight latex saturated backing provides 50% - 60% improvement in tear strength while retaining flexibility
- Water-based, non-pigmented stearate No-Fil coating provides maximum load resistance; available in Multi-Air Cyclonic version for maximum dust collection

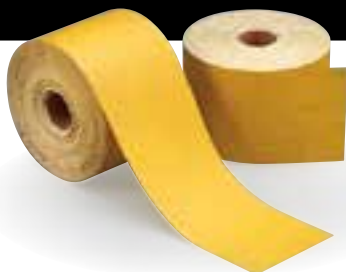

Good choice and value for dry sanding and finishing aluminum, fiberglass, composites, hard woods and soft woods

A296 GOLD ALUMINUM OXIDE

- P-graded premium aluminum oxide abrasive produces a quick, cool cut and a more consistent surface finish
- Strong paper backing resists tearing while staying conformable and flexible
- Water-based, non-loading No-Fil stearate coating minimizes clogging and increases disc life

Paper Rolls *continued*

Hook and Loop
Paper Rolls

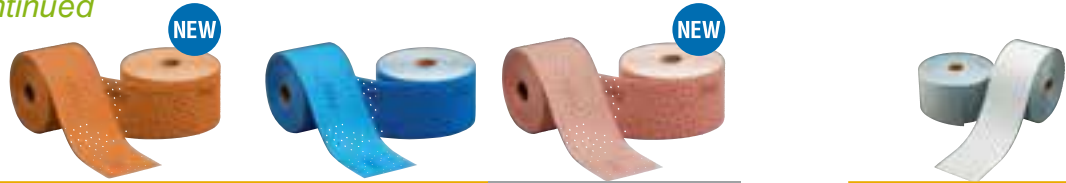

TIER:	BEST	BEST	BETTER	BEST	
TRADENAME:	BLAZE A995 NO-FIL MULTI-AIR CYCLONIC	DRY ICE A975 NO-FIL MULTI-AIR CYCLONIC	A2750P NO-FIL MULTI-AIR CYCLONIC	DRY ICE A975 NO-FIL	
ABRASIVE:	Ceramic Alumina	Ceramic Alumina	Aluminum Oxide	Ceramic Alumina	
BACKING WEIGHT:	D-Weight.	C- & B-Weight	D-Weight	B-Weight.	
BACKING ATTACHMENT:	Hook & Loop	Hook & Loop	Hook & Loop	Hook & Loop	
OTHER:	P-Graded	P-Graded	P-Graded	P-Graded	
SIZE:	2-3/4" x 13 yd	2-3/4" x 13 yd	2-3/4" x 13 yd	2-3/4" x 13 yd	
GRIT	PKG./CASE	PART #	PART #	PKG./CASE	PART #
80	1/4	699573 08899	636425 06113	1/4	636425 06261
120	1/4	699573 08900	636425 06114	1/4	636425 06259
150	1/4	699573 08901	636425 06117	1/4	636425 06258
180	1/4	699573 08902	636425 06118	1/4	636425 06257
220	1/4	699573 08903	636425 06119	1/4	636425 06256
240	1/4		636425 06120		
320	1/4		636425 06121	1/4	636425 06255
400	1/4		636425 06122	1/4	666233 29518
500	1/4		636425 06123	1/4	666233 29547
600	1/4		636425 06124	1/4	666233 29548

2-3/4" wide hook and loop paper rolls are perforated at 2-3/4" which allows use on all standard lengths of hand blocks and file boards. Additional grit sizes available, contact your Norton rep for more details.

PSA (Pressure Sensitive Adhesive) Paper Rolls



TIER:	BEST	BEST	BEST	BETTER	BETTER	BETTER	BETTER	GOOD
TRADENAME:	DRY ICE A975 NO-FIL	DRY ICE A975 NO-FIL	DRY ICE A975 NO-FIL	A275 OP NO-FIL	A275 OP NO-FIL	A275 OP NO-FIL	A275 OP NO-FIL	GOLD RESERVE A296 NO-FIL
ABRASIVE:	Ceramic Alumina	Ceramic Alumina	Ceramic Alumina	Aluminum Oxide	Aluminum Oxide	Aluminum Oxide	Aluminum Oxide	Aluminum Oxide
BACKING WEIGHT:	C-Weight.	C-Weight.	B-Weight.	B-Weight.	B-Weight.	B-Weight.	B-Weight.	B-Weight
BACKING ATTACHMENT:	PSA	PSA	PSA	PSA	PSA	PSA	PSA	PSA
OTHER:	P-Graded	P-Graded	P-Graded	P-Graded	P-Graded	P-Graded	P-Graded	P-Graded
SIZE:	2-3/4" x 25 yd	2-3/4" x 30 yd	2-3/4" x 45 yd	2-3/4" x 25 yd	2-3/4" x 30 yd	2-3/4" x 45 yd	4-1/2 x 10 yd	2-3/4" x 25 yd
GRIT	PKG./CASE	PART #	PART #	PART #	PART #	PART #	PART #	PART #
80	1/5	662611 49566			662611 131691		662611 131697	636425 06153
100	1/5					662611 131690	662611 131696	
120	1/5		662611 49564			662611 131689	662611 131695	636425 06152
150	1/5			662611 49563			662611 131688	662611 131694
180	1/5			662611 49562			662611 131687	662611 131693
220	1/5			662611 49561			662611 131686	662611 131692
240	1/5						662611 131685	
320	1/5			662611 49558			662611 131683	636425 06148
400	1/5			662611 49557			662611 131681	636425 06147
600	1/5						662611 131679	

Additional attachment options available as non-stock, contact your Norton rep for more details.

Roll Accessories

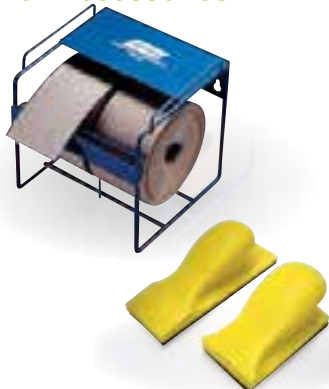

PSA Roll Dispenser

- Heavy-duty wire dispenser has a vinyl coating to protect the work surface
- Accommodates two 2-3/4" PSA rolls; stackable for multi-grit operations. Attach to wall or mount on cabinet

DESCRIPTION	STD. PKG.	PART #
PSA Roll Dispenser	1	636425 42773

PSA/Hook & Loop Sanding Blocks

- Ergonomically-shaped flexible foam blocks used with 2-3/4" rolls, fit comfortably in your hand
- Firm block produces a truly flat surface
- The soft block is designed for flat surfaces and contours

SIZE	DESCRIPTION	STD. PKG.	BACKING ATTACHMENT: PSA		Hook & Loop	
			PART #	PART #	PART #	PART #
2-3/4 x 5	Soft	5	636425 42090		636425 42092	
2-3/4 x 5	Firm	5	636425 42091		636425 42093	
2-3/4 x 7-3/4	Soft	5			636425 42095	
2-3/4 x 7-3/4	Firm	5	636425 42094			

Paper File Strips

Better choice for soft material applications

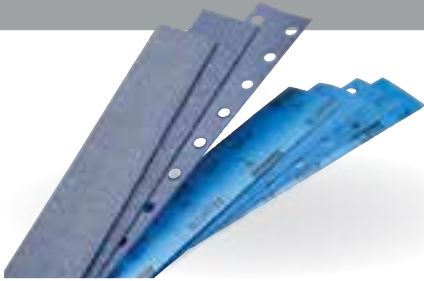

BLUEFIRE H875P ZIRCONIA ALUMINA

- Strong zirconia alumina plus abrasive provides 2 - 3 times life over aluminum oxide products
- Strong E-weight paper, synthetically-coated for excellent durability and chip resistance plus superior bond system optimizes grain adhesion and extends product life
- Non-stearated (no anti-loading agents); non-contamination often required for prime auto and aerospace paint applications

Paper File Strips
PSA (Pressure Sensitive Adhesive)
and Non-PSA

TIER:	BEST				BETTER		BETTER		BETTER	
TRADENAME:	A2750P NO-FIL	A2750P NO-FIL	A2750P NO-FIL	A2750P NO-FIL	BLUEFIRE H875P	BLUEFIRE H875P	BLUEFIRE H875P	BLUEFIRE H875P	BLUEFIRE H875P	BLUEFIRE H875P
ABRASIVE:	A/O	A/O	A/O	A/O	Z/A	Z/A	Z/A	Z/A	Z/A	Z/A
BACKING WEIGHT:	B-Weight	B-Weight	B-Weight	B-Weight	E-Weight	E-Weight	E-Weight	E-Weight	E-Weight	E-Weight
BACKING ATTACHMENT:	Non-PSA	PSA	Hook/Loop	Hook/Loop Vac	Non-PSA	PSA	PSA	PSA	PSA	Hook/Loop
OTHER:	P-Graded	P-Graded	P-Graded	P-Graded						

SIZE (W x L)	GRIT	PKG./CASE	PART #	PART #	PART #	PART #	PKG./CASE	PART #	PART #	PKG./CASE	PART #
2-3/4 x 16	100	50/500									
	120	50/500									
	180	50/500									
2-3/4 x 16-1/2	36						50/250		662611 23610	25/125	662611 23616
	40						50/250		662611 23609	25/125	662611 23615
	80	50/500		662611 31640		662611 31646	50/250		662611 23608	25/125	662611 23614
	100	50/500		662611 31639		662611 31645					
	120	50/500				662611 31644					
	150	50/500		662611 31637		662611 31643					
	180	50/500		662611 31636		662611 31642					
	220	50/500				662611 31641					
2-3/4 x 17-1/2	36						50/250	662611 23622			
	40						50/250	662611 23621			
	80	50/500	662611 31652				50/250	662611 23620			
	100	50/500	662611 31651				50/250	662611 26512			
	120	50/500	662611 31650								
	150	50/500	662611 31649								
	180	50/500	662611 31648				50/250	662611 26511			

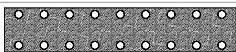

VACUUM HOLE PATTERN FOR
2-3/4 X 16 FILE STRIPS

Sanding Boards

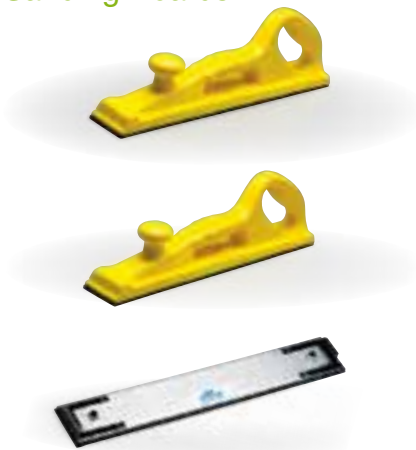

PSA/Non-PSA Sanding Board

- This sanding board has a cushioned surface
- Spring clips mounted at each end securely hold 2-3/4" x 16-1/2" PSA file strips and 2-3/4" x 17-1/2" non-PSA file strips

Hook and Loop and Non-PSA Sanding Board

- Lightweight, rugged design for easy sanding of plastic fillers
- Spring clips mounted at each end securely hold 2-3/4" x 16-1/2" hook and loop file strips and 2-3/4" x 17-1/2" non-PSA file strips
- Air file shoe eliminates the need for clips. The quick-change backing positively locks and unlocks for fast use.

DESCRIPTION	STD. PKG.	PART #
PSA/Non-PSA File Strip Sanding Board	6	636425 42724
Hook and Loop/Non-PSA File Strip Sanding Board	5	636425 52836
Hook and Loop Air File Shoe	5	636425 52835

Stearated (Non-Loading) 9" x 11" Sheets

The best choice for sanding painted surfaces, composites, plastics or any material that tends to load



A2750P NO-FIL ALUMINUM OXIDE

- Premium, P-graded, heat-treated aluminum oxide abrasive for consistent surface finish, exceptional performance on all surfaces and coatings
- Unique fiber-reinforced, B-weight latex-saturated backing for 50 - 60 percent improvement in tear strength, exceptional flexibility, can be folded without cracking
- Non-pigmented, water based stearate (anti-clog) coating, open coat for best resistance to clogging and loading during sanding

Best choice for moderate material removal

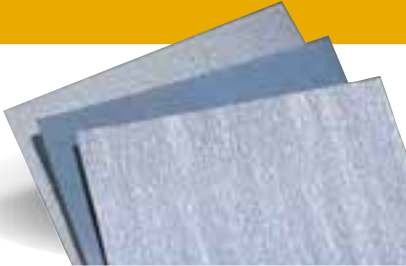

A259PS NO-FIL ALUMINUM OXIDE

- Premium heat-treated abrasive offers faster cut and long sanding life
- Open coat, non-pigmented, water-based stearate coating prevents color transfer and minimizes loading
- Increased backing weight, fiber-reinforcement and latex saturation offers better grain retention and tear-resistance yet is highly flexible for easy folding and unfolding

The better choice for gel coats, hard composite substrates, abrasion-resistant coatings, and woodworking applications

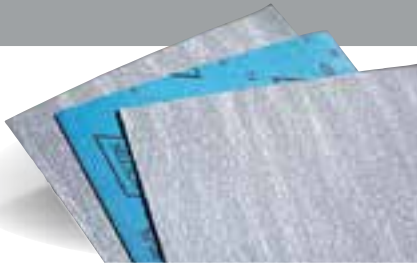

DURITE A475 NO-FIL SILICON CARBIDE

- P-graded, silicon carbide abrasive for easy penetration of the hardest surfaces
- Water based stearate, non-pigmented, No-Fil coating resists loading for the longest usable product life; no color transfer to work
- Fiber-reinforced, latex paper backing provides flexibility and resistance to tearing

Good choice for fast cuts and an even finish



PB273 NO-FIL ALUMINUM OXIDE

- P-graded, sharp light-brown, aluminum oxide abrasive for fast cut rate, extended life and consistent finish
- Water based non-pigmented stearate provides maximum load resistance and extended life; no dye in coating means no risk of color transfer or finish contamination
- Flexible latex-saturated B-weight backing, with a full resin bond and open coat for improved life

Stearated (Non-Loading) 9" x 11" Sheets *continued*

9 x 11
Paper Sheets



		BEST		BETTER		GOOD	
		JOBPACK					
TIER:		BEST		BETTER		GOOD	
TRADENAME:		A2750P NO-FIL		A259PS NO-FIL		DURITE A475 NO-FIL	
ABRASIVE:		Aluminum Oxide		Aluminum Oxide		Silicon Carbide	
BACKING WEIGHT:		B-Weight		C- & B-Weight		B-Weight	
OTHER:		P-Graded		P-Graded		P-Graded	
SIZE (W x L)	GRIT	PKG./ CASE	PART #	PART #	PART #	PART #	
9 x 11	80	50/250	662611 31634	076607 68174*	662544 87393	666233 11878	
	100	100/500	662611 31633	076607 68173*	662544 87394	666233 11877	
	120	100/500	662611 31632	076607 68172*	662544 87395	666233 11876	
	150	100/500	662611 31631	076607 68171*	662544 87396	666233 11875	
	180	100/500	662611 31630	076607 68168*	662544 87397	666233 11874	
	220	100/500	662611 31629	076607 68167*	662544 87398	666233 11873	
	240	100/500	662611 31628		662544 87399	666233 11879	
	280	100/500	662611 31627				
	320	100/500	662611 31626	076607 68166*	662544 87400	666233 11871	
	400	100/500	662611 31624	076607 68165*		666233 11870	
	500	100/500	662611 31623				
	600	100/500	662611 31622				
	800	100/500	662611 31621				
	1000	100/500	662611 31620				
	1200	100/500	662611 31619				
	1500	100/500	662611 31618				

* Packaging Standards: A259PS Job Packs: 20 sheets per pack / 10 packs per standard package for a total of 200 sheets

Rubber Hand Sanding Blocks

- Resilient rubber blocks that conform well to mild contours and flat surfaces

DESCRIPTION	STD. PKG.	PART #
2-3/4 x 5	5	076607 01889



Waterproof 9" x 11" Sheets

Best choice for superior cut and life in wet applications

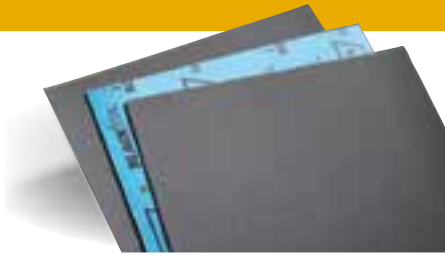

BLACK ICE T214 ALUMINUM OXIDE WATERPROOF

- Premium, P-graded, heat-treated aluminum oxide abrasive for ultimate cut and life in wet applications
- Strong resin bond for longer life in wet applications
- High-strength B-weight waterproof latex paper backing is extremely flexible, environmentally stable, and resists humidity-caused curling

Best choice for superior finish in wet applications

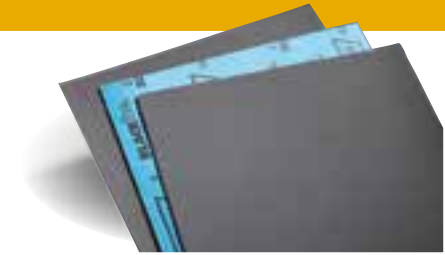

BLACK ICE T401 SILICON CARBIDE WATERPROOF

- Premium, JIS graded ultra-fine silicon carbide abrasive provides the ultimate finish in wet applications
- Strong resin bond for longer life in wet applications
- High-strength B-weight waterproof latex paper backing is extremely flexible, environmentally stable, and resists humidity-caused curling

Better choice for wet finishing applications

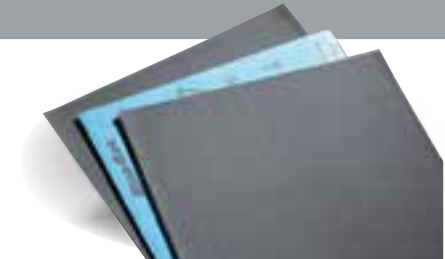

BLUE-BAK T414 SILICON CARBIDE

- Sharp, ANSI graded silicon carbide abrasive for exceptional finishes in wet applications
- Strong resin bond for longer life in wet applications
- High-strength B-weight waterproof latex paper backing is extremely flexible, environmentally stable, and resists humidity-caused curling

Good choice for medium material removal in wet applications



TUFBAK T461 SILICON CARBIDE

- ANSI graded silicon carbide abrasive for fast cutting with excellent finish in wet applications
- Advanced resin bond system for excellent flexibility and abrasive adhesion
- Strong, waterproof C-weight backing is ideal for more aggressive applications while being environmentally stable, resists product curl in humidity

Waterproof 9" x 11" Sheets *continued*

9 x 11
Paper Sheets



		TIER: BEST	BEST	BETTER	GOOD
		TRADENAME: BLACK ICE T214	BLACK ICE T401	BLUE-BAK T414	TUFBAK T461
		ABRASIVE: Aluminum Oxide	Silicon Carbide	Silicon Carbide	Silicon Carbide
		BACKING WEIGHT: B-Weight	B-Weight	B-Weight	C-Weight
		OTHER: P-Graded	JIS Graded	ANSI Graded	ANSI Graded
SIZE (W x L)	GRIT	PKG./CASE	PART #	PART #	PART #
9 x 11	60	50/250			662611 01175
	80	50/250			662611 01170
	100	50/250			662611 01165
	120	50/250			662611 01160
	150	50/250			662611 01155
	180	50/250			662611 01150
	220	50/250	662611 39389		662611 39367
	240	50/250	662611 39388		662611 39366
	280	50/250			662611 39365
	320	50/250	662611 39386		662611 39364
	360	50/250			662611 39363
	400	50/250	662611 39385		662611 39362
	500	50/250	662611 39384		662611 39361
	600	50/250	662611 39383		662611 39360
	800	50/250	662611 39382		662611 30334
	1000	50/250		662611 39381	
	1200	50/250		662611 39380	
	1500	50/250		662611 39379	
	2000	50/250		662611 39378	
	2500	50/250		662611 39377	

Waterproof Sanding Blocks – with “Grabbing” Power



Dual Density Wet Sanding Block

- No adhesive required: simply wrap a 5-1/2" x 9" (9" x 11" cut in half) sheet around the block
- The dense side is for more aggressive blocking, while the soft side is for color sanding
- Equalizes sanding pressure for fine grit applications

Holey Block

- No adhesive required: simply wrap a 5-1/2" x 9" (9" x 11" cut in half) sheet around the block
- A rugged, semi-rigid, multi-purpose sanding block engineered for flat to medium curved surfaces
- A tactical hole pattern side provides numerous cutting edges to create a 30% faster cut rate
- The plain side provides firmness and a comfortable, easy-to-hold surface

DESCRIPTION	STD. PKG.	PART #
Wet Sanding Block	12	636425 03728
Holey Block	8	636425 03729

All-Purpose 9" x 11" Paper Sheets

Good choice for your wood, metal or composite sanding projects



A211/A212/A213 ALUMINUM OXIDE

- P-graded, aluminum oxide grain, open-coat provides aggressive, long-lasting cutting action
- Use for dry, general purpose hand sanding on hardwood, metal, and composites
- Available in multiple backing weights: A212 A-weight; A213 C-weight, A211 D-weight

Good choice for use on soft woods such as pine



A513/A511 GARNET

- Natural garnet abrasive is ideal for soft woods, such as pine, and produces an excellent, consistent finish
- Use dry on bare wood prior to coating
- Available in two backing weights: A511 A-wt. and A513 C-wt. for heavy-duty to light-duty hand sanding

9 x 11
Paper Sheets



TIER:	GOOD	GOOD	GOOD	GOOD	GOOD	GOOD	GOOD
TRADENAME:	A211	A213	A212	MULTISAND A213/A212	A513	A511	WOODSAND A513/A511
ABRASIVE:	Aluminum Oxide	Aluminum Oxide	Aluminum Oxide	Aluminum Oxide	Garnet	Garnet	Garnet
BACKING WEIGHT:	D-Weight	C-Weight	A-Weight	D-, C- & A-Weight	D- & C-Weight	A-Weight	D-, C- & A-Weight
OTHER:	P-Graded	P-Graded	P-Graded	P-Graded			

SIZE (W x L)	GRIT	PKG./CASE	PART #	PART #	PART #	PART #	PART #	PART #	PART #
9 x 11	36	25/125	662611 00335						
	40	25/125	662611 00330						
	50	50/250	662611 00325						
	60	50/250		662611 00320			662611 01560		
	80	50/250		662611 00315			662611 01555	662611 01505	076607 01584*
	100	100/500		662611 00295		076607 00358*	662611 01535	662611 01500	076607 01583*
	120	100/500		662611 00290		076607 00357*	662611 01530	662611 01495	076607 01582*
	150	100/500		662611 00285		076607 00356*	662611 01525	662611 01490	076607 01581*
	180	100/500			662611 00245	076607 00355*		662611 01489	076607 01580*
	220	100/500			076607 00156	076607 00354*		662611 01488	076607 01579*
	Asst+	100/500				076607 00365*			

* Packaging Standards: Job Packs: 25 sheets per pack / 10 packs per standard package for a total of 250 sheets
+ Assorted contains 6 each of 60, 100, 150 grit and 7 each of 220 grit

3-2/3 x 9
Paper Cut Sheets



TIER:	GOOD	GOOD
TRADENAME:	A290 NO-FIL	A213
ABRASIVE:	Aluminum Oxide	Aluminum Oxide
BACKING WEIGHT:	C-Weight	C-Weight
OTHER:	P-Graded	P-Graded

SIZE (W x L)	GRIT	PKG./CASE	PART #	PART #
3-2/3 x 9	60	100/1000		662611 02925
	80	100/1000	662611 01119	662611 02920
	100	100/1000		662611 02900
	180	100/1000	662611 01124	
	220	100/1000	662611 01123	



Surface finishing rolls are made of a non-woven nylon web impregnated with abrasive grain and resin bond.

Applications:

Light- to heavy-duty cleaning, deburring, blending, polishing, and finishing of metal, wood, composite, plastics, stone, solid surface and painted surfaces.

Abrasive Grain:

Aluminum Oxide, Silicon Carbide

Grit Range:

Medium (M), Fine (F), Very Fine (VF), Ultra Fine (UF), Micro Fine (MF)

Roll Features:

- Economical alternative to cut pads
- Can be cut to specific sizes

Machine Used:

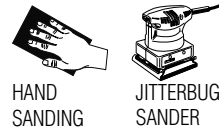

HAND
SANDING

JITTERBUG
SANDER

Application/Grit Recommendation Guide

MORE AGGRESSIVE, ROUGHER FINISH

LESS AGGRESSIVE, FINER FINISH



	#740	#644	#747	#635	#851	#777	HIGH STRENGTH
PRODUCT #:	#740	#644	#747	#635	#851	#777	HIGH STRENGTH
COLOR:	Dark Tan	Maroon	Maroon	Gray	Gray	Maroon	Maroon
DESCRIPTION:	Heavy Duty	GP – Fine	GP Plus – Very Fine	Clean & Finish	General Cleaning	General Purpose	High Strength
ABRASIVE:	AO	AO	AO	SC	SC	AO	AO
GRIT SIZE:	Medium 100 - 150	Fine 180 - 220	Very Fine 240 - 360	Ultra Fine 400 - 600	Very Fine 240 - 360	Very Fine 240 - 360	Medium 100 - 150
STEEL WOOL EQUIVALENT:	4 Extra Coarse	2 Medium Coarse	1 Medium	00 Very Fine	00 Very Fine	1 Medium	4 Extra Coarse
APPLICATIONS:	<ul style="list-style-type: none"> • Smear-free Clean Bond technology • 2X life • Most durable and aggressive cutting pad • Heavy-duty removal <ul style="list-style-type: none"> » rust » oxidation • Deburring 	<ul style="list-style-type: none"> • Cleaning and deburring <ul style="list-style-type: none"> » machinery » metal parts » plastic » solid surface » stone 	<ul style="list-style-type: none"> • Light cleaning, deburring and finishing <ul style="list-style-type: none"> » machinery » metal parts » plastic » solid surface » stone 	<ul style="list-style-type: none"> • Light cleaning and finishing of most surfaces <ul style="list-style-type: none"> » steel, aluminum » denibbing plastic » scuffing acrylics 	<ul style="list-style-type: none"> • Light cleaning and finishing of most surfaces <ul style="list-style-type: none"> » steel, aluminum » denibbing plastic » scuffing acrylics 	<ul style="list-style-type: none"> • Light cleaning, deburring and finishing <ul style="list-style-type: none"> » machinery » metal parts » plastic » solid surface » stone 	<ul style="list-style-type: none"> • Moderate deburring and surface blending

SIZE (W x L)	COLOR	DESCRIPTION	ABRASIVE	GRIT SIZE	STD. PKG.	TIER: BEST		BETTER
						PART #	PART #	
Non-Woven Rolls								
4" x 30 Ft.	Maroon	High Strength Roll	A/O	M	3	662610	06358	
	Dark Tan	740 Heavy-Duty Roll	A/O	M	3			662610 10081
	Maroon	644 General Purpose Fine Roll	A/O	F	4			662610 58364
	Maroon	777 General Purpose Very Fine Roll	A/O	VF	4	662610	06373	662610 58361
	Maroon	747 General Purpose Plus Roll	A/O	VF	4			662610 51701
	Gray	851 General Cleaning Roll	S/C	VF	4			662610 58360
	Gray	635 Clean & Finish Roll	S/C	UF	5			662610 58357
6" x 30 Ft.	Maroon	High Strength Roll	A/O	M	2	662610	05182	
	Maroon	747 General Purpose Plus Roll	A/O	VF	3			662610 16430
	Maroon	777 General Purpose Very Fine Roll	A/O	VF	3	662610	04281	662610 58376
	Gray	851 General Cleaning Roll	S/C	VF	3			662610 58377
2" x 15 Ft. Handy Roll Pack	Assorted	1 each A/O Fine, A/O VF, SC MF	–	–	1			662610 08108



Flexible, abrasive sanding sponges for a wide variety of curved, contoured or flat surface applications on wood, metal, paint, plastic, ceramics and drywall.

Applications:

Light stock removal, sanding sealer and wash-coats, touch-up or repair of primer, sanding contours and intricate shapes, and finishing

Benefits:

- Can be used wet or dry
- Clog resistant, washable, reusable
- Easy to use, can be folded without cracking
- Conformable
- Generate a consistent surface finish

Machine Used:



HAND
SANDING

Why Choose Abrasive Sponges Versus Conventional Sheets?

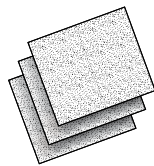
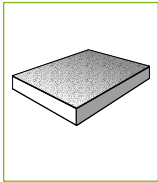

Eliminate Clogging

- The combination of flexible foam backing material and abrasive grit adhesion continually releases sanded material
- Any clogging can be washed out

Pressure Control

- Foam backing allows optimum pressure distribution to prevent sanding through surfaces
- Pressure spots are eliminated providing even surface pattern

Adapt to Contours

- Flexible foam allows adaptability to contours, shapes or areas of limited access
- No folding or buckling results in an even pattern without scratching

Surface Finishing Chart – Contour Sponges versus Sheets

	← COARSER → FINER →												
SHEETS	P150	P180	P220	P280	P320	P400	P500	P600	P800	P1000	P1200	P1500	P2000
SPONGES	Medium 60		Fine 100		Extra Fine 150		Super Fine 180		Ultra Fine 220		Micro Fine 280/320		

Surface Finishing Chart – Sponges versus Sheets

	← COARSER → FINER →													
SHEETS	P80	P100	P120	P150	P180	P220	P280	P320	P400	P500	P600	P800	P1000	P1200
SPONGES	Extra Coarse 36		Coarse 60		Medium 80 - 120		Fine 120 - 150		Very Fine 180 - 220				Micro Fine 280 - 320	

Cross Reference Guide

	BETTER	GOOD	GOOD	GOOD	GOOD	GOOD
NORTON	SoftTouch	Contour	Small Area	Profile	Sealer Sanding	Flexible
3M	Softback	Contour	Full Size	High Flexibility	Woodworking	Pro Pads
Hermes	Single Side	–	Four Sided	–	Two Sided	–
Klingspor	–	–	–	–	Foam Sanding Pad	–
SIA	Flat Pad	–	Standard Block	–	Standard Pad	–

For hand-sanding or finishing flat, curved, contoured and hard-to-reach areas on wood, metal, composites, paint and solid surfaces

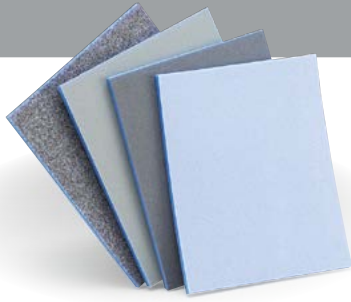

SOFTTOUCH CONTOUR SPONGES – COATED 1 SIDE

- Superior flexibility
- Premium foam substrate provides for an extremely smooth and uniform sanded surface

SIZE (W x L x T)	GRIT	STD. PKG.	PART #
4-1/2 x 5-1/2 x 3/16	60 Medium	80	076607 03074
	100 Fine	80	076607 03075
	180 Super Fine	80	076607 03076
	220 Ultra Fine	80	076607 03077
	280 Micro Fine	80	076607 03078

Good for sanding small diameters and contours



CONTOUR SPONGES – COATED 1 SIDE

- Thin, flexible; good for sanding small diameters and contours such as ceramics, spindles, turnings and railings

SIZE (W x L x T)	GRIT	STD. PKG.	PART #
4-1/2 x 5-1/2 x 3/16	100 Fine	100	076607 02257
	150 Extra Fine	100	076607 02256
	220 Ultra Fine	100	076607 02255

Good for a wide variety of materials and sanding applications where moderate flexibility is needed

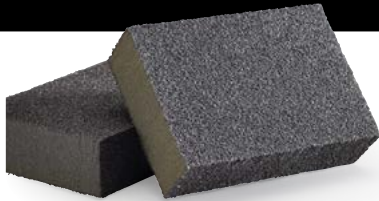

SMALL AREA GENERAL PURPOSE SPONGES – COATED 4 SIDES

- Medium to firm density open cell polyurethane foam provides uniform support and moderately aggressive cutting action while generating a smooth surface

SIZE (W x L x T)	GRIT	STD. PKG.	PART #	BULK PKG.	PART #
4 x 2-3/4 x 1	36/80	24	076607 49505	250	076607 04735
	Ex. Coarse/Med				
	80/80	24	076607 49507	250	076607 01875
	Med/Med				
	80/120	24	076607 49504	250	076607 02600
	Med/Fine				
	120/120	24	076607 49506		
	Fine/Fine				

Good for corners and flat surfaces on wood, metal, plastic and paint



PROFILE SPONGES – COATED 3 SIDES

- Ideal for cabinet sanding of raised profile doors

SIZE (W x L x T)	GRIT	STD. PKG.	PART #
4 x 2-3/4 x 1/2	100 Medium	500	636425 6313

Good for sanding primers, sealers and between coats on furniture and cabinets

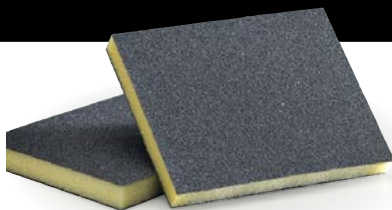

SEALER SANDING SPONGES – COATED 2 SIDES

- Very flexible; silicon carbide abrasive for sanding primers, sealers and between coats on furniture and cabinets

SIZE (W x L x T)	GRIT	BULK PKG.	PART #
4-3/4 x 3-3/4 x 1/2	36 Extra Coarse	250	636425 02538
	60 Coarse	250	636425 52870
	100 Medium	250	636425 52869
	220 VeryFine	250	636425 52868

Ideal for final sanding of surfaces, primer sanding, and between coats sanding



FLEXIBLE ABRASIVE SPONGES – COATED 1 SIDE

- Best initial price point for abrasive sponges

SIZE (W x L x T)	GRIT	STD. PKG.	PART #	BULK PKG.	PART #
3 x 4 x 1/2	60 Coarse	48	076607 04068	108	076607 01110
	80 Medium	48	076607 04067	108	076607 04070
	100 Medium	48	076607 04066	108	076607 00950
	150 Fine	48	076607 04065	108	076607 00949
	220 Very Fine			108	076607 04069

Non-Woven Hand Pads and Sponges



Surface finishing hand pads are made of a non-woven nylon web impregnated with abrasive grain and resin bond.

Applications:

Light- to heavy-duty cleaning, deburring, blending, polishing, and finishing of metal, wood, composite, plastics, stone, solid surface and painted surfaces.

Abrasive Grain:

Aluminum Oxide, Silicon Carbide

Grit Range:

Medium (M), Fine (F), Very Fine (VF), Ultra Fine (UF), Micro Fine (MF), Non-Abrasive (-)

Hand Pad Features:

- Flexible; conform to work surface
- Gentle action easily removes flashing or burrs without affecting dimension of workpiece
- Non-loading; constant supply of new cutting edges
- Non-rusting; no workpiece contamination
- Resilient construction; long life, increased productivity; solvent resistant; waterproof

Sponge Pad Features:

- Non-woven material is laminated to a long-lasting sponge for the convenience of 2 pads in one
- Superior replacement for steel wool

Machine Used:



HAND SANDING



JITTERBUG SANDER

Application/Grit Recommendation Guide

MORE AGGRESSIVE, ROUGHER FINISH

LESS AGGRESSIVE, FINER FINISH



PRODUCT #:	#740	#746	#644	#747	#796	#635	#748	THIN-FLEX VF	THIN-FLEX UF	THIN-FLEX BP	#456
COLOR:	Dark Tan	Gray	Maroon	Maroon	Green	Gray	Gray	Maroon	Gray	Gold	White
DESCRIPTION:	Heavy Duty	Blending	GP - Fine	GP Plus - Very Fine	Scouring	Clean & Finish	Final Shine	Cleaning	Cleaning	Blend Prep	Cleaning
ABRASIVE:	AO	SC	AO	AO	AO	SC	SC	AO	SC	AO	Non-Abrasive
GRIT SIZE:	Medium 100 - 150	Medium 100 - 150	Fine 180 - 220	Very Fine 240 - 360	Very Fine 240 - 360	Ultra Fine 400 - 600	Micro Fine 800 - 1200	Very Fine 240 - 360	Ultra Fine 400 - 600	Micro-Fine 800 - 1200	Non-Abrasive ----
STEEL WOOL EQUIVALENT:	4 Extra Coarse	3 Coarse	2 Medium Coarse	1 Medium	0 Fine	00 Very Fine	00 Very Fine	00 Very Fine	000 Extra Fine	000 Extra Fine	0000 Super Fine
APPLICATIONS:	<ul style="list-style-type: none"> • Smear-free Clean Bond technology • 2X life • Most durable and aggressive cutting pad • Heavy-duty removal <ul style="list-style-type: none"> » rust » oxidation • Deburring 	<ul style="list-style-type: none"> • Blending and deburring <ul style="list-style-type: none"> » welds » aluminum » stainless 	<ul style="list-style-type: none"> • Cleaning and deburring <ul style="list-style-type: none"> » machinery » metal parts » plastic » solid surface » stone 	<ul style="list-style-type: none"> • Light cleaning, deburring and finishing <ul style="list-style-type: none"> » machinery » metal parts » plastic » solid surface » stone 	<ul style="list-style-type: none"> • Removing stains, marks, rust, corrosion or oxidation from stainless equipment • Light cleaning of metal surfaces 	<ul style="list-style-type: none"> • Light cleaning and finishing of most surfaces <ul style="list-style-type: none"> » steel, aluminum » denibbing plastic » scuffing acrylics 	<ul style="list-style-type: none"> • Final finishing <ul style="list-style-type: none"> » final rub on wood » final blend on metal » final finish on plastics and acrylics 	<ul style="list-style-type: none"> • Maximum flexibility for consistent finishes • Cleaning, blending, finishing, and deburring in woodwork, metalwork, MRO, and synthetic applications 	<ul style="list-style-type: none"> • Maximum flexibility for consistent finishes • Cleaning, blending, finishing, and deburring in woodwork, metalwork, MRO, and synthetic applications 	<ul style="list-style-type: none"> • Fine cleaning <ul style="list-style-type: none"> » Fine polishing (most surfaces) » Top coat finishing (water-based and solvent) 	<ul style="list-style-type: none"> • Scratch-free cleaning <ul style="list-style-type: none"> » metal » fiberglass » stone » solid surface » ceramic • Wood <ul style="list-style-type: none"> » high-lighting » rubbing

Cross Reference Guide

COARSER

FINER

NORTON	#740	#746	#644	#747/847	#796	#635	#748	Thin-Flex VF	Thin Flex UF	#456
3M	7440	7446	64659	7447/8447 Production Hand Pad	96	64660	7448	Multi-Flex Maroon	Multi-Flex Gray	7445
Camel	Tan	—	—	Maroon	Green	—	Gray	—	—	White
Mirka	—	—	—	Maroon/Red VF	—	—	—	Mirlon Total Maroon	Mirlon Total Gray	—
Sait	Brown	—	—	Maroon	Green	—	Gray	—	—	—
SIA	6912 Brown	6712 Grey	—	6912 Maroon	6312 Green	—	—	—	—	—
Standard	HD-Tan AO	—	—	GP-Maroon VF	Green-AO	HP-VF	UF Gray	—	—	Cleaning White

SIZE (W x L)	COLOR	DESCRIPTION	ABRASIVE	GRIT SIZE	STD. PKG.	TIER: BEST	BETTER
						PART #	PART #
Hand Pads							
4-1/2 x 9	Maroon	Thin Flex Cleaning Pad	A/O	VF	25	666233 98062	
	Grey	Thin Flex Cleaning Pad	S/C	UF	25	666233 98063	
	Gold	Thin Flex Blend Prep	A/O	MF	25	662611 13519	
6 x 9	Dark Tan	740 Heavy-Duty Pad	A/O	Med	40	662610 74000	
	Gray	746 Blending Pad	S/C	Med	40		662610 74600
	Maroon	777 General Purpose Very Fine Pad	A/O	VF	60		662610 77700
	Maroon	747 General Purpose Plus Pad	A/O	VF	60	662610 74700	
	Maroon	847 General Purpose Plus Perforated Pad	A/O	VF	60	662610 84700	
	Green	796 Scouring Pad	A/O	VF	60		662610 79600
	Lt. Green	696 Food Pro Pad	A/O	VF	60		662610 69600
	Gray	851 General Cleaning Pad	S/C	VF	40		662610 85100
	Gray	635 Clean & Finish Pad	S/C	UF	60		662610 63500
	Gray	748 Final Shine Pad	S/C	MF	60		662610 74800
	White	456 Cleaning Pad	None	–	60		662610 45600
	Hand Pad Holder						
3-1/4 x 5-1/2	N/A	Hand Pad Holder			10		662610 47583
Scouring Pads/Sponges							
3-1/4 x 6-1/4 x 3/4	Green/Yellow	893 Scour-N-Sponge Pad	A/O	VF	40		662610 59403
3-1/4 x 6-1/4 x 3/4	White/Yellow	875 Clean-N-Sponge Pad	None	–	40		662610 59402



THIN and FLEXIBLE: Perfect for Tight Spots

Norton Bear-Tex Thin-Flex High-Performance Hand Pads

- Achieve performance benefits of a coarse and fine grain product in one hand pad; fast cut and definitively better finish than competing pads
- Extremely thin and conformable; ideal for deburring, cleaning, blending, and finishing contoured surfaces and tight spaces
- Special coated web design for superior and constant cutting action without added effort from user
- Versatile; ideal for woodworking, metalworking, maintenance operations, and synthetics fabrication

Rotolo Foam Sanding Pads

Application/Grit Recommendation Guide

← COARSER												FINER →											
120	150	180	220	240	280	320	400	500	600	800	1000	120	150	180	220	240	280	320	400	500	600	800	1000
Cleaning/Repairing			Final Sanding						Feather Edging			Basecoat Sanding			Clearcoat Sanding								

The better choice for fine sanding flat and curved surfaces



A2750P NO-FIL ROTOLO FOAM ROLLS

- Premium, P-graded, heat-treated aluminum oxide abrasive for consistent surface finish, exceptional performance on all surfaces and coatings
- Foam backing is perfect for hand sanding primer without leaving finger marks; 50% – 60% improvement in tear strength versus conventional paper rolls; perforated for easy sizing
- Non-pigmented, water based stearate No-Fil coating, open coat for best resistance to clogging and loading during sanding

TIER: **BETTER**
 TRADENAME: **A275 OP ROTOLO**
 ABRASIVE: Aluminum Oxide
 OTHER: P-Graded

SIZE (W x L)	GRIT SIZE	ROLLS/STD. PKG.	PART #
4-1/2" x 82'	120	2	636425 35316
	150	2	636425 57584
	180	2	636425 57599
	220	2	636425 57600
	240	2	636425 57602
	280	2	636425 57604
	320	2	636425 57606
	400	2	636425 57608
	500	2	636425 57611
	600	2	636425 57612
	800	2	636425 57613
1000	2	636425 57616	



Flexible Diamond-Coated Hand Pads

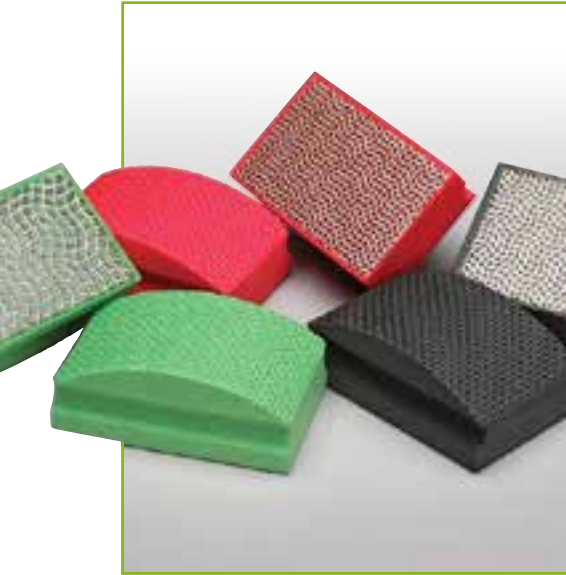

Norton flexible diamond coated hand pads combine the durability and aggressiveness of diamond, with a flexible backing.

Applications:

Diamond coated hand pads: shaping, rapid stock removal, touch-up and repair on ceramics, stone, marble, glass, composites and hard materials; polishing of dies and molds
 Quadroflex diamond hand pads: surface conditioning, repairs, and removing flash and burrs on aircraft composites and windmill blades

Size Range:

3-1/2" x 2-1/8"

Grit Range:

60 – 1500

Abrasive Types:

Diamond

Machine Used:



HAND
SANDING

Better choice for shaping, rapid stock removal, surface conditioning, touch-up, repair, and polishing



FLEXIBLE DIAMOND-COATED HAND PADS – CONVENTIONAL AND QUADROFLEX CURVED

- Durable yet lightweight conformable backing is adaptable to a variety of shapes and conditions with long lasting performance; offers a uniform finish for improved surface quality
- Can be used wet or dry; color-coded by grit size for easy identification
- Conventional hand pads with precision dot pattern for an aggressive, consistent, fast cut rate and reduced dust and loading; Quadroflex curved hand pads offer ergonomic advantages and longest life for lowest overall total cost

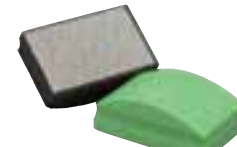

			TIER BETTER		TIER BETTER	
			DIAMOND COATED HAND PADS		QUADROFLEX CURVED DIAMOND COATED HAND PADS	
			ABRASIVE: Diamond		ABRASIVE: Diamond	
SIZE (L x W)	COLOR	GRIT	STD. PKG.	PART #	PART #	
3-1/2 x 2-1/8	Green	60	1	662603 06360	690141 21517	
	Black	120	1	662603 06361	690141 21518	
	Red	200	1	662603 06362	690141 23529	
	Yellow	400	1	662603 05852	690141 23530	
	White	800	1	662603 06363	690141 23531	
	Blue	1500	1	662603 06364		
	Kit (one each of above)			1	662603 07720	

power...
**IN THE PALM OF
YOUR HAND**

New Portable Tools and the specialty abrasive products to go along with them. Access hard-to-reach areas with ease with the Norton Merit line of specialty products.





Put the world right in the palm of your hand with our 2" and 3" Norton Mini Angle Sanders. Small, compact enough to get into those hard-to-reach areas, and powerful enough to finish the job fast and efficiently.

Specifications for:

Weight of tool:

Compressed air:

Maximum permissible operating pressure:

Horsepower:

Free speed:

Air consumption @90psi:

Noise characteristic value in accordance with EN ISO 15744 (ISO 15744):

- A-weighted sound pressure level at workstation
- A-weighted sound power level
- Peak C-weighted instantaneous sound pressure level at workstation

Measurement uncertainty (Standard):

Vibration value according to EN ISO 28927-3:

Recommended lubrications:

Sanding tool specifications:

Applications and suitability:

2" Mini Angle Air Sander 3" Mini Angle Air Sander

1.6 lbs. (0.742kg)

6.2 bar (90psi)

6.2 bar (90psi)

.45

22,000 rpm

85 liters/min (3 CFM)

1.8 lbs. (0.816kg)

6.2 bar (90psi)

6.2 bar (90psi)

.9

20,000 rpm

116 liters/min (4.1 CFM)

87.3 dB

98.3 dB

<130 dB

3.00 m/s²

0.84 m/s²

Air oil 20#

Air oil 20#

Pad Size 2" Collet

Pad size 3" Collet

Collet Chuck 1/4" (6mm)

Collet Chuck 1/4" (6mm)

Surface preparation, grind welds, spot sanding and light-duty finishing applications.



NEW

Put the power right in the palm of your hand with our Mini Angle Sanders

MINI ANGLE SANDERS

- A double-bearing spindle generates superb concentricity, reducing vibrations allowing for longer use and finer finishes
- Finesse your projects by having the ultimate control in both precision and power with the speed regulator
- Get better tool handling along with reduced fatigue with the ergonomic and streamlined non-slip grip

DESCRIPTION	STD. PKG.	PART #
Mini Angle Sanders and Kits		
2" Mini Angle Sander	1	662611 50076
2" Kit Includes:	1	662611 50077
• 1 – 2" Sander		
• 25 – 2" 36 Grit Blaze R980P 3-Ply TR Discs (662611 62318)		
• 50 – 2" Medium Grit Rapid Prep Non-Woven TR Discs (662610 09190)		
• 1 – 2" Medium Density Back-Up Pad (662610 55103)		
3" Mini Angle Air Sander	1	699573 82154
3" Kit Includes:	1	699573 82155
• 1 – 3" Sander		
• 25 – 3" 36 Grit Blaze R980P 3-Ply TR discs (662611 62328)		
• 25 – 3" Medium Grit Rapid Prep Non-Woven TR discs (662610 17522)		
• 1 – 3" Medium Density Back-Up Pad (662610 55105)		





Mini-flap discs are ideal for use in tight spaces. They feature layered flaps which wear away evenly during use exposing new abrasive grain. The lightweight plastic backing helps to absorb vibration. They can help eliminate the conventional 2-step process in grinding edges and removing welds and rust.

- Applications:** Grinding, stock removal, edge chamfering/beveling, weld blending, deburring/deflashing, rust removal, blending, cleaning, and finishing in small areas or tight spots.
- Size Range:** 2" and 3" Quick-Change
- Grit Range:** 36 – 120
- Abrasive Grain:** Ceramic Alumina, Zirconia Alumina
- Abrasive Flaps:** Polyester, Poly-cotton
- Attachment:** TR (Type III) and TS (Type II)
- Backing Plate Material:** Extra Heavy-Duty Plastic
- Machine Used:**



Best choice for beveling, blending, deburring, and stock removal in tight spaces



BLAZE R980P CERAMIC ALUMINA

- Premium ceramic alumina abrasive grain lasts 50% – 200% longer than many flap discs on stainless steel, cobalt, chrome, Inconel, titanium and other hard-to-grind materials
- Flexible, high-strength, plastic backing plates absorb vibration for optimized ergonomics
- Y-weight polyester flaps with a supersize grinding aid significantly improve life, grain retention, and fray resistance while providing a cool, noticeably faster cut rate

Better choice for blending, deburring, and stock removal in tight places



BLUEFIRE R884P ZIRCONIA ALUMINA PLUS

- High-performance zirconia alumina plus abrasive for aggressive cut and long life
- Flexible, high-strength, plastic backing plates absorb vibration for optimized ergonomics
- Poly-cotton flaps with semi-open coat provide improved durability and minimizes loading on aluminum



TIER:	BEST	BETTER	BEST	BETTER		
TRADENAME:	BLAZE R980P	BLUEFIRE R884P	BLAZE R980P	BLUEFIRE R884P		
ABRASIVE:	Ceramic Alumina	Zirconia Alumina Plus	Ceramic Alumina	Zirconia Alumina Plus		
FLAP:	Polyester	Polyester	Polyester	Polyester		
BACKING MATERIAL:	Extra Heavy-Duty Plastic	Extra Heavy-Duty Plastic	Extra Heavy-Duty Plastic	Extra Heavy-Duty Plastic		
ATTACHMENT:	TR (Type III)	TR (Type III)	TS (Type II)	TS (Type II)		
SIZE (D)	GRIT	STD. PKG.	PART #	PART #	PART #	PART #
2	36	10	776960 90145	776960 90165	776960 90155	776960 90175
	40	10	776960 90146	776960 90166	776960 90156	776960 90176
	60	10	776960 90147	776960 90167	776960 90157	776960 90177
	80	10	776960 90148	776960 90168	776960 90158	776960 90178
3	120	10	776960 90149	776960 90169	776960 90159	776960 90179
	36	10	776960 90150	776960 90170	776960 90160	776960 90180
	40	10	776960 90151	776960 90171	776960 90161	776960 90181
	60	10	776960 90152	776960 90172	776960 90162	776960 90182
	80	10	776960 90153	776960 90173	776960 90163	776960 90183
	120	10	776960 90154	776960 90174	776960 90164	776960 90184

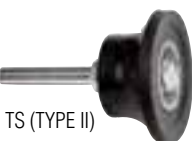

DESCRIPTION	MAX. RPM	STD. PKG.	TR (TYPE III)	TS (TYPE II)
Mini Flap Disc Back-up Pads				
2" and 3" Medium Density Back Up Pads	30,000	1	088341 60172	088341 68539



Tool-free, twist-on and -off fastening systems make fast work of disc changes to maximize productivity by minimizing downtime.

- Applications:** Fiber and NorKut trimmable hard plastic discs: welding, grinding and blending; heavy metal removal; light deburring and finishing
Cloth discs: light- to medium-pressure grinding; blending, leveling and finishing applications; for use on contours or flat surfaces
Diamond: Grinding ceramic, glass, composites, carbide and ceramic coatings, fiberglass, and reinforced plastics
- Size Range:** 9/16" – 4" diameter
- Grit Range:** 24 – 320
- Abrasive Grain:** Ceramic Alumina, Zirconia Alumina, Aluminum Oxide, Silicon Carbide, Diamond
- Backing:** Fiber, cloth, or polymer
- Cloth Flex:** 3-ply (more aggressive), 2-ply (standard)
- Attachment:** Type TS (II), Type TR (III), and Type TP (I)
- Back-up Pads:** Rubber with hardness variations for different applications
- Machine Used:**



MINI ANGLE SANDER

Coated Abrasive Quick-Change Disc Availability



Fiber

- The most heavy-duty discs with resin over resin construction on heavy-duty vulcanized fiber backing
- Premium grain for applications from heavy stock removal to surface blending



Cloth 3-Ply

- These heavy-duty, 3-ply polyester laminate construction discs are the most aggressive and durable cloth discs on the market



NorKut

- Unique polymer backing resists cracking and breakage and can be cut down up to the 1" core
- Use the cores to grind "pinch" welds and other hard-to-reach areas



Cloth 2-Ply

- Our standard 2-ply laminate construction creates an aggressive and durable cloth disc for flat surfaces



Diamond

- Unique, aggressive, diamond grain pattern on a flexible cloth backing

Quick-Change Attachment Systems and Cross Reference Guide

Each system enables quick, safe disc changes, reducing downtime and operating expenses.

Type TS (Type II)

- Features a turn-on/turn-off style fastener
- Fastener is made of metal



Type TR (Type III)

- Features a roll-on/roll-off style fastener
- Fastener is made of plastic



Type TP (Type I)

- Features a snap-on/snap-off style fastener
- Fastener is made of nylon



NORTON MERIT	TS (Type II)	TR (Type III)	TP (Type I)
3M	Roloc TS/TSM	Roloc TR	Roloc TP
Standard	TS (SocAtt)	TR (Lockit)	TP (ClickOn)
Superior	Type S	Type R	–
Arc	Type S	Type R	Type P
Pferd	Type CD	Type CDR	–
Sait	SAIT-LOK	SAIT-LOK-R	–
Camel	Turn On	Roll On	–
Klingspor	QMC	QRC	–
Garryson	Type S	Type R	–

Material/Application-to-Product Recommendation Guide

	BEST	BETTER	GOOD
	Blaze R980P	BlueFire R884P	Aluminum Oxide Silicon Carbide R422
Stainless Steel / Titanium / Super Alloys	◆	◆	◆
Mild Carbon Steel / Welds		◆	◆
Ferrous Metals / Cast Iron		◆	◆
Brass / Bronze / Aluminum		◆	◆
Paint / Glue / Adhesive			◆
Concrete / Stone / Fiberglass			◆

Application/Grit Recommendation Guide

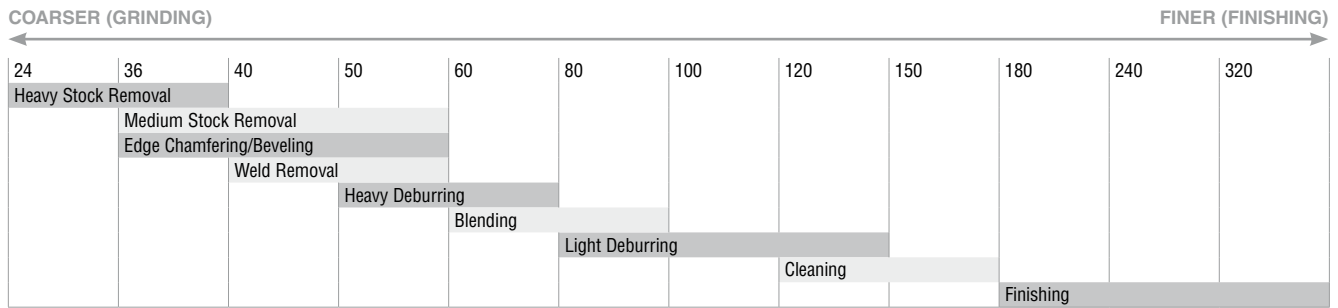

Cross Reference Guide

	TOTAL PERFORMANCE			INITIAL PRICE	
	BEST	BETTER	GOOD		
Abrasive Backing	Ceramic Alumina Fiber	Ceramic Alumina Cloth	Zirconia Alumina Cloth	Aluminum Oxide Cloth	Silicon Carbide Cloth
NORTON	Blaze F980	Blaze R980P	BlueFire R884P		R422
3M	782C, 785C, 787C, 982C, 985C, 987C, 988C	963G/H, 966F, 967F, 997F, 984F, 784F, 947A	561D	361F, 363F	421A, 441D, 461F
Standard	Ceramic, Ceramic Pro	Ceramic Pro, Ceramic	Zirconia	A/O Extra, A/O Pro	Silicon Carbide
Superior	—	Ceramic G.A.	Premium Zirc	A/O with Grinding Aid	—
Arc	—	—	Zirconia/Y Standard	A/O/X Plus Coolant	—
Pferd	CO, CO Cool	Ceramic	ZA Z	Aluminum Oxide A-Plus, Aluminum Oxide A-INOX-FORTE	Silicon Carbide SiC
Sait	7S,7A, 9S	—	Z	3A	C-W
Camel	Ceramic	—	Zirconia AO	—	—
Klingspor	CS570, FS966	CS610	Alumina Zirconia	—	CS333X
Garryson	—	Ceramic	—	—	—

Best choice for tough applications and stainless steel



BLAZE F980 CERAMIC ALUMINA FIBER

- 100% ceramic grain constantly exposes sharper edges to deliver highest productivity at lowest overall costs vs. competitive lower-ratio ceramic discs
- Strong fiber backing, heavier and more rigid than conventional cloth discs, adds strength and tear resistance, and allows additional pressure for better results when grinding difficult materials
- Advanced self-lubricating grain treatment provides coolest cut and significantly faster cut rates; excels on hard-to-grind materials like 300 and 400 Series stainless and exotic alloys

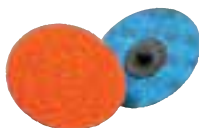

TIER: **BEST**
 TRADENAME: **BLAZE F980**
 ABRASIVE: Ceramic Alumina
 BACKING: Fiber – Heavy Duty
 OTHER: Supersize
 ATTACHMENT: TR (Type III)



SIZE (D)	GRIT	STD. PKG.	PART #
2	24	25	776960 90139
	36	25	662610 58704
	50	25	662610 58705
	60	25	662610 58706
	80	25	662610 58707
3	24	25	776960 90140
	36	25	662610 58708
	50	25	662610 58709
	60	25	662610 58711
	80	25	662610 58712

Quick-Change back-up pads shown at the end of the Quick-Change Disc section.





Best choice for tough applications, titanium, super alloys, and stainless steel (3-ply) or contoured surfaces (2-ply)

BLAZE R980P CERAMIC ALUMINA

- 100% ceramic grain constantly exposes sharper edges to deliver highest productivity at lowest overall costs vs. competitive lower-ratio ceramic discs
- Improved resin bond system maximizes grain retention for longer product life
- Advanced self-lubricating grain treatment provides coolest cut with significantly faster cut rates while minimizing loading on hard-to-grind materials



Better choice for soft metals, wood, stainless steel, and carbon

BLUEFIRE R884P ZIRCONIA ALUMINA

- Premium, versatile, self-sharpening zirconia plus grain provides aggressive cut and up to 30% longer life vs. competitive zirconia discs
- Semi-open coat minimizes loading on soft metals (aluminum, brass, and bronze) and wood, as well as stainless and carbon steels
- Durable Y-weight, polyester waterproof backing stands up to demanding applications: high-pressure and hard-to-grind exotic alloys



Better choice for stainless steel, titanium and other exotic alloys

R801 ZIRCONIA ALUMINA PLUS

- Self-sharpening, zirconia alumina abrasive with grinding aid provides cooler cut, and longer life on hard-to-grind materials
- Durable, Y-weight, 2-ply polyester waterproof blend back stands up to these demanding applications
- Minimized heat build-up allows these discs to outlast conventional aluminum oxide and zirconia alumina discs in many applications



Good choice when initial price is the primary consideration

ALUMINUM OXIDE

- Versatile aluminum oxide abrasive for aggressive cut and longer life than competitive aluminum oxide discs
- Durable Y-weight 2-ply polyester backing and coating for additional life and faster cut rate on moderately-demanding applications
- Good choice when initial price is the primary purchasing consideration



Good choice for non-ferrous materials

R422 SILICON CARBIDE

- Sharp, silicon carbide abrasive provides high initial cut and penetration to resist loading on soft metals
- Strong, X-weight, 2-ply cotton backing construction for extended durability and reduced edge wear
- When completion time is important, sharp silicon carbide abrasive gets non-ferrous blending jobs done quickly

Ceramic Alumina Quick-Change Cloth Discs



TIER:	BEST	BEST	BEST	BEST
TRADENAME:	BLAZE R980P	BLAZE R980P	BLAZE R980P	BLAZE R980P
ABRASIVE:	Ceramic Alumina	Ceramic Alumina	Ceramic Alumina	Ceramic Alumina
BACKING:	Polyester 3-Ply Heavy-Duty	Polyester 3-Ply Heavy-Duty	Polyester 2-Ply Standard	Polyester 2-Ply Standard
OTHER:	Supersize	Supersize	Supersize	Supersize
ATTACHMENT:	TS (Type II)	TR (Type III)	TS (Type II)	TR (Type III)

SIZE (D)	GRIT	STD. PKG.	PART #	PART #	PART #	PART #
1-1/2	36	100	662611 62307	662611 62308	636425 95401	
	50	100	662611 62309	662611 62310	636425 95446	
	60	100	662611 62311	662611 62312	636425 95447	636425 95468
	80	100	662611 62313	662611 62314	636425 95450	
	120	100	662610 43379	662610 43380	662610 43416	
2	36	25	662611 62317	662611 62318	636425 95452	636425 95470
	50	25	662611 62319	662611 62320	636425 95456	636425 95472
	60	25	662611 62321	662611 62322	636425 95458	636425 95476
	80	25	662611 62323	662611 62324	636425 95459	636425 95478
	100	25	662610 43382	662610 43383	662610 43418	662610 43419
	120	25	662610 43384	662610 43386	662610 43420	662610 43421
3	36	25	662611 62327	662611 62328	636425 95460	636425 95479
	50	25	662611 62329	662611 62330	636425 95462	636425 95480
	60	25	662611 62331	662611 62332	636425 95463	636425 95481
	80	25	662611 62333	662611 62334	636425 95464	636425 95493
	100	25	662610 43389	662610 43390	662610 43422	662610 43423
	120	25	662610 43391	662610 43392	662610 43424	662610 43425

Quick-Change back-up pads shown at the end of the Quick-Change Disc section.



Zirconia Alumina Quick-Change Cloth Discs



TIER:	BETTER	BETTER	BETTER	BETTER	BETTER
TRADENAME:	BLUEFIRE R884P	BLUEFIRE R884P	R801 ZIRC PLUS	R801 ZIRC PLUS	R801 ZIRC PLUS
ABRASIVE:	Zirconia Alumina	Zirconia Alumina	Zirconia Alumina	Zirconia Alumina	Zirconia Alumina
BACKING:	Polyester 2-Ply Standard	Polyester 2-Ply Standard	Polyester 2-Ply Standard	Polyester 2-Ply Standard	Polyester 2-Ply Standard
OTHER:			Supersize	Supersize	Supersize
ATTACHMENT:	TS (Type II)	TR (Type III)	TS (Type II)	TR (Type III)	TP (Type I)



SIZE (D)	GRIT	STD. PKG.	PART #	PART #	PART #*	PART #*	PART #*
1	36	100				088341 67093 NS	
	40	100			088341 67052 NS	088341 67094 NS	
	50	100				088341 67095 NS	088341 67011 NS
	60	100	662611 38608			088341 67096 NS	088341 67012 NS
	80	100	662611 38607			088341 67097	088341 67013 NS
	120	100				088341 67099	088341 67015 NS
1-1/2	36	100	662611 38624	662611 21041		088341 67102	088341 67018 NS
	50	100				088341 67103	088341 67019 NS
	60	100	662611 38621	662611 21043	088341 67061	088341 67104	
	80	100	662611 38620	662611 21044	088341 67062	088341 67106	
2	24	100	662611 38638 *	662611 38672 *			
	36	100	662611 38637 *	662611 38671	088341 67065	088341 67107	088341 67023
	40	100			088341 67066	088341 67108	
	50	100	662611 38635 *	662611 38670 *	088341 65583	088341 67109	088341 67025
	60	100	662611 38634 *	662611 21048 *	088341 67068	088341 67110	088341 67026
	80	100	662611 38633 *	662611 21049 *	088341 67069	088341 67111	088341 67027
3	120	100			088341 67071	088341 67113	088341 67029
	24	50	662611 38665 *	662611 38675 *			
	36	50	662611 38664 *	662611 38674 *	088341 67072	088341 67114	088341 67030
	40	50			088341 67073		
	50	50	662611 38662 *	662611 38673 *	088341 67074	088341 67116	088341 67032
	60	50	662611 38661 *	662611 21053 *	088341 67075	088341 67117	088341 67033
4	80	50	662611 38660 *	662611 21054 *	088341 67076	088341 67118	088341 67034
	120	50			088341 67078	088341 67120	
	36	50	662611 38683 *		088341 67079		
	50	50	662611 38681 *				
	60	50	662611 37343 *				088341 67040 NS
	80	50	662611 38679 *		088341 67083 NS		
	120	50			088341 67085 NS		

* Standard Package = 25 discs

NS Non-stock, contact your Norton representative for current order quantities and lead-times.

Quick-Change back-up pads shown at the end of the Quick-Change Disc section.





Quick-Change Test Kit "D"

- Part # 088341**65001**
- Includes 150 discs, assorted grits, in 1", 2", and 3" diameters and 3" back-up pads
- Primarily aluminum oxide cloth quick-change discs
- Several zirconia alumina and aluminum oxide FlexEdge discs are included

Aluminum Oxide Quick-Change Cloth Discs



TIER:	GOOD	GOOD	GOOD
ABRASIVE:	Aluminum Oxide	Aluminum Oxide	Aluminum Oxide
	Polyester	Polyester	Polyester
BACKING:	2-Ply Standard	2-Ply Standard	2-Ply Standard
ATTACHMENT:	TS (Type II)	TR (Type III)	TP (Type I)
			

SIZE (D)	GRIT	STD. PKG.	PART #	PART #	PART #	
3/4	40	100			699573 99739	
	50	100	699573 99604		699573 99740	
	60	100	699573 99605	699573 99673	699573 99741	
	80	100	699573 99606	699573 99674	699573 99742	
1	36	100	699573 99614	699573 99682	699573 99750	
	40	100			699573 99751	
	50	100	699573 99616		699573 99752	
	60	100	699573 99617	699573 99685	699573 99753	
	80	100	699573 99618	699573 99686	699573 99754	
	100	100	699573 99619	699573 99687	699573 99755	
	120	100	699573 99620	699573 99688	699573 99756	
	180	100	699573 99622	699573 99690	699573 99758	
240	100	699573 99623	699573 99691	699573 99759		
1-1/2	36	100	699573 99626	699573 99694	699573 99762	
	40	100	699573 99627	699573 99695	699573 99763	
	50	100	699573 99628	699573 99696	699573 99764	
	60	100	699573 99629	699573 99697	699573 99765	
	80	100	699573 99630	699573 99698	699573 99766	
	100	100	699573 99631	699573 99699		
	120	100	699573 99632	699573 99700	699573 99768	
	150	100			699573 99769	
	180	100	699573 99634	699573 99702	699573 99770	
	240	100	699573 99635	699573 99703		
2	24	100	699573 99637	699573 99705	699573 99773	
	36	100	699573 99638	699573 99706	699573 99774	
	40	100	699573 99639	699573 99707	699573 99775	
	50	100	699573 99640	699573 99708	699573 99776	
	60	100	699573 99641	699573 99709	699573 99777	
	80	100	699573 99642	699573 99710	699573 99778	
	100	100	699573 99643	699573 99711	699573 99779	
	120	100	699573 99644	699573 99712	699573 99780	
	150	100	699573 99645	699573 99713	699573 99781	
	180	100	699573 99646	699573 99714	699573 99782	
	240	100	699573 99647	699573 99715	699573 99783	
	320	100	699573 99648	699573 99716	699573 99784	
	3	24	50	699573 99649	699573 99717	699573 99785
		36	50	699573 99650	699573 99718	699573 99786
40		50	699573 99651	699573 99719	699573 99787	
50		50	699573 99652	699573 99720	699573 99788	
60		50	699573 99653	699573 99721	699573 99789	
80		50	699573 99654	699573 99722	699573 99790	
100		50	699573 99655	699573 99723	699573 99791	
120		50	699573 99656	699573 99724	699573 99792	
150		50	699573 99657	699573 99725		
180		50	699573 99658	699573 99726	699573 99794	
240		50	699573 99659	699573 99727	699573 99795	
320		50	699573 99660	699573 99728	699573 99796	
4		36	50	699573 99661	699573 99729	
		50	50		699573 99731	
	60	50	699573 99664		699573 99800	
	80	50		699573 99733	699573 99801	

Quick-Change back-up pads shown at the end of the Quick-Change Disc section.

Silicon Carbide Quick-Change Cloth Discs



TIER:	GOOD	GOOD	GOOD
TRADENAME:	R422	R422	R422
ABRASIVE:	Silicon Carbide	Silicon Carbide	Silicon Carbide
BACKING:	Cotton Standard	Cotton Standard	Cotton Standard
ATTACHMENT:	TS (Type II)	TR (Type III)	TP (Type I)



SIZE (D)	GRIT	STD. PKG.	PART #	PART #	PART #
2	40	100	088341 65252	088341 64275	
	60	100	088341 65254	088341 64163	088341 62168
	80	100	088341 65255	088341 66155	088341 62169
	120	100		088341 64837	088341 62171
	180	100	088341 65259	088341 67313	088341 62173
3	40	50	088341 65267	088341 64277	
	60	50		088341 64850	
	80	50		088341 66159	088341 62188
	120	50	088341 65272	088341 66160	088341 62190
	180	50	088341 65274	088341 68177	

Quick-Change back-up pads shown at the end of the Quick-Change Disc section.

Some part number are non-stock, contact your Norton representative for status, order quantities and lead-times.

Specialty Quick-Change Discs

Better choice for hard-to-grind areas where flexibility is not required



NORKUT ZIRCONIA ALUMINA POLYMER

- Durable zirconia alumina grain is resin bonded to a unique polymer backing which resists cracking and breaking; can be trimmed to the 1 Inch core
- Used with a quick change mandrel: 7/16-20 threaded for hand-held pneumatic grinders or 1/4 inch mandrel for automotive drills
- Use for deburring and blending; use the core to grind pinch welds and other hard-to-reach areas

TIER:	BETTER
TRADENAME:	NORKUT
ABRASIVE:	Zirconia Alumina
BACKING:	Extra HD Polymer
ATTACHMENT:	Threaded Hole

SIZE (D)	GRIT	STD. PKG.	PART #
NorKut Discs			
3	24	20	636425 03656
	36	20	636425 03657
	50	20	636425 03658

TIER:	BETTER
ATTACHMENT:	Threaded Hole

SIZE (D)	STD. PKG.	PART #
Mandrels		
7/16-20 Mandrel	5	636425 03659
1/4" Mandrel	5	636425 03660

Better choice for improved cut rate and finish on ceramics, glass, fiberglass, composites, carbide, and other tough metals and coatings

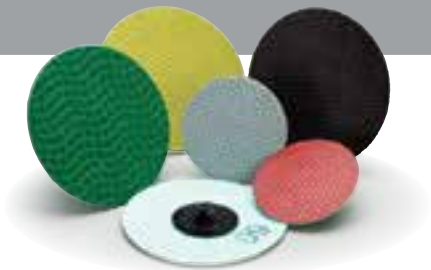

D7210 DIAMOND QUICK-CHANGE TR (TYPE III)

- Unique, durable diamond abrasive pattern increases life and lowers costs versus standard coated and diamond discs; color-coded backing for easy grit/application identification
- Removes rust and scale on other material; producing metallurgical stamps and coupons

SIZE (D)	COLOR	GRIT	STD. PKG.	PART #
Flexible Diamond Coated Quick-Change TR (Type III) Discs				
2"	Green	60	12	662603 11778
	Black	120	12	662603 11779
	Red	200	12	662603 11780
	Yellow	400	12	662603 11781
	White	800	12	662603 11782

SIZE (D)	COLOR	GRIT	STD. PKG.	PART #
Flexible Diamond Coated Quick-Change TR (Type III) Discs				
3"	Green	60	12	662603 11783
	Black	120	12	662603 11784
	Yellow	400	12	662603 11786



Non-woven quick-change discs are a combination of strong synthetic mesh and quality abrasives, bonded together by a smear-resistant adhesive. The open construction of the non-woven material enables aggressive cutting action and improved surface finish while maintaining its non-loading feature.

- Applications:** Medium-light stock removal, beveling, deburring/deflashing, rust removal, blending, cleaning and finishing, polishing, and decorative finishing
- Size Range:** 3/4" – 4" diameter
- Grit Range:** X-Coarse, Coarse, Medium, Fine, Very Fine, Super Fine
- Abrasive Grain:** Ceramic Alumina, Engineered Aluminum Oxide, Aluminum Oxide, Silicon Carbide
- Attachment:** Quick-Change Type TR (Type III), Type TS (Type II)
- Back-up Pads:** Rubber with hardness variations for different applications

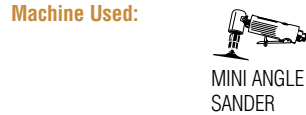

Quick-Change Attachment Systems and Cross Reference Guide

Each system enables quick, tool-free, safe disc changes, reducing downtime and operating expenses.

Type TS (Type II)

- Features a turn-on/turn-off style fastener
- Fastener is made of metal



Type TR (Type III)

- Features a roll-on/roll-off style fastener
- Fastener is made of plastic

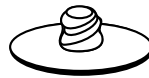

NORTON	TS	TR
3M	Roloc TS/TSM	Roloc TR
Standard	TS (SocAtt)	TR (Lockit)
Superior	Type S	Type R
Arc	Type S	Type R
Pferd	Type CD	Type CDR
Sait	SAIT-LOK	SAIT-LOK-R
Camel	Turn On	Roll On
Klingspor	QMC	QRC
Garryson	Type S	Type R

Application/Grit Recommendation Guide

← MOST AGGRESSIVE LEAST AGGRESSIVE →

NORTON MERIT	Rapid Strip	Vortex Rapid Blend Deburring & Blending	Vortex Rapid Prep	Rapid Prep	HS Buffing, Buffing
Scale Removal	Best Choice				
Stock Removal	Best Choice	Second Choice			
Heavy Deburring	Second Choice	Best Choice			
Light Deburring		Best Choice	Second Choice		
Light Finishing			Best Choice	Second Choice	
Blending			Best Choice	Second Choice	
Cleaning			Second Choice	Best Choice	
Finishing				Best Choice	Second Choice

Cross Reference Guide

NORTON MERIT	STRIPPING		HEAVY/LIGHT DEBURRING		LIGHT DEBURRING/BLENDING/CLEANING/FINISHING		
	BEST	BETTER	BEST	BETTER	BEST	BETTER	BETTER
	Blaze Rapid Strip	Rapid Strip	Vortex Rapid Blend	Rapid Blend, Deburring & Blending	Vortex Rapid Prep	Rapid Prep	HS Buffing, Buffing
3M	Clean and Strip XT PRO, Clean and Strip XT PRO Extra Cut	Clean & Strip Clean Strip XT	Deburr and Finish PRO	EXL Unitized	SE	Surf Cond, SL	-
Standard	-	Cleaning Disc	-	500-900 Series Unitized	-	FE, GP, RC	Buff & Blend - HS, Buff & Blend
Fiberal/SIA	-	-	-	-	-	Meteor, Type B & C	-
Superior	-	Type R	-	XL Unitized	-	FD, GD, CC	HS, HD A/O
Arc	-	Arcstrip	-	-	-	Surface Cond	Blend & Finish
Pferd	-	Policlean	-	-	-	Finishing Disc - Hard & Soft	-
Sait	-	SAIT-Strip	-	-	-	HD, GP	Sand-Light Blending
Camel	-	EZ Strip - Black	-	-	-	-	-
Klingspor	-	-	-	-	-	-	-
Garryson	-	-	-	-	-	Surface Cond	-
Bibielle	-	Strip-It Black	-	BUR Unitized	-	DCR	-

Abrasive/Grit/Density Key

ABRASIVE	SILICON CARBIDE			ALUMINUM OXIDE		CERAMIC ALUMINA
	SHARPER, FINER/BRIGHTER SCRATCH PATTERN			MORE DURABLE, LONGER LASTING, POLISHED FINISH		
GRIT SIZE	XC (50)	C (60-80)	M (100-150)	F (180-220)	VF (240-360)	SF (400-600)
	FASTER, AGGRESSIVE CUT, ROUGHER FINISH			REDUCED CUT RATE, FINER FINISH		
DENSITY	2			9		
	SOFT, OPEN, CONFORMABLE, LESS BURNING/LOADING			HARDER, MORE DURABLE, FASTER CUTTING, BETTER FINISH		

3D Quick-Change Stripping Discs



Best choice for removing coatings on a variety of substrates, such as wood, metal and plastics

BLAZE RAPID STRIP CERAMIC ALUMINA

- Blaze ceramic grain cuts 2X faster than competitive discs; leaves a thoroughly cleaned surface, ensuring excellent adhesion in subsequent processes such as coating, painting and soldering
- Open web construction for minimal loading; great alternative to wire brushes
- Rapid Strip material provides a unique combination of aggressive performance, long life, and improved finish



Better choice for removing coatings on a variety of substrates, such as wood, metal and plastics

RAPID STRIP SILICON CARBIDE

- Sharp silicon carbide abrasive provides fast aggressive cutting action
- Open web construction for minimal loading; great alternative to wire brushes
- Advanced resin bond prevents shedding, snagging, gouging, and rework



TIER: **BEST**
 TRADENAME: **BLAZE RAPID STRIP**
 ABRASIVE: Ceramic Alumina
 GRADE: XC
 ATTACHMENT: TR (Type III)

TIER: **BETTER**
 TRADENAME: **RAPID STRIP**
 ABRASIVE: Silicon Carbide
 GRADE: XC
 ATTACHMENT: TR (Type III)



SIZE (DIAMETER)	MAX. RPM	STD. PKG.	PART #	STD. PKG.	PART #
2 x 1/2	15,500	25	666233 03912	10	662610 13402
3 x 1/2	12,000	25	662610 96557	10	662610 13403
4 x 1/2 TR+	8,000	5	666233 03921*	5	662610 16580*

*TR+ attachment show in the group image above

For unified wheels with arbor holes or spindle mounts, see Non-woven Unified Wheels section. Quick-Change back-up pads shown at the end of this section.

3D Quick-Change Deburring & Blending Discs

Best technology for heavy deburring and finishing



BLAZE RAPID BLEND CERAMIC ALUMINA

- Blaze SG ceramic alumina grain provides quickest cut rate and up to 8X longer life than competitive aluminum oxide discs
- Superior resin chemistry resists shedding when used on sharp edges; ideal for deburring
- Abrasive is distributed throughout the entire disc (top, bottom and side) so all three faces can be used versus competitive discs with one bottom layer of abrasive

Best choice for weld blending, polishing and deburring



VORTEX RAPID BLEND ALUMINUM OXIDE

- Patented Vortex agglomerated aluminum oxide grain provides the cutting power of a coarser grit with the finish of finer grits
- Special resin bond for consistent performance with no smearing
- Abrasive is distributed throughout the entire disc (top, bottom and side) so all three faces can be used versus competitive discs with one bottom layer of abrasive

Better choice for light deburring, blending, and cleaning



RAPID BLEND NEX ALUMINUM OXIDE

- Quality aluminum oxide delivers durability and long life
- Resin formula delivers smear-free finishes
- Abrasive is distributed throughout the entire disc (top, bottom and side) so all three faces can be used – versus competitive discs' one bottom layer of abrasive

3D Quick-Change Deburring & Blending TS Discs



TIER:	BEST	BEST
TRADENAME:	BLAZE RAPID BLEND	VORTEX RAPID BLEND
ABRASIVE:	Ceramic Alumina	Engineered Aluminum Oxide
ATTACHMENT:	TS (Type II)	TS (Type II)



SIZE (D x T)	ABRASIVE	GRIT	DENSITY	MAX. RPM	STD. PKG.	PART #	PART #
1 x 1/4	Ceramic Alumina	XC	1	35,000	100	666233 13920	
1-1/2 x 1/4	Ceramic Alumina	XC	1	35,000	80	666233 13922	
2 x 1/4	Ceramic Alumina	XC	1	22,000	25	666233 13925	
	Aluminum Oxide	M	1	22,000	25		662544 97070
3 x 1/4	Ceramic Alumina	XC	1	15,000	25	666233 13931	
	Aluminum Oxide	M	1	15,000	25		662544 97069

3D Quick-Change Deburring & Blending Discs *continued*

3D Quick-Change Deburring & Blending TR Discs



TIER:	BEST	BEST	BETTER
TRADENAME:	BLAZE RAPID BLEND	VORTEX RAPID BLEND	RAPID BLEND NEX
ABRASIVE:	Ceramic Alumina	Engineered Aluminum Oxide	Aluminum Oxide
ATTACHMENT:	TR (Type III)	TR (Type III)	TR (Type III)



SIZE (D x T)	ABR.	GRIT	DENSITY	MAX. RPM	STD. PKG.	PART #	PART #	PART #	
1 x 1/4	Ceramic Alumina	XC	1	35,000	100	666233 13919			
1-1/2 x 1/4	Ceramic Alumina	XC	1	35,000	80	666233 13921			
2 x 1/8	Aluminum Oxide	M	4-6	22,000	60		662544 25632		
	Aluminum Oxide	M	7-9	22,000	60		662544 33509		
2 x 3/16	Aluminum Oxide	M	2-3	22,000	60		662544 28236		
2 x 1/4	Ceramic Alumina	XC	1	22,000	25	666233 13923			
	Aluminum Oxide	C	7-9	22,000	60			662610 14921	
	Aluminum Oxide	M	1	22,000	25		662544 97067		
	Aluminum Oxide	M	2-3	22,000	60		662544 28237	662610 14897	
	Aluminum Oxide	M	4-6	22,000	60		662544 13660	662610 14911	
	Aluminum Oxide	M	7-9	22,000	60		662544 33510	662610 14935	
	Silicon Carbide	F	2	22,000	60			662610 14889	
	Silicon Carbide	F	3	22,000	60			662610 17306	
	3 x 1/8	Aluminum Oxide	M	4-6	15,000	40		662610 93556	
		Aluminum Oxide	M	7-9	15,000	40		662610 90909	
3 x 3/16	Aluminum Oxide	M	7-9	15,000	40		662544 28239		
3 x 1/4	Ceramic Alumina	XC	1	15,000	25	666233 13930			
	Aluminum Oxide	C	7-9	15,000	40			662610 14922	
	Aluminum Oxide	M	1	15,000	25		662544 97068		
	Aluminum Oxide	M	2-3	15,000	40		662544 28238	662610 14898	
	Aluminum Oxide	M	4-6	15,000	40		662544 13661	662610 14912	
	Aluminum Oxide	M	7-9	15,000	40		662544 06395	662610 14936	
	Aluminum Oxide	F	4-6	15,000	40			662610 15419	
	Silicon Carbide	F	2	15,000	40			662610 14890	
	Silicon Carbide	F	3	15,000	40			662610 16005	

For unified wheels with arbor holes or spindle mounts, see the Non-woven Unified Wheel section. Quick-Change back-up pads shown at the end of this section.

Quick-Change Surface Preparation Discs

Best choice for aggressive stock removal and blending in one step



RAPID PREP XHD

- Coarse and Medium discs solve your most aggressive stock removal and blending challenges, remove weld lines, weld spatter, weld discoloration and blend surfaces in a single step
- Improve cut control and surface blending over traditional coated discs with our unique combination of a conformable fiber matrix and premium ceramic grain
- XHD Coarse discs for aggressive weld removal and surface blending on steels and Medium discs on softer metals/ alloys

TIER: **BEST**
 TRADENAME: **RAPID PREP XHD**
 ABRASIVE: Ceramic Alumina
 ATTACHMENT: TR (Type III)



SIZE (DIAMETER)	MAX. RPM	STD. PKG.	PART #
Coarse			
2	20,000	50	662611 70271
3	18,000	25	662611 70273
4	12,000	25	662611 70274
Medium			
2	20,000	50	662611 70285
3	18,000	25	662611 70286
4	12,000	25	662611 70287



Quick-Change Surface Preparation Discs



Best choice for finishing and blending applications

VORTEX RAPID PREP





- Proprietary engineered Vortex aluminum oxide abrasive grain and coating method combine maximum cutting speed with the consistent finish of finer grits to reduce process times by 50+% by combining multiple grit sequences to 1 step
- Premium high-loft nylon fiber bonded to a strong nylon scrim backing allows a thick layer of resin bond and grain for extended life and provides added durability and stiffness
- Proprietary Clean Bond resin technology guarantees smear-free finishes even on high nickel content alloys and reduces loading on aluminum and other soft metals



Better choice for finishing and blending applications

RAPID PREP ALUMINUM OXIDE

- Quality aluminum oxide abrasive grain coating provides up to 20% higher cut rate and 50% better performance than competitive products
- Thick layer of grain throughout the product extends life; grain does not sit on top of fibers as it does with other competitive products
- Proprietary Clean Bond resin technology guarantees smear-free finishes even on high nickel content alloys and reduces loading on aluminum and other soft metals

TIER:	BEST	BETTER	BEST	BETTER
TRADENAME:	VORTEX RAPID PREP	RAPID PREP	VORTEX RAPID PREP	RAPID PREP
ABRASIVE:	Engineered A/O	Aluminum Oxide	Engineered A/O	Aluminum Oxide
ATTACHMENT:	TR (Type III)	TR (Type III)	TS (Type II)	TS (Type II)
				

SIZE (DIAM.)	MAX. RPM	STD. PKG.	PART #	PART #	PART #	PART #
Extra Coarse						
3/4	25,000	50	666233 25001	666233 40002	666233 35324	
1	25,000	50	666233 25004		666233 25003	666233 40006
1-1/2	20,000	50	666233 25007	666233 40011	666233 25006	666233 40010
2	20,000	50	666233 35326	662610 16373	666233 35325	662610 17819
3	18,000	25	666233 35327	662610 16994	666233 25010	662610 17818
4	12,000	25	666233 35329	662610 16374		
Coarse						
3/4	25,000	50	666233 25013	666233 40021	666233 35410	662610 09515
1	25,000	50	666233 25015	666233 40023	666233 35537	662610 24310
1-1/2	20,000	50	666233 35411	662610 47579	666233 25017	666233 40026
2	20,000	50	666233 35414		666233 35413	662610 09183
3	18,000	25	666233 35417	662610 09194	666233 35416	662610 09186
4	12,000	25	666233 35419	662610 08822		
Medium						
3/4	25,000	50	666233 25020	666233 40032	666233 35420	662544 28059
1	25,000	50	666233 35422	662544 82331	666233 35421	662544 82327
1-1/2	20,000	50	666233 35424	662544 82332	666233 35423	662544 82328
2	20,000	50	666233 35427	662610 09190*	666233 35426	662610 09182
3	18,000	25	666233 35430	662610 17522	666233 35429	662610 09185
4	12,000	25	666233 35432	662610 08821		662610 55350
Fine						
3/4	25,000	50	666233 25026	666233 40058	666233 25025	
1	25,000	50	666233 25029	666233 40064	666233 25028	666233 40062
1-1/2	20,000	50	666233 25032	666233 40070	666233 25031	666233 40068
2	20,000	50	666233 25035	666233 40077	666233 25034	666233 40074
3	18,000	25	666233 25038	666233 40085	666233 25037	666233 40082
4	12,000	25	666233 25041	666233 40092		
Very Fine						
3/4	25,000	50	666233 25044	666233 40044	666233 25043	666233 40042
1	25,000	50	666233 25047	662544 82339	666233 25046	662544 82335
1-1/2	20,000	50	666233 25050	662544 82340	666233 25049	662544 82336
2	20,000	50	666233 35433	662610 09189*	666233 25052	662544 82337
3	18,000	25	666233 35437	662610 09192	666233 35436	662610 09184
4	12,000	25		666233 40053		
Super Fine						
2	20,000	50		662610 091459		
3	18,000	25		662610 091460		

* 25 per standard package.



Quick-Change Buffing/Polishing Discs

Best choice for light removal of paint or rust







BUFFING/POLISHING DISCS

- This aluminum oxide grain and resin bond combination produce a smooth cut rate and smear-free, uniform finish
- Non-woven nylon fibers are laminated to tough yet conformable nylon backing that resists tearing on burrs and sharp edges
- Designed for light removal of coatings oxidation or rust without affecting the base product

TIER:	BEST
TRADENAME:	HIGH-STRENGTH
ABRASIVE:	Aluminum Oxide
ATTACHMENT:	TR (Type III)



BEST	BEST	BETTER	BETTER
HIGH-STRENGTH	HIGH-STRENGTH	BUFFING	BUFFING
Aluminum Oxide	Aluminum Oxide	Aluminum Oxide	Aluminum Oxide
TR (Type III)	TS (Type II)	TR (Type III)	TS (Type II)

SIZE (D)	GRIT	MAX. RPM	STD. PKG.	PART #	STD. PKG.	PART #	PART #	PART #	PART #
1-1/2	M	20,000			100			088341 66368	088341 66392
	F	20,000			100			088341 66369	
2	C	18,000			50			088341 61649	088341 66394
	M	18,000	160	662610 14792	50	088341 64064	088341 64244	088341 66303	088341 66395
	F	18,000			50			088341 66304	088341 66396
	VF	18,000			50	088341 63987	088341 64245	088341 66305	088341 66405
3	C	12,000			25			088341 61651	088341 66397
	M	12,000	80	662610 14793	25	088341 64065	088341 64252	088341 66308	088341 66398
	F	12,000			25			088341 66309	088341 66399
	VF	12,000			25	088341 63559	088341 64255	088341 66310	088341 66403

Quick-Change Back-up Pads

- Hard density pads are for aggressive cutting action
- Medium density pads are for all-purpose applications
- Soft density pads are used for contours and fine finishing work

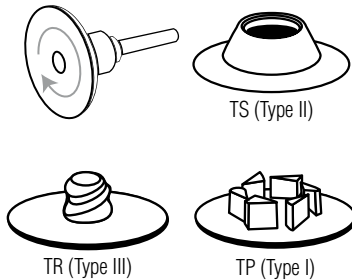

SIZE (DIAMETER)	DENSITY	MAX. RPM	STD. PKG.	TS (TYPE II)	TR (TYPE III)	TP (TYPE I)
Quick-Change Back-up Pads						
9/16		40,000	1	662610 54014 NS		662610 54013 NS
3/4	Medium	40,000	1	088341 64206	088341 64038	088341 64001
1	Medium	40,000	1	088341 64651	088341 64037	088341 64002
1-1/2	Hard	30,000	1	088341 64622		088341 63996
2	Medium	30,000	1	088341 64146	088341 61174	088341 64003
	Hard	30,000	1	088341 64624	088341 64643	088341 63997
	Medium	30,000	1	088341 64198	088341 64922	088341 64004
3	Soft	30,000	1	088341 61625	088341 64641	088341 63949
	Hard	20,000	1	088341 61626	088341 64036	088341 63998
	Medium	20,000	1	088341 64113	088341 64949	088341 64005
4	Soft	20,000	1	088341 64626	088341 64644	088341 63948
	Medium	15,000	1	088341 64135	088341 64655	
4	Medium	8,000	1		636425 55106	
Vendible Quick-Change Back-up Pads						
2	Medium	30,000	5	6662334 1082	6662334 1083	
3	Medium	20,000	5		6662334 1085	



All Quick-Change back-up pads have a 1/4" solid steel shank.

NS Non-stock. Contact your Norton representative for current order quantities and lead-times.

Vendible back-up pad Std. Pkg. Qty: 1 pad per pack; 5 packs per carton. Order in multiples of 5.

Replacement Medium Density Rubber Pads for Quick-Change TP (Type I) Back-up Pads

- When the rubber pad has worn away, but the steel components of your quick-change back-up are still serviceable, order these replacement rubber pads.

SIZE (D)	MODEL #	STD. PKG.	PART #
Quick-Change Replacement Rubber Back-up Pads			
3/4	RR75	1	088341 64008 NS
1	RR10	1	088341 64009 NS
4	RR40	1	088341 64013 NS

NS Non-stock. Contact your Norton representative for current order quantities and lead-times.

Replacement Assemblies and Shanks for Quick-Change Back-up Pad

- Assemblies replace all the steel components of a quick-change back-up pad. This shank replaces the screw-in 1/4" solid steel shank only.

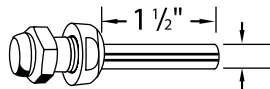

DESCRIPTION	STD. PKG.	PART #
Replacement Mandrels and Nut Assembly		
TP (Type I) Assembly RMN3 for 3 - 4	1	088341 64016 NS
TS (Type II) & TR (Type III) Replacement 1/4" Shank	1	088341 64303

NS Non-stock. Ask your Norton representative for current order quantities and lead-times

Extension Mandrels and Assembly

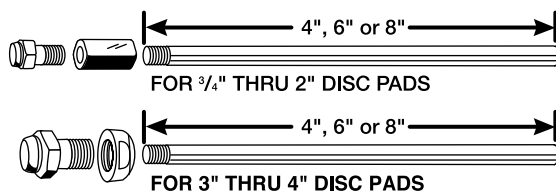

DIAMETER	MODEL #	LENGTH	STD. PKG.	PART #
Extension Mandrels and Assembly - TP (Type I)				
3/4 - 2	EMN-14	4"	1	088341 64017 NS
3/4 - 2	EMN-16	6"	1	088341 64018 NS
3/4 - 2	EMN-18	8"	1	088341 64019 NS
3 - 4	EMN-34	4"	1	088341 64020 NS
3 - 4	EMN-36	6"	1	088341 64026 NS
3 - 4	EMN-38	8"	1	088341 64021 NS

All extension mandrels are non-stock, Contact your Norton representative for current order quantities and lead-times.

MNA-1 Pad Adapters

- Convert a TP (Type I) back-up pad 1/4" diameter solid shank to a threaded shank

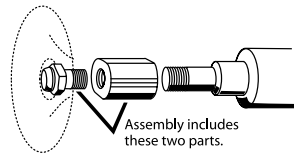

DISC DIAMETER	MODEL NO.	STD. PKG.	PART #
MNA-1 Pad Adapters - TP (Type I)			
3/4 - 2	MNA 1/4-20 THD.	1	088341 61176 NS
3/4 - 2	MNA 3/8-24	1	088341 64055 NS
3/4 - 2	MNA 5/8-11	1	088341 63001 NS
3 - 4	MNA 1/4-20	1	088341 63002 NS
3 - 4	MNA 3/8-24	1	088341 64041 NS
3 - 4	MNA 5/8-11	1	088341 64028 NS

All pad adapters are non-stock. Contact your Norton representative for current order quantities and lead-times.

MNA-23 Pad Adapters

- For use on a right angle grinder: convert TS (Type II) and TR (Type III) back-up pad 1/4" diameter solid shanks to threaded shanks.
- The larger 5/8"-11 adapter (for 4-1/2" discs) is used alone to convert to a 5/8"-11 thread.
- The 3/8"-24 insert (for 4" discs) is screwed into the 5/8"-11 adapter to create a 3/8"-24 thread adapter.

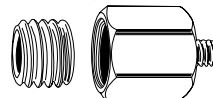

DISC DIAMETER	MODEL #	STD. PKG.	PART #
MNA-23 Pad Adapters - TS (Type II) and TR (Type III)			
3/4 - 4	MNA-23 3/8"-24 and 5/8"-11 THD.	1	088341 62764 NS

NS Non-stock. Ask your Norton representative for current order quantities and lead-times

1/4" Diameter Extension Mandrel

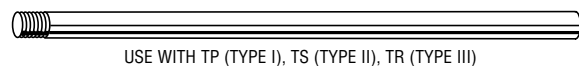

USE WITH TP (TYPE I), TS (TYPE II), TR (TYPE III)

MODEL NO.	LENGTH	STD. PKG.	PART #
1/4" Diameter Extension Mandrel 1/4-20 Thread			
EM-144	4"	1	088341 54185
EM-146	6"	1	088341 54186
EM-148	8"	1	088341 54187



Our new Norton pneumatic die grinder quickly and comfortably accomplishes many portable applications without changing machines – including jobs for abrasive specialties (cartridge and spiral rolls...), small diameter flap wheels, mounted points, and carbide burrs.

- Weight of tool:** 1.4 lbs.
- Compressed air:** 6.2 bar (90psi)
- Maximum permissible operating pressure:** 6.2 bar (90psi)
- Recommended operating pressure:** 6.2 bar (90psi)
- Horsepower:** 0.9HP
- Free speed:** 25,000 rpm
- Air consumption @90psi:** 85 l/min (3 CFM)
- Noise characteristic value in accordance with EN ISO 15744 (ISO 15744):**
 - A-weighted sound pressure level at workstation 87.3 dB
 - A-weighted sound power level 98.3 dB
 - Peak C-weighted instantaneous sound pressure level at workstation < 130 dB
 - Measurement uncertainty (Standard) 3 dB
- Vibration value according to EN ISO 28927-12:** 3.00 m/s²
- Measurement uncertainty (Standard):** 0.84 m/s²
- Recommended lubrications:** Air drill oil 20#
- Sanding tool specifications:** Pad Size 2" Collet
Chuck 1/8" (3 mm) and 1/4" (6 mm)
- Applications and suitability:** Final surface finishing, chamfering, deburring of architectural millwork, sheet metal and surface prep, zinc casting, aluminum products, injection molds, etc.; general sanding and polishing.

Put the power right in the palm of your hand with our die grinder



PNEUMATIC DIE GRINDER

- Comfortable during prolonged use thanks to vibration-limiting technology, ergonomic design, and streamlined non-slip grip
- Adaptable to the needs of each job with speed regulation and two collet inserts in 1/8" and 1/4"
- Compatible with many accessories including cartridge rolls, spiral rolls, square pads, cross pads, overlap slotted discs, flap wheels, mounted points and carbide burrs

DESCRIPTION	STD. PKG.	PART #
Norton Pneumatic Die Grinder		
Single Die Grinder with 1/8" and 1/4" collets	1	699573 08000
Die Grinder Kit*	1	699573 08001
Kit includes:		
1 die grinder with 1/8" and 1/4" collets		
100 – 3/8" x 1-1/2" x 1/8", 80 grit Metal R228 cartridge rolls (088341 80232)		
1- M9 cartridge roll mandrel (088341 81209)		
10 – 1" x 1" x 1/4" shank, 60 grit Blaze R920 flap wheels (662611 51170)		
5 – 1" x 1" W220, 1/4" x 1-1/2" spindle Gemini 38A60-P mounted points (614636 24566)		
1 – 1/2" x 1" SF5 Double-Cut carbide burr (699573 08021)		





Cartridge rolls are strips of abrasive cloth rolled and glued to form a solid shape that is designed to break down during use and reveal the next layer of abrasive. A valuable abrasive tool for reaching into corners, where larger diameter tools cannot work

- Applications:** Used on inside surfaces and inside corners where other abrasive shapes cannot reach. Typically these are used on high-speed air grinders and are always mounted on a mandrel. Ideal for flash removal, polishing or removing machine tool marks, and edge breaking.
- Stock Shapes:** Cartridge rolls, half-glued
- Grit Range:** 36 - 320
- Abrasive Grain:** Ceramic Alumina, Aluminum Oxide
- Backing:** X-weight cotton, X-weight poly-cotton
- Construction:** All cartridge roll part numbers shown are resin bond, half-glued. Quarter and full glue are also available for quotation as made-to-order products.
- Maximum RPM:** 1/8" to 1/2" – 23,000
5/8" to 1" – 18,000
1" to 1-1/2" – 15,000
- Machine Used:**  DIE GRINDER

Application/Grit Recommendation Guide

COARSER (GRINDING) ←									→ FINER (FINISHING)	
36	40	50	60	80	120	180	240	320		
Blending Out Heavy Machine Marks										
Removing Heavy Burrs										
Applying Heavy Scratch Pattern										
Removing Flash/Parting Lines										
Removing Rust/Scale/Pit Marks										
		Preparing Metal for Painting								
		Blending Out Medium Machine Marks								
				Blending Metal Surfaces						
				Applying Light Scratch Pattern						
						Fine Blending and Cleaning				
							Metal Finishing and Polishing			

Best choice for hard-to-grind materials including super alloys (cobalt, inconel, and titanium) and stainless steel



BLAZE R920 CERAMIC ALUMINA

- Premium ceramic alumina abrasive grain provides greatest productivity with significantly faster cut rates; resists wear resulting in 50% – 300% longer life; supersized for cool cutting
- X-weight cotton cloth provides extended durability, conformability, and superior wear resistance; strong resin bond system provides good grain retention and life
- Constructed of rolled and half-glued abrasive strips that break down to expose next layer of abrasive

Better choice for accessing tight areas and where long life & fast cut are required



NEW

PINK R928 CERAMIC ALUMINA

- Excellent option for reaching into corners and small areas, ceramic grain provides better performance than aluminum oxide or zirconia alumina alternatives
- Improved resin bond system provides longer life; supersized for cool cutting
- Versatile X-weight poly cotton backing for flexibility and life

Good starting specification for flash removal, polishing, or removing machine tool marks and edge breaking on all types of metal



R228 ALUMINUM OXIDE

- Quality aluminum oxide abrasive delivers long life
- X-weight cotton cloth provides extended durability, conformability, and superior wear resistance; strong resin bond system provides good grain retention and life
- Constructed of rolled and half-glued abrasive strips that break down to expose next layer of abrasive



TIER:	BEST	BETTER
TRADENAME:	BLAZE R920	PINK R928
ABRASIVE:	Ceramic Alumina	Ceramic Alumina
OTHER:	Supersize	Supersize

SIZE (D x L x H)	GRIT	STD. PKG.	PART #	PART #
1/4 x 1-1/2 x 1/8	60	100	662611 94384	699573 39765
Use M-9 Mandrel	80	100	662611 94394	699573 39766
	120	100	662611 94397	699573 39767
3/8 x 1-1/2 x 1/8	60	100	662611 94392	699573 39768
Use M-9 Mandrel	80	100	662611 94395	699573 39769
	120	100	662611 94398	699573 39770
1/2 x 1-1/2 x 1/8	60	100	662611 94393	699573 39771
Use M-9 Mandrel	80	100	662611 94396	699573 39772
	120	100	662611 94399	699573 39774



TIER:	GOOD
TRADENAME:	R228
ABRASIVE:	Aluminum Oxide

SIZE (D x L x H)	GRIT	STD. PKG.	PART #
3/16 x 3/4 x 3/32	80	100	088341 80005
3/16 x 1 x 3/32	60	100	088341 80023
Use M-2E Mandrel	80	100	088341 80024
	100	100	088341 80025
	120	100	088341 80026
	150	100	088341 80027
	180	100	088341 80028
	240	100	088341 80030
1/4 x 3/4 x 1/8	60	100	088341 80042
Use M-3 or M-7 Mandrel	80	100	088341 80043
1/4 x 1 x 1/8	50	100	088341 80060
Use M-4 or M-8 Mandrel	60	100	088341 80061
	80	100	088341 80062
	100	100	088341 80063
	120	100	088341 80064
	150	100	088341 80065
	180	100	088341 80066
	320	100	088341 80070
1/4 x 1-1/2 x 1/8	50	100	088341 80079
Use M-9 Mandrel	60	100	088341 80080
	80	100	088341 80081
	100	100	088341 80082
	120	100	088341 80083
	150	100	088341 80084
	180	100	088341 80085
	320	100	088341 80089
1/4 x 2 x 1/8	80	100	088341 80100
Use M-10 Mandrel	120	100	088341 80102
5/16 x 1 x 1/8	80	100	088341 80138
Use M-4 or M-8 Mandrel	120	100	088341 80140
5/16 x 1-1/2 x 1/8	80	100	088341 80157
Use M-9 Mandrel			

Some part numbers are non-stock; contact your Norton representative for status, order quantities and lead-times.

Continued



TIER:	GOOD
TRADENAME:	R228
ABRASIVE:	Aluminum Oxide

SIZE (D x L x H)	GRIT	STD. PKG.	PART #
3/8 x 3/4 x 1/8	120	100	088341 80197
Use M-7 Mandrel			
3/8 x 1 x 1/8	60	100	088341 80213
Use M-8 Mandrel	80	100	088341 80214
	100	100	088341 80215
	120	100	088341 80216
	150	100	088341 80217
	180	100	088341 80218
	240	100	088341 80220
3/8 x 1-1/2 x 1/8	36	100	088341 80228
Use M-9 Mandrel	40	100	088341 80229
	50	100	088341 80230
	60	100	088341 80231
	80	100	088341 80232
	100	100	088341 80233
	120	100	088341 80234
	180	100	088341 80236
	240	100	088341 80238
	320	100	088341 80240
3/8 x 2 x 1/8	60	100	088341 80250
Use M-10 Mandrel	80	100	088341 80251
	120	100	088341 80253
1/2 x 3/4 x 1/8	80	100	088341 80270
Use M-7 Mandrel			
1/2 x 1 x 1/8	50	100	088341 80287
Use M-8 Mandrel	60	100	088341 80288
	80	100	088341 80289
	100	100	088341 80290
	120	100	088341 80291
	150	100	088341 80292
	180	100	088341 80293
	240	100	088341 80295

Continued

Refer to the back of this section for mandrels.



TIER: **GOOD**
TRADENAME: **R228**
ABRASIVE: Aluminum Oxide

SIZE (D x L x H)	GRIT	STD. PKG.	PART #
1/2 x 1-1/2 x 1/8 Use M-9 Mandrel	36	100	088341 80304
	40	100	088341 80305
	50	100	088341 80306
	60	100	088341 80307
	80	100	088341 80308
	100	100	088341 80309
	120	100	088341 80310
	150	100	088341 80311
	180	100	088341 80312
	240	100	088341 80314
1/2 x 2 x 1/8 Use M-10 Mandrel	320	100	088341 80316
	60	100	088341 80326
	80	100	088341 80327
1/2 x 2 x 3/16 Use M-17 Mandrel	120	100	088341 80329
	60	100	088341 80350
	80	100	088341 80653
1/2 x 2 x 1/4 Use M-22 Mandrel	120	100	088341 80338
	80	100	088341 80351
5/8 x 1 x 3/16 Use M-15 Mandrel	80	100	088341 80364
5/8 x 1-1/2 x 1/8 Use M-9 Mandrel	60	100	088341 80275
	80	100	088341 80789
	120	100	088341 80394
5/8 x 1-1/2 x 3/16 Use M-16 Mandrel	60	100	088341 80382
	80	100	088341 80383
5/8 x 2 x 1/8 Use M-10 Mandrel	60	100	088341 82505
	80	100	088341 81080
5/8 x 2 x 3/16 Use M-10 Mandrel	50	100	088341 80400
	60	100	088341 80401
	80	100	088341 80402
3/4 x 1 x 1/8 Use M-8 Mandrel	80	100	088341 80469
	120	100	088341 81543
3/4 x 1 x 3/16 Use M-15 Mandrel	80	100	088341 80459
	120	100	088341 80461

Some part numbers are non-stock; contact your Norton representative for status, order quantities and lead-times.
Continued



TIER: **GOOD**
TRADENAME: **R228**
ABRASIVE: Aluminum Oxide

SIZE (D x L x H)	GRIT	STD. PKG.	PART #
3/4 x 1-1/2 x 1/8 Use M-9 Mandrel	60	100	088341 80490
	80	100	088341 80527
	120	100	088341 80487
3/4 x 1-1/2 x 3/16 Use M-16 Mandrel	36	100	088341 80474
	50	100	088341 80476
	60	100	088341 80477
	80	100	088341 80478
	120	100	088341 80480
3/4 x 1-1/2 x 1/4 100/box 400/case Use M-21 Mandrel	180	100	088341 80482
	36	100	088341 80907
	60	100	088341 80489
	80	100	088341 80358
1/2 x 2 x 1/8 Use M-10 Mandrel	120	100	088341 80488
	150	100	088341 82807
	60	100	088341 80791
	3/4 x 2 x 3/16 Use M-17 Mandrel	40	100
3/4 x 2 x 1/4 Use M-22 Mandrel	60	100	088341 80496
	80	100	088341 80497
	100	100	088341 80498
	120	100	088341 80499
3/4 x 2 x 1/4 Use M-22 Mandrel	60	100	088341 80506
	80	100	088341 81297
	100	100	088341 80509
1 x 1-1/2 x 1/8 Use M-9 Mandrel	120	100	088341 80507
	80	100	088341 80584
	1 x 1-1/2 x 1/4 Use M-21 Mandrel	36	100
1 x 2 x 3/16 Use M-17 Mandrel	60	100	088341 80587
	80	100	088341 80583
	80	100	088341 80591
1 x 2 x 1/4 Use M-22 Mandrel	60	100	088341 80592
	80	100	088341 80603
1 x 2 x 1/4 Use M-22 Mandrel	60	100	088341 80603
	80	100	088341 80606

Refer to the back of this section for mandrels.



Spiral rolls are strips of abrasive cloth rolled and glued to form a solid shape that is designed to break down during use and reveal the next layer of abrasive.

- Applications:** Used on inside surfaces and inside corners where other abrasive shapes cannot reach. Typically these are used on high-speed air grinders and are always mounted on a mandrel. Ideal for flash removal, polishing, or removing machine tool marks, and edge breaking.
- Shapes:** Full taper (all stock part numbers), half taper, and sidewall taper
- Grit Range:** 36 - 240
- Abrasive Grain:** Ceramic Alumina, Aluminum Oxide
- Backing:** X-weight cotton, X-weight poly cotton
- Construction:** All spiral roll part numbers shown are full tapered, resin bond, half glued. Half-tapered and sidewall-tapered are available for quotation as made-to-order products. Quarter and full glue are also available for quotation as made-to-order products.
- Maximum RPM:** 1/8" to 1/2" – 23,000
5/8" to 1" – 18,000
1" to 1-1/2" – 15,000
- Machine Used:**  DIE GRINDER

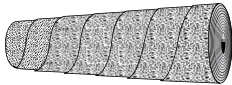

Full Taper

- Especially useful for grinding/polishing of channels, fillets and radii, and deburring small holes
- Full taper used when the area to be finished is hard to reach with a full cartridge roll
- The tapered roll conforms to smaller areas
- Fits into irregular concaves, contours, channels

All part numbers shown are full tapered

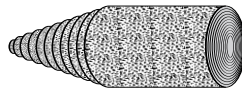

Half Taper

- Used when the area to be finished is not narrow but a beginning point on the roll is needed
- The portion of the roll that is not tapered is then used to finish off the sides

Available for quotation as made-to-order products

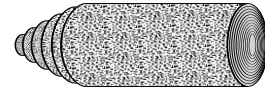

Sidewall Taper

- The portion of the roll that is tapered guides the roll down to the area to be finished
- The sidewall then finishes off the sides

Available for quotation as made-to-order products

Application/Grit Recommendation Guide

COARSER (GRINDING)					FINER (FINISHING)			
36	40	50	60	80	120	180	240	320
Blending Out Heavy Machine Marks								
Removing Heavy Burrs								
Applying Heavy Scratch Pattern								
Removing Flash/Parting Lines								
Removing Rust/Scale/Pit Marks								
		Preparing Metal for Painting						
		Blending Out Medium Machine Marks						
				Blending Metal Surfaces				
				Applying Light Scratch Pattern				
						Fine Blending and Cleaning		
							Metal Finishing and Polishing	

Best choice for hard-to-grind materials including super alloys (cobalt, inconel, and titanium) and stainless steel



BLAZE R920 CERAMIC ALUMINA

- See significantly faster, cooler, burn-free results on the toughest jobs from the premium, sharp, longest-lasting P-graded ceramic abrasive grains and advanced grinding aid lubricant; supersized for cool cutting
- X-weight cotton cloth provides extended durability, conformability, and superior wear resistance; strong resin bond system provides good grain retention and life
- Full taper construction consisting of rolled and half-glued abrasive strips that break down to expose next layer of abrasive

Better choice for accessing tight areas and where long life and fast cut are required



NEW

PINK R928 CERAMIC ALUMINA

- Excellent option for reaching into corners and small areas, ceramic grain provides better performance than aluminum oxide or zirconia alumina alternatives
- Improved resin bond system provides longer life; supersized for fast cutting
- Versatile X-weight poly cotton backing for flexibility and life

Good choice for cooler grinding/polishing of channels, fillets and radii, and deburring small holes at a low initial price



R228 ALUMINUM OXIDE

- Quality aluminum oxide abrasive delivers long life
- X-weight cotton cloth provides extended durability, conformability, and superior wear resistance; strong resin bond system provides good grain retention and life
- Full taper construction consisting of rolled and half-glued abrasive strips that break down to expose next layer of abrasive





TIER:	BEST	BETTER	GOOD
TRADENAME:	BLAZE R920	PINK R928	R228
ABRASIVE:	Ceramic Alumina	Ceramic Alumina	Aluminum Oxide
OTHER:	Supersize	Supersize	

SIZE (D x L x H)	GRIT	STD. PKG.	PART #	PART #	PART #
3/8 x 1 x 1/8 Use M-8 Mandrel	60	100			088341 81714
	80	100			088341 81715
	120	100			088341 81717
3/8 x 1-1/2 x 1/8 Use M-9 Mandrel	60	100	662611 94481	699573 39775	088341 81724
	80	100	662611 94490	699573 39785	088341 81708
	120	100	662611 94491	699573 39787	088341 81727
	180	100			088341 81709
1/2 x 1 x 1/8 Use M-8 Mandrel	60	100			088341 81734
	80	100			088341 81735
	120	100			088341 81737
1/2 x 1-1/2 x 1/8 Use M-9 Mandrel	36	100			088341 81230
	50	100			088341 81743
	60	100	662611 94484	699573 39790	088341 81744
	80	100	662611 94492	699573 39791	088341 81745
	100	100			088341 81746
	120	100	662611 94495	699573 39792	088341 81747
	180	100			088341 81749
240	100			088341 81750	
1/2 x 2 x 1/8 Use M-10 Mandrel	60	100			088341 81754
	80	100			088341 81755
	120	100			088341 81757
5/8 x 1-1/2 x 1/8 Use M-9 Mandrel	100	100			088341 81776
	120	100			088341 81777
5/8 x 1-1/2 x 3/16 Use M-16 Mandrel	80	100			088341 81444
3/4 x 1-1/2 x 1/8 Use M-9 Mandrel	60	100			088341 81286
	80	100			088341 80886
3/4 x 1-1/2 x 3/16 Use M-16 Mandrel	60	100			088341 81808
	80	100			088341 81809
	120	100			088341 81811
3/4 x 2 x 3/16 Use M-17 Mandrel	60	100			088341 81820
1 x 1-1/2 x 1/8 Use M-9 Mandrel	60	100		699573 39790	088341 81240
1 x 2 x 3/16 Use M-17 Mandrel	36	100			088341 81875
	60	100			088341 81878
	80	100			088341 81879

Some part numbers are non-stock; contact your Norton representative for status, order quantities and lead-times.

Refer to the back of this section for mandrels.



Square pads, cross pads and overlap slotted discs are all used on high-speed pneumatic tools for deburring, blending, cleaning, and polishing applications. All of these abrasive specialties are designed for applications in small, tight, hard-to-access locations on parts that are being finished.

Benefits:

Variety of shapes and sizes to fit application and part geometry
Shapes provide flexibility for the application, while eliminating aggressiveness of the sanding action
Cross pads allow visibility of the surface while sanding, to ensure correct amount of material is removed

Grit Range:

50 – 180

Abrasive Grain:

Ceramic Alumina, Aluminum Oxide

Backing:

X-weight cotton, X-weight poly-cotton

Construction

Standard quick-change eyelet for easy mounting and removal on quick-change mandrel minimizes downtime; Mandrel use increases range and versatility

Maximum RPM:

1" Diameter – 25,000 3" Diameter – 12,000 to 14,000
1-1/2" to 2" Diameter – 18,000 to 23,000 4" Diameter – 8,000 to 12,000
2-1/2" Diameter – 14,000 to 18,000 5" to 6" Diameter – 5,500 to 7,500

Machine Used:



Application/Grit Recommendation Guide

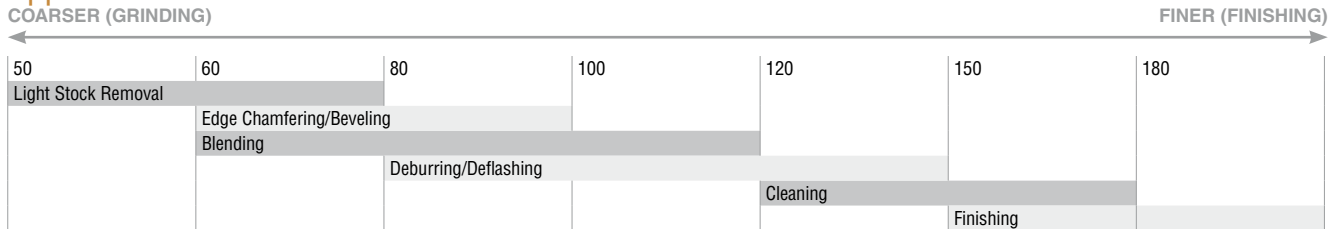

Best choice for hard-to-grind materials including super alloys (cobalt, inconel, and titanium) and stainless steel



BLAZE R920 CERAMIC ALUMINA

- See significantly faster, cooler, burn-free results on the toughest jobs from the sharp, longest-lasting P-graded ceramic abrasive grains and advanced supersize grinding aid for cool cutting
- X-weight cotton cloth provides extended durability, conformability, and superior wear resistance; strong resin bond system provides good grain retention and life
- Corners wear down consistently, exposing fresh abrasive; as these become round, they become less aggressive and run even smoother, with less stock removal – to retain workpiece shape

Better choice for accessing tight areas and where long life & fast cut are required



PINK R928 CERAMIC ALUMINA

- Excellent option for reaching into corners and small areas, ceramic grain provides better performance than aluminum oxide and zirconia alternatives
- Improved resin bond system provides longer life; supersized for cool cutting
- Versatile X-weight poly cotton backing for flexibility and life

Good for most ID deburring and polishing applications



R228 ALUMINUM OXIDE

- Versatile, quality aluminum oxide abrasive grain ensures good cut rate
- X-weight cotton cloth provides extended durability, conformability, and superior wear resistance; strong resin bond system provides good grain retention and life
- Corners wear down consistently, exposing fresh abrasive; as these become round, they become less aggressive and run even smoother, with less stock removal – to retain workpiece shape

Square & Cross Pads, Overlap Slotted Discs

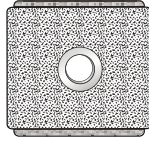

Square Pads

- Corners wear down consistently exposing fresh abrasive; the pad becomes round for less aggressive stock removal
- Grind almost as fast as hard wheels, but are much smoother and easier to control
- For quick blending of channels, fillets, corners, or spotting flat surfaces



			TIER: BEST		BETTE4R		GOOD		
TRADENAME:			BLAZE R920		PINK R928		R228		
ABRASIVE:			Ceramic Alumina		Ceramic Alumina		Aluminum Oxide		
OTHER:			Supersize		Supersize				
SIZE (L x W x T)	EYELET	GRIT	STD. PKG.	PART #	PART #	PART #	PART #		
1 x 1 x 6 ply	8-32	80	100				088341	84826	
1 x 1 x 8 ply		80	100				088341	84124	
1-1/2 x 1-1/2 x 1/2	1/4-20	60	100				088341	84463	
		80	100				088341	84125	
2 x 2 x 1/2	1/4-20	60	100	662611	94520	699573	40138		
		80	100	662611	94552	699573	40139	088341	84397
		120	100	662611	94554	699573	40141		
2 x 2 x 3/4	1/4-20	80	100				088341	84394	
3 x 3 x 1/4	1/4-20	60	100	662611	94531	699573	40142		
		80	100	662611	94555	699573	40143		
		120	100	662611	94556	699573	40144		
3 x 3 x 1/2	1/4-20	50	100					088341	82152
		60	100	662611	94528	699573	40146	088341	82057
		80	100	662611	94557	699573	40147	088341	84336
		120	100	662611	94558				

Some part numbers are non-stock; contact your Norton representative for status, order quantities and lead-times.

Refer to the back of this section for mandrels.

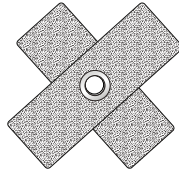

Cross Pads

- The shape of cross pads enables you to see through to the contact area, and provides greater flexibility than square pads to conform to variable internal diameters
- Used for close-tolerance polishing of small radii and channels, deburring, and finishing of bell-mouth configurations
- All pads are furnished with standard quick-change eyelet, as listed
- Plain hole sizes must be specified and are available for quotation as made-to-order products



TIER:	BEST	BETTER	GOOD
TRADENAME:	BLAZE R920	PINK R928	R228
ABRASIVE:	Ceramic Alumina	Ceramic Alumina	Aluminum Oxide
OTHER:	Supersize	Supersize	

SIZE (L x W x T)	PLY	EYELET	GRIT	STD. PKG.	PART #	PART #	PART #
3/4 x 3/4 x 3/8	8	3-48	80	100			088341 85578
1 x 1 x 3/8	8	3-48	60	100			088341 84943
			80	100			088341 85519
			100	100			088341 84195
			120	100			088341 85164
1-1/2 x 1-1/2 x 1/2	8	8-32	60	100	662611 94496	699573 39793	088341 84258
			80	100	662611 94508	699573 39794	088341 84465
			100	100			088341 82196
			120	100	662611 94511	699573 39804	088341 82148
2 x 2 x 1/2	8	8-32	60	100			088341 82156
			80	100			088341 82157
			120	100			088341 82132
2 x 2 x 3/4	8	8-32	60	100	662611 94502	699573 39806	088341 84128
			80	100	662611 94513	699573 40133	088341 84194
			120	100	662611 94516	699573 40134	
2-1/4 x 2-1/4 x 1/2	8	8-32	80	100			088341 84402
2-1/2 x 2-1/2 x 3/4	8	8-32	80	100			088341 84206
3 x 3 x 1	8	1/4-20	60	100	662611 94504		088341 82135
			80	100	662611 94549		088341 84119
			120	100	662611 94551		088341 84116
3 x 3 x 1	8	1/4-20	60	100		699573 40135	
			80	100		699573 40136*	088341 82140
			120	100		699573 40137	
3 x 3 x 1-1/2	10	1/4-20	80	100			088341 82184
4 x 4 x 1	8	1/4-20	60	100			088341 84142
			80	100			088341 84135
			120	100			088341 84377
4 x 4 x 1-1/2	8	1/4-20	80	100			088341 84129

* Pink R928 3 x 3 x 1 are 8 ply.

Ceramic Alumina and Alumina Oxide cross pads are also available upon request as made-to-order products.

Some part numbers are non-stock; contact your Norton representative for status, order quantities and lead-times.

Refer to the back of this section for mandrels.



Overlap Slotted Discs

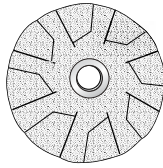

Overlap Slotted Discs

- Used for deburring and polishing radii, holes and cylinder walls
- Our "2 to a set" configuration cuts on the inward motion only
- The "4 to a set" configuration, assembled back to back, cuts on both the inward and outward motions
- All discs are furnished with standard quick-change eyelet
- Plain hole sizes must be specified and are available for quotation as made-to-order products



TIER:	BEST	GOOD
TRADENAME:	BLAZE R920	R228
ABRASIVE:	Ceramic Alumina	Aluminum Oxide
OTHER:	Supersize, 2 Per Set	2 Per Set

DIA.	EYELET	GRIT	STD. PKG.	PART #	PART #
1	8-32	60	100		088341 84346
		80	100		088341 84019
		100	100		088341 84224
		120	100		088341 84151
1-1/4	8-32	60	100		088341 84270
		80	100		088341 84065
		100	100		088341 84291
		120	100		088341 84084
1-1/2	8-32	60	100	662611 95051	088341 84066
		80	100	662611 95368	088341 84079
		100	100		088341 84279
		120	100	662611 95367	088341 86035
1-3/4	8-32	60	100		088341 84655
		80	100		088341 84042
2	8-32	60	100	662611 95054	
		80	100	662611 95055	088341 84076
		100	100		088341 84145
		120	100	662611 95056	088341 84055
2-1/2	8-32	80	100		088341 84444
3	1/4-20	60	100	662611 95057	088341 84041
		80	100	662611 95058	088341 84077
		100	100		088341 84082
		120	100		088341 84344
4	1/4-20	60	100		088341 84000
		120	100		088341 85155
4-1/2	1/4-20	100	100		088341 84431

All overlap slotted discs are available (made-to-order) reinforced with a fiber washer
 Ceramic Alumina and Alumina Oxide overlap slotted discs are also available upon request as made-to-order products.
 Some part numbers are non-stock; contact your Norton representative for status, order quantities and lead-times.

Quick-Change Mandrels for Overlap Slotted Discs, Square and Cross Pads

CROSS PAD SIZE DIA.	SQUARE PAD SIZE DIA.	OVERALL LENGTH	MODEL NO.	THD. SIZE	PART #
1/4, 3/8, and 1/2 wide		2-1/2	MM48-4	3-48	088341 83162
3/4, 1 wide	Up thru 1-1/2 sq. x 1/2 thick 2 sq. x 1/4 or 3/8 thick	3	MM32-4	8-32	088341 83163
		4	MM-32-4-4	8-32	088341 21680
		6	MM-32-4-6	8-32	088341 21681
All pads 2-1/2 x 1-1/2 and larger	2 sq. x 1/4 or 1/2 thick and larger	3	MM20-4	1/4-20	088341 83164

For overlap slotted discs, choose a mandrel with the same thread size as the disc

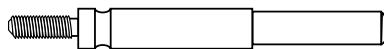

QUICK-CHANGE MANDREL



EXTENDED MANDREL



Best product for blending and polishing contours when smooth running is a primary concern. Used for finishing hard-to-reach areas, removing parting lines, imperfections, and burrs on all surfaces.

Benefits:

Spiral construction avoids shadow marks and provides smooth, chatter-free cutting action. Achieves close tolerances when finishing curved, contoured, and hard-to-reach areas. Fast cutting and removes toughest metal. Bands are easily removed and replaced.

Grit Range:

24 - 320

Abrasive Grain:

Ceramic Alumina, Aluminum Oxide

Backing:

X-weight cotton

Other:

Use with rubber expanding drum

Machine Used:



DIE GRINDER

Application/Grit Recommendation Guide

← COARSER (GRINDING)					FINER (FINISHING) →				
24	36	40	50	60	80	120	180	240	320
Heavy Stock Removal									
Blending Out Heavy Machine Marks									
Removing Heavy Burrs									
Applying Heavy Scratch Pattern									
Removing Flash/Parting Lines									
Removing Rust/Scale/Pit Marks									
			Preparing Metal for Painting						
			Blending Out Medium Machine Marks						
					Blending Metal Surfaces				
					Applying Light Scratch Pattern				
							Fine Blending and Cleaning		
								Metal Finishing and Polishing	

Best choice for hard-to-grind materials including super alloys (cobalt, inconel, and titanium) and stainless steel



BLAZE R920 CERAMIC ALUMINA

- See significantly faster, cooler, burn-free results on the toughest jobs from the next-generation of sharp, longest-lasting P-graded ceramic abrasive grains and advanced grinding aid lubricant
- Advanced, full resin bond system designed to promote exceptional grain retention for additional product life
- X-weight cotton backing and spiral construction avoid shadow marks and provide smooth, chatter-free cutting action

Good starting specification for all types of metal



R228 ALUMINUM OXIDE

- Tough and durable quality aluminum oxide abrasive removes tough metal
- X-weight cotton backing and spiral construction avoid shadow marks and provide smooth, chatter-free cutting action
- Achieves close tolerances on curved, contoured, and hard-to-reach areas



TIER: **BEST**
 TRADENAME: **BLAZE R920**
 ABRASIVE: Ceramic Alumina
 OTHER: Supersize

SIZE (D x W)	GRIT	STD. PKG.	PART #
1/2 x 1	40	100	662611 46012
	60	100	662611 46013
	80	100	662611 46014
	120	100	662611 46015
3/4 x 1	40	100	662611 46016
	60	100	662611 46017
	80	100	662611 46018
	120	100	662611 46019
1 x 1	40	100	662611 46020
	60	100	662611 46021
	80	100	662611 46022
	120	100	662611 46023
1-1/2 x 1-1/2	40	100	662611 46024
	60	100	662611 46025
	80	100	662611 46026
	120	100	662611 46027
2 x 2	40	100	662611 46028
	60	100	662611 46029
	80	100	662611 46030
	120	100	662611 46031
3 x 3	40	50	662611 46032
	60	50	662611 46033
	80	50	662611 46034
	120	50	662611 46035



TIER: **GOOD**
 TRADENAME: **R228**
 ABRASIVE: Aluminum Oxide

SIZE (D x W)	GRIT	STOCK PKG. QTY.	NON-STOCK MOQ	PART #
3/8 x 1	80	100/box	300	088341 96645
1/2 x 1/2	50	100/box	300	088341 96228
	80	100/box	300	088341 96179
	100	100/box	300	088341 96189
	120	100/box	300	088341 96069
1/2 x 1	180	100/box	300	088341 96209
	36	100/box	300	088341 96591
	40	100/box	300	088341 96174
	60	100/box	300	088341 96212
1/2 x 2	80	100/box	300	088341 96215
	120	100/box	300	088341 96210
	50	100/box	200	088341 96548
	80	100/box	200	088341 96669
3/4 x 3/4	60	100/box	300	088341 96168
	80	100/box	300	088341 96161
3/4 x 1	36	100/box	300	088341 96261
	40	100/box	300	088341 96517
	50	100/box	300	088341 96515
	60	100/box	300	088341 96070
	80	100/box	300	088341 96071
	120	100/box	300	088341 96219
3/4 x 1-1/2	24	100/box	300	088341 96596
	60	100/box	300	088341 96554
	80	100/box	300	088341 96249
3/4 x 2	80	100/box	200	088341 96756



TIER: **GOOD**
 TRADENAME: **R228**
 ABRASIVE: Aluminum Oxide

SIZE (D x W)	GRIT	STOCK PKG. QTY.	NON-STOCK MOQ	PART #
1 x 1	36	100/box	300	088341 96072
	40	100/box	300	088341 96073
	50	100/box	300	088341 96184
	60	100/box	300	088341 96075
	80	100/box	300	088341 96074
	120	100/box	300	088341 96177
1 x 1-1/2	36	100/box	200	088341 96525
1 x 2	80	100/box	200	088341 96268
	100	100/box	200	088341 96750
1 x 3	36	100/box	100	088341 96665
	50	100/box	100	088341 97688
	60	100/box	100	088341 96676
	80	100/box	100	088341 96195
	120	100/box	100	088341 96197
	1-1/2 x 1-1/2	36	100/box	200
40		100/box	200	088341 96171
50		100/box	200	088341 96176
60		100/box	200	088341 96091
80		100/box	200	088341 96165
120		100/box	200	088341 96066

Some part numbers are non-stock; contact your Norton representative for status, order quantities and lead-times.

Continued



TIER: **GOOD**
TRADENAME: **R228**
ABRASIVE: Aluminum Oxide

SIZE (D x W)	GRIT	STOCK PKG. QTY.	NON-STOCK MOQ	PART #
1-1/2 x 2	60	100/box	200	088341 96067
	80	100/box	200	088341 96533
1-1/2 x 3	36	100/box	100	088341 97063
	60	100/box	100	088341 96703
	80	100/box	100	088341 96809
	120	100/box	100	088341 96343
	180	100/box	100	088341 97869
2 x 1	80	100/box	200	088341 96166
	120	100/box	200	088341 96595
2 x 2	36	100/box	200	088341 96110
	40	100/box	200	088341 96172
	60	100/box	200	088341 96173
	80	100/box	200	088341 96181
	120	100/box	200	088341 96585
2 x 3	50	100/box	100	088341 96152
	60	100/box	100	088341 96175
	80	100/box	100	088341 96198
2-1/4 x 3	36	100/box	100	088341 97140
	50	100/box	100	088341 96620
	80	100/box	100	088341 96270
	120	100/box	100	088341 96729
	150	100/box	100	088341 95857



TIER: **GOOD**
TRADENAME: **R228**
ABRASIVE: Aluminum Oxide

SIZE (D x W)	GRIT	STOCK PKG. QTY.	NON-STOCK MOQ	PART #
3 x 2	40	100/box	100	088341 96090
	50	100/box	100	088341 96264
	60	100/box	100	088341 96530
	80	100/box	100	088341 96265
3 x 3	120	100/box	100	088341 96531
	24	100/box	100	088341 96256
	36	100/box	100	088341 96262
	40	100/box	100	088341 96555
	50	100/box	100	088341 96253
	60	100/box	100	088341 96188
	80	100/box	100	088341 96159
	100	100/box	100	088341 96250
	120	100/box	100	088341 96572
150	100/box	100	088341 96452	
180	100/box	100	088341 96131	
320	100/box	100	088341 97968	

Some part numbers are non-stock; contact your Norton representative for status, order quantities and lead-times.

Expanding Rubber Drums

Spiral Bands are easily removed and replaced on the rubber expanding drum.



TIER: **GOOD**
TRADENAME: **RUBBER EXPANDING DRUMS**

DRUM DIAMETER	WIDTH	SHANK DIAMETER	MAX. RPM	STD. PKG.	PART #
1/4	1/2	1/8	30,000	1	088341 96030
3/8	1/2	1/4	30,000	1	088341 96944 NS
3/8	1	1/8	18,000	1	088341 96011 NS
1/2	1/2	1/4	30,000	1	088341 96904
1/2	1	1/4	15,000	1	088341 96906
1/2	1-1/2	1/4	12,000	1	088341 96907
1/2	2	1/4	10,000	1	088341 96908
3/4	1/2	1/4	27,000	1	088341 96909 NS
3/4	3/4	1/4	24,000	1	088341 96910 NS
3/4	1	1/4	17,000	1	088341 96911
3/4	1-1/2	1/4	10,000	1	088341 96912
3/4	2	1/4	10,000	1	088341 96913

NS Non-stock, contact your Norton representative for current order quantities and lead-times.



TIER: **GOOD**
TRADENAME: **RUBBER EXPANDING DRUMS**

DRUM DIAMETER	WIDTH	SHANK DIAMETER	MAX. RPM	STD. PKG.	PART #
1	1/2	1/4	20,000	1	088341 96914 NS
1	1	1/4	18,000	1	088341 96916
1	1-1/2	1/4	10,000	1	088341 96917
1	2	1/4	8,000	1	088341 96918
1-1/2	1	1/4	12,000	1	088341 96921
1-1/2	1-1/2	1/4	10,000	1	088341 96922
1-1/2	2	1/4	8,000	1	088341 96923
2	1	1/4	11,000	1	088341 96926
2	1-1/2	1/4	8,000	1	088341 96927
2	2	1/4	6,000	1	088341 96928
3	1	3/8	3,000	1	088341 96929 NS
3	2	3/8	3,000	1	088341 96930 NS
3	3	3/8	3,000	1	088341 96931



Tapered cone points are strips of abrasive cloth rolled and glued to form a solid shape that is designed to break down during use and reveal the next layer of abrasive. Tapered cone points are similar to cartridge rolls but their shape lends greater accessibility to many difficult-to-reach work areas. They are used for deburring holes and in close tolerance work areas.

- Applications:** Used on inside surfaces and inside corners where other abrasive shapes cannot reach. Typically these are used on high-speed air grinders and are always mounted on a mandrel. Ideal for flash removal, polishing, or removing machine tool marks, and edge breaking.
- Grit Range:** 50 - 320
- Abrasive Grain:** Aluminum Oxide
- Backing:** X-weight cotton
- Construction:** Popular sizes and mandrels are listed, with additional sizes available upon request as made-to-order products
Ceramic alumina and silicon carbide cone points are available upon request as made-to-order products
- Maximum RPM:** 1/8" to 1/2" – 23,000
5/8" to 1" – 18,000
1" to 1-1/2" – 15,000
- Machine Used:**  DIE GRINDER

Application/Grit Recommendation Guide

COARSER (GRINDING) ←									FINER (FINISHING) →	
36	40	50	60	80	120	180	240	320		
Blending Out Heavy Machine Marks										
Removing Heavy Burrs										
Applying Heavy Scratch Pattern										
Removing Flash/Parting Lines										
Removing Rust/Scale/Pit Marks										
		Preparing Metal for Painting								
		Blending Out Medium Machine Marks								
				Blending Metal Surfaces						
				Applying Light Scratch Pattern						
						Fine Blending and Cleaning				
							Metal Finishing and Polishing			

Good starting specification for flash removal, polishing, or removing machine tool marks and edge breaking on all types of metal in difficult-to-reach work areas



R228 ALUMINUM OXIDE TAPERED CONE POINTS

- Quality aluminum oxide abrasive delivers long life
- X-weight cotton cloth provides extended durability, conformability, and superior wear resistance; strong resin bond system provides good grain retention and life
- Full taper construction consisting of rolled and half-glued abrasive strips that break down to expose next layer of abrasive

TIER: GOOD			
TRADENAME: R228			
ABRASIVE: Aluminum Oxide			
SIZE (D x L x H)	GRIT	STD. PKG.	PART #
3/16 x 1 x 2-1/2° Use K-110 Mandrel	50	500	088341 86892
	60	500	088341 86893
	80	500	088341 80918
	100	500	088341 82197
	120	500	088341 82199
	150	500	088341 82200
	180	500	088341 86894
	240	500	088341 86895
320	500	088341 82855	

TIER: GOOD			
TRADENAME: R228			
ABRASIVE: Aluminum Oxide			
SIZE (D x L x H)	GRIT	STD. PKG.	PART #
5/16 x 1-1/2 x 5° Use B-20 Mandrel	80	500	088341 80873
	100	500	088341 82043
	120	500	088341 82717
	150	500	088341 86890
	180	500	088341 82535
	240	500	088341 82044
	320	500	088341 82537

Refer to next page for mandrels.

Continued

Cartridge and Spiral Roll Mandrels

MODEL #	PILOT DIA.	PILOT LENGTH	SHANK DIA.	SHANK LENGTH	OVERALL LENGTH	PART #
Cartridge and Spiral Roll Mandrels						
M-2E	3/32	3/4	1/4	1	3	088341 83799 NS
M-2	3/32	1	1/8	1	3	088341 81202
M-3	1/8	1/2	1/8	1	2-1/2	088341 81203
M-4	1/8	3/4	1/8	1	2-1/2	088341 81204
M-5	1/8	1	1/8	1	2-3/4	088341 81205
M-6	1/8	1-1/2	1/8	1	2-1/2	088341 81206 NS
M-7	1/8	1/2	1/4	1-1/4	2-1/4	088341 81207
M-8	1/8	3/4	1/4	1-1/4	2-1/2	088341 81208
M-9	1/8	1	1/4	1-1/4	2-3/4	088341 81209
M-10	1/8	1-1/2	1/4	1-1/4	3-1/4	088341 81210
M-11	1/8	2	1/4	1-1/4	4	088341 81211 NS
M-12	3/16	1/2	1/8	1-1/4	2-1/4	088341 81212 NS
M-13	3/16	3/4	1/8	1-1/4	2-1/2	088341 81213 NS
M-14	3/16	1/2	1/4	1-1/4	2-1/2	088341 81214 NS
M-15	3/16	3/4	1/4	1-1/4	2-3/4	088341 81215 NS
M-16	3/16	1	1/4	1-1/4	3	088341 81216
M-17	3/16	1-1/2	1/4	1-1/4	3-1/2	088341 81217
M-18	3/16	2	1/4	1-1/4	4	088341 81218
M-19	1/4	1/2	1/4	1-1/4	2-1/2	088341 81219 NS
M-20	1/4	3/4	1/4	1-1/4	2-3/4	088341 81220 NS
M-21	1/4	1	1/4	1-1/4	3	088341 81221
M-22	1/4	1-1/2	1/4	1-1/4	3-1/2	088341 81222
M-23	1/4	2	1/4	1-1/4	4	088341 81223 NS
M-24	5/16	3/4	1/4	1-1/4	2-3/4	088341 81224 NS
M-25	5/16	1	1/4	1-1/4	3	088341 81225 NS
M-26	5/16	1-1/2	1/4	1-1/4	3-1/2	088341 81226 NS
M-27	5/16	2	1/4	1-1/4	4	088341 81227 NS

*NS Non-stock. Contact your Norton representative for current order quantities and lead-times.
Standard Package = 1*

Recommended Pilot Length for Mandrels

3/4 Roll Length	Use 1/2 Pilot
1 Roll Length	Use 3/4 Pilot
1-1/2 Roll Length	Use 1 Pilot
2 Roll Length	Use 1-1/2 Pilot

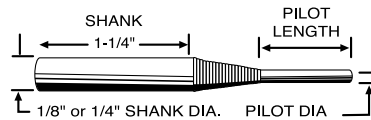

Extra Shank Length Mandrels for Cartridge Rolls and Spiral Rolls

MODEL #	SHANK LENGTH	OVERALL LENGTH	PART NO.
Extras Shank Length Mandrels			
M-8-4	4	5-1/4	088341 80116
M-8-6	6	7-1/4	088341 80122
M-9-2.5	2-1/2	4	088341 80096
M-9-3	3	4-1/2	088341 80129
M-9-4	4	5-1/2	088341 80074 NS
M-9-6	6	7-1/2	088341 80131
M-10-4	1-3/4	4	088341 80092 NS
M-10-6	3-3/4	6	088341 80145

All Extra Shank Length mandrels are 1/4" diameter

*NS Non-stock. Contact your Norton representative for current order quantities and lead-times.
Standard Package = 1*

Tapered Cone Point Mandrels

DESCRIPTION	SHANK	PART #
Cone Point Mandrels		
A-10	1/4	088341 81300
B-20	1/4	088341 81301
C-30	1/4	088341 81302
D-40	1/4	088341 81303
E-50	1/4	088341 81304
F-60	1/4	088341 81305
G-70	1/4	088341 81306
I-90	1/4	088341 81308
K-110	1/8	088341 81310



Standard Package = 1

These test kits feature the most popular range and sizes of our coated specialty products in convenient kit formats. Ideal for small job shops, or for travelling to a job site. Our cartridge roll kits are great when you need a small quantity, but a wide range of grits and sizes



Ceramic Alumina Cartridge Roll Test Kit

- Part # 662610**66726**
- Kit includes a variety of our ceramic alumina cartridge rolls, spiral rolls and mandrels in popular sizes and grits.



Aluminum Oxide Cartridge Roll Test Kit "CR"

- Part # 088341**181061**
- Includes over 120 pieces of our most popular sizes, grits and shapes with their appropriate mandrels.



General Purpose Test Kit "GP"

- Part # 088341**169025**
- Includes samples of various abrasive specialties. One of these kits could be worth the cost of the entire kit by solving your problems in deburring, polishing and grinding.



Porting Test Kit "APK-MO"

- Part # 088341**169032**
- The samples in this kit highlight specialties for general metal and wood working polishing and finishing applications.



Surface Preparation Stars

The perfect item for ID work



SURFACE PREPARATION STARS

- Star shape design is tough yet conformable to intricate shapes and contours without changing the workpiece dimension
- Premium aluminum oxide grain for excellent cutting and finishing
- Firm durable web for high resistance to tearing on burrs and sharp edges

TIER: **BETTER**
 TRADENAME: **SURFACE PREP**
 ABRASIVE: Aluminum Oxide
 ATTACHMENT: 1/4-20 Eyelet

SIZE (D x EYELET)	GRIT	STD. PKG.	PART #
1-1/2" x 1/4-20	C	100	088341 85923
	M	100	088341 85924
	VF	100	088341 85925
2" x 1/4-20	C	100	088341 85926
	M	100	088341 85927
	VF	100	088341 85928
3" x 1/4-20	C	100	088341 85929
	M	100	088341 85678
	VF	100	088341 85931
4" x 1/4-20	C	100	088341 85932
	M	100	088341 85933
	VF	100	088341 85934

Some part number are non-stock, contact your Norton representative for status, order quantities and lead-times.
 1/4-20 eyelets attach to MM20-4 mandrel, Part # 088341**83164** (See description at end of Overlap Slotted Disc Section.)

Cross Buffs

Best choice for blending, cleaning and polishing



CROSS BUFFS

- Unique design is tough yet conformable to intricate shapes and contours without changing the workpiece dimension
- Premium aluminum oxide grain for excellent cutting and finishing
- Firm durable web for high resistance to tearing on burrs and sharp edges

TIER: **BEST** **BETTER**
 TRADENAME: **HIGH STRENGTH** **BUFFING**
 ABRASIVE: Aluminum Oxide Aluminum Oxide
 ATTACHMENT: 8-32 Eyelet 8-32 Eyelet

SIZE (D x W)	GRIT	PLY	STD. PKG.	PART #	PART #
1-1/2 x 1/2	Coarse	2	100		088341 88761
	Medium	2	100	088341 89306	088341 87312
	Very Fine	2	100	088341 89307	088341 88585
1-1/2 x 1/2	Coarse	3	100		666233 01763
	Medium	3	100	088341 89308	088341 87311
	Very Fine	3	100	088341 89309	088341 88586

8-32 eyelets: Attach to MM32-4 mandrel. Part No. 088341**83163** (See description at end of Overlap Slotted Disc Section)

Non-Woven Disc Wheels with 1/4" Steel Shank

Best choice for all of your tough stripping needs on all kinds of surfaces



BLAZE RAPID STRIP DISCS

- Ceramic alumina grain provides 2X cut rate, 2X life over silicon carbide products
- Advanced resin bond does not shed on rust-encrusted pieces, and prevents gouging and rework; does not snag when used for deburring
- Leave a thoroughly cleaned surface that ensures excellent adhesion for subsequent processes such as coating, painting and soldering

Better choice for light deburring and finishing



DISC WHEELS

- Durable, longer lasting aluminum oxide abrasive leaves a more polished finish
- Discs are ganged together to form a wheel that is tough yet conformable to intricate shapes and contours without changing the workpiece dimension
- These wheels are mounted on a 1/4 inch steel mandrel embedded in a strong epoxy core



TIER: **BEST**
TRADENAME: **BLAZE RAPID STRIP**
ABRASIVE: Ceramic Alumina

SIZE (D x W x 1/4 SHANK)	GRIT	PLY	MAX. RPM	STD. PKG.	PART #
4 x 1/2	Extra Coarse	1 Ply	8,000	5	776960 05713
4 x 1	Extra Coarse	2 Ply	8,000	5	666233 75051



TIER: **BETTER**
ABRASIVE: Aluminum Oxide

SIZE (D x W x 1/4 SHANK)	GRIT	PLY	MAX. RPM	STD. PKG.	PART #
2 x 1/2	Medium	2 Ply	12,000	10	088341 31551
2 x 1	Medium	4 Ply	12,000	10	088341 31554
3 x 1/2	Medium	2 Ply	8,000	10	088341 31558
	Very Fine	3 Ply	8,000	10	088341 31560
3 x 1	Medium	4 Ply	8,000	10	088341 31496
	Fine	5 Ply	8,000	10	088341 31557
	Very Fine	5 Ply	8,000	10	088341 31497
4 x 1/2	Fine	3 Ply	6,000	10	088341 31562
4 x 1	Medium	4 Ply	6,000	10	088341 31564
5 x 1/2	Medium	2 Ply	4,000	10	088341 31567
5 x 1	Medium	4 Ply	4,000	10	088341 31570
	Fine	5 Ply	4,000	10	088341 31571

Disc wheels are constructed by number of plies. The actual face width will vary and will not match the listed width exactly. Face width is given for reference only.



Flap wheels are an ideal choice for a wide variety of blending, deburring and finishing applications common in the metal fabrication, welding and polishing industries. Flap wheels are conformable to intricate shapes and contours. Designed to deliver a consistent finish with a uniform rate of cut, flap wheels wear away, continually exposing fresh abrasives.

Applications:

Used for a wide range of metal fabrication and welding applications including stock removal, blending, deburring, cleaning, finishing, and polishing

Size Range:

Flap wheels with mounted steel shanks: 3/8" - 3" diameter

Flap wheels with mounted 1/4"-20 thread: 1" - 3" diameter

Flap wheels with arbor holes: 3" - 16" diameter

Grit Range:

40 - 320

Abrasive Grain:

Ceramic Alumina, Aluminum Oxide Blend, Aluminum Oxide

Machine Used:

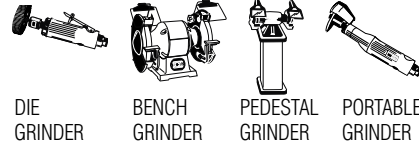



DIE GRINDER

BENCH GRINDER

PEDESTAL GRINDER

PORTABLE GRINDER

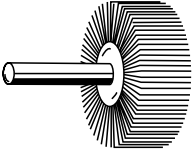
Shape Recommendation Guide

Shape	Description/Application
	<p>Flap Wheels with Mounted Steel Shanks</p> <p>Wheels are designed with a 1/8" or 1/4" steel shank as an integral part of each wheel. These shanks run through the wheel creating better balance, a reduction of chatter, and reduced operator fatigue. They also permit quick changes on air tools when using other abrasive products.</p>
	<p>Flap Wheels with Mounted 1/4"-20 Thread</p> <p>Wheels are designed with a 1/4"-20 thread and flange as an integral part of the wheel. These threads facilitate the quickest changes on air tools using flap wheels exclusively, as there are no special tools needed to change the flap wheel. Also allow extended reach with accessory mandrels.</p>
	<p>Flap Wheels with Arbor Holes</p> <p>For use on larger portable and fixed-base tools where the wheel must fit on an existing arbor.</p>

Application/Grit Recommendation Guide

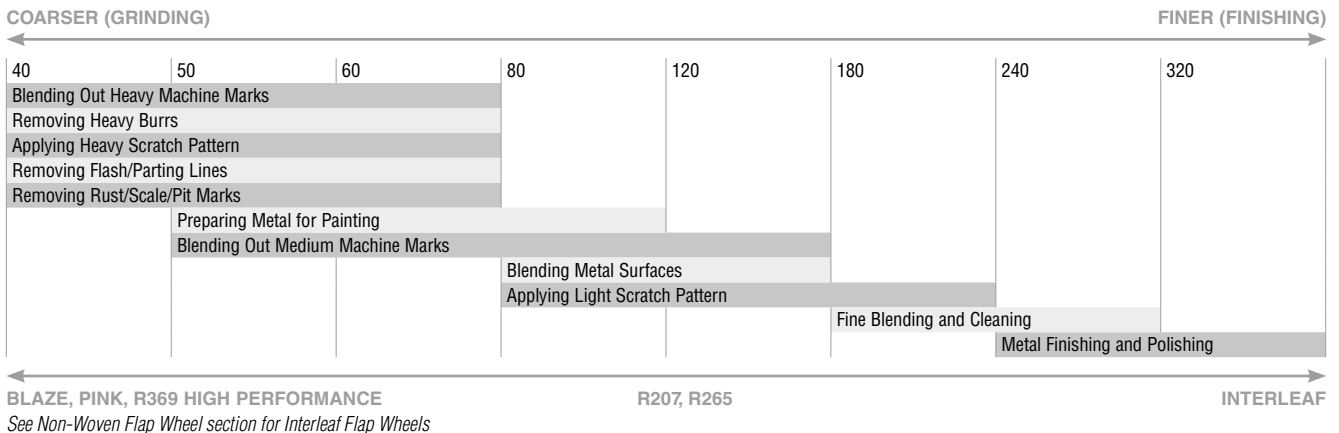



Best choice for hard-to-grind materials, including superalloys (cobalt, inconel, and titanium) and stainless steel!

BLAZE R920 CERAMIC ALUMINA

- See significantly faster, cooler, burn-free results on the toughest jobs from the next-generation of sharp, longest-lasting P-graded ceramic abrasive grains and advanced grinding aid lubricant
- X-weight cotton flaps provide conformability and even wear
- Advanced self-lubricating grain treatment reduces heat on hard-to-grind materials



Better choice for blending, deburring and finishing on a wide range of materials

PINK R928 CERAMIC ALUMINA

- Ceramic grain provides better performance than zirconia alternatives
- Improved resin bond system provides longer life
- Versatile X-weight poly cotton backing for flexibility and life

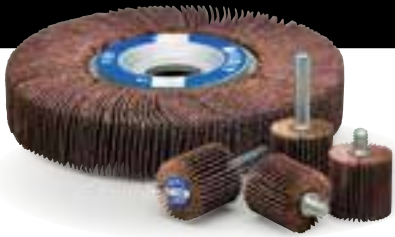

Good choice for more durable flap wheel applications where aggressive cut and superior life are required

R369 HIGH PERFORMANCE ALUMINUM OXIDE BLEND

- Long-lasting premium aluminum oxide blend with 2 to 3 times longer life
- Delivers an excellent cut rate on finishing operations
- Heavy cotton/polyester blended flaps provide extended durability, conformability, and superior wear resistance



Good choice for more flexible flap wheel applications where finish is required

R207 ALUMINUM OXIDE

- P-graded, solid-performing aluminum oxide abrasive delivers uniform stock removal and long life
- Heavy X-weight cotton flaps provide conformability and even wear
- Good general purpose starting specification for small deburring and cleaning jobs



Good choice when initial price is a key purchasing criteria

R265 ALUMINUM OXIDE

- Quality aluminum oxide abrasive provides good cut rate and life
- Heavy cotton/polyester blended flaps provide extended durability, conformability, and superior wear resistance
- Designed for all-purpose use where price is the major consideration



Micro-Mini Flap Wheels with 1/8" Mounted Steel Shanks

- The smallest flap wheels, ranging from 3/8" to 1-3/16" diameter, mounted on a 1/8" diameter steel shank
- Provide fast polishing and light deburring of internal workpieces with holes or grooves as small as 1/2"



TIER: **GOOD**
 TRADENAME: **R369**
 ABRASIVE: Premium Aluminum Oxide
 BACKING: Y-Weight Cotton

SIZE (D x W x SK.)	GRIT	MAX. RPM	STD. PKG.	PART #
3/8 x 3/8 x 1/8	60	40,000	10	088341 37470
	80	40,000	10	088341 37471
	120	40,000	10	088341 37472
	180	40,000	10	088341 37473
	240	40,000	10	088341 37474
5/8 x 5/8 x 1/8	320	40,000	10	088341 37475
	60	37,000	10	088341 37480
	80	37,000	10	088341 37481
	120	37,000	10	088341 37482
	180	37,000	10	088341 37483
5/8 x 3/4 x 1/8	240	37,000	10	088341 37484
	320	37,000	10	088341 37485
	80	37,000	10	088341 37541
	120	37,000	10	088341 37542
	180	37,000	10	088341 37543
3/4 x 3/16 x 1/8	240	37,000	10	088341 37544
	320	37,000	10	088341 37545
	60	35,000	10	088341 37550
	80	35,000	10	088341 37551
	120	35,000	10	088341 37552
3/4 x 3/8 x 1/8	180	35,000	10	088341 37553
	240	35,000	10	088341 37554
	320	35,000	10	088341 37555
	60	35,000	10	088341 37560
	80	35,000	10	088341 37561
3/4 x 1/2 x 1/8	120	35,000	10	088341 37562
	180	35,000	10	088341 37563
	240	35,000	10	088341 37564
	320	35,000	10	088341 37565
	60	35,000	10	088341 37570
3/4 x 1/2 x 1/8	80	35,000	10	088341 37571
	120	35,000	10	088341 37572
	180	35,000	10	088341 37573
	240	35,000	10	088341 37574
320	35,000	10	088341 37575	



TIER: **GOOD**
 TRADENAME: **R369**
 ABRASIVE: Premium Aluminum Oxide
 BACKING: Y-Weight Cotton

SIZE (D x W x SK.)	GRIT	MAX. RPM	STD. PKG.	PART #
3/4 x 5/8 x 1/8	60	35,000	10	088341 37580
	80	35,000	10	088341 37581
	120	35,000	10	088341 37582
	180	35,000	10	088341 37583
	240	35,000	10	088341 37584
3/4 x 3/4 x 1/8	320	35,000	10	088341 37585
	60	35,000	10	088341 37590
	80	35,000	10	088341 37591
	120	35,000	10	088341 37592
	180	35,000	10	088341 37593
1-3/16 x 1/8 x 1/8	240	35,000	10	088341 37594
	320	35,000	10	088341 37595
	80	30,000	10	088341 37491
	120	35,000	10	088341 37492
1-3/16 x 3/16 x 1/8	180	35,000	10	088341 37493
	320	35,000	10	088341 37495
	60	30,000	10	088341 37508
	80	35,000	10	088341 37501
1-3/16 x 3/8 x 1/8	120	35,000	10	088341 37502
	180	35,000	10	088341 37503
	240	35,000	10	088341 37504
	320	35,000	10	088341 37505
	80	30,000	10	088341 37511
1-3/16 x 3/8 x 1/8	120	35,000	10	088341 37512
	180	35,000	10	088341 37513
	240	35,000	10	088341 37514
	320	35,000	10	088341 37515

Some part numbers are non-stock; contact your Norton representative for status, order quantities and lead-times.



Micro-Mini Test Kit "MMC"

- Part # 088341**131493**
- Includes five wheels, 3/8" to 1-3/16" diameter in various grits, mounted on a 1/8" diameter hardened steel shank
- The "MMC" kit is ideal for fast polishing and light deburring of internal holes or grooves as small as 1/2"

Mini Flap Wheels with 1/4" Mounted Steel Shanks

- Small flap wheels, ranging from 1" to 3" diameter, mounted on a 1/4" diameter steel shank
- Very durable, long-lasting mini flap wheels for demanding, heavy stock removal applications



		TIER: BEST		TIER: BETTER		TIER: GOOD		TIER: GOOD		TIER: GOOD	
		TRADENAME: BLAZE R920		TRADENAME: PINK R928		TRADENAME: R369		TRADENAME: R207		TRADENAME: R265	
		ABRASIVE: Ceramic Alumina		ABRASIVE: Ceramic Alumina		ABRASIVE: Premium Aluminum Oxide		ABRASIVE: Aluminum Oxide		ABRASIVE: Aluminum Oxide	
		BACKING: X-Weight Cotton		BACKING: X-Weight Poly/Cotton		BACKING: Y-Weight Cotton		BACKING: X-Weight Cotton			
SIZE (D x W x SK.)	GRIT	MAX. RPM	STD. PKG.	PART #	PART #	PART #	PART #	PART #	PART #	PART #	PART #
1 x 1/2 x 1/4	80	30,000	10								088341 49801
	120	30,000	10								088341 49802
1 x 5/8 x 1/4	40	30,000	10				088341 137105				
	60	30,000	10				088341 137100	636425 02576			
	80	30,000	10				088341 137101	636425 02577			
	120	30,000	10				088341 137102	636425 02578			
	180	30,000	10				088341 131536				
1 x 1 x 1/4	240	30,000	10				088341 137104				
	40	30,000	10		699573 39701	088341 131259				088341 49803	
	60	30,000	10	662611 151170	699573 39702	088341 137310	636425 02580			088341 49804	
	80	30,000	10	662611 151171	699573 39703	088341 137311	636425 02581			088341 49805	
	120	30,000	10	662611 151172	699573 39704	088341 137312	636425 02582			088341 49806	
	180	30,000	10			088341 137313				088341 49807	
	240	30,000	10			088341 137114					
1-3/8 x 5/8 x 1/4	320	30,000	10			088341 137315					
	60	30,000	10			088341 137320					
	80	30,000	10			088341 137321					
	120	30,000	10			088341 137322					
1-1/2 x 1/2 x 1/4	180	30,000	10			088341 137323					
	240	30,000	10			088341 137324					
	60	25,000	10							088341 49810	
1-1/2 x 1 x 1/4	80	25,000	10							088341 49811	
	40	25,000	10			088341 135140					
1-1/2 x 1 x 1/4	60	25,000	10			088341 137340	636425 02592			088341 49816	
	80	25,000	10			088341 137141	636425 02593			088341 49817	
	120	25,000	10			088341 137142	636425 02594			088341 49818	
	180	25,000	10			088341 137343					
	240	25,000	10			088341 132101					
1-1/2 x 1-1/2 x 1/4	40	25,000	10			088341 130642					
	60	25,000	10			088341 130643					
	80	25,000	10			088341 130644					
	120	25,000	10			088341 130641					
2 x 1/2 x 1/4	180	25,000	10			088341 130695					
	60	25,000	10							088341 49821	
2 x 1/2 x 1/4	80	25,000	10							088341 49822	
	120	25,000	10							088341 49823	
	40	25,000	10			088341 137158					
2 x 3/4 x 1/4	60	25,000	10			088341 137160					
	80	25,000	10			088341 137161					
	120	25,000	10			088341 137162					
	180	25,000	10			088341 137163					
	180	25,000	10			088341 137163					

Some part numbers are non-stock; contact your Norton representative for status, order quantities and lead-times.

Continued

Mini Flap Wheels with 1/4" Mounted Steel Shanks *continued*



		TIER: BEST		TIER: BETTER		TIER: GOOD		TIER: GOOD		TIER: GOOD	
		TRADENAME: BLAZE R920		TRADENAME: PINK R928		TRADENAME: R369		TRADENAME: R207		TRADENAME: R265	
		ABRASIVE: Ceramic Alumina		ABRASIVE: Ceramic Alumina		ABRASIVE: Premium Aluminum Oxide		ABRASIVE: Aluminum Oxide		ABRASIVE: Aluminum Oxide	
		BACKING: X-Weight Cotton		BACKING: X-Weight Poly/Cotton		BACKING: Y-Weight Cotton		BACKING: X-Weight Cotton		BACKING: X-Weight Cotton	
SIZE (D x W x SK.)	GRIT	MAX. RPM	STD. PKG.	PART #	PART #	PART #	PART #	PART #	PART #	PART #	PART #
2 x 1 x 1/4	40	25,000	10		699573 39705	088341 37377				088341 49824	
	50	25,000	10			088341 37169					
	60	25,000	10	662611 51173	699573 39706	088341 37370		636425 02600		088341 49825	
	80	25,000	10	662611 51174	699573 39711	088341 37371		636425 02601		088341 49826	
	120	25,000	10	662611 51175	699573 39712	088341 37372		636425 02602		088341 49827	
	180	25,000	10			088341 37373				088341 49828	
	240	25,000	10			088341 37374					
2 x 1-1/2 x 1/4	40	25,000	10			088341 37183					
	60	25,000	10			088341 37380					
	80	25,000	10			088341 37381					
	120	25,000	10			088341 37382					
	180	25,000	10			088341 37383					
2-1/2 x 1 x 1/4	40	20,000	10			088341 37408					
	60	20,000	10			088341 37410		636425 02608			
	80	20,000	10			088341 37411		636425 02609			
	120	20,000	10			088341 37412		636425 02610			
	180	20,000	10			088341 37413					
	240	20,000	10			088341 37633					
	320	20,000	10			088341 37415					
2-1/2 x 1-1/2 x 1/4	60	20,000	10			088341 37420					
	80	20,000	10			088341 37421					
	120	20,000	10			088341 37422					
3 x 1/2 x 1/4	60	20,000	10					636425 02612		088341 49834	
	80	20,000	10					636425 02613		088341 49835	
	120	20,000	10					636425 02614			
3 x 3/4 x 1/4	60	20,000	10			088341 37440					
	80	20,000	10			088341 37441					
3 x 1 x 1/4	40	20,000	10		699573 39713	088341 37456				088341 49836	
	60	20,000	10	662611 51176	699573 39714	088341 37450		636425 02620		088341 49837	
	80	20,000	10	662611 51177	699573 39715	088341 37451		636425 02621		088341 49838	
	120	20,000	10	662611 51178	699573 39716	088341 37252		636425 02622		088341 49839	
	180	20,000	10			088341 37253				088341 49840	
	240	20,000	10			088341 35339					
	320	20,000	10			088341 35341					
3 x 2 x 1/4	40	12,000	10			088341 37460					
	60	12,000	10			088341 37260					
	80	12,000	10			088341 37261					
	120	12,000	10			088341 37262					
	180	12,000	10			088341 37263					

Some part numbers are non-stock; contact your Norton representative for status, order quantities and lead-times.



Mini 1/4" Steel Shank Test Kit "CMM"

- Part # 088341**38004**
- Includes ten wheels, 1" to 3" diameter in various grits mounted on a 1/4" diameter hardened steel shank



Mini Flap Wheels with 1/4"-20 Thread

- Mini flap wheels ranging from 1" to 3" diameter, mounted on a 14-20 thread that allows you to quickly spin the wheels on and off with no tools
- Designed for polishing and finishing intricate surfaces; cost-effective replacement for brushes, rubber points, and felt bobs



TIER:	BETTER	GOOD	GOOD
TRADENAME:	PINK R928	R369	R207
ABRASIVE:	Ceramic Alumina	Premium Aluminum Oxide	Aluminum Oxide
BACKING:	X-Weight Poly/Cotton	Y-Weight Cotton	X-Weight Cotton

SIZE (D x W x THD.)	GRIT	MAX. RPM	STD. PKG.	PART #	PART #	PART #
1 x 5/8 x 1/4-20	60	30,000	10		088341 31001	636425 02624
	80	30,000	10		088341 31002	636425 02625
	120	30,000	10		088341 31003	636425 02626
1 x 1 x 1/4-20	40	30,000	10	699573 39718	088341 31027	
	60	30,000	10	699573 39719	088341 31008	636425 02628
	80	30,000	10	699573 39720	088341 31009	636425 02629
	120	30,000	10	699573 39721	088341 31010	636425 02630
	180	30,000	10		088341 31011	
	240	30,000	10		088341 31012	
1-3/8 x 5/8 x 1/4-20	60	30,000	10		088341 32001	636425 02632
	80	30,000	10		088341 32002	636425 02633
	120	30,000	10		088341 32003	636425 02634
1-5/8 x 1 x 1/4-20	40	25,000	10		088341 32051	
	60	25,000	10		088341 32015	636425 02638
	80	25,000	10		088341 32016	636425 02639
	120	25,000	10		088341 32017	636425 02640
	180	25,000	10		088341 32018	
2 x 1/2 x 1/4-20	80	25,000	10			636425 02643
	120	25,000	10			636425 02644
2 x 3/4 x 1/4-20	60	25,000	10		088341 33008	
	80	25,000	10		088341 33009	
	120	25,000	10		088341 33010	
	180	25,000	10		088341 33011	
2 x 1 x 1/4-20	40	25,000	10	699573 39722	088341 33044	
	60	25,000	10	699573 39723	088341 33015	636425 02646
	80	25,000	10	699573 39735	088341 33016	636425 02647
	120	25,000	10	699573 39736	088341 33017	636425 02648
	180	25,000	10		088341 33018	
	240	25,000	10		088341 33019	
2 x 1-1/2 x 1/4-20	60	25,000	10		088341 35201	
	80	25,000	10		088341 35202	
	120	25,000	10		088341 35203	
2-1/2 x 1 x 1/4-20	40	20,000	10		088341 34061	
	60	20,000	10		088341 34022	636425 02654
	80	20,000	10		088341 34023	
	120	20,000	10		088341 34024	
3 x 1/2 x 1/4-20	80	20,000	10			636425 02659
	120	20,000	10			636425 02660
3 x 3/4 x 1/4-20	80	20,000	10		088341 35009	
	120	20,000	10		088341 35010	
3 x 1 x 1/4-20	40	20,000	10	699573 39737	088341 35230	
	60	20,000	10	699573 39738	088341 35015	636425 02664
	80	20,000	10	699573 39739	088341 35016	636425 02665
	120	20,000	10	699573 39740	088341 35017	636425 02666
	180	20,000	10		088341 35018	
	240	20,000	10		088341 35019	

Some part numbers are non-stock; contact your Norton representative for status, order quantities and lead-times.
For adapters for flap wheels with 1/4"-20 thread, see the end of this section



Cup-Type Mini Flap Wheels with 1/4" Mounted Steel Shanks

- Primarily used for bottom or side-wall type sanding where conventional tools do not reach
- Cup-type mini flap wheels will not mar your workpiece while reaching flush into areas where other wheels cannot reach

TIER: **GOOD**
 TRADENAME: **R369**
 ABRASIVE: Premium Aluminum Oxide
 BACKING: Y-Weight Cotton

D x W x SK.	MAX. RPM	GRIT	STD. PKG.	PART #
2-1/2 x 1-1/2 x 1/4	20,000	60	10	088341 44463

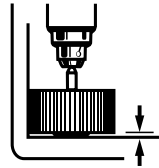

TYPICAL
WHEELS

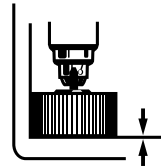

CUP WHEELS GET FLUSH INTO CORNERS
AND THE BOTTOMS OF CYLINDERS

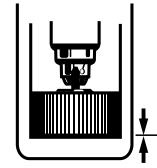

Flap Wheel Test Kits

Mini 1/4"-20 Thread Test Kit "CQ"

- Part # 088341**38001**
- Includes ten, 1" to 3" diameter, 1/4"-20 thread mini flap wheels
- Each kit includes a 1/4"-20 QC-4 quick-change adapter

Mini 1/4" Steel Shank Test Kit "CMM"

- Part # 088341**38004**
- Includes ten wheels, 1" to 3" diameter in various grits
- The flap wheels are mounted on a 1/4" diameter hardened steel shank

Micro Mini 1/8" Steel Shank Test Kit "MMC"

- Part # 088341**31493**
- Includes 5 wheels, 3/8" to 1-3/16" in diameter
- The flap wheels are mounted on a 1/8" diameter hardened steel shank
- Ideal for fast polishing and light deburring of holes or grooves



3" – 8" Flap Wheels with Arbor Holes

- Flap wheels ranging from 3" to 8" diameter with arbor holes
- Heavy cotton backing and premium abrasive grains combine to provide superior life with aggressive cut on a wide range of polishing and finishing applications



TIER:	GOOD	GOOD
TRADENAME:	R369	R207
ABRASIVE:	Premium Aluminum Oxide	Aluminum Oxide
BACKING:	Y-Weight Cotton	X-Weight Cotton

SIZE (D x W x H)	GRIT	MAX. RPM	STD. PKG.	PART #	PART #
3 x 2 x 3/8	60	12,000	10	088341 35050	
	80	12,000	10	088341 35051	
	120	12,000	10	088341 35052	
3-1/2 x 1 x 5/8	40	12,000	10	088341 22001	
	50	12,000	10	088341 22002	
	60	12,000	10	088341 22003	
	80	12,000	10	088341 22004	
	120	12,000	10	088341 22006	
	180	12,000	10	088341 22007	
	240	12,000	10	088341 22008	
3-1/2 x 1-1/2 x 5/8	320	12,000	10	088341 22009	
	40	12,000	10	088341 22011	
	50	12,000	10	088341 22012	
	60	12,000	10	088341 22013	
	80	12,000	10	088341 22014	
	120	12,000	10	088341 22016	
	180	12,000	10	088341 22018	
3-1/2 x 2 x 5/8	320	12,000	10	088341 22020	
	40	12,000	10	088341 22022	
	60	12,000	10	088341 22024	
	80	12,000	10	088341 22025	
	120	12,000	10	088341 22027	
4 x 1 x 5/8	180	12,000	10	088341 22028	
	40	12,000	10	088341 22032	
	50	12,000	10	088341 22033	
	60	12,000	10	088341 22034	636425 02673
	80	12,000	10	088341 22035	636425 02674
4 x 1-1/2 x 5/8	120	12,000	10	088341 22037	636425 02675
	180	12,000	10	088341 22038	
	240	12,000	10	088341 22039	
	320	12,000	10	088341 22040	
	40	12,000	10	088341 22042	
	60	12,000	10	088341 22044	
	80	12,000	10	088341 22045	
4 x 2 x 5/8	120	12,000	10	088341 22047	
	240	12,000	10	088341 22050	
	40	12,000	10	088341 22053	
	60	12,000	10	088341 22055	
	80	12,000	10	088341 22056	
4 x 2 x 5/8	120	12,000	10	088341 22058	
	180	12,000	10	088341 22059	
	240	12,000	10	088341 22060	
	320	12,000	10	088341 22061	

Some part numbers are non-stock; contact your Norton representative for status, order quantities and lead-times.
For flap wheel with arbor hole adapters and bushings, see the end of this section. A set of reducing bushing will be included for 1" center hole wheels at no charge when purchased with flap wheels and specified on the order.
Continued

3" – 8" Flap Wheels with Arbor Holes *continued*



TIER:	BEST	GOOD	GOOD	GOOD
TRADENAME:	BLAZE R920	R369	R207	R265
ABRASIVE:	Ceramic Alumina	Premium Aluminum Oxide	Aluminum Oxide	Aluminum Oxide
BACKING:	X-Weight Cotton	Y-Weight Cotton	X-Weight Cotton	

SIZE (D x W x H)	GRIT	MAX. RPM	STD. PKG.	PART #	PART #	PART #	PART #	
5 x 1-1/2 x 5/8	40	12,000	10		088341 22063			
	50	12,000	10		088341 22064			
	60	12,000	10		088341 22065			
	80	12,000	10		088341 22066			
	120	12,000	10		088341 22068			
	180	12,000	10		088341 22070			
	240	12,000	10		088341 22071			
6 x 1/2 x 1	320	12,000	10		088341 22072			
	40	6,000	10		088341 23001			
	60	6,000	10		088341 23003			
	120	6,000	10		088341 23005			
	150	6,000	10		088341 22198			
6 x 1 x 1	180	6,000	10		088341 23006			
	40	6,000	5		088341 23009		088341 20167	
	50	6,000	5		088341 23010		088341 20168	
	60	6,000	5	662611 46104	088341 23011	636425 02680	088341 20169	
	80	6,000	5	662611 46105	088341 23012	636425 02681	088341 20170	
	100	6,000	5				088341 20171	
	120	6,000	5	662611 46106	088341 23014	636425 02682	088341 20172	
	150	6,000	5		088341 23015			
	180	6,000	5		088341 23016		088341 20174	
	240	6,000	5		088341 23017		088341 20176	
	320	6,000	5		088341 23018		088341 20177	
	6 x 1-1/2 x 1	40	6,000	5		088341 23020		
		50	6,000	5		088341 23021		
		60	6,000	5		088341 23022	636425 02686	
80		6,000	5		088341 23023	636425 02687		
120		6,000	5		088341 23025			
180		6,000	5		088341 23027			
240		6,000	5		088341 23028			
320		6,000	5		088341 23029			
6 x 2 x 1		40	6,000	5		088341 23031		088341 20189
	50	6,000	5		088341 23032			
	60	6,000	5		088341 23033	636425 02691	088341 20191	
	80	6,000	5		088341 23034	636425 02692	088341 20192	
	100	6,000	5				088341 20198	
	120	6,000	5		088341 23036	636425 02694		
	180	6,000	5		088341 23038		088341 20197	
	240	6,000	5		088341 23039		088341 20199	
	320	6,000	5		088341 23040			
6 x 3 x 1	50	6,000	3		088341 23054			
	60	6,000	3		088341 23055			
	80	6,000	3		088341 23056			
	120	6,000	3		088341 23058			
	180	6,000	3		088341 23060			
	240	6,000	3		088341 23061			
8 x 1 x 1	40	4,500	3		088341 23070			
	50	4,500	3		088341 23071			
	60	4,500	3		088341 23072			
	80	4,500	3		088341 23073			
	120	4,500	3		088341 23075			
	180	4,500	3		088341 23077			
8 x 2 x 1	40	4,500	3		088341 23092			
	50	4,500	3		088341 23093			
	60	4,500	3		088341 23094	636425 02700		
	80	4,500	3		088341 23095	636425 02701		
	120	4,500	3		088341 23097			
	180	4,500	3		088341 23099			
	240	4,500	3		088341 23100			
320	4,500	3		088341 23101				

Some part numbers are non-stock; contact your Norton representative for status, order quantities and lead-times.
For flap wheel with arbor hole adapters and bushings, see the end of this section.
A set of reducing bushing will be included for 1" center hole wheels at no charge when purchased with flap wheels and specified on the order.



10" – 16" Large Flap Wheels with Arbor Holes

Wide range of applications:

- For polishing/grinding jobs in production work as well as clean-up and maintenance jobs
- Work on metals, plastic, rubber and wood

Easy to operate:

- No adjustments, dressing, or preparation required before or during operation

Fewer rejected parts:

- More forgiving than other abrasive products
- Reduce the possibility of flattening, gouging and surface deformation

TIER: **GOOD**
TRADENAME: **R369**
ABRASIVE: Premium Aluminum Oxide
BACKING: Y-Weight Cotton

SIZE (D x W x H)	GRIT	MAX. RPM	STD. PKG.	PART #
10 x 1 x 1-3/4	40	4,000	4	088341 2223
	80	4,000	4	088341 24003
	120	4,000	4	088341 24005
	180	4,000	4	088341 24007
	240	4,000	4	088341 22889
10 x 1-1/2 x 1-3/4	320	4,000	4	088341 24009
	60	4,000	4	088341 24022
	80	4,000	4	088341 24023
10 x 2 x 1-3/4	180	4,000	4	088341 24027
	60	4,000	2	088341 24042
	80	4,000	2	088341 24043
10 x 3 x 1-3/4	120	4,000	2	088341 24045
	180	4,000	2	088341 24047
	60	4,000	2	088341 24077
12 x 1 x 1-3/4	80	4,000	2	088341 22316
	120	4,000	2	088341 22311
	180	4,000	2	088341 22132
12 x 1 x 1-3/4	60	3,000	4	088341 24085
	80	3,000	4	088341 22349
	120	3,000	4	088341 22311
	180	3,000	4	088341 22315
12 x 2 x 1-3/4	40	3,000	2	088341 22248
	50	3,000	2	088341 22249
	60	3,000	2	088341 22250
	120	3,000	2	088341 22269
	150	3,000	2	088341 22270
	180	3,000	2	088341 22271
	240	3,000	2	088341 22273
320	3,000	2	088341 22275	
12 x 4 x 1-3/4	180	2,400	1	088341 20017

TIER: **GOOD**
TRADENAME: **R369**
ABRASIVE: Premium Aluminum Oxide
BACKING: Y-Weight Cotton

SIZE (D x W x H)	GRIT	MAX. RPM	STD. PKG.	PART #
14 x 1 x 1-3/4	60	2,400	1	088341 20020
	120	2,400	1	088341 20022
14 x 2 x 1-3/4	60	2,400	1	088341 20028
	80	2,400	1	088341 23215
	120	2,400	1	088341 22907
14 x 3 x 1-3/4	240	2,400	1	088341 20032
	120	2,400	1	088341 20035
	240	2,000	1	088341 20041
16 x 1 x 1-3/4	80	2,400	1	088341 20043
	120	2,400	1	088341 20044
	240	2,400	1	088341 20046
16 x 2 x 1-3/4	60	2,400	1	088341 20047
	120	2,400	1	088341 20050
	180	2,400	1	088341 20051
16 x 3 x 1-3/4	240	2,400	1	088341 20052
	120	2,400	1	088341 20055

Some part numbers are non-stock; contact your Norton representative for status, order quantities and lead-times.

For flap wheel with arbor hole adapters and bushings, see the end of this section.

Adapter and Bushings for Flap Wheels with Arbor Holes

WHEEL DIAMETER	ADAPTERS	PART #
Shank Adapters		
3-1/2	1/4 Shank	088341 25001
3-1/2	3/8 Shank	088341 25007 NS
4-8	1/4 Shank	088341 25003
Threaded Mounting Adapters		
4-8	5/8-11 Thread	088341 25027
Reducing Bushings		
6-8	1 to 3/8	088341 25016 NS
	1 to 1/2	088341 25017
	1 to 5/8	088341 25018 NS
	1 to 3/4	088341 25019 NS
	1 to 7/8	088341 25020 NS
10-16	1 to 5/8	088341 22069 NS

Standard packages = 1 adapter, 1 pair of bushings
 NS Non-stock. Contact your Norton representative for current order quantities and lead-times.
 For additional aluminum reducing bushings see non-woven convolute wheel section



Adapters for 1/4"-20 Thread Mini and Arbor Hole Flap Wheels

MODEL #	DESCRIPTION	PART #
Adapters		
ADAPT C	Fits 3 x 2 x 3/8 arbor flap wheel	088341 37009 NS
MA-100	Fits A.H. Mini Wheel	088341 37007 NS
QC-8	1/8 x 5/8	088341 37002 NS
QC-4	1/4 SK. Dia. x 5/8 SK. L.	088341 37001
QC-44	1/4 x 4	088341 37003
QC-46	1/4 x 6	088341 37004
QC-48	1/4 x 8	088341 37005
QC-T	1/4-20 Thread	088341 37012
QC-T	3/8-24 Thread	088341 37010

Standard package = 1 adapter
 Other thread sizes available for quotation
 NS Non-stock. Contact your Norton representative for current order quantities and lead-times.

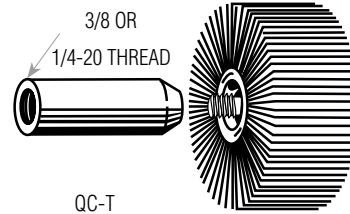
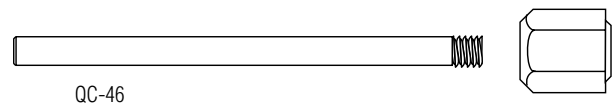
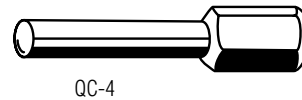



Sand-O-Flex Wheels

With their firm cushioning brushes, Sand-O-Flex's abrasive strips are forced into, around and over corners, hollow and fluted surfaces, and small openings. Pressure is distributed evenly over the surface to prevent loss of detail and the flattening of rounded areas; for sanding metals, woods, plastics, rubber and ceramic.

Sand-O-Flex wheels eliminate the need to hand-sand and are designed to fit most standard equipment. They load quickly and easily by turning the index knob as needed, allowing you to change grit size in minutes. Sand-O-Flex refills are available both scored (for finer, less aggressive work) and unscored. And, with the use of adapters, Sand-O-Flex wheels will fit most electric bench grinders.

Sand-O-Flex Wheel – Model 350-RP

- Diameter: 6-1/2" overall, 4" diameter high-impact plastic body
- 1" wide abrasive strips backed by 8 cushioning brushes
- 1/4" diameter steel shank
- Weight: 9-1/2 oz.
- Maximum operating speed: 2,400 RPM
- Special adapter required for bench grinder use
- Some assembly required

TIER: **GOOD**
TRADENAME: **SAND-O-FLEX**
ABRASIVE: Aluminum Oxide

MODEL #	GRIT	STD. PKG.	PART #
Sand-O-Flex Wheel			
350-RP		1	088341 11051
<i>Comes assembled with 80 grit A/O resin bond scored refill and brushes</i>			
Sand-O-Flex Accessories			
Replacement Brushes for 350-RP; 8 per set		1 set	088341 13003
Resin Bond Refills			
350-RP SCORED	60	10	088341 11052
	80	10	088341 11053
	100	10	088341 12114
	120	10	088341 11054
	180	10	088341 11057
Glue Bond Refills			
350-RP SCORED	80	10	088341 12054
	100	10	088341 12055
	120	10	088341 12056
350-RP UNSCORED	80	10	088341 12044





Non-woven surface finishing flap wheels are an ideal choice for a wide variety of blending and finishing applications common in the metal fabrication, welding and polishing industries. Flap wheels are conformable to intricate shapes and contours. Designed to deliver a consistent finish with a uniform rate of cut, flap wheels wear away continually exposing fresh abrasives.

There are two types of non woven flap wheels: non-woven only abrasive flaps where finishing is the primary application, and interleaf with alternating cloth and non-woven abrasive flaps (less conformable, more aggressive) for stock removal and finishing. Interleaf flap wheels must always be run in the direction indicated by the arrow.

Applications: Used for a wide range of metal fabrication and welding applications including blending, deburring, cleaning, finishing, and polishing

Size Range: Flap wheels with mounted steel shanks: 2" – 4" diameter
Flap wheels with arbor holes: 3" – 12" diameter

Grit Range: 60 – 320

Abrasive Grain: Aluminum Oxide

Machine Used:



DIE GRINDER



BENCH GRINDER



PEDESTAL GRINDER



PORTABLE GRINDER

Application/Grit Recommendation Guide

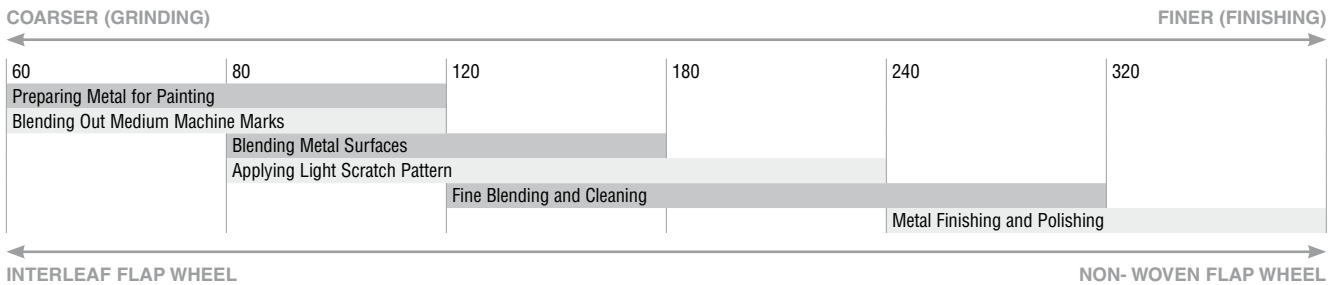

Good choice for fine grit cleaning and blending and finishing applications



INTERLEAF

- Alternating cloth and non-woven flaps make interleaf wheels less conforming and more aggressive than non-woven flap wheels, but less aggressive than all-cloth flap wheels
- Premium aluminum oxide grain with durable resin bond and web that wears away continually exposing fresh abrasives
- Tough yet conformable to intricate shapes and contours without changing the workpiece dimension

Good choice for fine grit light cleaning and finishing



NON-WOVEN

- Premium aluminum oxide grain with durable resin bond and web that wears away continually exposing fresh abrasives
- Tough yet conformable to intricate shapes and contours without changing the workpiece dimension
- Designed with a steel shank as an integral part of the wheel or with an arbor hole

1/4" Mounted Steel Shanks

Wheels are designed with a 1/4" steel shank as an integral part of each wheel. These shanks run through the wheel creating better balance, a reduction of chatter, and reduced operator fatigue. They also permit quick changes on air tools when using other abrasive products.

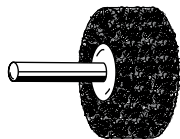

SIZE (D x W x SK.)	ABRASIVE	COATED GRIT	NON-WOVEN GRIT	MAX. RPM	STD. PKG.	TIER: GOOD GOOD	
						TRADENAME: INTERLEAF	NON-WOVEN
						PART #	PART #
2 x 1 x 1/4	A/O	60	Very Fine	12,000	10	088341 38122	
	A/O	80	Very Fine	12,000	10	088341 38123	
	A/O		Medium	12,000	20		662611 89992*
	A/O	120	Very Fine	12,000	10	088341 44457	
	A/O	180	Very Fine	12,000	10	088341 44458	
2 x 1-1/2 x 1/4	A/O	320	Very Fine	12,000	10	088341 44459	699573 99202
	A/O	80	Very Fine	12,000	10	088341 38125	
	A/O	120	Very Fine	12,000	10	088341 38126	
3 x 1 x 1/4	A/O	320	Very Fine	12,000	10	088341 38128	
	A/O	60	Very Fine	12,000	10	088341 38129	
	A/O	80	Very Fine	12,000	10	088341 38130	
	A/O		Medium	12,000	10		088341 31921
	A/O	120	Very Fine	12,000	10	088341 38118	
3 x 2 x 1/4	A/O	180	Fine	12,000	10	088341 38120	
	A/O	320	Very Fine	12,000	10	088341 38119	
	A/O	120	Very Fine	8,000	10	088341 44460	
4 x 2 x 1/4	A/O	180	Very Fine	8,000	10	088341 44461	
	A/O	80	Very Fine	12,000	10	088341 21115	
	A/O	120	Very Fine	12,000	10	088341 20458	

*Standard package quantity = 20

Arbor Hole Mounts

For use on larger portable and fixed-base tools where the wheel must fit on an existing arbor.



SIZE (D x W x SK.)	ABRASIVE	COATED GRIT	NON-WOVEN GRIT	MAX. RPM	STD. PKG.	TIER: GOOD GOOD	
						TRADENAME: INTERLEAF	NON-WOVEN
						PART #	PART #
3 x 2 x 3/8	A/O	60	Very Fine	12,000	10	088341 39000	
	A/O	120	Very Fine	12,000	10	088341 39001	
	A/O	240	Very Fine	12,000	10	088341 39028	
	A/O	320	Very Fine	12,000	10	088341 39024	
4 x 2 x 5/8	A/O	60	Very Fine	12,000	10	088341 26025	
	A/O	240	Very Fine	12,000	10	088341 26014	
	A/O	320	Very Fine	12,000	10	088341 26027	
6 x 1 x 1	A/O	120	Very Fine	6,000	10	088341 26006	
	A/O	240	Very Fine	6,000	10	088341 26030	
6 x 1 x 2	S/C	-	Very Fine	3,000	4		055395 12658
6 x 2 x 1	A/O	80	Very Fine	6,000	10	088341 26009	
	A/O	180	Very Fine	6,000	10	088341 26018	
6 x 3 x 1	A/O	80	Very Fine	6,000	6	088341 26055	
8 x 2 x 3	A/O	-	Medium	2,500	2		055395 12677
12 x 2 x 5	A/O	-	High Strength	1,900	1		055395 62637

Refer to Non-Woven
Convolute Wheel
section for Flap Wheel
Reducing Bushings.

Non-Woven High Strength Discs

Applications include rust/oxide or coating removal, pipe ID and OD polishing, casting cleaning, highlighting (antiquing), contaminant removal, removal of handling marks, gasket removal, cleaning and blending of surface imperfections, prepping prior to soldering, removal of filling materials, cleaning angles and odd shapes. Will not stretch or shed. Ganging increases versatility. For use on larger portable and fixed-base tools where the wheel must fit on an existing arbor.

Best choice for light deburring and finishing



HIGH STRENGTH DISCS

- Premium aluminum oxide grain; engineered for more demanding applications
- Tough but flexible web resists tearing on burrs and sharp edges; and conforms to intricate shapes and contours without changing the workpiece dimension; can be ganged together and used as a wheel
- Smear-free bond excels at producing light satin finishes

TIER: **BEST**

TRADENAME: **HIGH STRENGTH**

ABRASIVE: Aluminum Oxide

SIZE (D x H)	GRIT	MAX. RPM	STD. PKG.	PART #
6 x 1/4	VF	4,000	70	662610 07628
6 x 1/2	M	4,000	70	662610 05073
	VF	4,000	70	662610 04980
8 x 1/2	M	3,000	50	662610 05491
	VF	3,000	50	662610 04506
12 x 1-1/4	VF	1,900	25	662610 08723



FITS HOLE	FOR DISC WIDTH	FOR DISC DIAMETER	SHANK DIAMETER	OVERALL LENGTH	WASHER DIAMETER	STD. PKG.	PART #
Mandrel Assemblies For Using Discs On Edge							
1/4"	1/2" (Standard)	up to 6"	1/4"	2-1/2"	1-1/2"	1	662610 09502
1/2"	1/2" (Standard)	Up to 8"	1/4"	3-1/8"	2-1/4"	1	662610 59420



Flaps of abrasive cloth are stacked, inserted into a holder, and then attached to a mandrel. The flaps are designed to break down during use and reveal the next layer of abrasive.

To create an interleaf bore polisher, cloth flaps are mixed with non-woven flaps.

Applications:

For deburring, sizing, cleaning and polishing the interior diameters of cylinders, tubes and hydraulic fittings. Flaps adjust automatically to inside diameter, polishing the entire surface area with each pass.

Bore polishers are self-centering, so they apply equal pressure to full wall of inside diameter. Spring action design gives faster inside diameter cleaning, deburring and polishing to cylinders, deep bores and tubes.

Interleafed bore polishers are designed to polish and finish in one easy application. The abrasive flaps cut, while the non-woven flaps apply a fine finish.

Grit Range:

60 - 240

Abrasive Grain:

Aluminum Oxide

Application-to-Product Shape Recommendation Guide

Shape

Solid Flaps
B-3 Series



Application

- For 5/8" to 1" interior diameter bores
- 3 abrasive packs 1-1/2" wide, bonded to hub
- Use with QC-5 mandrel Part # 088341**54182**

Solid Flaps
B-4 Series



- For 1" to 4" interior diameter bores
- 4 abrasive packs 1-1/2" wide, bonded to hub
- Use with BPM-4 mandrel Part # 088341**54183**

Solid Flaps
B-8 Series

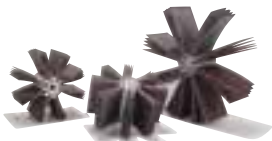

- For 2" to 5-7/8" interior diameter bores
- 8 abrasive packs 1-1/2" wide, bonded to hub
- Use with BPM-8 mandrel Part # 088341**54184**

Scored Flaps

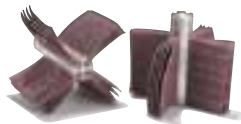

Available upon request as made-to-order products.

Interleaf



Cloth flaps are mixed with non-woven flaps. Interleaf bore polishers do double duty. Designed to polish and finish in one easy application, they are the ideal choice when close tolerances must be maintained, while giving an interior a polished finish.

Application/Grit Recommendation Guide

COARSER (MATERIAL REMOVAL) ←					→ FINER (FINISHING)				
60	80	120	180	240					
Blending Out Medium Machine Marks									
Sizing Cylinders									
Deburring Cylinders									
Blending Metal Surfaces									
Cleaning Cylinders									
Applying Light Scratch Pattern									
					Fine Blending and Cleaning				
					Metal Finishing and Polishing				
← SOLID FLAP					INTERLEAF →				
					SCORED				

Aluminum Oxide Bore Polishers

TIER: **GOOD**
 TRADENAME: **R369**
 ABRASIVE: Aluminum Oxide
 BACKING: Y-weight Cotton/Poly

DESCRIPTION	GRIT	MAX. RPM	STD. PKG.	PART #
Bore Polishers – Solid Flap B-3 and B-4 Series				
B-305	60	25,000	10	088341 54190
Fits ID 5/8 to 1	80	25,000	10	088341 54191
	120	25,000	10	088341 54193
	180	25,000	10	088341 54195
	240	25,000	10	088341 54197
B-405	60	22,000	10	088341 54091
Fits ID 1 to 1-1/2	80	22,000	10	088341 54092
	120	22,000	10	088341 54093
	180	22,000	10	088341 54094
B-410	60	20,000	10	088341 54100
Fits ID 1-1/2 to 2	80	20,000	10	088341 54101
	120	20,000	10	088341 54102
	180	20,000	10	088341 54103
	240	20,000	10	088341 54104
B-415	60	16,000	10	088341 54109
Fits ID 2-1/8 to 2-1/2	80	16,000	10	088341 54110
	120	16,000	10	088341 54111
	180	16,000	10	088341 54112
B-420	60	15,000	10	088341 54118
Fits ID 2-1/2 to 3	80	15,000	10	088341 54119
	120	15,000	10	088341 54120
	180	15,000	10	088341 54121
	240	15,000	10	088341 54122
B-425	60	10,000	10	088341 54127
Fits ID 3-1/8 to 4	80	10,000	10	088341 54128
	120	10,000	10	088341 54129
	180	10,000	10	088341 54130

NS Non-stock. Contact your Norton representative for current order quantities and lead-times.

TIER: **GOOD**
 TRADENAME: **R369**
 ABRASIVE: Aluminum Oxide
 BACKING: Y-weight Cotton/Poly

DESCRIPTION	GRIT	MAX. RPM	STD. PKG.	PART #
Bore Polishers – Solid Flap B-8 Series				
B-810	60	16,000	10	088341 54136
Fits ID 2 to 2-1/2	80	16,000	10	088341 54137
	120	16,000	10	088341 54138
	180	16,000	10	088341 54139 NS
	240	16,000	10	088341 54140 NS
	60	15,000	10	088341 54145
B-815	60	15,000	10	088341 54145
Fits ID 2-5/8 to 3	80	15,000	10	088341 54146
	120	15,000	10	088341 54147
	180	15,000	10	088341 54148 NS
	240	15,000	10	088341 54149 NS
B-820	60	10,000	10	088341 54154
Fits ID 3-1/8 to 4	80	10,000	10	088341 54155
	120	10,000	10	088341 54156
	180	10,000	10	088341 54157
	240	10,000	10	088341 54158 NS
	60	8,000	10	088341 54163
B-825	60	8,000	10	088341 54163
Fits ID 4-1/4 to 5-1/4	80	8,000	10	088341 54164
	120	8,000	10	088341 54165
	180	8,000	10	088341 54166
	240	8,000	10	088341 54167
	60	8,000	10	088341 54172
B-830	60	8,000	10	088341 54172
Fits ID 5-1/4 to 5-7/8	80	8,000	10	088341 54173
	120	8,000	10	088341 54174
	180	8,000	10	088341 54175
	240	8,000	10	088341 54176

Bore Polishers – Scored Flaps

Available on request as made-to-order products

Bore Polishers – Interleaf

DESCRIPTION	GRIT	MAX. RPM	STD. PKG.	PART #
B-405 Interleaf	80	22,000	10	088341 50271
Fits ID 1 to 1-1/2	180	22,000	10	088341 50273

Mandrels for Bore Polishers

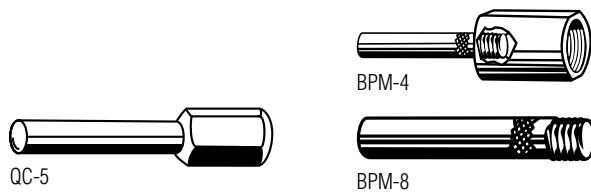

DESCRIPTION	MODEL NO.	THREAD	STD. PKG.	PART #
For B-3 Series	QC-5	5/16-18	1	088341 54182
For B-4 Series	BPM-4	1/2-20	1	088341 54183
For B-8 Series	BPM-8	1/4-20	1	088341 54184

Extension Mandrels for Bore Polishers

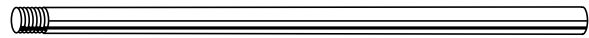

DIAMETER x LENGTH	MODEL NO.	THREAD	STD. PKG.	PART #
1/4 x 4	EM-144	1/4-20	1	088341 54185
1/4 x 6	EM-146	1/4-20	1	088341 54186
1/4 x 8	EM-148	1/4-20	1	088341 54187

To extend a B-4 series bore polisher, attach the adapter piece of the BPM-4 mandrel to the bore polisher, then attach the desired length extension mandrel above to the BPM-4 adapter piece. To extend a B-8 series bore polisher, attach the desired length extension mandrel above directly to the bore polisher.

Bore Polisher Test Kit “BP”

- Part # 088341**54181**
- Contains ten bore polishers and two mini 1/4"-20 thread flap wheels in assorted sizes and grits for finishing 1" to 5" interior diameters, and mandrel for 1/4" chuck.





FlexDrum abrasive segments sweep away flaws. Their extreme longevity and perfect balance make them well-suited for automatic as well as offhand use. Hubs and abrasive segments can be combined to fit your job perfectly.

Applications

Blending out parting lines on castings, smoothing out pre-ground welded areas, removing burrs and work flaws, graining stainless, brush-finishing and satin-finishing aluminum, removing rust, deflashing molded plastic and rubber parts, and preparing surfaces for painting or plating.

Size Range:

Diameter of loaded FlexDrum: 8" – 18"
Width of FlexDrum: 1-1/2" – 12"
Custom die-cut segments as well as extra wide segments, in widths up to 144" are also available as made-to-order products.

Grit Range:

50 – 240

Bond:

Resin or glue

Backing:

Heavyweight cotton

Abrasive Grain:

Premium Aluminum Oxide

Shape/Application Recommendation Guide

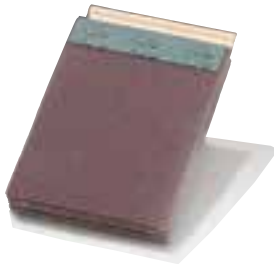

Plain Segment

- For flat or mildly contoured surfaces



1/4 Scored (SC) Segment

- Great for complex parts
- Provides a fine finish



1/2 Slash (SL) Segment

- Great for mild and moderate contours

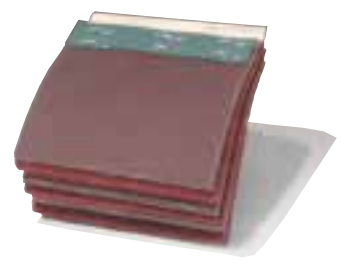

Interleaf Segment

- Plain cloth segments are mixed with non-woven segments. Interleaf FlexDrums do double duty. Designed to polish and finish in one easy application,
- Available upon request as made-to-order product

Loading Flex Drum Hubs



FlexDrum hub end plate removes for easy loading of abrasive segments.



Custom profiled segments eliminate break-in resulting in maximum productivity. Contact your sales representative for more information.

Plain Segments – for flat or mildly curved surfaces

TIER: GOOD									
TRADENAME: R369									
ABRASIVE: A/O									
BACKING: Y-weight Cotton									
GRIT: 50 60 80 100 120 180 240									
WIDTH	TRIM LENGTH*	STD. PKG.	PART #	PART #	PART #	PART #	PART #	PART #	PART #
1-1/2	2-3/4	12	088341 55002	088341 55003	088341 55004		088341 55006	088341 55008	088341 55010
2	2-3/4	12	088341 55013	088341 55014	088341 55015	088341 55016		088341 55019	
2	4	20		088341 55313	088341 55314	088341 55315		088341 55318	
2	5	20		088341 55568	088341 55569				
3	2-3/4	12		088341 55026	088341 55027		088341 55029	088341 55031	
3	4	20			088341 55326			088341 55330	
3	5	20		088341 55579			088341 55582	088341 55584	
4	2-3/4	12	088341 55036				088341 55040		
4	4	20	088341 55336	088341 55337	088341 55338		088341 55340		
4	5	20		088341 55590					

All FlexDrum segments are non-stock; contact your Norton representative for current order quantities and lead-times.

1/4" Scored Segments – for complex parts and providing a fine finish

TIER: GOOD									
TRADENAME: R369									
ABRASIVE: A/O									
BACKING: Y-weight Cotton									
GRIT: 50 60 80 100 120 180									
WIDTH	TRIM LTH.*	SCORE	STD. PKG.	PART #	PART #	PART #	PART #	PART #	PART #
1-1/2	2-3/4	1/4	12		088341 55083	088341 55084	088341 55085	088341 55086	088341 55088
2	2-3/4	1/4	12	088341 55094	088341 55095	088341 55096	088341 55097	088341 55098	088341 55100
3	2-3/4	1/4	12		088341 55107	088341 55108	088341 55109		088341 55112
4	2-3/4	1/4	12	088341 55117	088341 55118	088341 55119		088341 55121	088341 55123

All FlexDrum segments are non-stock; contact your Norton representative for current order quantities and lead-times.

1/2" Slashed Segments – for mild and moderate contours

TIER: GOOD									
TRADENAME: R369									
ABRASIVE: A/O									
BACKING: Y-weight Cotton									
GRIT: 60 80 120 180 240									
WIDTH	TRIM LTH.*	SLASH	STD. PKG.	PART #	PART #	PART #	PART #	PART #	PART #
2	4	1/2	20	088341 55420	088341 55421	088341 55423	088341 55425	088341 55427	
2	5	1/2	20			088341 55639			
3	4	1/2	20		088341 55432				
4	4	1/2	20		088341 55445	088341 55447	088341 55449	088341 55451	
4	5	1/2	20		088341 55659				

All FlexDrum segments are non-stock; contact your Norton representative for current order quantities and lead-times.

*Trim Length is the actual usable length of segment when loaded

TECH TIP

FlexDrums can be used for polishing large IDs. Just load half the segments with a wheel diameter 1/2" to 1" larger than the ID of your workpiece.

Hub Units

- FlexDrum hubs are perfectly balanced, last indefinitely and are available in widths from 1-1/2" to 12"
- Extra wide widths are available up to 144" as made-to-order products

MODEL NO.	D x W	ARBOR HOLE/THREAD	SEGMENTS PER HUB	PART #
FlexDrum Hub Units				
81.5-B	2-3/8 x 1-1/2	1 AH	12	088341 40065
82-B	2-3/8 x 2	1 AH	12	088341 41049
		5/8-11 THD	12	088341 40048
83-B	2-3/8 x 3	1 AH	12	088341 41018
		5/8-11 THD	12	088341 40034
84-B	2-3/8 x 4	1 AH	12	088341 40066
		5/8-11 THD	12	088341 40049
122-B	4 x 2	1-1/4 AH	20	088341 40050
123-B	4 x 3	1-1/4 AH	20	088341 40051
124-B	4 x 4	1-1/4 AH	20	088341 40061
142-B	6 x 2	1-1/4 AH	30	088341 40062
143-B	6 x 3	1-1/4 AH	30	69957 99208
144-B	6 x 4	1-1/4 AH	30	088341 41060
840-B2	8 x 2	1-1/4 AH	40	636425 92550
840-B4	8 x 4	1-1/4 AH	40	636425 92548

All FlexDrum hub units are non-stock; contact your Norton representative for current order quantities and lead-times.



**2-3/8" DIAMETER HUB
WITH 1" ARBOR HOLE**

8" WHEEL WHEN LOADED



**2-3/8" DIAMETER HUB ALSO
AVAILABLE WITH 5/8"-11 ARBOR**

8" WHEEL WHEN LOADED



4" DIAMETER HUB

12" WHEEL WHEN LOADED



6" DIAMETER HUB

14" OR 16" WHEEL WHEN LOADED



8" DIAMETER HUB

16" OR 18" WHEEL WHEN LOADED

FlexDrum Reference Charts

FlexDrums can be mounted on any type of arbor.

Weights

DIAMETER	WEIGHT
Weight of Hubs*	
4" Diameter Hub	1.5 lbs./inch of width
6" Diameter Hub	2 lbs./inch of width
8" Diameter Hub	2.5 lbs./inch of width
Weight of Hubs with Segments*	
4" Diameter Hub	3.4 - 4 lbs./inch of width
6" Diameter Hub	5 - 5.5 lbs./inch of width
8" Diameter Hub	6.75 - 7 lbs./inch of width

*Approximate values. Actual weight will depend on abrasive type and overall width of hub.

FlexDrum Maximum RPM

WHEEL DIAMETER	MAXIMUM RPM
8	4,500
12	3,000
14	2,500
16	2,200
18	2,000

Recommended H.P. Required

HUB	H.P.
4" Diameter Hub	1/2 H.P. /inch of width
6" Diameter Hub	3/4 H.P./inch of width
8" Diameter Hub	1 H.P./inch of width

Recommended Surface Feet per Minute for using FlexDrum Wheels on Various Materials

MATERIAL	SFPM
Mild Steel	5,000
Stainless Steel	6,500
Alloy Steel	5,000
Titanium	3,500
Hard Aluminum	5,500
Nonferrous	5,000
Rubber	4,500
Hardwood (edge breaking)	4,000
Softwood	3,500
Thermoplastic	3,000

SPEC CHECK



FlexDrum Hub Specification Chart

MODEL NO.	82-B	121-B	141-B	840-B
Diameter of Finished Wheel	8	12	14 or 16	16 or 18
Diameter of Hub Alone	2-3/8	4	6	8
Arbor Hole	1 or 5/8-11 thd	3/4 to 1-3/4	1 to 3-1/2	1-1/4 to 5
Segments Per Hub	12	20	30	40

How to Determine Diameter of Finished FlexDrums

HUB DIAMETER	TRIM LENGTH (X2)	FINISHED WHEEL
2-3/8	2-3/4	8
4	4	12
4	5	14
6	4	14
6	5	16
8	4	16
8	5	18

TECH TIP

For surface feet per minute, use the following calculation: SFPM=.262 x DIA (in inches) x RPM.



Made from non-woven synthetic fiber mesh, which is impregnated with abrasives and bound with resins, non-woven wheels are designed to create desired surface finish where little or no stock removal is required. The industry's broadest offering is available for light stock removal, deburring, blending, finishing and polishing. Non-woven wheels have an open mesh construction that is waterproof, washable, conformable and non-loading.

Applications:

Cleaning and removing imperfections on metal surfaces, cleaning built-up residue, deburring or finishing a variety of surfaces, blending weld seams or creating decorative finishes. Non-woven surface finishing products have excellent versatility.

Abrasive Grain:

Ceramic Alumina, Engineered Aluminum Oxide, Aluminum Oxide, Silicon Carbide

Grit Range:

Extra Coarse (XC), Coarse (C), Medium (M), Fine (F)

Machine Used:

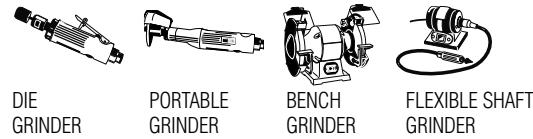

DIE GRINDER

PORTABLE GRINDER

BENCH GRINDER

FLEXIBLE SHAFT GRINDER

Application/Grit Recommendation Guide

	← MOST AGGRESSIVE		LEAST AGGRESSIVE →
NORTON	Rapid Strip Wheels	Rapid Blend Unified Wheels	Non-Woven / Interleaf Flap Wheels
Scale Removal	Best Choice		
Painting/Coating Removal	Best Choice		
Stock Removal		Best Choice	
Heavy Deburring		Best Choice	
Polishing			Second Choice
Buffing			Best Choice

Surface Finish Variables

Changes in any one of many factors can affect the surface finish on the workpiece. This chart shows the effect on surface finish by changes in single factors of product specifications. Arrows have been used to signify the trend direction. The arrow length does not signify that the effect of each factor is equal.

Variable Factor	Rough Finish High RMS Reading	Smooth Surface Lower RMS Reading
1. Wheel Speed	Slow ←	→ Fast
2. Feed Speed	Faster (Long Scratch) ←	→ Slower (Short Scratch)
3. Oscillation	No Oscillation ←	→ Oscillation
4. Lubricants	Dry ←	→ Water ←
		→ Soluble Oil ←
		→ Straight Oil
		← Compounds →

Non-Woven Marking System

ABRASIVE	SILICON CARBIDE	ALUMINUM OXIDE		
	← SHARPER, FINER/BRIGHTER SCRATCH PATTERN	→ MORE DURABLE, LONGER LASTING, POLISHED FINISH		
GRIT SIZE	XC (50)	C (60-80)	M (100-150)	F (180-220)
	← FASTER, AGGRESSIVE CUT, ROUGHER FINISH	→ REDUCED CUT RATE, FINER FINISH		
DENSITY	2	9		
	← SOFT, OPEN, CONFORMABLE, LESS BURNING/LOADING	→ HARDER, MORE DURABLE, FASTER CUTTING, BETTER FINISH		

Cross Reference Guide

	STRIPPING	HEAVY/LIGHT DEBURRING	LIGHT DEBURRING/BLENDING/POLISHING	CLEANING/FINISHING	
	BEST	BETTER	BEST	BETTER	GOOD
NORTON	Blaze Rapid Strip	Rapid Strip	Vortex Rapid Blend	Rapid Blend NEX	Non-Woven / Interleaf Flap Wheels
3M	Clean and Strip XT PRO, Clean and Strip XT PRO Extra Cut	Clean Strip	Cut & Polish Unitized, Deburr and Finish PRO	EXL Unitized	Finishing Flap Brush
Standard		Britestrip	800 & 900 Series	500 - 700 Series	Buff & Blend Flap Brush

Rapid Strip Unified Wheels

Best choice for removing rust, scale and paint/coatings on a variety of substrates, such as wood, metal and plastics



BLAZE RAPID STRIP CERAMIC ALUMINA

- Norton Blaze ceramic alumina grain provides 2X cut rate, 2X life over silicon carbide products
- Advanced resin bond does not shed on rust-encrusted pieces, and prevents gouging and rework; does not snag when used for deburring
- Leave a thoroughly cleaned surface that ensures excellent adhesion for subsequent processes such as coating, painting and soldering

Better choice for removing coatings on a variety of substrates such as wood metal and plastics

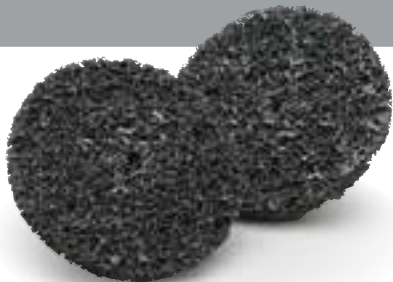

RAPID STRIP SILICON CARBIDE

- Faster cutting, sharp, extra coarse silicon carbide abrasive provides a unique combination of aggressive performance, long life, and improved finish
- Advanced resin bond prevents shedding on rust-encrusted pieces and gouging and rework; does not snag when used for deburring
- Leaves a thoroughly clean surface that ensures excellent adhesion in subsequent processes such as coating, painting and soldering



TIER:	BEST	BETTER
TRADENAME:	BLAZE RAPID STRIP	RAPID STRIP
ABRASIVE:	Ceramic Alumina	Silicon Carbide
GRIT:	Extra Coarse	Extra Coarse

SIZE (D x H)	MAX. RPM	STD. PKG.	PART #
Arbor Hole			
4 x 1/4	8,000	25	662610 09324
4 x 1/2	8,000	25	666233 04856
6 x 1/4	4,000	15	666233 40171
6 x 1/2	4,000	15	662610 99378



FITS HOLE	FOR DISC WIDTH	FOR DISC DIAMETER	SHANK DIAMETER	OVERALL LENGTH	WASHER DIAMETER	STD. PKG.	PART #
Mandrel Assemblies For Non-Woven Unified Wheels							
1/4"	1/2" (Standard)	up to 6"	1/4"	2-1/2"	1-1/2"	1	662610 09502
1/2"	1/2" (Standard)	Up to 8"	1/4"	3-1/8"	2-1/4"	1	662610 59420

Rapid Blend Unified Wheels *continued*

Designed for maintenance operations needing an efficient and cost-effective method of deburring, polishing, cleaning or finishing metals and composites. Easily preformed for use on a wide variety of shapes/contours. Hold shape well; less wheel dressing. Non-metallic so no contamination of workpiece. Uniform construction maintains part tolerance; prevents cutting or gouging.



Best choice for light weld bead and weld spatter removal, heavy deburring and finishing applications

VORTEX RAPID BLEND ALUMINUM OXIDE

- High-performance, medium grit, engineered aluminum oxide grain and improved resin bond system provide aggressive, fast, stock removal, reduced cycle times, and excellent part quality
- Thick nylon web delivers 2X longer life and faster finishing – with minimal shedding vs competitive wheels
- Controlled porosity ensures cool cutting and improved cut rate

TIER: **BEST**
TRADENAME: **VORTEX RAPID BLEND**
ABRASIVE: Aluminum Oxide

SIZE (D x T x H)	GRIT SIZE	STD. PKG.	MAX. RPM	3 DENSITY PART #	MAX. RPM	5 DENSITY PART #	MAX. RPM	7 DENSITY PART #	MAX. RPM	9 DENSITY PART #
2 x 1/8 x 1/8	M	60			22,000	662544 25657	20,000	662544 10849		
2 x 1/8 x 1/4	M	60					22,000	66261 191446		
2 x 1/4 x 1/4	M	60	18,000	662544 28456	22,000	662544 33504	22,000	66261 080270		
2 x 1 x 1/4	M	15					22,000	66261 080269		
3 x 1/8 x 1/4	M	40			18,000	66261 093448	18,000	66261 191445		
3 x 1/8 x 3/8	M	40			18,000	662544 33503	18,000	662544 01131		
3 x 1/4 x 1/4	M	40	12,000	662544 28454	18,000	662544 14832	18,000	66261 199696		
3 x 1/4 x 3/8	M	40	12,000	662544 33505	12,000	662544 33506				
3 x 1/2 x 1/4	M	20			18,000	662544 32925	18,000	66261 080267	18,000	662544 33507
3 x 1/2 x 3/8	M	20			18,000	662544 33508	18,000	66261 080266	18,000	662544 20696



Better choice for light deburring and blending

RAPID BLEND NEX ALUMINUM OXIDE AND SILICON CARBIDE

- Uniform construction provides extra long life and holds shape well for less wheel dressing
- Smear free resin binder formula provides smear-free finishes
- A great option for light deburring and blending applications

TIER: **BETTER**
TRADENAME: **RAPID BLEND NEX**

SIZE (D x T x H)	ABRASIVE	GRIT	MAX. RPM	STD. PKG.	2 DENSITY PART #	3 DENSITY PART #	4 DENSITY PART #	6 DENSITY PART #	8 DENSITY PART #
1 x 1 x 3/16	A/O	C	30,000	50					66261 014915
	A/O	M	18,000	50	66261 014891				
	A/O	M	30,000	50				66261 014908	66261 014924
	S/C	F	18,000	50	66261 014883				
	S/C	F	30,000	50				66261 014904	66261 014923
2 x 1/8 x 1/4	A/O	M	22,000	60					66261 014927
2 x 1/4 x 1/4	A/O	M	18,000	60	66261 014892				
	A/O	M	22,000	60					66261 014926
	A/O	F	22,000	60				66261 014901	
	S/C	F	18,000	60	66261 014884				
2 x 1/2 x 1/4	A/O	M	22,000	30					66261 014925
3 x 1/4 x 1/4	A/O	C	18,000	40					66261 014919
	A/O	M	18,000	40				66261 014909	66261 014930
	S/C	F	12,000	40	66261 014886				
3 x 1/4 x 3/8	A/O	C	18,000	40					66261 014920
	A/O	M	12,000	40	66261 014895				
	A/O	M	18,000	40				66261 014910	66261 014933
	A/O	F	12,000	40			66261 014899		
	S/C	F	12,000	40	66261 014887	66261 016006			
3 x 1/2 x 1/4	A/O	M	12,000	20	66261 014893				
	A/O	M	18,000	20				66261 014928	
	S/C	F	12,000	20	66261 014885				
3 x 1/2 x 3/8	A/O	M	18,000	20					66261 014929
3 x 1 x 3/8	S/C	XC	18,000	10				66261 014914	
6 x 1/2 x 1	A/O	M	7,500	4					66261 014931
6 x 1 x 1	S/C	F	5,000	2	66261 014888				

Assemblies and Mandrels for Unified Wheels

FITS WHEEL CENTER HOLE	FOR WHEEL WIDTH	FOR WHEEL DIAMETER	SHANK DIAMETER	OVERALL LENGTH	WASHER DIAMETER	3M EQUIVALENT	STD. PKG.	PART #
Mandrel Assemblies for Unified Wheels and Discs On Edge								
3/16	1/8 – 1/2	1 – 2	1/4	2	7/16	994	1	662610 09852
1/4 – 5/16	Up to 1/2	Up to 2	1/4	2	5/8	932	1	662610 15146
1/4 – 5/16	Up to 1	Up to 2	1/4	2-1/2	5/8	932	1	662610 59422
	Up to 1	2 – 3	1/4	2-1/2	1	933	1	662610 59421
3/8	Up to 1/2	2 – 4	1/4	2-1/2	1	990	1	662610 09851
1/2	Up to 1	3 – 6	1/4	3-1/8	1-5/8	934	1	662610 09850
FOR CENTER HOLE	USE WITH UNIFIED WHEEL	SHANK DIAMETER	SHANK LENGTH			3M EQUIVALENT	STD. PKG.	PART #
Threaded Mandrel for Unified Wheels								
3/16	1 x 1 x 3/16	1/4"	1-3/4"			948	5	662610 47584



MANDREL ASSEMBLY 662610**59421**



THREADED MANDREL 662610**47584**



MANDREL ASSEMBLY 662610**59422**





NEW

Used in a multitude of operations in almost every industry and on a variety of machines, mounted points are small grinding wheels permanently fastened to its own spindle. These vitrified bond mounted points are available in a wide range of shapes.

- Industries:**
- Aerospace
 - Tool and Die
 - Construction
 - Metal Fabrication
 - Automotive
- Cutlery
 - Mold Shops
 - Stainless Steel Equipment
 - Foundries

- Abrasive Grain:** Aluminum Oxide
Shape Availability: A, B, and W

Machine Used:



DIE AND
PENCIL
GRINDER



HORIZONTAL/
STRAIGHT SHAFT
PORTABLE GRINDER

Measurement Guide

Description of Overhang

Overhang is the distance between the grinder chuck and the abrasive on the spindle. The larger the overhang, the lower the maximum safe operating speed.

Size

Measured by diameter (D) x thickness (T)

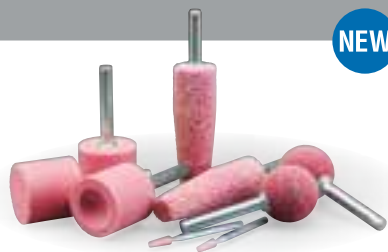
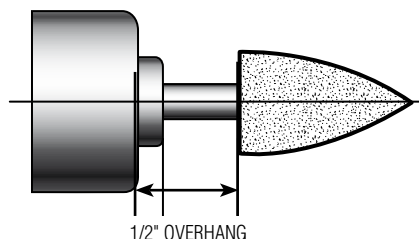
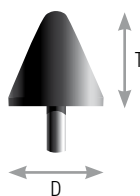

NEW

Better medium grit option for blending and deburring

PINK ALUMINUM OXIDE – VITRIFIED BOND

- Sharp versatile 86A aluminum oxide grain is free cutting and resists burn
- Excellent form holding compared to more friable white aluminum oxides
- Medium grit for blending and deburring

TIER: **BETTER**
TRADENAME: **PINK**
ABRASIVE: 86A Aluminum Oxide

SHAPE	SIZE (D x T)	SPINDLE DIA. †	MAX. RPM*	MIN./STD. PKG.	SPEC	PART #
Vitrified Bond Mounted Points – A Shapes						
A1	3/4 x 2-1/2	1/4	19,800	5/25	86A80-S	690786 45335
A3	1 x 2-3/4	1/4	16,100	5/25	86A80-S	690786 45333
A5	3/4 x 1-1/8	1/4	45,000	5/25	86A80-S	690786 45339
A11	7/8 x 2	1/4	19,860	5/25	86A80-S	690786 45336
A12	11/16 x 1-1/4	1/4	48,000	5/25	86A80-S	690786 45344
A25	1" Ball	1/4	35,620	5/25	86A80-S	690786 45341
A38	1 x 1	1/4	34,500	5/25	86A80-S	690786 45345
Vitrified Bond Mounted Points – B Shapes						
B52	3/8 x 3/4	1/8	45,370	5/25	86A80-S	690786 45334
B53	5/16 x 5/8	1/8	60,000	5/25	86A80-S	690786 45340
B81	3/4 x 3/16	1/8	50,930	5/25	86A80-S	690786 45347
B97	1/8 x 3/8	1/8	105,000	5/25	86A80-S	690786 45337
B121	1/2" Ball	1/8	45,370	5/25	86A80-S	690786 45338
B122	3/8" Ball	1/8	61,650	5/25	86A80-S	690786 45360
B135	1/4 x 1/2	1/8	60,000	5/25	86A80-S	690786 45342
Vitrified Bond Mounted Points – W Shapes						
W163	1/4 x 1/2	1/8	60,000	5/25	86A80-S	690786 45346
W177	3/8 x 3/4	1/8	33,750	5/25	86A80-S	690786 45355
W185	1/2 x 1/2	1/4	61,500	5/25	86A80-S	690786 45354
W200	3/4 x 1/8	1/8	50,930	5/25	86A80-S	690786 45356
W220	1 x 1	1/4	25,500	5/25	86A80-S	690786 45359
W235	1-1/2 x 1/4	1/4	25,470	5/25	86A80-S	690786 45343

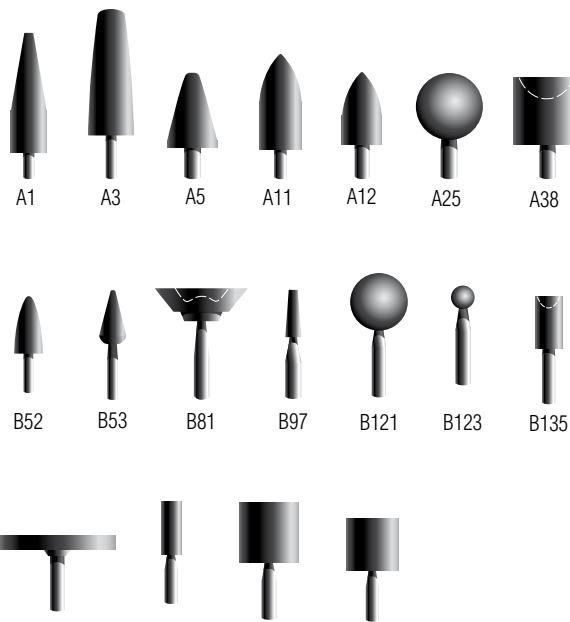

† Standard spindle size is 1/4" x 1-1/2"
* Maximum RPM valid to 1/2" overhang. See package insert for other overhangs.

Refer to the Precision Offhand/Portable section for the full offering of mounted points.



NEW

Our double-cut style carbide burrs have stronger tooth formulation and numerous cutting edges to outperform other double-cut carbide burrs with better stock removal, granular chip break, and longer life.

Pair up these long-lasting burrs with our pneumatic die grinder to quickly and comfortably accomplish many portable applications on one machine – including jobs using specialties, small diameter flap wheels, and mounted points.

Applications: Deburring, medium-to-light surface cleaning and stock removal, weld removal and prep, chamfering

Shapes: A, B, C, D, E, F, G, H, L, M

Shank Diameter: 1/4"

Machine Used:



DIE GRINDER

Understanding the Product

Burr Dimensions

D1	L1	D2	L2
HEAD DIAMETER	HEAD LENGTH	SHANK DIAMETER	OVERALL BURR LENGTH (OL)

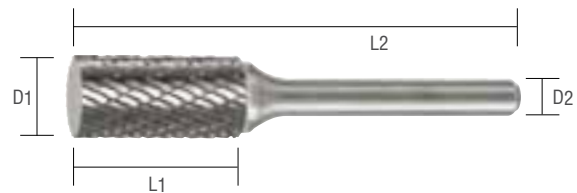

TECH TIP

Each carbide burr is packed individually in a clear, protective plastic case with Norton-blue end-caps. Each burr is marked with the burr head diameter and length for easy identification.

Carbide Burrs Merchandising Display

For those last minute point-of-purchase sales the Carbide Burr merchandiser is an ideal addition to any counter or display shelf. Holds twenty-four burrs in the lockable front display with plenty of storage in the back drawer.



MERCHANDISING DISPLAY

SUB-SHAPE	D	W	H	MIN/STD PKG QTY	PART #
Carbide Burr Merchandising Display	15-1/4"	9-1/4"	16"	1	699573 66825



DISPLAY HEADER CARD



DISPLAY BACKER DECAL

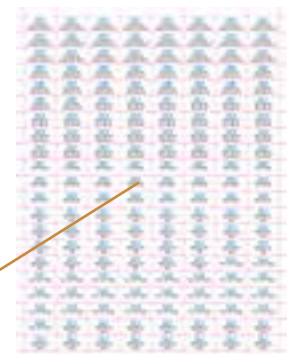

DISPLAY PRODUCT DECALS

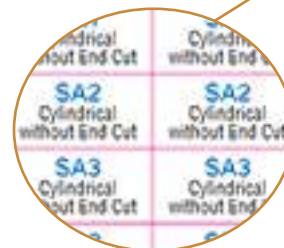



Double cut burrs are a popular choice because of their universal cutting style

DOUBLE CUT CARBIDE BURRS

- Hard tungsten carbide burrs with strong tooth formulations and numerous cutting edges for extended life and less changeover downtime versus other cutting tools
- Higher stock removal, and smaller, granular chip-break on hard-to-grind workpieces versus other carbide burrs
- Perform well at higher temperatures and can be used longer than high-speed steel tools – even if your operation generates some heat

Carbide Burrs for Standard Metal Removal



SA Cylindrical without End Cut

The ends of these burrs are flat, with no cutting edges and are used for contour finishing and to get into right-angled corners.

SUB-SHAPE	MAX. RPM	D1	L1	L2	MIN/STD PKG QTY	PART #
SA1	25,000	1/4"	3/4"	2"	1	699573 08002
SA2	25,000	5/16"	3/4"	2-1/2"	1	699573 08003
SA3	25,000	3/8"	3/4"	2-1/2"	1	699573 08004
SA5	25,000	1/2"	1"	2-3/4"	1	699573 08005
SA5	25,000	1/2"	1"	6"	1	699573 60674



SB Cylindrical with End Cut

The cutting edge at the end of the burr makes these burrs a good choice for contour finishing.

SUB-SHAPE	MAX. RPM	D1	L1	L2	MIN/STD PKG QTY	PART #
SB3	25,000	3/8"	3/4"	2-1/2"	1	699573 08006
SB3	25,000	3/8"	3/4"	6"	1	699573 40156
SB5	25,000	1/2"	1"	2-3/4"	1	699573 08007
SB5	25,000	1/2"	1"	6"	1	699573 40157
SB6	25,000	5/8"	1"	2-3/4"	1	699573 08008



SC Ball-Nosed Cylindrical

Use these round-nosed burrs for smoother operation and better tool control.

SUB-SHAPE	MAX. RPM	D1	L1	L2	MIN/STD PKG QTY	PART #
SC1	25,000	1/4"	3/4"	2"	1	699573 08009
SC2	25,000	5/16"	3/4"	2-1/2"	1	699573 08010
SC3	25,000	3/8"	3/4"	2-1/2"	1	699573 08011
SC3	25,000	3/8"	3/4"	6"	1	699573 60678
SC5	25,000	1/2"	1"	2-3/4"	1	699573 08012
SC5	25,000	1/2"	1"	6"	1	699573 60679
SC5	25,000	1/2"	1"	12"	1	699573 60905
SC6	25,000	5/8"	1"	2-3/4"	1	699573 08013

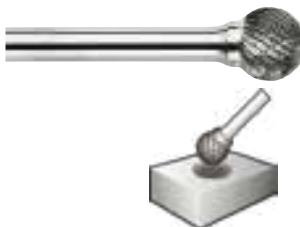

SD Ball Shape

Use these carbide burrs to create a concave and to hollow out a workpiece.

SUB-SHAPE	MAX. RPM	D1	L1	L2	MIN/STD PKG QTY	PART #
SD1	25,000	1/4"	1/4"	2"	1	699573 08014
SD2	25,000	5/16"	1/4"	2"	1	699573 08015
SD3	25,000	3/8"	5/16"	2-1/8"	1	699573 08016
SD5	25,000	1/2"	7/16"	2-3/16"	1	699573 08017
SD5	25,000	1/2"	7/16"	6"	1	699573 60686
SD9	25,000	1"	15/16"	2-15/16"	1	699573 60865

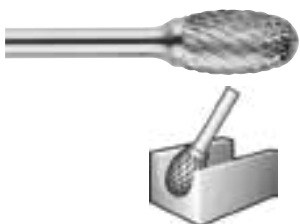

SE Oval Shape

Use the oval-shaped carbide burrs for good reach and round head for shaping.

SUB-SHAPE	MAX. RPM	D1	L1	L2	MIN/STD PKG QTY	PART #
SE3	25,000	3/8"	5/8"	6"	1	699573 40158
SE5	25,000	1/2"	7/8"	6"	1	699573 40159

Carbide Burrs for Standard Metal Removal

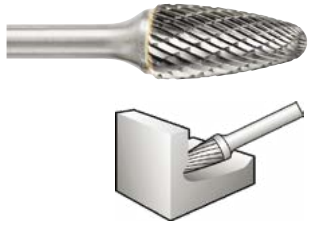

SF Ball-Nosed Tree
Designed to round off edges and make concave cuts.

SUB-SHAPE	MAX.-RPM	D1	L1	L2	MIN/STD PKG QTY	PART #
SF1	25,000	1/4"	3/4"	2"	1	699573 08018
SF2	25,000	5/16"	3/4"	2-1/2"	1	699573 08019
SF3	25,000	3/8"	3/4"	2-1/2"	1	699573 08020
SF3	25,000	3/8"	3/4"	6"	1	699573 60689
SF5	25,000	1/2"	1"	2-3/4"	1	699573 08021
SF5	25,000	1/2"	1"	6"	1	699573 60691
SF5	25,000	1/2"	1"	12"	1	699573 60904
SF6	25,000	5/8"	1"	2-3/4"	1	699573 08022



SG Tree with Taper
The taper allows access to hard-to-reach areas, such as angled contours.

SUB-SHAPE	MAX.-RPM	D1	L1	L2	MIN/STD PKG QTY	PART #
SG1	25,000	1/4"	3/4"	2"	1	699573 08023
SG2	25,000	5/16"	3/4"	2-1/2"	1	699573 08024
SG3	25,000	3/8"	3/4"	2-1/2"	1	699573 08025
SG5	25,000	1/2"	1"	2-3/4"	1	699573 08026
SG5	25,000	1/2"	1"	6"	1	699573 60712
SG6	25,000	5/8"	1"	2-3/4"	1	699573 08027
SG13	25,000	3/4"	1-1/2"	3/4"	1	699573 66821
SG15	25,000	3/4"	1-1/2"	1/4"	1	699573 60886

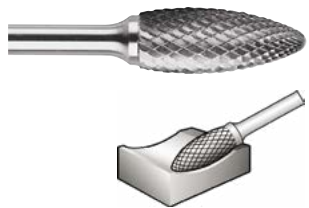

SH Flame Shape
Great for channel working and shaping due to its long fluted sides and rounded head.

SUB-SHAPE	MAX.-RPM	D1	L1	L2	MIN/STD PKG QTY	PART #
SH5	25,000	1/2"	1-1/4"	6"	1	699573 66822



SL Ball-Nosed Cone
This cone shape is excellent for imparting fine finishes.

SUB-SHAPE	MAX.-RPM	D1	L1	L2	MIN/STD PKG QTY	PART #
SL2	25,000	5/16"	7/8"	2-3/4"	1	699573 08028
SL3	25,000	3/8"	1 3/16"	2-15/16"	1	699573 08029
SL3	25,000	3/8"	1-1/16"	6"	1	699573 60716
SL4	25,000	1/2"	1 3/16"	3"	1	699573 08030
SL4	25,000	1/2"	1-3/16"	6"	1	699573 60720
SL5	25,000	1/2"	1"	6"	1	699573 66823



SM Pointed Cone
Ideal for rounded edges or reaching difficult, tight areas.

SUB-SHAPE	MAX.-RPM	D1	L1	L2	MIN/STD PKG QTY	PART #
SM4	25,000	3/8"	5/8"	6"	1	699573 66824
SM5	25,000	1/2"	7/8"	6"	1	699573 60767

Carbide Burr Kit



SUB-SHAPE	MIN/STD PKG QTY	PART #
Carbide Burr Kit*	1	699573 08060

* Kit Includes one each of: SA5 (699573**08005**), SF3 (699573**08020**), SF5 (699573**08021**), SG5 (699573**08026**), and SL4 (699573**08030**)

Carbide Burrs for Aluminum and Non-Ferrous Materials

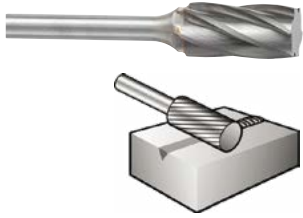

SA Cylindrical without End Cut

The ends of these burrs are flat, with no cutting edges and are used for contour finishing and to get into right-angled corners.

SUB-SHAPE	MAX. RPM	D1	L1	L2	MIN/STD PKG QTY	PART #
SA3 NF	25,000	3/8"	3/4"	2-1/2"	1	699573 40148
SA5 NF	25,000	1/2"	1"	2-3/4"	1	699573 40149

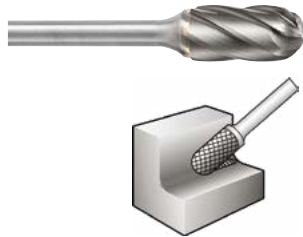

SC Ball-Nosed Cylindrical

Use these round-nosed burrs for smoother operation and better tool control.

SUB-SHAPE	MAX. RPM	D1	L1	L2	MIN/STD PKG QTY	PART #
SC3 NF	25,000	3/8"	3/4"	2-3/4"	1	699573 40150
SC5 NF	25,000	1/2"	1"	6"	1	699573 60657



SD Ball Shape

Use these carbide burrs to create a concave and to hollow out a workpiece.

SUB-SHAPE	MAX. RPM	D1	L1	L2	MIN/STD PKG QTY	PART #
SD3 NF	25,000	3/8"	5/16"	2-1/8"	1	699573 66820
SD5 NF	25,000	1/2"	7/16"	2-3/16"	1	699573 40152

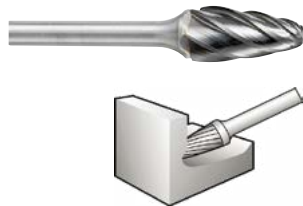

SF Ball-Nosed Tree

Designed to round off edges and make concave cuts.

SUB-SHAPE	MAX. RPM	D1	L1	L2	MIN/STD PKG QTY	PART #
SF1 NF	25,000	1/4"	3/4"	2"	1	699573 40153
SF3 NF	25,000	3/8"	3/4"	2-1/2"	1	699573 40154
SF5 NF	25,000	1/2"	1"	2-3/4"	1	699573 60647



SG Tree with Taper

The taper allows access to hard-to-reach areas, such as angled contours.

SUB-SHAPE	MAX. RPM	D1	L1	L2	MIN/STD PKG QTY	PART #
SG5 NF	25,000	1/2"	1"	2-3/4"	1	699573 60646

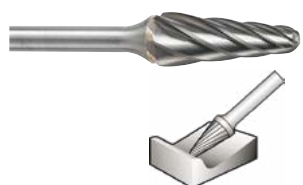

SL Ball-Nosed Cone

This cone shape is excellent for imparting fine finishes.

SUB-SHAPE	MAX. RPM	D1	L1	L2	MIN/STD PKG QTY	PART #
SL4 NF	25,000	1/2"	1-1/4"	6"	1	699573 60651

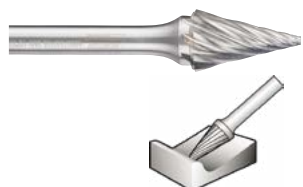

SM Pointed Cone

Ideal for rounded edges or reaching difficult, tight areas.

SUB-SHAPE	MAX. RPM	D1	L1	L2	MIN/STD PKG QTY	PART #
SM3 NF	25,000	1/2"	7/8"	2"	1	699573 40155

we've got you covered
**FROM DIY TO TOOLCRIB
TO PRODUCTION FLOOR**

Available in vitrified bond, resin bond, center lap and cotton fiber, and in a variety of shapes our mounted points offer fast, free cutting grinding and finishing capability. Produce sharp edges with the Norton line of sharpening stones - bringing solutions for craftsmen and hobbyists alike for over 190 years.

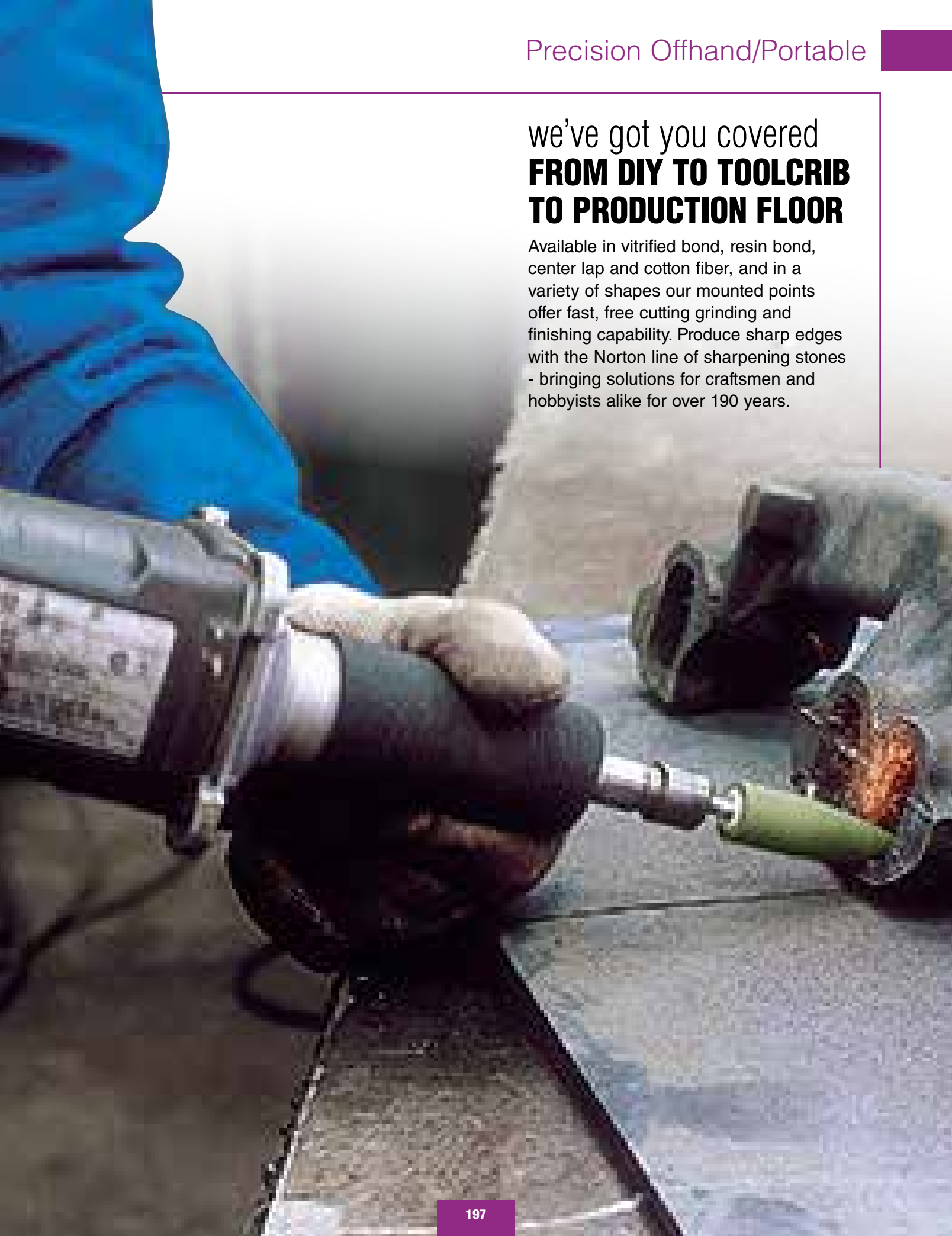



Resin bond, vitrified bond, center lap, and cotton fiber mounted points are available in a wide range of shapes.

Industries: Aerospace
Tool and Die
Construction
Metal Fabrication
Automotive
Cutlery
Mold Shops
Stainless Steel Equipment
Foundries

Abrasive Grain: Ceramic Alumina, Zirconia Alumina, Zirconia Alumina / Aluminum Oxide Blend, Aluminum Oxide

Shape Availability: A, B, and W

Machine Used:



DIE AND
PENCIL
GRINDER



HORIZONTAL/
STRAIGHT SHAFT
PORTABLE GRINDER

Measurement Guide

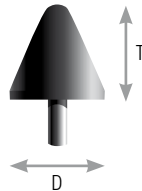
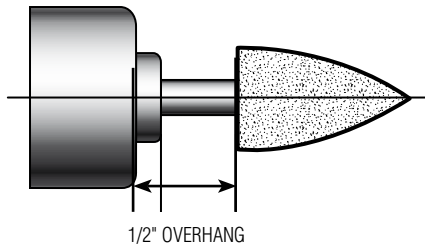

Description of Overhang

Overhang is the distance between the grinder chuck and the abrasive on the spindle. The larger the overhang, the lower the maximum safe operating speed.

Size

Measured by diameter (D) x thickness (T)

Cotton Fiber



Good for blending and polishing

COTTON FIBER ALUMINUM OXIDE - RESIN BOND

- Aluminum oxide grain provides an excellent blend of cut rate and life
- The cotton fibers ensure smooth, chatter-free grinding
- Designed for blending and polishing in one step; use 80 grit for most materials and 120 for polishing and stainless steel applications

TIER: **GOOD**

TRADENAME: **COTTON FIBER**

ABRASIVE: Aluminum Oxide

SHAPE	SIZE (D x T)	SPINDLE DIA. †	MAX. RPM*	MIN./STD. PKG.	SPEC	PART #
Cotton Fiber Mounted Points						
A11	7/8 x 2	1/4	19,860	5/25	A80-HBF3	614636 22664
B52	3/8 x 3/4	1/8	45,370	5/25	A120-HBF3	614636 20242
B121	1/2" Ball	1/8	45,370	5/25	A80-HBF3	614636 22657
W163	1/4 x 1/2	1/8	60,000	5/25	A80-HBF3	614636 22655
			60,000	5/25	A120-HBF3	614636 22656
W176	3/8 x 1/2	1/8	45,370	5/25	A80-HBF3	614636 22654
W185	1/2 x 1/2	1/8	34,500	5/25	A80-HBF3	614636 22649
W187	1/2 x 1	1/8	20,620	5/25	A80-HBF3	614636 22651
W220	1 x 1	1/4	25,500	5/25	A80-HBF3	614636 22646

† Spindle length is 1-1/2"

* Maximum RPM valid to 1/2" overhang. See package insert for other overhangs.

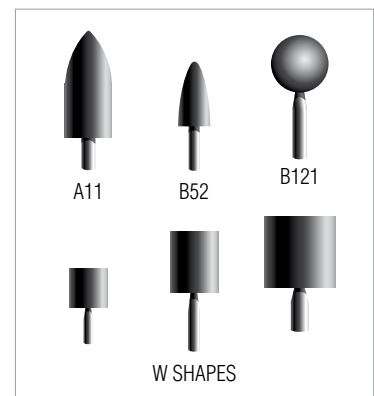

Center Lap

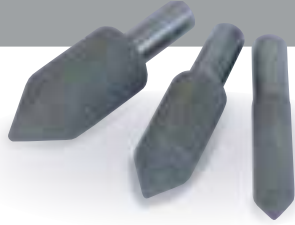

Better for Excell-O center lap and similar machines

CENTER LAP ALUMINUM OXIDE - VITRIFIED BOND

- Specially formulated wheel treatment provides added lubricity to the wheel, minimizing risk of metallurgical damage
- The larger diameter spindle ensures minimal deflection and rigid support
- Precise dimensional tolerances ensure accurate location of part centers

TIER: **BETTER**
 TRADENAME: **CENTER LAP**
 ABRASIVE: Aluminum Oxide

SHAPE	SIZE (D x T)	SPINDLE DIA. †	MAX. RPM*	MIN./STD. PKG.	SPEC	PART #
Center Lap Mounted Points						
-	1/2 x 2**	1/2	65,000	5/25	A80-VVM	614636 21421
-	1 x 2**	1/2	15,900	5/25	A80-VVM	614636 22926

† Spindle length is 1-1/4"

* Maximum RPM valid to 1/2" overhang. See package insert for other overhangs.

** Pointed 60°

TECH TIP

Dress the center lap mounted points frequently to ensure accurate and smooth center holes.



It is the user's responsibility to refer to and comply with ANSI B7.1

Resin Bond



Best choice for fast stock removal

NORZON ZIRCONIA ALUMINA – RESIN BOND

- Zirconia alumina abrasive blend for 2X faster cut rate than standard aluminum oxide
- Strong grain and specially formulated organic bond provide 4X greater life than aluminum oxide points, while reducing vibration and wheel chatter
- Ideal for removing parting lines, fins and small risers from castings, and smoothing and blending of welded areas



Better choice for fast stock removal and long life

CHARGER Z/A & A/O BLEND – RESIN BOND

- Durable zirconia alumina and aluminum oxide abrasive blend delivers 35% faster cut rate than standard aluminum oxide; an aggressive, free cut, and more parts cleaned in less time to substantially increase productivity
- Specially formulated organic bond provides 2X greater life than standard resin bonds while reducing vibration and wheel chatter
- Better choice for removing parting lines, fins and small risers from castings, and smoothing and blending welded areas
- Charger mounted point pre-packed in small packages are ideal for vending machines, pegboards, small jobs, and carrying to job site

TIER: **BEST** | **BETTER**
 TRADENAME: **NORZON** | **CHARGER**
 ABRASIVE: Zirconia Alumina | Zirconia Alumina/Aluminum Oxide

SHAPE	SIZE (D x T)	SPINDLE DIA. †	MAX. RPM*	MIN./STD. PKG.	SPEC	PART #	SPEC	PART #
Resin Bond Mounted Points								
A1	3/4 x 2-1/2	1/4	19,800	5/25	NZ24-UBXR1	614636 16457	Charger	614636 16458
A3	1 x 2-3/4	1/4	16,100	5/25	NZ24-UBXR1	614636 16459	Charger	614636 16460
A5	3/4 x 1-1/8	1/4	45,000	5/25			Charger	614636 16462
A11	7/8 x 2	1/4	19,860	5/25	NZ24-UBXR1	614636 16463	Charger	614636 16464
W189	1/2 x 2	1/4	24,000	5/25	NZ24-UBXR1	614636 16465	Charger	614636 16466
W197	5/8 x 2	1/4	21,000	5/25	NZ24-UBXR1	614636 16467		
W207	3/4 x 1-1/2	1/4	24,000	5/25			Charger	614636 16470
W208	3/4 x 2	1/4	18,750	5/25	NZ24-UBXR1	614636 16471	Charger	614636 16472
W220	1 x 1	1/4	25,500	5/25	NZ24-UBXR1	614636 17520	Charger	614636 17521
			25,500	5 V			Charger	662533 25930
W221	1 x 1-1/2	1/4	19,120	5/25	NZ24-UBXR1	614636 16473	Charger	614636 16474
W222	1 x 2	1/4	15,900	5/25	NZ24-UBXR1	614636 16475	Charger	614636 16476

† Spindle length is 1-1/2"

* Maximum RPM valid to 1/2" overhang. See package insert for other overhangs.

V = Vendible package. Ideal for vending machines and small jobs. Min. Pkg. Qty = number of mounted points per vendible pack. Order in multiples of min qty.

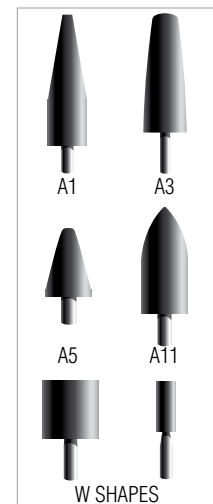

Vitrified Bond

Best choice for high volume operations



QUANTUM CERAMIC ALUMINA – VITRIFIED BOND

- Quantum grain with unique, engineered ceramic grain and shape, specifically developed for high-volume, high-speed alloy grinding operations
- Minimal loading and heat build-up; provide up to 33% longer life and 37% better metal removal rates versus other ceramic points
- Versatile; optimized for all low-, medium-, and high-force vitrified applications
- Oil and Gas 36 grit mounted points; specifically engineered to efficiently grind the carbide matrix material of oil field drill heads

Better medium grit option for blending and deburring

NEW

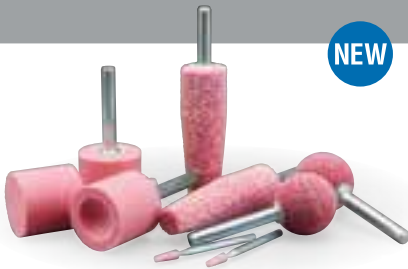

PINK ALUMINUM OXIDE – VITRIFIED BOND

- Sharp versatile 86A aluminum oxide grain is free cutting and resists burn
- Excellent form holding compared to more friable white aluminum oxides
- Medium grit for blending and deburring

Good value for general purpose, small job shop applications



GEMINI ALUMINUM OXIDE – VITRIFIED BOND

- 38A abrasive is designed to be cool cutting to minimize burn
- High temperature vitrified bond maximizes form holding and life
- Wide grit range for stock removal, blending/deburring, and finishing/polishing

TECH TIP

- For best mounted point performance, always run the mounted point at the maximum allowable speed according to ANSI B7.1. Refer to the speed chart included in each shipment for proper operating speeds.
- Use "A" shapes for medium- to heavy-duty blending.
- Use "B" shapes for light deburring and finishing/polishing.
- Use "W" shapes for offhand and precision grinding of medium to heavy stock.
- Use 36 grit and coarser for rough grinding.
- Use 60 and 90 grits for imparting fine finishes or when grinding on narrow surfaces.



It is the user's responsibility to refer to and comply with ANSI B7.1



Vitrified Bond

TIER:	BEST	BETTER	NEW	GOOD
TRADENAME:	QUANTUM	PINK		GEMINI
ABRASIVE:	Ceramic Alumina	86A Aluminum Oxide		38A Aluminum Oxide

SHAPE	SIZE (D x T)	SPINDLE DIA. †	MAX. RPM*	MIN./STD. PKG.	SPEC	PART #	SPEC	PART #	SPEC	PART #
Vitrified Bond Mounted Points – A Shapes										
A1	3/4 x 2-1/2	1/4	19,800	25/250	Oil & Gas 36	614636 86139				
A1	3/4 x 2-1/2	1/4	19,800	5/25	3NQ80	690831 49139	86A80-S	690786 45335	38A36-T	614636 24374
A1	3/4 x 2-1/2	1/4	19,800	5/25					38A60-P	614636 24375
A3	1 x 2-3/4	1/4	16,100	25/250	Oil & Gas 36	614636 86138				
A3	1 x 2-3/4	1/4	16,100	5/25			86A80-S	690786 45333	38A36-T	614636 24377
A3	1 x 2-3/4	1/4	16,100	5/25					38A60-P	614636 24378
A4	1-1/4 x 1-1/4	1/4	30,560	5/25					38A60-P	614636 24380
A5	3/4 x 1-1/8	1/4	45,000	5/25			86A80-S	690786 45339	38A36-T	614636 24381
A5	3/4 x 1-1/8	1/4	45,000	5/25					38A60-P	614636 24382
A11	7/8 x 2	1/4	19,860	5/25	3NQ80	690831 49141			38A36-T	614636 24384
A11	7/8 x 2	1/4	19,860	5/25			86A80-S	690786 45336	38A60-P	614636 24385
A12	11/16 x 1-1/4	1/4	48,000	5/25			86A80-S	690786 45344	38A60-P	614636 24388
A13	1-1/8 x 1-1/8	1/4	33,950	5/25					38A60-P	614636 24389
A15	1/4 x 1-1/16	1/4	72,750	5/25					38A60-P	614636 24391
A21	1 x 1	1/4	34,500	5/25					38A60-P	614636 24392
A23	3/4 x 1	1/4	39,370	5/25					38A60-P	614636 24394
A24	1/4 x 3/4	1/4	76,500	5/25					38A60-P	614636 24395
A25	1" Ball	1/4	35,620	5/25			86A80-S	690786 45341	38A60-P	614636 24396
A26	5/8" Ball	1/4	61,120	5/25					38A60-P	614636 24397
A31	1-3/8 x 1	1/4	27,780	5/25					38A60-P	614636 24399
A34	1-1/2 x 3/8	1/4	25,470	5/25					38A60-P	614636 24402
A36	1-5/8 x 3/8	1/4	23,520	25/250	Oil & Gas 36	662531 45562				
A36	1-5/8 x 3/8	1/4	23,520	5/25					38A60-P	614636 24404
A37	1-1/4 x 1/4	1/4	30,560	5/25					38A60-P	614636 24405
A38	1 x 1	1/4	34,500	5/25			86A80-S	690786 45345	38A60-P	614636 24406
A39	3/4 x 3/4	1/4	47,250	5/25					38A60-P	614636 24407
A40	3/4" Ball	1/4	47,250	5/25					38A60-P	614636 24408

† Standard spindle size is 1/4" x 1-1/2"

* Maximum RPM valid to 1/2" overhang. See package insert for other overhangs.

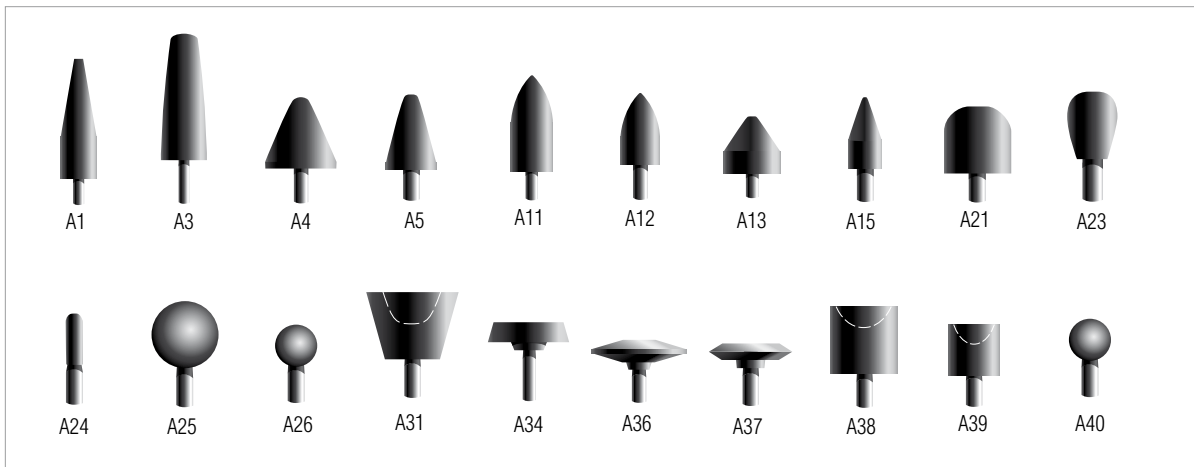

Vitrified Bond

TIER:	BEST	BETTER	NEW	GOOD
TRADENAME:	QUANTUM	PINK		GEMINI
ABRASIVE:	Ceramic Alumina	86A Aluminum Oxide		38A Aluminum Oxide

SHAPE	SIZE (D x T)	SPINDLE DIA. †	MAX. RPM*	MIN./STD. PKG.	SPEC	PART #	SPEC	PART #	SPEC	PART #
Vitrified Bond Mounted Points – B Shapes										
B41	5/8 x 5/8	1/8	33,570	5/25					38A60-P	614636 24410
B42	1/2 X 3/4	1/8	33,570	5/25					38A60-P	614636 24412
B44	7/32 x 3/8	1/8	68,400	5/25					38A60-P	614636 24414
B45	3/16 x 5/16	1/8	104,250	5/25					38A60-P	614636 24415
B46	1/8 x 5/16	1/8	105,000	5/25					38A60-P	614636 24416
B51	7/16 x 3/4	1/8	45,370	5/25					38A60-P	614636 24418
B52	3/8 x 3/4	1/8	45,370	5/25			86A80-S	690786 45334	38A60-P	614636 24420
B52	3/8 x 3/4	1/4	81,000	5/25					38A60-P	614636 24419
B52	3/8 x 3/4	1/8	45,370	5/25					38A90-Q	614636 24422
B53	5/16 x 5/8	1/8	60,000	5/25			86A80-S	690786 45340	38A60-P	614636 24423
B55	1/8 x 1/4	1/8	105,000	5/25					38A60-P	614636 24425
B81	3/4 x 3/16	1/8	50,930	5/25			86A80-S	690786 45347	38A60-P	614636 24437
B91	1/2 x 5/8	1/8	34,500	5/25					38A60-P	614636 24443
B96	1/8 x 1/4	1/8	105,000	5/25					38A90-Q	614636 24449
B97	1/8 x 3/8	1/8	105,000	5/25	3NQ80	690831 49048	86A80-S	690786 45337	38A60-P	614636 24451
B121	1/2" Ball	1/8	45,370	5/25			86A80-S	690786 45338	38A60-P	614636 24466
B122	3/8" Ball	1/8	61,650	5/25	3NQ80	690831 49050	86A80-S	690786 45360	38A60-P	614636 24470
B123	3/16" Ball	1/8	104,250	5/25					38A60-P	614636 24472
B124	1/8" Ball	1/8	105,000	5/25					38A90-Q	614636 24474
B131	1/2 x 1/2	1/8	34,500	5/25					38A60-P	614636 24475
B132	3/8 x 1/2	1/8	45,370	5/25					38A60-P	614636 24479
B135	1/4 x 1/2	1/8	60,000	5/25			86A80-S	690786 45342	38A60-P	614636 24484

† Spindle size is 1/8" or 1/4" x 1-1/2"

* Maximum RPM valid to 1/2" overhang. See package insert for other overhangs.

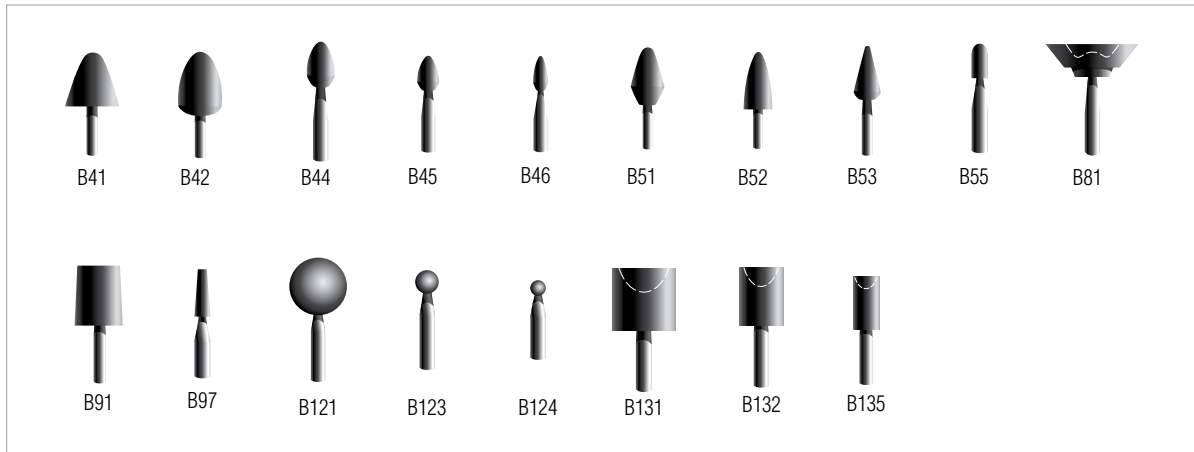

Vitrified Bond

TIER:	BEST	GOOD	NEW	GOOD
TRADENAME:	QUANTUM	PINK		GEMINI
ABRASIVE:	Ceramic Alumina	86A Aluminum Oxide		38A Aluminum Oxide

SHAPE	SIZE (D x T)	SPINDLE DIA. †	MAX. RPM*	MIN./STD. PKG.	SPEC	PART #	SPEC	PART #	SPEC	PART #
Vitrified Bond Mounted Points – W Shapes										
W144	1/8 x 1/4	1/8	105,000	5/25					38A60-P	614636 24488
W145	1/8 x 3/8	1/8	105,000	5/25					38A60-P	614636 24489
W146	1/8 x 1/2	1/8	105,000	5/25					38A60-P	614636 24491
W152	3/16 x 1/4	1/8	105,000	5/25					38A60-P	614636 24495
W153	3/16 x 3/8	1/8	80,850	5/25					38A60-P	614636 24496
W154	3/16 x 1/2	1/8	70,500	5/25	3NQ80	690831 49133			38A60-P	614636 24497
W162	1/4 x 3/8	1/8	64,800	5/25					38A60-P	614636 24503
W163	1/4 x 1/2	1/8	60,000	5/25			86A80-S	690786 45346	38A60-P	614636 24504
W164	1/4 x 3/4	1/8	45,900	5/25					38A60-P	614636 24505
W170	5/16 x 1/2	1/8	52,500	5/25					38A60-P	614636 24511
W175	3/8 x 3/8	1/8	54,000	5/25					38A60-P	614636 24516
W176	3/8 x 1/2	1/8	45,370	5/25					38A60-P	614636 24517
W177	3/8 x 3/4	1/8	33,750	5/25			86A80-S	690786 45355	38A60-P	614636 24518
W179	3/8 x 1-1/4	1/4	20,415	25/250	Oil & Gas 36	690831 54055				
W185	1/2 x 1/2	1/8	34,500	5/25	3NQ80	690831 49137			38A60-P	614636 24525
W185	1/2 x 1/2	1/4	61,500	5/25			86A80-S	690786 45354	38A60-P	614636 24526
W186	1/2 X 3/4	1/4	51,000	5/25					38A60-P	614636 24528
W188	1/2 x 1-1/2	1/4	30,370	5/25					38A60-P	614636 24530
W189	1/2 x 2	1/4	24,000	25/250	Oil & Gas 36	614636 86137				
W189	1/2 x 2	1/4	24,000	5/25					38A60-P	614636 24531
W196	5/8 x 1	1/4	35,250	5/25					38A60-P	614636 24539
W200	3/4 x 1/8	1/8	50,930	5/25			86A80-S	690786 45356	38A60-P	614636 24543
W200	3/4 x 1/8	1/8	50,930	5/25					38A90-Q	614636 24544
W204	3/4 x 3/4	1/4	42,750	5/25					38A60-P	614636 24549
W205	3/4 x 1	1/4	34,500	5/25					38A60-P	614636 24550
W208	3/4 x 2	1/4	18,750	5/25					38A60-P	614636 24553
W215	1 x 1/8	1/8	38,200	5/25					38A60-P	614636 24560
W216	1 x 1/4	1/4	38,200	5/25					38A60-P	614636 24562
W218	1 x 1/2	1/4	38,200	25/250	Oil & Gas 36	690831 54061				
W218	1 x 1/2	1/4	38,200	5/25					38A60-P	614636 24564
W220	1 x 1	1/4	25,500	5/25			86A80-S	690786 45359	38A60-P	614636 24566
W222	1 x 2	1/4	15,900	5/25					38A60-P	614636 24569
W230	1-1/4 x 1-1/4	1/4	20,400	5/25					38A60-P	614636 24578
W235	1-1/2 x 1/4	1/4	25,470	5/25			86A80-S	690786 45343	38A60-P	614636 24583
W236	1-1/2 x 1/2	1/4	25,470	5/25					38A60-P	614636 24585
W237	1-1/2 x 1	1/4	22,500	5/25					38A60-P	614636 24587
W238	1-1/2 x 1-1/2	1/4	15,600	5/25					38A60-P	614636 24588
W242	2 x 1	1/4	19,100	5/25					38A60-P	614636 24592

† Spindle size is 1/8" or 1/4" x 1-1/2"

* Maximum RPM valid to 1/2" overhang. See package insert for other overhangs.

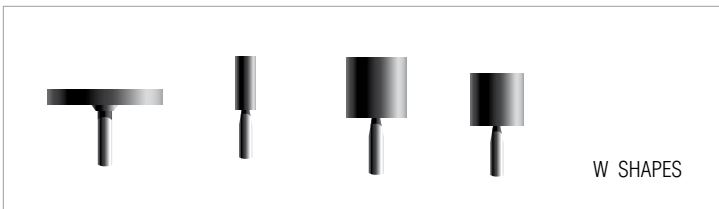



Since 1823, Norton stones have lead the marketplace with conventional and diamond benchstones, waterstones, sharpening systems, files, slips and specialty stones for industrial, commercial and DIY sharpening applications. Our comprehensive line of sharpening and finishing products is the industry's broadest line with premier performance and quality.

Applications:

Deburring, dimensioning, sharpening, honing

Grit Range:

Coarse, Medium, Fine, Extra Fine, Ultra Fine

Abrasive Types:

Aluminum Oxide (India), Silicon Carbide (Crystolon), Arkansas (Soft and Hard Translucent), and Diamond

Machine Used:



HAND SHARPENING

Application-to-Product Recommendation Guide Benchstones

	Coarse/Medium Sharpening	Fine Stoning	Finish Honing
Chip Breakers	–	Fine Crystolon Benchstone	–
Draw Knives	Coarse Crystolon Benchstone	Fine India Benchstone	Hard Arkansas Benchstone
Scrapers	Coarse Crystolon Benchstone	Fine India Benchstone	Hard Arkansas Benchstone
Chisels (Wood)	Coarse Crystolon Benchstone 1000 Waterstone	Fine India Benchstone 4000 Waterstone	Hard Arkansas Benchstone 8000 Waterstone
Plane Blades	Coarse Crystolon Benchstone 1000 Waterstone	Fine India Benchstone 4000 Waterstone	Hard Arkansas Benchstone 8000 Waterstone

Slips

	Coarse/Medium Sharpening	Fine Stoning
Milling Cutter	Medium India Round Edge Slip	Fine India Round Edge Slip
Carbide Tools		Fine Crystolon Slip for Carbide Tools

Abrasive Files

	Coarse/Medium Sharpening	Fine Stoning	Finish Honing
Form Cutter	Coarse or Medium India Knife Blade	Fine India Knife Blade	–
Keyways	Coarse or Medium India Square File	Fine India Square File	–
Lathe Bits	Medium India Square File	Fine India Square File	–
Radius Tools	Medium India Round File	Fine India Round File	–
Reamers	Medium India Reamer Stone	Fine India Reamer Stone	–
Router Bits	–	Fine India Square File	–
Saws	Coarse India Triangular File	Fine India Tapered Triangular File	–
Center Punches	Medium India Triangular File	Fine India Triangular File	–
Magnetic Chucks	Medium Crystolon Round File	Fine India Round File	–
Molding Cutters*	Coarse or Medium India File	Fine India File	–
Countersinks	Coarse India Triangular File	Fine India Triangular File	Hard Arkansas Triangular File
Tap Threads	–	Fine India Triangular File	–

* Select shape to fit configuration

Relative Sharpening Comparisons for Norton Products

Crystolon (Silicon Carbide); India (Aluminum Oxide)	Arkansas (Soft, Hard Translucent)	Diamond Stones	Waterstones	Coated Abrasives (Waterproof Sandpaper)		Diamond Compound
			JIS (Japan)	CAMI (USA)	FEP A (Europe)	MICRON Size
Coarse Crystolon					P120	141
				120		127
						116
Coarse India					P150	97
				150		93
						78
Medium Crystolon		Extra Coarse Diamond (220)	Norton 220		P220	65
				220		60
					P240	58
Medium India				240		53.5
					P280	52.5
						50
Fine Crystolon		Coarse Diamond (325)		280		46
					P360	45
				360		43
Fine India				320		40.5
					P400	36
				360		35
Soft Arkansas		Fine Diamond (600)		400		29
					P600	25.8
				600		23
Hard Translucent Arkansas			Norton 4000	600	P800	22
						20
				800		16
			Norton 1000	700		14
				800	P1500	12.6
			1200			11
					P2000	10.3
				1500		9.2
						9
				1500	P2500	8.4
						7.5
						6
			Norton 4000	2000		5
						3
			Norton 8000			1.2
						1
						0.5
			15000			

Benchstones

Better choice for sharpening tools and knives



PRECISION BENCHSTONES

- Jewelers' Benchstones – These stones are excellent for sharpening the fine, precision cutting tools used by jewelers, engravers and artisans
- Penknife Precision Benchstones – Ideal for sharpening cutting tools, laboratory blades, surgical instruments, engravers' and die makers' tools, and pocket knives to the keenest edge

TIER: BETTER

SIZE (L x W x H)	QTY./CASE	SPEC.	PRODUCT #	PART #
Precision Benchstones – Jewelers'				
4 x 2 x 3/8	5	Ultra Fine – Hard Translucent Arkansas	HB24	614636 87525
6 x 2 x 3/8	5	Ultra Fine – Hard Translucent Arkansas	HB26	614636 87530
<i>Jewelers' stones are packed in individual boxes within a case. Order in multiples of stones/case.</i>				
Precision Benchstones – Penknife				
3 x 1 x 3/8	5	Extra Fine – Soft Arkansas	SB13	614636 87560
		Ultra Fine – Hard Translucent Arkansas	HB13	614636 87550
4 x 1 x 3/8	5	Extra Fine – Soft Arkansas	SB14	614636 87565
		Ultra Fine – Hard Translucent Arkansas	HB14	614636 87555

Benchstones *continued*



VENDIBLE

Better choice for edge shaping and honing

SINGLE GRIT ABRASIVE BENCHSTONES

- Crystolon – sharp premium silicon carbide abrasive, delivers fast stock removal for quick edge shaping with minimal loading
- India - smooth cutting aluminum oxide abrasive produces a strong, keen, long-lasting edge and is the choice for the best blend of cut rate and finish
- Arkansas – Natural premium Novaculite quarried in Arkansas and available in Soft or Hard Translucent

TIER: BETTER				
SIZE (L x W x H)	QTY./CASE	SPEC.	PRODUCT #	PART #
Single Grit Benchstones – Crystolon (Silicon Carbide)				
4 x 1 x 1/4	5	Coarse	CJB14	614636 85470
	5	Medium	MJB14	614636 85465
	5	Fine	FJB14	614636 85460
	5 V	Fine	FJB14-V	662533 25915+
4 x 1 x 1/2	5	Coarse	CJB24	614636 85485
	5	Medium	MJB24	614636 85480
	5	Fine	FJB24	614636 85475
5 x 2 x 5/8	5	Medium	MJB35	614636 85495
	5	Fine	FJB35	614636 85490
6 x 2 x 1	5	Coarse	CJB6	614636 85510
	5	Medium	MJB6	614636 85505
	5	Fine	FJB6	614636 85500
8 x 2 x 1	5	Coarse	CJB8	614636 85525
	5	Medium	MJB8	614636 85520
	5	Fine	FJB8	614636 85515
8 x 3 x 1/2	5	Coarse	CJB83	614636 54459*
	5	Medium	MJB83	614636 54458*
	5	Fine	FJB83	614636 54457*
11-1/2 x 2-1/2 x 1/2	1	Coarse	JM3	614636 85980#
	1	Medium	JM6	614636 85975#
Single Grit Benchstones – Soft Arkansas				
4 x 2 x 3/4-1	5	Extra Fine	SB4	614636 85670
6 x 2 x 3/4-1	5	Extra Fine	SB6	614636 85675
8 x 2 x 3/4-1	5	Extra Fine	SB8	614636 85680

TIER: BETTER				
SIZE (L x W x H)	QTY./CASE	SPEC.	PRODUCT #	PART #
Single Grit Benchstones – India (Aluminum Oxide)				
4 x 1 x 1/4	5	Coarse	CB14	614636 85580
	5	Medium	MB14	614636 85575
	5	Fine	FB14	614636 85570
	5 V	Fine	FB14-V	662533 25919
4 x 1 x 1/2	5	Coarse	CB24	614636 85595
	5	Medium	MB24	614636 85590
	5	Fine	FB24	614636 85585
5 x 2 x 5/8	5	Medium	MB35	614636 85605
	5	Fine	FB35	614636 85600
6 x 2 x 1	5	Coarse	CB6	614636 85620
	5	Medium	MB6	614636 85615
	5	Fine	FB6	614636 85610
8 x 2 x 1	5	Coarse	CB8	614636 85635
	5	Medium	MB8	614636 85630
	5	Fine	FB8	614636 85625
8 x 3 x 1/2	5	Coarse	CB83	614636 54462*
	5	Medium	MB83	614636 54461*
	5	Fine	FB83	614636 54460*
11-1/2 x 2-1/2 x 1/2	1	Medium	IM6	614636 54214#
	1	Fine	IM9	614636 85970#
Single Grit Benchstones – Hard Translucent Arkansas				
4 x 2 x 3/4-1	5	Ultra Fine	HB4	614636 85655
6 x 2 x 3/4-1	5	Ultra Fine	HB6	614636 85660
8 x 2 x 3/4-1	5	Ultra Fine	HB8	614636 85665
8 x 3 x 1/2	5	Ultra Fine	HTB83	614636 54464*
11-1/2 x 2-1/2 x 1/2	1	Ultra Fine	HM11	614636 85965#

V = Vendible Package. Ideal for vending machines, small jobs, and carrying to job site. Pre-packed in sturdy boxes of 5 per pack. Order by total number of stones needed in multiples of 5.

* May be used as replacement stone for IM-83 Sharpening System.

May be used as replacement stone for IM-313 Sharpening Stone System.

These benchstones (except for 8 x 3 x 1/2 and vendibles) are packed in individual boxes within a case. Order in multiples of stones/case.



Benchstones *continued*

Better choice for economical solution for general sharpening and finishing with one stone



COMBINATION GRIT ABRASIVE BENCHSTONES

- **Crystolon Combination**
Coarse and fine grit sharp-cutting silicon carbide abrasive surfaces for general sharpening (to moderate tolerances) when the speed of sharpening is more important than the fineness of the cutting edges. Gray in color.
- **India Combination**
Coarse and fine grit aluminum oxide abrasive surfaces produce strong, keen, long-lasting edges on quality tools. Orange/brown in color.
- **Crystolon/India Combination**
Fast-sharpening, medium grit silicon carbide (Crystolon) and fine aluminum oxide (India) abrasive surfaces for keen, long-lasting edges on quality tools. Crystolon side is dark gray in color, India side is orange.
- **Giant Combination Stones**
11-1/2" and 12" bench oil stones are used to sharpen large edge tools with long sweeping strokes.

Application-to-Product Recommendation Guide

	FAST CUT STOCK REMOVAL	INITIAL SHARPENING	FINAL SHARPENING	HONING	SHARPEST EDGE
Grit Size	Coarse	Medium	Fine	Extra Fine	Ultra Fine
Abrasive	Crystolon	Crystolon	India	Soft Arkansas	Hard Arkansas
Product/Color	Grey	Grey	Orange	Milky White	Translucent

SIZE (L x W x H)	QTY./CASE	SPEC.	TIER: BETTER	
			PRODUCT #	PART #
Combination Grit Benchstones – Crystolon (Silicon Carbide)				
4 x 1 Round	5	Coarse/Fine	JB64	614636 85435
4 x 1-3/4 x 5/8	5	Coarse/Fine	JB134	614636 85440
5 x 2 x 3/4	5	Coarse/Fine	JB45	614636 85445
6 x 2 x 1	5	Coarse/Fine with Anniversary Box	JB6	614636 85450
8 x 2 x 1	5	Coarse/Fine with Anniversary Box	JB8	614636 85455
11-1/2 x 2-1/2 x 1	2	Coarse/Fine	JUM3	614636 85840
12 x 2-1/2 x 1-1/2	2	Coarse/Fine	JUM4	614636 85855
Combination Grit Benchstones – India (Aluminum Oxide)				
4 x 1 Round	5	Coarse/Fine	IB64	614636 85545
4 x 1-3/4 x 5/8	5	Coarse/Fine	IB134	614636 85550
5 x 2 x 3/4	5	Coarse/Fine	IB45	614636 85555
6 x 2 x 1	5	Coarse/Fine with Anniversary Box	IB6	614636 85560
8 x 2 x 1	5	Coarse/Fine with Anniversary Box	IB8	614636 85565
11-1/2 x 2-1/2 x 1	2	Coarse/Fine	IM2	614636 85851
Combination Grit Benchstones – Crystolon/India				
6 x 2 x 1	5	Medium/Fine	IC6	614636 85643
11-1/2 x 2 x 1	2	Medium/Fine	IC11	614636 87239

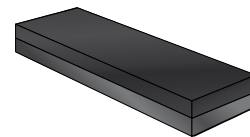

These benchstones are packed in individual boxes within a case. Order in multiples of stones/case.

Waterstones

Waterstones are synthetic stones designed to be softer than oil stones. These softer grade stones are used with water as the lubricant (versus oil) to develop a fast cutting slurry. The Norton Waterstone system was designed in a carefully planned sequence to create sharpening efficiency. You get the level of abrasiveness you need at each stage, without wasting time trying to sharpen your tools on a grit that is too fine, too soon.

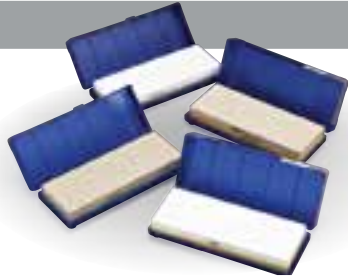

Better choice for producing superior edges on planes and straight chisels

WATERSTONES

- Synthetic stones designed to work together, with water for fast sharpening, fine finish
- Softer than traditional oilstones - providing lapping action for superb results with low pressure
- Color-coded by grit: 220 grit for repairing badly damaged tools, 1000 grit for initial cut, 4000 grit for excellent finishing, and 8000 grit for polishing



Better choice for raising slurry

PREP STONE

- This synthetic stone enhances the performance of waterstones by speeding up the slurry-making process needed to cut and polish with waterstones
- This prep stone is designed to raise the slurry on waterstones without significantly altering the dimensions of the stone
- Waterstones are great for producing superior edges for planes and straight chisels

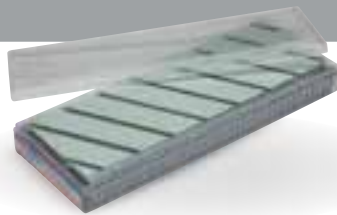

Better choice for producing flat surfaces on waterstones

FLATTENING STONE

- Coarse grit silicon carbide stone promotes fast results
- Diagonal grooves increase swarf removal
- Superbly flat with hard bond to produce extremely flat surfaces on all waterstones

SIZE (L x W x H)	QTY./ CASE	SPEC.	TIER: BETTER
			PART #
Waterstones – Single Grit			
8 x 3 x 1	5	220	614636 89505
	5	1000	614636 89506
	5	4000	614636 89507
	5	8000	614636 89508
Set	1	4 Stones: 220, 1000, 4000, 8000 Grit	614636 24334
Waterstones – Combination Grit			
8 x 3 x 1	5	220 / 1000	614636 24335
	5	1000 / 4000	614636 24450
	5	1000 / 8000	699366 55039
	5	4000 / 8000	614636 24336
Prep Stone			
20mm x 20mm x 3"	5	Aluminum Oxide	662434 39361
Flattening Stone			
9 x 3 x 3/4	5	Silicon Carbide	699366 87444
Waterstone Kit			
N/A	1	Kit includes: 1-220/1000 and 1-4000/8000 waterstone, 1 flattening stone	076607 87943

Waterstones are packed in individual boxes within a case. Order in multiples of stones/case.

TECH TIP

Maximizing Waterstone Performance

- Wet waterstone
- Rub evenly with the prep stone to create slurry
- Evening off the high spots will make for less-frequent flattening of the waterstones
- Waterstones wear concave with use; periodically flatten with flattening stone

Diamond Benchstones

Made in the USA, these benchstones have unique stackable non-skid rubber feet designed to keep the diamond plate steady while you sharpen, and efficiently stacked for space-saving storage when not in use. Our simple grit-size color-coding makes them easy to differentiate.

Better choice for producing superior edges on planes and straight chisels



STACKABLE DIAMOND BENCHSTONES

- Flat, diamond surface plated onto a nickel coated steel bar precision ground to a tolerance of .001 in. for fast, even blade and tool edge sharpening
- Continuous diamond sharpening surface for excellent sharpening performance across entire surface of stone
- Choose 220 grit for badly worn tools, 325 for initial sharpening, 600 grit for final sharpening
- Color-coded tabs on stones and packaging for easy identification of grit sizes for use and displaying
- Stackable; the stones firmly stack on top of each other for easy, small-profile storage
- Non-skid rubber base stays in place while sharpening for smoother, efficient sharpening

SIZE WITH RUBBER FEET (L x W x H)	QTY./ CASE	SPEC.	TIER: BETTER	
			PRODUCT #	PART #
Stackable Diamond Benchstones				
6 x 2 x 1/4*	5	D220	662532	68082
6 x 2 x 1/4*	5	D325	662532	68081
6 x 2 x 1/4*	5	D600	662532	68080

Diamond benchstones are packed in individual boxes within a case. Order in multiples of stones/case.



6" stones come retail packaged

Sharpening Stone Oil

Better choice for improving sharpening stone performance



SHARPENING STONE OIL

- Highly refined lubricating oil which is specifically formulated for sharpening stone use
- Will not load or "gum-up" sharpening stones, meets U.S. Pharmacopoeia standards for mineral oil purity; may be used around food preparation operations
- Equally ideal for all lubricating jobs

SIZE	QTY./ CASE	SPEC.	TIER: BETTER	
			PRODUCT #	PART #
Sharpening Stone Oil				
4-1/2 oz.	20	Oil	XB1	614636 87760
1 Pint	20	Oil	XB5	614636 87770
1 Quart	5	Oil	XB2	614636 87775
1 Gallon	4	Oil	XB6	662534 57631

TECH TIP

- All oil stones are porous in nature; oil is required to keep the pores open and working efficiently
- Use Norton oil to optimize the performance of Crystolon, India and Arkansas stones
- While sharpening knives, blades and tools, be careful to keep fingers away from sharp edges

Sharpening Systems

Tri-Stone Systems

The base of the tri-stone system acts as an oil reservoir permitting continuous submersion of the unused stones, keeping them clean and saturated, ready for immediate use and years of utility. Rotating the handle brings the desired stone into position for sharpening. All offer a range of replacement stones to replace worn or damaged stones, or substitute different specifications to customize the system.



Better choice for large, straight-edged tool sharpening

IM313 MULTI-OILSTONE SHARPENING SYSTEM

- Considered by many to be the ultimate sharpening system, the IM313 contains three oil stones. The 11-1/2" stone length permits long, sweeping strokes for faster and more precise sharpening and honing of all large, wider straight-edged tools. The heavy base has a non-skid bottom.
- Coarse Crystolon stone quickly restores worn edges for general sharpening; medium Crystolon stone produces the average edge needed for most tools; and fine India stone hones for a sharper edge
- Each IM313 system is included with a pint of Norton oil, plastic angle guide, and reservoir unit



Better choice for a versatile, multi-size tool and knife sharpener

IM200 PROFESSIONAL SHARPENING SYSTEM

- The smaller 8" stone IM200 system provides the same quality sharpening features as the IM313 – making it the perfect choice for small restaurants and home DIYers
- Coarse Crystolon stone quickly restores worn edges for general sharpening; medium Crystolon stone produces the average edge needed for most tools; and fine India stone hones for a sharper edge
- Contains 4-1/2 oz. of lubricating oil, plastic angle guide, and the reservoir unit



Better choice for small straight-edged tool sharpening

IM100 3-IN-1 TOOL AND KNIFE SHARPENING SYSTEM

- The smallest system, designed for general sharpening, the IM100 is an affordable choice for small knives, cutlery, and woodworking tools
- Coarse Crystolon stone quickly restores worn edges for general sharpening; medium Crystolon stone produces the average edge needed for most tools; and fine India stone hones for a sharper edge
- 4-1/2 oz. of lubricating oil and a reservoir unit included

Portable Sharpening Systems



Better choice for all sharpening enthusiasts who carry their system with them

IM83 PORTABLE SHARPENING STONE SYSTEM

- Sturdy metal latches secure the cover and storage case – where small tools can be housed. The IM83 system is designed like all our other sharpening systems; the stones can be replaced to customize the unit to individual requirements
- Ideal for industrial toolrooms, restaurants, knife manufacturers, DIYers, and sportsmen
- Both IM83 systems include 3 sharpening stones, and a reservoir carrying case; the oil stone system also includes 4-1/2 oz. oil
- IM83-W Portable Waterstone System – Tool Repair to Fine Finishes
This portable sharpening system is equipped with a carefully engineered sequence of waterstones for clean, efficient sharpening. The waterstones can easily be maintained with the flattening stone provided
- IM83-O Portable Oil Stone System – Straight-Edged Tool Sharpening
The coarse silicon carbide (Crystolon) stone in this system repairs damaged edges quickly; the medium aluminum oxide (India) stone imparts a durable, smooth cutting edge; and the fine aluminum oxide (India) stone provides the final sharpening and polishing stage

Sharpening Systems *continued*

Portable Sharpening Systems *continued*

			TIER: BETTER	
SIZE	QTY./ CASE	SPEC.	PRODUCT #	PART #
IM313 Multi-Oilstone Sharpening System				
11-1/2 x 2-1/2 x 1/2	1	1 Coarse Crystolon, 1 Medium Crystolon, and 1 Fine India Stone, 1 Pint Oil, Angle Guide, Reservoir Unit	IM313	614636 85960
IM200 Professional Sharpening System				
8 x 2 x 3/8	1	1 Coarse Crystolon, 1 Medium Crystolon, and 1 Fine India Stone, 4-1/2 oz. Oil, Angle Guide, Reservoir Unit	IM200	614636 91260
IM100 3-in-1 Tool and Knife Sharpening System				
6 x 2 x 1/2	1	1 Coarse Crystolon, 1 Medium Crystolon, and 1 Fine India Stone, 4-1/2 oz. Oil, Reservoir Unit	IM100	614636 85356
IM83 Portable Systems				
8 x 3 x 1/2	1	Oilstones: 1 Coarse Crystolon, 1 Medium India, 1 Fine India, 4-1/2 oz. Oil, Reservoir Carrying Case	IM83-O	662435 82823
8 x 3 x 1	1	Waterstones: 1 ea. of 1000, 4000, 8000 Grit, 1 Flattening Stone, Reservoir Carrying Case	IM83-W	662435 82825

For sharpening system replacement stones: see single grit benchstone charts, or your Norton representative for replacement stones and parts which may be used as replacements or to customize your system.

Abrasive Files

Norton abrasive files hold their shape while imparting the finest, most uniform finish on precision machine parts and in tool and die making. They are ideal for any deburring, chamfering or radiusing job, or for filing delicate parts. Select the file shape that matches the contour of the surface being stoned.

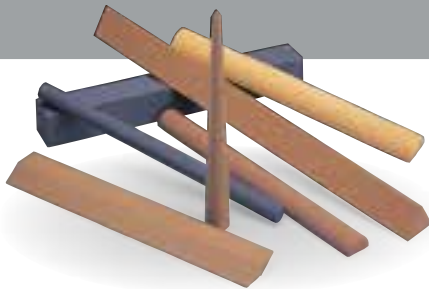

Better choice for any deburring, chamfering or radiusing job, or for filing delicate parts

ABRASIVE FILES

- Crystolon Files – Fast-acting silicon carbide products. Crystolon files are designed for use where moderate tolerances are acceptable, and speed of sharpening is more important than fineness
- India Files – India files are ideal when close tolerance, and strong, keen, long-lasting edges are needed
- Hard Translucent Arkansas Files – Hard Arkansas has an ultra fine grit that produces the finest edge possible while maintaining tolerances unequalled by any other abrasive file. It will also produce a highly polished finish

Square Abrasive Files

Square File applications range from dimensioning keyways to maintain fit, stoning faces on router bits, touching-up edges of reamer teeth, and lapping/honing to close tolerances to produce the finest edge on precision instruments, die work and delicate tools.



TIER: BETTER				
SIZE (L x H)	QTY./ CASE	SPEC.	PRODUCT #	PART #
Square Abrasive Files – Crystolon (Silicon Carbide)				
4 x 1/2	5	Medium	MJF44	614636 86045
	5	Fine	FJF44	614636 86040
Square Abrasive Files – Hard Translucent Arkansas				
3 x 1/4	5	Ultra Fine	HF13	614636 86590
3 x 3/8	5	Ultra Fine	HF33	614636 86595
3 x 1/2	5	Ultra Fine	HF43	614636 86600

All square files are bulk packed

TIER: **BETTER**

SIZE (L x H)	QTY./ CASE	SPEC.	PRODUCT #	PART #
Square Abrasive Files – India (Aluminum Oxide)				
4 x 1/4	5	Coarse	CF14	614636 86075
	5	Medium	MF14	614636 86070
	5	Fine	FF14	614636 86065
4 x 3/8	5	Coarse	CF34	614636 86090
	5	Medium	MF34	614636 86085
	5	Fine	FF34	614636 86080
4 x 1/2	5	Coarse	CF44	614636 86105
	5	Medium	MF44	614636 86100
	5 V	Medium	MF44-V	662533 25913
	5	Fine	FF44	614636 86095
6 x 1/2	5	Coarse	CF46	614636 86120
	5	Medium	MF46	614636 86115
	5	Fine	FF46	614636 86110
6 x 5/8	5	Medium	MF56	614636 86130
	5	Fine	FF56	614636 86125
6 x 3/4	5	Coarse	CF66	614636 86150
	5	Medium	MF66	614636 86145
	5	Fine	FF66	614636 86140
6 x 1	5	Coarse	CF76	614636 86165
	5	Medium	MF76	614636 86160
	5	Fine	FF76	614636 86155

V = Vendible Package. Ideal for vending machines, small jobs, and carrying to job site. Pre-packed in sturdy boxes of 5 per pack. Order by total number of stones needed in multiples of 5.

Abrasive Files *continued*

Triangular Abrasive Files

Triangular Files are used for a variety of deburring, chamfering and radiusing applications including cleaning tap threads, stoning cutting surfaces of milling cutters, lapping honing tools, dies and molds, and putting precision points on center punches.

The India line also offers Tapered Triangles, used by mechanics and tool and die makers to impart the correct edge in the least time.



TIER: BETTER

SIZE (L x H)	QTY./CASE	SPEC.	PRODUCT #	PART #
Triangular Abrasive Files – Crystolon (Silicon Carbide)				
4 x 1/4	5	Fine	FJF114	61463686185
4 x 1/2	5	Fine	FJF144	61463686205
Triangular Abrasive Files – Hard Translucent Arkansas				
3 x 1/4	5	Ultra Fine	HF113	61463686620
3 x 3/8	5	Ultra Fine	HF133	61463686625
3 x 1/2	5	Ultra Fine	HF143	61463686630

All Triangular files are bulk packed

Round Abrasive Files

Half Round Files offer both a round and a flat surface for imparting a fine finish on precision machine parts, tools and dies.

Round Files are ideal for deburring, chamfering, radiusing, lapping, honing, cleaning radius tools to a burr-free edge, and dimensioning compound curves on templates.

Round Pointed Files are ideally suited for engravers and die sinkers for stoning difficult recesses on instruments and die tools.

Round Tapered Files are used by craftsmen, woodworkers, and die makers as their unique shape imparts the correct edge quickly.

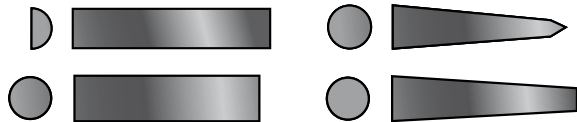

TIER: BETTER

SIZE (L x D)	QTY./CASE	SPEC.	PRODUCT #	PART #
Half Round Abrasive Files – India (Aluminum Oxide)				
4 x 1/4	5	Medium	MF314	61463686355
		Fine	FF314	61463686350
4 x 3/8	5	Medium	MF334	61463686385
		Fine	FF334	61463686380
4 x 1/2	5	Coarse	CF344	61463686405
		Medium	MF344	61463686400
		Fine	FF344	61463686395

All Half-Round and Round files are bulk packed

TIER: BETTER

SIZE (L x H)	QTY./CASE	SPEC.	PRODUCT #	PART #
Triangular Abrasive Files – India (Aluminum Oxide)				
4 x 1/4	5	Coarse	CF114	61463686240
		Medium	MF114	61463686235
		Fine	FF114	61463686230
4 x 3/8	5	Coarse	CF134	61463686255
		Medium	MF134	61463686250
		Fine	FF134	61463686245
4 x 1/2	5	Coarse	CF144	61463686270
		Medium	MF144	61463686265
		Fine	FF144	61463686260
6 x 1/2	5	Coarse	CF146	61463686285
		Medium	MF146	61463686280
		Fine	FF146	61463686275
6 x 5/8	5	Medium	MF156	61463686295
		Fine	FF156	61463686290
6 x 3/4	5	Medium	MF166	61463686310
		Fine	FF166	61463686305
6 x 1	5	Medium	MF176	61463686325
		Fine	FF176	61463686320
Triangular Tapered Abrasive Files – India (Aluminum Oxide)				
4 x 1/2 x 1/4	5	Medium	MF544	61463686685
		Fine	FF544	61463686680

TIER: BETTER

SIZE (L x D)	QTY./CASE	SPEC.	PRODUCT #	PART #
Round Abrasive Files – Crystolon (Silicon Carbide)				
4 x 1/4	5	Medium	MJF214	61463686430
		Fine	FJF214	61463686425
4 x 3/8	5	Medium	MJF234	61463686440
Round Abrasive Files – India (Aluminum Oxide)				
4 x 1/4	5	Coarse	CF214	61463686480
		Medium	MF214	61463686475
		Fine	FF214	61463686470
4 x 3/8	5	Coarse	CF234	61463686495
		Medium	MF234	61463686490
		Fine	FF234	61463686485
4 x 1/2	5	Coarse	CF244	61463686510
		Medium	MF244	61463686505
		Fine	FF244	61463686500
6 x 1/2	5	Coarse	CF246	61463686525
		Medium	MF246	61463686520
		Fine	FF246	61463686515
6 x 5/8	5	Medium	MF256	61463686535
6 x 3/4	5	Medium	MF266	61463686550
6 x 1	5	Medium	MF276	61463686565
Round Abrasive Files – Hard Translucent Arkansas				
3 x 1/4	5	Ultra Fine	HF813	61463686800
Round Pointed Abrasive Files – India (Aluminum Oxide)				
3 x 5/16 Base	5	Coarse	CF723	61463686750
		Medium	MF723	61463686745
		Fine	FF723	61463686740
Round Pointed Abrasive Files – Hard Translucent Arkansas				
3 x 1/4 Base	5	Ultra Fine	HF863	61463686825
Round Tapered Abrasive Files – India (Aluminum Oxide)				
4 x 1/2 x 1/4	5	Coarse	CF644	61463686660
		Medium	MF644	61463686655
		Fine	FF644	61463686650

Abrasive Files *continued*

Diamond-Shaped Abrasive Files

Diamond-shaped Files are precision sharpening favorites for cleaning acute angles in dies and molds, and for stoning geometric chasers and sewing machine feeds.



TIER: BETTER				
SIZE (L x W x H)	QTY./CASE	SPEC.	PRODUCT #	PART #
Diamond-Shaped Abrasive Files – India (Aluminum Oxide)				
4 x 9/16 x 3/16	5	Coarse	CT134	614636 86720
	5	Medium	MT134	614636 86715
	5	Fine	FT134	614636 86710
Diamond-Shaped Abrasive File – Hard Translucent Arkansas				
3 x 1/2 x 3/16	5	Ultra Fine	HF843	614636 86815

All Diamond-shaped files are bulk packed

Beveled Abrasive Files

Beveled Files are preferred by exacting artisans, jewelers, mechanics, and watchmakers for honing the finest of finishes. These extremely hard files provide years of service.



TIER: BETTER				
SIZE (L x W x H)	QTY./CASE	SPEC.	PRODUCT #	PART #
Beveled Abrasive File – Hard Translucent Arkansas				
3 x 3/8 x 1/8	5	Ultra Fine	HF833	614636 86810

All Beveled files are bulk packed

Flat Abrasive Files

The Flat File is the choice of mechanics, artisans and jewelers. This long lasting file produces the finest finishes.



TIER: BETTER				
SIZE (L x W x H)	QTY./CASE	SPEC.	PRODUCT #	PART #
Flat Abrasive File – Hard Translucent Arkansas				
3 x 3/8 x 1/8	5	Ultra Fine	HF823	614636 86805

All Flat files are bulk packed

Oval Abrasive Files

The Oval File's shape makes it ideal for finishing and honing recesses or curved edges of precision instruments.



TIER: BETTER				
SIZE (L x W x H)	QTY./CASE	SPEC.	PRODUCT #	PART #
Oval Abrasive File – Hard Translucent Arkansas				
3 x 1/2 x 3/16	5	Ultra Fine	HF853	614636 86820

All Oval files are bulk packed

Knife Blade Abrasive Files

Knife Blade Files are used by clock and watch makers to quickly sharpen, hone, and maintain the edges and points of cutting tools.



TIER: BETTER				
SIZE (L x W x H)	QTY./CASE	SPEC.	PRODUCT #	PART #
Knife Blade Abrasive Files – India (Aluminum Oxide)				
4 x 1 x 1/8 Back	5	Coarse	CF724	614636 86780
	5	Medium	MF724	614636 86775
	5	Fine	FF724	614636 86770
Knife Blade Abrasive File – Hard Translucent Arkansas				
3 x 3/4 x 1/8	5	Ultra Fine	HF873	614636 86830

All Knife Blade files are bulk packed

Abrasive File Sets

Hard Translucent Arkansas File Set

This set provides a selection of our most popular square, triangular, round and knife blade files in ultra fine Hard Translucent Arkansas for honing and polishing a wide range of configurations.

Hard Translucent Arkansas-India File Set

This set contains an assortment of files for finishing, honing and polishing applications. It contains a selection of the most popular square, triangular, round and knife blade files in both fine grit India and ultra fine grit Hard Translucent Arkansas.



TIER: BETTER			
SIZE (L x W x H)	QTY./CASE	PRODUCT #	PART #
File Set – Hard Translucent Arkansas			
	1		614636 86839
1 Each of Ultra Fine Hard Arkansas HF13, HF113, HF813, and HF873			
File Set – Hard Translucent Arkansas and India (Aluminum Oxide)			
	1		614636 86840
1 Each of Ultra Fine Hard Arkansas HF13, HF43, HF113, HF813, HF873, and Fine India FF14, FF44, FF114, FF214, FF724			

Abrasive Files *continued*

Engravers' Chuck & Points

Engravers' Points are the choice of professional die-makers for cleaning tight corners and recesses where close tolerances and accuracy are a must. The Engravers' Chuck is a knurled nickel-plated tool designed to hold the Engravers' Point.

SIZE (L x POINT)	QTY./CASE	SPEC.	PRODUCT #	PART #
<i>TIER: BETTER</i>				
Engravers' Chuck				
Engravers' Chuck	5		XT1	614636 87485
Engravers' Point – India (Aluminum Oxide)				
1 x 1/8 Point	5	Fine	FT11	614636 87495
Engravers' Point – Soft Arkansas				
1 x 1/8 Point	5	Extra Fine	AT11	614636 87490

All Engravers' Chucks and Points are bulk packed.

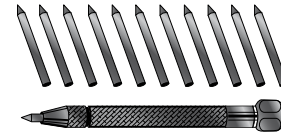

Silversmith Precision Files

These aluminum oxide precision-shaped stones are designed for use by silversmiths and mechanics for close tolerance lapping, touching-up instruments, and for cleaning tools and dies.

SIZE	QTY./CASE	SPEC.	PRODUCT #	PART #
<i>TIER: BETTER</i>				
Silversmith Precision Files – India (Aluminum Oxide)				
4 x 5/16 x 3/16 x 5/16 x 1/16 - X	5	Medium	MF414	614636 86855
	5	Fine	FF414	614636 86850
4 x 3/8 x 3/16 x 1/8 x 1/16 - Y	5	Fine	FF424	614636 86910
4 x 1/2 x 1/16 - BB	5	Coarse	CF444	614636 86965
	5	Medium	MF444	614636 86960
	5	Fine	FF444	614636 86955
4 x 1/2 x 1/4 x 5/16 x 1/8 - EE	5	Medium	MF474	614636 87005
	5	Fine	FF474	614636 87000

All Silversmith Precision Files are bulk packed.

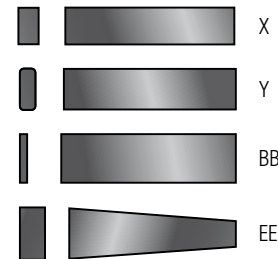

Pocket Stones



Better choice for outdoor enthusiasts

POCKET STONES

- Convenient and easily transported
- Ideal for outdoor enthusiasts to sharpen scissors, knives, axes, etc.
- Available in a protective case

SIZE (L x W x H)	QTY./CASE	SPEC.	PRODUCT #	PART #
<i>TIER: BETTER</i>				
Sportsman Pocket Stone – India (Aluminum Oxide)				
3 x 1-1/2 x 1/2	50	Coarse/Fine	IBP4	614636 90705
Pocket Stone – India (Aluminum Oxide)				
4 x 3/4 x 1/4	25	Fine	IBP4	614636 24153
Pocket Stone with Case – India (Aluminum Oxide)				
3 x 7/8 x 3/8 with case	50	Fine	FBP3	614636 91122
Pocket Stone with Case – Crystolon (Silicon Carbide)				
3 x 7/8 x 3/8 with case	50	Fine	JP14	614636 90703
Pocket Stone with Case – Soft Arkansas				
4 x 1 x 3/4 with case; in retail package	5	Extra Fine		662531 42544
Fish Hook Stone With Pouch – Crystolon Half-Round (Silicon Carbide)				
3 x 1/2 with pouch	50	Fine		614636 24072

All Pocket Stones except 662531**42544** are bulk packed.

Abrasive Slips



Better choice for imparting fine, uniform finishes

ABRASIVE SLIPS

- Norton abrasive slips impart the finest, most uniform finishes on curved knives and tools, molders' knives, wood gouges, bead planers, and carbide-tipped tools
- The Crystolon and India stones are designed for preliminary sharpening; the Norton Hard Translucent Arkansas stones are the choice for achieving the finest finish possible
- These fast-acting slips hold their shape and are long lasting

Carbide Tool Slips

Crystolon (silicon carbide) Slips are used to maintain the edge of carbide tools – keeping regrinding costs and time to an absolute minimum. Not oil-filled.

Round Edge Slips

Round Edge Slips are ideal for precision sharpening and honing of bead planers, curved knives and tools, molders' knives and wood gouges.



TIER: **BETTER**

SIZE	QTY./CASE	SPEC.	PRODUCT #	PART #
Carbide Tool Slips – Crystolon (Silicon Carbide)				
3-1/2 x 3/4 x 1/2	5	Coarse	CJT63	614636 87295
	5	Medium	MJT63	614636 87290
	5	Fine	FJT63	614636 87285
Set of Three Above	5	Coarse, Medium & Fine	J63	614636 87300
Carbide Tool Slips – India (Aluminum Oxide)				
2-1/4 x 7/8 x 3/16	5	Medium	MS12	614636 87215
Round Edge Slips – Crystolon (Silicon Carbide)				
4-1/2 x 1-3/4 x 1/4 x 3/32	5	Medium	MJS24	614636 87080
	5	Fine	FJS24	614636 87075
4-1/2 x 1-3/4 x 1/2 x 3/16	5	Coarse	CJS44	614636 87100
	5	Medium	MJS44	614636 87095
	5	Fine	FJS44	614636 87090
6 x 2-1/4 x 3/4 x 3/8	5	Medium	MJS66	614636 87110
	5	Fine	FJS66	614636 87105
Round Edge Slips – India (Aluminum Oxide)				
4 x 1 x 7/16 x 3/16	5	Medium	MS14	614636 87140
	5	Fine	FS14	614636 87135
4-1/2 x 1-3/4 x 1/4 x 3/32	5	Coarse	CS24	614636 87155
	5	Medium	MS24	614636 87150
	5	Fine	FS24	614636 87145
4-1/2 x 1-3/4 x 3/8 x 1/8	5	Coarse	CS34	614636 87170
	5	Medium	MS34	614636 87165
	5	Fine	FS34	614636 87160
4-1/2 x 1-3/4 x 1/2 x 3/16	5	Coarse	CS44	614636 87185
	5	Medium	MS44	614636 87180
	5	Fine	FS44	614636 87175
5 x 1 x 5/16 x 3/32	5	Medium	MS15	614636 87195
	5	Fine	FS15	614636 87190
Round Edge Slips – Soft Arkansas				
4 x 1-3/4 x 3/8 x 1/8	5	Extra Fine	SS4	614636 87055
Round Edge Slips – Hard Translucent Arkansas				
3 x 1-3/4 x 1/4 x 1/16	5	Ultra Fine	HS3	614636 87040
4 x 1-1/4 x 1/4 x 1/8	5	Ultra Fine	HS14	614636 87050
4 x 1-3/4 x 3/8 x 1/8	5	Ultra Fine	HS4	614636 87045

All Slips are bulk packed.

Specialty Stones



Better choice for specific sharpening or deburring applications

SPECIALTY STONES

- Norton continues to offer specialty stones with optimum specifications and unique shapes that conform to, and quickly sharpen, specific tools

Specialty Stones for Machine Tools

Gouge Sharpening Stone

This stone has a unique shape for sharpening and lapping inside and outside curved surfaces on gouges and other cutting tools.

Jointer Stones

These stones provide a fast method of restoring and maintaining the cutting edges of mechanical jointing devices on automatic planers.

Machine Knife Stone

Crystolon (silicon carbide) machine knife stones offer both coarse and fine sides for sharpening and honing paper and cloth-cutting knives and planer knives on the machine. The groove around the middle of the stone protects fingers and provides a secure hold.

Reamer Stones

Durable, fast-cutting stones designed for imparting a professional edge on reamers, taps, and rough rounders on shoe machine tools.

Boat Stones

Boat Stones are medium grit, medium grade stones that are easy to hold and use. Excellent for deburring and breaking sharp edges on dies, fixtures and machined parts, and for deburring grinder magnetic chucks.

SIZE	QTY./CASE	SPEC.	PRODUCT #	PART #
TIER: BETTER				
Gouge Sharpening Stone – India (Aluminum Oxide)				
6 x 2 x 1 x 1/2 x 3/8	5	Fine	FS76	614636 87305
Jointer Stones				
4 x 3/4 x 3/8 – Crystolon (Silicon Carbide)	5	Medium	JE74	614636 87335
4 x 3/4 x 3/8 – India (Aluminum Oxide)	5	Coarse	IE74	614636 87375
Machine Knife Stone – Crystolon (Silicon Carbide)				
4" Diam. x 1-1/2" Thick	5	Coarse/Fine	JB74	614636 87570
Reamer Stones – India (Aluminum Oxide)				
4-1/2 x 1 x 5/16	10	Medium	MT124	614636 87420
	10	Fine	FT124	614636 87415
5 x 1 x 3/16	10	Medium	MT125	614636 87430
	10	Fine	FT125	614636 87425
6 x 1 x 1/4	10	Medium	MT126	614636 87440
	10	Fine	FT126	614636 87435
Boat Stone – Crystolon (Silicon Carbide)				
9 x 2-1/2 x 1-1/2	10	37C80-HV		614636 10369
Boat Stone – India (Aluminum Oxide)				
9 x 2-1/2 x 1-1/2	10	38A60-IVBE		614636 10503

Boat and Reamer Stones are bulk packed. All these other Specialty Stones are packed in individual boxes within a case.

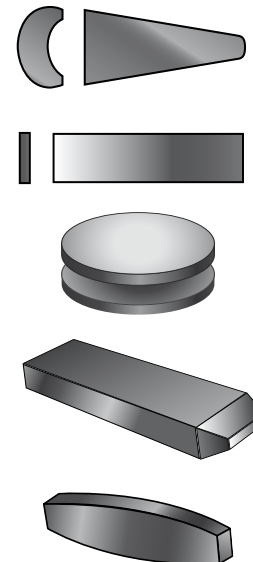

Large Specialty Stones

Tradesmen's Utility Stones

Used for sharpening trimming knives and as an abrasive file in many different industries. The JT910 does not have a handle, while the JT920 and JT930 have wooden handles.

Sickle and Scythe Stones

These silicon carbide stones quickly produce a fast-cutting edge on sickles, scythes, and brush hooks. These stones are most frequently chosen where the speed of sharpening is the primary consideration.

Utility File

A long wedge-shaped stone with four flat sides designed for sharpening coarse cutting edges on cutting implements and edged garden tools. Wooden handles make them easy to use. They will outlast and out-sharpen metal files.

SIZE	QTY./CASE	SPEC.	PRODUCT #	PART #
TIER: BETTER				
Tradesmen's Utility Stones – Crystolon (Silicon Carbide)				
10 x 1-1/4 x 3/4	10	Medium	JT910	614636 87665
14-3/4 Overall (with Handle)	10	Coarse/Fine	JT930	614636 87675
	10	Medium	JT920	614636 87670
Sickle and Scythe Stones				
10 x 1-1/4 x 3/4 Crystolon (Silicon Carbide)	10	Coarse	TJ3	614636 87731
10 x 1-5/16 x 3/4 India (Aluminum Oxide)	10	Coarse	TD1	614636 87715
Utility File – Crystolon (Silicon Carbide)				
14 Overall (w/ Handle)	10	Coarse	JD2	614636 87750

All Large Specialty Stones are bulk packed.

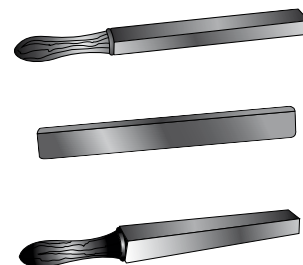

Retail Packaged Sharpening Products

Our retail-packaged line brings Norton quality to your distributor showroom, vending machine, tool crib, and your tool box. Each stone is specifically designed for a popular sharpening application and packaged to sell or carry to the job site.

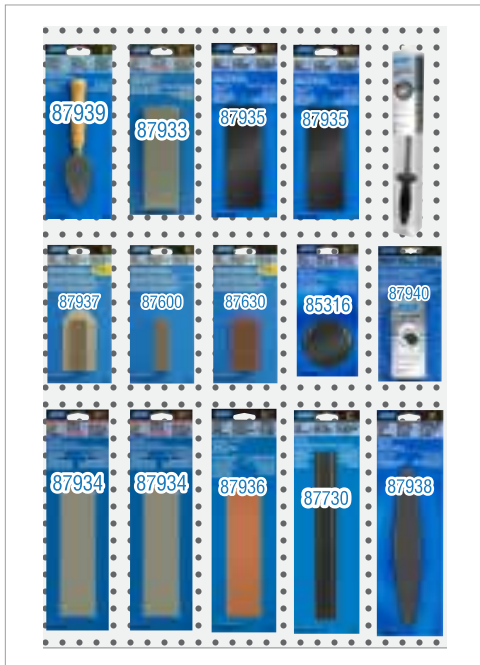

SIZE (L x W x H)	SPEC.	TIER: BETTER	
		QTY./CASE	PART #
Axe and Hatchet Sharpener			
3 x 5/8 round	Coarse/Fine Crystolon (Silicon Carbide)	10	076607 85316
Pocket Knife Sharpener			
3 x 7/8 x 3/8	Fine Crystolon (Silicon Carbide)	5	076607 87600
3 x 7/8 x 3/8 with case	Medium India (Aluminum Oxide)	5	076607 87937
3 x 1-1/2 x 1/2 with case	Coarse/Fine India (Aluminum Oxide)	5	076607 87630
Economy Tool & Knife Benchstone			
6 x 2 x 3/4	Coarse/Fine Crystolon (Silicon Carbide)	5	076607 87933
8 x 2 x 3/4	Coarse/Fine India (Aluminum Oxide)	10	076607 87934
8 x 2 x 1	Coarse/Fine India (Aluminum Oxide)	10	614636 85755
High Quality Tool & Knife Benchstone			
6 x 2 x 3/4	Coarse/Fine Crystolon (Silicon Carbide)	5	076607 87935
Chisel & Planer Blade Sharpener			
8 x 2 x 3/4	Coarse/Fine India (Aluminum Oxide)	10	076607 87936
Household Knife & Tool Sharpener			
7-1/2	Fine Crystolon (Silicon Carbide)	5	076607 87939
Farm Tool Sharpener			
10 x 1-1/4 x 3/4	Coarse Crystolon (Silicon Carbide)	10	076607 87730
Lawn & Garden Tool Sharpener			
9-1/2 x 1-3/8 x 1/2	Medium Crystolon (Silicon Carbide)	10	076607 87938
Sharpening Stone Oil			
4-1/2 oz.	Oil	5	076607 87940
Sharpening Steel			
1/2 x 10	Round file with rubber handle	8	662532 40433
Vitrified Dressing Stick			
1 x 1 x 6	Medium Silicon Carbide	5	076607 10466

Knife and Scissor Sharpener

The knife and scissor mechanical sharpener is a quick and portable tool for hundreds of sharpening applications.

SPECIFICATION	QTY./CASE	PART #
Knife and Scissor Sharpener		
Carbide	6	076607 87520

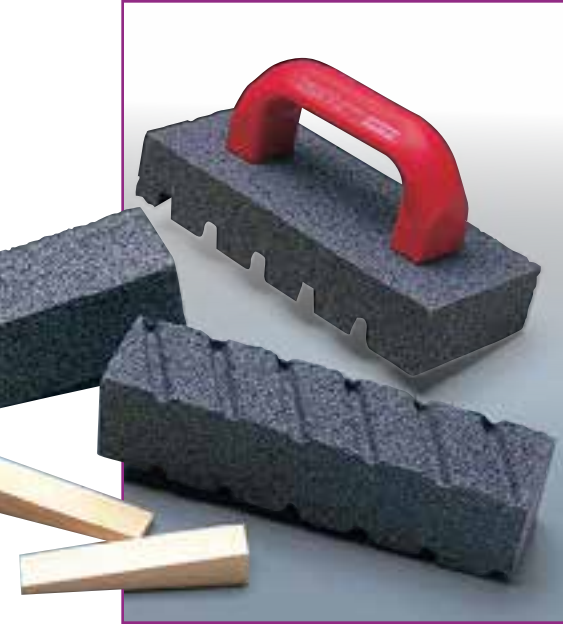

Hard silicon carbide rubbing bricks are used for heavy-duty applications such as rubbing floors, cleaning and scouring castings, rubbing down concrete, and removing mold marks.

Applications:

Floor Rubbing Bricks – are used to rub down concrete and remove mold marks. These are designed to fit the chucks of common concrete floor grinding equipment. Reusable wooden wedges anchor the bricks to the equipment chucks.

Plain Hand Rubbing Bricks – are the choice of mechanics and foundry workers for dressing grinding wheels and cleaning or scouring castings.

Fluted Hand Rubbing Bricks – are used by masons and stone workers for rubbing down concrete and removing mold marks. The diagonal flutes provide sharp edges, a clean shearing action, and carry away debris.

Fluted Hand Rubbing Bricks with Handle – make quick work of removing mold marks and rubbing down concrete. The firmly attached handle reduces fatigue and facilitates overhead, wall, and floor work.

Griddle Bricks – quickly clean away carbon build-up and other residue on your grill without leaving fibers, which grill brushes often do.

Grit Range:
Abrasive Type:
Machine Used:

6 – 120
Silicon Carbide



HAND SANDING



ELECTRIC
FLOOR STRIPPER



SIZE (L x W x H)	QTY./ CASE	SPEC.	ABRASIVE	PART #
Plain Floor Rubbing Bricks with Wooden Wedges				
4 x 2 x 2	6	C6-R	Silicon Carbide	614636 53292
	6	C10-R	Silicon Carbide	614636 53293
	6	C24-R	Silicon Carbide	614636 53294
	6	C80-R	Silicon Carbide	614636 53295

SIZE (L x W x H)	QTY./ CASE	PART #
Wooden Wedges		
	6	614636 85297

SIZE (L x W x H)	QTY./ CASE	SPEC.	ABRASIVE	PRODUCT #	PART #
Plain Hand Rubbing Bricks					
8 x 2 x 2	5	C24	Silicon Carbide	BP28	614636 87830

SIZE (L x W x H)	QTY./ CASE	SPEC.	ABRASIVE	PRODUCT #	PART #
Fluted Hand Rubbing Bricks					
6 x 2 x 2	5	C20	Silicon Carbide	BF26	614636 87840
8 x 2 x 2	5	C20	Silicon Carbide	BF28	614636 87845

SIZE (L x W x H)	QTY./ CASE	SPEC.	ABRASIVE	PRODUCT #	PART #
Fluted Hand Rubbing Bricks with Handle					
6 x 3 x 1	5	C20	Silicon Carbide	BFH6	614636 87800
8 x 3-1/2 x 1-1/2	5	C20	Silicon Carbide	235	614636 87795

SIZE (L x W x H)	QTY./ CASE	SPEC.	ABRASIVE	PART #
Griddle Brick				
4-1/2 x 3 x 2	5	Medium	Alundum	614636 87870



improve your **PROCESS, PRODUCTIVITY, AND COST POSITION**

You know the industry-leading performance of our engineered abrasives. Norton R&D has now created new formulations of these abrasives with our exclusive, proprietary Norton Vitrium³ (VS3) bond. You won't get better productivity from any other grinding wheels and segments.

- Cooler cutting with better chip clearance; improved coolant flow; significantly reduced burn
- Reduced wheel loading
- Improved part quality
- Improved precision profile; ultra-radius accuracy
- Extended wheel life
- Reduced dressing frequency and cost
- Improved cycle and process time
- Able to run at higher operating speed; increased throughput and productivity
- Leverage existing equipment; optimize machine efficiency



iGrind App

Created by Norton engineers and updated based on feedback from you, the Norton iGrind app features calculators and conversion tools designed to help optimize your grinding processes.

With Norton iGrind, you can calculate the starting parameters for traverse or plunge truing your grinding wheel, determine the ideal setup for delivering coolant to the grinding zone, and convert wheel speeds between RPM, SFPM (Surface Feet Per Minute), and M/Sec to ensure a safe grinding operation.

App Features:

- Wheel Speed Converter
- Traverse Diamond Roll Dressing Calculator
- Coolant Calculator
- Plunge Diamond Roll Dressing Calculator
- Stationary Tool Dressing Calculator

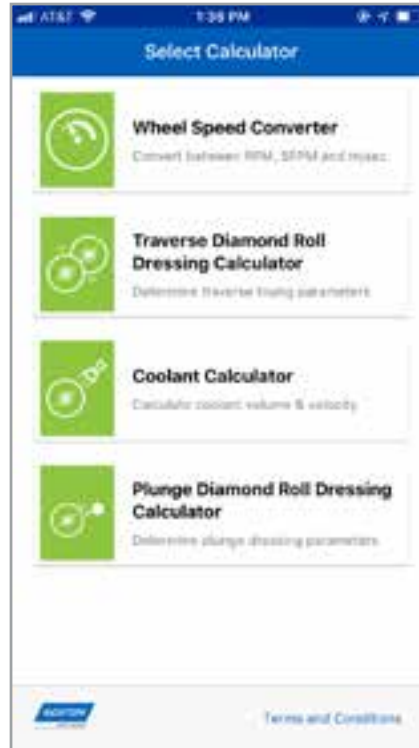

Standard Grinding Wheel and Periphery Shapes



Type 01
Straight Wheels

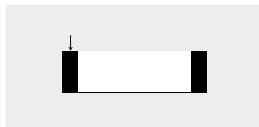

Type 02
Cylinder Wheels



Type 05
Recessed One Side
Wheels

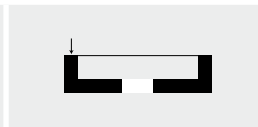

Type 06
Straight Cup Wheels
(rim and back)

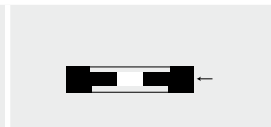

Type 07
Double Recessed
Wheels

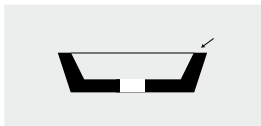

Type 11
Taper Cup Wheels

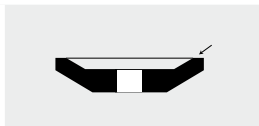

Type 12
Dish Wheels



Type 31
Segments

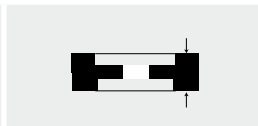

Type 35 and 36
Discs

How to Read an Abrasive Product Specification

Conventional Grinding Wheels

32A 46 I 8 V BE

Abrasive				Grit Size			Grade			Structure	Bond Type	Norton Symbol
Aluminum Oxide	Ceramic	Silicon Carbide	Zirconia Alumina	Coarse	Medium	Fine	Soft	Medium	Hard	Relative grain spacing	Resin = B	Designates a variation or modification to bond.
23A	Oxide	37C	4NZ	12	30	80	D	I	Q	Dense	Shellac = E	
25A	3SGP	39C	4ZF	14	36	90	E	J	R	↑ 2 4 5 6 8 12 16 19 25 28 ↓ Open	Plastic = P	
32A	3SGR	Crystolon	5ZF	16	46	100	F	K	S		Rubber = R	
32AC (blend)	5SG	Masonry	AZ (blend)	20	54	120	G	L	T		Vitrified = V	
38A	BRG		BlueFire	24	60	150	H	M	u			
48A	SG		Charger (blend)	70	220		N	V				
53A	SXG						O	Y				
55A	NorZon Plus (blend)		NZ				P	Z				
57A	NQ		NZC (blend)									
U57A	Quantum		NZIII									
64A	Targa		NZIV									
86A			NorZon									
90A			ZI									
Alundum												
FabCut												
India												
Gemini												
Metal												
Vortex												

Shelf Life and Proper Storage of Grinding Wheels

It has always been Saint-Gobain Abrasives recommendation that resinoid bonded grinding wheels be used within 2 years from the date of manufacture. This recommendation assumes that resinoid bonded grinding wheels have been stored under ideal storage conditions. It might be true that under ideal storage conditions resinoid bonded grinding wheels can survive without any degradation in strength for well over two years. However, it is always wise to suspect any wheels over two years old and have them reinspected or re-speed tested to determine if there has been any degradation in strength. If the wheels are stored under less than ideal conditions, they might have a much shorter shelf life depending upon the severity of storage conditions. These same comments also apply to rubber and shellac bonded grinding wheels.

As for vitrified grinding wheels, the shelf life is less influenced by humidity and adverse storage conditions as compared to resinoid, rubber or shellac, but even vitrified grinding wheels do not have an infinite shelf life. The best procedure and the best rule of thumb is to have any wheel that is two years old or older re-speed tested and reinspected to ensure it is fit for use. The procedure for having this done and the charges will be explained by our Customer Service Department, but the cost of shipping as well as the cost of re-inspection is the customer's responsibility. Also, any wheels rejected or otherwise lost in the re-inspection process will also be the responsibility of the customer.

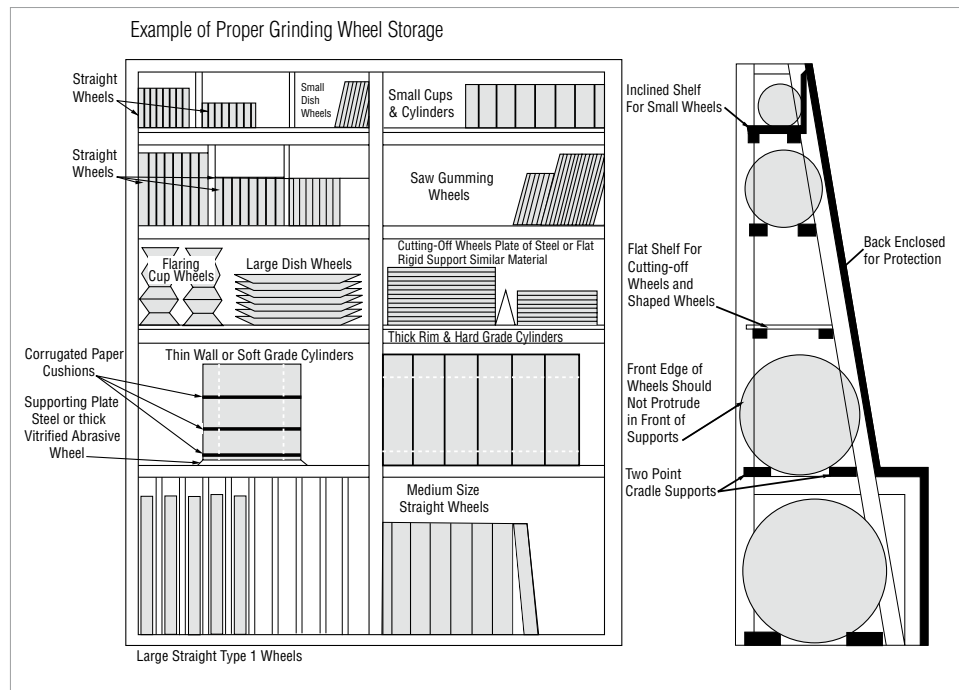

Keep in mind, however, that this procedure is good to verify the reliability of a product but must not be performed until you are ready to consume the wheel. If wheels are sent back after the two year time frame for re-inspection and re-testing and then put back on the shelf, there is no telling how long they will be fit for use after that last inspection. Therefore, these wheels must be consumed as soon as is practical.



The Norton bench and pedestal wheel line consists of numerous wheel diameters and arbor sizes, abrasive types and grit sizes. Our offering answers all metal removal, deburring, shaping and sharpening needs: white aluminum oxide for high-speed tool steels, brown aluminum oxide for carbon steel, and silicon carbide for non-ferrous metals and carbide tooling.

- Applications:** Offhand deburring and sharpening of parts and tools
- Size Range:** 5" – 18"
- Grit Range:** 24 – 150
- Abrasive Types:** Premium Ceramic Alumina, Aluminum Oxide, Silicon Carbide
- Bushings:** Telescopic arbor bushings to fit all popular grinders are packaged with the wheel
- Machine Used:**



BENCH GRINDER



PEDESTAL GRINDER

Application/Grit Recommendation Guide

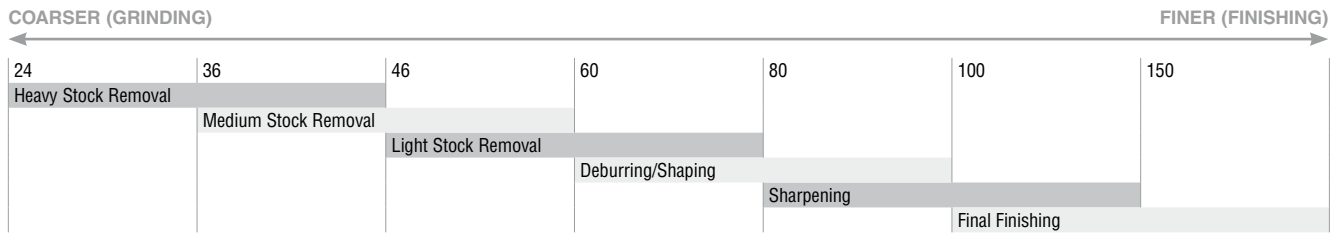

TECH TIP

- Unsecured machines can move, causing grinding breakage and injury. Fixed-based bench and pedestal grinders **MUST** be secured.
- Do not grind wood, plastic, or any other non-metallic material on a bench or pedestal grinder.
- All bench and pedestal wheels must be dressed to prevent loading. Loading can cause excessive heat, damage to the workpiece, and wheel breakage. Dressing exposes new cutting edges and provides chip clearance.
- Recommended starting dressing stick: 1" x 1" x 6" 37C24-SVK Part # 614636**10462**



It is the user's responsibility to refer to and comply with ANSI B7.1

Bench and Pedestal Wheel Arbor Bushings

WHEEL DIAMETER	WHEEL CENTER HOLE	1/2"	5/8"	3/4"	7/8"	1"	1-1/4"
5", 6", 7"	1"	•	•	•	•		
8"	1"		•	•	•		
10"	1-1/4"			•	•	•	
12" x 2"	1-1/4"					•	
12" and 14"	1-1/2"					•	•

These size bushings shipped free of charge with your wheel order.



NEW

Best choice for deburring and tool sharpening on bench and pedestal grinders

PREMIUM CERAMIC ALUMINA 3SG

- Type 01 straight wheel with ceramic alumina grain has fast cut, minimal burn, and long wheel life
- High performance bond for versatility and exceptional form holding
- Especially great for hollow grinding of plane blades and chisels; telescoping bushings to fit popular arbor hole sizes



Better choice for light metal removal and sharpening of high-speed tool steels (55 Rc and higher)

PREMIUM WHITE ALUMINUM OXIDE

- Type 01 straight wheel with premium white aluminum oxide for maximum cut rate and cool grinding action on hardened or high-speed tool steels
- Vitrified bonded for superb shape holding and resistance to wear
- Better choice for deburring and tool sharpening on bench and pedestal grinders; telescoping bushings to fit popular arbor hole sizes



Better choice for light to medium stock removal

57A ALUMINUM OXIDE

- Type 01 straight wheel, the better choice for the end-user that needs a specific grit size and hardness for engineered applications
- Vitrified bond for superb shape holding and resistance to wear
- Excellent choice for deburring and tool sharpening on bench and pedestal grinders



Better choice for medium grit and grade for light to medium stock removal on carbide tooling and non-ferrous materials

39C SILICON CARBIDE

- Type 01 straight wheel with sharp, green silicon carbide; use for performance applications on carbide tooling and non-ferrous materials
- Vitrified bond for superb shape holding and resistance to wear
- Excellent choice for deburring and tool sharpening on bench and pedestal grinders



Good choice for all general-purpose bench and pedestal applications

GEMINI ALUMINUM OXIDE

- Type 01 straight wheel with quality, aluminum oxide for general purpose bench and pedestal grinder applications on steel
- Vitrified bond for superb shape holding and resistance to wear
- Good choice for deburring and tool sharpening on bench and pedestal grinders; telescoping bushings to fit popular arbor hole sizes



Good choice for all general-purpose bench and pedestal applications on non-ferrous materials and carbide tooling

GEMINI SILICON CARBIDE

- Type 01 straight wheel with sharp, green silicon carbide for general-purpose applications on carbide tooling and non-ferrous materials
- Vitrified bond for superb shape holding and resistance to wear
- Available in many sizes and coarse to fine grits; for sharpening to fine shaping applications



TIER:	BEST	BETTER	BETTER
TRADENAME:	PREMIUM CERAMIC ALUMINA	PREMIUM ALUMINUM OXIDE	57A
ABRASIVE:	3SG Ceramic Alumina	White Aluminum Oxide	Brown Aluminum Oxide

SIZE (D x T x H)	MAX. RPM	MIN./STD. PKG.	SPEC	PART #	SPEC	PART #	SPEC	PART #
6 x 3/4 x 1	4,140*	1/5	3SG-46K	076607 05411	Medium 60	076607 88246		
	4,140*	1/5	3SG-60I	076607 04684	Fine 100	076607 88247		
	4,140*	1/5	3SG-80K	076607 05412	Very Fine 150	076607 88248		
	4,140*	1/5	3SG-100I	076607 04682				
6 x 1 x 1	4,140*	1/5	3SG-46K	076607 05413	Medium 60	076607 88261		
	4,140*	1/5	3SG-80K	076607 05414	Fine 100	076607 88262		
	4,140	1/5			Very Fine 150	076607 88263		
8 x 1 x 1	3,600	1/5	3SG-46I	076607 04660	Medium 60	076607 88281		
	3,600	1/5	3SG-46K	076607 05421	Fine 100	076607 88282		
	3,600	1/5	3SG-60I	076607 04659	Very Fine 150	076607 88283		
	3,600	1/5	3SG-80K	076607 05422				
	3,600	1/5	3SG-100I	076607 04657				
10 x 1 x 1-1/4	2,485	1/5					57A46-MVBE	662531 16274
	2,485	1/5					57A60-MVBE	662531 16273
10 x 1-1/2 x 1-1/4	2,485	1/5					57A46-MVBE	662531 16280
12 x 1 x 1-1/4	2,070	1/5					57A46-MVBE	662532 20947
12 x 2 x 1-1/2	2,070	1/4					57A30-MVBE	662532 20951
	2,070	1/4					57A36-OVBE	662532 20952
	2,070	1/4					57A46-MVBE	662532 20953
	2,070	1/4					57A60-MVBE	662532 20955
	2,070	1/4					57A24-QVBE	662533 19972
14 x 2 x 1-1/2	1,800	1/3					57A36-OVBE	662533 19973
	1,800	1/3					57A46-MVBE	662533 19974
	1,800	1/3					57A24-QVBE	662533 19976
14 x 2-1/2 x 1-1/2	1,800	1/2					57A46-MVBE	662533 19975
	1,800	1/2					57A36-OVBE	662533 19977
18 x 3 x 1-1/2	1,275	1/2					57A24-QVBE	662534 62610

* Max. RPM for Premium Ceramic Alumina Wheels is 5,410

Bench and Pedestal Wheel Arbor Bushings

WHEEL DIAMETER	WHEEL CENTER HOLE	1/2"	5/8"	3/4"	7/8"	1"	1-1/4"
5", 6", 7"	1"	•	•	•	•		
8"	1"		•	•	•		
10"	1-1/4"			•	•	•	
12" x 2"	1-1/4"					•	
12" and 14"	1-1/2"					•	•

These size bushings shipped free of charge with your wheel order.



TIER: GOOD
TRADENAME: GEMINI ALUMINUM OXIDE
ABRASIVE: Brown Aluminum Oxide



TIER: GOOD
TRADENAME: 39C (GREEN) / 37C (GRAY)
ABRASIVE: Silicon Carbide



TIER: GOOD
TRADENAME: GEMINI SILICON CARBIDE
ABRASIVE: Green Silicon Carbide

SIZE (D x T x H)	MAX. RPM	MIN./STD. PKG.	SPEC	PART #	MIN./STD. PKG.	SPEC	PART #	MIN./STD. PKG.	SPEC	PART #
5 x 1/2 x 1	4,965	1/5	Medium 60/80	07660788202						
	4,965	1/5	Fine 100/120	07660788201						
5 x 3/4 x 1	4,965	1/5	Medium 60/80	07660788210						
	4,965	1/5	Fine 100/120	07660788205						
5 x 1 x 1	4,965	1/5	Medium 60/80	07660788225						
	6 x 1/2 x 1	4,140	1/5	Coarse 36/46	66252836132			1/5	Medium 60	66252836571
		4,140	1/5	Medium 60/80	66252836131			1/5	Fine 80	66252836572
6 x 3/4 x 1	4,140	1/5	Fine 100/120	66252836133			1/5	Extra Fine 120	66252836573	
	6 x 1 x 1	4,140	1/5	Coarse 36/46	07660788245			1/5	Medium 60	66252837190
		4,140	1/5	Medium 60/80	07660788240			1/5	Fine 80	66252837191
	4,140	1/5	Fine 100/120	07660788235			1/5	Extra Fine 120	66252837192	
7 x 1 x 1	4,140	1/5	Coarse 36/46	07660788260			1/5	Medium 60	66252837187	
	4,140	1/5	Medium 60/80	07660788255			1/5	Fine 80	66252837193	
	4,140	1/5	Fine 100/120	07660788250			1/5	Extra Fine 120	66252837194	
8 x 3/4 x 1	3,600	1/5	Coarse 36/46	07660788275			1/5	Medium 60	66252942300	
	3,600	1/5	Medium 60/80	07660788270			1/5	Fine 80	66252942301	
	3,600	1/5	Fine 100/120	07660788265			1/5	Extra Fine 120	66252942302	
8 x 1 x 1	3,600	1/5	Coarse 36/46	07660788278						
	3,600	1/5	Medium 60/80	07660788277						
	3,600	1/5	Fine 100/120	66253042317						
	3,600	1/5	Very Coarse 24	66253044454			1/5	Medium 60	66253044087	
10 x 1 x 1-1/4	3,600	1/5	Coarse 36/46	07660788286			1/5	Fine 80	66253044534	
	3,600	1/5	Medium 60/80	07660788285			1/5	Extra Fine 120	66253044535	
	3,600	1/5	Fine 100/120	07660788280						
	2,485	1/2	Very Coarse 24	66253160788	1/5	39C60-IVK	66253116262	1/2	Medium 60	66253144536
10 x 1-1/4 x 1-1/4	2,485	1/2	Coarse 36/46	07660788295						
	2,485	1/2	Medium 60/80	07660788290						
	2,485	1/2	Fine 100/120	66253160350						
	2,485	1/2	Coarse 36/46	66253161250						
10 x 1-1/2 x 1-1/4	2,485	1/2	Medium 60/80	66253161251						
	2,485	1/2	Coarse 36/46	66253161393	1/5	39C60-IVK	66253116265			
	2,485	1/2	Medium 60/80	66253161395						
12 x 1-1/2 x 1-1/2	2,070	1/2	Coarse 36/46	66253263052						
	2,070	1/2	Medium 60/80	66253263053						
12 x 2 x 1-1/4	2,070							1/2	Medium 60	66253263359
	2,070							1/2	Fine 80	66253263360
12 x 2 x 1-1/2	2,070	1/2	Very Coarse 24	66253263054						
	2,070	1/2	Coarse 36/46	66253263055						
	2,070	1/2	Medium 60/80	66253263056	1/4	39C60-KVK	66253220942			
14 x 2 x 1-1/2	1,800				1/3	37C24-RVK	66253319967			
	1,800				1/3	39C60-JVK	66253319968			

Bench and Pedestal Wheel Arbor Bushings

WHEEL DIAMETER	WHEEL CENTER HOLE	1/2"	5/8"	3/4"	7/8"	1"	1-1/4"
5", 6", 7"	1"	•	•	•	•		
8"	1"		•	•	•		
10"	1-1/4"			•	•	•	
12" x 2"	1-1/4"					•	
12" and 14"	1-1/2"					•	•

These size bushings shipped free of charge with your wheel order.



Keep circular saws, band saws and other cutting tools razor sharp when you use the NorZon NZ ZA Type 01 sawgumming wheel. Featuring a resin bond to provide a smooth performance and deliver exceptional strength, this hardy wheel is specially designed for use in timber industries and for woodworking and saw manufacturing applications. Ideal for frequent use, the wheel has a zirconia alumina abrasive that ensures sharp cuts while it enhances the wheel's durability.

- Applications:** Tool Sharpening
- Size Range:** 12"
- Abrasive Grain:** Zirconia Alumina
- Shape:** Type 01 Straight
- Machine Used:**



GUMMING
SAW

Best choice for saw sharpening in the timber, woodworking, and saw manufacturing industries



NORZON NZ ZIRCONIA ALUMINA

- Durable, sharp zirconia alumina abrasive delivering the highest performance under frequent use conditions
- Strong, yet smooth-running resin bond
- Designed to excel at shaping and resharpening various types of saws including large circular and band saw blades used primarily for timber harvesting

TIER: **BEST**
 TRADENAME: **NORZON NZ**
 ABRASIVE: Zirconia Alumina

SIZE (D x T x H)	MAX. RPM	STD. PKG.	SPEC	PART #
Type 01 Straight				
12 x 5/8 x 1-1/4	3,025	5	SG2981	662532 62303
12 x 3/4 x 1-1/4	3,025	5	SG2181	662532 62305
12 x 3/4 x 1-1/4	3,025	5	SG2981	662532 62306
12 x 3/4 x 1-1/4	3,025	5	SG2981	662532 62307
12 x 7/8 x 1-1/4	3,025	5	SG2981	662532 62462
12 x 7/8 x 1-1/4	3,025	5	SG2181	662532 62461
12 x 1 x 1-1/4	3,025	5	SG2981	662532 62487 NS

NS Non-stock, Contact your Norton representative for current order quantities and lead-times.



Used on surface, cylindrical, and tool and cutter grinders, Norton precision, form-holding vitrified toolroom wheels maximize your productivity. Available in latest-generation ceramic alumina, aluminum oxide, and silicon carbide – for every ferrous and non-ferrous MRO, small job shop, and production operation.

- Applications:** Surface grinding, tool and cutter grinding, and sharpening
- Shapes:** Type 01 Straight, Type 02 Cylinder, Type 05 and 07 Recessed 1 and 2 Sides, Type 06 and 11 Straight and Flaring Cups, Type 12 Dish, Type 20 Concaved 1 Side, and Type 35 Plate Mounted Disc
- Size Range:** 3/4" – 18" diameter
- Grit Range:** 46 – 220
- Abrasive Grain:** Ceramic Alumina, Aluminum Oxide, Silicon Carbide

Material-to-Product Recommendation Guide

APPLICATION / MATERIAL	PERFORMANCE/PRODUCTIVITY								
	Narrow Contact Area			Medium Contact Area			Wide Contact Area		
	BEST	BETTER	GOOD	BEST	BETTER	GOOD	BEST	BETTER	GOOD
Tool Resharpener									
Heavy Stock Removal (> .004)									
HSS & Tool Steel RC 50-68	5SG46-KVS	32A46-KVBE	38A46-KVBE	5SG46-JVS	32A46-JVBE	38A46-JVBE	5SG46-GVSP 3SGR46-GVP2	32A46-GVBEP 48A46-GVP2	38A46-GVBEP 38A46-GVP2
Moderate Stock Removal (.002-.004)									
HSS & Tool Steel RC 50-68	5SG60-KVS	32A60-KVBE	38A60-KVBE	5SG60-JVS	32A60-JVBE	38A60-JVBE	5SG60-GVSP 3SGR60-GVP2	32A60-GVBEP 48A60-GVP2	38A60-GVBEP
Carbide			39C60-JVK			39C60-JVK			
Surface Grinding									
Heavy Stock Removal (> .004)									
HSS & Tool Steel RC 50-68	5NQ46-JVS	32A46-JVBE	38A46-JVBE	5SG46-IVS	32A46-IVBE	38A46-IVBE	5SG46-GVSP 3SGR46-GVP2	32A46-GVBEP 48A46-GVP2	38A46-GVBEP 38A46-GVP2
400 Series Stainless									
Soft Steels RC 30-45	5SG46-KVS	32A46-KVBE	38A46-KVBE	5SG46-JVS	32A46-JVBE	38A46-JVBE	5SG46-HVSP 3SGR46-HVP2	32A46-HVBEP 48A46-HVP2	38A46-HVBEP 38A46-HVP2
300 Series Stainless									
Cast Iron: Ductile & Gray	5SG46-KVS	32A46-KVBE	38A46-KVBE	5SG46-JVS	32A46-JVBE	38A46-JVBE	5SG46-HVSP 3SGR46-GVP2	32A46-HVBEP 48A46-HVP2	38A46-HVBEP 38A46-HVP2
Non-ferrous Alloys			39C46-JVK			39C46-IVK			
Moderate Stock Removal (.002-.004)									
HSS & Tool Steel RC 50-68	5NQ60-JVS	32A60-JVBE	38A60-JVBE	5SG60-IVS	32A60-IVBE	38A60-IVBE	5SG60-GVSP 3SGR60-GVP2	32A60-GVBEP 48A60-GVP2	38A60-GVBEP
400 Series Stainless									
Soft Steels RC 30-45	5SG60-KVS	32A60-KVBE	38A60-KVBE	5SG60-JVS	32A60-JVBE	38A60-JVBE	3SGR60-HVP2	32A60-HVBEP 48A60-HVP2	38A60-HVBEP 38A60-HVP2
300 Series Stainless									
Cast Iron: Ductile & Gray	5SG60-KVS	32A60-KVBE	38A60-KVBE	5SG60-JVS	32A60-JVBE	38A60-JVBE	3SGR60-HVP2	32A60-HVBEP 48A60-HVP2	38A60-HVBEP 38A60-HVP2
Non-ferrous Alloys			39C60-JVK			39C60-IVK			
Light Stock Removal and Finishing (<.001)									
HSS & Tool Steel RC 50-68		32A80-JVBE	38A80-JVBE		32A80-IVBE	38A80-IVBE		32A80-HVBE	38A80-HVBE
400 Series Stainless									
Soft Steels RC 30-45		32A80-KVBE	38A80-KVBE		32A80-JVBE	38A80-JVBE		32A80-IVBE	38A80-IVBE
300 Series Stainless									
Cast Iron: Ductile & Gray		32A80-KVBE	38A80-KVBE		32A80-JVBE	38A80-JVBE		32A80-IVBE	38A80-IVBE
Nonferrous Alloys			39C80-JVK			39C80-IVK			39C80-HVK

Upgrade to Vitrium³ to improve your process and productivity in 3 ways

Vitrium³ bond (VS3) wheels for enhanced-performance are available with these abrasives: NQ, SG, 32A, and 48A

<p>1. COOL CUTTING</p> <p>VITRIUM³ BOND BOND-PART INTERACTION</p> <p>Improved holding power (using less bond-to-abrasive ratio) exposes a larger grain surface area, improving free cut rate.</p>	<p>2. PRECISE PROFILE</p> <p>VITRIUM³ WHEEL AFTER 5 GRINDING CYCLES</p> <p>Superior grain-holding properties significantly improve wheel form and corner holding vs. other bond systems – reducing dressing time and dresser wear.</p>	<p>3. HIGH SPEED</p> <p>High Speed – Norton Vitrium³ bond provides the ultimate wheel strength. This allows for high speed operation on equipment designed and rated for high speed.</p>
---	--	--

Vitrified Wheel Bonds

Bond	Description
VS3	Quantum (white) and Norton SG (white): Patented technology produces a strong, exceptionally cool-cutting bond with unprecedented form holding; able to run at higher operating speed; increased throughput and productivity; versatile, for all areas of contact
VS3P	Quantum (white) Norton SG (white): Porous bond; use where heat is an issue; patented technology produces a strong, exceptionally cool-cutting bond with unprecedented form holding; versatile, for all areas of contact
VS	Quantum (green) and Norton SG (blue): High stock removal; narrow/medium contact area; roughing/finishing; cool cutting
VSP	Quantum (green) and Norton SG (blue): Porous bond; use where heat is an issue; high stock removal; medium/wide contact area; cool cutting; high chip clearance
VBE	32A (purple), 38A (white) and 57A (brown): General purpose; narrow/medium contact area; versatile; economical.
VBEP	32A (purple) and 38A (white): Porous bond; use where heat is an issue; medium/wide contact area; cool cutting; high chip clearance; high stock removal
V	38A (orange): For fine grit, form/corner holding applications; narrow contact area
VK	37C (black) and 39C (green): Designed specifically for silicon carbide abrasives; medium to narrow area of contact ; for non-steel applications
VCP	32A (purple) and 23A (blue/grey): Induced-pore, wide contact area, surface/creepfeed grinding applications
VP2	3SGR (ruby), 48A (ruby), 25A (pink) and 38A (white): Unique, controlled-porosity (NORPOR) bond for heat-sensitive applications

TECH TIP

SELECTING A WHEEL WITH THE CORRECT BOND TYPE

- Use VBE, V, VS, VS3, and VK bonds for general purpose applications or medium contact areas.
- Use VBEP, VSP, VS3P, VCP, and VP2 bonds on wide contact areas where heat is an issue.



It is the user's responsibility to refer to and comply with ANSI B7.1

Application/Grit Recommendation Guide

Grit	Requirement	Finish	Minimum Corner Radius
46	General Purpose	32 Ra and rougher	0.020"
60	Commercial Finish	32 Ra and better	0.016"
80 – 100	Fine Finish	20 Ra and better	0.0105"
120	Very Fine Finish	10 Ra and better	0.006"
150	Corner-Form Holding		0.005"
180	Corner-Form Holding		0.0035"
220	Corner-Form Holding		0.0026"

Cross Reference Guide

NORTON	CAMEL	CINCINNATI	RADIAC	TYROLIT	WINTERTHUR
Quantum 5NQ	—	5M5B	—	—	—
3SGR	AS3	3BP	7BP, 8BP	—	—
5SG	SZA	5MSB	7BW, 8BW	—	—
25A	PA	12A	RAA	88A	57A
32A	AZ	4A, 12A, 29A, 32A	32A, WRA	90A	67A, 68A
38A	83A, WA, AZ (Blue)	9A, 10A, 11A, 82A	WA, 9A	88A, 89A	53A, 49A, 42A
48A	—	—	RA	91A	68A
53A	91A, DA	29A, 97A	43A, 45A, 97A, WPA	50A	61A, 64A
57A	94A, CGW, A	A, AK	A	A, 52A	A
37C	—	6C	C	1C	C
39C	—	5C	GC	C	11C

Starting Recommendations for Truing and Dressing Norton Toolroom Wheels

TRUING & DRESSING: DRESSING STICK STARTING RECOMMENDATIONS

Size/ Spec.	High Performance Stick Part #	Size/ Spec.	Conventional Stick Part #
3 x 1/2 x 1/4" Norbide	614636 10148	6 x 1 x 1" 37C24-SVK	614636 10462
		8 x 1 x 1" 37C24-SVK	614636 10471
Other sizes are available. See the Dressing Stick section.			

DRESSING: SINGLE POINT DRESSING TOOL STARTING RECOMMENDATIONS

		Ceramic (NQ, Norton SG, TG, Etc.), 37C & 39C Wheels		25A, 32A, 38A, 48A, 53A, 57A, 64A, 86A Wheels	
Wheel Sizes	Tool Shank Diameter	Product No.	Part #	Product No.	Part #
Up to 7"	3/8	BCSG2M6	662601 57007	BC2M6	662601 95000
	7/16	BCSG2M7	662601 56905	BC2M7	662601 95001
8" to 10"	3/8	BCSG3M6	662601 57008	BC3M6	662601 95002
	7/16	BCSG3M7	662601 56906	BC3M7	662601 95003
12" to 14"	3/8	BCSG5M6	662601 57009	BC5M6	662601 95004
	7/16	BCSG5M7	662601 56907	BC5M7	662601 95005

These tools are a standard recommendation; see the "Diamond Tool" section for additional tools
See the Fliesen Tool section for Furioso tools, engineered specifically for Quantum vitrified wheel dressing

TECH TIP

Wheel Dressing

Single Point Diamond Tools

- Rigidly mount Single Point tools at a 10°-15° angle to the wheel centerline with a line drawn through the center of the wheel, pointing in the direction of wheel travel
- Point of contact should be slightly below centerline of wheel
- Use coolant whenever possible
- Normal infeed is .001" per pass
- Lead selections range from .002" - .010" per wheel revolution
- Rotate the tool 1/4 turn periodically to maintain a sharp point
- Use VBE, V, VS, VK bonds for general purpose applications or medium contact areas.
- Use VBEP, VSP, VS3P, VCP, VP2 bonds on wide contact areas where heat is an issue.

Multi-Point Diamond Tools

- Most multi-point tools are used for straight face dressing
- Tool should have full face contact with the wheel
- With new tool, 3 to 5 passes at .005" per pass should be taken to expose diamonds
- Infeed per pass .001" - .002"
- Use coolant whenever possible
- Use appropriate lead (and traverse rate)

Contact your Norton representative for proper tool selection for Targa (TG) wheels



It is the user's responsibility to refer to and comply with ANSI B7.1

Dressing Ceramic Wheels

- Use our specially designed Norton SG diamond tools when dressing ceramic wheels
- When first using a Norton SG tool, make 3 to 5 passes at .005" infeed to ensure full face contact between the dressing tool and wheel face
- Reduce normal dressing infeed by half. Do not exceed infeed of .002" per pass.
- The lead selection should be between .006" - .030" per wheel revolution. Faster traverse with Norton SG tools generally provides an open wheel face that can maximize productivity of the ceramic abrasive.
- To optimize applications using ceramic abrasives and/or tools, normal dressing parameters must change. Reduce infeed by 25%. Significant reductions in the amount of infeed and frequency of dress will result in substantially lower cost per part ground.
- See the Fliesen Tool section for Furioso tools, engineered specifically for Quantum vitrified wheel dressing.



Single-Pack Toolroom Wheels

The Small Quantity Order Solution

Available in our most popular specification of BEST, BETTER and GOOD performance tiers. Norton single-pack toolroom wheels provide many opportunities:

- Test order small quantities of a variety of wheel specifications
- Display and safely store your most often used wheels
- No need to repackage small orders from bulk shipments
- Ensure your wheel arrives on site undamaged

Troubleshooting Guide

Check the obvious first. Before changing the grinding wheel specification, investigate the following most common causes for most grinding problems:

1. Diamond dressing tool condition (check if worn or dull, rotate tool or replace if necessary)
2. Coolant direction, volume and filtration
3. Wheel dressing procedures (dress more open to free up cut rate, dress more closed to improve finish)

PROBLEM	POSSIBLE CAUSE	CORRECTION
Workpiece burn	Poor coolant direction	Redirect coolant into grinding zone
	Restricted or low coolant volume	Increase coolant volume
	Wheel too hard	Use one grade softer wheel
	Wheel structure too closed	Use porous bond wheel
	Wheel dressed too fine	Dress wheel coarser, more "open"
	Worn dressing tool	Inspect, rotate or replace dressing tool
	Work speed too slow	Increase work speed
	Infeed too fast	Reduce stock removed per pass or upgrade to 5SG or 5NQ
Wheel loading and glazing	Wheel too fine	Use coarser grit or softer grade wheel
	Wheel too hard	Use one grade softer wheel
	Too durable abrasive	Use a sharper, more friable abrasive
	Poor coolant quality	Change coolant or use high detergent type
	Wheel structure too closed	Use a porous bond wheel
	Wheel too finely dressed	Dress wheel very open
	Diamond dressing tool worn	Replace diamond and dress coarse (open)
Chatter	Depth of cut too small	Increase feed and traverse speed
	Unsupported work	Increase work support
	Machine vibration	Check for worn bearings
	Too heavy cut rate	Reduce cut rate
	Wheel too hard	Use one grade softer wheel
	Wheel structure too closed	Use a porous bond wheel
Chatter marks on workpiece	Wheel out of balance	Check wheel balance or try new wheel
	Worn spindle bearings	Check and correct for truth and end play
	Wheel out of truth	Redress wheel and check mounting
	Poorly clamped wheel	Check tightness of mounting nuts
Poor surface finish	Glazed face of wheel	Redress wheel with sharp dressing tool
	Incorrect wheel dress	Dress wheel finer (slow down dressing tool traverse)
	Worn dressing tool	Inspect, rotate, or replace dressing tool
	Too coarse grit size	Use a finer grit size
	Wheel too hard	Use softer grade
Not holding form	Wheel too soft	Use one grade harder wheel
	Wheel structure too open	Use a more closed wheel structure
Not holding corner	Incorrect wheel dress	Dress wheel finer. Face and side true wheel.
	Too large grit size	Use smaller grit size (maximum grit diameter less than 1.5 times corner radius)
	Wheel too soft	Use harder grade wheel
	Wheel structure too open	Use more closed structure wheel

Best choice for versatility, maximum performance and cost savings



QUANTUM (5NQ) CERAMIC ALUMINA

- Revolutionary, proprietary, engineered ceramic grain shape and chemistry for all low-, medium- and high-force applications ranging from cast iron, to stainless steel, and hard-to-grind Inconel and titanium
- Proven tough vitrified bond stands up to extreme grinding forces; perform well on old and new CNC cutting tool, cylindrical and surface grinding machines
- 33% to 100% longer life, 30% higher MRR (material removal rate), and 15% lower threshold power versus competitive ceramic products

Best choice for high productivity, low total per-part grinding cost



SG CERAMIC ALUMINA

- Exceptionally high-performance ceramic alumina and friable aluminum oxide abrasive blend for fast stock removal, cool, superior cutting; 3 - 5 times more life than aluminum oxide wheels; double rough stock removal rate versus conventional abrasives
- High performance bond for versatility (for grinding high speed tool steels, hardened and soft steels, and aerospace alloys) and exceptional form holding
- Self-sharpening abrasive minimizes burn and dressing to maximize sharp edge on tools and dies for longer life in production

Better choice for medium-to-heavy stock removal



32A ALUMINUM OXIDE

- Strong, sharp monocrystalline aluminum oxide grain, ideal for precision production medium-to-heavy stock removal applications
- The most versatile vitrified bond, especially recommended for CNC cutting tool machines, and cylindrical and surface grinding
- Grinds with an exceptional cool, fast cutting action, requires minimum dressing

Good choice for light grinding of tool steel



38A ALUMINUM OXIDE

- Friable aluminum oxide abrasive for cool and burn-free cutting toolroom applications with light-to-moderate feed rates
- The most versatile vitrified bond, especially recommended for CNC cutting tool machines, and cylindrical and surface grinding applications on hard and very heat-sensitive high-speed tool steels; cool fast cutting
- Consistent quality for excellent balance and dimensional accuracy time after time

Good choice for use on general-purpose applications; economical



GEMINI ALUMINUM OXIDE

- Specially blended aluminum oxide abrasive for many surface and cylindrical grinding applications
- Durable vitrified bond for high stock removal on narrow to medium contact areas
- Good general-purpose choice when a broad range of parts are ground on one machine

Vitrified Wheels For Steel Applications



TIER: BEST	TIER: BETTER	TIER: GOOD
TRADENAME: QUANTUM / NORTON SG	TRADENAME: 32A	TRADENAME: 38A
ABRASIVE: Ceramic Alumina	ABRASIVE: Aluminum Oxide	ABRASIVE: Aluminum Oxide

SIZE (D x T x H)	MAX. RPM	MIN./STD. PKG.	SPEC.	PART #	SPEC.	PART #	MIN./STD. PKG.	SPEC.	PART #
Type O1 Straight									
2 x 1/2 x 3/8	16,235	10/50			32A60-KVBE	662434 28214			
3 x 1/4 x 1/2	10,825	10/50			32A60-KVBE	662435 28696			
3 x 1/2 x 3/8	10,825	10/50			32A60-KVBE	662435 28825	10/50	38A60-JVBE	662435 29032
3 x 1/2 x 1/2	10,825	10/50			32A60-KVBE	662435 28828			
3 x 1 x 1/2	10,825						10/10	38A60-MVBE	662435 29145
	10,825						10/10	38A80-MVBE	662435 29146
4 x 1/4 x 1/2	8,120	1/10			32A60-KVBE	662435 29532	1/10	38A60-KVBE	662435 29777
	8,120						1/10	38A100-IVBE	662435 29782
4 x 1/4 x 3/4	8,120	1/10			32A60-KVBE	662435 29736			
4 x 1/2 x 1/2	8,120						1/10	38A60-KVBE	662435 29947
	8,120						1/10	38A100-KVBE	662435 29954
4 x 1/2 x 3/4	8,120	1/10			32A60-KVBE	662435 29849	1/10	38A60-KVBE	662435 29961
	8,120	1/10			32A80-KVBE	662435 29850			
4 x 1 x 1/2	8,120						1/10	38A60-MVBE	662435 30126
6 x 1/8 x 1-1/4	4,140	1/10			32A80-KVBE	662528 35361	1/10	38A150-LVBE	662528 35506
6 x 1/4 x 1/2	4,140	1/10			32A60-KVBE	662528 35784			
6 x 1/4 x 1-1/4	4,140	1/10			32A60-KVBE	662528 35786	1/10	38A60-KVBE	662528 35803
	4,140						1/10	38A80-KVBE	662528 35807
	4,140						1/10	38A150-KV	662528 35759
6 x 1/2 x 1/2	4,140	1/10			32A60-KVBE	662528 36394	1/10	38A60-KVBE	662528 36530
	4,140						1/10	38A80-KVBE	662528 36548
6 x 1/2 x 1-1/4	4,140	1/10			32A46-KVBE	662528 36380	1/10	38A46-KVBE	662528 36520
	4,140	1/10	5SG60-KVS	662528 03344	32A60-KVBE	662528 36396 B	1/10	38A60-KVBE	662528 36533
	4,140	1/10			32A80-JVBE	662528 36405	1/10	38A80-KVBE	662528 36550
	4,140						1/10	38A120-KVBE	662528 36664
6 x 3/4 x 1/2	4,140	1/10			32A60-KVBE	662528 37420			
6 x 3/4 x 5/8	4,140						1/10	38A60-KVBE	662528 37444
6 x 3/4 x 1-1/4	4,140	1/10			32A60-KVBE	662528 37421	1/10	38A60-KVBE	662528 37445
6 x 1 x 1-1/4	4,140	1/10			32A60-KVBE	662528 37921 B			
7 x 1/8 x 1-1/4	3,275	1/10			32A60-IVBE	662529 39112	1/10	38A80-IVBE	662529 39219
	3,600						1/10	38A100-KVBE	662529 39223
7 x 1/4 x 1-1/4	3,600	1/10			32A46-HVBE	662529 39543	1/10	38A46-HVBE	662529 39690
	3,600	1/10	5NQ46-IVS3	662434 95257	32A46-IVBE	662529 39544	1/10	38A46-IVBE	662529 39691
	3,600	1/10	5NQ60-JVS	662532 93579	32A46-JVBE	662529 39545	1/10	38A46-JVBE	662529 09755
	3,600	1/10	5NQ60-JVS3	662434 95258	32A46-KVBE	662529 39862	1/10	38A60-HVBE	662529 39695
	3,600	1/10	5SG46-IVS	662529 40207 B	32A60-HVBE	662529 39547	1/10	38A60-IVBE	662529 39696
	3,600	1/10			32A60-IVBE	662529 39548 B	1/10	38A60-JVBE	662529 39698
	3,600	1/10	5SG60-IVS	662529 39459 B	32A60-IVBE	662532 88569 S	1/10	38A60-KVBE	662529 39700
	3,600	1/10			32A60-JVBE	662529 39549 B	1/10	38A80-HVBE	662529 39707
	3,600	1/10			32A60-KVBE	662529 39552 B	1/10	38A80-IVBE	662529 39808
	3,600	1/10	5SG60-JVS	662529 39460	32A60-KVBE	662532 88570 S	1/10	38A80-JVBE	662529 39809
	3,600	1/10	5SG60-KVS	662529 39461 B			1/10	38A80-KVBE	662529 39812
	3,600	1/10			32A80-HVBE	662529 39557	1/10	38A100-IVBE	662529 39823
	3,600	1/10	5SG80-IVS	662529 39462	32A80-IVBE	662529 39658 B			
	3,600	1/10	5SG80-JVS	662529 39463	32A80-IVBE	662532 88571 S	1/10	38A100-JVBE	662529 39826
	3,600	1/10	5SG80-KVS	662529 39464	32A80-JVBE	662529 39660 B	1/10	38A100-KVBE	662529 39827
	3,600	1/10	5SG100-JVS	662529 39467	32A80-KVBE	662529 39662 B	1/10	38A100-LVBE	662529 39830
	3,600	1/10	5SG100-KVS	662529 39468 B	32A80-KVBE	662532 88572 S	1/10	38A120-JVBE	662529 39833
	3,600	1/10					1/10	38A120-KVBE	662529 39834
	3,600	1/10			32A100-IVBE	662529 39670 B	1/10	38A150-KVBE	662529 39838
	3,600	1/10			32A100-JVBE	662529 39672	1/10	38A150-LVBE	662529 39839
	3,600	1/10			32A100-IVBE	662532 88573 S	1/10	38A150-MV	662529 39521
	3,600	1/10			32A100-KVBE	662529 39673 B	1/10	38A220-KV	662529 39528
	3,600	1/10					1/10	38A220-LV	662529 39529
	3,600	1/10			32A120-IVBE	662529 39680	1/10	38A220-LVBE	662529 39847
	3,600	1/10			32A120-KVBE	662529 39682	1/10	38A220-MV	662529 39530
	3,600	1/10			32A220-LVBE	662529 39689			
7 x 3/8 x 1-1/4	3,600	1/10			32A60-KVBE	662529 40276	1/10	38A60-KVBE	662529 40294
	3,600	1/10			32A80-KVBE	662529 40284	1/10	38A80-IVBE	662529 40297

B Best Seller; performs well in a variety of applications for many satisfied customers
S Single Pack

Continued

Vitrified Wheels For Steel Applications *continued*



TIER: **BEST** **QUANTUM / NORTON SG** **BETTER** **32A / 48A**
 TRADENAME: Ceramic Alumina Aluminum Oxide
 ABRASIVE: Ceramic Alumina Aluminum Oxide

GOOD **38A / 25A / GEMINI**
 Aluminum Oxide

SIZE (D x T x H)	MAX. RPM	MIN./STD. PKG.	SPEC.	PART #	SPEC.	PART #	MIN./STD. PKG.	SPEC.	PART #
Type O1 Straight									
7 x 1/2 x 1-1/4	3,600	1/10	5NQ46-HVS3	662533 75053	32A46-FVBEP	662529 41203	1/10	25A46-HVP2	662529 16219
	3,600	1/10	5NQ46-IVS	69083 159103	32A46-GVBE	662529 40862	1/10	25A60-HVP2	662529 16221
	3,600	1/10	5NQ46-IVS3	662533 75052	32A46-GVBEP	662529 41204 B	1/10	38A46-GVBE	662529 41022
	3,600	1/10	5NQ46-JVS	69083 159104	32A46-HVBE	662529 40863 B	1/10	38A46-GVBEP	662529 41323
	3,600	1/10	5NQ60-GVSP	69083 159105	32A46-HVBE	662532 88775 S	1/10	38A46-HVBE	662529 41023
	3,600	1/10	5NQ60-IVS3	662533 75047	32A46-HVBEP	662529 41205 B			
	3,600	1/10	5NQ60-JVS	69083 159106	32A46-HVS3	662434 94107	1/10	38A46-HVBEP	662529 41324
	3,600	1/10	5NQ60-JVS3	662533 75046	32A46-IVBE	662529 40864 B	1/10	38A46-HVP2	662529 16223
	3,600	1/10	3SGP46-GVSP	662529 11717	32A46-IVBE	662532 88776 S	1/10	38A46-IVBE	662529 41024
	3,600	1/10	3SGR46-HVP2	662529 16211	32A46-IVBEP	662529 41206	1/10	38A46-JVBE	662529 41026
	3,600	1/10	3SGR60-HVP2	662529 16213	32A46-IVS3	662434 95357	1	38A46-JVBE	662532 88767 S
	3,600	1/10	5SG46-GVSP	662529 40522	32A46-JVBE	662529 40865 B	1/10	38A46-KVBE	662529 41028
	3,600	1/10	5SG46-HVS3	662533 75050	32A46-JVBE	662532 88777 S	1/10	38A60-HVBE	662529 41035
	3,600	1/10	5SG46-HVSP	662529 41130			1/10	38A60-HVBEP	662529 41330
	3,600	1/10	5SG46-IVS	662529 40193 B	32A46-KVBE	662529 40867 B	1/10	38A60-IVBE	662529 41036
	3,600	1/10	5SG46-IVS	662532 88788 S			1/10	38A60-JVBE	662529 41038
	3,600	1/10			32A54-IVBE	662529 40873	1	38A60-JVBE	662532 88766 S
	3,600	1/10	5SG46-IVSP	662529 40523	32A60-GVBEP	662529 41313	1/10	38A60-KVBE	662529 41041
	3,600	1/10	5SG46-JVS	662529 40194 B	32A60-HVBE	662529 40879 B	1	38A60-KVBE	662532 88769 S
	3,600	1/10	5SG46-JVS	662532 88789 S	32A60-HVBEP	662529 41314	1/10	38A60-LVBE	662529 11677
	3,600	1/10	5SG46-JVS3	662434 95263	32A60-IVBE	662529 40880 B	1/10	38A80-HVBE	662529 41047
	3,600	1/10	5SG46-KVS	662529 40195	32A60-IVBE	662532 88779 S	1/10	38A80-IVBE	662529 41048
	3,600	1/10	5SG60-GVSP	662529 40524	32A60-IVS3	662434 95363	1/10	38A80-JVBE	662529 41049
	3,600	1/10	5SG60-IVS	662529 40196 B	32A60-JVBE	662529 40882 B	1/10	38A80-KVBE	662529 41054
	3,600	1/10			32A60-JVBEP	662529 41316	1	38A80-KVBE	662533 50641 S
	3,600	1/10			32A60-JVS3	662434 95364	1/10	38A80-LVBE	662529 41056
	3,600	1/10	5SG60-IVSP	662529 40525	32A60-KVBE	662529 40885 B	1/10	38A100-IVBE	662529 41163
	3,600	1/10	5SG60-JVS	662529 40197 B	32A60-KVBE	662532 88782 S	1/10	38A100-JVBE	662529 41165
	3,600	1/10			32A60-LVBE	662529 40888	1/10	38A100-KVBE	662529 41168
	3,600	1/10	5SG60-JVS3	662533 75043	32A80-HVBE	662529 40894	1/10	38A120-JVBE	662529 41174
	3,600	1/10	5SG60-KVS	662529 40198	32A80-IVBE	662529 40895 B	1/10	38A120-KVBE	662529 41175
	3,600	1/10	5SG60-LVS	662529 40199	32A80-IVBE	662532 88783 S	1/10	38A150-JVBE	662529 41179
	3,600	1/10	5SG80-IVS	662529 40200	32A80-JVBE	662529 40897 B	1/10	38A150-MV	662529 40595
	3,600	1/10	5SG80-IVSP	662529 40527	32A80-KVBE	662529 40899 B	1/10	38A220-QV	662529 40605
	3,600	1/10	5SG80-JVS	662529 40201 B	32A80-KVBE	662532 88784 S			
	3,600	1/10			32A80-LVBE	662529 40900	10/10	Gemini 46-I	662532 46800
	3,600	1/10	5SG80-KVS	662529 40202	32A100-IVBE	662529 40907	10/10	Gemini 46-J	662532 46802
	3,600	1/10	5SG80-LVS	662529 40203	32A100-JVBE	662529 41008			
	3,600	1/10	5SG100-JVS	662529 40204	32A120-LVBE	662529 41018 B			
	3,600	1/10	5SG100-KVS	662529 40205	32A120-LVBE	662532 88786 S			
	3,600	1/10			48A46-HVP2	662529 16215 B	10/10	Gemini 60-K	662532 46821
	3,600	1/10			48A60-HVP2	662529 16217 B			
	3,600	1/10			32A60-IVBE	662529 41762			
7 x 5/8 x 1-1/4	3,600	1/10	5SG46-IVS	662529 42304	32A46-GVBEP	662529 42070	1/10	38A46-HVBE	662529 41950
7 x 3/4 x 1-1/4	3,600	1/10	5SG46-KVS	662529 42305	32A46-HVBE	662529 41930	1/10	38A46-KVBE	662529 41954
	3,600	1/10	5SG60-JVS	662529 42307	32A46-IVBE	662529 41931	1/10	38A60-IVBE	662529 42207
	3,600	1/10	5SG60-KVS	662529 42308	32A46-KVBE	662529 41935	1/10	38A60-KVBE	662529 42060
	3,600	1/10			32A60-IVBE	662529 41938			
	3,600	1/10			32A60-KVBE	662529 41943			
	3,600	1/10			32A80-IVBE	662529 41946			
7 x 1 x 1-1/4	3,600	1/10	5SG60-JVS	662529 42429	32A46-HVBE	662529 42513	1/10	38A46-HVBE	662529 42534
	3,600	1/10	5SG60-KVS	662529 42430	32A46-JVBE	662529 42268			
	3,600	1/10			32A60-IVBE	662529 42524			
	3,600	1/10			32A60-KVBE	662529 42709			

B Best Seller; performs well in a variety of applications for many satisfied customers
S Single Pack

For non-stock toolroom wheels: if you don't see the toolroom wheel you need in our stock listing, call your local authorized Norton distributor to check our made-to-order non-stock availability – including our revolutionary new Quantum ceramic and Vitrium³ bond wheels.

Vitrified Wheels For Steel Applications *continued*



TIER: **BEST** **QUANTUM / NORTON SG** **BETTER** **32A / 48A**
 TRADENAME: **QUANTUM / NORTON SG** **32A / 48A**
 ABRASIVE: Ceramic Alumina Aluminum Oxide

GOOD **38A / 25A / GEMINI**
 Aluminum Oxide

SIZE (D x T x H)	MAX. RPM	MIN./STD. PKG.	SPEC.	PART #	SPEC.	PART #	MIN./STD. PKG.	SPEC.	PART #
Type O1 Straight									
8 x 1/4 x 1-1/4	3,105 / 3,600*	1/10	5SG60-KVS	662530 43351 *	32A46-HVBE	662530 43412	1/10	38A60-IVBE	662530 43431 *
	3,105 / 3,600*	1/10	5SG80-KVS	662530 43353 *	32A46-IVBE	662530 43310	1/10	38A60-JVBE	662530 43432 *
	3,600	1/10			32A46-KVBE	662530 43413	1/10	38A60-KVBE	662530 10825
	3,600	1/10			32A60-IVBE	662530 43416 B	1/10	38A80-IVBE	662530 43437
	3,600	1/10			32A60-IVBE	662532 88796 S	1/10	38A80-JVBE	662530 43439
	3,600	1/10			32A60-JVBE	662530 43417	1/10	38A80-KVBE	662530 43461
	3,600	1/10			32A60-KVBE	662530 43399	1/10	38A100-IVBE	662530 43445
	3,600	1/10			32A80-IVBE	662530 43421	1/10	38A100-KVBE	662530 43447
	3,600	1/10			32A80-KVBE	662530 43458 B	1/10	38A120-KVBE	662530 43450
	3,600	1/10			32A80-KVBE	662532 88797 S	1/10	38A150-KVBE	662530 43451
	3,600	1/10			32A80-LVBE	662530 43425			
	3,600	1/10			32A100-IVBE	662530 43426			
	3,600	1/10			32A100-KVBE	662530 43428			
	8 x 3/8 x 1-1/4	3,600	1/10			32A60-KVBE	662530 43565		
8 x 1/2 x 1-1/4	3,105 / 3,600*	1/10	5NQ46-HVS3	662533 87211	32A46-GVBEP	662530 43882 B	1/10	25A46-HVP2	662530 19354 *
	3,105	1/10	5NQ46-IVS	690831 59107	32A46-HVBE	662530 43712 B	1/10	38A46-HVBE	662530 43746
	3,105	1/10	5NQ46-IVS3	662533 87212	32A46-HVBE	662532 88800 S			
	3,105 / 3,600*	1/10	5NQ46-JVS	690831 59108 *	32A46-HVBEP	662530 43883 *† B	1/10	38A46-HVBEP	662530 43891 †
	3,105	1/10					1/10	38A46-IVBE	662530 43749
	3,105 / 3,600*	1/10	5NQ60-GVSP	690831 59109			1/10	38A46-JVBE	662530 43752 *
	3,105 / 3,600*	1/10	5NQ60-IVS3	662533 87214 *	32A46-IVBE	662530 43713 B	1/10	38A46-KVBE	662530 43762 *
	3,600	1/10	5NQ60-JVS	690831 59110			1/10	38A60-HVBE	662530 43756
	3,600	1/10	5NQ60-JVS3	662533 87213	32A46-JVBE	662530 43715 B	1/10	38A60-IVBE	662530 43757
	3,105 / 3,600*	1/10	3SGP46-HVSP	662530 11505	32A46-JVBE	662532 88801 * S	1/10	38A60-JVBE	662530 43858 *
	3,600	1/10	3SGP46-JVH	662530 13796	32A46-JVS3	662434 95314	1/10	38A60-KVBE	662530 43861
	3,600	1/10	3SGR46-GVP2	662530 19345	32A46-KVBE	662530 43716 B	1/10	38A80-IVBE	662530 43866
	3,600	1/10	3SGR46-HVP2	662530 19346			1/10	38A80-JVBE	662530 13787
	3,600	1/10	3SGR60-HVP2	662530 19348	32A60-GVBEP	662530 43887 †	1/10	38A80-KVBE	662530 43869
	3,105 / 3,600*	1/10	5SG46-GVSP	662530 43649	32A60-HVBE	662530 43724 *	1/10	38A100-KVBE	662530 43877 *
	3,600	1/10			32A60-HVBEP	662530 43888	10/10	Gemini 46-H	662532 46841 *
	3,105 / 3,600*	1/10	5SG46-HVSP	662530 43915 *†	32A60-IVBE	662530 43725 * B	10/10	Gemini 46-I	662532 46843
	3,105 / 3,600*	1/10	5SG46-IVS	662530 44089 B	32A60-IVBE	662532 88802 * S	10/10	Gemini 46-J	662532 46845 *
	3,105 / 3,600*	1/10	5SG46-IVS	662532 88804 S	32A60-JVBE	662530 43727 * B			
	3,105 / 3,600*	1/10	5SG46-IVS3	662533 87221	32A60-KVBE	662530 43729 * B			
	3,105 / 3,600*	1/10	5SG46-IVSP	662530 43650	32A60-KVBE	662532 88803 * S			
	3,600	1/10	5SG46-JVS	662530 44090 B	32A80-HVBE	662530 43733			
	3,600	1/10	5SG46-JVS	662532 88806 S	32A80-IVBE	662530 43734			
	3,600	1/10	5SG46-KVS	662530 44091	32A80-JVBE	662530 43736			
	3,600	1/10	5SG60-GVSP	662530 43651 †	32A80-KVBE	662530 43737			
	3,600	1/10	5SG60-IVS	662530 44092	32A100-IVBE	662530 43740			
	3,600	1/10	5SG60-IVS3	662533 87225	32A100-KVBE	662530 43742			
	3,600	1/10	5SG60-IVSP	662530 43652	48A46-HVP2	662530 19350 B			
	3,600	1/10	5SG60-JVS	662530 44093 B					
	3,600	1/10	5SG60-KVS	662530 44094					
	3,600	1/10	5SG80-JVS	662530 44096					
	3,600	1/10	5SG80-KVS	662530 44097					
	3,600	1/10	5SG100-KVS	662530 19435					

B Best Seller; performs well in a variety of applications for many satisfied customers

S Single Pack

* Indicates wheel max RPM has been tested to 3,600 as explained in the tech tip below

Continued

TECH TIP

* 8" Type O1 and Type O5 Vitrified Toolroom Wheels' Maximum Operating Speeds:

- Stock NorPor VP2 wheels = 3,600 RPMs
- All other 46 grit, J grade and harder = 3,600 RPMs
- All other 54 grit, I grade and harder = 3,600 RPMs
- All other 60 grit and finer, H grade and harder = 3,600 RPMs
- † Exceptions to the rule: speed-tested to 3,600 RPM
- All other specifications = 3,105 RPMs



It is the user's responsibility to refer to and comply with ANSI B7.1

Vitrified Wheels For Steel Applications *continued*



TIER: BEST	TIER: BETTER	TIER: GOOD
TRADENAME: QUANTUM / NORTON SG	TRADENAME: 32A / 48A	TRADENAME: 38A / 57A
ABRASIVE: Ceramic Alumina	ABRASIVE: Aluminum Oxide	ABRASIVE: Aluminum Oxide

SIZE (D x T x H)	MAX. RPM	MIN./STD. PKG.	SPEC.	PART #	SPEC.	PART #	MIN./STD. PKG.	SPEC.	PART #
Type O1 Straight									
8 x 3/4 x 1-1/4	3,105	1/10	5NQ46-IVS	690831 59111	32A46-GVBEP	662530 44195	1/10	38A46-HVBE	662530 44175
	3,105	1/10	5NQ46-IVS3	66243 494089	32A46-HVBE	662530 44159	1/10	38A46-IVBE	662530 44177
	3,600	1/10	5NQ46-JVS	690831 59112	32A46-HVBEP	662530 44196 †	1/10	38A46-KVBE	662530 44180
	3,105 / 3,600*	1/10	5NQ46-JVS3	66243 494090 *	32A46-IVBE	662530 44215	1/10	38A60-IVBE	662530 44184 *
	3,105 / 3,600*	1/10	5NQ60-GVS3P	66243 495369	32A46-JVBE	662530 44161 *			
	3,105 / 3,600*	1/10	5NQ60-GVSP	690831 59113	32A46-KVBE	662530 44165 *			
	3,600	1/10	5NQ60-JVS	690831 59114	32A60-GVBEP	662530 44198			
	3,600	1/10			32A60-HVBE	662530 44168			
	3,105 / 3,600*	1/10	5SG46-IVS	662530 44098	32A60-IVBE	662530 44169 *			
	3,600	1/10	3SGP46-JVH	662530 13792	32A60-JVBE	662530 44171			
	3,600	1/10	5SG46-JVS	662530 44099 B	32A60-KVBE	662530 44173			
	3,600	1/10			32A80-KVBE	662530 44064			
	3,600	1/10	5SG60-IVS	662530 44101					
	3,600	1/10	5SG60-JVS	662530 44102					
	3,600	1/10	5SG60-KVS	662530 44103					
	8 x 1 x 1-1/4	3,105 / 3,600*	1/10	5SG46-KVS	662530 02588 *	32A46-HVBE	662530 44616	1/10	38A46-IVBE
3,105 / 3,600*		1/10	5SG60-GVSP	662530 03228 †	32A46-IVBE	662530 44617	1/10	38A60-IVBE	662530 44456 *
3,600		1/10	5SG60-IVS	662530 02639	32A46-KVBE	662530 44622	1/10	57A60-MVBE	662530 44270
3,600		1/10			32A60-IVBE	662530 44624			
	3,600	1/10			32A60-KVBE	662530 44629			
10 x 1/4 x 3	2,485					1	38A80-KVBE	662531 49572	
10 x 1/2 x 3	2,485	1			32A60-JVBE	662531 49729	1	38A60-KVBE	662531 49859
	2,485						1	38A80-KVBE	662531 49865
10 x 3/4 x 3	2,485	1			32A46-IVBE	662531 60024	1	38A46-JVBE	662531 60158
	2,485	1			32A60-IVBE	662531 60137	1	38A60-IVBE	662531 60163
	2,485	1			32A60-KVBE	662531 60143			
10 x 1 x 1-1/4	2,485	1			32A60-KVBE	662531 60774			
10 x 1 x 2	2,485	1			32A46-IVBE	662531 60749			
10 x 1 x 3	2,485	1	5SG46-GVSP	662531 60494	32A46-HVBE	662531 60747	1	38A46-IVBE	662531 60889
	2,485	1	5SG46-IVS	662531 60400	32A46-IVBE	662531 60750	1	38A46-JVBE	662531 60892
	2,485	1	5SG46-JVS	662531 60401	32A46-JVBE	662531 60754	1	38A60-IVBE	662531 60898
	2,485	1			32A46-KVBE	662531 60758	1	38A60-KVBE	662531 60900
	2,485	1	5SG46-KVS	662531 60402	32A60-IVBE	662531 60769			
	2,485	1	5SG60-GVSP	662531 60495	32A60-KVBE	662531 60777			
	2,485	1	5SG60-IVS	662531 60403	32A80-KVBE	662531 60782			
	2,485	1	5SG60-JVS	662531 60404					
	2,485	1	5SG60-KVS	662531 60405					
12 x 1/2 x 3	2,070	2			32A60-JVBE	662532 62134			
	2,070	2			32A80-KVBE	662532 62110			
12 x 1/2 x 5	2,070	2			32A60-KVBE	662532 62107			
	2,070	2			32A80-KVBE	662532 62111			
	2,070	1	5SG46-IVS	662532 62204	32A46-GVBEP	662532 62392	1	38A46-JVBE	662532 62281
12 x 3/4 x 3	2,070	1			32A46-HVBE	662532 62260			
	2,070	1			32A46-IVBE	662532 62261			
	2,070	1			32A60-IVBE	662532 62270			
	2,070	1			32A60-KVBE	662532 62273			
12 x 1 x 1-1/4	2,070	1			32A46-KVBE	662532 62570			

B Best Seller; performs well in a variety of applications for many satisfied customers

S Single Wheel Pack

* Indicates wheel max RPM has been tested to 3,600 as explained in the tech tip below

TECH TIP

* 8" Type O1 and Type O5 Vitrified Toolroom Wheels' Maximum Operating Speeds:

- Stock NorPor VP2 wheels = 3,600 RPMs
- All other 46 grit, J grade and harder = 3,600 RPMs
- All other 54 grit, I grade and harder = 3,600 RPMs
- All other 60 grit and finer, H grade and harder = 3,600 RPMs
- † Exceptions to the rule: speed-tested to 3,600 RPM
- All other specifications = 3,105 RPMs



It is the user's responsibility to refer to and comply with ANSI B7.1

Vitrified Wheels For Steel Applications *continued*



TIER:	BEST	BETTER	GOOD
TRADENAME:	QUANTUM / NORTON SG	32A / 48A	38A
ABRASIVE:	Ceramic Alumina	Aluminum Oxide	Aluminum Oxide

SIZE (D x T x H)	MAX. RPM	MIN./STD. PKG.	SPEC.	PART #	SPEC.	PART #	MIN./STD. PKG.	SPEC.	PART #	
Type O1 Straight										
12 x 1 x 3	2,070 / 2,710*	1	3SGR46-HVP2	662532 20885*	32A46-GVBEP	662532 62840	1	38A46-HVBE	662532 62700	
	2,070	1	5SG46-HVSP	662532 62488	32A46-HVBE	662532 62562	1	38A46-IVBE	662532 62702	
	2,070	1	5SG46-IVS	662532 62500	32A46-HVBEP	662532 62842	1	38A46-JVBE	662532 62704	
	2,070	1	5SG46-JVS	662532 62501	32A46-IVBE	662532 62564	1	38A60-IVBE	662532 62713	
	2,070	1	5SG46-JVS3	662434 95317	32A46-JVBE	662532 62567				
	2,070	1	5SG46-KVS	662532 62502	32A46-KVBE	662532 62572				
	2,070	1	5SG46-KVS3	662434 95318	32A60-HVBE	662532 62580				
	2,070	1	5SG60-GVSP	662532 62593	32A60-IVBE	662532 62581				
	2,070	1	5SG60-IVS	662532 62503	32A60-KVBE	662532 62689				
	2,070	1	5SG60-JVS	662532 62504	32A80-KVBE	662532 62532				
	2,070 / 2,710*	1	5SG60-KVS	662532 62505	48A60-HVP2	662532 20891*				
	12 x 1 x 5	2,070	1	5SG46-GVSP	662532 62594	32A46-GVBEP	662532 62841	1	38A46-IVBE	662532 62703
		2,070	1	5SG46-IVS	662532 62508	32A46-HVBE	662532 62563	1	38A60-KVBE	662532 62719
		2,070	1	5SG46-JVS	662532 62509 B	32A46-IVBE	662532 62565			
2,070		1	5SG46-KVS	662532 62510	32A46-KVBE	662532 62573				
2,070		1	5SG60-GVSP	662532 62595						
2,070		1	5SG60-IVS	662532 62511	32A60-IVBE	662532 62582				
2,070		1	5SG60-JVS	662532 62512	32A60-JVBE	662532 62686				
2,070		1	5SG60-KVS	662532 62513	32A60-KVBE	662532 62691 B				
2,070		1	5SG80-JVS	662532 62515	32A80-JVBE	662532 62696				
2,070		1			32A80-KVBE	662532 62697				
12 x 1-1/4 x 3	2,070	1			32A46-IVBE	662532 62301				
12 x 1-1/2 x 1-1/4	2,070	1			32A46-KVBE	662532 63146				
12 x 1-1/2 x 3	2,070	1	5SG46-IVS	662532 02820	32A46-HVBE	662532 63143				
	2,070	1			32A46-IVBE	662532 63144				
	2,070	1			32A60-JVBE	662532 63123				
12 x 1-1/2 x 5	2,070	1	5NQ46-IVS	690831 59115	32A46-GVBEP	662532 63192	1	38A46-IVBE	662532 14987	
	2,070	1	5NQ46-IVS3	662434 94092	32A46-HVBE	662532 63128				
	2,070	1	5NQ46-JVS	690831 59116	32A46-IVBE	662532 63145				
	2,070	1	5NQ46-JVS3	662434 94093	32A46-JVBE	662532 63120				
	2,070	1	5NQ60-GVSP	690831 59117	32A60-HVBE	662532 63149				
	2,070	1	5NQ60-JVS	690831 59118	32A60-KVBE	662532 63034				
	2,070	1	3SGP60-GVSP	662532 15030						
	2,070	1	5SG46-GVSP	662532 03453						
	2,070	1	5SG46-IVS	662532 02842						
	2,070	1	5SG46-IVS3	662434 95319						
	2,070	1	5SG46-JVS	662532 02926						
2,070	1	5SG60-GVSP	662532 62596							
12 x 2 x 1-1/4	2,070	1			32A46-KVBE	662532 63461				
	2,070	1			32A46-MVBE	662532 63463				
12 x 2 x 3	2,070	1			32A46-IVBE	662532 63459				
12 x 2 x 5	2,070	1			32A46-HVBE	662532 63403				
	2,070	1			32A46-IVBE	662532 62302				
	2,070	1			32A60-KVBE	662532 63465				
14 x 1/2 x 5	1,800	1	5SG80-KVS	662533 63814	32A60-KVBE	662533 63761				
14 x 3/4 x 5	1,800	1			32A60-KVBE	662533 63772				
14 x 1 x 3	1,800	1	5SG46-IVS	662533 63960	32A46-HVBE	662533 63912				
	1,800	1			32A46-IVBE	662533 63914				
	1,800	1			32A60-IVBE	662533 63927				

* 12" Type O1 Wheel Maximum RPM: NORPOR VP2 Wheels = 2,710; all others = 2,070

B Best Seller; performs well in a variety of applications for many satisfied customers

To maximize the performance of these wheels and finished part quality, refer to the beginning of this section and the "Dressing Solutions" section for truing and dressing products.

For non-stock toolroom wheels: if you don't see the toolroom wheel you need in our stock listing, call your local authorized Norton distributor to check our made-to-order non-stock availability – including our revolutionary new Quantum ceramic and Vitrium³ bond wheels.

Vitrified Wheels For Steel Applications *continued*



TIER: BEST	TIER: BETTER	TIER: GOOD
TRADENAME: QUANTUM / NORTON SG	TRADENAME: 32A	TRADENAME: 38A / 57A
ABRASIVE: Ceramic Alumina	ABRASIVE: Aluminum Oxide	ABRASIVE: Aluminum Oxide

SIZE (D x T x H)	MAX. RPM	MIN./STD. PKG.	SPEC.	PART #	SPEC.	PART #	MIN./STD. PKG.	SPEC.	PART #
Type O1 Straight									
14 x 1/2 x 5	1,800	1	5SG80-KVS	662533 63814	32A60-KVBE	662533 63761			
14 x 3/4 x 5	1,800	1			32A60-KVBE	662533 63772			
14 x 1 x 3	1,800	1	5SG46-IVS	662533 63960	32A46-HVBE	662533 63912			
	1,800	1			32A46-IVBE	662533 63914			
	1,800	1			32A60-IVBE	662533 63927			
14 x 1 x 5	1,800	1	5SG46-GVSP	662533 64108	32A46-GVBEP	662533 64074	1	38A46-HVBE	662533 64043
	1,800	1	5SG46-HVSP	662533 13990	32A46-HVBE	662533 63913	1	38A60-IVBE	662533 63947
	1,800	1	5SG46-IVS	662533 63970	32A46-IVBE	662533 63915	1	38A60-JVBE	662533 64051
	1,800	1	5SG46-JVS	662533 63971	32A46-JVBE	662533 63919	1	38A60-KVBE	662533 64053
	1,800	1			32A46-KVBE	662533 63921	1	38A80-KVBE	662533 64058
	1,800	1	5SG60-IVS	662533 63974	32A60-GVBEP	662533 64077	1	57A60-KVBE	662533 64065
	1,800	1	5SG60-IVSP	662533 63871	32A60-HVBE	662533 63926	1	57A60-LVBE	662533 64066
	1,800	1	5SG60-JVS	662533 63975	32A60-JVBE	662533 63930	1	57A80-MVBE	662533 64070
	1,800	1	5SG60-KVS	662533 63976	32A60-KVBE	662533 63932			
	1,800	1	5SG80-JVS	662533 63979	32A60-LVBE	662533 64035			
	1,800	1	5SG80-KVS	662533 64003	32A80-JVBE	662533 64038			
	1,800	1			32A80-KVBE	662533 64039			
14 x 1 x 8	1,800	1			32A60-IVBE	662533 63887			
14 x 1-1/2 x 5	1,800	1	5NQ46-HVS3	662533 87216	32A46-GVBEP	662533 64238	1	38A46-HVBE	662533 13968
	1,800	1	5NQ46-IVS3	662533 87219	32A46-HVBE	662533 64335	B 1	38A46-HVBEP	662533 13969
	1,800	1	5NQ46-IVS	690831 59119	32A46-HVBEP	662533 64243	1	38A46-IVBE	662533 64090
	1,800	1	5NQ46-JVS	690831 59120	32A46-JVBE	662533 64336	1	38A46-JVBE	662533 64240
	1,800	1	5NQ46-JVS3	662434 94095	32A46-JVBE	662533 64337	1	38A60-IVBE	662533 64247
	1,800	1	5NQ60-GVS3P	662434 95372	32A46-KVBE	662533 64339			
	1,800	1	5NQ60-GVSP	690831 59122	32A60-HVBE	662533 64340			
	1,800	1	5NQ60-JVS	690831 59124	32A60-IVBE	662533 64239			
	1,800	1	5NQ60-JVS3	662434 94096	32A60-JVBE	662533 64341			
	1,800	1	3SGP46-GVSP	662533 06780	32A60-KVBE	662533 64342			
	1,800	1	3SGP46-HVSP	662533 07025	32A80-JVBE	662533 64246			
	1,800	1	3SGP46-JVH	662533 13976					
	1,800	1	5SG46-GVSP	662533 64320					
	1,800	1	5SG46-HVS3	662533 87231					
	1,800	1	5SG46-HVSP	662533 02625					
	1,800	1	5SG46-IVS	662533 64097					
	1,800	1	5SG46-IVS3	662533 87234					
	1,800	1	5SG46-IVSP	662533 02498					
	1,800	1	5SG46-JVS	662533 64098	B				
	1,800	1	5SG60-IVS	662533 64100					
	1,800	1	5SG60-JVS	662533 64101					
	1,800	1	5SG60-KVS	662533 02160					
	1,800	1	5SG80-KVS	662533 63815					
14 x 2 x 5	1,800	1	5SG60-JVS	662533 64414	32A46-IVBE	662533 64323			
	1,800	1			32A46-JVBE	662533 64508			
	1,800	1			32A46-KVBE	662533 64509			
	1,800	1			32A60-KVBE	662533 64510			

B Best Seller; performs well in a variety of applications for many satisfied customers

Dressing: Single Point Dressing Tool Starting Recommendations

WHEEL SIZES	TOOL SHANK DIAMETER	Ceramic (NQ, Norton SG, TG, etc.), 37C & 39C Wheels		25A, 32A, 38A, 48A, 53A, 57A, 64A, 86A Wheels	
		PRODUCT NO.	PART #	PRODUCT NO.	PART #
12" to 14"	3/8"	BCSG5M6	662601 57009	BC5M6	662601 95004
	7/16"	BCSG5M7	662601 56907	BC5M7	662601 95005

These tools are a standard recommendation; see the "Dressing Solutions" section for additional tools. See the Fliesen Tool section for Furioso tools, engineered specifically for Quantum vitrified wheel dressing.

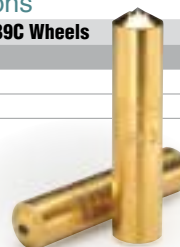

Vitrified Wheels For Steel Applications *continued*



TIER:	BEST	BETTER	GOOD
TRADENAME:	QUANTUM / NORTON SG	32A / 23A / 48A	38A / 53A / 57A
ABRASIVE:	Ceramic Alumina	Aluminum Oxide	Aluminum Oxide

SIZE (D x T x H)	MAX. RPM	MIN./STD. PKG.	SPEC.	PART #	SPEC.	PART #	MIN./STD. PKG.	SPEC.	PART #
Type O2 Cylinder									
6 x 1 x 4	3,600	1/10			32A46-KVBE	662528 38308	1/10	38A80-HVBE	662528 38314
Rim 1"	3,600	1/10			32A60-JVBE	662528 38309			
Plate A47466									
8 x 2 x 5-1/2	2,865						1/8	53A46-KVBE	662530 44942
Rim 1-1/4"									
Plate A50831									
10 x 2 x 7-1/2	2,295	1			32A54-JVG	662531 16187	1	53A60-KVG	662531 161701
Rim 1-1/4"									
(ME62845)									
Plate A110170									
11 x 5	1,910	1			32A30-HVBE	662531 161800			
Rim 1" (ME33437)									
Tape Wound									
11 x 5	1,740	1			32A36-EVBEP	662531 161780	1	38A46-GVBE	662531 161807
Rim 1" (ME52726)	1,910	1			32A36-GVBEP	662531 161808			
Tape Wound	1,910	1			32A46-HVBE	662531 161893			
18 x 5 Rim 1-1/2"	1,065	1			32A30-E19VCP	662534 65142			
(ME15536)									
Tape Wound									
18 x 5 Rim 1-1/2"	1,170	1			23A30-F19VCP	662534 65235			
(ME52719)									
Tape Wound									
Includes Strips									
Type O5 Recessed One Side									
3/4 x 3/4 x 1/4	43,290	5/40			32A60-KVBE	662434 27582			
Recess 1/S 3/8 x 3/8									
1 x 1 x 1/4	32,470	5/40			32A60-KVBE	662434 27769			
Recess 1/S 1/2 x 1/2									
1 x 1 x 3/8	32,470	5/40			32A60-KVBE	662434 27773			
Recess 1/S 1/2 x 1/2									
1-1/4 x 1 x 3/8	25,975	5/40			32A60-KVBE	662434 27799			
Recess 1/S 5/8 x 1/2									
1-1/2 x 1 x 3/8	25,975	5/40			32A60-KVBE	662434 27938			
Recess 1/S 5/8 x 1/2									
1-1/2 x 1 x 3/8	21,645	5/40			32A60-KVBE	662434 27937			
Recess 1/S 3/4 x 1/2									
2 x 1 x 3/8	16,235	5/40			32A60-KVBE	662434 28329			
Recess 1/S 3/4 x 1/2									
2 x 1-1/2 x 5/8	16,235	10/30			32A60-KVBE	662434 28332			
Recess 1/S 1 x 3/4									
7 x 3/4 x 1-1/4	3,600	1/10	5SG46-IVS	662529 41976	32A46-HVBE	662529 42209	1/10	38A46-IVBE	662529 42222
Rec 1/S 2-3/4 x 1/4	3,600	1/10			32A46-IVBE	662529 42211	1/10	38A60-IVBE	662529 42225
	3,600	1/10			32A46-JVBE	662529 42213			
	3,600	1/10			32A60-IVBE	662529 42217			
	3,600	1/10			32A60-JVBE	662529 42218			
	3,600	1/10			32A60-KVBE	662529 42205			
	3,600	1/10			32A46-GVBEP	662529 42826			
7 x 1 x 1-1/4	3,600	1/10			32A46-HVBE	662529 42688			
Rec 1/S 2-3/4 x 1/2	3,600	1/10	3SGR46-HVP2	662529 16228	32A46-HVBE	662529 42688			
	3,600	1/10	5SG46-IVS	662529 42318	32A46-HVBEP	662529 42828			
	3,600	1/10			32A46-IVBE	662529 42691			
	3,600	1/10	5SG46-JVS	662529 42427	32A46-KVBE	662529 42708			
	3,600	1/10			32A60-IVBE	662529 42699			
	3,600	1/10	5SG60-JVS	662529 42431	32A60-JVBE	662529 42701			
	3,600	1/10			32A60-KVBE	662529 42703			
	3,600	1/10			48A46-HVP2	662529 16232			

Continued

For non-stock toolroom wheels: if you don't see the toolroom wheel you need in our stock listing, call your local authorized Norton distributor to check our made-to-order non-stock availability – including our revolutionary new Quantum ceramic and Vitrium³ bond wheels.

Vitrified Wheels For Steel Applications *continued*



TIER: **BEST** **BETTER** **GOOD**
 TRADENAME: **QUANTUM / NORTON SG** **32A / 48A** **38A / GEMINI**
 ABRASIVE: Ceramic Alumina Aluminum Oxide Aluminum Oxide

SIZE (D x T x H)	MAX. RPM	MIN./STD. PKG.	SPEC.	PART #	SPEC.	PART #	MIN./STD. PKG.	SPEC.	PART #
Type 05 Recessed One Side									
7 x 1 x 1-1/4	3,600	1/10	5NQ46-IVS	662533 50691	32A46-HVBE	662529 42689	1/10	38A46-HVBE	662529 42707
Rec 1/S 3 x 1/2	3,600	1/10	5SG46-IVS	662529 01814	32A46-IVBE	662529 42690	1/10	38A46-IVBE	662529 42809
	3,600	1/10			32A60-IVBE	662529 42686	1/10	38A46-KVBE	662529 42793
	3,600	1/10	5SG60-IVS	662529 06907			1/10	38A60-IVBE	662529 42815
	3,600	1/10	5SG60-IVS3	662434 94102			1/10	38A60-JVBE	662529 42816
	3,600						1/10	38A60-KVBE	662529 42817
	3,600					10/10	Gemini 46-J	662532 46835	
7 x 1-1/4 x 1-1/4	3,600	1/5			32A46-HVBE	662529 42833			
Rec 1/S 2-3/4 x 5/8	3,600	1/5			32A60-IVBE	662529 42859			
	3,600	1/5			32A60-JVBE	662529 42835			
7 x 1-1/2 x 1-1/4	3,600	1/5			32A46-IVBE	662529 42843			
Rec 1/S 2-3/4 x 3/4	3,600	1/5			32A60-IVBE	662529 42844			
8 x 3/4 x 1-1/4	3,105	1/10			32A46-IVBE	662530 44213			
Rec 1/S 3-1/4 x 1/4									
8 x 1 x 1-1/4	3,600						10/10	Gemini 46-J	662532 46850
Rec 1/S 3 x 1/2									
8 x 1 x 1-1/4	3,105	1/10	5SG46-IVS	662530 13543	32A46-IVBE	662530 44790			
Rec 1/S 3-1/4 x 1/2	3,600	1/10			32A46-JVBE	662530 44382			
	3,600	1/10	5SG46-JVS	662530 03301	32A46-JVS3	662434 95329			
	3,600	1/10			32A60-IVBE	662530 44753			
	3,600	1/10			32A60-KVBE	662530 44810			
10 x 3/4 x 2	2,485	1			32A60-JVBE	662531 60189			
Rec Side A									
5 x 3/16 Face Bev									
Side A 75 Deg									
From 1/8" Flat									
12 x 1-1/2 x 3	2,070	1			32A46-IVBE	662532 63186			
Rec 1/S 6 x 1/2									
12 x 1-1/2 x 5	2,070 / 2,710*	1	3SGR46-HVP2	662532 20904*	32A46-HVBEP	662532 63180	1	38A46-IVBE	662532 63175
Rec 1/S 7-1/2 x 1/2	2,070	1	5SG46-GVSP	662532 63127	32A46-IVBE	662532 63166			
	2,070	1			32A46-JVBE	662532 63169			
	2,070	1	5SG46-IVS	662532 02883	32A46-KVBE	662532 63170			
	2,070	1			32A60-KVBE	662532 63172			
				5SG60-IVSP	662532 63050				
14 x 1-1/2 x 5	1,800 / 2,320*	1	3SGR46-GVP2	662533 19953*	32A46-HVBE	662533 64359			
Rec 1/S 8 x 1/2	1,800 / 2,320*	1	3SGR46-HVP2	662533 19954*	32A46-IVBE	662533 64300			
	1,800 / 2,320*	1	3SGR60-HVP2	662533 19956*	32A46-KVBE	662533 64362			
	1,800	1	5SG46-IVS	662533 64102	32A60-JVBE	662533 64364			
	1,800	1	5SG46-IVS3	662434 94106	32A60-KVBE	662533 64365			
	1,800	1	5SG46-JVS	662533 64103					
	1,800	1	5SG60-IVS	662533 64104					
	1,800	1	5SG60-JVS	662533 64105					
14 x 2 x 5	2,320	1	3SGR46-GVP2	662533 19936	48A46-HVP2	662533 19941	1	25A46-HVP2	662533 19945
Rec 1/S 8 x 1/2	2,320	1	3SGR46-HVP2	662533 19937			1	38A46-HVP2	662533 19949
	2,320						1	38A60-HVP2	662533 19951
14 x 2 x 5	1,800	1			32A60-KVBE	662533 64390			
Rec 1/S 8 x 1									

* 12" Type 05 Wheel Maximum RPM: NORPOR VP2 Wheels = 2,710; all others = 2,070

* 14" Type 05 Wheel Maximum RPM: NORPOR VP2 Wheels = 2,320; all others = 1,800

To maximize the performance of these wheels and finished part quality, refer to the beginning of this section and the "Dressing Solutions" section for truing and dressing products.

For non-stock toolroom wheels: if you don't see the toolroom wheel you need in our stock listing, call your local authorized Norton distributor to check our made-to-order non-stock availability – including our revolutionary new Quantum ceramic and Vitrium³ bond wheels.

Vitrified Wheels For Steel Applications *continued*



TIER: BEST	TIER: BETTER	TIER: GOOD
TRADENAME: NORTON SG	TRADENAME: 32A / 48A	TRADENAME: 38A / 25A / 53A
ABRASIVE: Ceramic Alumina	ABRASIVE: Aluminum Oxide	ABRASIVE: Aluminum Oxide

SIZE (D x T x H)	MAX. RPM	MIN./STD. PKG.	SPEC.	PART #	SPEC.	PART #	MIN./STD. PKG.	SPEC.	PART #
Type 06 Straight Cup									
3-1/2 x 1-1/2 x 1/2 Rim 1/2" Back 1/2"	6,550						1/10	38A60-KVBE	662435 29372
100mm x 50mm x 20mm Rim 10mm, Back 13mm	6,550						1/10	38A80-JVBE	662435 30429
4 x 1-1/2 x 1/2 Rim 1/2" Back 1/2"	5,730	1/10			32A60-KVBE	662435 30218			
4 x 1-1/2 x 1-1/4 Rim 1/2" Back 1/2"	5,730						1/10	38A60-KVBE	662435 30221
4 x 2 x 20mm Rim 3/8" Back 1/2"	5,730						1/10	38A80-JVBE	662435 30523
5 x 1-1/2 x 1-1/4 Rim 3/8" Back 3/8"	4,585	1/10			32A46-KVBE	662528 30832	1/10	38A46-KVBE	662528 30842
Face Y (ME19243)	4,585	1/10			32A60-JVBE	662528 30837	1/10	38A60-KVBE	662528 30846
5 x 2 x 5/8 Rim 1/2" Back 1/2"	4,585	1/10			32A60-KVBE	662528 30838			
5 x 2 x 5/8 Rim 1/2" Back 1/2"	4,585	1/10			32A60-JVBE	662528 30987			
6 x 1-1/2 x 1/2 Rim 1" Back 1/2"	3,820	1/10			32A46-KVBE	662528 38458			
6 x 2 x 1-1/4 Rim 1/2" Back 1/2"	3,820	1/10			32A46-IVBE	662528 38544	1/10	38A60-KVBE	662528 38486
7 x 2 x 1-1/4 Rim 1/2" Back 1/2"	3,275	1/8			32A60-JVBE	662528 38538			
7 x 2 x 1-1/4 Rim 1/2" Back 1/2"	3,275	1/8			32A46-JVBE	662529 42856			
9-1/2 x 1-1/2 x 1-1/2 Rim 1-1/2" Back 5/8"	2,415						1	53A46-LVBE	662531 49136
10 x 4 x 1-1/2 Rim 1-1/4" Back 1"	2,295						1	38A46-IVBE	662531 61797
Tape Wound									
12 x 2-1/2 x 7 Rim 1-1/2" Back 7/8"	1,910	1			32A46-LVBE	662532 63614			
Type 07 Recessed Two Sides									
12 x 2 x 3 Rec 2/S 5-1/2 x 3/8	2,070	1			32A46-IVBE	662532 63588			
12 x 2 x 3 Rec 2/S 7-1/4 x 1/2	2,070	1			32A46-HVBE	662532 63590			
12 x 2 x 5 Rec 2/S 7-1/4 x 1/2	2,070	1			32A46-JVBE	662532 63348			
12 x 2 x 5 Rec 2/S 7-1/4 x 1/2	2,070	1			32A46-IVBE	662532 63594			
12 x 2 x 5 Rec 2/S 7-1/2 x 1/2	2,070	1	5SG46-JVS	662532 09930	32A46-HVBE	662532 63591	1	38A46-IVBE	662532 63600
	2,070	1			32A46-HVBEP	662532 63603			
	2,070	1			32A46-JVBE	662532 63483			
	2,070	1			32A46-KVBE	662532 63596			
	2,070	1			32A60-IVBE	662532 63597			





Vitrified Wheels For Steel Applications *continued*



TIER: **BEST** **NORTON SG** **BETTER** **32A**
 TRADENAME: **NORTON SG** **32A**
 ABRASIVE: Ceramic Alumina Aluminum Oxide

GOOD **38A**
 Aluminum Oxide

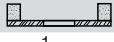
SIZE (D x T x H)	MAX. RPM	MIN./STD. PKG.	SPEC.	PART #	SPEC.	PART #	MIN./STD. PKG.	SPEC.	PART #
Type 11 Flaring Cup 									
3/2-1/4 x 1-1/4 x 3/4	7,640	1/10			32A60-JVBE	662435 29183	1/10	38A60-JVBE	662435 29197
Rim 1/4" Back 3/8"	7,640	1/10			32A60-KVBE	662435 29187			
Face Z (ME21560)									
3-1/2/2-3/4 x 1-1/2 x 1-1/4	7,640	1/10			32A60-KVBE	662435 29358			
Rim 1/4" Back 3/8"									
Face Z (ME24327)									
4/3 x 1-1/2 x 1-1/4	5,730	1/5	5SG46-IVSP	662435 30127	32A46-IVBE	662435 30240	1/10	38A46-KVBE	662435 30378
Rim 1/4" Back 1/2"	5,730	1/5	5SG46-KVS	662435 03342	32A46-KVBE	662435 30246	1/10	38A60-JVBE	662435 30387
Face Z (ME19237)	5,730	1/5			32A60-JVBE	662435 30256	1/10	38A60-KVBE	662435 30390
	5,730	1/5	5SG60-JVS	662435 30415	32A60-KVBE	662435 30361	1/10	38A80-JVBE	662435 30393
	5,730	1/5					1/10	38A80-KVBE	662435 30395
	5,730	1/5	5SG60-LVS	662435 30417	32A80-KVBE	662435 30368			
	5,730	1/5	5SG80-JVS	662435 30419					
	5,730	1/5	5SG80-KVS	662435 30420					
4-1/2/3-3/4 x 2 x 1-1/4	5,730	1/5			32A46-KVBE	662528 30539			
Rim 1/4"									
Back 1/2"(ME20115)									
5/3-3/4 x 1-3/4 x 1-1/4	4,585	1/5	5SG46-KVS	662528 03291	32A46-JVBE	662528 30858	1/5	38A46-KVBE	662528 30971
Rim 1/4" Back 1/2"	4,585	1/5	5SG60-KVS	662528 30737	32A46-KVBE	662528 30859	1/5	38A60-JVBE	662528 30973
Face Z (ME21563)	4,585	1/5					1/5	38A60-KVBE	662528 30975
	4,585	1/5	5SG60-LVS	662528 30736	32A60-JVBE	662528 30962			
	4,585	1/5			32A60-KVBE	662528 30964			
6/4-1/2 x 2 x 1-1/4	3,820	1/5			32A46-JVBE	662528 38491	1/5	38A46-KVBE	662528 38495
Rim 3/8" Back 1/2"	3,820	1/5			32A46-KVBE	662528 38528	1/5	38A60-KVBE	662528 38497
Face Z (ME19241)	3,820	1/5			32A60-JVBE	662528 38492			
7/5 x 2 x 1-1/4	3,275	1/8			32A46-JVBE	662529 42959	1/8	38A46-HVBE	662529 42963
Rim 3/4" Back 1/2"									
(ME19242)									
Type 12 Dish 									
4 x 1/2 x 3/4	6,207	1/10			32A60-KVBE	662435 30067			
(ME19226)									
6 x 1/2 x 1-1/4	4,140	1/10	5SG60-LVS	662528 36574	32A46-JVBE	662528 36860	1/10	38A60-JVBE	662528 36977
(ME19229)	4,140	1/10			32A60-JVBE	662528 36966			
6 x 3/4 x 1-1/4	4,140	1/10	5SG60-KVS	662528 37771	32A46-KVBE	662528 37732			
(ME19230)	4,140	1/10			32A60-JVBE	662528 37734			
	4,140	1/10			32A60-KVBE	662528 37735			
7 x 1/2 x 1-1/4	3,600	1/10			32A46-KVBE	662529 41644			
(ME13717)	3,600	1/10			32A60-KVBE	662529 41647			
8 x 3/4 x 1-1/4	3,600						1/10	38A60-KVBE	662530 44319
(ME19231)									
10 x 1 x 1	2,485	1			32A54-JVBE	662531 61196			
(ME38702)									
10 x 1 x 1-1/4	2,485	1			32A54-JVBE	662531 61197			
(ME38702)									
Type 20 Concave One Side 									
14 x 1-1/2 x 5	1,800	1	5SG60-JVS	662533 02265	32A60-JVBE	662533 64250			
Concave from Periphery	1,800	1			32A60-KVBE	662533 64332			
1/2" Deep to 8" Flat Spot									
Type 35 Plate Mounted Disc 									
9 x 2 x 4-15/16	2,550	1			32A46-MVBE	662530 49115			
Rim 2-1/32" (ME31130)	2,550	1			32A60-J25VCF2	662530 06557			
Plate A47248	2,550	1			32A70-JVBEP	662530 49112			

For non-stock toolroom wheels: if you don't see the toolroom wheel you need in our stock listing, call your local authorized Norton distributor to check our made-to-order non-stock availability – including our revolutionary new Quantum ceramic and Vitrium³ bond wheels.



These sharp silicon carbide, vitrified wheels are used for grinding non-ferrous applications.

Applications:

Use 39C (green silicon carbide) for cemented carbides, titanium, metal matrix composites and plasma sprayed materials.
Use 37C (black silicon carbide) on 300 series stainless steels, irons, nonferrous metals (aluminum, brass, bronze and copper) and non-metallic materials (stone, marble, rubber, ceramics and glass).

Shapes:

Type 01 Straight, Type 02 Cylinder, and Type 05 Recessed 1 Side

Size Range:

3" – 14" diameter

Grit Range:

24 – 120

Abrasive Grain:



39C Green Silicon Carbide, 37C Black Silicon Carbide

Vitrified Wheels For Non-Ferrous Applications

TIER: **GOOD**
TRADENAME: **39C / 37C**
ABRASIVE: Silicon Carbide

SIZE (D x T x H)	MAX. RPM	MIN./STD. PKG.	SPEC.	PART #	
Type 01 Straight 					
3 x 1/2 x 1/2	10,825	10/50	37C60-MVK	662435 29041	
3 x 1 x 1/2	10,825	10/10	37C60-MVK	662435 29166	
	10,825	10/10	37C80-HVK	662435 29170	
	10,825	10/10	37C80-MVK	662435 29171	
	10,825	10/10	37C100-HVK	662435 29172	
	10,825	10/10	37C100-MVK	662435 29070	
3-1/2 x 1-1/2 x 7/8 (ME622)	7,095	1/10	37C24-SVK	662435 29339	
	7,095	1/10	37C30-SVK	662435 29338	
4 x 1/2 x 1/2	8,120	1/10	37C60-MVK	662435 29960	
	8,120	1/10	39C100-IVK	662435 30064	
6 x 1/2 x 1-1/4	4,140	1/10	39C60-IVK	662528 36706	
	4,140	1/10	39C80-IVK	662528 36816	
	4,140	1/10	39C100-IVK	662528 36827	
	4,140	1/10	39C120-IVK	662528 36836	
6 x 3/4 x 1-1/4	4,140	1/10	39C60-IVK	662528 37584	
	4,140	1/10	39C80-IVK	662528 37598	
	4,140	1/10	39C100-IVK	662528 37717	
	4,140	1/10	39C60-IVK	662528 38161	
6 x 1 x 1-1/4	4,140	1/10	39C80-IVK	662528 38173	
	3,600	1/10	39C80-JVK	662529 40007	
7 x 1/4 x 1-1/4	3,600	1/10	39C100-IVK	662529 40109	
	3,600	1/10	39C120-IVK	662529 40111	
	3,600	1/10	37C46-JVK	662529 41488	
	3,600	1/10	37C60-OVK	662529 41498	
7 x 1/2 x 1-1/4	3,600	1/10	39C60-IVK	662529 41609	
	3,600	1/10	39C60-JVK	662529 41611	
	3,600	1/10	39C60-KVK	662529 41613	
	3,600	1/10	39C80-IVK	662529 41617	
	3,600	1/10	39C80-JVK	662529 41618	
	3,600	1/10	39C100-HVK	662529 41622	
	3,600	1/10	39C100-IVK	662529 41624	
	3,600	1/10	39C120-IVK	662529 41632 B	
	7 x 3/4 x 1-1/4	3,600	1/10	39C80-JVK	662529 42096
		3,600	1/10	39C100-JVK	662529 42104
7 x 1 x 1-1/4	3,600	1/10	39C60-IVK	662529 42666	
	3,600	1/10	39C80-IVK	662529 42413	
	3,600	1/10	39C120-IVK	662529 42416	
8 x 1/4 x 1-1/4	3,600	1/10	39C80-IVK	662530 14526	
8 x 3/8 x 1-1/4	3,600	1/10	39C80-IVK	699366 64144	
8 x 1/2 x 1-1/4	3,600	1/10	39C60-IVK	662530 44013	
	3,600	1/10	39C80-IVK	662530 44015	
	3,600	1/10	39C100-IVK	662530 44017 B	

TIER: **GOOD**
TRADENAME: **39C / 37C**
ABRASIVE: Silicon Carbide

SIZE (D x T x H)	MAX. RPM	MIN./STD. PKG.	SPEC.	PART #
Type 01 Straight 				
8 x 3/4 x 1-1/4	3,600	1/10	39C60-JVK	662530 44312
	3,600	1/10	39C80-IVK	662533 50645
	3,600	1/10	39C100-IVK	662530 44314
8 x 1 x 1-1/4	3,600	1/10	39C60-JVK	662530 44770
	3,600	1/10	39C80-IVK	662530 44425 B
	3,600	1/10	39C100-IVK	662530 44379
	2,485	1	39C60-JVK	662531 160348
	2,485	1	39C60-JVK	662531 161640
10 x 1 x 3	2,485	1	39C60-IVK	662532 62985
12 x 1 x 3	2,070	1	39C60-IVK	662532 62988
	2,070	1	39C60-IVK	662532 62988
14 x 1 x 5	1,800	1	39C60-JVK	662533 64206
	1,800	1	39C80-JVK	662533 64208
	1,800	1	39C60-JVK	662533 64242
14 x 1-1/2 x 5	1,800	1	39C60-JVK	662533 64242
14 x 2 x 5	1,800	1	39C60-JVK	662533 64322
Type 02 Cylinder 				
6 x 1 x 4	3,600	1/10	39C60-IVK	662528 38322
Rim 1"	3,600	1/10	39C60-JVK	662528 38324
Plate A47466	3,600	1/10	39C80-IVK	662528 38327
	3,600	1/10	39C100-IVK	662528 38330
	3,600	1/10	39C120-IVK	662528 38193
6 x 1-1/4 x 4	3,600	1/10	39C60-IVK	662528 38345
Rim 1"				
Plate A47466				
10 x 2 x 7	2,100	1	39C60-HVK	662531 161675
Rim 1-1/2"	2,295	1	39C60-JVK	662531 161678
Plate A83831				
Type 05 Recessed One Side 				
14 x 1-1/2 x 5	1,800	1	39C60-IVK	66253364328
Rec 1/5 8 x 1/2				

B = Best Seller; performs well in a variety of applications for many satisfied customers





Large surface grinding wheels are generally used to grind flat stock or flat surfaces within a workpiece. These wheels are typically used on horizontal spindle machines. Applications can vary from heavy, rapid stock removal to precision tolerance operations.

- Applications:**
- Producing flat stock
 - Grinding large molds and dies
 - Sharpening knives, blades and cutlery
 - Manufacturing broaches
- Shape:** Type 01 Straight, Type 07 Recessed 2 Sides
- Size Range:** Stock: 20" diameter
1" – 6" thickness
- Abrasive Grain:** Aluminum Oxide

Cross Reference Guide

NORTON	GOOD GEMINI
Camel	91A
Cincinnati Milacron	29A, 97A
Radiac	WAA, 97A, 45A



Good choice when a broad range of parts are ground on a few machines

GEMINI ALUMINUM OXIDE BLEND

- Specially blended aluminum oxide abrasive for many surface grinding applications
- Porous bond is cool cutting on medium to wide contact areas; high chip clearance and stock removal
- Faster grinding rates remove stock, lower rates produce finer finishes; ideal when a broad range of tool steel parts are ground on a few machines

TIER: **GOOD**
 TRADENAME: **GEMINI**
 ABRASIVE: Aluminum Oxide

SIZE (D x T x H)	RECESS	MAX. RPM	STD. PKG.	SPEC.	PART #
Type 01 Straight Wheels					
20 x 1 x 8	–	1,625	1	Norton Gemini A46-H	662532 46937
20 x 2 x 10	–	1,625	1	Norton Gemini A36-J	662532 46956
Type 07 Recessed Two Sides					
20 x 2 x 8	Recess 2 Sides 11-1/2 x 1/2	1,625	1	Norton Gemini 59A46-I	662532 46949
	Recess 2 Sides 11-1/2 x 1/2	1,625	1	Norton Gemini A46-G VSP	662532 46953
20 x 3 x 8	Recess 2 Sides 11-1/2 x 1/2	1,625	1	Norton Gemini A46-G VSP	662532 46972
	Recessed 2 Sides 11-1/2 x 1/2	1,625	1	Norton Gemini A46-H	662532 46969
	Recess 2 Sides 11-1/2 x 1/2	1,625	1	Norton Gemini A46-I	662532 46960
20 x 3 x 10	Recess 2 Sides 12-1/4 x 3/4	1,625	1	Norton Gemini 59A46-I VSP	662530 58315
	Recess Side A 12-1/2 x 1/2, Side B 12-1/2 x 1	1,625	1	Norton Gemini A36-J VSP	662532 46980
	Recess Side A 12-1/2 x 1/2, Side B 12-1/2 x 1	1,625	1	Norton Gemini A46-D VSP	662532 46988

There are many more sizes and specifications available made-to-your-order. Contact your Norton representative with your custom requirements.

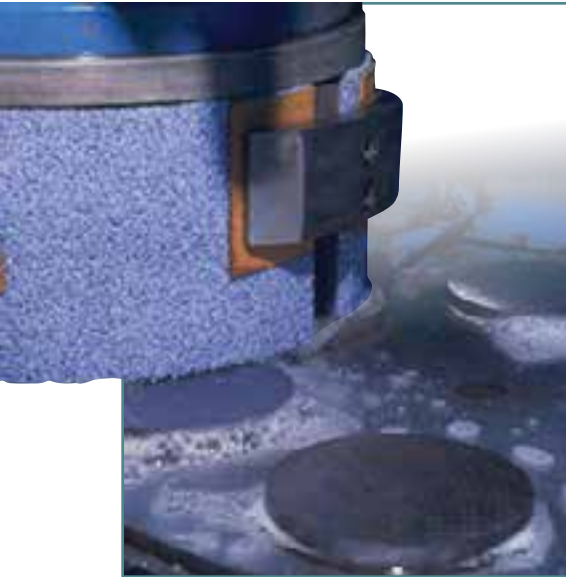

Surface grinding segments are generally used to grind flat stock or flat surfaces within a workpiece. The segment moves over the workpiece in a flat plane or vice versa. Applications can vary from heavy, rapid stock removal to precision tolerance operations.

- Applications:**
- Vertical spindle surface grinding
 - Grinding large molds, dies and plates
 - Producing flat stock
 - Sharpening knives, blades, cutlery
- Abrasive Grain:** Ceramic Alumina, Aluminum Oxide

Material-to-Product Recommendation Guide

MATERIAL	HEAVY-DUTY				GENERAL-DUTY		
	QuantumX 20-G	QuantumX 30-F	86A24-G20VTX2	86A30-E20VTX2	Gemini 30-E	Gemini 30-F	Gemini 30-G
Aluminum				◆	◆		
Bronze (hard)							◆
Cast Iron	◆						◆
Hastalloy			◆		◆		
Inconel		◆			◆		
Hardened Steel	◆				◆		
High Speed Steel	◆				◆		
Soft Steel			◆	◆			◆
Stainless Steel 300				◆	◆		
Stainless Steel 400						◆	

Segment Blueprints

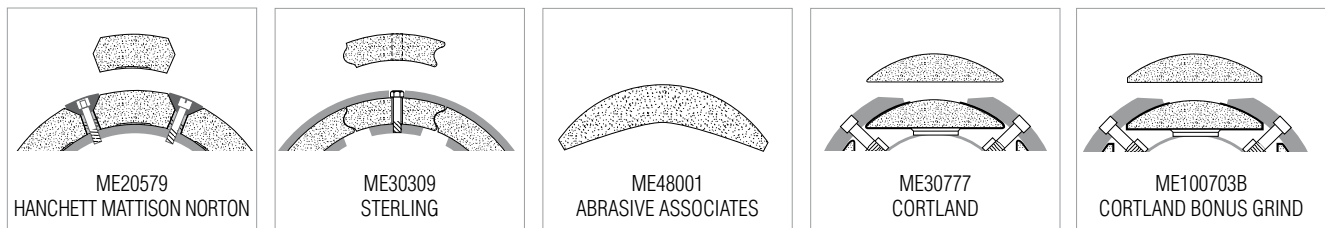

Troubleshooting Guide

PROBLEM	CORRECTION
Segment acting too hard	Increase rate of downfeed Increase table rotation speed (watch amp-meter) Dress more frequently Consider reducing area of table load
Segment acting too soft	Decrease rate of downfeed Decrease table rotation speed Check for abnormal machine vibration
Glazing and/or burning	Choose a softer grade Increase table speed (watch amp-meter)

TECH TIP

- Choose as coarse a grit size as possible in order to remove stock as quickly as possible (in big chips).
- To maximize production, choose the hardest grade possible that will not overload the machine.

It is the user's responsibility to refer to and comply with ANSI B7.1

Best choice for all low-, medium-, and high-force applications ranging from cast iron, to stainless steel and hard-to-grind alloys

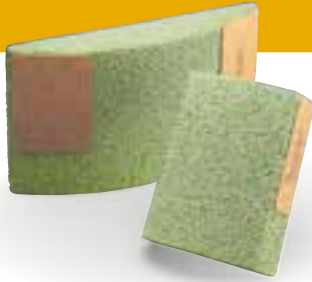

QUANTUM AND QUANTUM X CERAMIC ALUMINA

- Revolutionary, versatile engineered ceramic grain shape and chemistry produce highest productivity with the lowest total grinding costs
- 33% to 100% longer life versus competitive ceramic products, 30% plus higher metal removal rate, with 15% plus lower threshold power
- Excellent performance on both old and new machines

Better choice for versatile, consistent performance



86A ALUMINUM OXIDE

- Sharper aluminum oxide abrasive grain delivers cooler-cutting, consistent performance
- Segments available for Hanchett, Mattison Norton, Sterling, Abrasive Associates, Cortland, and Cortland Bonus Grind machines
- Better choice with porous vitrified bond for increased chip clearance and cool cutting in heat-sensitive applications

Good choice when a broad variety of parts are ground on a few machines



GEMINI ALUMINUM OXIDE BLEND

- Specially blended aluminum oxide abrasive for many surface grinding applications
- The porous vitrified bond increases chip clearance and maximizes coolant flow, reduces loading, and is cool cutting in heat-sensitive applications
- For use in Hanchett, Mattison, and Norton, and Cortland and Cortland Bonus Grind chucks on surface grinding machines

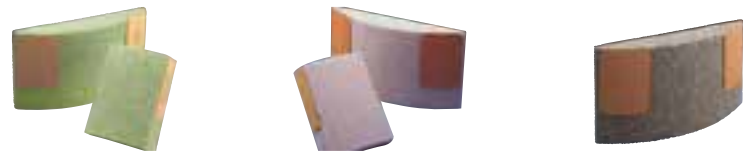

		TIER: BEST		TIER: BETTER		TIER: GOOD				
		TRADENAME: QUANTUM/QUANTUM X		TRADENAME: 86A		TRADENAME: GEMINI				
		ABRASIVE: Ceramic Alumina		ABRASIVE: Aluminum Oxide		ABRASIVE: Aluminum Oxide Blend				
WIDTH	THICK	HEIGHT	BLUEPRINT NO.	STD. PKG.	SPEC.	UPC NO.	SPEC.	UPC NO.		
5	1-1/2	6	ME20579	8	QUANTUMX 20-G	662533 50603				
				8			86A24-H20VTX2	662533 50602	Gemini 30-E	662530 50295
				8			86A30-F12VBEP	614636 50273	Gemini 30-F	662530 50297
				8			86A24-G20VTX2	662533 50595	Gemini 30-G	662530 50299
6-13/16	1-1/2	6	ME30309	8						
				8			86A24-G20VTX2	662533 50595		
11	2-1/8	6	ME48001	5			86A24-G20VTX2	662533 50586		
11-1/4	2-1/4	6	ME30777	5	QUANTUMX 20-G	662533 50607	86A24-E12VBEP	614636 50279	Gemini 30-E	699366 99706
				5	QUANTUMX 20-H	662533 50608	86A24-G20VTX2	662533 50605	Gemini 30-F	699366 99709
				5	3NQP36-G12VSP	662532 51527			Gemini 30-G	699366 99710
				5			86A30-E12VBEP	614636 50285	Gemini 30-H	662434 47588
				5			86A30-F12VBEP	614636 50287		
				5			86A30-G12VBEP	614636 50289		
11-1/4	2-1/4	8	ME30777	5	QUANTUMX 20-G	662533 50612	86A24-G20VTX2	662533 50609	Gemini 30-E	699366 99712
				5	QUANTUMX 20-H	662533 50615			Gemini 30-F	699366 99716
				5	QUANTUMX 30-E	662533 87810	86A30-E20VTX2	662533 87812	Gemini 30-G	699366 99717
				5	QUANTUMX 30-F	662533 87811	86A30-F20VTX2	662533 87813	Gemini 30-H	662434 47591
				5	3NQP30-F12VSP	662532 38276			Gemini 30-I	662434 47592
				5			86A46-D12VBEP	614636 50442		
11-1/4	3	8	ME100703B	4	QUANTUMX 20-G	662533 50623	86A24-G20VTX2	662533 50617	Gemini 30-E	699366 99725
				4	QUANTUMX 20-H	662533 50624			Gemini 30-F	699366 99727
				4	QUANTUMX 30-E	662533 87808			Gemini 30-G	699366 99728
				4	QUANTUMX 30-F	662533 87809			Gemini 30-H	662434 47594
				4	3NQP30-F12VSP	690831 56473			Gemini 30-I	662434 47595
				4						
	1-5/8			10	Vitrified Burr Remover	614636 50268*				

*Minimum Quantity = 2



Cylindrical wheels are used most often when the part is held between centers and in chucks. There are three methods of cylindrical grinding: plunge, traverse, and angular.

- Plunge grinding – wheel is thrust or plunged into the part
- Traverse grinding – wheel moves across the part
- Angular grinding – wheel contacts the part at an angle

Typical Industries: Automotive, shipbuilding, engine building, bearing, land- and air-based turbine blades, and toolroom

Shape: Type 01 Straight, Type 05 Recessed One Side, and Type 07 Recessed 2 Sides

Size Range: 16", 18", 20", 24" and 30" diameter

Abrasive Grain: Ceramic Alumina and Aluminum Oxide

Stationary Dressing Tool Recommendations for Cylindrical Wheels

Grinding Wheel Diameter	Diamond Carat Weight	Single Point		Multi-Point (Grit)			Tool Product/Part #		Shape	
		Tool Product/Part #	0° Angle	Tool Product/Part #	Shape	Tool Product/Part #	15° Angle	Shape		
16" - 20"	3/4	BC7M7	662601 95007	BC62	662601 95012	1/4 x 1/2 Rect.	BC63	662601 95013	1/4 x 1/2 Rect.	
		NS7M7	662601 95132	2A6D7	662601 95046		2A6E7	662601 95049		
21" +	1	BC10M7	662601 95009	BC61	662601 95011	1/4 x 3/4 Rect.	BC60	662601 95010	1/4 x 3/4 Rect.	
		NS10M7	662601 95137	1A6A7	662601 95031		1A6C7	662601 95039		

NS Single Point Diamond Tools are resettable. BC Diamond Tools are not resettable. All tools specified above have 7/16" diameter shanks.

Troubleshooting Guide

PROBLEM	POSSIBLE CAUSES	SUGGESTED CORRECTION
Burn or cracks on workpiece	Wheel too hard	Try softer wheel or make wheel act softer (see Tech Tip on next page)
	Dress is too fine	Dress faster
	Nozzle not directing coolant properly	Redirect flow
	Work speed too slow or wheel speed too fast	Adjust speeds
	Wheel feed too slow causing excess contact time	Increase feed rate
Chatter marks on workpiece	Loose spindle, end play, bearing failure	Check wheel spindle on assembly
	Work drive faults, out-of-truth plate	Check gear action, truth, drive on pin pressure
	Wheel too hard, poor truing, poor mounting	Use softer grade; dress wheel correctly; secure mounting
Poor quality finish	Poor quality dressing	Reduce final depth of dress on wheel
	Diamond insecurely held	Check and replace diamond and secure properly
	Misalignment of head and tail stocks	Check for properly aligned workpiece
	Dirty coolant	Clean coolant frequently; use efficient filter
	Scored workpiece centers	Check and lap center holes as required

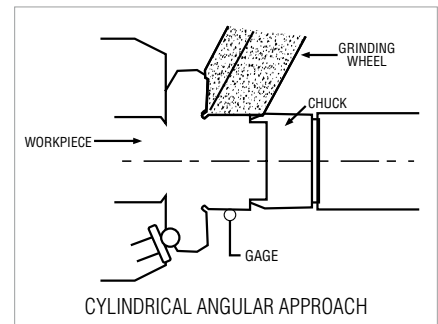
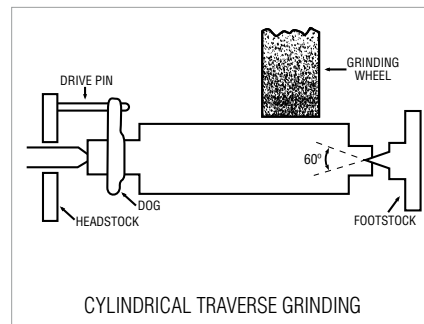
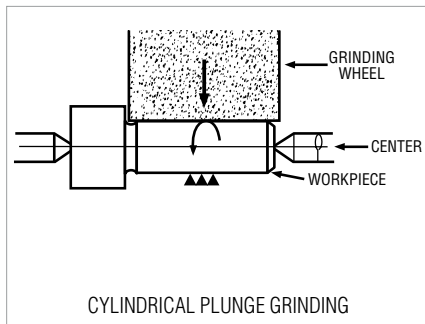

Best choice for highest productivity, lowest total per-part grinding cost

5SG CERAMIC ALUMINA/ALUMINUM OXIDE BLEND

- Exceptionally high-performing seeded gel ceramic alumina and friable aluminum oxide abrasive blend for fast stock removal, cool, superior cutting; 3 - 5 times more life than aluminum oxide wheels; 2 times stock removal rate vs. conventional abrasives
- High-performance versatile bond for cylindrical and surface grinding high-speed tool steels, hardened and soft steels, and aerospace alloys: exceptional form holding
- Self-sharpening abrasive minimizes burn and required dressing, to maximize sharp edge on tools and dies for longer life in production

Better choice for medium to heavy stock removal

32A ALUMINUM OXIDE

- Exceedingly strong, sharp monocrystalline aluminum oxide grain, for precision production medium to heavy stock removal applications
- The most versatile vitrified bond, especially recommended for toolroom, cylindrical, and surface grinding
- Grinds with an exceptional cool; fast cutting action, requires minimum dressing

Better choice for longer wheel life

86A ALUMINUM OXIDE

- Premium abrasive and superior bond system produce high grinding G-Ratios (metal removal/wheel wear) for increased productivity
- Hold form for better part geometry; decreased dress frequency and/or dress compensation
- Engineered for easy use, grind cycles do not need to be altered, no special operator training is needed

Good choice for versatile performance at an economical price

64A ALUMINUM OXIDE BLEND

- Specially blended aluminum oxide abrasive for production cylindrical applications
- A superior vitrified bond that maintains high grinding rates without wheel breakdown
- Good choice for small job shops grinding numerous materials on a few machines

Good choice for smallest volume, lowest initial price applications

GEMINI 2 ALUMINUM OXIDE

- Upgraded aluminum oxide abrasive blend delivers an efficient cut rate and improved grinding wheel life to your precision operations
- Made in the USA, these quality, low initial price wheels are ideal for small- to medium-sized manufacturing facilities that perform a variety of jobs
- Carefully chosen, versatile specifications and sizes meet many cylindrical and surface grinding requirements



		TIER: BEST		BETTER		GOOD	
TRADENAME: 5SG		Ceramic Alumina / Aluminum Oxide		Aluminum Oxide		Aluminum Oxide	
SIZE (D x T x H)	STD. PKG.	SPEC.	PART #	SPEC.	PART #	SPEC.	PART #
Type O1 Straight							
16 x 1 x 5	1	5SG60-JVS	662534 67007	32A60-J8VBE	662534 64836	64A60-K8V127	662534 66722
	1			32A60-K5VBE	662534 64837	Gemini2 60-I	662434 97801
	1					Gemini2 60-K	662434 95077
	1					Gemini2 60-M	662434 97802
	1					Gemini2 100-I	662434 97804
	1					Gemini2 100-K	662434 97806
	1					Gemini2 100-M	662434 97807
16 x 1 x 8	1			32A60-K5VBE	662534 64826		
16 x 1-1/2 x 5	1	5SG60-KVS	662534 67010	32A46-H8VBE	662534 64925		
16 x 2 x 5	1			32A46-J8VBE	662534 64995	64A60-K8V127	662534 66721
	1			32A60-K5VBE	662534 64960	Gemini2 60-I	662434 97810
	1					Gemini2 60-K	662434 95078
	1					Gemini2 100-I	662434 97812
16 x 3 x 5	1					Gemini2 100-K	662434 97815
	1					Gemini2 60-I	662434 97820
	1					Gemini2 100-I	662434 97821
18 x 1 x 5	1					Gemini2 60-I	662434 83777
	1					Gemini2 60-K	662434 97610
	1					Gemini2 60-M	662434 97611
	1					Gemini2 100-I	662434 97612
	1					Gemini2 100-K	662434 97613
	1					Gemini2 100-M	662434 97615
	1						
18 x 2 x 5	1					64A60-K8V127	662534 66719
	1					Gemini2 60-I	662434 83779
	1					Gemini2 60-K	662434 97618
	1					Gemini2 100-I	662434 97619
18 x 3 x 5	1					Gemini2 100-K	662434 97620
	1					Gemini2 60-I	662434 83780
	1					Gemini2 100-I	662434 97621
	1						
20 x 1 x 8	1			86A60-J8V127	690786 08982	Gemini2 60-I	662434 83782
	1			86A80-J8V127	690786 08983	Gemini2 60-K	662434 97840
	1					Gemini2 60-M	662434 97841
	1					Gemini2 100-I	662434 97842
	1					Gemini2 100-K	662434 97843
	1					Gemini2 100-M	662434 97846
20 x 1 x 10	1					Gemini2 60-I	662434 95332
	1					Gemini2 60-K	662434 97789
	1					Gemini2 60-M	662434 97791
	1					Gemini2 100-I	662434 97793
	1					Gemini2 100-K	662434 97796
	1					Gemini2 100-M	662434 97798
20 x 1 x 12	1					Gemini2 60-I	662434 83787
	1					Gemini2 60-K	662434 97827
	1					Gemini2 60-M	662434 97831
	1					Gemini2 100-I	662434 97835
	1					Gemini2 100-K	662434 97837
	1					Gemini2 100-M	662434 97838
20 x 1-1/2 x 5	1			32A46-H8VBE	690786 65382		
20 x 2 x 5	1					64A60-J8V127	690786 66713
20 x 2 x 8	1			32A46-I8VBE	690786 65433	64A60-K8V127	690786 66712
	1			32A60-K5VBE	690786 65490	Gemini2 60-I	662434 83785
	1					Gemini2 60-K	662434 97855
	1					Gemini2 100-I	662434 97856
	1					Gemini2 100-K	662434 97857
20 x 2 x 10	1					Gemini2 60-I	662434 95334
	1					Gemini2 60-K	662434 97848
	1					Gemini2 100-I	662434 97849
	1					Gemini2 100-K	662434 97850
	1						
20 x 2 x 12	1			32A46-I8VBE	690786 65455	Gemini2 60-I	662434 83788
	1					Gemini2 60-K	662434 97851
	1					Gemini2 100-I	662434 97852
	1					Gemini2 100-K	662434 97854

For additional stock cylindrical wheels, see the large surface grinding wheel section of this catalog

Contact your Norton representative with your custom cylindrical wheel requirements. There are many more sizes and specifications available made-to-your-order, including wheels made from Norton 55A and Quantum blank stock. Our revolutionary Norton Quantum and Vitrium³ bond ceramic wheels bring a quantum leap in technology to your operation. See 55A and Quantum Blank Stock FastTrack Service catalog sections for more details.

TIER: BEST		BETTER		GOOD	
TRADENAME: 55G		32A, 86A		64A, GEMINI, OR GEMINI2	
ABRASIVE: Ceramic Alumina / Aluminum Oxide		Aluminum Oxide		Aluminum Oxide	
SIZE (D x T x H)	STD. PKG.	SPEC.	PART #	SPEC.	PART #
Type 01 Straight					
20 x 3 x 8	1			64A46-18V127	690786 66447
	1			64A60-J8V127	690786 08140
	1			Gemini2 60-I	662434 83786
20 x 3 x 10	1			Gemini2 100-I	662434 97862
	1			Gemini2 60-I	662434 95333
	1			Gemini2 100-I	662434 97859
20 x 3 x 12	1			Gemini2 60-I	662434 83789
	1			Gemini2 100-I	662434 97860
24 x 1 x 12	1			Gemini2 60-I	662434 83790
	1			Gemini2 60-K	662434 97863
	1			Gemini2 100-I	662434 97866
	1			Gemini2 100-K	662434 97868
24 x 2 x 12	1			Gemini2 100-M	662434 97870
	1			64A60-K8V127	690831 66710
	1			64A80-K8V127	690831 66711
	1			Gemini2 60-I	662434 83792
	1			Gemini2 60-K	662434 97872
24 x 3 x 12	1			Gemini2 100-I	662434 97873
	1			Gemini2 100-K	662434 97874
	1			Gemini2 60-I	662434 83793
	1			Gemini2 100-I	662434 97877
30 x 2 x 12	1			64A60-J8V127	692104 66704
	1			Gemini2 60-J	662434 97878
	1			Gemini2 60-L	662434 97986
30 x 3 x 12	1			64A60-J8V127	692104 66697
	1			64A60-K8V127	692104 66698
	1			Gemini2 60-J	662434 97987
	1			Gemini2 60-L	662434 97988
30 x 4 x 12	1			64A60-J8V127	692104 01774
	1			Gemini2 60-J	662434 97989
	1			Gemini2 60-L	662434 97990
Type 07 Recessed Two Sides					
18 x 2 x 8	1		32A46-18VBE	662534 65110	
Rec 2/S 10-1/2 x 1/2					
20 x 2 x 8	1		32A46-18VBE	690786 65537	
Rec 2/S 11-1/2 x 1/2					
20 x 3 x 8	1		32A46-18VBE	690786 65686	
Rec 2/S 11-1/4 x 1/2					
20 x 3 x 8	1			Gemini 46-H	662532 46969
Rec 2/S 11-1/2 x 1/2					
20 x 3 x 10	1		32A46-18VBE	690786 65575	
Rec 2/S 12-1/4 x 5/8					
20 x 6 x 10	1		32A46-18VBE	690786 65854	
Rec Side A 12-1/4 x 2					
Rec Side B 12-1/4 x 1					

For additional stock cylindrical wheels, see the large surface grinding wheel section of this catalog

Contact your Norton representative with your custom cylindrical wheel requirements. There are many more sizes and specifications available made-to-your-order, including wheels made from Norton 55A and Quantum blank stock. Our revolutionary Norton Quantum and Vitrium³ bond ceramic wheels bring a quantum leap in technology to your operation. See 55A and Quantum Blank Stock FastTrack Service catalog sections for more details.

TECH TIP

To make a wheel act softer:

- Increase work speed
- Increase traverse speed
- Increase infeed
- Decrease wheel speed
- Increase dresser traverse rate
- Increase depth of dress per traverse
- Dress more often

To make a wheel act harder:

- Decrease work speed
- Decrease traverse speed
- Decrease infeed
- Increase wheel speed (do not exceed MAX RPM marked on wheel)
- Dress at slower traverse rate
- Decrease depth of dress per traverse



It is the user's responsibility to refer to and comply with ANSI B7.1



Centerless grinding is a production process that produces extremely close tolerances on metal cylindrical forms or parts. Centerless grinding is used on a wide variety of workpieces. The key components in the process are the grinding wheel, the work rest blade (used to support the work) and the regulating or “feed” wheel (the drive mechanism for the workpiece).

Applications:

- High production operations on large volume continuous grinding
- Parts ranging from miniature roller bearings to train axles and bearings
- Fastener and tool manufacturing
- Steel mills
- Automotive related components
- Bearing
- Machine tools
- Aircraft
- Turbine blades – land- and air-based

Shape:

Centerless wheels: Type 01 Straight
 Feed wheels: Type 01 Straight and Type 07 Recessed 2 Sides

Size Range:

Centerless wheels: 16", 20", and 24" diameter
 Feed wheels: 12" and 14" diameter

Abrasive Grain:

Ceramic Alumina, Aluminum Oxide, Aluminum Oxide/Silicon Carbide Blend

Material-to-Product Recommendation Guide

	55A60-KVS3	55A80-LVS3	32AC90-QB	32AC54-QB	2NQMC54-QB45
Alnico	◆			◆	
Cast Iron	◆			◆	
Hastalloy	◆				
Inconel	◆				
Stainless	◆				
Stainless Steel 300	◆				
Stainless Steel 400	◆				
Steel - Hard or Soft					
Less than 1/2" Diameter		◆			
5/8" to 2 1/2" Diameter	◆				
Over 2 1/2" Diameter	◆				◆
High Speed (commercial finish)	◆				◆
High Speed (fine finish)			◆		

Stationary Dressing Tool Recommendations for Centerless Wheels

Grinding Wheel Diameter	Diamond Carat Weight	Single Point	Indexable Single Point	Multi-point (Grit)		Tool Product # Part # 15° Angle	Shape
		Tool Product # Part # 0° Angle	Tool Product # Part # 0° Angle	Tool Product # Part # 0° Angle	Shape		
11" - 14"	1/2	BC5M7 662601 95005	BCUD5 662601 95025	BC65 662601 95015	3/8 Round	BC63 662601 95013	1/4 x 1/2
		NS5M7 662601 95127	NSUD5 662601 95163	2R6K7 662601 95096		2A6E7 662601 95049	Rectangle
15" - 20"	3/4	BC7M7 662601 95007	N/A	BC62 662601 95012	1/4 x 1/2	BC63 662601 95013	1/4 x 1/2
		NS7M7 662601 95132	NSUD7 662601 95164	2A6D7 662601 95046	Rectangle	2A6E7 662601 95049	Rectangle
21" +	1	BC10M7 662601 95009	N/A	BC61 662601 95011	1/4 x 3/4	BC60 662601 95010	1/4 x 3/4
		NS10M7 662601 95137	NSUD10 662601 95165	1A6A7 662601 95031	Rectangle	1A6C7 662601 95039	Rectangle

Stationary Dressing Tool Recommendations for Feed Wheels

Feed Wheel Diameter	Tool Carat Weight	Tool Shank Diameter	Indexable Single Point	
			Tool Product #	Tool Part #
Up to 14"	1/2	7/16"	NSUD5	662601 95163

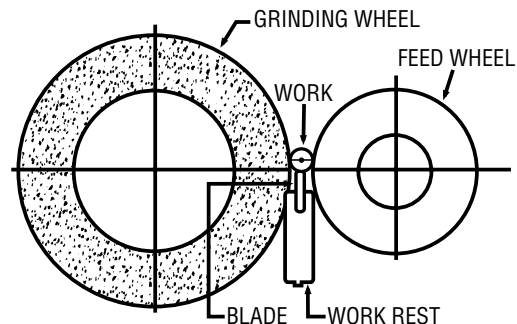

TECH TIP

Proper Wheel Mounting

1. Thoroughly clean spindle and flange bearing area of all dirt and foreign material.
2. Inspect for worn, distorted or damaged areas on flanges and spindle.
3. If mounting a wide centerless wheel on a spindle (i.e., twin-grip), do not use grease or other petroleum lubricants. Use a silicone spray lubricant on the spindle to ease mounting the wheel, if necessary.
4. Ensure mount up arrow is at the top of the wheel. In the case of butted sets, assemble so that the arrow is formed across the top of the wheel face.
5. Ensure proper blotters are installed; one on each flange mating surface. Always use new blotters.
6. Install blotter flange and snug up the bolts only finger tight.
7. Using a torque wrench, tighten all bolts in an alternating pattern from side to side to 15 foot pounds.
8. Repeat the same tightening sequence, increasing the torque to 35 foot pounds.
 - » for wide wheels (18"-20"), torque the bolts at 45 to 50 foot pounds
 - » for narrower wheels (2"-12"), a torque of 35 foot pounds is sufficient
9. Retorque the flange bolts to specification after the first eight hours of operation.

TECH TIP

- Use vitrified bond wheels for form holding and plunge grinding
- Use resinoid bond wheels for stock removal, long irregular parts and faster throughfeed grinding
- Vitrified Centerless Wheel Speeds:
 - » 64A46-KVCE wheels: 6,500 SFPM max. operating speed
 - » All other vitrified centerless stock products: 8,500 SFPM max. operating speed
 - » Always check wheel speed markings on wheels before running wheel



It is the user's responsibility to refer to and comply with ANSI B7.1

TECH TIP

To make a wheel act softer:

- Increase work speed/regulating wheel speed
- Increase throughput speed/regulating wheel speed
- Increase infeed
- Decrease wheel speed
- Dress at a faster traverse rate

To make a wheel act harder:

- Decrease work speed/regulating wheel speed
- Decrease throughput speed/regulating wheel speed
- Decrease infeed
- Increase wheel speed (observe safe limits)



Best choice for cast iron to stainless and hard-to-grind materials and alloys (titanium, Inconel...)

QUANTUM (2NQ) CENTURY45 CERAMIC ALUMINA

- Proprietary 2NQ ceramic abrasive and Century45 (B45) resin bond formulation engineered specifically to maximize productivity of centerless applications
- Achieve over 30% improvement of stock removal, and up to 50% reduction in cycle time
- Less grinding noise significantly improves operator safety

Better choice for performance to price ratio



55A-VS3 ALUMINUM OXIDE

- Monocrystalline 55A aluminum oxide offers superior performance on centerless plunge and throughfeed surface grinders with 2 plus times the life of competitive aluminum oxide wheels
- Vitrium 3 VS3 bond allows cool cutting, high-speed, and precise form holding
- Ideal for simple- to complex-shaped components, with increased productivity; more quality parts at low cost per part

Better choice when one wheel is used to grind several different materials

32AC ALUMINUM OXIDE / SILICON CARBIDE BLEND

- Aluminum oxide/silicon carbide abrasive blend in a strong resin bond is ideal when one wheel is used to grind several different materials from high-to-low tensile strength
- Norton resin bond centerless wheels are the choice for stock removal, long irregular paths, and faster through feed grinding
- Ideal for full range of simple- to complex-shaped components

Good choice for hard-to-grind fasteners

57A ALUMINUM OXIDE WITH FINE / HARD SIDE

- Tough, durable aluminum oxide abrasive for heavy duty work
- Superior vitrified bond system for longer wheel life and excellent form holding when toolroom and centerless grinding
- 3/16 inch thick fine/hard side provides good form holding while grinding stainless and Inconel fasteners

Good choice for grinding a variety of materials, economically

64A ALUMINUM OXIDE BLEND

- Good intermediate type aluminum oxide abrasive blend for production centerless applications
- A superior vitrified bond that maintains high grinding rates without wheel breakdown
- Good choice for small job shops grinding numerous materials on a few machines

Good choice for smallest volume, lowest initial price applications

GEMINI 2 ALUMINUM OXIDE

- Upgraded aluminum oxide abrasive blend delivers an efficient cut rate and improved grinding wheel life to your precision operations
- Made in the USA, these quality, low initial price wheels are ideal for small- to medium-sized manufacturing facilities that perform a variety of jobs
- Carefully chosen, versatile specifications and sizes meet many centerless grinding requirements

Centerless Wheels

		TIER: BEST		BETTER		BETTER		EXPANDED OFFERING		GOOD	
TRADENAME:		QUANTUM CENTURY45 CENTERLESS RESINOID WHEELS		32AC / 32AC CENTURY 45 CENTERLESS RESINOID WHEELS		55A CENTERLESS VITRIFIED WHEELS				53A, 57A, 64A, GEMINI, GEMIN2 CENTERLESS VITRIFIED WHEELS	
ABRASIVE:		Ceramic Alumina		Aluminum Oxide/Silicon Carbide		Aluminum Oxide				Aluminum Oxide	
SIZE (D x T x H)	STD. PKG.	SPEC.	PART #	SPEC.	PART #	SPEC.	PART #	SPEC.	PART #	SPEC.	PART #
Type 01 Straight											
16 x 4 x 10	1							57A80-L8VCN	662534	65001	
20 x 2 x 12	1										
20 x 4 x 12	1										
	1							64A60-KVCE	690786	66723	
	1							64A80-LVCE	690786	66727	
20 x 6 x 12	1	2NQMC54-QB45	662434 96406	32AC80-NB45	662434 96398	55A60-KVS3	662533 87817	64A60-KVCE	690786	66729	
	1			32AC54-QB	690786 66545	55A80-LVS	662534 90781	Gemini 60-L	662532	46994	
	1					55A80-MVS	662534 90788				
20 x 8 x 12	1	2NQMC54-QB45	662434 96407	32AC80-NB45	662434 96400	55A60-KVS3	662533 87819	64A60-KVCE	690786	66748	
	1			32AC54-QB	690786 66546	55A80-LVS	662534 90783	64A60-LVCE	690786	66749	
	1					55A80-MVS	662534 90785	64A80-KVCE	690786	66751	
	1							Gemini 54-J	662532	47001	
	1							Gemini2 60-K	662534	51857	
24 x 1-1/2 x 12	1							57A 80/120 O/Q	662531	193575	
w/ 3/16" fine/hard layer	1							57A 80/120 P/R	662533	54449	
24 x 2-1/2 x 12	1							57A A80/120 P/R	662534	91223	
24 x 2-1/2 x 12	1							57A 80/120 O/Q	662532	85629	
w/ 3/16" fine/hard layer	1							57A 80/120 P/R	662533	40540	
24 x 3 x 12	1							64A60-K8V127	690831	66708	
24 x 4 x 12	1							Gemini2 60-K	662534	51860	
	1							Gemini2 100-L	662534	51861	
24 x 6 x 12	1	2NQMC54-QB45	662434 96408	32AC80-NB45	662434 96401	55A80-LVS3	662533 87821	Gemini 60-K	662532	47047	
	1			32AC54-QB	690831	66547		Gemini2 60-K	662534	51862	
24 x 8 x 12	1	2NQMC54-QB45	662434 96409	32AC80-NB45	662434 96403	55A60-KVS	662534 90791	Gemini2 60-K	662534	51864	
	1			32AC54-QB	690831	66548	55A60-LVS	662534	90762		
	1						55A80-LVS3	662533	87825		
	1						55A60-MVS	662534	90782		
24 x 10 x 12	1	2NQMC54-QB45	662434 96410	32AC80-NB45	662434 96404	55A60-KVS3	662533 87830	Gemini2 60-K	662534	51866	
	1			32AC54-QB	690831	66549	55A80-LVS3	662533	87828		
24 x 20 x 12	1			32AC54-QB	690831	66552					
Composed of 2 Wheels 10" Thick (ME90362)	1			32AC54-SB	690831	66553					

Rubber Bond Feed Wheels

		TIER: BETTER	
ABRASIVE:		Aluminum Oxide	
SIZE (D x T x H)	STD. PKG.	SPEC.	PART #
Type 01 Straight			
12 x 2 x 5	1	57A80-RR51	662532 22840
Type 07 Recessed Two Sides			
12 x 4 x 5	1	57A80-RR51	662532 22844
Rec 2 Sides 7-1/2 x 1/2			
12 x 6 x 5	1	57A80-RR51	662532 22846
Rec Side A 7-1/2 x 1-1/2			
Rec Side B 7-1/2 x 1/2			
12 x 6 x 5	1	57A80-RR51	662532 22847
Rec 2 Sides 7-1/2 x 1-1/2			
12 x 8 x 5	1	57A80-RR51	662532 22850
Rec Side A 7-1/2 x 2-1/2			
Rec Side B 7-1/2 x 1-1/2			
14 x 8 x 5	1	57A80-RR51	662533 22859
Rec Side A 8 x 2			
Rec Side B 8 x 1-1/2			
14 x 20 x 6	1	57A80-RR51	662533 22196
Rec 2 Sides 8-1/2 x 1-1/2			
Butted Feed Wheels Composed of 2 Wheels 10" Thick (ME91512)			

Plastic Bond Feed Wheels

		TIER: BETTER	
ABRASIVE:		Aluminum Oxide	
SIZE (D x T x H)	STD. PKG.	SPEC.	PART #
Type 07 Recessed Two Sides			
12 x 8 x 5	1	57A80-RP4	662532 22199
Rec Side A 7-1/2 x 2-1/2			
Rec Side B 7-1/2 x 1-1/2			

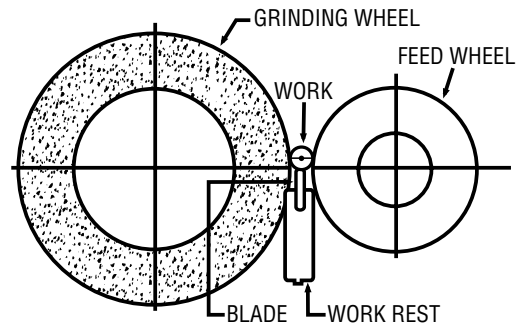

There are many more sizes and specifications available made-to-your-order, including wheels made from our blank stock FastTrack Service for rush orders. Contact your Norton representative with your custom centerless requirements.

Creepfeed Blank Stock FastTrack Service



Norton creepfeed wheels are the best performing creepfeed wheels in the industry. These high-performance blank stock wheels can be altered to your dimensional requirements.

- Applications:** Heat-sensitive, porous grinding of difficult-to-grind alloys
- Typical Industries:** Aerospace, automotive, toolroom, gear, energy
- Size Range:** Blank Stock: 16" – 25" diameter
Finished Wheel: 14" – 25" diameter
- Grade/Porosity:** C28 – F26
- Abrasive Grain:** Ceramic Alumina, Fused Aluminum Oxide

Best choice for versatility, maximum performance, and highest productivity



QUANTUM X CERAMIC ALUMINA AND VORTEX ALUMINUM OXIDE BLEND

- Leading Norton technologies produce the most free-cutting creepfeed wheel: patented pore-induced construction, a blend of Norton Quantum ceramic and Vortex aluminum oxide abrasives, and the newest, strongest Norton bond: Vitrium
- Excel on large area of contact applications with exceptional form and corner-holding and 20+% less power draw; best MRR vs. all other ceramic creepfeed wheels, with reduced cycle times of up to 50%
- Versatile; for all low-, medium- and high-force applications on hard-to-grind Inconel, titanium, and aerospace alloys

Better choice for heat-sensitive, porous grinding of difficult-to-grind alloys



VORTEX ENGINEERED ALUMINUM OXIDE

- High-performance, engineered and optimally spaced fused aluminum oxide abrasive
- High metal removal rates; able to grind large areas of contact with exceptional part integrity and quality and superior surface finish
- Long wheel life: dramatically shorter grinding cycles = less wheel changes and more parts/wheel = high productivity

Key Program Features

- Standard lead-time: 2 weeks
- Alteration Parameters:
 - » Diameter may be altered to 2" smaller than the original blank stock diameter
 - » Thickness may be altered to 1/2 the original blank stock thickness
 - » Bore may be altered to these parameters 5" altered up to 8" max. 8" altered up to 12" max.

TIER: BEST		BETTER		
TRADENAME: QUANTUM X 3NQX, TG CERAMIC UNFINISHED BLANK STOCK		VORTEX A/O UNFINISHED BLANK STOCK		
SIZE (D x T x H)	SPEC.	UF BLANK PART #	SPEC.	UF BLANK PART #
Type O1 Straight				
12 x 1.750 x 3	3NQX60/1-D24VTX2	003105	01586	
12 x 3.500 x 3	3NQX60/1-E24VTX2	003105	01589	
12 x 1 x 3	3NQX60/1-E24VTX2	003105	01590	
12 x 3 x 3	TG2120/1-E24VTX2	003105	01591	
12 x 3.500 x 3	3NQX60/1-C28VTX2	003105	03234	
12 x 1.500 x 3	3NQX60/1-C28VTX2	003105	03235	
16 x 1 x 5	3NQX60-C28VTX2	003104	38575	
	3NQX60-D28VTX2	003104	25238	
	3NQX60-D+28VTX2	003104	79157	
	3NQX60-E24VTX2	003104	25239	
	3NQX80-E+28VTX2	003104	79160	
16 x 3 x 5	3NQX60-C28VTX2	003104	38656	
	3NQX60-D28VTX2	003104	25240	
	3NQX60-D+28VTX2	003104	79158	
	3NQX60-E24VTX2	003104	25241	
	3NQX80-D+28VTX2	003104	79163	
	3NQX80-E+28VTX2	003104	79161	
16 x 4 x 5				IPA60-D29VTX 003103 12485
				IPA60-E26VTX 003103 12486
16 x 5 x 5	3NQX60-D28VTX2	003104	25242	
	3NQX60-E24VTX2	003104	25243	
16 x 6 x 5	3NQX60-C28VTX2	003104	38657	
	3NQX80-D+28VTX2	003104	79164	
	3NQX80-E+28VTX2	003104	79162	
20 x 1 x 8	3NQX60-C28VTX2	003104	38658	
	3NQX60-D28VTX2	003104	25244	
	3NQX60-E24VTX2	003104	25245	
20 x 2-1/2 x 8				IPA60-E26VTX 003103 03130
				IPA60-F17VTX 003103 03131
				IPA80-D29VTX 003103 03132
20 x 3 x 8	3NQX60-C28VTX2	003104	38659	
	3NQX60-D28VTX2	003104	25256	
	3NQX60-E24VTX2	003104	25257	
20 x 4 x 8				IPA60-D29VTX 003103 03133
				IPA60-E26VTX 003103 03134
20 x 5 x 8	3NQX60-D28VTX2	003104	25258	
	3NQX60-E24VTX2	003104	25259	
20 x 6 x 8	3NQX60-C28VTX2	003104	38660	
24 x 4 x 8				IPA60-C29VTX 031039 25091
				IPA60-D29VTX 003104 06547
				IPA60-F26VTX 003103 03135
25 x 2-1/2 x 8				IPA60-E26VTX 003104 04613
25 x 3-1/2 x 8				IPA60-E26VTX 003104 04678



Quantum Blank Stock FastTrack Service



The newest-generation ceramic Norton Quantum vitrified wheels deliver the highest productivity of any wheel in the marketplace. They will grind with superior results in many applications. They can be altered to your specific needs within two weeks of receipt of your order.

- Applications:**
- Centerless plunge and throughfeed grinding
 - Surface grinding
 - Cylindrical grinding
- Size Range:**
Blank Stock: 18" – 30" diameter
Finished Wheel: 16" – 30" diameter
- Grit Range:** 60, 80, and 120
- Grade Range:** I – M
- Abrasive Grain:** Ceramic Alumina

Best choice for versatility, maximum performance, and cost savings



QUANTUM CERAMIC ALUMINA

- Revolutionary, sharp, durable engineered ceramic alumina grain shape and chemistry; highly-porous
- Perform well on old and new machines with 30%+ higher metal removal rate and 15%+ lower threshold power; achieve highest productivity with lowest total grinding cost
- Versatile; for all low-, medium- and high-force applications ranging from cast iron, to stainless steel and hard-to-grind Inconel and titanium

TIER: **BEST**

TRADENAME: **QUANTUM CERAMIC UNFINISHED BLANK STOCK**

SIZE (D x T x H)	SPEC.	UNFINISHED BLANK PART #
Type 01 Straight		
18 x 1 x 5	3NQ80-K10VS	003104 05993
18 x 2 x 5	3NQ80-K10VS	003104 05994
18 x 3 x 5	3NQ80-K10VS	003104 05995
20 x 1 x 8	3NQ80-K10VS	003104 05985
20 x 1 x 12	3NQ80-K10VS	003104 06017
	3NQ120-MVS	003104 05924
20 x 2 x 8	3NQ80-K10VS	003104 06036
20 x 3 x 8	3NQ80-K10VS	003104 06037
20 x 6 x 12	3NQ80-L10VS	003104 06018
20 x 8 x 12	3NQ80-L10VS	003104 06026
24 x 1 x 8	3NQ80-K10VS	003104 06034
24 x 1 x 12	3NQ80-K10VS	003104 06038
24 x 2 x 8	3NQ80-K10VS	003104 06035
24 x 2 x 12	3NQ80-K10VS	003104 06029
24 x 3 x 8	3NQ60-J10VS	003104 25121
	3NQ80-K10VS	003104 06046
24 x 3 x 12	3NQ60-J10VS	003104 25120
	3NQ80-K10VS	003104 06030
24 x 6 x 12	3NQ80-L10VS	003104 06031
24 x 8 x 12	3NQ80-L10VS	003104 06032
24 x 10 x 12	3NQ80-L10VS	003104 06033
30 x 2 x 12	3NQ80-I10VS	003104 27211
	3NQ80-J10VS	003104 06047
	3NQ80-K10VS	003104 06048
30 x 3 x 12	3NQ60-I10VS	003104 27212

There are many finished sizes and specifications available. Contact your local Norton distributor or salesperson with your size and specification requirements for quantity guidelines, quotations and helpful ordering instructions.

Please note "2-week delivery request" if needed, on your order.

55A Blank Stock FastTrack Service

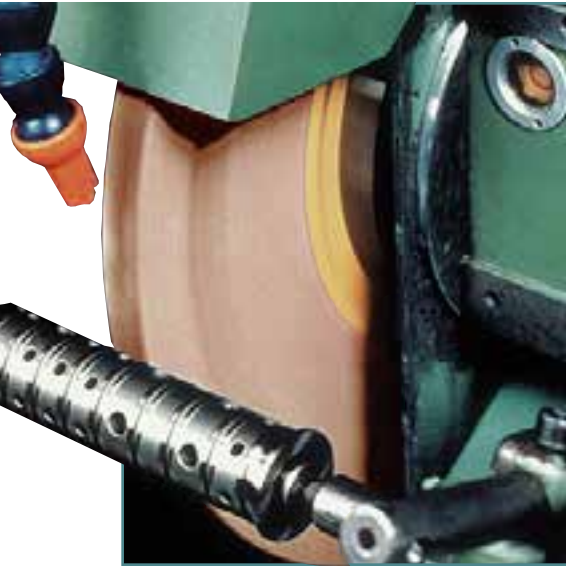

55A-VH blank stock wheels are competitively-priced, monocrystalline grain wheels specifically engineered for numerous carbon steel applications requiring moderate to heavy stock removal rates. They can be altered to your specific needs within two weeks of receipt of your order.

- Applications:** Centerless plunge and throughfeed grinding
Surface grinding
Cylindrical grinding
- Size Range:** Blank Stock: 18" – 42" diameter
Finished Wheel: 16" – 42" diameter
- Grit Range:** 60 – 120
- Grade Range:** I – M
- Abrasive Grain:** Aluminum Oxide

Better choice for precision grinding of carbon steel and cast iron



55A-VH ALUMINUM OXIDE

- Advanced combination of monocrystalline 55A aluminum oxide abrasive and superior VH bond
- Superior performance on centerless plunge and throughfeed, surface, and cylindrical grinders with up to 2X the life of competitive aluminum oxide wheels
- Ideal for simple- to complex-shaped components with increased productivity, more quality parts, and lowest cost per part

TIER: **BETTER**
OTHER: **55A-VH ALUMINUM OXIDE UNFINISHED BLANK STOCK**

SIZE (D x T x H)	GRIT	GRADE	UNFINISHED BLANK PART #
Type 01 Straight			
18 x 1 x 5	80	K	003104 04552
18 x 2 x 5	80	K	003104 04554
18 x 3 x 5	80	K	003104 04555
20 x 1 x 8	60	K	003100 20910
20 x 1 x 12	100	K	003103 02177
	120	K	003103 02220
	120	M	003100 64512
20 x 1-1/2 x 12	80	K	003103 02221
	100	K	003103 02222
20 x 2 x 8	80	K	003100 20918
	100	K	003100 20920
	120	M	003100 64252
20 x 3 x 8	80	K	003104 25116
20 x 3 x 12	80	K	003104 25117
20 x 6 x 12	80	K	003100 20965
24 x 1 x 8	80	K	003100 21884
24 x 1 x 12	60	K	003100 20921
	80	M	003100 20923
24 x 1-1/4 x 12	60	M	003103 02224
24 x 1-1/2 x 8	80	K	003103 02223
24 x 1-1/2 x 12	80	K	003103 02225
	80	M	003103 02226
24 x 2 x 8	80	K	003100 21885
24 x 2 x 12	60	K	003100 20924
	80	I	003100 20926
24 x 3 x 8	80	K	003100 21757
24 x 5 x 12	60	L	003103 02227
24 x 6 x 12	60	K	003100 20968
24 x 8 x 12	100	K	003103 02228
24 x 10 x 12	80	K	003100 20972
30 x 2 x 12	60	L	003100 20929
30 x 3 x 12	60	L	003100 20930
42 x 1-1/2 x 12	60	M	003100 20931

There are many finished sizes and specifications available. Contact your local Norton distributor or salesperson with your size and specification requirements for quantity guidelines, quotations and helpful ordering instructions.

Please note "2-week delivery request" if needed, on your order.

Gear Wheel Blank Stock FastTrack Service



Norton quality non-stock gear wheels are designed to produce high metal removal rates with less power draw. The blank stock wheels below comprise our FastTrack alteration service. All Norton FastTrack wheels are altered on state-of-the-art CNC controlled machines and are finished using Norton dressing wheels. The Norton dressing wheels and machines give these wheels excellent accuracy and repeatability.

Vitrium³ VS3G Bond Wheels

Our revolutionary, exclusive bond platform provides unprecedented wheel performance and finished part accuracy across many precision grinding applications – while lowering process time and cost in three ways:

1. Coolest cutting with maximum chip clearance
2. Optimized precision profile delivers ultra radius accuracy
3. Able to run at higher operating speeds (maximizing your older and newer machines' performances)

Size Range:	Blank Stock: 120mm – 450mm diameter Finished Wheel: 115mm – 450mm diameter
Grit Range:	60 – 120
Abrasive Grain:	Ceramic Alumina and Aluminum Oxide

Key Program Features

- Standard lead time:
 - » 2 weeks
- Alteration Parameters:
 - » Diameter may be altered to 2" smaller than the original blank stock diameter
 - » Thickness may be altered to 1/2 the original blank stock thickness

Best choice for versatility, highest productivity, and lowest total cost

QUANTUM X CERAMIC ALUMINA AND VORTEX ALUMINUM OXIDE BLEND

- Leading Norton technologies produce the most free-cutting gear wheels: patented pore-induced construction, Norton Quantum X ceramic alumina and Vortex aluminum oxide abrasive blend, and strong Norton bond
- Best MRR (metal removal rate) versus all other ceramic gear wheels; reduce grinding cycle times up to 50%, best choice for grinding from solid
- Versatile; for all low-, medium- and high-force applications on hard-to-grind Inconel, titanium, and aerospace alloys; excel on large area of contact applications with exceptional form and corner-holding; 20+% less power draw

Excellent choice for the most demanding operations

TARGA TG, 3TG, 5TG CERAMIC ALUMINA

- The unique elongated shape of our second generation Norton seeded gel ceramic alumina abrasive offers exceptional durability for the most demanding applications and materials
- Consider Targa (TG) when your requirements for SG have been exceeded
- VS3G Vitrium³ bond is the newest, strongest bond in the Norton portfolio: patented pore-induced construction; for all low-, medium- and high-force applications; excels on hard-to-grind aerospace alloys and large areas of contact; exceptional form and corner-holding

Excellent choice for high productivity, low total per-part grinding cost

SG CERAMIC ALUMINA

- High-performance seeded gel ceramic aluminum oxide abrasive provides fast stock removal, cool, superior cutting, and 3X - 5X more life than aluminum oxide wheels, and double rough stock removal rate versus conventional abrasives
- Self-sharpening abrasive for less burn, less dressing; very consistent performing wheel
- 5SG – durable Norton SG and aluminum oxide blend – blue, for high stock removal rates, excellent productivity, long wheel life, low overall grinding cost; versatile, high-performance VS and VSP bonds provide exceptional form holding

Better choice for versatile, consistent performance

86A ALUMINUM OXIDE

- Sharper aluminum oxide abrasive for cooler cutting
- VS3G Vitrium³ bond is the newest, strongest bond in the Norton portfolio: patented pore-induced construction; for all low-, medium- and high-force applications
- Excels on hard-to-grind aerospace alloys and large areas of contact; exceptional form and corner-holding

TIER:	BEST		BEST		BETTER		BETTER	
TRADENAME:	NORTON QUANTUM X: 5NQX NORTON QUANTUM: NQ, 3NQ, 5NQ VS3G = VITRIUM³ BOND		NORTON SEEDED GEL: 3TGP, SG, 5SG VS3G = VITRIUM³ BOND		BRGL VS3G = VITRIUM³ BOND		86A, 25A, X25A VS3G = VITRIUM³ BOND	
ABRASIVE:	Ceramic Alumina Unfinished Blank Stock		Ceramic Alumina Unfinished Blank Stock		BRGL – Ceramic Alumina Unfinished Blank Stock		86A, 25A, X25A – Aluminum Oxide Unfinished Blank Stock	
SIZE (D x T x H)	SPEC.	BLANK PART #	SPEC.	BLANK PART #	SPEC.	BLANK PART #	SPEC.	BLANK PART #
Type O1 Straight								
Worm Profile Wheels								
220mm x 180mm x 76.2mm					BRGL80-GVPHS	00310048274		
275mm x 125mm x 160mm							86A90-J10VS3G	00310477165
							86A100/5-110VTX2	00310458402
275mm x 160mm x 160mm	5NQM90-J10VS3G	00310491163					86A90-J10VS3G	00310486397
							25A100-110VS3G	00310460909
280mm x 160mm x 115mm	NQ80-H8VS3G	00310448492	SG80-HVX	00310419856			X25A70-G16VPAP	00310410369
							25A80-H8VS3G	00310448494
							86A80-H10VS3G	00310470137
300mm x 125mm x 160mm	3NQ90-J10VH	00310394338					86A100/5-J10VTX2	00310458405
	3NQ90-J10VS3G	00310477165					86A100/5-110VTX2	00310458404
300mm x 160mm x 160mm							86A90-J10VS3G	00310486981
							86A120-J10VS3G	00310486983
320 x 125 x 115	NQ80-H8VS3G	00310472371						
350mm x 104mm x 160mm					BRGL80-GVPHS	00310066976		
					BRGL100-GVPLS	00310066991		
350mm x 125mm x 160mm	3NQ90-H10VS3G	00310448495					25A90-H10VS3G	00310448496
Single Rib Wheels								
120mm x 30mm x 20mm	5NQX100-G20VTX2	00310490920	3TGP80/3-G12VS3G	00310448502				
300mm x 30mm x 50.8mm	5NQX60-G20VTX2	00310490863	3TGP80/3-G12VS3G	00310448501				
300mm x 60mm x 50.8mm	5NQX60-G20VTX2	00310490864	3TGP80/3-G12VS3G	00310448500				
400mm x 50mm x 127mm			3TGP60-G20VSPF	00310404596				
400mm x 60mm x 127mm	5NQX60-G20VTX2	00310490865						
400mm x 75mm x 127mm			3TGP60-G20VSPF	00310404597				
400mm x 100mm x 127mm	5NQX60-G20VTX2	00310490916	3TGP60-G20VSPF	00310404598				
400mm x 150mm x 127mm	5NQX60-G20VTX2	00310490917						
450mm x 50mm x 127mm			3TGP80/3-G12VS3G	00310448499				
450mm x 60mm x 127mm	5NQX60-G20VTX2	00310490918						
450mm x 100mm x 127mm	5NQX60-G20VTX2	00310490921	3TGP80/3-G12VS3G	00310448498				
450mm x 150mm x 127mm	5NQX60-G20VTX2	00310490919	3TGP80/3-G12VS3G	00310448497				

TIER:	BEST		
TRADENAME:	NORTON SEEDED GEL: TG, 5TG, 5SG		
ABRASIVE:	Ceramic Alumina Unfinished Blank Stock		
SIZE (D x T x RIM)	PLATE #	SPEC.	BLANK PART #
Type O2 Plate-Mounted Cylinder			
3.000 x 3.000 x .600	A311220	5SG80-JVS	00310485211
3.350 x 3.000 x .650	A311220	5SG80-JVS	00310485212
3.750 x 3.000 x .650	A311220	5SG80-JVS	00310485213
4.100 x 3.000 x .700	A311220	5SG80-JVS	00310485214
5.200 x 3.500 x .800	A311250	5SG80-JVS	00310485215
5.700 x 3.500 x .800	A311250	5SG80-JVS	00310485226
7.000 x 3.500 x 1.050	A311251	5SG80-JVS	00310485227
8.400 x 3.500 x 1.050	A311384	5SG80-JVS	00310485228
		TG280-H12V-X575	00310485229
8.346 x 3.500 x 1.043	A311384	5TG80-3-J8VH	00310480245

Gear blank stock alteration orders must include complete blueprint information.

Please ask your Norton representative for appropriate blueprint worksheet to fill in:

- Worm wheel blueprint worksheet: ME161508
- Single rib wheel blueprint worksheet: ME161178



ID, Race and Superfinishing Wheels and Sticks



The most extensive line of Pressed-To-Size ID and Race wheels to choose from to maximize performance and cost savings.

In addition to VFL wheels, VS3L-bonded wheels are also available. VS3L is the Vitrium3 high-strength, cool-cutting bond with improved cutting efficiency, productivity, and wheel life. VFL and VS3L wheels are the fastest way to get Make-to-Order Norton ID and Race Grinding wheels. Norton VFL and VS3L wheels are available in both ceramic abrasives and conventional aluminum oxide abrasives in diameters up to 5".

Additional dimensions and grinding faces are available as made-to-order products with 4-week lead-times.

Wheel Types: Type 01 and 05
Abrasive Types: Ceramic Alumina, Aluminum Oxide

ID and Race Wheels

ID and Race Wheel FastTrack Availability

Type 01 Straight	
Diameter: 0.172" thru 4.532"	Maximum thickness: 3.75"
Type 05 Recessed One Side	
Diameter: 0.407" thru 5"	Maximum thickness: 3.10"

For more program details, ask your Norton sales representative to review the FirstLine VFL & VS3L ID and Race Wheels Brochure #6981 with you.

VFL Availability

ABRASIVE	25A, 32A, 38A, 48A, 53A, 57A, 86A	5TG*	1SG, 3SG, 5SG	32AA	NQ, 1NQ, 3NQ, 5NQ, 1NQP, 3NQP, 5NQP, 1NQM, 3NQM, 5NQM
GRIT	54 - 120	80/1, 120/1	54-120	54-80	54-150
GRADE	J - P	I - M	I - N	I - M	I - N
STRUCTURE	6 (Not Shown)				
BOND	VFL				
WHEEL TYPES	01, 05				
SHAPES	Special faces not available				
SPEED	8,500 SFPM***				
TREAT 22	Not Available				

* 5TG is available in /1 combination, only
 **Speeds up to 12,500 SFPM by request and Safety approval

VS3L Availability

ABRASIVE	25A, 32A, 38A, 55A, 86A	5TG*	1SG, 3SG, 5SG	NQ, 1NQ, 3NQ, 5NQ, 1NQP, 3NQP, 5NQP, 1NQM, 3NQM, 5NQM
GRIT	54-120	80/1, 120/1	54-120	54-150
GRADE	H - P	I - K	I - N	I - N
STRUCTURE	8, 10	8	8, 10	8, 10
BOND	VS3L			
WHEEL TYPES	01, 05			
SHAPES	Special faces not available			
SPEED	8,500 SFPM***			
TREAT 22	Not Available			

* 5TG is available in /1 combination, only
 **Speeds up to 12,500 SFPM by request and Safety approval

Dimensional Tolerances

IF DIAMETER IS:	DIAMETER	THICKNESS	HOLE
0.532" and less	+/- .003"	+ .004" - .000	+ .001" + .006"
> 0.532" - 2.907"	+/- .005"	+/- .005"	+ .001" + .006"
> 2.907" - 4.407"	+/- .015"	+/- .015"	+ .001" + .006"



ID, Race and Superfinishing Wheels and Sticks

Blank Stock FastTrack Made-to-Order Microabrasive Superfinishing Sticks



Superfinishing blank stock encompasses a wide range of different specifications. These blanks can be finished to your dimensional requirements within two weeks from the date that the order is received at Norton Customer Service. Small lots, for test purposes, can be express shipped.

APPLICATIONS	ABRASIVE TYPE – BOND	GRIT RANGE	TREATMENT TYPE
Superfinishing / Finishing	NLA – V	240 – 1200	Sulfur, Wax
	NMVC – VCA		
	NSA – V		
Honing	SG – VS	54 – 220	
	SGG – VS1		

Rubber Finishing Sticks

These sticks are used for manual or mechanical honing on machines where they are mounted in holders or fixtures. Intended for use where precision dimensional limits and grade controls are required, such as die polishing.



SIZE (T x W x L)	STD. PKG./CASE	SPEC.	PART #
Rubber Finishing Sticks			
1/2 x 1/2 x 6	5/20	57A120-B2RR	614636 10608
1/2 x 1 x 6	5/20	57A120-B2RR	614636 10609

our dressing tools
**MAKE THE
PERFECT POINT**

The Norton Winter full line of expertly-crafted stationary and rotary dressing tools - whether stock or custom-engineered - delivers your every application need. And, our expert resetting and relapping services renew used tools to reduce your "cost per dress."

Diamond Stationary Dressing Tools



Our Norton Winter offering is the industry's most comprehensive line of stock and made-to-order products to true (restore the wheel's profile) and dress (opening – to remove stock – or closing to finish) the face of the wheel. In addition to these catalog stock stationary tools, Norton Winter manufactures a full line of custom stationary tools, rotary diamond dressers and truing/dressing devices to meet all your specific application needs.

Applications:

Truing and dressing conventional and superabrasive wheels, straight, step, radius and form dressing

Tool Types:

Stationary: Single Point, Toolroom, Multi-Point, Blade, Form, and Cluster Tools, and Truing Devices

Rotary: Reverse Plated and Infiltrated Form Plunge Diamond Rolls, Diamond CNC Traversing Discs, and Dressing Spindles

Determining the Best Value

Remember that diamonds are a rare commodity—the larger the stone and the better the quality, the higher the initial cost. The key to successful diamond tool productivity and use is based on the "cost per dress." Normally, higher quality diamonds and a proactive resetting program will result in the lowest "cost per dress."

In those situations where a resetting program is not feasible or low initial cost is the primary purchasing consideration, Norton Winter offers a complete line of non-resettable tools.

Resetting Your Used Diamond Tools

Resetting – Minimizing Your Cost

Buying a higher quality diamond is your best value, especially if you participate in a proactive resetting program. Although initial cost may be higher, the payback comes through several factors:

- Diamond durability, providing longer tool life
- Tighter form tolerances
- Consistent finish rates
- Resetting the diamond lowers the overall tooling cost

Used properly, the overall cost of a higher quality, resettable diamond will compare favorably with that of an inexpensive, non-resettable diamond. Initially, the best diamond point is selected for use. When returned, the next best diamond point is selected for resetting, and so on.

To ensure you get the best value for your diamond:

- Rotate the diamond tool ¼ turn periodically to maintain a sharp point
- Use proper flow of coolant to protect the diamond from heat which can create fracturing of the diamond
- Excessive wear on the diamond point may impact the ability to reset the diamond. The widest point of the diamond is referred to as the girth. The diamond girth is buried in a powder metal matrix. Using a diamond into the girth zone might impact the ability to reset other diamond points

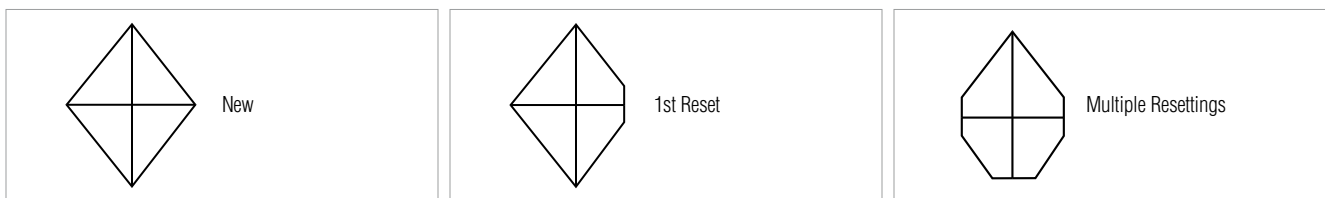

TECH TIP

Selecting the Correct Diamond Tool

To determine the type of dressing tool to use, it is best to think about the desired shape of the wheel face. Finished wheel face shapes are generally categorized into six types, as illustrated below.

Typical Wheel Forms Dressed by Stationary Diamond Tools

Look for the applicable wheel forms beside each product type to help you choose the correct product for your application.



Straight



Tapered



Convex

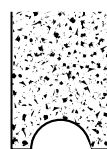

Concave

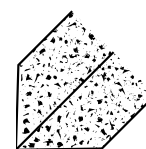

Angled

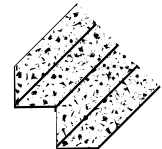

Multi-Angled



Single Point Tools

Our Norton Winter line of single point tools is used in straight and simple form dressing applications. It includes: resettable and non-resettable products, tools for all abrasive types (conventional and advanced ceramic grains) and the technology-leading "Indexable" tool design.

Wheel Forms Dressed by These Tools



STRAIGHT



TAPERED



CONVEX

SPEC CHECK

Selection Guide

Stock Tools for Ceramic Abrasive Wheels

SG/Ceramic Engineered for use on ceramic (SG, NQ, Targa, etc.) wheels but may also provide significant benefits when used on conventional abrasive products. These tools are furnished with top quality specially selected diamonds.

BCSG/Ceramic Economical alternative to an "SG" tool. Best choice when a disposable tool is preferred.

Stock Tools for Conventional Abrasive Wheels

NS Engineered for use on conventional abrasives. These high quality, value-priced tools can be used for a variety of dressing applications.

BC Economical alternative to an "NS" tool. Best choice when a disposable tool is preferred.

Selecting the Correct Single Point Tool:

- Identify the wheel abrasive type: aluminum oxide, silicon carbide, or ceramic
- Determine the wheel diameter – to select the optimum carat weight
- Determine the tool holder size – to select appropriate shank diameter

Examples of Single Point Tool Selection

Conventional Wheel Spec:	32A46-IVBE 7" x 1/2" x 1-1/4"
	Machine has a 7/16" tool holder
Tool Selections:	Resettable: NS2M7 or NSUD2 (Indexable)
	Non-Resettable: BC2M7 or BCUD2 (Indexable)
Ceramic Wheel Spec:	5SG60-JVS or 5NQ60-IVS 10" x 1" x 3"
	Machine has a 3/8" tool holder
Tool Selections:	Resettable: SG3M6
	Non-Resettable: BCSG3M6

TECH TIP

- Rigidly mount single point tools at a 10° - 15° angle to the wheel centerline with a line drawn through the center of the wheel, pointing in the direction of wheel travel
- Point of contact should be slightly below centerline of wheel as shown
- Use coolant whenever possible
- Normal infeed is .001" per pass
- Lead selections range from .002" – .010" per wheel revolution
- Rotate the tool 1/4 turn periodically to maintain a sharp point

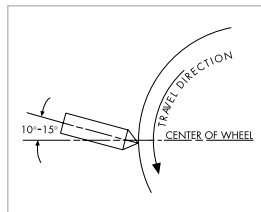

To optimize applications using ceramic abrasives and/or tools, normal dressing parameters must change. Reduce infeed by 25%. Significant reductions in the amount of infeed and frequency of dress will result in substantially lower cost per part ground.

Single Point Dress Traverse Rate

Select a Lead Value based on desired Surface Finish and run the formula below.

Finish	Lead Value (Per Wheel Revolutions)
For Coarse Finish (approx. 64 RMS)	.008" to .010"
For Medium Finish (approx. 32 RMS)	.005" to .009"
For Fine Finish (approx. 16 RMS)	.002" to .004"

Lead Value x Wheel Speed (RPM) = Traverse Rate in Inches/Minute

- Slower traverse rates result in a closed wheel face and lower surface finish readings on the workpiece.
- Faster traverse rates result in an open wheel face that produces greater stock removal and a rougher workpiece finish.



It is the user's responsibility to refer to and comply with ANSI B7.1

Single Point Tools for Truing/Dressing Ceramic Abrasives



SINGLE POINT TOOLS FOR SG/CERAMIC

- Specially selected broad-shaped, diamond withstands the increased grinding pressures of ceramic abrasives
- Each diamond is hand selected for stone shape, quality and structural integrity for consistent tool performance
- Multi-purpose - can accommodate most straight dressing and simple form dressing applications; stands up to the sharpness of ceramic abrasives (SG, Quantum, Targa, etc.) but can also be used to dress conventional abrasives

Resettable Single Point Tools for SG/Ceramic

- High quality diamond and a proactive resetting program will result in the lowest dressing cost per part for ceramic abrasives

Non-Resettable Single Point Tools for BCSG/Ceramic

- The best selection for ceramic abrasives when a resetting program is not feasible or low initial cost is the primary purchasing consideration

WHEEL DIAMETER	TOOL CARAT WEIGHT	TOOL DIAMETER	TOOL LENGTH	TIER: BEST		GOOD	
				PRODUCT #	3 SETTABLE PTS (2 RESETS) PART #	PRODUCT #	NON-RESETTABLE PART #
Stock Single Point Tools for Truing/Dressing Ceramic Abrasives							
Up to 7"	1/4 (.25)	3/8"	2"	SG2M6	662601 95365	BCSG2M6	662601 57007
		7/16"	2"	SG2M7	662601 95366	BCSG2M7	662601 56905
8" to 10"	1/3 (.33)	3/8"	2"	SG3M6		BCSG3M6	662601 57008
		7/16"	2"	SG3M7	662601 95368	BCSG3M7	662601 56906
11" to 14"	1/2 (.50)	3/8"	2"	SG5M6	662601 95369	BCSG5M6	662601 57009
		7/16"	2"	SG5M7	662601 95370	CSG5M7	662601 56907
15" to 20"	3/4 (.75)	7/16"	2"	SG7M7	662601 95372	BCSG7M	662601 56908
21"+	1 (1.00)	7/16"	2"			BCSG10M7	662601 57010

Standard Package = 1 tool

Wheel Forms Dressed by These Tools

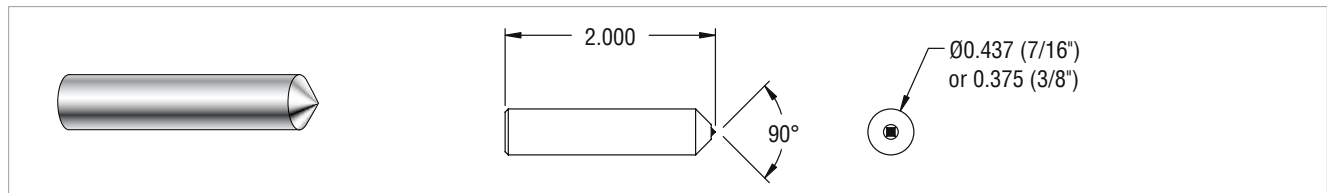
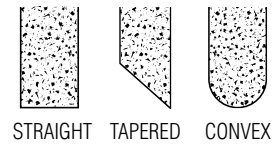

TECH TIP

Stock Single Point Tool Marking System

Diamond Quality	Diamond Size	Shank Design	Shank Diameter
SG/Ceramic	1 = 1/5 (.20) carat	M	6 = 3/8"
BCSG/Ceramic	2 = 1/4 (.25) carat	J	7 = 7/16"
NS	3 = 1/3 (.33) carat		
BC	5 = 1/2 (.50) carat		
	7 = 3/4 (.75) carat		
	10 = 1 carat		

Example: **NS 2 M 6**

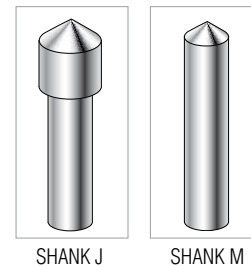

Single Point Tools for Truing/Dressing Conventional Abrasives



SINGLE POINT TOOLS FOR CONVENTIONAL ABRASIVES

- Consistent diamond structure and shape for repeatable dressing performance on conventional abrasives
- Well defined, sharp, durable diamond point offers maximum cost effectiveness
- Steeper 60 degree angle head design allows for greater machine and part clearance to produce forms with tighter tolerances

Resettable NS (Norton Standard) Single Point Tools

- Selection of the correct tool and a proactive resetting program will usually result in the lowest dressing cost per part on conventional abrasives with these value priced, high quality diamonds

Non-resettable BC Single Point Tools

- The best selection for conventional abrasives when a resetting program is not feasible or low initial cost is the primary purchasing consideration

		TIER: BETTER			TIER: GOOD		
		TRADENAME: NS (NORTON STANDARD)			TRADENAME: BC		
WHEEL DIAMETER	TOOL CARAT WEIGHT	TOOL DIAMETER	PRODUCT #	2 SETTABLE PTS (1 RESET) PART #	PRODUCT #	NON RESETTABLE PART #	
Stock Single Point Tools for Truing/Dressing Conventional Abrasives							
Internal Wheel	1/5 (.20)	3/8"			BC1M6	662601 95021	
		7/16"			BC1M7	662601 95022	
Up to 7"	1/4 (.25)	3/8"	NS2M6	662601 95116	BC2M6	662601 95000	
		7/16"	NS2M7	662601 95117	BC2M7	662601 95001	
8" to 10"	1/3 (.33)	3/8"	NS3M6	662601 95121	BC3M6	662601 95002	
		7/16"	NS3M7	662601 95122	BC3M7	662601 95003	
11" to 14"	1/2 (.50)	3/8"	NS5M6	662601 95126	BC5M6	662601 95004	
		7/16"	NS5M7	662601 95127	BC5M7	662601 95005	
15" to 20"	3/4 (.75)	3/8"			BC7M6	662601 95006	
		7/16"	NS7M7	662601 95132	BC7M7	662601 95007	
		7/16"	NS7J7*	662601 95130			
21" +	1 (1.00)	3/8"	NS10M6	662601 95136	BC10M6	662601 95008	
		7/16"	NS10M7	662601 95137	BC10M7	662601 95009	
		7/16"	NS10J7 *	662601 95135			

* J-shank tools are available in 7/16" diameter with 5/8" head. Standard Package = one tool

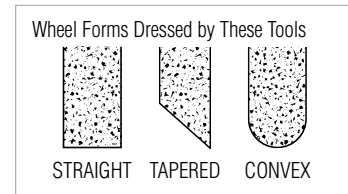
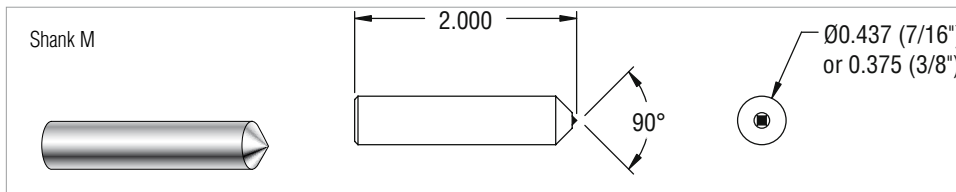
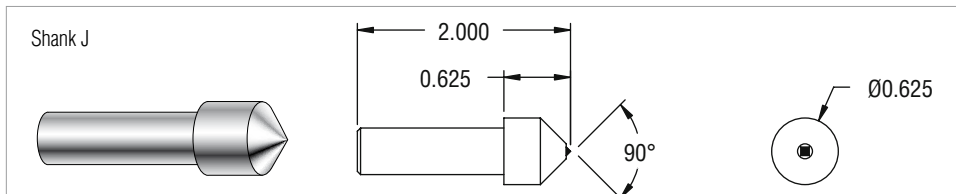

Indexable Single Point Tools

Indexable tools are specifically designed to alleviate any misalignment issues and are the tools of choice for CNC grinders. They feature a two-part construction with the head and shank as separate pieces. After the initial installation, operators simply turn the indexable head with a wrench, while the tool shank remains secure (and aligned) in the tool holder.



INDEXABLE SINGLE POINT TOOLS

- These indexable tools are easily turned without having to remove the tool from the holder, making it easier to turn than conventional tools and increasing frequency of beneficial tool turning
- U-Dex-It and Mini-Dex tools have a 60° included angle head design providing additional form versatility through better machine and part clearance
- Offers an excellent choice for regulating wheels

Indexable Single Point Tools for Truing/Dressing Conventional Abrasives

Resettable NS (Norton Standard) Indexable Single Point Tools

- Selection of the correct tool and a proactive resetting program will usually result in the lowest dressing cost per part on conventional abrasives with these value priced, high quality diamonds
- Ideal for centerless grinders; using standard 5/8" wrench, the head can be turned through the hole in the side of the wheel guard without removing the guard

Resettable NS (Norton Standard) Mini-Dex Indexable Single Point Tools

- Selection of the correct tool and a proactive resetting program will usually result in the lowest dressing cost per part on conventional abrasives with these value priced, high quality diamonds
- Use a standard 7/16" wrench to turn; designed for internal, bearing race, and twist drill flute machines

Non-Resettable Indexable Single Point Tools

- The best selection for conventional abrasives when a resetting program is not feasible or low initial cost is the primary purchasing consideration
- Ideal for centerless grinders; using standard 5/8" wrench, the head can be turned through the hole in the side of the wheel guard without removing the guard

WHEEL DIAMETER	TOOL CARAT WEIGHT	TOOL SIZE	TIER: BETTER		GOOD	
			PRODUCT #	2 SETTABLE PTS (1 RESET) PART #	PRODUCT #	NON-RESETTABLE PART #
Stock Indexable Single Point Tools for Truing/Dressing Conventional Abrasives						
Up to 7"	1/4 (.25)	7/16" x 1-7/16" with 5/8" head			BCUD2	662601 95023
		1/4" x 1-3/16" with 7/16" head	NSMD2	662601 95171		
8" to 10"	1/3 (.33)	7/16" x 1-7/16" with 5/8" head	NSUD3	662601 95162		
11" to 14"	1/2 (.50)	7/16" x 1-7/16" with 5/8" head	NSUD5	662601 95163	BCUD5	662601 95025
15" to 20"	3/4 (.75)	7/16" x 1-7/16" with 5/8" head	NSUD7	662601 95164		

Standard Package = one tool

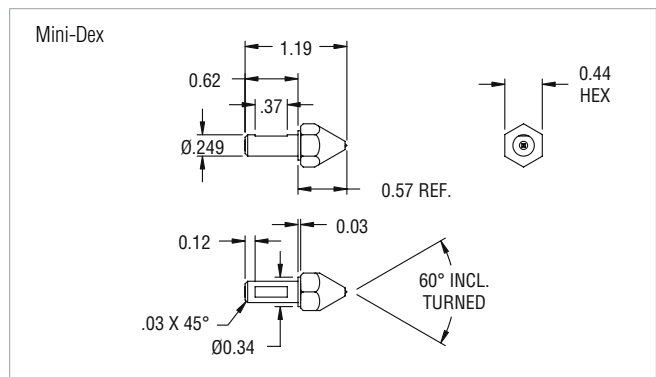
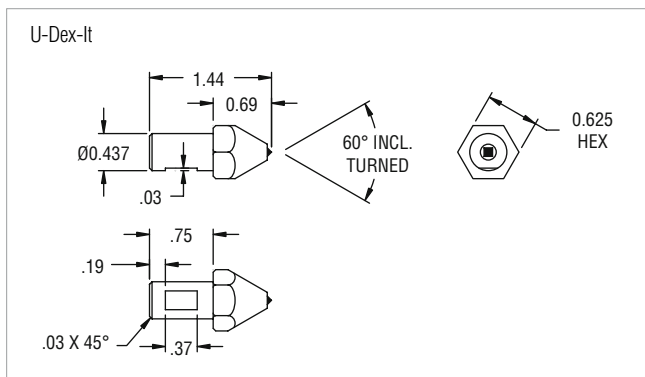

Indexable Single Point Tools *continued*

Indexable Single Point Tools for Truing / Dressing Ceramic Abrasives

Non-Resettable Ceramic Indexable Single Point Tools

- U-Dex-It BCSG tool contain specially selected diamonds to withstand increased ceramic (SG, Quantum, Targa, etc.) grinding pressures
- Ideal for centerless grinders; using standard 5/8" wrench, the head can be turned through the hole in the side of the wheel guard without removing the guard
- The best selection when a resetting program is not feasible or low initial cost is the primary purchasing consideration

			TIER: GOOD	
WHEEL DIAMETER	TOOL CARAT WEIGHT	TOOL SIZE	PRODUCT #	NON-RESETTABLE PART #
Stock Indexable Single Point Tools for Truing/Dressing Ceramic Abrasives				
11" to 14"	1/2 (.50)	7/16" x 1-7/16" with 5/8" head	BCSGUD5	66260159894
<i>Standard Package = one tool</i>				

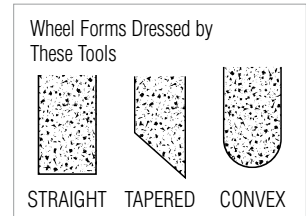
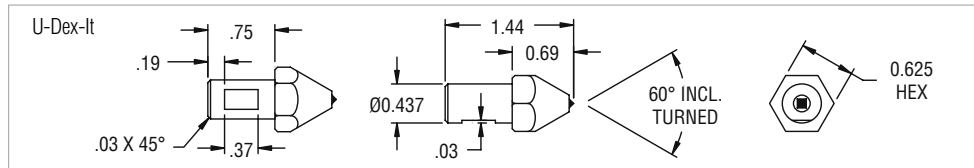

Internal Grinding Tools



Resettable Tools For Internal Grinding

- Q style shank is used on a Heald internal grinder (resettable)

Wheel Forms Dressed by These Tools

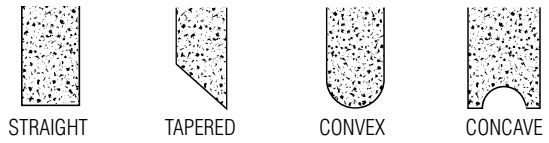

TIER: BEST					
MACHINE TYPE	CARAT WEIGHT	SHANK DIAMETER	TOOL LENGTH	PRODUCT #	2 SETTABLE PTS (1 RESET) PART #
Stock Internal Grinding Tools					
Heald	1/5 (.20)	7/16"	1"	NI21Q7	662601 95180
Standard Package = 1 Tool					

Shank Q for Heald Machine

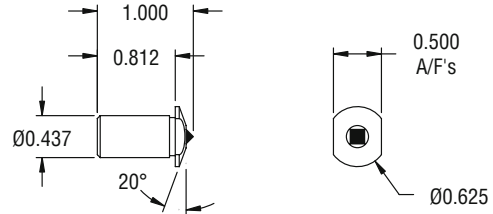

Thread Grinding Tools



Thread Grinding Tools For SG / Ceramic Abrasives

- These wheels are used on J & L and Excello thread grinding machines to accurately dress the grinding wheels that form the desired thread configuration (non-resettable)

TIER: BEST						
MACHINE TYPE	SHANK DIAMETER	TOOL LENGTH	INCLUDED ANGLE	MAX. RADIUS ON POINT	PRODUCT #	NON-RESETTABLE PART #
Stock Thread Grinding Tools						
J & L	1/4"	1"			38RL4*	662601 95100
J & L	1/4"	1"	80°	.010"	NT1L4	662601 95187
EXCELLO	3/8"	1-5/8"	60°	.010"	NT106	662601 95190

Wheel Forms Dressed by These Tools

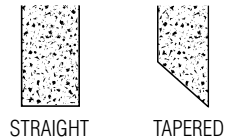

* 38RL4 is a multi-point (grit) 30 - 40 mesh tool
Standard Package = 1 Tool

NT1L4 for Jones & Lamson Machine

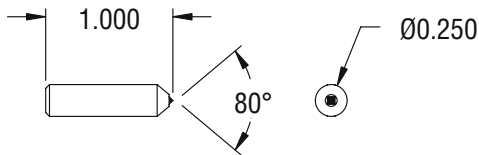

NT106 for Excello Machine

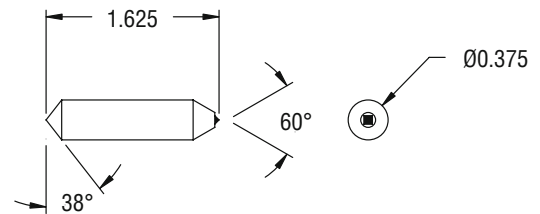

38RL4 for Jones & Lamson Machine

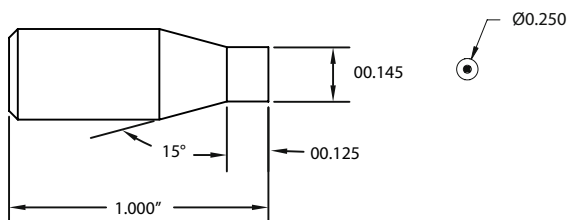



Toolroom Tools

Norton Winter Toolroom Dressing Tools are primarily used on surface grinders to form the grinding wheel to an exact concave or convex radius. Although some tools are designed for use on a specific machine, many radius tools can be used on any grinder having the correct set-up.

Used generally on 8" diameter and smaller vitrified toolroom wheels, our Norton Winter offering includes phono-point, conventional radius, and full ball radius tools.

Wheel Forms Dressed by These Tools

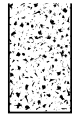

STRAIGHT



CONCAVE



CONVEX



MULTI-ANGLED

Phono-Point Tools

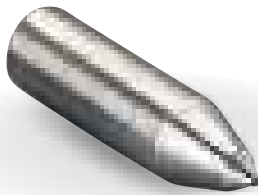

Non-Resettable Phono-Point Tools

- For general toolroom concave and convex dressing on small diameter grinding wheels

INCLUDED ANGLE	SHANK DIAMETER	TOOL LENGTH	TIER: BETTER		GOOD	
			PRODUCT #	NON-RESETTABLE PART #	PRODUCT #	NON-RESETTABLE PART #
Stock Phono-Point Tools						
60°	1/8"	1"	NP1M2	662601 95225	BCPP-60	662601 95017
	3/16"	1"	NP1M3	662601 95226		
	1/4"	1"	NP1M4	662601 95227		
75°	1/8"	1"	NP2M2	662601 95228	BCPP-75	662601 95018
	1/4"	1"	NP2M4	662601 95230		
90°	1/8"	1"	NP3M2	662601 95231	BCPP-90	662601 95019
	3/16"	1"	NP3M3	662601 95232		
	1/4"	1"	NP3M4	662601 95233		

Standard Package = one tool

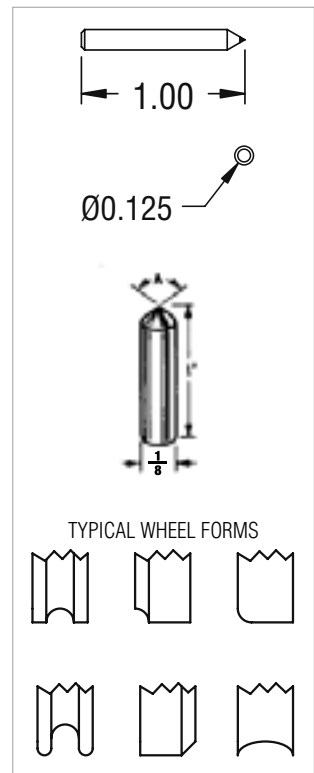

Wheel Forms Dressed by These Tools



CONVEX



CONCAVE

SPEC CHECK

Phono-Point Tool Marking System

Diamond Type	Included Angle On Diamond	Shank Style	Shank Diameter
NP	1 = 60°	M	2 = 1/8"
BCPP	2 = 75°		3 = 3/16"
	3 = 90°		4 = 1/4"

Example: **NP 1 M 3**

TECH TIP

How to Use Toolroom Tools

- We recommend dressing with coolant. However, if dressing totally dry, allow three to five seconds between passes for diamond to cool.
- Use extremely light cuts from .0002" to .001" maximum.
- Rotate tool if the application and set-up allow.
- Custom Full Ball Radius Tools should be returned for relap after minimum wear.

Radius Tools

Concave Radius Tools

- This line offers a specially-shaped single point diamond, designed for forming concave radii on small diameter grinding wheels; not resettable.

Convex Radius Tools

- This line offers a specially-shaped single point diamond, designed for forming convex radii on small diameter grinding wheels; not resettable.

Half-Circle Concave Radius Tools (Available as Non-stock Only)

- This line offers a specially-shaped diamond set in the side of the shank for forming half-circle radii on small diameter grinding wheels.
- The tool is rotated to form the radius. Commonly called a "rat tail dresser"; not resettable.

RADIUS SIZE TO BE DRESSED	SHANK DIAMETER	TOOL LENGTH	TIER: BEST		GOOD	
			PRODUCT #	NON-RESETTABLE PART #	PRODUCT #	NON-RESETTABLE PART #
Stock Concave Radius Tools						
.010" to .015"	3/8"	2"	NR1P6	66260195210		
.016" to .020"	3/8"	2"	NR2P6	66260195211		
.021" to .032"	3/8"	2"	NR3P6	66260195212		
.033" to .062"	3/8"	2"	NR4P6	66260195213	BCRD	66260195016
.063" to .125"	3/8"	2"	NR5P6	66260195214	BCRD	66260195016
.126" to .250"	3/8"	2"	NR6P6	66260195215	BCRD	66260195016
Stock Convex Radius Tools						
.020" to .125"	3/8"	2"	NR2M6	66260195216		
.126" to .250"	3/8"	2"	NR12M6	66260195217		

Standard Package = one tool

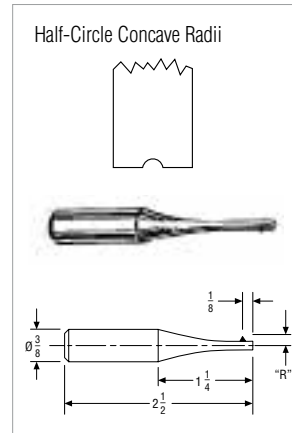
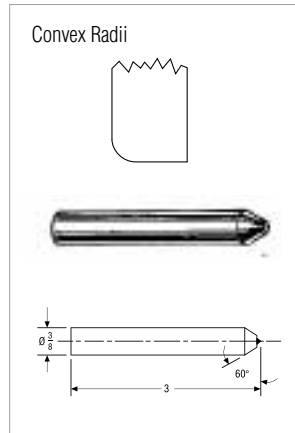
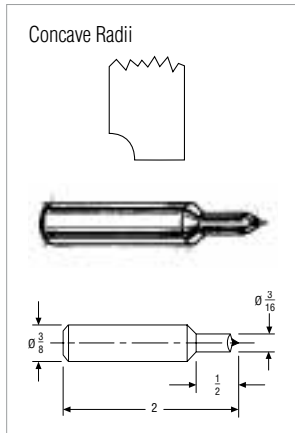

Full-Ball Radius Tools for precision plunge form dressing of concave radii in the center of a grinding wheel are available made to your custom requirements. Ask your Norton representative for details.



Multi-Point (Grit) Tools

Since Norton Winter conventional and high-performance Multi-Point tools never need turning or resetting, they are the most economical way to accomplish a variety of straight, tapered, and step dressing operations on all sizes of cylindrical, centerless, surface, and toolroom grinding wheel applications.

Wheel Forms Dressed by These Tools



STRAIGHT



TAPERED

SPEC CHECK

Selection Guide

- Identify the wheel abrasive type: ceramic (SG, Quantum, Targa), aluminum oxide, or silicon carbide
- Determine the wheel diameter and grit size
- Determine the tool's approach angle to the centerline of the wheel
- Identify the tool holder diameter
- Use 1E shape for angular wheel slide, cylindrical grinding and for shoulder or step truing

Examples of Multi-Point Tool Selection

Conventional Wheel Spec:	32A46-IVBE 7" x 1/2" x 1-1/4" Machine has a 3/8" tool holder
Tool Selection:	1R6J6
Ceramic Wheel Spec:	5SG60-JVS or 5NQ60-IVS 10" x 1" x 3" Machine has a 7/16" tool holder
Tool Selections:	SG1R6J7

TECH TIP

Multi-Point Tools – Straight Face Dressing and Truing

- Most multi-point tools are used for straight face dressing
- Tool should have full face contact with the wheel
- With new tool, 3–5 passes at .005" per pass should be taken to expose diamonds
- Infeed per pass .001" – .002"
- Use coolant whenever possible
- Use appropriate lead (and traverse rate)
- Contact your Norton representative for proper tool selection for Targa wheels

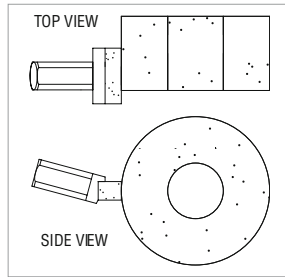

Multi-Point Dress Traverse Rate

Select a Lead Value based on desired Surface Finish and run the formula below.

FINISH	LEAD VALUE (PER WHEEL REVOLUTIONS)
For Coarse Finish (approx. 64 RMS)	.023" to .030" (.58mm – .76mm)
For Medium Finish (approx. 32 RMS)	.013" to .022" (.33mm – .57mm)
For Fine Finish (approx. 16 RMS)	.006" to .012" (.15mm – .33mm)

$Lead\ Value \times Wheel\ Speed\ (RPM) = Traverse\ Rate\ in\ Inches/Minute$

- Slower traverse rates result in a closed wheel face that produces less stock removal and improved workpiece finish.
- Faster traverse rates result in an open wheel face that produces greater stock removal and a rougher workpiece finish.



It is the user's responsibility to refer to and comply with ANSI B7.1

TECH TIP

Optimizing SG Multi-Point Tool Performance

- To optimize applications using ceramic abrasives/tools, normal dressing parameters must change. Significant reductions in the amount of infeed and frequency of dress will result in significantly lower cost per part ground.
- While all SG/Ceramic tools have been designed to improve the efficiency of ceramic grinding applications, they can also offer significant benefits in many applications using conventional abrasives.
- When first using a SG/Ceramic tool, make 3 to 5 passes at .005" infeed to ensure full face contact between the dressing tool and wheel face.
- Reduce normal dressing infeed by half. Do not exceed infeed of .002" per pass.
- The lead selection should be between .006"-.030" per wheel revolution. Faster traverse with a SG/Ceramic tool generally provides an open wheel face that can maximize productivity of the ceramic abrasive.

TECH TIP

Multi-Point Tool Diamond Section Specifications

SHAPE	WIDTH	LENGTH	DEPTH	TOOL APPROACH ANGLE TO WHEEL	FOR WHEEL DIAMETER
1A	1/4"	3/4"	5/16"	0°	Over 20"
2A	1/4"	1/2"	3/8"	0°	15" – 20"
3A	5/32"	3/8"	1/4"	0°	Over 20"
1E	5/32"	3/8"	5/16"	–	
2E	1/4"	1/2"	1/2"	–	20" x 2" and up
1R	1/4" Round		1/4"	0°	Up to 10"
2R	3/8" Round		3/8"	0°	11" – 14"

Multi-Point Tool Marking System

Diamond Shape	Tool Diamond Size	To Dress Grinding Wheels With Grit Size Of:	Shank Design	Shank Diameter
1A	4	= 46 grit	See the following pages for shank configurations	6 = 3/8"
2A	6	= 54 - 100 grit		7 = 7/16"
3A	8	= 120 - 150 grit		8 = 1/2"
1E	12	= 150+ grit		
2E	14	= Special Applications		
1R				
2R				

Example: **1A 6 A 7**

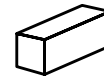

Shape A is used primarily for straight face dressing.



Shape E (double angle top face) is used for standard N-Face wheels, angular wheels, face and side truing of cylindrical wheels, and in step dressing.



Shape R is used for straight face dressing where the tool holder is perpendicular to the wheel face (no drag angle), and on thread grinding machines.

Multi-Point Tools for Straight Dressing

SG MULTI-POINT TOOL SHAPE AND SHANK AVAILABILITY

SHAPE SG1A SHANK A	SHAPE SG1A SHANK C	SHAPE SG2A SHANK D
SHAPE SG2A SHANK E	SHAPE SG1R SHANK J	SHAPE SG2R SHANK K

CONVENTIONAL TOOLROOM MULTI-POINT TOOL SHAPE AND SHANK AVAILABILITY

SHAPE 1A BC-60	SHAPE 1A BC-61	SHAPE 2A BC-62
SHAPE 2A BC-63	SHAPE 1R BC-64	SHAPE 1R BC-65

CONVENTIONAL ABRASIVE MULTI-POINT TOOL SHAPE AND SHANK AVAILABILITY

SHAPE 1A SHANK A	SHAPE 1A SHANK B	SHAPE 1A SHANK C	SHAPE 2A SHANK D	SHAPE 2A SHANK E	SHAPE 3A SHANK F
SHAPE 3A SHANK G	SHAPE 1E SHANK F	SHAPE 1R SHANK J	SHAPE 2R SHANK K	SHAPE 3R SHANK L	

Shapes 3A (F and G Shanks) are used for form, shape, and step truing. Shape 1E is used for angle dressing



MULTI-POINT TOOLS

- Uniformly distributed diamonds in a tough, durable matrix for consistent performance throughout tool life
- Fresh, multiple diamond points exposed in truing operation; no turning or resetting required for faster, more consistent straight face dressing and longer tool life than single point tools
- Overall diamond weight exceeds equivalent single point tool making this the most economical way to dress straight and tapered forms

Multi-Point Tools for Truing and Straight Dressing

Multi-Point Tools For SG/Ceramic Abrasives

- Designed specifically for use on ceramic (SG, Quantum, Targa, etc.) abrasives, SG tools contain a higher diamond concentration to withstand the increased grinding pressures generated by the ceramic abrasives
- These tools have improved life and dress quality; they can also offer significant benefits in many applications when used on conventional abrasives

Standard Multi-Point Tools

- The ideal selection for use on conventional abrasives in high-production applications

BC Multi-Point Tools

- General-purpose tools ideal for conventional toolroom applications with a specially selected diamond size for a broad range of dressing applications

WHEEL DIAMETER	WHEEL GRIT SIZE	TOOL APPROACH ANGLE	TOOL DIAMETER	TIER: BEST SG/CERAMIC		TIER: BETTER STANDARD		TIER: GOOD BC	
				PRODUCT #	PART #	PRODUCT #	PART #	PRODUCT #	PART #
Multi-Point Tools for Straight Dressing									
Up to 10"	54 to 100	0°	7/16"			1R6J7	662601 95088	BC64	662601 95014
		0°	3/8"			1R6J6	662601 95085		
11" to 14"	54 to 100	0°	7/16"	SG2R6K7	662601 95378	2R6K7	662601 95096	BC65	662601 95015
15" to 20"	46	15°	7/16"			2A4E7	662601 95048		
		0°	7/16"	SG2A6D7	662601 95375	2A6D7	662601 95046	BC62	662601 95012
	120 to 150	15°	7/16"	SG2A6E7	662601 95376	2A6E7	662601 95049	BC63	662601 95013
		0°	7/16"			2A8D7	662601 95047		
21" +	46	15°	7/16"			2A8E7	662601 95050		
		0°	7/16"			1A4C7	662601 95038		
	54 to 100	0°	7/16"	SG1A6A7	662601 95373	1A6A7	662601 95031	BC61	662601 95011
		15°	7/16"			1A6B7	662601 95035		
120 to 150	15°	7/16"	SG1A6C7	662601 95374	1A6C7	662601 95039	BC60	662601 95010	
		7/16"			1A8C7	662601 95040			



Standard Package = one tool

Multi-Point Tools for Form, Shape, or Step Dressing Conventional Abrasives

WHEEL DIAMETER	WHEEL GRIT SIZE	TOOL APPROACH ANGLE	TOOL DIAMETER	TIER: BETTER	
				PRODUCT #	PART #
Stock Multi-Point Tools for Form, Shape, and Step Dressing					
All	54 to 100	0°	7/16"	3A6F7	662601 95055
		15°	7/16"	3A6G7	662601 95975

Standard Package = one tool

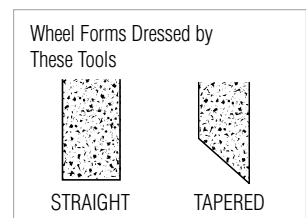

WHEEL DIAMETER	WHEEL GRIT SIZE	TOOL APPROACH ANGLE	TOOL DIAMETER	TIER: BETTER	
				PRODUCT #	PART #
Stock Multi-Point Tools for Angular Dressing Conventional Abrasives					
All	54 to 100	0°	7/16"	1E6F7	662601 95080

Standard Package = one tool

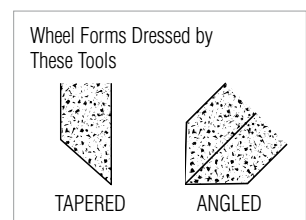



High Performance Grit Tools

Norton Winter High Performance grit tools are used in the same manner as multi-point tools, but are designed to produce a superior finish. They are used on 120 - 150 grit wheels. The traverse rates are equal to or faster than ordinary tools. Mounted on standard shanks, standard High Performance grit tools have a 3/8" wide by .100" thick diamond impregnated blade with a greater number of sharp points than in ordinary multi-point tools.

Since High Performance grit tools contain a higher concentration of diamond than found in standard multi-point tools, they are well suited for ceramic abrasive applications.

Typical Machines and Applications

- HP4439: cylindrical machines, grinding thrust walls, bearing diameters and multi-diameter shafts with radii
- HP4511: angular machines plunge grinding multi-diameter shafts and plunge grinding on dual-wheel forms
- HP4595: cylindrical machines grinding main bearing and lobes on camshafts
- HP4596: centerless machines step grinding and machines dual-wheel grinding transmission shafts

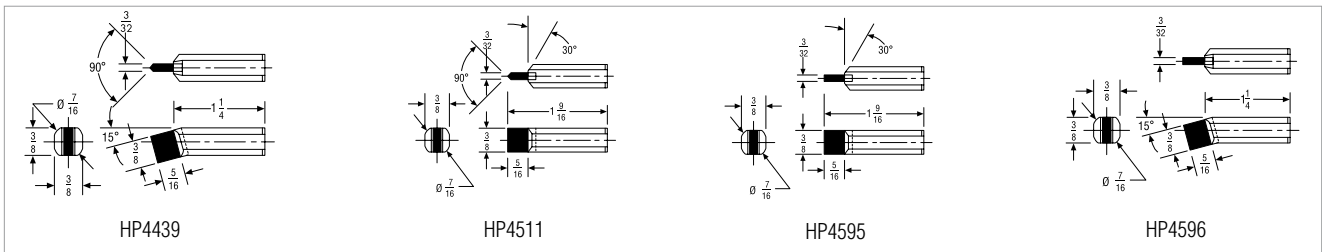

TIER: **BEST**

WHEEL DIAMETER	WHEEL GRIT SIZE	SHANK DIAMETER	TOOL LENGTH	PRODUCT #	PART #
Stock High Performance Grit Tools					
Up to 20"	120 to 150	7/16"	1-9/16"	HP4439	662601 95270
Up to 20"	120 to 150	7/16"	1-9/16"	HP4511	662601 95271
Up to 20"	120 to 150	7/16"	1-9/16"	HP4595	662601 95272
Up to 20"	120 to 150	7/16"	1-9/16"	HP4596	662601 95273

Standard Package = one tool

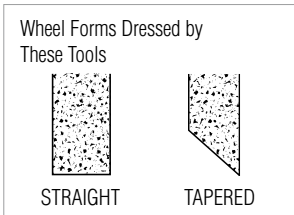



Blade Tools

With the choice of natural and synthetic diamond in three performance/price tiers, blade tools can meet all your angle, step, and radius dressing requirements for cylindrical, surface, and centerless grinding.

Wheel Forms Dressed by These Tools

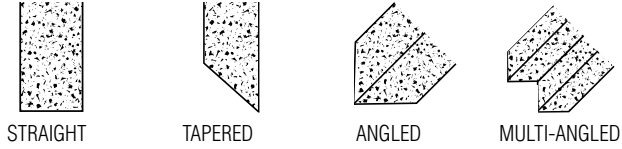

Synthetic Blade Tools – For USB and Quantum

- Synthetic diamond with a controlled diamond shape provides a constant cross section of diamond to the wheel throughout the life of the tool
- Provides consistent wheel conditioning from the first dress to last; economical, long-lasting alternative to chisel-type tools for centerless form grinding
- USB (made-to-order) - for dressing aluminum oxide wheels; Quantum (made-to-order) - for dressing ceramics and silicon carbide wheels

Multi-Cut Blade Tools (Available in Stock and Made-To-Order)

- Manufactured with top quality natural or processed elongated diamond
- Customizable diamond type depending on wheel specification and application requirements
- Durable performing tools in a medium price range

		TIER: BEST			TIER: BETTER	
		TRADENAME: SYNTHETIC BLADE TOOLS			TRADENAME: MULTI-CUT TOOLS	
WHEEL DIAMETER (WIDTH <= 9")	TOOL APPROACH ANGLE	SHANK DIAMETER	PRODUCT #	PART #	PRODUCT #	PART #
Blade Tools						
12" to 17"	0°	7/16"	NQ20A7	079587 47944 NS		
	15°	7/16"	NQ215A7	079587 47945 NS	MC355	662601 95266
18" to 29"	0°	7/16"	NQ30A7	079587 47946 NS		
	15°	7/16"	NQ315A7	079587 47947 NS		
30" - 36"	0°	7/16"	NQ50A7	079587 47948 NS		
	15°	7/16"	NQ515A7	079587 47950 NS		

These stock tools are composed of 1 layer with 3 diamonds. These tools are not resettable or relappable.

NS Non-Stock: Please contact your Norton representative for current lead-times.

Standard Package = one tool

Wheel Forms Dressed by These Tools

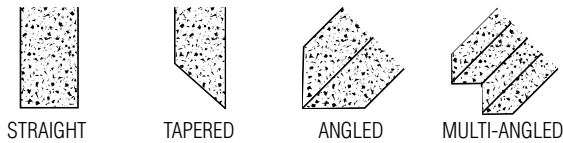

Form Tools

Norton Winter Form Tools have diamond lapped to specific angles and radii required for a particular application, machine, contour dressing system, or CNC operation. Due to the high degree of accuracy necessary, the diamond is of special shape and quality.

Used tools can be relapped - the tip geometry can be restored on worn tools at a reduced cost.

Wheel Forms Dressed by These Tools



CONVEX



CONCAVE

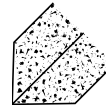

ANGLED



MULTI-ANGLED

TECH TIP

How to Use Form Dressing Tools

- Proper centerline and light infeeds are essential to minimize side pressure. Excessive pressure will cause the diamond to fracture.
- Cone point tools should be rotated approximately 1/4 turn daily.

Cone Point Tools



CONE POINT TOOLS

- Norton Winter vacuum braze technology used in the manufacturing surpasses all traditional diamond retention methods
- Absolute diamond retention, diamond pullout prevention during the dressing cycle, and longer tool life through multiple relaps
- Diamond is accurately coned to the specific included angle and radius making these tools ideal when the most intricate, precise forms and radii are required

U-Dex-It Cone Point Tool

- Used for precision dressing of intricate forms and radii
- Specially designed with 5/8" indexable head for easy turning during use
- These tools can be relapped

TIER: **BEST**

INCLUDED ANGLE ON DIAMOND	RADIUS ON DIAMOND	TOOL CARAT WEIGHT	SHANK DIAM.	TOOL LENGTH	PRODUCT #	RELAPPABLE PART #
75°	.020"	.50	7/16"	1.678"	CPUD720-7	66260158981

Standard Package = one tool

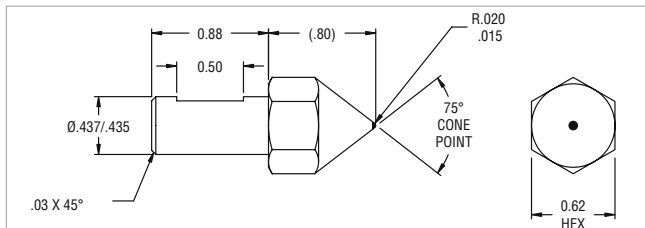

WHEEL FORMS DRESSED BY THESE TOOLS



CONVEX



CONCAVE



ANGLED



MULTI-ANGLED

SPEC CHECK

Cone Point Tool Marking System

Tool Type	Included Angle On Diamond	Radius On Diamond	Carat Weight	Shank Diameter
CP	6 = 60°	05 = .005"	L = .10 - .15	6 = 3/8"
	7 = 75°	10 = .010"	M = .20 - .25	7 = 7/16"
	9 = 90°	15 = .015"	H = .33	
		20 = .020"	X = .50	
		25 = .025"		
		30 = .030"		

Example: **CP 6 10 M-6**

Cone Point Tools *continued*

Standard Cone Point Tool

- These tools are used for precision dressing when the most intricate forms and radii are required; can be relapped

TIER: **BEST**

INCLUDED ANGLE ON DIAMOND	RADIUS ON DIAMOND	TOOL CARAT WEIGHT	SHANK DIAM.	TOOL LENGTH	PRODUCT #	RELAPPABLE PART #
60°	.010"	.20 - .25	3/8"	2"	CP610M-6	662601 95240

Standard Package = one tool

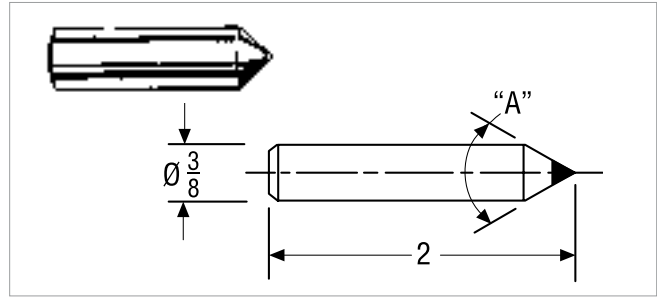

Wheel Forms Dressed by These Tools



CONVEX

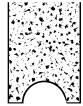

CONCAVE

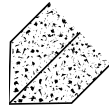

ANGLED



MULTI-ANGLED

Chisel Point Tools

Chisel Point Tool for Toyoda Grinders

- High-precision chisel point tool designed for forming intricate shapes and radii
- Specifically engineered to fit Toyoda machine series GL32 and GL4, it can also be used on various straight and angle-head grinders – for dressing conventional and ceramic abrasive wheels, sizes 12" to 24"
- This tool can be reset/relapped

TIER: **BEST**

INCLUDED ANGLE ON DIAMOND	RADIUS ON DIAMOND	TOOL CARAT WEIGHT	SHANK DIAM.	TOOL LENGTH	PRODUCT #	RELAPPABLE PART #
55°	.020"	.75	7/16"	1.10"	CHT520-7	662601 03741

Standard Package = one tool

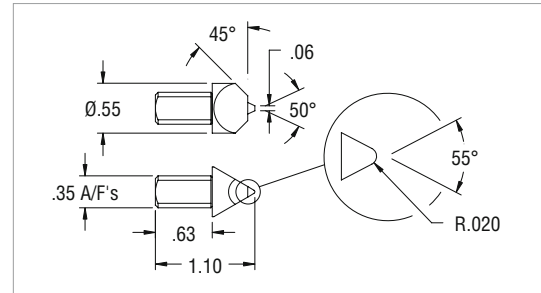

Wheel Forms Dressed by These Tools



CONVEX



CONCAVE

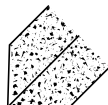

ANGLED

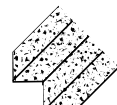

MULTI-ANGLED

SPEC CHECK

Chisel Point Tool Marking System

Tool Type	Included Angle On Diamond	Radius On Diamond	Carat Weight	Shank Diameter
CH	6 = 60°	05 = .005"	L = .10 - .15	6 = 3/8"
(Natural)	7 = 75°	10 = .010"	M = .20 - .25	7 = 7/16"
Diamond)	9 = 90°	15 = .015"	H = .33	
		20 = .020"	X = .50	
		25 = .025"		
		30 = .030"		

Example: **CH 9 5 M-6**

TECH TIP

Chisel Point Tools

Chisel Point Tools should be rotated 180° when dulling or contour problems occur.



Cluster Tools

Norton Winter Cluster tools are designed specifically for straight face dressing of large diameter, coarse grit grinding wheels on single or double disc, centerless, or surface grinders.

Wheel Forms Dressed by These Tools



STRAIGHT TAPERED

Multi-Point Cluster Tools

- Multi-Point Cluster tools are typically used for straight face dressing on disc and centerless operations
- For greatest efficiency, these tools should be mounted at a 15° angle so that three diamonds are in contact with the wheel face at all times
- The tool should be rotated at frequent intervals; not resettable

TIER: BETTER

DIAMONDS ON FACE	SHANK DIAMETER	TOOL LENGTH	PRODUCT #	NON-RESETTABLE PART #
Stock Multi-Point Cluster Tools				
7	7/16"	1-5/16"	NC7K7	662601 95206

Standard Package = 1 Tool

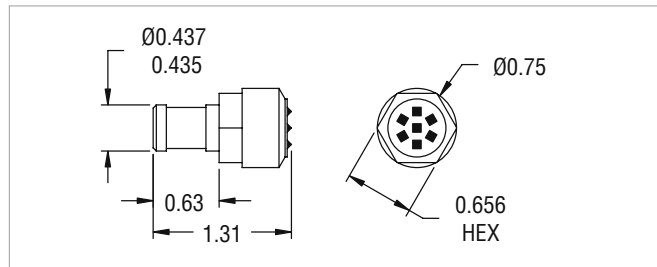

Wheel Forms Dressed by These Tools



STRAIGHT TAPERED

Dia-Pak Tools

- Dia-Pak tools are primarily used in straight face disc grinding, but are extremely versatile and may also be used in centerless and surface operations
- Designed for maximum economy, three layers of diamond are carefully arranged so that a new layer is exposed before the previous layer is completely worn away; not resettable

TIER: BETTER

FOR WHEEL DIAMETERS	DIAMONDS PER LAYER	SHANK DIAMETER	TOOL LENGTH	PRODUCT #	NON-RESETTABLE PART #
Stock Dia-Pak Tools					
Up to 14"	5-4-5	7/16"	2"	DP20	662601 95200
Up to 20"	7-6-7	7/16"	2"	DP30	662601 95201
Any	7-6-7	7/16"	2"	DP35	662601 95202

Standard Package = 1 Tool

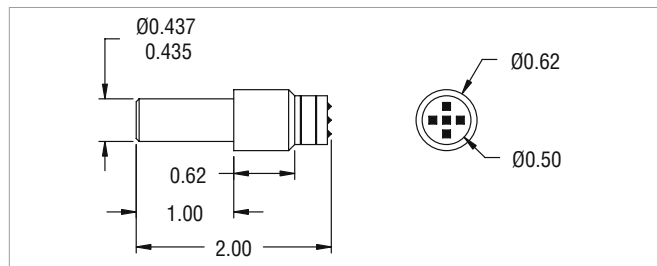

Wheel Forms Dressed by These Tools



STRAIGHT TAPERED

TECH TIP

Cluster and Dia-Pak Tools – Straight face dressing of hard / coarse wheels:

- Tool should approach the wheel at a 15° angle and be rotated periodically to keep three diamonds in contact with the wheel at all times.
- Tools can also be used at a 90° to the wheel face.
- Multi-Point Cluster tools should be rotated at frequent intervals.
- Infeed per pass should not exceed .0015" (.001" with ceramic – Norton SG, Quantum, Targa TG, etc. – wheels).
- Use coolant whenever possible.
- These tools permit a faster traverse rate providing a freer cutting wheel than when dressed by a single-point tool.



Tool Holder/Hand Dresser

- Designed for use when offhand truing and dressing on tool and cutter, or benchstand grinders.
- This stock hand dresser will not rust, and is 10-1/2" long, with a hollow shaft that accepts any tool shank length from 3/4" to 9". The 1-3/4" diameter plastic knob ensures a firm grip. The collet accepts a 7/16" diameter tool shank.

DESCRIPTION	PART NUMBER
Hand Dresser	662601 95020

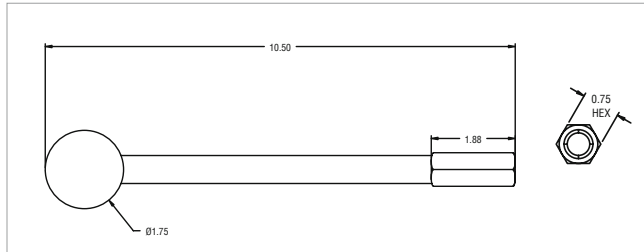

Open or Closed Dressing... You Can Count on Fliesen Tools

Whether dressing a wheel OPEN or CLOSED you can count on Fliesen tools. Open wheels (sharp, free-cutting abrasive grains are exposed) are created by increasing the speed a Fliesen tool moves across the wheel when dressing. Generally considered the most favorable wheel conditioning, open wheels avoid workpiece burn while maximizing a wheel's ability to remove metal quickly when grinding.

Slowing a Fliesen tool as it moves across the wheel creates a closed wheel condition (abrasive grains are smoother, less sharp); a very helpful condition when trying to lower part surface finish readings.

- Harder, H-bond metal formulation tools have been specifically engineered to efficiently dress durable silicon carbide and ceramic wheels
- Furioso Fliesen tools have a unique bond system developed for optimal performance when dressing Norton Quantum (NQ) ceramic wheels
- W-bond Fliesen tools are designed for conventional aluminum oxide wheels



The Benefits of Fliesen Tools

Spend More Time Grinding

Single point, chisel, and cone point tools require operator attention to ensure proper tool rotation at regular intervals. Fliesen tools require no adjustments. Simply install the tool, dress the wheel to break it in, and the tool will do the rest. Operators spend more time grinding – rather than making non-productive dressing adjustments.

Longer Tool Life

Expect long life when using a Fliesen tool. Other stationary tools, made with a single diamond stone, develop flat spots ("wear flats") over time – which create chatter and burn. Fliesen tools use hand-set, fine diamond grit, eliminating the creation of wear flats.

Fliesen Tool Configurations: Plate and Shank

Fliesen tools are available in two basic tool configurations. The most common is a plate configuration, which is somewhat rectangular-shaped with a mounting hole. Fliesen shank tool configurations are plates mounted in shanks of varying sizes and shapes. Most grinding machines accommodate one or the other tool configuration. To find the correct tool configuration for your machine, check the existing dressing tool, or consult your grinding machine manual.

Choosing The Correct Fliesen Tool

Using the chart below, find your desired wheel form – then locate the preferred diamond position. Next, find the correct tool configuration for your machine: plate or shank tool. Follow down that column to find the Fliesen page for your plate or standard shank tool configuration. Go to the appropriate page. Locate the corresponding zone for your wheel diameter and width on the graph. Find that zone number in the part number chart. Next, moving to the right, find your wheel abrasive type and grit size. Locate the part number for your Fliesen tool.

Desired Wheel Form					
Diamond Positions	Blade Only FR	Side-Mounted FRS, FAS, FBS, FCS & FDS	Center-Mounted FAS, FBS, FCS & FDS	Double-Sided FCSD & FDSD	Twin FDST, FSST & 1TFAS
TOOL CONFIGURATION					
Plates 	Consult Customer Service	Page 282 – 283	Consult Customer Service	Consult Customer Service	Page 282 – 283
Shank Tools 	Consult Customer Service	Consult Customer Service	Consult Customer Service	Consult Customer Service	Consult Customer Service

Furioso Tools

The new generation of highly wear-resistant stationary diamond dressing tools for dressing modern ceramic abrasives

PERFORMANCE ADVANTAGE

Furioso vs. Standard Blade

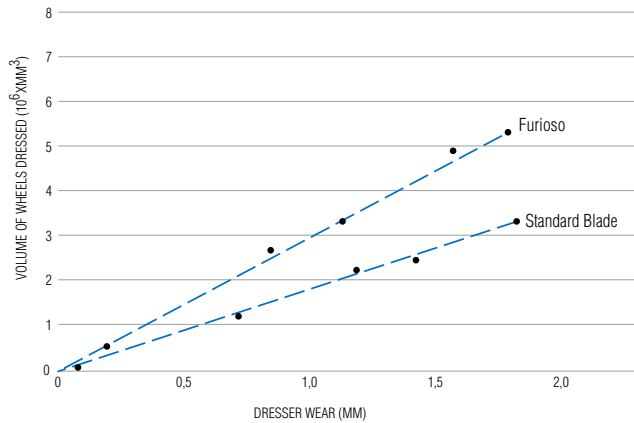

Best choice for optimum performance of Norton Quantum or other ceramic wheels



FLIESEN FURIOSO TOOLS

- The optimized combination of diamond quality, bond and setting pattern when dressing Norton Quantum (NQ) or other ceramic grinding wheels
- Improved wear-resistance and enhanced tool life; excellent dressing behavior with optimum consistency
- Constant surface roughness

Standard Furioso Plate Drawings

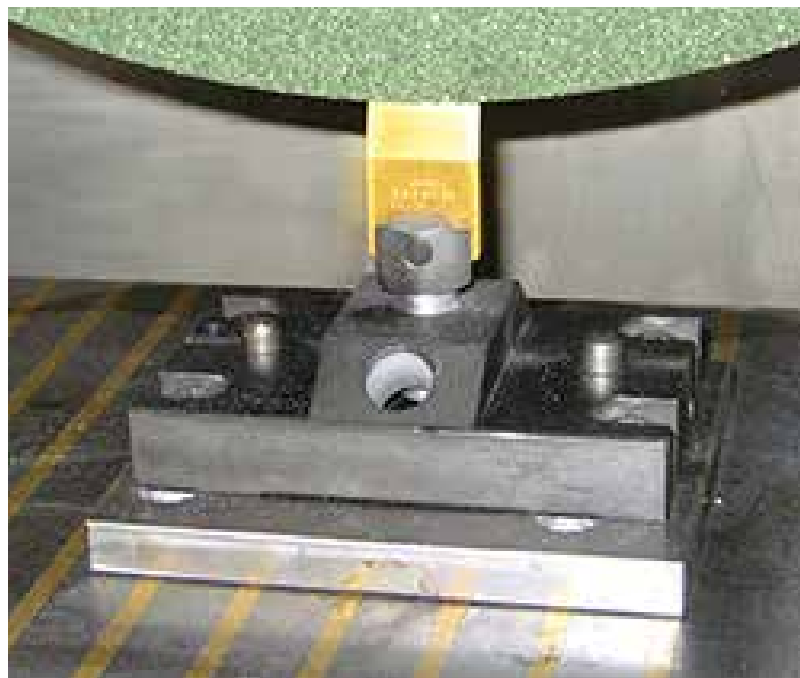
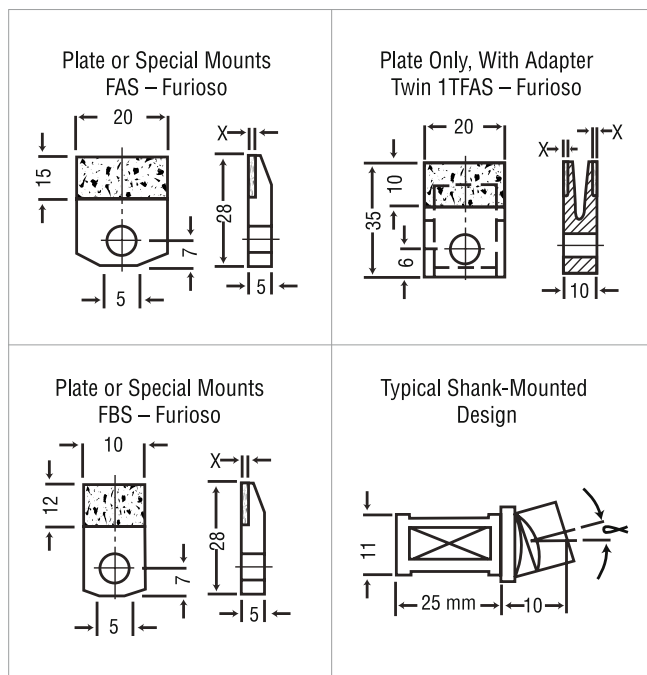

Furioso Plates; Side-Mounted and Twin

Use the Wheel/Tool Graph to identify your grinding wheel's Zone number, and the chart below to find the Furioso tool for your application.

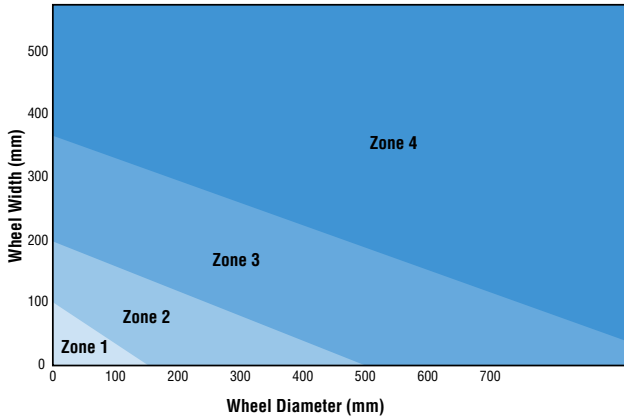

Wheel / Furioso Tool Graph

Select Zone based on wheel diameter and width



TIER: **BEST**

TO DRESS: **NORTON QUANTUM NQ CERAMIC WHEELS**

ZONE NO. / SERIES	WHEEL GRIT SIZE	TOOL #	PART #	DESCRIPTION
Side-Mounted				
 Zone 2 FBS Series	36 - 54	DT1463	690141 22948 *	FBS 140 Furioso
	54 - 80	DT1462	690141 22947 *	FBS 115 Furioso
	80 - 120	DT1461	690141 22946 *	FBS 90 Furioso
	120 - 180	DT1460	690141 22944 *	FBS 75 Furioso
 Zone 3 FAS Series	36 - 54	DT1467	690141 22952 *	FAS 140 Furioso
	54 - 80	DT1466	601576 90579 *	FAS 115 Furioso
	80 - 120	DT1465	601576 93885 *	FAS 90 Furioso
 Twin Zone 4 1TFAS Series	36 - 54	DT1471	690141 22956 *	1TFAS 140 Furioso
	54 - 80	DT1470	690141 22955 *	1TFAS 115 Furioso
	80 - 120	DT1469	690141 22954 *	1TFAS 90 Furioso
	120 - 180	DT1468	690141 22953 *	1TFAS 75 Furioso

* All Furioso Plates shown ship in 10 business days from receipt of order.

SPEC CHECK

Blade Size

DESCRIPTION	DIMENSION
1 FBS	10 mm thick, 15 mm usable length
2 FAS	20 mm thick, 15 mm usable length
3 TFAS	Twin blade with cooling duct

Diamond Grit Size

DESCRIPTION	FEPA
140	D1181
115	D1001
90	D711
75	D501

Furioso Shank Tools

Made-to-order Furioso shank tools are also available. Ask your Norton representative for ordering assistance.

Side-Mounted Diamond Sections

Tools are available in different offset positions and angles.



Offset Left,
Specify
angle amount

Zero Offset

Offset Right,
Specify
angle amount

Tipping the Diamond Plates on Shank Tools

Diamond sections can be tipped right or left.



Diamond
Tipped Left,
Specify angle

Diamond
Tipped Right,
Specify angle

There are many different diamonds making up a single plate as this cut-away view shows.



Norton Winter diamond rotary truing and dressing tools provide a very efficient way to modify the shape and topography of your grinding wheels.

Products:

- Form Rolls: Plunge Dressing
 - Infiltrated diamond form rolls
 - Reverse plated diamond form rolls
- Dressing Discs: CNC Traverse Dressing
 - Infiltrated dressing discs
 - BPR dressing discs (for dressing superabrasive wheels)
 - IDW dressing discs (for dressing superabrasive wheels)
- Truing and Dressing Spindles and Devices

Form Roll: Plunge Dressing

- Diamond roll geometry matches geometry of part to be ground
- Roll is fed into grinding wheel to generate the desired form and wheel surface condition
- Used where lowest cycle time and highest accuracy is required

Dressing Disc: CNC Traverse Dressing

- Diamond dressing disc has a thin diamond section that is traversed across the face of the grinding wheel
- Profile is generated with a CNC program or template
- Used for simple profiles or where flexibility is necessary

How to Order Rotary Dressing Tools

Provide the following information to your local sales representative or customer service representative

Legible blueprint of roll, wheel, or part with the following geometry:

- Overall diameter
- Overall length
- Bore size and tolerances required
- Mounting pattern
- Any feature with tolerances less than 0.0002" (5 um) must be clearly defined for engineering review
- If designing from a part, a fully dimensioned part drawing is required
- Abrasive type (natural diamond, synthetic diamond, CVD stones, etc.)
- Specification of wheel to be dressed (need at least the grit type and size)
- Dressing type (Plunge or CNC Profiling)

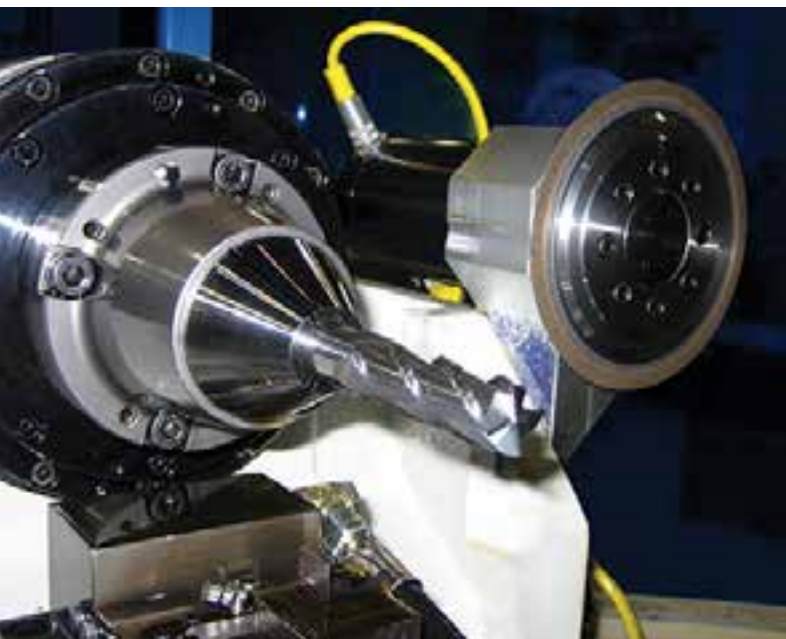

Request the "Rotary Truing and Dressing" brochure, form # 8535, and contact your Norton representative for more information and expert assistance with your dressing operation.



Brake Controlled Truing Devices

Designed for truing diamond and cBN wheels rapidly, effectively, and with a minimum of superabrasive loss. Recommended for wheels up to 12" in diameter.

Applications:

- Truing straight, cup and cylinder wheels:
- Straight wheels, used on chip breaker, tool and cutter, surface, and cylindrical grinding machines
 - Cup wheels, used on vertical spindle surface grinders
 - Internal grinding wheels
 - Cut-off wheels

Non-Stock 4597 Brake Controlled Truing Device

The 4597 is engineered for heavier and more frequent truing applications. The adjustable speeds allow for varying conditions (between 1050 and 1500 SFPM). It comes complete with a reusable case, two 3" 38A60-M8VBE* vitrified wheels, Truing Device Tips book and a dressing stick. It can be rebuilt using the 4597RK Rebuild Kit.

Worn #4597 Brake Controlled Truing Devices (UPC 662601**95350**) in need of reconditioning (beyond new shoes and springs) may be returned to be rebuilt. Contact Customer Service for return instructions and quote.

Stock 3597 Pacesetter Brake Controlled Truing Device

The Pacesetter model is ideal for light-duty use. The pre-set brake speed requires no adjusting. This model includes one 3" 38A60-M8VBE* vitrified wheel and can be rebuilt using the 3597RK Rebuild Kit.

Stock 4597RK and 3597RK Rebuild Kits

The truing devices can be rebuilt with these kits, consisting of 3 brake shoes, 3 springs, and 3 screws.

ITEM	TIER: BETTER		GOOD	
	PRODUCT NO.	PART #	PRODUCT NO.	PART #
Truing Devices				
4597 Brake Controlled Truing Device	4597	662601 95350 NS		
3597 Pacesetter Brake-Controlled Truing Device	3597	662601 35578		
Truing Device Rebuild Kits				
4597 Rebuild Kit	4597RK	662601 95351		
3597 Pacesetter Rebuild Kit	3597RK	662601 35595		
Replacement Wheels				
3 x 1 x 1/2			38A60-MVBE	662435 29145
			38A80-MVBE	662435 29146
			37C60-MVK	662435 29166
			37C80-HVK	662435 29170
			37C80-MVK	662435 29171
			37C100-HVK	662435 29172
			37C100-MVK	662435 29070

NS Non-Stock: Please contact your Norton representative for current lead-times.

SPEC CHECK

Truing Diamond and cBN Wheels

SUPERABRASIVE WHEEL	TRUING WHEEL SPECIFICATION
Resin and Vitrified Bond	
80, 100, and 120 grits	38A60-MVBE 37C60-MVK
150, 180, and 220 grits	38A80-MVBE 37C80-MVK
320 and finer grits	37C100-HVK
Metal Bond	
80, 100, and 120 grits	38A60-MVBE
150, 180, and 220 grits	38A80-MVBE
240 and finer grits	37C80-HVK

TECH TIP

- Prior to truing the wheel, run a wax crayon over the wheel face. Important: do NOT use any liquid-based ink on superabrasive wheels.
- Any crayon left on the wheel face after truing will reveal untrued areas.
- Indicate the superabrasive wheel runout before starting... usually within .001" to .002", to minimize wheel loss.
- Mount the device spindle parallel to the wheel spindle to ensure proper straight face truing.
- For cup-shaped wheels, the device spindle will be mounted perpendicular to the wheel spindle.
- Always use the brake-controlled truing device dry.
- Bring the diamond/cBN wheel and the truing wheel together until they almost touch.
- Start the diamond/cBN wheel to normal speed; spin the truing wheel in the same direction at point of contact.
- Bring the two wheels together until they touch.
- Make sure the truing wheel is spinning at time of contact.
- Traverse the wheel back and forth at 30 to 60 inches/minute.
- Downfeed .0005" to .001" at the end of each traverse.
- At the end of truing, the diamond/cBN wheel should be smooth and in truth.
- Apply a dressing stick to sharpen the wheel.



It is the user's responsibility to refer to and comply with ANSI B7.1



Regular use of properly selected dressing sticks will help you achieve maximum performance from your grinding wheels.

Applications:
Grit range:
Abrasive grain:
Shape:
Machine Used:

Truing, cleaning, and dressing diamond, cBN, and conventional abrasive grinding wheels
16 – 1200
Aluminum Oxide, Boron Nitride, Silicon Carbide
Square, rectangular, and round



HAND DRESSING

Grinding Wheel-to-Product Recommendation Guide

Selecting the appropriate dressing stick for each application depends on the wheel size, type, speed, specification, and grit size, as well as the workpiece material. Initial starting specifications are listed below. We recommend testing several sticks to find the best one for your application.



	Product	Specification
Superabrasive Wheels - Resin and Vitrified Bond		
- 80, 100, and 120 grits	Dressing Stick	38A150-HVBE
- 150, 180, and 220 grits	Dressing Stick	38A220-HVBE
- 320 and finer grits	Superfine Stick	NMVC400-J5VCA
Superabrasive Wheels - Metal Bond		
- 80, 100, and 120 grits	Dressing Stick	37C80-NV
- 150, 180, and 220 grits	Dressing Stick	37C150-KV
- 240 and finer grits	Dressing Stick	37C220-KV
Conventional Vitrified Wheels - Vitrified Bond		
- 46 grit and finer and M grade and softer	High Performance Dressing Stick	Norbide
	Conventional Dressing Stick	37C24-SVK

TECH TIP

Dressing Diamond and cBN Wheels

- Resin and Vitrified Bond Diamond, and cBN Wheels: choose a dressing stick one or two grit sizes finer than the abrasive in the wheel – in a soft grade (H or I)
- Metal Bond Diamond, and cBN Wheels: choose a stick the same grit size or one grit size coarser than the abrasive in the wheel – in a medium grade (K–M)



It is the user's responsibility to refer to and comply with ANSI B7.1

Offhand Grinding Wheel Dressing Stick and Holder

This convenient metal holder is widely used by mechanics and foundry-men for truing, dressing and changing the face of the wheel. The JT246 dressing stick – an extra coarse grit silicon carbide for dressing conventional vitrified wheels – is firmly held and adjusted by the knurled control.



SIZE (D x L)	SPEC.	STD. PKG.	TIER: BETTER	
			PRODUCT #	PART #
Offhand Grinding Wheel Dressing Stick and Holder				
1/2 x 6 Round	Silicon Carbide Extra Coarse Grit Round Dressing Stick	5	JT246	614636 87900
10 Overall	Dressing Stick Holder	5	H6	614636 87895

Norbide High-Performance Sticks

For offhand truing and dressing of medium grit, soft- and medium-grade conventional vitrified grinding wheels. Norton Norbide sticks are the hardest sticks you can buy. Made from boron nitride, they are well suited for dressing tool and cutter wheels 10" and smaller, especially cup and saucer shapes.

SIZE (T x W x L*)	STD. PKG.	TIER: BETTER	
		SPEC.	PART #
High Performance Long Life Stick			
1/4 x 1/2 x 3	5	Norbide	614636 10148

* Thickness x Width x Length

Vitrified Dressing Sticks

Aluminum Oxide (White)

For dressing and cleaning diamond and cBN superabrasive wheels.

Silicon Carbide (Black)

Coarse grit (16 - 46) and hard-grade (R and harder) sticks are used for dressing conventional vitrified wheels. Finer grit and softer grades are used for dressing diamond wheels.

SIZE (T x W x L)	TIER: BETTER		PART #
	STD. PKG.	SPEC.	
Vitrified Dressing Sticks – Aluminum Oxide			
3/8 x 3/4 x 4	5	38A150-IVBE	614636 39635
1/2 x 1/2 x 4	5	38A220-HVBE	614636 10555
1/2 x 1/2 x 6	5	38A150-IVBE	614636 10303
	5	38A220-HVBE	614636 10103
1/2 x 3/4 x 4	5	38A60-LVBE	614636 10415
1/2 x 1 x 4	5	38A180-IVBE	614636 99705
3/4 x 3/4 x 4	5	38A60-LVBE	614636 10440
	5	38A80-MVBE	614636 10362
	5	38A90-LV	614636 39632
	5	38A150-HVBE	614636 10291
	5	38A150-IVBE	614636 10368
	5	38A220-HVBE	614636 10290
	5	38A220-HVBE	614636 10280
3/4 x 3/4 x 8	5	38A220-HVBE	614636 10280
1 x 1 x 6	5	38A150-HVBE	614636 10405
	5	38A150-IVBE	614636 10453
	5	38A220-HVBE	614636 10406
1 x 1 x 8	5	38A120-IVBE	614636 10390
	5	38A150-IVBE	614636 10455

SIZE (T x W x L)	TIER: BETTER		PART #
	STD. PKG.	SPEC.	
Vitrified Dressing Sticks – Silicon Carbide			
1/2 x 1/2 x 6	5	37C24-SVK	614636 10285
	5	37C100-LV	614636 10201
	5	37C150-KV	614636 10205
	5	37C150-LV	614636 10206
	5	37C150-MV	614636 10207
	5	37C220-KV	614636 10214
	5	37C150-LV	614636 10375
	5	37C20-SVK	614636 10459
	5	37C24-SVK	614636 10462
	5	37C24-TVK	614636 10354
3/4 x 3/4 x 6	5	37C46-RVK	614636 10466
	5	37C80-NV	614636 10393
	5	37C150-KV	614636 10438
	5	37C220-KV	614636 10398
	5	37C20-SVK	614636 10469
1 x 1 x 6	5	37C24-SVK	614636 10471
	5	37C16-TVK	614636 10482
1 x 1 x 8	5	37C24-TVK	614636 10485
	5	37C24-SVK	614636 10490
Vitrified Round Dressing Sticks – Silicon Carbide			
1/2 x 6	5	37C24-SVK	614636 10371
1 x 6	5	S/C Ex-C (JT276)	614636 87905

Vitrified Superfine Sticks

For dressing diamond and cBN superabrasive wheels.

SIZE (T x W x L)	TIER: BETTER		PART #
	STD. PKG.	SPEC.	
Vitrified Superfine Sticks – Aluminum Oxide			
1 x 1 x 6	5	PCD Coarse - 400 grit	614636 47865
	5	PCD Fine - 800 grit	614636 47867
1 x 1 x 8	5	NSA320-H8V	614636 10597
Vitrified Superfine Sticks – Silicon Carbide			
1/2 x 1/2 x 6	5	NMVC320-J5VCA	614636 10599
	5	NMVC400-J5VCA	614636 50324
1 x 1 x 6	5	NMVC320-J5VCA	614636 10605
	5	NMVC400-J5VCA	614636 50450

Organic Silicon Carbide Micro Dressing Wheel

Type 01 straight dressing wheels with sharp high-purity green silicon carbide abrasive.

For micro-dressing fine grit polyimide superabrasive diamond wheels.

TIER: **BEST**
ABRASIVE: Silicon Carbide

SIZE (D x T x H)	MAX. RPM	MIN./STD. PKG.	SPEC.	PART #
Type 01 Straight 				
200mm x 10mm x 31.75mm	2,870	5	320 Silicon Carbide Organic Micro Dressing Wheels	662532 96349*

* For fine grit diamond Polyimide wheels

For additional silicon carbide wheels that can be used for dressing see page 242 in the Precision Grinding Silicon Carbide Toolroom Wheels section

Diamond and cBN Wheel Mounting, Truing and Dressing Guide

To achieve the best results using Norton Winter diamond and cBN products, the following steps for mounting, truing and dressing should be practiced:

MOUNTING – Putting Wheel on Machine Spindle

- Examine wheel flanges and spindle carefully.
- Be sure flanges' surfaces are clean and free of damage.
- Ensure that the mounting flanges are flat and of equal diameter, especially on wheels with rigid centers, such as vitrified bond wheels.
- Paper or plastic blotters should only be used when mounting superabrasive wheels with vitrified cores. Using paper or plastic blotters on any other core material might result in the wheel loosening during grinding.
- Inspect machine spindle for excessive runout.
 - » TIR (Total Indicated Runout) should be no greater than 0.0002".
- Mount wheel between hand-tightened flanges.
- Using a dial indicator, tap the wheel lightly with a rubber or wooden block to minimize runout to less than .0010".

TRUING – Making Wheel Round and Concentric with the Spindle Axis

- Prior to truing the wheel, run a wax crayon over the wheel face. Important: do not use any liquid-based ink on superabrasive wheels.
- Any crayon left on the wheel face after truing will reveal untrued areas.
- Indicate the superabrasive wheel runout before starting... usually within .001" to .002", to minimize wheel loss.
- Brake controlled truing devices are most commonly used to true Diamond and cBN straight, cup and cylinder wheels.
 - » Mount the device spindle parallel to the wheel spindle to ensure proper straight face truing.
 - » For cup wheels, the device spindle will be mounted perpendicular to the wheel spindle.
 - » Always use brake controlled truing device dry.

DRESSING – Opening the Face of a Trued Wheel

- Dressing the abrasive – a cleaning/sharpening process to expose sharp, free-cutting grit:
 - » For resinoid and vitrified bond wheels, the dressing stick should be one or two grit sizes finer than the abrasive in the diamond/cBN wheel – in a soft grade such as H or I.
 - » For metal bond wheels, choose a stick with the same grit or one grit coarser than the wheel abrasive – in a medium grade (K – N).
 - » See the "Dressing Stick" section for recommendations.

- Tighten flange securely and recheck with indicator.
- Allow a newly mounted wheel to operate for one full minute before grinding.
- The use of one permanent mounting for the life of the wheel is recommended whenever possible:
 - » If the grinding machine has a tapered spindle, mount each straight, flaring cup or dish wheel on a separate collet or adapter.
 - » When changing wheels the entire unit is removed, keeping the wheel in running truth.
 - » When needed again, the entire unit can be placed directly on the spindle or arbor, thereby eliminating the time and abrasive lost in retruing.

- » Bring the diamond/cBN wheel and the truing wheel together until they almost touch.
- » Start the diamond/cBN wheel to normal speed; start the truing wheel in the same direction.
- » Bring the two wheels together until they touch.
- » Make sure the truing wheel is spinning at time of contact.
- » Traverse the wheel back and forth at 30 to 60 inches per minute.
- » Downfeed .0005" to .001" at the end of each traverse.
- » At the end of truing, the diamond/cBN wheel should be smooth and in truth.
- » Apply a dressing stick to sharpen the truing wheel.

- Dressing the core – The core material (the part of the wheel that holds and supports the abrasive-bearing section) should never contact the work piece during grinding; rubbing will generate excessive heat. As the abrasive section of a cup wheel wears, the core material might become exposed, necessitating dressing.
 - » Use a single-point carbide or steel tool to dress an exposed resalloy core.
 - » Clamp the tool in a vise.
 - » Direct the cutting edge accurately to leave a 1/16" of abrasive section exposed.

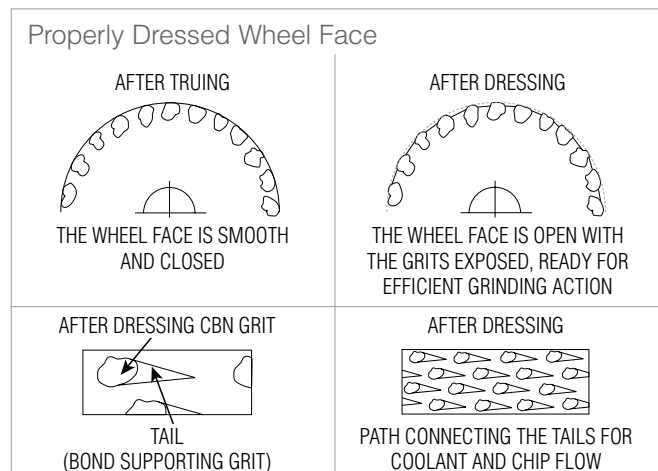



setting a new
industry standard
FOR PRODUCTIVITY

From the most comprehensive stock offering to the industry's largest custom-manufactured availability, our Norton Winter superabrasive product portfolio gives you the most options with uncompromising performance.

- Diamond / cBN Stock Wheels
- B99 Express Made-to-Order Resin Wheels
- CNC Wheels
- Electroplated Products
- Lapping Compound

Norton Winter Diamond Product Identification System / Usage Information

ASD 120 – R 75 B99 1/8

Abrasive Type	Grit Size	Grade	Concentration	Bond	Abrasive Depth
ASD <ul style="list-style-type: none"> Used with B99 and B105 bonds Armored Durable Versatile Use wet or dry Carbide/steel operations 	<ul style="list-style-type: none"> 100S – Roughing 120 – Roughing/cutting-off 150 – Combined roughing and finishing 180 – Improving finish 220, 320 & 400 – Finishing only 10/20 mic 6/12 mic 	Resin Bond R – Norton standard N – Free cutting Metal Bond N – Norton standard Vitrified Bond P – Norton standard R – Most durable	50 <ul style="list-style-type: none"> Most economical For broad area of contact 75 <ul style="list-style-type: none"> Norton standard Freer cutting than 100 Dry grinding with ASD 100 <ul style="list-style-type: none"> Very durable For flood coolants Use with 220 grit or finer Use for cutting-off 115 <ul style="list-style-type: none"> For CNC grinding machines 125 <ul style="list-style-type: none"> Form holding For high volume, high pressure coolant, precision applications on high-speed tool steels 	B99 <ul style="list-style-type: none"> Resin bond Use wet or dry Tool making; resharpening B105 <ul style="list-style-type: none"> Premium resin bond Advanced heat-reducing bond Use dry; reconditioning B610 and B80 <ul style="list-style-type: none"> For CNC grinding machines M99 <ul style="list-style-type: none"> Metal bond 1A1R cut-off Glass and ceramics MSL <ul style="list-style-type: none"> Metal single layer Type 6A2C only Use dry Offhand reconditioning/finishing carbide V99 <ul style="list-style-type: none"> Vitrified bond Offhand finishing of carbide tools Plunge grinding 	1/16" 1/8" 1/4" 9/32" 3/8" 1/2" 3/4" Solid
CD <ul style="list-style-type: none"> Used with B99 bond 					
D <ul style="list-style-type: none"> Used with B99 bond Micron-sized diamond; finishing 					
M3D <ul style="list-style-type: none"> Used with M99 bond 					
M4D <ul style="list-style-type: none"> Used with M99 bond Armored Durable; for non-metallics 					
RMD <ul style="list-style-type: none"> Used with V99 bond 					
SD <ul style="list-style-type: none"> Used with B99 and V99 bonds Norton standard Use wet or dry Free cutting Low horsepower (3/4 hp or less) 					

Norton Winter cBN Product Identification System / Usage Information

CB 120 – T B99 1/8

Abrasive Type	Grit Size	Grade	Bond	Abrasive Depth
CB – cubic Boron Nitride <ul style="list-style-type: none"> Used with B99 bond Armored Use wet or dry 	<ul style="list-style-type: none"> 100 – Roughing 120 – Roughing/cutting-off 150 – Combined roughing and finishing 180 – Improving finish 220, 320, 400 – For finishing only 	Q <ul style="list-style-type: none"> Approx. 50 concentration Type 6A2 Broad area of contact T <ul style="list-style-type: none"> Approx. 75 concentration Norton standard First choice Lower horsepower Broad area of contact Dry grinding Resharpening applications W <ul style="list-style-type: none"> Approx. 100 concentration Most durable High volume coolant Flute polishing Surface grinding Cylindrical grinding 	B99 <ul style="list-style-type: none"> Resin bond Use wet or dry Aztec III <ul style="list-style-type: none"> Premium resin bond Use dry Tool resharpening Aztec .007 <ul style="list-style-type: none"> Premium resin bond Use dry Increased feed rates Heavy stock removal Heavier cuts 	1/16" 1/8" 1/4" 1/2" Solid

Application-to-Product Recommendation Guide – Diamond Wheels

APPLICATION OR COMMON MACHINE TYPE	COMMON WHEEL SIZE, TYPE & BLUEPRINT	APPLICATION VARIABLES		RECOMMENDED SPECIFICATION
Carbide Grinding – Toolroom Production				
Blanchard Grinding Vertical Spindle Surface Grinding	10", 11", 16" & 18" diameters Type 2A2T	Wet – solid carbide	1" or larger pieces	SD100-R75B99E*
			– roughing Small pieces	ASD100-R75B99E*
		Carbide & steel (combination)		ASD100-R75B99E*
Hand Burr Grinding	6" x 3/32" x 1-1/4" Type 1V1P V – 20° ME89562	Dry		ASDC320B-R125B99
Centerless (wet)	Throughfeed Grinding 12", 14", 16", 18" & 20" diameters Type 1A1	Roughing		ASD100-R75B99E*
	Unison Dedtru Grinder 7" x 1" x 1-1/4" Type 1A1			ASD150-R75B99E*
Cutting Off (wet)	6" x .035" x 1-1/4" Type 1A1R ME43572 10" x .050" x 1-1/4" Type 1A1R ME43565	Most durable		ASD100S-R100B99
		Free cutting		SD100-R75B99
				SD120-R100B99
Cylindrical Grinding (wet)	10", 12", 14", 16" & 20" diameters Type 1A1	Wet, rough grinding of cemented carbides, hard (55 Rc+) plasma and ceramic spray coatings		ASD180-R100B99
				ASD180-R75B99E*
				ASD150-R75B99
				ASD120-R75B99
		Wet, finish grinding of all carbides, plasma and ceramic spray coatings		SD220-R100B99E*
Tool Sharpener Bench Grinder (wet)	5" x 1" x 1-1/4" Type 6A2H ME27084 Rim Width (W) = 1-1/16	Tool sharpening		SD320-R50B99
Hand Honing (dry)	Various sizes Type HH1 or HH2			ASD100-R100B99 SD320-100V99
Lamination Dies (wet)	Various sizes Type 1A1	Surface grinding of carbide		ASD120-R75B99
Surface Grinding (wet) Straight Wheels	Various sizes Type 1A1	Roughing	Durable	ASD100S-R100B99E*
			Free cutting	SD100S-R100B99
		Finishing only		SD220-R100B99
		General purpose		ASD150-R75B99
Tool & Cutter Grinding	Various sizes Type 11V9, 12V9 or 15V9	Wet or dry		ASD120-R7599
Carbide Grinding – Offhand				
Single-Point Carbide Tools	6" x 3/4" x 1-1/4" Type 6A2C ME27853	Wet roughing	Durable	RMD150-P50V99*
			Free cutting	SD150-P50V99
		Wet finishing	Durable	RMD220-P50V99*
			Free cutting	SD220-P50V99
		Wet or dry grinding where free-cutting and self-dressing wheels are required	Roughing	ASD120-R75B99
			Finishing	SD220-R50B99E*

Note: Diamond depths are not indicated in above listings. When ordering, be sure to include Diamond depth (1/16, 1/8, etc.).

*Express Made-To-Order; Refer to the B99E Express Made-to-Order Wheel section.

Application-to-Product Recommendation Guide – cBN Wheels

APPLICATION OR COMMON MACHINE TYPE	COMMON WHEEL SIZE, TYPE & BLUEPRINT	APPLICATION VARIABLES	RECOMMENDED SPECIFICATION
Toolroom Grinding			
Cutter Sharpening Milling Cutters, Broaches, Reamers, etc.	3-3/4" x 1-1/2" x 1-1/4" Type 11V9 ME92192	Dry Wet	Aztec III 120T CB120-TB99
	6" x 1" x 1-1/4" Type 12A2 ME27758	Wet or dry	CB120-TB99
	6" x 3/4" x 1-1/4" Type 12V9 ME48666	Wet or dry	CB120-TB99
	6" x 3/4" x 1-1/4" Type 15V9 ME40633	Wet or dry	CB100-WB99E*
	10" x 1/2" x 3" Type 1A1	Wet or dry	CB100-TB99E*
Surface Grinding	12" x 1/2" x 3" Type 1A1	Wet or dry	CB150-WB99E*
Cylindrical Grinding	Thinner than 1/2" Type DW	Wet or dry	CB100-WB99
	1/2" or thicker Type 1A1	Wet or dry	CB120-TB99E*
Internal Grinding Tools	7" x .040" x 1-1/4" Type 1A1R	Water-base coolant	CB120-WB99E*
Slotting			

Note: cBN depths are not indicated in above listings. When ordering, be sure to include cBN depth (1/16, 1/8, etc.)

**Express Made-To-Order; Refer to the B99E Express Made-to-Order Wheel section.*

Troubleshooting Guide – Dry Grinding

Problem	Possible Causes	Suggested Correction
Burning (excessive heat)	Wheel loaded or glazed	Dress wheel with a dressing stick
	Excessive feed rate	Reduce infeed of wheel or workpiece
	Wheel too durable	Use freer cutting specification or slow down wheel speed
Poor finish	Grit size too coarse	Select a finer grit size
	Excessive feed rate	Reduce infeed of wheel or workpiece
Chatter	Wheel out of truth	True wheel; ensure it is not slipping on mount (See “Mounting, Truing and Dressing Guide”)

Troubleshooting Guide – Wet Grinding

Problem	Possible Causes	Suggested Correction
Burning (excessive heat)	Wheel glazed or loaded	Re-dress wheel
	Poor coolant placement	Apply coolant directly to wheel/workpiece interface
	Excessive material removal rate	Reduce downfeed and/or crossfeed
Poor finish	Excessive dressing	Use lighter dressing pressure Stop dressing as soon as wheel starts to consume stick rapidly
	Grit size too coarse	Select a finer grit size
	Poor coolant flow or location	Apply heavy flood so it reaches wheel/work interface
Chatter	Wheel out of truth	True wheel; ensure it is not slipping on mount
Wheel will not cut	Glazed by truing	Dress lightly until wheel opens up
	Wheel loaded	Dress lightly until wheel opens up Increase coolant flow to keep wheel surface clean Never run wheel with coolant turned off
	Low feeds and speeds	Increase feed rate; increase wheel speed (Do not exceed wheel MOS)
	Incorrect coolant flow	Apply coolant to flood wheel/work surface
Slow cutting	Low wheel speed	Increase wheel speed (observe maximum operating speed)
Short wheel life	Excessive dressing	Use lighter dressing pressure
	Wheel too soft or too hard	Change grit or grade; use higher concentration

Material Hardness Scale

Superabrasives is a term used to describe those abrasives of extreme hardness which produce outstanding results when properly used on specific applications. This graph provides a hardness comparison (Knoop Hardness Scale) between diamond and cBN superabrasives, aluminum oxide and silicon carbide standard abrasives, and some common materials these abrasives are used to grind.

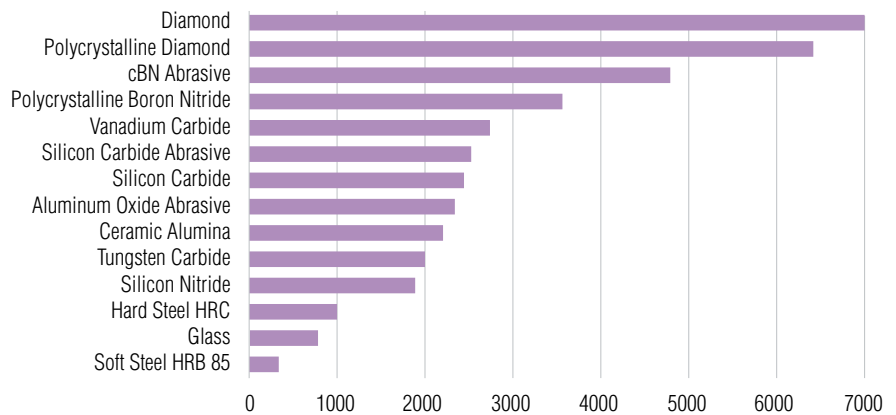

TECH TIP

Avoid Grinding Steel

- Avoid steel when grinding with diamond wheels. Keep the amount of steel ground to an absolute minimum.
- On brazed tools, use aluminum oxide wheel to back off the steel shank.
- A high lubricity grinding fluid should be used.
- For some steels, an armored (AMD) diamond wheel might prove most economical.

Use Rigid Work Support

- All workpieces should be supported firmly during the grinding process. Any amount of vibration will cause wheel wear and produce chatter or wave marks on the ground surface.
- On work ground between centers, centerholds should be properly prepared.
- Minimize work overhang.
- If the ground work is supported by a work finger, ensure the finger is strong enough to provide vibration-free support.

Coolant – Grind Wet

- Diamond wheels should be used with a full flood coolant properly directed toward the grinding zone. Water with a rust inhibitor is recommended.
- Vitrified diamond wheels should be used only with a coolant.
- When flood application can't be used, try mist or spray application.
 - » Use compressed air to "atomize" water or soluble oil.
 - » Direct the spray at the grinding zone to help dissipate heat and prevent heat damage to the work.

Avoid Excessive Feeds

- Excessive feeds will result in premature wheel wear. Excessive feed rates are characterized by:
 - » A hard grinding sound
 - » Chatter
 - » Burn
 - » High wheel wear rate
 - » Vibration

Decimal and Metric Equivalents of Common Fractions

FRACTIONS OF AN INCH	DECIMALS OF AN INCH	MILLIMETERS
1/64	.0156	0.397
1/32	.0313	0.794
3/64	.0469	1.191
1/16	.0625	1.588
5/64	.0781	1.985
3/32	.0938	2.381
7/64	.1094	2.778
1/8	.1250	3.175
9/64	.1406	3.572
5/32	.1563	3.969
11/64	.1719	4.366
3/16	.1875	4.762
13/64	.2031	5.159
7/32	.2188	5.556
15/64	.2344	5.953
1/4	.2500	6.350
17/64	.2656	6.747
9/32	.2813	7.144
19/64	.2969	7.541
5/16	.3135	7.937
21/64	.3281	8.334
11/32	.3438	8.731
23/64	.3594	9.128
3/8	.3750	9.525
25/64	.3906	9.922
13/32	.4063	10.319
27/64	.4219	10.716
7/16	.4375	11.112
29/64	.4531	11.509
15/32	.4688	11.906
31/64	.4844	12.303
1/2	.5000	12.700
33/64	.5156	13.097
17/32	.5313	13.494
35/64	.5469	13.891
9/16	.5625	14.287
37/64	.5781	14.684
19/32	.5938	15.081
39/64	.6094	15.478
5/8	.6250	15.875
41/64	.6406	16.272
21/32	.6563	16.688
43/64	.6719	17.085
11/16	.6875	17.462
45/64	.7031	17.859
23/32	.7188	18.256
47/64	.7344	18.653
3/4	.7500	19.050
49/64	.7645	19.447
25/32	.7813	19.843
51/64	.7969	20.240
13/16	.8125	20.637
53/64	.8281	21.034
27/32	.8438	21.430
55/64	.8594	21.827
7/8	.8750	22.224
57/64	.8906	22.621
29/32	.9063	23.018
59/64	.9219	23.415
15/16	.9375	23.812
61/64	.9531	24.209
31/32	.9688	24.606
63/64	.9844	25.003
1	1.0000	25.400

Expected Surface Finish by Grit Size

Use these charts as guides only. Surface finish is affected by several variables: machine type and condition, type of material ground, coolant, wheel speed, bond system, etc.

DIAMOND

Grit Size	Expected Finish Micro Inch AA	Maximum Depth of Cut per Pass for Grit Size
100	24 to 32	0.001" to 0.002"
120	16 to 18	0.001" to 0.002"
150	14 to 16	0.001" to 0.002"
180	12 to 14	0.0007" to 0.001"
220	10 to 12	0.0007" to 0.001"
320	8	0.0004" to 0.0006"
400	7 to 8	0.0003" to 0.0005"

cBN

Grit Size	Expected Finish With Oscillation	Expected Finish Plunge
100	35 – 40	40 – 45
120	30 – 35	35 – 40
150	25 – 30	30 – 35
180	20 – 25	25 – 30
220	15 – 20	20 – 25
320	10 – 15	15 – 20
400	4 – 8	5 – 10

Recommended Wheel Speeds for Diamond and cBN Wheels

WET GRINDING	Cup Wheels	Peripheral Wheels
	11V9, 12V9, 15V9, etc.	1A1, 1V1, 1A1R, etc.
Diamond Grinding Wheels		
Resin Bond Wheels	4921 to 7874 SFPM 25 to 40 m/s	4921 to 7874 SFPM 25 to 40 m/s
Metal Bond Wheels		3937 to 5906 SFPM 20 to 30 m/s
Vitrified Bond Wheels	2953 to 5906 SFPM 15 to 30 m/s	2953 to 5906 SFPM 15 to 30 m/s
cBN Grinding Wheels		
Resin Bond Wheels	5906 to 9843 SFPM 30 to 50 m/s	5906 to 9843 SFPM 30 to 50 m/s
DRY GRINDING	Cup Wheels 11V9, 12V9, 15V9, etc.	Peripheral Wheels 1A1, 1V1, 1A1R, etc.
Diamond Grinding Wheels		
Resin Bond Wheels	2756 to 3543 SFPM 14 to 18 m/s	2756 to 3543 SFPM 14 to 18 m/s
cBN Grinding Wheels		
Resin Bond Wheels	2953 to 5906 SFPM 15 to 30 m/s	2953 to 5906 SFPM 15 to 30 m/s

Note: These are not the maximum operating speeds (MOS).
Consult ANSI B7.1 or contact your Norton representative for MOS.

Wheel Speed Calculation

To convert M/S to SFPM:	Multiply M/S x 196.85 = SFPM
To convert SFPM to M/S:	Divide SFPM by 196.85 = M/S
To convert RPM to SFPM:	Multiply wheel diameter in inches x RPM x 0.262
M/S = meters/second RPM = Revolutions Per Minute SFPM = Surface Feet Per Minute	



Norton Winter offers an extensive line of stock Diamond and cBN (cubic Boron Nitride) grinding products, including resin, vitrified, metal and MSL (metal single layer) bond offerings, under the "99" quality line. Premium, high-performance stock resin bond options are also available.

Applications:

- B99 Diamond Wheels**
- Sharpening cemented carbide cutting tools
 - Cutting off carbide rod
 - Grinding or cutting off non-ferrous materials such as ceramics or glass
 - Surface grinding dies
 - O.D. grinding spray coatings

B99 cBN Wheels

- Sharpening high-speed (M2, D2, T15, etc.) steel cutting tools
- Surface and ID grinding hardened steel die components
- Precision grinding steel parts Rc 50 or harder

Stock Shapes:

DW Mounted Points, HH1 and HH2 Hand Hones, and 1A1, 1A1R, 1V1P, 4A2P, 6A2C, 6A2H, 11V9, 12A2, 12V9, and 15V9 Wheels

Abrasive Grain:

Diamond and cBN (cubic Boron Nitride)

Abrasive Bonds:

Resin, Metal, Metal Single Layer, and Vitrified

Superior performance for grinding non-ferrous materials



DIAMOND WHEELS

- High quality synthetic diamond
- High material removal rates with longer wheel life vs. conventional green silicon carbide wheels
- Wide variety of stock wheel shapes and bond options available

Diamond Bond Types

BONDS	DESCRIPTION
Diamond Wheel Bonds	
Pre-engineered resin bond – B99	Free cutting; superior form holding; efficient wet or dry
Premium, heavy-duty resin bond – B105	Ideal for dry toolroom reconditioning applications
Metal bond – M99	Ideal for 1A1R cut-off applications and grinding glass or ceramic materials
MSL (metal single layer) diamond tools; no wheel dressing required	Fast stock removal, cool cutting; excellent for dry offhand finishing of carbide
Vitrified bond – V99	Most durable under high grinding forces; excellent for wet, offhand finishing of carbide tools

Superior performance for grinding ferrous materials



cBN WHEELS

- cBN (cubic Boron Nitride) abrasive material is second in hardness to diamond
- Easily cuts difficult-to-grind steel parts Rc 50 or harder
- Highly wear resistant and thermally stable

cBN Bond Types

BONDS	DESCRIPTION
cBN Wheel Bonds	
Pre-engineered resin bond – B99	Free cutting, superior form holding
Premium Aztec III resin bond	Most efficient for dry tool resharpening
Premium Aztec .007 resin bond	Most efficient for dry tool resharpening where heavy stock removal is desired

How to Select Diamond Wheels

SELECT:		
WHEEL SHAPE	Select desired wheel shape	
WHEEL DIMENSIONS	D x T x H Select Diameter x Thickness x Hole from the availability tables. Use blueprint numbers where available.	
ABRASIVE	Select the abrasive based on horsepower, grinding wet or dry, and contact with steel.	
	Resin Bond Wheels:	
	ASD Armored diamond, durable. Versatile: can be used wet or dry. Also should be used when carbide and steel are ground in the same operation.	
	D Micron-sized diamond. Used for finishing and polishing operations.	
	SD Free cutting standard. Used wet or dry; should be used on low horsepower (3/4 hp or less) machines.	
	Metal Bond Wheels:	
	M4D Armored, durable standard. A strong, blocky crystal designed for high performance on glass, ceramics, refractories and other non-metals.	
	Vitrified Bond Wheels:	
	RMD Medium strength. Specifically designed for use with vitrified bonds.	
	SD Free cutting standard.	
	GRIT SIZE	Select the abrasive grit size based on finish and material removal rate required.
	100 Roughing. The most common grit size for roughing operations.	
120 For roughing where 100 is too coarse. Also for cut-off applications.		
150 Medium stock removal plus good finish. For combined roughing and finishing applications.		
180 Medium stock removal plus good finish. To improve finish.		
220 Finishing		
320 Finishing		
400 Fine Finishing		
10/20 Mic Super Fine Finishing		
6/12Mic Super Fine Finishing		
GRADE	The hardness of the wheel	
	Resin Bond Wheels:	
	R Norton standard	
	N Free cutting	
	Metal Bond Wheels:	
	N Norton standard	
	Vitrified Bond Wheels:	
	P Norton standard	
	R Most durable	
	CONCENTRATION	Select the abrasive concentration based on grinding wet or dry, material removal rates and form-holding requirements.
	50 Most economical. For broad area of contact grinding.	
	75 Norton standard. Freer cutting than 100 and the most economical for dry grinding with ASD diamond.	
100 Very durable. Recommended under flood coolant conditions; for use with 220 grit or finer, when durability is required, and for cut-off applications.		
125 Form holding. Used in high volume, high pressure coolant, precision applications on high-speed tool steels.		
BOND	Select the bond based on the material being ground and grinding application.	
	Resin Bond:	
	B99 Norton standard. Versatile enough to be used wet or dry on most tool making or sharpening applications.	
	B105 Premium, heat-reducing bond. For dry toolroom reconditioning applications.	
	Metal Bond:	
	M99 Best suited for 1A1R cut-off applications as well as grinding glass or ceramic materials.	
	MSL Metal Single Layer. Available in shape 6A2C for dry, offhand reconditioning of carbide tools.	
	Vitrified Bond:	
	V99 Best for wet offhand finishing of carbide tools as well as plunge grinding of carbide tools.	
	ABRASIVE DEPTH	Usable abrasive
	1/16	
	1/8	
1/4		
9/32		
Solid		

How to Select Stock cBN Wheels

SELECT:			
WHEEL SHAPE	Select desired wheel shape		
WHEEL DIMENSIONS		D x T x H	Select Diameter x Thickness x Hole from the availability tables. Use blueprint numbers where available.
ABRASIVE	Select cBN abrasive to grind hard tool steels such as A2, D2, T15, etc., and tough alloy steels.	Resin Bond Wheels: CB	Norton standard coated cBN (cubic Boron Nitride). Optimized for high performance in resin bond systems.
GRIT SIZE	Select the grit size based on finish and material removal rate required.	100 120 150	Roughing. The most common grit size for roughing operations. For roughing where 100 is too coarse. Also for cut-off applications. Medium stock removal plus good finish. For combined roughing and finishing applications.
GRADE	The hardness of the wheel	Q T W	Approximately 50 concentration. Used on wide area of contact applications. Norton standard. Approximately 75 concentration. T is the first choice for lower horsepower equipment or large area of contact between the wheel and the work piece. Ideal for resharpening applications with 11V9, 12A2, 4A2P, and 15V9 wheel shapes when dry grinding. Most durable. Approximately 100 concentration, W is recommended for high volume coolant operations: flute grinding from solid, flute polishing, surface, and cylindrical grinding.
BOND	Select the bond depending on the type of grinding application.	B99 Aztec III Aztec .007	Norton standard. Pre-engineered for optimal performance with cBN abrasive. Available in all shapes. The advanced heat-reducing, lubricating resin bond. Used for dry grinding tool steels. The premium resin bond for increased feed rates, high stock removal and heavier cuts – when dry grinding tool steels.
ABRASIVE DEPTH	Usable abrasive	1/16 1/8 1/4 Solid	

Competitive Cross Reference Guides

	Abrasives				Bonds						
	Resin Diamond	Resin Diamond	Metal Diamond	Resin/Vitrified cBN	Resin Diamond	Resin Diamond	Metal Diamond	Vitrified Diamond	Resin cBN	Resin cBN	Resin cBN
NORTON WINTER	ASD	SD	M4D	CB	B99/B99E	B105	M99	V99	B99/B99E	B99EF	AZTEC
3M / General Industrial Diamond / Diamond Productions, Inc	CGD, ND	GD, D, MD		CB	PS			V		BC	
Abrasive Technology	SN	S		cBN	B		M		B		
Accurate Diamond Tool	NCD	D, MD		BN	B		M				
Citco	5SD, 6SD	SD	MD	CB	B43, B52		M		B26	C3	
Engis	NMD	D, MD		cBN, CB							
Noritake				CBC		BX4			BD/B38		BX4
Radiac / US Diamond	NCD, WD, 1WD, MDC	D, MD	MD4C	B, CB, BZ	B7Z, BB, B5, B56, BN		M, MF	V	BZ, BN		
Regal Diamond				B, BB	BJ						
Superabrasives, Inc.	MDN	D, MD		B					B82	B5	
Tyrolit / Wickman / Bay State / Cincinnati	SDM, XDL, XDN, D, 7D, CMD	SD, D, 6D, MD	1D	5B, 1BN, BN, BM	BD, BC, BX33, B52, B6	Amigo	MI, MSS, MB		B72, B56, BG, B7	BXU8	Amigo
Wendt / Slip Naxos / Winterthur	SDK			B, BXW					RN	RR	

	ABRASIVES		BONDS	
	UNIVEL/G-FORCE		DIAMOND AND cBN	
NORTON WINTER POLYIMIDE	DIAMOND AD	cBN BX	UNIVEL	G-FORCE
3M / General Industrial Diamond / Diamond Productions, Inc	D	CB	BP	BPP
Citco	SD	CB	P	C5

TECH TIP

- Truing makes the wheel concentric with the spindle
- Dressing opens the wheel's cutting face
- Always true and dress diamond and cBN wheels prior to use
- Diamond and cBN wheels with grit sizes 100 – 180 can be trued with a Brake Controlled Truing Device
- Refer to the "Mounting, Truing and Dressing Guide" for more information



It is the user's responsibility to refer to and comply with ANSI B7.1

TECH TIP

Diamond Grinds:

In general, diamond is used to grind non-ferrous materials, because of an adverse reaction between diamond and iron.

- Cemented carbide
- Glass
- Ceramics
- Fiberglass
- Plastics
- Stone
- Abrasives
- Electronic components and materials

cBN Grinds:

cBN is used to grind ferrous materials.

- High-speed tool steels
- Die steels
- Hardened carbon steels
- Alloy steels
- Aerospace alloys
- Hardened stainless steel
- Abrasion-resistant ferrous materials



It is the user's responsibility to refer to and comply with ANSI B7.1



B99 Express Service

The B99 Express service is designed to offer you up to 65,000 made-to-order choices of resin bond Diamond and cBN wheels. Almost all popular sizes are offered.

12" and less diameter B99 Express wheels will ship in two weeks or less from the date the order is received. 14" and larger wheels are available at standard lead-times.

Our Norton Winter line offers a comprehensive stock product selection to service most of your needs – with the fastest delivery and lowest total costs.

Review this stock section first. If you can not find the specification you need:

- Then refer to the brief descriptions of our B99 Express and CNC lines (following this section)

Type DW

- D - Diameter
- T - Thickness
- Y - Spindle Diameter
- SP - Spindle Length

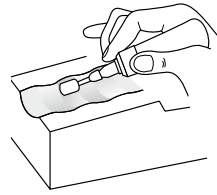
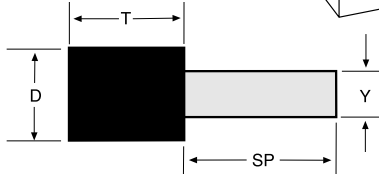

Type HH1

- L - Length
- L1 - Length of Abrasive
- X - Abrasive Depth
- W - Width
- T - Thickness (Back)

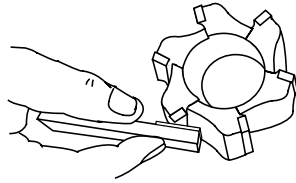
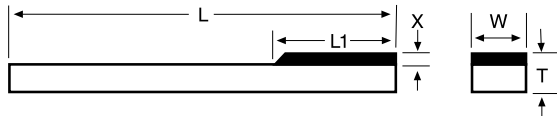

Type HH2

- L - Length
- L1 - Length of Abrasive
- X - Abrasive Depth
- W - Width
- T - Thickness (Back)

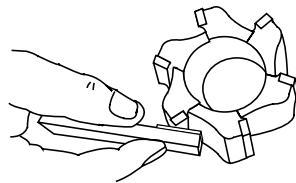
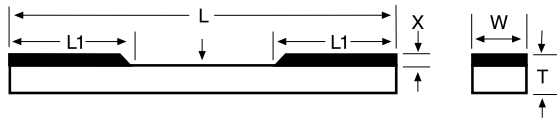

Type 1A1

- D - Diameter
- X - Abrasive Depth
- H - Hole
- T - Thickness

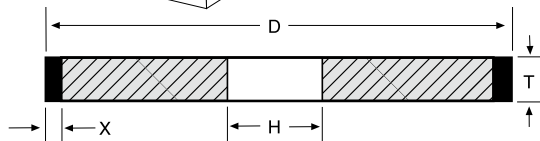
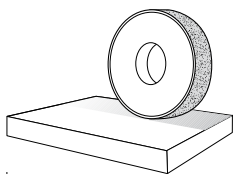

Type 1A1R

- D - Diameter
- X - Abrasive Depth
- H - Hole
- E - Back Thickness
- T - Thickness

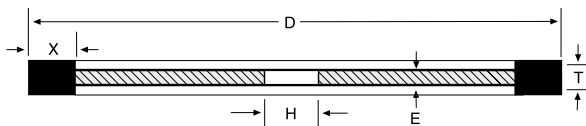
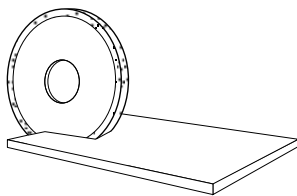

SIZE (D x T)	SPECIFICATION	PART #
Type DW Mounted Points - Diamond		
3/16 x 1/4	SD100-R100B99-SOLID	690141 92238
Steel Spindle 1/8 x 1-1/2		
1/2 x 1/2	SD220-R100B99-SOLID	690141 92249
Steel Spindle 1/4 x 1-1/2		
3/4 x 3/8	SD150-R100B99-SOLID	690141 92251
Steel Spindle 1/4 x 1-1/2		
1 x 1/2	SD100-R100B99-SOLID	690141 92428
Steel Spindle 1/4 x 1-1/2		
Type DW Mounted Points - cBN		
3/16 x 1/4	CB150-WB99-SOLID	690141 92258
Carbide Spindle .125 x 1-3/4		
SIZE (T x W x L)	SPECIFICATION	PART #
Type HH1 Hand Hones - Diamond		
1/4 x 1/4 x 6	ASD220-R100B99-1/16	690141 92139
One 1/16 deep 1" long insert in one 1/4 surface		
1/4 x 3/8 x 4	ASD100-R100B99-1/16	690141 92141
One 1/16 deep 1" long insert in one 3/8 surface	ASD180-R100B99-1/16	690141 92142
	ASD220-R100B99-1/16	690141 91670
	ASD320-R100B99-1/16	690141 91672
	ASD400-R100B99-1/16	690141 92143
	D10/20MIC-R100B99-1/16	690141 92144
	SD320-100V99-1/16	690141 92140
Type HH2 Hand Hones - Diamond		
1/4 x 3/8 x 4	ASD120/220-R100B99-1/16	690141 92150
Two 1/16 deep 1" long inserts in one 3/8 surface	ASD220/320-R100B99-1/16	690141 92178
	ASD220/400-R100B99-1/16	690141 92179
	ASD320/400-R100B99-1/16	690141 92180
	SD220/320-100V99-1/16	690141 92149
SIZE (D x T x H)	SPECIFICATION	PART #
Type 1A1 Straight - Diamond		
1 x 1/4 x 1/4	SD100-R100B99-1/8	690141 92175
1-1/2 x 1/2 x 1/2	D6/12MIC-N100B99-1/8	690141 92176
2 x 1/8 x 1/4	SD100-R100B99-1/8	690141 92184
3 x 1/4 x 3/4	SD180-N100B99-1/8	690141 92187
4 x .020 x 1-1/4	SD320-R100B99-1/8	690141 92188
4 x 1/32 x 1-1/4	SD100S-R100B99-1/4	690141 92192
4 x 1/16 x 1-1/4	SD100S-R100B99-1/4	662602 73583
	SD150-R100B99-1/4	662602 73584
	SD220-R100B99-1/4	662602 73586
4 x 1/8 x 3/4	SD150-R100B99-1/4	690141 92024
4 x 1/8 x 1-1/4	SD150-R100B99-1/4	690141 91677
4 x 1/4 x 1/2	SD150-R100B99-1/4	662602 73590
4 x 1/4 x 3/4	SD150-R100B99-1/4	662602 73592
4 x 1/4 x 1-1/4	SD100S-R100B99-1/4	662602 73587
	SD120-R100B99-1/4	662602 73588
	SD150-R100B99-1/4	662602 73589
4 x 1/2 x 1-1/4	SD150-R100B99-1/4	662602 73594
6 x 1/32 x 1-1/4	SD220-R100B99-1/8	690141 92197
6 x 1/16 x 1-1/4	SD100-R100B99-1/4	662602 73596
	SD150-R100B99-1/4	662602 73597
	SD180-R100B99-1/4	662602 73598
	SD220-R100B99-1/4	662602 73599
6 x 1/8 x 1-1/4	ASD150-R75B99-1/4	662602 73617
	SD100-R100B99-1/4	662602 73611
	SD150-R100B99-1/4	662602 73613
	SD180-R100B99-1/4	662602 73614
	SD220-R100B99-1/4	662602 73615
6 x 1/4 x 1-1/4	ASD100S-R75B99-1/4	690141 92205
	ASD120-R75B99-1/4	690141 92769
	ASD150-R75B99-1/4	662602 73609
	ASD180-R75B99-1/4	690141 92770
	ASD220-R75B99-1/4	690141 92771
	ASD320-R75B99-1/4	690141 92772
	RMD180-P100V99-1/8	690141 92203
	SD120-R100B99-1/4	690141 91691
	SD150-R100B99-1/4	690141 91692
	SD180-R100B99-1/4	690141 91693
	SD220-R100B99-1/4	690141 92764

Standard Package = 1 mounted point, hand hone, or wheel
Continued

SIZE (D x T x H)	SPECIFICATION	PART #
Type 1A1 Straight – Diamond continued		
6 x 3/8 x 1-1/4	ASD120-R75B99-1/4	690141 92773
	ASD150-R75B99-1/4	690141 91695
	SD150-R100B99-1/4	690141 91696
6 x 1/2 x 1-1/4	ASD120-R75B99-1/4	690141 92777
	ASD150-R75B99-1/4	690141 91698
	ASD220-R75B99-1/4	690141 92779
	ASD320-R75B99-1/4	690141 92780
	SD120-R100B99-1/4	662602 73557
	SD150-R100B99-1/4	662602 73561
7 x 1/4 x 1-1/4	SD180-R100B99-1/4	690141 91700
	ASD150-R75B99-1/4	690141 91701
	SD100S-R100B99-1/4	690141 92210
	SD120-R100B99-1/4	662602 73566
	SD150-R100B99-1/4	690141 91703
	SD180-R100B99-1/4	690141 91704
7 x 3/8 x 1-1/4	SD220-R100B99-1/4	690141 91705
	SD120-R100B99-1/4	690141 91849
	SD220-R100B99-1/4	690141 91852
7 x 1/2 x 1-1/4	ASD100-R75B99-1/4	690141 92211
	ASD150-R75B99-1/4	690141 91853
	ASD180-R75B99-1/4	690141 92212
	SD120-R100B99-1/4	690141 91854
	SD150-R100B99-1/4	690141 91855
	SD180-R100B99-1/4	690141 91856
8 x 1/2 x 1-1/4	SD220-R100B99-1/4	690141 91857
	SD150-R100B99-1/4	662602 73574
	SD120-R75B99-1/4	690141 92305
10 x 1/2 x 3	ASD180-R100B99-1/4	690141 92306
	ASD150-R75B99-1/4	690141 92310
	ASD120-R75B99-1/4	690141 92311
12 x 1/2 x 3	ASD120-R75B99-1/4	690141 92312
12 x 1 x 3	ASD120-R75B99-1/4	690141 92313
12 x 1 x 5	ASD120-R75B99-1/4	690141 92313
14 x 1/2 x 5	ASD150-R75B99-1/4	690141 92314
14 x 1 x 5	ASD120-R75B99-1/4	690141 92316
20 x 1 x 12	ASD120-R75B99-1/4	690141 92325

Standard Package = 1 wheel

SIZE (D x T x H)	SPECIFICATION	PART #
Type 1A1 Straight – cBN		
6 x 1/8 x 1-1/4	CB120-TB99-1/4	662602 73601
6 x 1/4 x 1-1/4	CB120-TB99-1/4	662602 73605
6 x 1/2 x 1-1/4	CB120-TB99-1/4	662602 73607
7 x 1/4 x 1-1/4	CB120-TB99-1/4	690141 92021
7 x 1/2 x 1-1/4	CB120-TB99-1/4	662602 73567
12 x 1/2 x 5	CB150-TB99-1/4	662602 73560
12 x 1 x 5	CB150-TB99-1/4	662602 73562
Type 1A1R Cut-Off – Diamond		
3 x .020 x 1/2 (ME104177)	M4D150-N50M99-1/8	690141 92060
4 x .012 x 1/2 (ME104180)	M4D180-N75M99-1/8	690141 92063
4 x .020 x 1/2 (ME104180)	M4D220-N75M99-1/8	690141 92064
4 x .030 x 1/2 (ME104180)	M4D220-N100M99-1/8	690141 92067
4 x .030 x 1/2 (ME104180)	M4D150-N75M99-1/8	690141 92068
4 x 1/32 x 3/4 (ME43570)	SD100S-R100B99-1/4	690141 92151
4 x 1/32 x 1-1/4 (ME43570)	SD120-R100B99-1/4	690141 91706
5 x .015 x 1/2 (ME104180)	SD100S-R100B99-1/4	690141 92152
6 x .017 x 1-1/4 (ME104180)	M4D220-N100M99-1/8	690141 92070
6 x .025 x 1-1/4 (ME104180)	M4D150-N100M99-1/8	690141 92082
6 x .035 x 5/8 (ME104177)	M4D220-N100M99-1/8	690141 92083
6 x .035 x 1-1/4 (ME43572)	M4D150-N100M99-1/8	690141 92086
	SD100-R75B99-1/4	690141 92155
	ASD100S-R100B99-1/4	690141 92158
	ASD120-R100B99-1/4	690141 92159
	SD100-R100B99-1/4	690141 91858
	SD100S-R100B99-1/4	690141 92156
	SD220-R100B99-1/4	690141 92157

Continued

TECH TIP

Cylindrical Grinding Applications – 1A1 wheels:

- Includes all outside grinding of round parts, even though the finished product is not always a true cylinder
- Infeed at both ends of the traverse to keep wheel face flat
- Use work supports to prevent deflection
- Rough grinding traverse speed should be 1/2 to 2/3 of the thickness of the wheel per work revolution
- Finishing grinding traverse speed should be 1/2" or less per work revolution

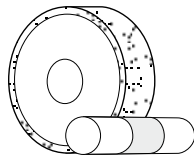

It is the user's responsibility to refer to and comply with ANSI B7.1

TECH TIP

Cut-off Applications – 1A1R wheels:

- Use the largest diameter flanges possible
- Use flanges of equal diameter
- Use the thickest wheel possible for increased stiffness and straightness of cut

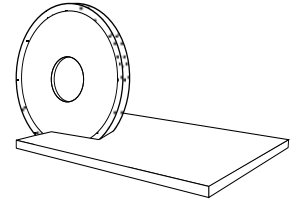

cBN wheels are used on hardened steels.

Diamond wheels are used to cut or slot carbide, glass or ceramic parts.



It is the user's responsibility to refer to and comply with ANSI B7.1

TECH TIP

Diamond Grinds:

- Cemented carbide
- Glass
- Ceramics
- Fiberglass
- Plastics
- Stone
- Abrasives
- Electronic components and materials

cBN Grinds:

- High-speed tool steels
- Die steels
- Hardened carbon steels
- Alloy steels
- Aerospace alloys
- Hard stainless steel
- Abrasion-resistant ferrous materials

Can't Find Your Specification Here?

Review this stock section first. If you can not find the specification you need:

- Then refer to the brief descriptions of our B99 Express and CNC lines (following this section)

SIZE (D x T x H)	SPECIFICATION	PART #
Type 1A1R Cut-Off – Diamond		
6 x .035 x 1-1/4 (ME73316)	ASD100S-R100B99-9/32	690141 92164
	ASD120-R100B99-9/32	690141 92165
	SD100-R100B99-9/32	690141 92161
	SD120-R100B99-9/32	690141 92162
	SD150-R100B99-9/32	690141 92163
	SD100-R50B99-1/8	690141 92166
6 x .045 x 1-1/4 (ME83991)		
6 x .055 x 1-1/4 (ME104177)	M4D100-N75M99-1/8	690141 92099
7 x .035 x 1-1/4 (ME82347)	ASD100-R100B99-1/4	662602 38686
7 x .055 x 1-1/4 (ME104177)	M4D120-N100M99-1/8	690141 92108
8 x .030 x 1-1/4 (ME104180)	M4D180-N75M99-1/8	690141 92110
8 x .045 x 5/8 (ME43569)	SD120-R100B99-1/4	690141 92167
8 x .045 x 1-1/4 (ME43569)	SD120-R100B99-1/4	690141 92169
8 x .050 x 1-1/4 (ME104180)	M4D180-N75M99-1/8	690141 92114
10 x .050 x 1-1/4 (ME 43565)	ASD120-R100B99-1/4	662602 30236
	CD100-R100B99-1/4	690141 92815
	SD120-R100B99-1/4	690141 92170
12 x .070 x 3/4 (ME 43567)	SD150-R100B99-1/4	690141 92173
Type 1A1R Cut-off – cBN		
6 x .035 x 1-1/4 (ME43572)	CB100-WB99-1/4	690141 92160
Type 1V1P Fluting – Diamond		
6 x 3/32 x 1-1/4	ASDC320C-R100B99-1/4	690141 92761
Face Bevel 1 Side 20 Deg Copper Core (ME89562)	ASD320B-R125B99-1/4	690141 92302
Type 4A2P Dish – Diamond		
6 x 3/8 x 1-1/4 Rim Width 1/4" (ME88369)	ASD120-R75B99-1/16	690141 92280

Standard Package = 1 wheel

Refer to “Brake Controlled Truing Devices” and “Dressing Sticks” in the Dressing Solutions section for truing and dressing products.

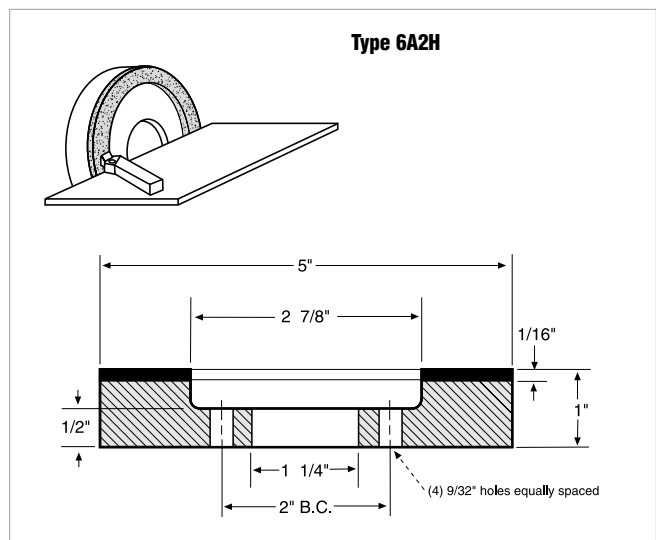
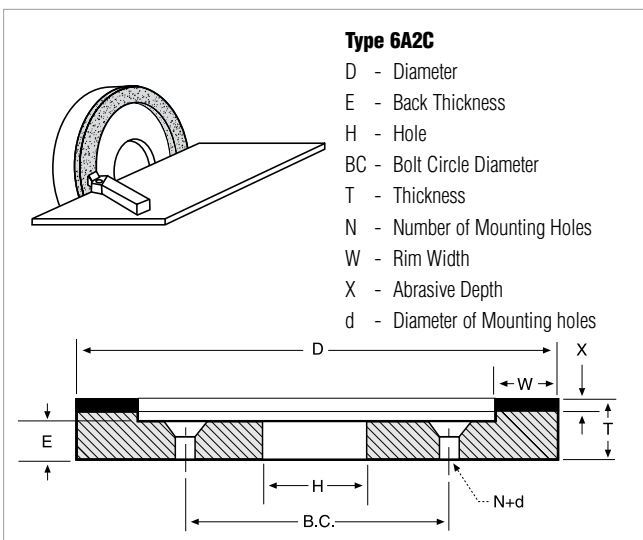
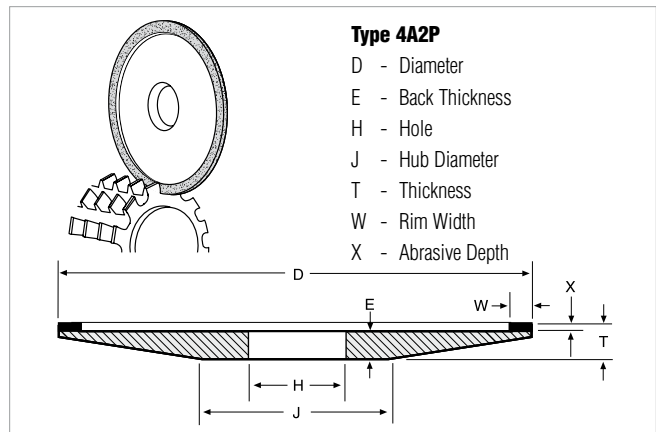
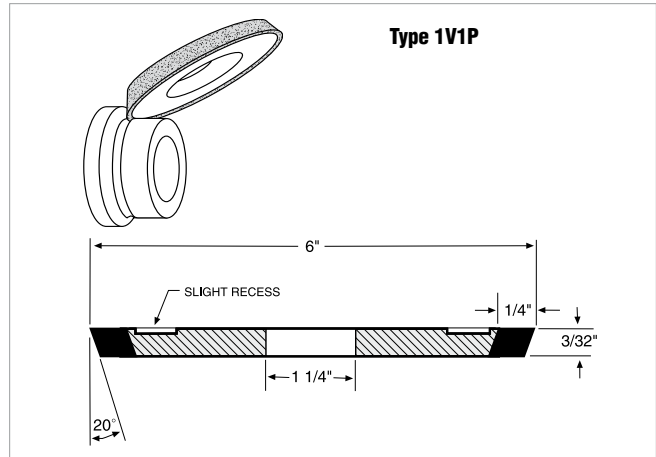
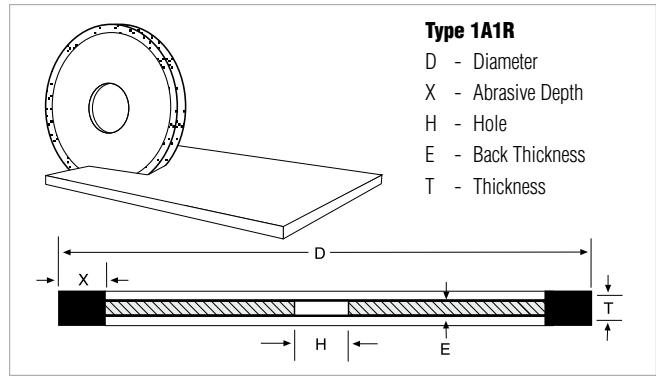

SIZE (D x T x H)	SPECIFICATION	PART #
Type 6A2C Straight cup – Diamond		
6 x 7/16 x 1-1/4 Rim Width 1" (0640185M)	D120/140-H-MSL	662602 69172
6 x 3/4 x 1-1/4 Rim Width 3/4" (ME27853)	SD220-R50B99-1/16	690141 91665
	ASD120-R75B99-1/16	690141 91860
	ASD120-R75B99-1/8	690141 92786
	SD150-P50V99-1/16	690141 92217
	SD220-P50V99-1/8	690141 91623
6 x 3/4 x 1-1/4 Rim Width 1/2" (ME30621)	ASD120-R75B99-1/8	662602 73565

Standard Package = 1 wheel

SIZE (D x T x H)	SPECIFICATION	PART #
Type 6A2H Straight Cup – Diamond		
5 x 1 x 1-1/4 Rim Width 1-1/16" (ME27084)	SD320-R50B99-1/16	690141 92221

Standard Package = 1 wheel

Best choice for dry grinding carbide tools

ASD DIAMOND / B105 RESIN BOND WHEELS

- Premium quality diamond produces keen cutting tools that hold their shape, are easier to sharpen, and require fewer reconditionings
- Advanced, self lubricating bond minimizes heat generation and thermal damage to tool for increases tool life and productivity; lasts more than 2X as long as standard diamond wheels for lowest total wheel costs and highest productivity
- Unique self-dressing core eliminates wheel core damage and downtime to dress core

TIER: **BEST**
BOND: **B105**

SIZE (D x T x H)	SPECIFICATION	PART #
Type 11V9 Flaring Cup – Diamond		
3-3/4 x 1-1/2 x 1-1/4 Insert Length 3/8" (ME92192)	ASD120-R75B105-1/16	690141 91905
	ASD150-R75B105-1/16	690141 91906
	ASD100S-R75B105-1/8	690141 91908
	ASD120-R75B105-1/8	690141 91909
	ASD150-R75B105-1/8	690141 91910
5 x 1-3/4 x 1-1/4 Insert Length 7/16" (ME98298)	ASD120-R75B105-1/16	690141 91913
	ASD150-R75B105-1/16	690141 91914
	ASD100S-R75B105-1/8	690141 91916
	ASD150-R75B105-1/8	690141 91918

TIER: **BETTER**
BOND: **B99**

SIZE (D x T x H)	SPECIFICATION	PART #
Type 11V9 Flaring Cup – Diamond		
3 x 1-1/4 x 3/4 Insert Length 3/8" (ME93912)	ASD120-R75B99-1/16	690141 92291
	ASD150-R75B99-1/16	690141 92292
	SD150-R100B99-1/16	690141 92293
3-3/4 x 1-1/2 x 3/4 Insert Length 3/8" (M92192)	ASD120-R75B99-1/16	690141 92022
3-3/4 x 1-1/2 x 1-1/4 Insert Length 3/8" (ME92192)	ASD150C-R50B99-1/8	690141 90751
	ASD120-R75B99-1/16	690141 91660
	ASD150-R75B99-1/16	690141 91725
	ASD100S-R75B99-1/8	690141 91653
	ASD120-R75B99-1/8	690141 91652
	ASD150-R75B99-1/8	690141 91651
	ASD180-R75B99-1/8	690141 91650
	SD120-R100B99-1/16	690141 91657
	SD150-R100B99-1/16	690141 91656
	SD220-R100B99-1/16	690141 91654
	SD320-R100B99-1/16	690141 92814
	SD100S-R100B99-1/8	690141 92427
	SD120-R100B99-1/8	690141 91649
	SD150-R100B99-1/8	690141 91648
	SD180-R100B99-1/8	690141 91647
	SD220-R100B99-1/8	690141 91646
5 x 1-3/4 x 1-1/4 Insert Length 7/16" (ME98298)	ASD100S-R75B99-1/16	690141 91645
	ASD120-R75B99-1/16	690141 91644
	ASD150-R75B99-1/16	690141 91643
	ASD100S-R75B99-1/8	690141 91637
	ASD120-R75B99-1/8	690141 91636
	ASD150-R75B99-1/8	690141 91635
	ASD180-R75B99-1/8	690141 91634
	SD120-R100B99-1/16	690141 91641
	SD150-R100B99-1/16	690141 91640
	SD220-R100B99-1/16	690141 91638
	SD150-R100B99-1/8	690141 91632
	SD180-R100B99-1/8	690141 91631

Standard Package = 1 Wheel

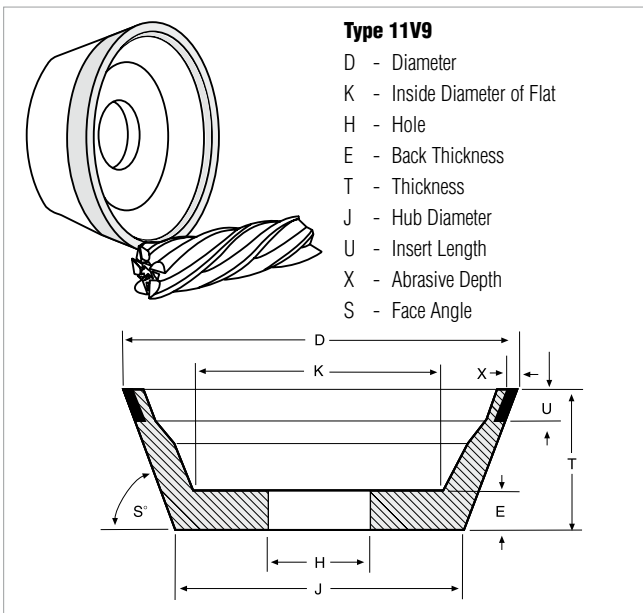

Best choice for dry tool sharpening

AZTEC cBN WHEELS

- Consistent, high quality cBN (cubic Boron Nitride) abrasive which offers 85% longer life than standard cBN wheels
- Advanced heat-reducing bond conducts heat away from the workpiece for freer cutting action and extended wheel life; helps maintains cutting tool steel integrity and extends tool life
- AZTEC III lubricating bond eliminates steel braze and loading; AZTEC .007 allows increased infeed (start at .007) for high stock removal

TIER: BEST		
BOND: AZTEC		
SIZE (D x T x H)	SPECIFICATION	PART #
Type 11V9 Flaring Cup – cBN		
3-3/4 x 1-1/2 x 1-1/4 Insert Length 3/8" (ME92192)	AZTEC .007-100-1/16	690141 95683
	AZTEC .007-150-1/16	690141 95679
	AZTEC III 100T-1/16	690141 91832
	AZTEC III 120T-1/16	690141 91833
	AZTEC III 150T-1/16	690141 91834
	AZTEC III 100T-1/8	690141 91838
	AZTEC III 120T-1/8	690141 91839
5 x 1-3/4 x 1-1/4 Insert Length 7/16" (ME98298)	AZTEC .007-100-1/16	690141 95685
	AZTEC III 100T-1/16	690141 91841
	AZTEC III 120T-1/16	690141 91842
	AZTEC III 150T-1/16	690141 91843
	AZTEC .007-100-1/8	690141 95686
	AZTEC .007-150-1/8	690141 95682
	AZTEC III 100T-1/8	690141 91844

Standard Package = 1 Wheel

TIER: BETTER		
BOND: B99		
SIZE (D x T x H)	SPECIFICATION	PART #
Type 11V9 Flaring Cup – cBN		
3-3/4 x 1-1/2 x 1-1/4 Insert Length 3/8" (ME92192)	CB100-TB99-1/16	690141 91719
	CB100-TB99-1/8	690141 91722
	CB120-TB99-1/8	690141 91723
	CB150-TB99-1/8	690141 91724
	CB120-WB99-1/16	690141 91720
5 x 1-3/4 x 1-1/4 Insert Length 7/16" (ME98298)	CB120-TB99-1/8	690141 91715
	CB150-TB99-1/8	690141 91716

Standard Package – 1 Wheel

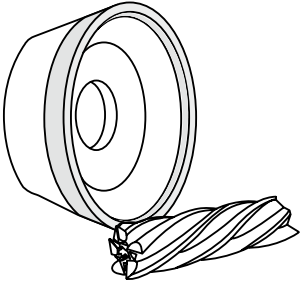

Type 11V9

D - Diameter
K - Inside Diameter of Flat
H - Hole
E - Back Thickness
T - Thickness
J - Hub Diameter
U - Insert Length
X - Abrasive Depth
S - Face Angle

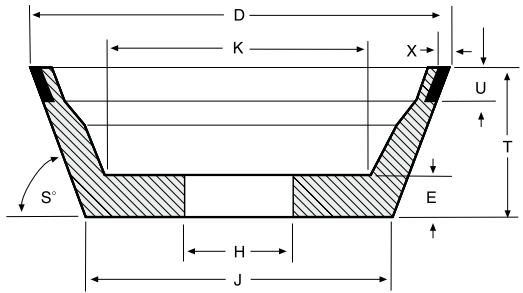

Refer to “Brake Controlled Truing Devices” and “Dressing Sticks” in the Dressing Solutions section for truing and dressing products.

TIER: **BETTER**
BOND: **B99**

SIZE (D x T x H)	SPECIFICATION	PART #
Type 12A2 Dish – Diamond		
4 x 1/2 x 1-1/4 Rim Width 1/4" (ME40745)	SD180-R75B99-1/8	690141 92223
6 x 1 x 1-1/4 Rim Width 3/16" (ME27758)	ASD120-R75B99-1/8 ASD180-R75B99-1/8	690141 91630 690141 92226
Type 12A2 Dish – cBN		
6 x 1 x 1-1/4 Rim Width 3/16" (ME27758)	CB120-TB99-1/16	690141 92227
Type 12V9 Dish – Diamond		
3 x 7/16 x 3/4 Insert Length 7/16" (ME41755)	SD150-R100B99-1/16	690141 92228
4 x 1/2 x 1-1/4 Insert Length 1/4" (ME58734)	SD180-R100B99-1/8	690141 91629
6 x 3/4 x 1-1/4 Insert Length 3/8" (ME48666)	ASD150-R75B99-1/16	690141 91628
Type 12V9 Dish – cBN		
4 x 1/2 x 1-1/4 Insert Length 1/4" (ME58734)	CB120-TB99-1/8	690141 92229
6 x 3/4 x 1-1/4 Insert Length 3/8" (ME48666)	CB120-TB99-1/8 CB150-TB99-1/8	690141 92020 690141 92784
Type 15V9 Dish – Diamond		
6 x 3/4 x 1-1/4 Insert Length 3/8"	SD150-R100B99-1/16	690141 92230

Standard Package = 1 wheel

Can't Find Your Specification Here?

We offer a comprehensive stock product selection to service most of your needs

– with the fastest delivery and lowest total cost.

Review this stock section first. If you can not find the specification you need:

- Then refer to the brief descriptions of our B99 Express and CNC lines (following this section)

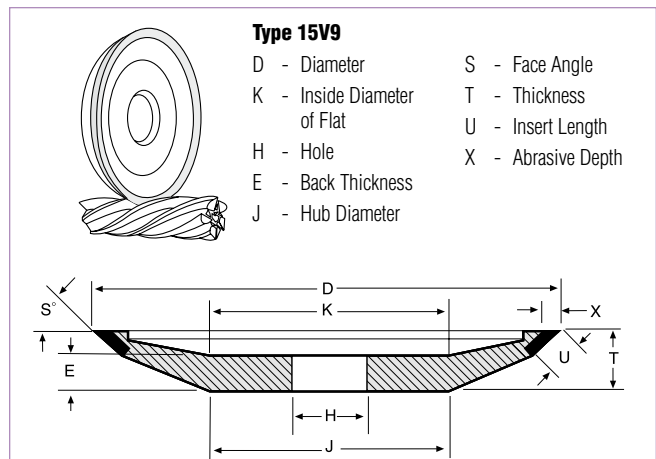
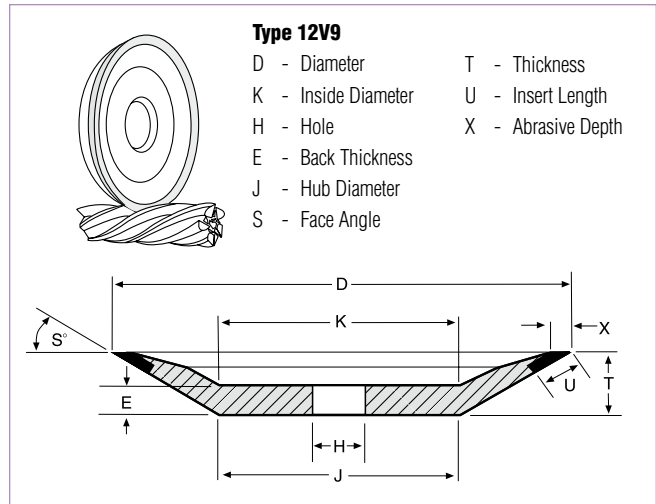
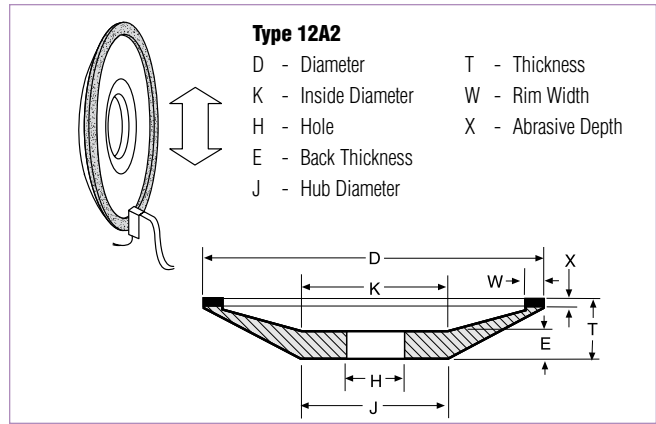

B99 Express Resin Bond Wheels



65,000+ made-to-order resin products; 25 wheel shapes, with one- and two-week lead-times for 12" and less diameter wheels. 14" and larger wheels and 80 grit and coarser wheels are available with standard made-to-order lead-times. If you do not find the resin specification and/or shape you need in our stock offering, you will most likely find it in our B99 Express made-to-order offering.

Applications:

- B99E Diamond Wheels
 - Sharpening cemented carbide cutting tools
 - Cutting-off carbide rod
 - Grinding or cutting-off non-metallic materials such as ceramics or glass
 - Surface grinding dies
 - O.D. grinding spray coatings
- B99E cBN Wheels
 - Sharpening high-speed (M2, D2, T15, etc.) steel cutting tools
 - Surface and ID grinding hardened steel die components
 - Precision grinding steel parts Rc 50 or harder

Superior performing diamond and cBN wheels custom made to your requirements

B99 EXPRESS MADE-TO-ORDER DIAMOND AND cBN RESIN BOND WHEELS

- Superior diamond or cBN abrasives with durable resin bond systems
- With thousands of abrasive, grit, grade, concentration, and bond combinations there is a B99 Express wheel for almost every resin bond application
- Offering exceptional quality and performance, these wheels are made in our state-of-the-art, USA, ISO-certified facilities; excellent performance/price ratio with convenient two-week (or less) lead-times

How to Select B99 Express Made-to-Order Diamond Wheels

SELECT:

WHEEL SHAPE	Select desired wheel shape		
WHEEL DIMENSIONS		D x T x H	Select Diameter x Thickness x Hole from the availability tables in Catalog #8068. Use blueprint numbers where available.
ABRASIVE	Select the abrasive based on horsepower, grinding wet or dry, and contact with steel.	ASD	Armored diamond; most durable. Versatile: can be used wet or dry. ASD should be used when carbide and steel are ground in the same operation.
		SD	Free cutting standard. Can be used wet or dry; should be used on low horsepower (3/4 hp or less) machines.
GRIT SIZE	Select the grit size based on finish and material removal rate required. Note: Standard made-to-order lead-times apply to 80 grit and coarser wheels.	80	Roughing
		100	Roughing. The most common grit size for roughing operations.
		120	For roughing where 100 is too coarse. Also for cut-off applications.
		150	Medium stock removal plus good finish. For combined roughing and finishing applications.
		180	Medium stock removal plus good finish. To improve finish.
		220	Finishing
		320	Finishing
GRADE	The hardness of the wheel	R	Resin bond standard
		CONCENTRATION	Select the concentration based on grinding wet or dry, material removal rates, and form holding requirements.
		50	Shape 2A2T only. For broad area of contact grinding.
		75	Norton standard. Freer cutting than 100 grit and the most economical for dry grinding with ASD diamond.
BOND	Select the bond based on the material being ground and grinding application.	100	Very durable. Recommended under flood coolant conditions. For use with 220 grit or finer, when durability is required. Also for cut-off applications.
		125	Improved form holding. Used with B99EF bond only for form holding in high-volume, high-pressure coolant applications. Used with ASD abrasive.
		B99E	Norton standard pre-engineered resin bond. Versatile enough to be used wet or dry on most tool making or resharpening applications as well as for grinding non-metallic materials such as ceramics or glass. Available in all shapes.
ABRASIVE DEPTH	Usable abrasive	B99EF	Improved form holding. More durable than B99E. Improved heat dissipation in wet or dry applications. Available in wheel shapes 1V1, 1B1, 1E1, 1EE1, 1F1 and 1FF1.
		1/16	
		1/8	
		1/4	
		1/2	

How to Select B99 Express Made-to-Order cBN Wheels

SELECT:			
WHEEL SHAPE	Select desired wheel shape		
WHEEL DIMENSIONS	Note: Standard made-to-order lead-times apply to 14" and larger wheels.	D x T x H	Select Diameter x Thickness x Hole from the availability tables. Use blueprint numbers where available.
ABRASIVE	Select cBN abrasive to grind hard tool steels such as A2, D2, T15, etc., and tough alloy steels.	CB	Norton standard coated cBN (cubic Boron Nitride). Optimized for high performance in resin bond systems.
GRIT SIZE	Select the grit size based on finish and material removal rate required. Note: Standard made-to-order lead-times apply to 80 grit and coarser wheels.	100	Roughing. The most common grit size for roughing operations.
		120	For roughing where 100 is too coarse. Also for cut-off applications.
		150	Medium stock removal plus good finish. For combined roughing and finishing applications.
		180	Medium stock removal plus good finish. To improve finish.
		220	Finishing
		320	Finishing
GRADE	The hardness of the wheel	T	Norton standard. Approximately 75 concentration, T is the first choice for lower horsepower equipment or wide area of contact between the wheel and the workpiece. Ideal for resharpening applications with 11V9, 12A2, 4A2P, and 15V9 wheel shapes when dry grinding.
		W	Very durable. Approximately 100 concentration, W is recommended for high volume coolant operations: flute grinding from solid, flute polishing, surface, and cylindrical grinding.
		Z	Form holding. Approximately 125 concentration, Z grade is extremely durable and is recommended where long life or form holding is required in high-volume, high-pressure coolant applications. Used with B99EF bond only.
BOND	Select the bond depending on the type of grinding application.	B99E	Norton standard resin bond. Pre-engineered for optimal performance with cBN abrasive. Available in all shapes.
		B99EF	Improved form holding. More durable than B99E. Improved heat dissipation in wet or dry applications. Available in wheel shapes 1V1, 1B1, 1E1, 1EE1, 1F1 and 1FF1.
ABRASIVE DEPTH	Usable abrasive	1/16	
		1/8	
		1/4	
		1/2	

TECH TIP

Diamond Grinds:

In general, diamond is used to grind non-ferrous materials, because of an adverse reaction between diamond and iron.

- Cemented carbide
- Glass
- Ceramics
- Fiberglass
- Plastics
- Stone
- Abrasives
- Electronic components and materials

cBN Grinds:

cBN is used to grind ferrous materials.

- High-speed tool steels
- Die steels
- Hardened carbon steels
- Alloy steels
- Aerospace alloys
- Hardened stainless steel
- Abrasion-resistant ferrous materials



It is the user's responsibility to refer to and comply with ANSI B7.1



These superior, pre-engineered wheels have been specifically developed to meet the demanding needs of precision cutting tool manufactures as well as re-sharpeners. The use of the highest quality diamond and cBN abrasives matched to superior high temperature bond systems, guarantees high performing wheels. These wheels are manufactured under the strictest quality control protocols ensuring the same, consistent, high-performing product. Cutting tool manufactures who use these wheels report much improved dimensional accuracy and superior cutting edges.

This product offering provides wheel sizes for most CNC machines and wheels shapes to produce the required cutting tool geometries. If you do not find a wheel in this offering to suit your specific needs, a custom-made wheel can be provided.

Applications: CNC cutting tool manufacturing and resharpening: fluting, end fluting, gashing, and OD relief

Diamond CNC Wheels

Best choice for CNC tungsten carbide round tool manufacturing



PARADIGM DIAMOND WHEELS

- Truable online and offline for maximum productivity
- Wear and load resistance deliver superior grinding performance on tough-to-grind carbides with 6-12% cobalt content
- High grain retention and uniform structure generate high G-ratio; up to 2.5 times longer life and 30% higher MRR than existing superabrasive wheels

Better choice for CNC tungsten carbide round tool manufacturing



G-FORCE AND UNIVEL POLYIMIDE DIAMOND WHEELS

- Polyimide bond systems provide superior form-holding and lower-power requirements compared to premium competitive wheels, reducing frequency of dresses, and decreasing chances of burn and heat damage to the part
- Unique bond technology excels on round, carbide and steel tools; excellent depth of cut, traverse rates, and form holding; reduces total grinding costs by 30% or more
- Self-dressing; maintains a consistently sharp grinding edge which allows for lights-out manufacturing

Good choice for short runs and frequent geometry changes



DIAMOND CNC WHEELS

- A price competitive alternative to premium wheels; ideal for short-run manufacturing jobs where frequent wheel profile changes are required
- Consistent wheel-to-wheel performance for reduced cycle times, less dressing = longer wheel life
- Ideal for resharpening and short-run manufacturing operations; competitively-priced while providing good performance

Diamond CNC Wheels

TIER: BEST				BETTER				GOOD			
TRADENAME: PARADIGM				G-FORCE/UNIVEL				NORTON WINTER			
SIZE (D x T x H) U, W	ANGLE V	SPECIFICATION	ABR. DEPTH X	PART #	SPECIFICATION	ABR. DEPTH X	PART #	SPECIFICATION	ABR. DEPTH X	PART #	
TYPE 1A1 – Diamond Flute											
4 x 1/2 x 1-1/4		SD320-D168-P100C	3/8	079587 83055 NS	AD320-UP061 G-Force	1/4	601576 63909				
5 x 3/8 x 1-1/4		SD320-D168-P100C	1/2	079587 83058 NS	AD320-UP061 G-Force	1/2	601576 68409	A4D220-R115B610	1/2	690141 18255	
5 x 1/2 x 1-1/4		SD320-C176-P100C	1/2	079587 83061	AD320-UP061 G-Force	1/2	601576 62240	A4D180-R115B610	1/2	690141 18202	
5 x 5/8 x 1-1/4		SD320-C176-P100C	1/2	079587 83063 NS	AD320-UP061 G-Force	1/2	601576 63486 NS	A4D180-R115B610	1/2	690141 18203 NS	
6 x 1/2 x 1-1/4		SD320-C176-P100C	1/2	079587 83064	AD320-UP061 G-Force	1/4	601576 82133 NS	A4D180-R115B610	1/4	690141 18216 NS	
TYPE 1A1 – Diamond Polish											
5 x 1/2 x 1-1/4					80D1000-100UP731 Univel	1/2	079587 84316 NS				
TYPE 1A1 – Diamond Relief											
6 x 1/2 x 1-1/4		SD320-E168-P100C	1/2	079587 83073 NS	AD320-UP892 G-Force	1/2	690141 17684 NS	A4D180-R115B610	1/2	690141 18217 NS	
TYPE 1A1RN – Diamond Flute											
5 x 3/8 x 1-1/4		SD320-D168-P100C	1/2	079587 83067 NS	AD320-UP061 G-Force	1/2	601576 63501	A4D180-R115B610	1/2	690141 18201	
5 x 1/2 x 1-1/4					AD220-UP061 G-Force	1/2	662603 22280				
5 x 5/8 x 1-1/4					AD220-UP061 G-Force	1/2	601576 64141				
TYPE 1B1 – Diamond Flute											
4 x 3/8 x 1-1/4	V=20°	SD320-D168-P100C	3/8	079587 83054							
TYPE 1B1 – Diamond Flute/Gash											
5 x 3/8 x 1-1/4	V=45°	SD320-E168-P100C	1/2	079587 83065							
TYPE 1B1 – Diamond Gash											
5 x 1/2 x 1-1/4	V=45°	SD320-E168-P100C	1/4	079587 83062 NS							
5 x 1/2 x 1-1/4	V=60°	SD320-E168-P100C	1/4	079587 83060 NS							
5 x 1/2 x 1-1/4	V=30°	SD320-E168-P100C	3/4	079587 83070 NS				A4D320-R115B610	3/4	690141 18207	
								D220-C100-K+925	6mm	601576 13112	
5 x 1/2 x 1-1/4	V=45°	SD320-E168-P100C	3/4	079587 83068 NS	AD320-UP531 G-Force	3/4	662603 29603	A4D320-R115B610	3/4	690141 18208	
								D220-C100-K+925	6mm	601576 23673	
TYPE 1V1 – Diamond Flute											
4 x 3/8 x 1-1/4	V=20°				AD320-UP061 G-Force	1/4	662603 16591	A4D180-R115B610	1/4	690141 18263	
5 x 1/2 x 1-1/4	V=10°	SD320-C176-P100C	1/2	079587 83071 NS	AD320-UP061 G-Force	1/2	662601 16723	A4D180-R115B610	1/2	690141 18204	
5 x 1/2 x 1-1/4	V=20°	SD320-C176-P100C	1/2	079587 83074	AD320-UP061 G-Force	1/2	601576 93843	A4D180-R115B610	1/2	690141 18205	
								D220-C100-K+925	6mm	601576 23953	
5 x 1/2 x 1-1/4	V=30°	SD320-C176-P100C	1/2	079587 83085 NS	AD320-UP671 G-Force	1/2	601576 93841	A4D180-R115B610	1/2	690141 18206	
TYPE 1V1 – Diamond Flute/Gash											
5 x 3/8 x 1-1/4	V=45°				AD320-UP531 G-Force	1/2	601576 96562	A4D320-R115B610	1/2	690141 18257	
TYPE 1V1 – Diamond Gash											
5 x 1/2 x 1-1/4	V=45°				AD320-UP531 G-Force	1/4	662603 29604	A4D320-R115B610	1/4	690141 18209	
5 x 1/2 x 1-1/4	V=60°				AD320-UR331 Univel	1/4	662603 29469				

NS Non-stock, contact your Norton representative for current lead-times.
All holes (bores) are machined to (H7) class fit.

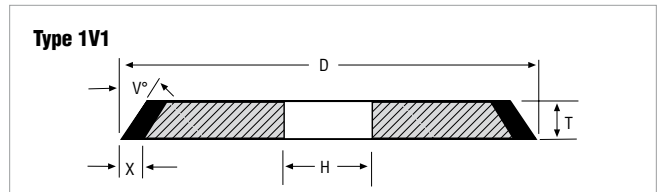
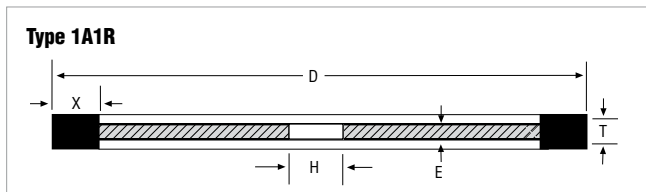
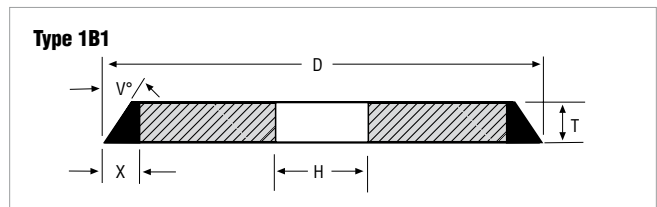
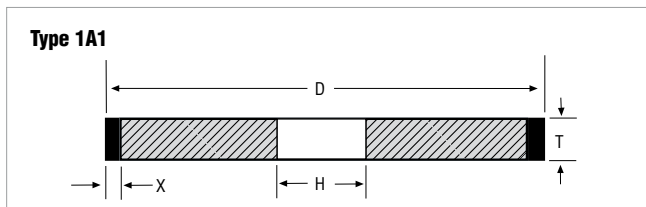

Diamond CNC Wheels

TIER: BEST		BETTER				GOOD				
TRADENAME: PARADIGM		G-FORCE/UNIVEL				NORTON WINTER				
SIZE (D x T x H) U, W	ANGLE V	SPECIFICATION	ABR. DEPTH X	PART #	SPECIFICATION	ABR. DEPTH X	PART #	SPECIFICATION	ABR. DEPTH X	PART #
TYPE 6A2 – Diamond Point										
4 x 1-1/4 x 1-1/4 W=1/4		SD320-E168-P100C	1/4	079587 83057NS	AD320-UP251 G-Force	1/4	690141 18644NS	ASD320C-R100B56	1/4	690141 18219NS
TYPE 11A2 – Diamond Relief										
3 x 1-1/4 x 1-1/4 W=1/4					10D320-NB100U Univel	1/4	601576 92199			
4 x 1-1/4 x 1-1/4 W=1/4		SD320-E168-P100C	1/4	079587 83059NS	AD320-UP701 G-Force	1/4	601576 96315	ASDC320-R100B80	1/4	690141 18213
4 x 1-1/4 x 1-1/4 W=1/4					AD320-UP561 G-Force	1/4	690141 18479NS	ASDC320-R100B80	1/4	690141 18265NS
TYPE 11V5 – Diamond Relief										
4 x 1-1/4 x 1-1/4 V=30° W=1/4					AD320-UP561 G-Force	1/4	690141 17838	ASDC320-R100B80	1/4	690141 18211
4 x 1-1/4 x 1-1/4 V=10° W=3/8					AD320-UP561 G-Force	1/4	690141 17812	ASDC320-R100B80	1/4	690141 18212
TYPE 11V9 – Diamond Relief										
3-3/4 x 1-1/2 x 1-1/4 U=3/8					10D240-PB125-U Univel	1/8	662603 22134	ASDC320-R100B80	1/8	690141 18259
5 x 1-3/4 x 1-1/4 U=5/8					10D240-PB125-U Univel	1/8	662601 18300	ASDC320-R100B80	1/8	690141 18215
TYPE 12V9 – Diamond Relief										
4 x 3/4 x 1-1/4 U=3/8					AD320-UP531 G-Force	1/8	662601 27950NS	ASDC320-R100B80	1/8	690141 18221NS
5 x 3/4 x 1-1/4 U=1/2					AD320-UP531 G-Force	1/8	662601 27911NS	ASDC320-R100B80	1/8	690141 18222NS

NS Non-stock, contact your Norton representative for current lead-times.
All holes (bores) are machined to (H7) class fit.

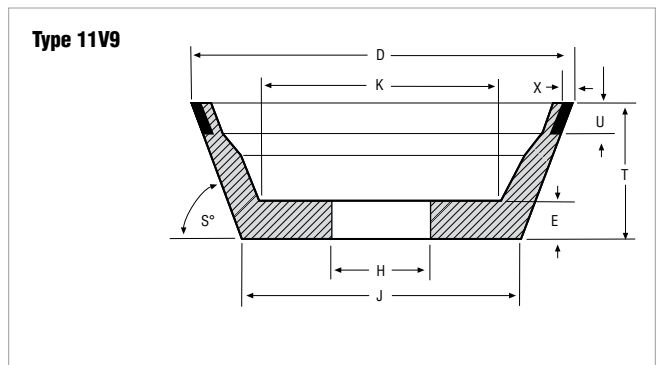
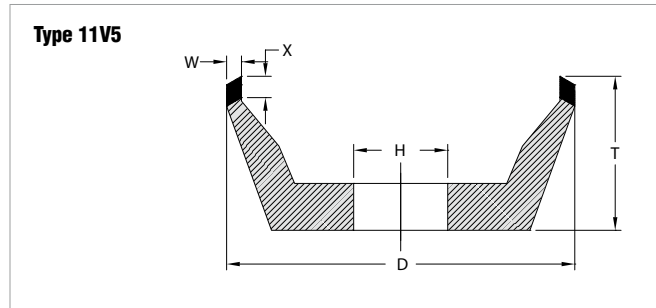
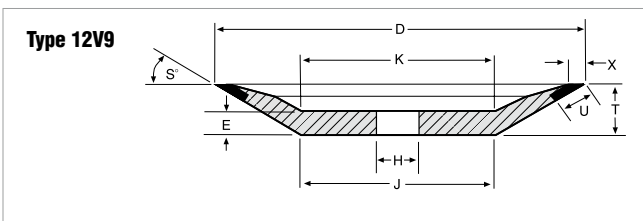
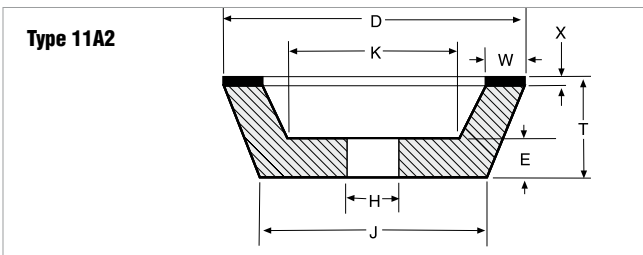
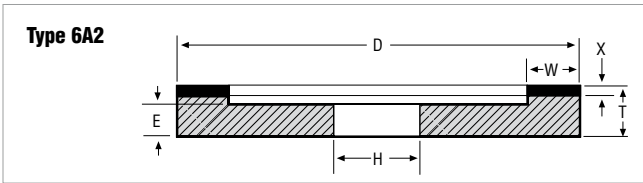

TECH TIP

Diamond Grinds:

In general, diamond is used to grind non-ferrous materials, because it reacts with iron.

- Cemented carbide
- Glass
- Ceramics
- Fiberglass
- Plastics
- Stone
- Abrasives
- Electronic components and materials



It is the user's responsibility to refer to and comply with ANSI B7.1

cBN CNC Wheels



Best choice for CNC HSS round tool manufacturing

G-FORCE / UNIVEL cBN WHEELS

- Truable online and offline for lights-out manufacturing and maximum productivity
- Wear and load resistance deliver superior grinding performance on tough-to-grind carbides with 6-12% cobalt content
- Low specific cutting energy for faster grinding with lower power draw and less burn



Good choice for short runs and frequent geometry changes

cBN CNC WHEELS

- A price competitive alternative to premium wheels; ideal for short-run manufacturing jobs where frequent wheel profile changes are required
- Consistent wheel-to-wheel performance for reduced cycle times, less dressing = longer wheel life
- Ideal for resharpening and short-run manufacturing operations; competitively-priced while providing good performance

TIER: **BEST**
TRADENAME: **G-FORCE/UNIVEL**

GOOD
NORTON WINTER

SIZE (D x T x H) U, W	ANGLE V	SPECIFICATION	ABR. DEPTH X	PART #	SPECIFICATION	ABR. DEPTH X	PART #
TYPE 1A1 – cBN Flute							
4 x 1/2 x 1-1/4		BX220-UP241 G-Force	1/4	601576 69935 NS	BAM180-WBXD3037	1/4	690141 18223 NS
					B220-V240-KSS920	6mm	601576 23498
5 x 3/8 x 1-1/4		BX220-UP241 G-Force	1/2	690141 18436 NS	BAM320C-WBXD3037	1/2	690141 18256 NS
5 x 1/2 x 1-1/4		BX220-UP241 G-Force	1/2	601576 70869 NS	BAM180-WBXD3037	1/2	690141 18224 NS
					B220-V240-KSS920	6mm	601576 02944
5 x 5/8 x 1-1/4		BX220-UP241 G-Force	1/2	662603 29385 NS	BAM180-WBXD3037	1/2	690141 18225 NS
6 x 1/4 x 1-1/4		BX240-UP241 G-Force	1/4	690141 18435 NS	BAM180-WBXD3037	1/4	690141 18240 NS
TYPE 1A1 – cBN Relief							
6 x 1/2 x 1-1/4		BX320-UP892 G-Force	1/2	690141 17679 NS	BAM180-WBXD3037	1/2	690141 18237 NS
TYPE 1A1RN – cBN Flute							
5 x 1/4 x 1-1/4		BX150-UP241 G-Force	1/2	079587 73216 NS			
5 x 3/8 x 1-1/4		BX150-UP241 G-Force	1/2	079587 73217 NS			
5 x 1/2 x 1-1/4		BX150-UP241 G-Force	1/2	690141 41373 NS			
TYPE 1B1 – cBN Gash							
5 x 1/2 x 1-1/4	V=30°	BX320-UP701 G-Force	3/4	662603 29388 NS	BAM320C-WBXD3037	3/4	690141 18229 NS
5 x 1/2 x 1-1/4	V=45°	BX320-UP531 G-Force	3/4	662603 29391 NS	BAM320C-WBXD3037	3/4	690141 18230 NS
					B220-V240-KSS920	6mm	601576 23542
TYPE 1V1 – cBN Flute							
4 x 3/8 x 1-1/4	V=20°	BX220-UP241 G-Force	1/4	690141 18342 NS	BAM180C-WBXD3037	1/4	690141 18264 NS
5 x 1/2 x 1-1/4	V=20°	BX220-UP241 G-Force	1/2	601576 80042 NS	BAM180-WBXD3037	1/2	690141 18227 NS
					B220-V240-KSS920	6mm	601576 23944 NS
5 x 1/2 x 1-1/4	V=30°	BX220-UP241 G-Force	1/2	601576 91380 NS	BAM180-WBXD3037	1/2	690141 18228 NS
5 x 1/2 x 1-1/4	V=10°	BX220-UP241 G-Force	1/2	662601 19876 NS	BAM180-WBXD3037	1/2	690141 18226 NS
TYPE 1V1 – cBN Flute/Gash							
5 x 3/8 x 1-1/4	V=45°	BX220-UP531 G-Force	1/2	601576 97699 NS	BAM320C-WBXD3037	1/4	690141 18262 NS
					B220-V240-KSS920	6mm	601576 23524
TYPE 1V1 – cBN Gash							
5 x 1/2 x 1-1/4	V=60°	BX320-UR331 Univel	1/4	662603 29461 NS	BAM320C-WBXD3037	1/4	690141 18232 NS
5 x 1/2 x 1-1/4	V=45°	BX320-UP531 G-Force	1/4	662603 29275 NS	BAM320C-WBXD3037	1/4	690141 18231 NS
					B220-V240-KSS920	6mm	601576 23776

TECH TIP

cBN Grinds:

cBN is used to grind ferrous materials.

- High-speed tool steels
- Die steels
- Hardened carbon steels
- Alloy steels
- Aerospace alloys
- Hardened stainless steel
- Abrasion-resistant ferrous materials



It is the user's responsibility to refer to and comply with ANSI B7.1

NS Non-stock, contact your Norton representative for current lead-times.
All holes (bores) are machined to (H7) class fit.

Type 1A1

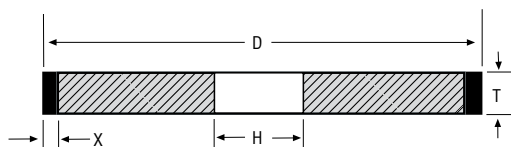

Type 1B1

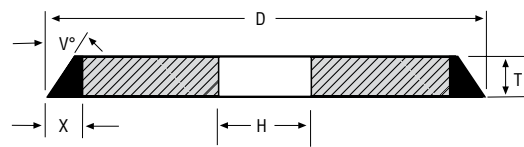

cBN CNC Wheels

TIER: **BEST** **GOOD**
TRADENAME: **G-FORCE/UNIVEL** **NORTON WINTER**

SIZE (D x T x H) U, W	ANGLE V	SPECIFICATION	ABR. DEPTH X	PART #	SPECIFICATION	ABR. DEPTH X	PART #
TYPE 6A2 – cBN Point							
4 x 1-1/4 x 1-1/4 W=1/4		BX320-UP241 G-Force	1/4	690141 18543 NS	CB320C-WBB	1/4	690141 18239 NS
5 x 1-1/4 x 1-1/4 W=1/2		BX320-UP241 G-Force	1/4	690141 18447 NS	CB320C-WBB	1/4	690141 18238 NS
TYPE 11A2 – cBN Relief							
5 x 1-1/2 x 2 W=1/4		BX320-UP531 G-Force	1/4	690141 18406 NS	BAM220-WBE	1/4	690141 18254 NS
TYPE 11A2 – cBN Relief							
4 x 1-1/4 x 1-1/4 W=1/4		BX320-UP531 G-Force	1/4	690141 18445 NS	BAM220-WBE	1/4	690141 18266 NS
TYPE 11V5 – cBN Relief							
4 x 1-1/4 x 1-1/4 W=1/4	V=30°	BX320-UP701 G-Force	1/4	690141 17833 NS	BAM220-WBE	1/4	690141 18233 NS
					B220-J240-KSS63Y	6mm	601576 23563
4 x 1-1/4 x 1-1/4 W=3/8	V=10°	BX320-UP701 G-Force	1/4	690141 17820 NS	BAM220-WBE	1/4	690141 18234 NS
TYPE 11V9 – cBN Relief							
3-3/4 x 1-1/2 x 1-1/4 U=3/8		90B240-PB125-U Univel	1/8	690141 18345 NS	BAM220-WBE	1/8	690141 18260 NS
TYPE 11V9 – cBN Relief							
3-3/4 x 1-1/2 x 1-1/4 U=3/8		90B240-PB125-U Univel	1/8	690141 18029 NS	BAM220-WBE	1/8	690141 18235 NS
5 x 1-3/4 x 2 U=3/8		90B240-PB125-U Univel	1/8	690141 18043 NS	BAM220-WBE	1/8	690141 18248 NS
TYPE 12V9 – cBN Relief							
4 x 3/4 x 1-1/4 U=3/8		BX320-UP531 G-Force	1/8	690141 18470 NS	BAM220-WBE	1/8	690141 18241 NS
5 x 3/4 x 1-1/4 U=1/2		BX320-UP531 G-Force	1/8	690141 18441 NS	BAM220-WBE	1/8	690141 18242 NS

NS Non-stock, contact your Norton representative for current lead-times.
All holes (bores) are machined to (H7) class fit.

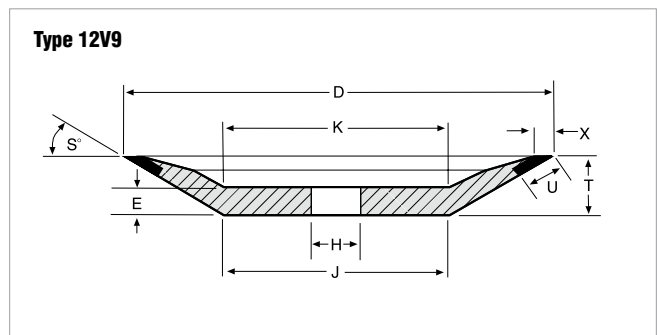
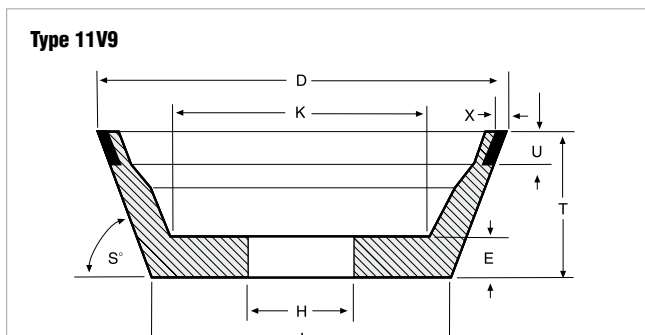
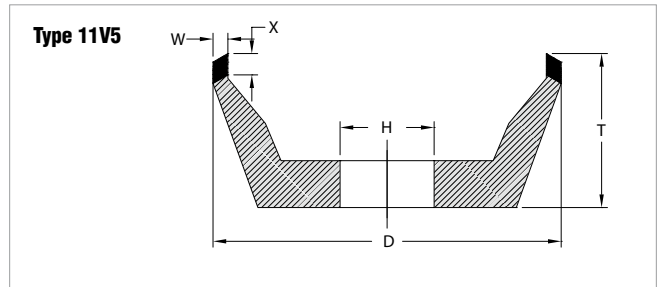
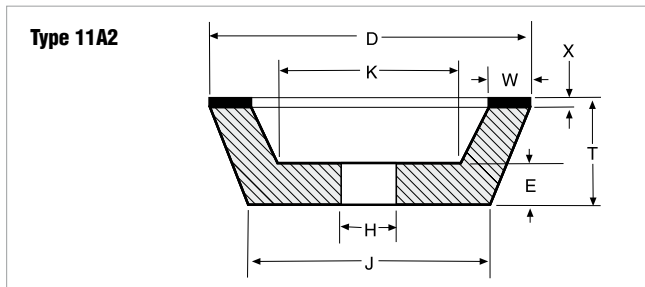
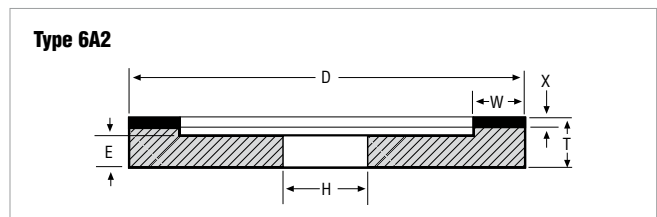
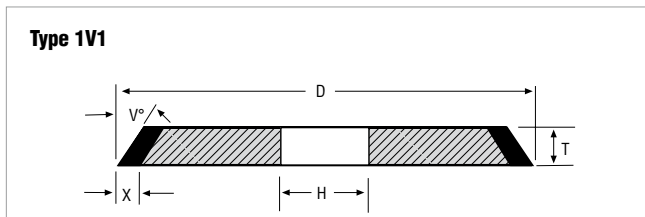

CNC Express Wheel Service for WC and HSS Tools

- G-Force Diamond and cBN wheels altered from blank stock
- Available for a large range of special geometries
- 2-week standard lead time for first-time orders (new part numbers)
- 1-week lead-time for repeat orders (existing part numbers)

How To Request An Express Wheel Quote And Order

Refer to this chart and choose:

- Wheel shape by application
- Diameter "D"
- Thickness "T" from the range of 7/16" to 1/2"
- Hole "H" from the range of 1/2" to 2"
- Angle ("V"), Radius ("R") dimensions from the range provided
- Abrasive depth "X" will always be 1/2" for these CNC wheels
- Specifications required for material and application
- NOTE: Please remember to include the "E" at the end of the specification to indicate Express lead-time is required

CNC Express Blank Stock for Made-To-Order Wheels

Blank Stock Inventory to be altered to your specifications within 5-10 days

Wheel Shape	Tool Material	Application	G-Force Specification AD = Diamond BX = cBN	Diameter D	THK. T	Hole H	Abr. Depth X	Angle (V) or Radius (R)
	WC	Fluting	AD320-UP061E	5	7/16" min. to 1/2" max.	1/2" min. to 2" max.	1/2"	-
	HSS	Fluting	BX320-UP241E	5				
	WC	Fluting	AD320-UP061E	6				
	WC	Fluting	AD320-UP061E	5				
	WC	Fluting	AD320-UP061E	6				
	HSS	Fluting	BX320-UP241E	5				
	WC	Gashing	AD320-UP531E	5				
	HSS	Gashing	BX320-UP531E	5				
	WC	Fluting	AD320-UP061E	5				
	HSS	Fluting	BX320-UP241E	5				
	WC	Fluting	AD320-UP061E	6				
	WC	Fluting	AD320-UP061E	5				
	HSS	Fluting	BX320-UP241E	5				
	WC	Fluting	AD320-UP061E	6				
	WC	Fluting	AD320-UP061E	5				
	HSS	Fluting	BX320-UP241E	5				
	WC	Fluting	AD320-UP061E	6				
	WC	Fluting	AD320-UP061E	5				
	HSS	Fluting	BX320-UP241E	5				
	WC	Fluting	AD320-UP061E	6				

Note: all of the wheel shapes listed can also be designated to have .010 relief(s) 1 side, or 2 sides on 1A1P and 1A1RN wheels.



Our extensive offering of stock diamond and cBN electroplated products has been engineered to meet the diverse demands of traditional and emerging tool and die, ceramic, and composite applications.

Applications: Small hole/ID grinding, deburring, cleaning, honing, precision drilling, forming dies and molds, routing, reaming, blending radii, notching and cutting-off with saw blades in ceramic, tool and die, and composite applications

- Product Types:**
- Mounted points
 - Mandrels
 - Drills
 - Routers
 - Contour tools
 - Wheels
 - Files
 - Saw blades

Abrasive Grain: Diamond or cBN (cubic Boron Nitride)

Maintain tight tolerances and provide superior form holding; can be used wet or dry



ELECTROPLATED PRODUCTS

- Nickel alloy matrix creates a tough, durable bond
- Single layer of abrasive offers an economical choice
- Exposed particles for aggressive cutting action

Identifying Target Markets

An industry is provided beside each product. This key identifies markets that typically use the product.

TARGET MARKET SYMBOLS

- = Ceramics ▲ = Tool & Die ■ = Composites

TECH TIP

Abrasive Applications

Although diamond and cBN (cubic Boron Nitride) are both superabrasives, the use of diamond and cBN varies, depending upon the materials to be ground.

Diamond Grinds:

- Cemented carbide
- Glass
- Ceramics
- Fiberglass
- Plastics
- Composites
- Abrasives
- Stone
- Electronic components and materials

cBN Grinds:

- High-speed tool steels
- Die steel
- Hardened carbon steels
- Hardened stainless steels
- Alloy steels
- Aerospace alloys
- Abrasion-resistant ferrous materials

In general, cBN is used to grind ferrous materials. Diamond is used to grind non-ferrous materials, because of an adverse reaction between diamond and iron.

Made-to-Order Electroplated Product Guide

The stock electroplated products offered on the following pages have been engineered to meet the diversity of demands typical in today's manufacturing environment. When special forms, shapes, and configurations are required, Norton Winter electroplated diamond and cBN products can be fabricated in almost any geometry.

Customer-Supplied Preforms and Blanks

Customers may prefer to manufacture their own preforms/blanks for custom products and in many cases this can reduce cost and lead-times. The instructions below detail the necessary allowances for each grit size. Please refer to these whenever manufacturing blanks.

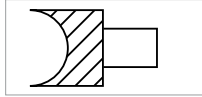

Area to be plated (female radius)

Female radius must be larger than the finished size required.

Example – If a .500 female radius is required with 60/80 grit, then the blank should be manufactured .011 larger = .511

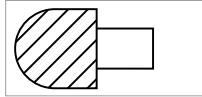

Area to be plated (male radius)

A male radius must be smaller than the finished size required.

Example – If a .500 male radius is required with 60/80 grit, then the blank should be manufactured .011 smaller = .489

Grit Size Allowance for Plated Products

ALLOWANCE/GRIT SIZE	PARTICLE SIZE
20/30	.035
30/40	.025
40/50	.018
60/80	.011
80/100	.008
100/120	.007
120/140	.006
140/170	.005
170/200	.004
200/230	.0035
270/325	.003
4.5 Micron – 400	.0025
30 Micron – 600	.0016
15 Micron – 1200	.001

This should be used as a guide when manufacturing blanks to be plated with diamond or cBN.

Surface Finish

Use this chart only as a guide. Surface finish is affected by a number of variables: machine type and condition, type of material, coolant, wheel speed, bond system, etc.

Expected RMS Finish

GRIT SIZE	ELECTROPLATED
80	90-125
100	64-90
120	48-64
150	32-48
180	24-32
220	20-24
240	16-20
320	16-20
400	14-20
500	12-13
600	12

Strip and Replate Services

Ask Customer Service for information and quotations on our complete strip and replate services on many electroplated products.

TECH TIP

Coolants

Although coolants may not be necessary, using a coolant produces superior surface finishes, a longer tool life, higher performance, and reduces tool loading.

Feeds

Suggested feeds for jig or internal grinding are from .0002" – .0004" per pass.

Speeds

Maximum Operating Speeds (MOS)

Never exceed the maximum operating speed marked on the superabrasive product being used.

- Electroplated Products: 25,000 SFPM

Maximum speeds of mounted points are a function of the length of overhang and size of the product. Refer to "Safe Operating Speeds" in form #2872, provided with your product.

Recommended Operating Speeds

The preceding speed is the maximum safe speed and not necessarily the most efficient. Superabrasive products operate most effectively at speeds lower than the maximum. The following are general recommendations. cBN products, in many cases, are used effectively at higher speeds.

- Electroplated Diamond Products: 5,000 to 10,000 SFPM
- Electroplated cBN Products: 8,000 to 10,000 SFPM

Calculating Operating Speed

The following formula may be used to quickly calculate wheel speed:

- RPM = Revolutions Per Minute
- SFPM = Surface Feet Per Minute

To convert SFPM to RPM: (Multiply SFPM x 3.82) divided by wheel diameter in inches

Electroplated Mounted Points

Diamond and cBN Mounted Points ● ▲

- Use diamond mounted points for precise, small hole, jig and internal grinding of carbide, ceramics, sapphire, glass, and a variety of tough, super alloys
- For grinding tough, high carbon, high chrome steel, use cBN mounted points
- Mandrels are made of high-speed tool steel to withstand operating pressure

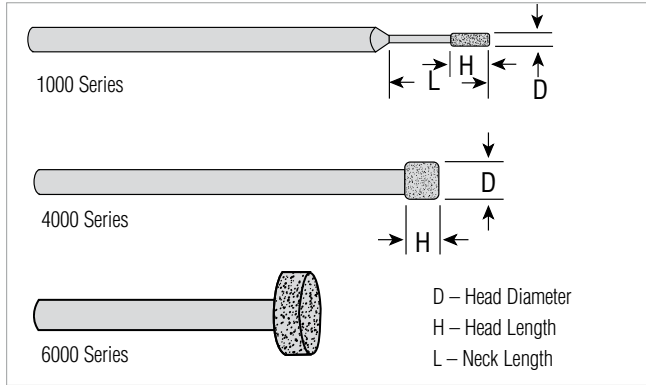

PART #	PRODUCT #	HEAD DIAMETER INCHES	HEAD LENGTH	NECK LENGTH	GRIT SIZE
1000 Series – Diamond					
1/8" Shank x 2-1/4" Overall Length					
66260392429	1016FD	.016	.079	1/8	200
66260392432	1020MD	.020	.079	1/8	150
66260392431	1020FD	.020	.079	1/8	200
66260392436	1025MD	.025	.079	1/8	150
66260392435	1025FD	.025	.079	1/8	200
66260392440	1030MD	.030	.079	1/4	150
66260392439	1030FD	.030	.079	1/4	200
66260392445	1035CD	.035	.118	1/4	100
66260392444	1035MD	.035	.118	1/4	150
66260392443	1035FD	.035	.118	1/4	200
66260392451	1040CD	.040	.118	1/4	100
66260392450	1040MD	.040	.118	1/4	150
66260392449	1040FD	.040	.118	1/4	200
66260392457	1045CD	.045	.118	1/4	100
66260392456	1045MD	.045	.118	1/4	150
66260392455	1045FD	.045	.118	1/4	200
66260392463	1050CD	.050	.118	1/2	100
66260392462	1050MD	.050	.118	1/2	150
66260392461	1050FD	.050	.118	1/2	200
66260392469	1050LCD	.050	.118	1	100
66260392468	1050LMD	.050	.118	1	150
66260392467	1050LFD	.050	.118	1	200
66260392475	1055CD	.055	.118	1/2	100
66260392474	1055MD	.055	.118	1/2	150
66260392473	1055FD	.055	.118	1/2	200
66260392481	1060CD	.060	.157	1/2	100
66260392480	1060MD	.060	.157	1/2	150
66260392479	1060FD	.060	.157	1/2	200
66260392487	1060LCD	.060	.157	1	100
66260392492	1065MD	.065	.157	1/2	150
66260392491	1065FD	.065	.157	1/2	200
66260392499	1070CD	.070	.157	1/2	100
66260392498	1070MD	.070	.157	1/2	150
66260392497	1070FD	.070	.157	1/2	200
66260392505	1070LCD	.070	.157	1	100
66260392511	1075CD	.075	.157	1/2	100
66260392510	1075MD	.075	.157	1/2	150
66260392509	1075FD	.075	.157	1/2	200

Continued

PART #	PRODUCT #	HEAD DIAMETER INCHES	HEAD LENGTH	NECK LENGTH	GRIT SIZE
1000 Series – Diamond (continued)					
1/8" Shank x 2-1/4" Overall Length					
66260392517	1080CD	.080	.157	1/2	100
66260392516	1080MD	.080	.157	1/2	150
66260392515	1080FD	.080	.157	1/2	200
66260392523	1080LCD	.080	.157	1	100
66260392521	1080LFD	.080	.157	1	200
66260392529	1085CD	.085	.157	1/2	100
66260392528	1085MD	.085	.157	1/2	150
66260392535	1090CD	.090	.157	1/2	100
66260392534	1090MD	.090	.157	1/2	150
66260392533	1090FD	.090	.157	1/2	200
66260392541	1090LCD	.090	.157	1	100
66260392540	1090LMD	.090	.157	1	150
66260392547	1095CD	.095	.157	1/2	100
66260392546	1095MD	.095	.157	1/2	150
66260392553	1100CD	.100	.157	1/2	100
66260392552	1100MD	.100	.157	1/2	150
66260392551	1100FD	.100	.157	1/2	200
66260392565	1105CD	.105	.157	1/2	100
66260392563	1105FD	.105	.157	1/2	200
66260392577	1110CD	.110	.157	1/2	100
66260392576	1110MD	.110	.157	1/2	150
66260392583	1110LCD	.110	.157	1	100
66260392589	1115CD	.115	.157	1/2	100
66260392588	1115MD	.115	.157	1/2	150
66260392595	1120CD	.120	.157	1/2	100
66260392594	1120MD	.120	.157	1/2	150
66260392593	1120FD	.120	.157	1/2	200
66260392601	1125CD	.125	.157	1/2	100
66260392600	1125MD	.125	.157	1/2	150
66260392599	1125FD	.125	.157	1/2	200
66260392607	1130CD	.130	.197	1	100
66260392606	1130MD	.130	.197	1	150
66260392613	1135CD	.135	.236	N/A	100
66260392612	1135MD	.135	.236	N/A	150
66260392611	1135FD	.135	.236	N/A	200
66260392619	1140CD	.140	.236	N/A	100
66260392625	1156CD	.156	.236	N/A	100
66260392624	1156MD	.156	.236	N/A	150
66260392623	1156FD	.156	.236	N/A	200
66260392730	1171MD	.171	.236	N/A	150
66260392730	1171MD	.171	.236	N/A	150
66260392737	1187CD	.187	.312	N/A	100
66260392735	1187FD	.187	.312	N/A	200
66260392742	1203MD	.203	.312	N/A	150
66260392741	1203FD	.203	.312	N/A	200
66260392748	1218MD	.218	.312	N/A	150
66260392747	1218FD	.218	.312	N/A	200
66260392755	1250CD	.250	.312	N/A	100
66260392754	1250MD	.250	.312	N/A	150
66260392753	1250FD	.250	.312	N/A	200
66260363450	1750MD	.750	.035	N/A	150

TARGET MARKET SYMBOLS

- = Ceramics
- ▲ = Tool & Die
- = Composites

Electroplated Mounted Points

Diamond and cBN Mounted Points ● ▲

PART #	PRODUCT #	HEAD DIAMETER INCHES	HEAD LENGTH	NECK LENGTH	GRIT SIZE
1000 Series – cBN					
1/8" Shank x 2-1/4" Overall Length					
66260392434	1020MC	.020	.079	1/8	150
66260392442	1030MC	.030	.079	1/4	150
66260392453	1040MC	.040	.118	1/4	150
66260392460	1045CC	.045	.118	1/4	100
66260392466	1050CC	.050	.118	1/2	100
66260392465	1050MC	.050	.118	1/2	150
66260392464	1050FC	.050	.118	1/2	200
66260392484	1060CC	.060	.157	1/2	100
66260392483	1060MC	.060	.157	1/2	150
66260392482	1060FC	.060	.157	1/2	200
66260392496	1065CC	.065	.157	1/2	100
66260392502	1070CC	.070	.157	1/2	100
66260392501	1070MC	.070	.157	1/2	150
66260392500	1070FC	.070	.157	1/2	200
66260392514	1075CC	.075	.157	1/2	100
66260392520	1080CC	.080	.157	1/2	100
66260392532	1085CC	.085	.157	1/2	100
66260392538	1090CC	.090	.157	1/2	100
66260392537	1090MC	.090	.157	1/2	150
66260392536	1090FC	.090	.157	1/2	200
66260392543	1090LMC	.090	.157	1	150
66260392556	1100CC	.100	.157	1/2	100
66260392554	1100FC	.100	.157	1/2	200
66260392561	1100LMC	.100	.157	1	150
66260392568	1105CC	.105	.157	1/2	100
66260392567	1105MC	.105	.157	1/2	150
66260392580	1110CC	.110	.157	1/2	100
66260392578	1110FC	.110	.157	1/2	200
66260392598	1120CC	.120	.157	1/2	100
66260392604	1125CC	.125	.157	1/2	100
66260392603	1125MC	.125	.157	1/2	150
66260392602	1125FC	.125	.157	1/2	200
66260392610	1130CC	.130	.197	1	100
66260392608	1130FC	.130	.197	1	200
66260392616	1135CC	.135	.236	N/A	100
66260392615	1135MC	.135	.236	N/A	150
66260392622	1140CC	.140	.236	N/A	100
66260392628	1156CC	.156	.236	N/A	100
66260392627	1156MC	.156	.236	N/A	150
66260392626	1156FC	.156	.236	N/A	200
66260392734	1171CC	.171	.236	N/A	100
66260392733	1171MC	.171	.236	N/A	150
66260392740	1187CC	.187	.312	N/A	100
66260392739	1187MC	.187	.312	N/A	150
66260392738	1187FC	.187	.312	N/A	200
66260392745	1203MC	.203	.312	N/A	150
66260392751	1218MC	.218	.312	N/A	150
66260392758	1250CC	.250	.312	N/A	100
66260392757	1250MC	.250	.312	N/A	150

PART #	PRODUCT #	HEAD DIAMETER INCHES	HEAD LENGTH	NECK LENGTH	GRIT SIZE
4000 Series – Diamond					
1/4" Shank x 3" Overall Length					
66260392630	4156CD	.156	.250	1	100
66260392629	4156FD	.156	.250	1	200
66260392634	4187CD	.187	.250	1	100
66260392633	4187FD	.187	.250	1	200
66260392638	4203CD	.203	.250	1	100
66260392642	4218CD	.218	.250	1	100
66260392641	4218FD	.218	.250	1	200
66260392646	4236CD	.236	.250	1	100
66260392645	4236FD	.236	.250	1	200
66260392650	4250CD	.250	.250	1	100
66260392649	4250FD	.250	.250	1	200
66260392654	4282CD	.282	.250	N/A	100
66260392653	4282FD	.282	.250	N/A	200
66260392658	4312CD	.312	.375	N/A	100
66260392657	4312FD	.312	.375	N/A	200
66260392662	4375CD	.375	.375	N/A	100
66260392661	4375FD	.375	.375	N/A	200
66260392666	4390CD	.390	.375	N/A	100
66260392670	4406CD	.406	.375	N/A	100
66260392674	4437CD	.437	.375	N/A	100
66260392678	4500CD	.500	.375	N/A	100
66260392677	4500FD	.500	.375	N/A	200
66260392682	4730CD	.730	.375	N/A	100
66260392690	41000CD	1.000	.375	N/A	100
66260392689	41000FD	1.000	.375	N/A	200
4000 Series – cBN					
1/4" Shank x 3" Overall Length					
66260392632	4156CC	.156	.250	1	100
66260392631	4156FC	.156	.250	1	200
66260392636	4187CC	.187	.250	1	100
66260392635	4187FC	.187	.250	1	200
66260392640	4203CC	.203	.250	1	100
66260392639	4203FC	.203	.250	1	200
66260392644	4218CC	.218	.250	1	100
66260392643	4218FC	.218	.250	1	200
66260392648	4236CC	.236	.250	1	100
66260392647	4236FC	.236	.250	1	200
66260392652	4250CC	.250	.250	1	100
66260392651	4250FC	.250	.250	1	200
66260392656	4282CC	.282	.250	N/A	100
66260392655	4282FC	.282	.250	N/A	200
66260392660	4312CC	.312	.375	N/A	100
66260392659	4312FC	.312	.375	N/A	200
66260392664	4375CC	.375	.375	N/A	100
66260392663	4375FC	.375	.375	N/A	200
66260392668	4390CC	.390	.375	N/A	100
66260392672	4406CC	.406	.375	N/A	100
66260392676	4437CC	.437	.375	N/A	100
66260392675	4437FC	.437	.375	N/A	200
66260392680	4500CC	.500	.375	N/A	100
66260392679	4500FC	.500	.375	N/A	200
66260392684	4730CC	.730	.375	N/A	100
66260392692	41000CC	1.000	.375	N/A	100

TARGET MARKET SYMBOLS

● = Ceramics ▲ = Tool & Die ■ = Composites

Electroplated Mounted Points, Mandrels, Tapered Honers and Micro Drills

Diamond and cBN Mounted Points ● ▲

PART #	PRODUCT #	HEAD DIAMETER INCHES	HEAD LENGTH	GRIT SIZE
6000 Series – Diamond				
3/8" Shank x 3-3/4" Overall Length				
66260392694	6406CD	.406	.375	80
66260392693	6406MD	.406	.375	150
66260392698	6437CD	.437	.375	80
66260392697	6437MD	.437	.375	150
66260392702	6500CD	.500	.375	80
66260392701	6500MD	.500	.375	150
66260392706	6562CD	.562	.375	80
66260392710	6625CD	.625	.375	80
66260392709	6625MD	.625	.375	150
66260392718	6750CD	.750	.375	80
66260392717	6750MD	.750	.375	150
66260392721	6875MD	.875	.400	150
66260392726	61000CD	1.000	.500	80

PART #	PRODUCT #	HEAD DIAMETER INCHES	HEAD LENGTH	GRIT SIZE
6000 Series – cBN				
3/8" Shank x 3-3/4" Overall Length				
66260392696	6406CC	.406	.375	80
66260392695	6406MC	.406	.375	150
66260392700	6437CC	.437	.375	80
66260392699	6437MC	.437	.375	150
66260392703	6500CC	.500	.375	80
66260392704	6500MC	.500	.375	150
66260392708	6562CC	.562	.375	80
66260392712	6625CC	.625	.375	80
66260392716	6687CC	.687	.375	80
66260392715	6687MC	.687	.375	150
66260392720	6750CC	.750	.375	80
66260392719	6750MC	.750	.375	150
66260392724	6875CC	.875	.400	80
66260392728	61000CC	1.000	.500	80
66260392727	61000MC	1.000	.500	150

cBN Heavy Stock Removal Mandrels ▲

- For heavy stock removal on jig, internal, and offhand operations on tool steels and hardened aerospace alloys. Made with super coarse abrasive grit for long tool life

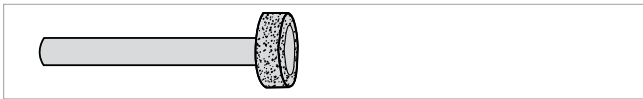

PART #	PRODUCT #	HEAD DIAMETER	HEAD LENGTH	SHANK DIAMETER	OVERALL LENGTH	GRIT SIZE
HSR Series – cBN						
66260395426	HSR-1/4	1/4	1/4	3/8	3	60
66260395428	HSR-3/8	3/8	3/8	3/8	3	60
66260395429	HSR-1/2	1/2	3/8	3/8	3-1/2	60
66260395431	HSR-3/4	3/4	3/8	3/8	3-1/2	60
66260395432	HSR-1	1	3/8	3/8	3-1/2	60

Diamond Tapered Honers for Drawing Dies ● ▲ ■

- Used primarily for forming carbide drawing dies, but also can be used for small hole honing in ceramics, fiberglass, plastics, and composite materials

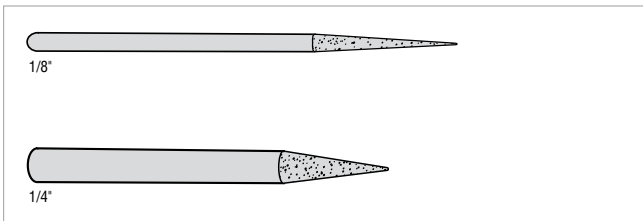

PART #	PRODUCT #	INCLUDED ANGLE	SHANK DIAMETER	GRIT SIZE
Tapered Honers for Drawing Dies – Diamond				
3" Overall Length				
66260395540	TH12-6MD	6°	1/8	150
66260395541	TH12-8MD	8°	1/8	150
66260363371	TH25-12CD	12°	1/4	100
66260395542	TH12-12MD	12°	1/8	150
66260395543	TH25-12MD	12°	1/4	150
66260395544	TH25-14MD	14°	1/4	150
66260395545	TH25-16MD	16°	1/4	150

Diamond Micro Drills ● ▲ ■

- A modification of mounted points, these tools are specifically designed for drilling holes in the .007" to .065" diameter range
- Perfect for drilling sapphire and high density alumina ceramics for hybrid micro-circuit substrates
- M-Series - Carefully-sized, uniformly-shaped diamond particles are used on all M-Series drills
- S-Series - Recommended for adapting to ultrasonic drill heads

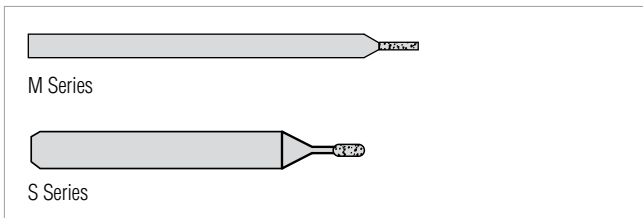

PART #	PRODUCT #	DIAMETER INCHES	HEAD LENGTH	OVERALL LENGTH	GRIT SIZE
M-Series Micro Drills – Diamond					
Shank Diameter .040" (1mm)					
66260395516	M7	.007	.028	11/16	600
66260395517	M10	.010	.049	11/16	400
66260395518	M12	.012	.056	13/16	325
66260395519	M15	.015	.077	13/16	325

PART #	PRODUCT #	DIAMETER INCHES	HEAD LENGTH	OVERALL LENGTH	GRIT SIZE
S-Series Micro Drills – Diamond					
1/8" Shank x 1" Overall Length					
66260395520	S16FD	.016	.062	.093	200
66260392841	S18FD	.018	.062	.125	200
66260395521	S20FD	.020	.062	.125	200
66260395522	S25FD	.025	.093	.156	200
66260395523	S30MD	.030	.093	.156	150
66260395524	S35MD	.035	.093	.187	150
66260395525	S40MD	.040	.125	.218	150
66260395526	S45CD	.045	.125	.218	100
66260395527	S50CD	.050	.125	.250	100
66260395528	S60CD	.060	.125	.312	100
66260395529	S65CD	.065	.125	.312	100

TARGET MARKET SYMBOLS
● = Ceramics ▲ = Tool & Die ■ = Composites

Electroplated Routers and Mounted Contour Tools

Diamond Routers ● ■

- Used with hand operated tools, drill presses, and milling machines
- Ideal for routing and reaming the highly-abrasive materials of alumina, fiberglass, plastics, and other nonmetallic composite materials.

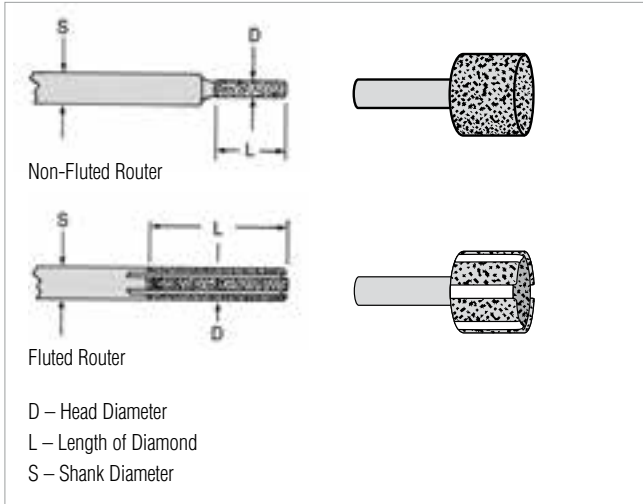

PART #	PRODUCT #	HEAD DIAMETER	LENGTH OF DIAMOND	SHANK DIAMETER	OVERALL LENGTH	GRIT SIZE
Non-Fluted Routers – Diamond						
662603 64302	RNF1410CD	1/4	1	1/4	2-1/2	40
Fluted Routers – Diamond						
662603 64310	RSF1812CD	1/8	1/2	1/4	2-1/2	60
662603 64309	RSF1810CD	1/8	1	1/4	2-1/2	60
662603 64308	RSF1412CD	1/4	1/2	1/4	2-1/2	40
662603 64307	RSF1410CD	1/4	1	1/4	2-1/2	40
662603 02715	RSF3412CD	3/4	1/2	1/2	2-1/2	40

Type 6A2C cup and Type 01 straight bench and pedestal electroplated wheels are available as made-to order products. Contact your Norton representative for availability and quotation.

Diamond and cBN Mounted Contour Tools ● ▲ ■

- For contour grinding applications on carbide, ceramics, glass, ferrites, and many tough alloys and cements. Best suited for blending radii and deburring operations
- Operating speeds: 15,000-20,000 RPM range
- Variety of tool shapes available as stock to satisfy most tool and die and deburring requirements

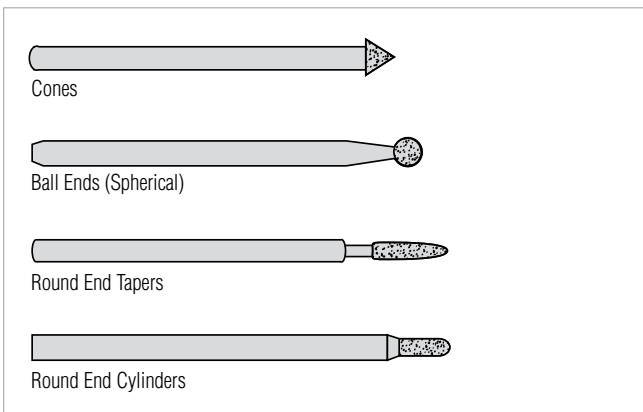

PART #	PRODUCT #	BALL DIAMETER	GRIT SIZE
Ball Ends (Spherical) – Diamond			
1/8" Shank x 2" Overall Length			
662603 95434	BE1CD	3/64	100
662603 95436	BE2CD	1/16	100
662603 95438	BE3CD	5/64	100
662603 95440	BE4CD	3/32	100
662603 95442	BE5CD	1/8	100
662603 95444	BE6CD	3/16	100
662603 95448	BE8CD	3/8	100
662603 95450	BE9CD	1/2	100
Ball Ends (Spherical) – cBN			
1/8" Shank x 2" Overall Length			
662603 95437	BE3CC	5/64	100
662603 95439	BE4CC	3/32	100
662603 95441	BE5CC	1/8	100
662603 95443	BE6CC	3/16	100
662603 95445	BE7CC	1/4	100

PART #	PRODUCT #	SMALL HEAD DIAMETER	LARGE HEAD DIAMETER	HEAD LENGTH	INC. ANGLE	GRIT SIZE
Round End Tapers – Diamond						
1/8" Shank x 2" Overall Length						
662603 95506	RT44CD	.044	.066	5/16	4°	100
662603 95510	RT78CD	.078	.110	5/16	6°	100
Round End Tapers – cBN						
1/8" Shank x 2" Overall Length						
662603 95509	RT78CC	.078	.110	5/16	6°	100

PART #	PRODUCT #	CONE BASE DIAMETER	INCLUDED ANGLE	CONE LENGTH	GRIT SIZE
Cones – Diamond					
1/8" Shank x 2" Overall Length					
662603 95484	C14CD	1/8	14°	1/2	100
662603 95488	C35CD	5/32	35°	1/4	100
662603 95490	C60CD	11/64	60°	5/32	100
662603 95492	C90CD	3/16	90°	3/32	100
Cones – cBN					
1/8" Shank x 2" Overall Length					
662603 95483	C14CC	1/8	14°	1/2	100
662603 95485	C26CC	3/16	26°	13/32	100
662603 95487	C35CC	5/32	35°	1/4	100
662603 95489	C60CC	11/64	60°	5/32	100
662603 95491	C90CC	3/16	90°	3/32	100

PART #	PRODUCT #	HEAD DIAMETER	HEAD LENGTH	GRIT SIZE
Round End Cylinders – Diamond				
1/8" Shank x 2" Overall Length				
662603 95494	RE1CD	1/16	1/4	100
662603 95496	RE2CD	5/64	1/4	100
662603 95498	RE3CD	3/32	1/4	100
662603 95500	RE4CD	1/8	1/4	100
662603 95502	RE5CD	3/16	5/16	100
662603 95504	RE6CD	1/4	5/16	100

TARGET MARKET SYMBOLS

- = Ceramics
- ▲ = Tool & Die
- = Composites

Electroplated Files

Diamond Machine Files ● ▲

- For use in reciprocating hand profiling machines
- Ideal for reworking and finishing carbide dies and molds, blending radii, and deburring and cleaning slots and grooves

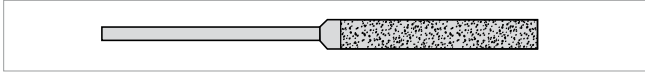

Diamond Hand Files ● ▲

- Indispensable aid for the toolroom
- All purpose hand-held tool useful for deburring, notching, dressing, and honing hard, brittle materials

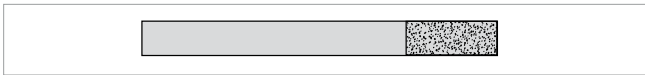

PART #	PRODUCT #	DIMENSIONS	ABRASIVE LOCATION	GRIT SIZE
Machine Files – Diamond				
5/8" Diamond Length, 1/8" Shank, 2" Overall Length				
662603 95585	1ECD	.020 x .125		100
662603 95586	2ECD	.030 x .125		100
662603 95587	3ECD	.040 x .125		100
662603 95589	3FCD	.120 x .040		100
662603 95590	4FCD	.157 x .040		100
662603 95591	5FCD	.203 x .078		100
662603 95592	6FCD	.120 x .040		100
662603 95593	1CCD	.098 x .196		100
662603 95594	2CCD	.120 x .250		100
662603 95596	3TCD	.127 side		100
662603 95598	1RCD	.042 diam.		100
662603 95599	2RCD	.080 diam.		100
662603 95600	3RCD	.127 diam.		100

PART #	PRODUCT #	DIMENSIONS	ABRASIVE LOCATION	GRIT SIZE
Hand Files – Diamond				
6" Overall Length, 1-1/2" Diamond Length				
662603 95605	DF1CD	1/8 x 1/8		100
662603 95606	DF2CD	1/8 x 1/4		100
662603 95607	DF2WCD	1/8 x 1/4		100
662603 95608	DF3CD	1/8 x 3/8		100
662603 92844	DF3FD	1/8 x 3/8		200
662603 95609	DF3WCD	1/8 x 3/8		100
662603 64241	DF3SCD	1/8 x 1/2		100
662603 95611	DF4CD	1/8		100
662603 00134	DF4WCD	1/4		100
662603 95613	DF5CD	1/8		100
662603 92846	DF5FD	1/8		200
662603 95614	DF5WCD	1/4		100
662603 95615	DF6CD	1/8		100

TARGET MARKET SYMBOLS

- = Ceramics
- ▲ = Tool & Die
- = Composites

Electroplated Files and Drills

Diamond Needle Files ● ▲

- Indispensable aid for the toolroom
- An all-purpose hand-held tool, useful for deburring, notching, dressing, and honing hard, brittle materials

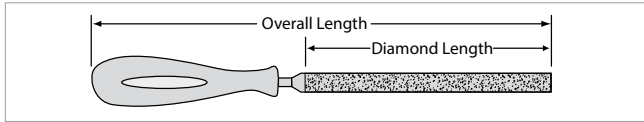

PART #	PRODUCT #	GRIT SIZE
NFK-6 Needle File Kit – Diamond		
662603 64008	NFK-6	
Contains one each of the following:		
	NF1FD	200
	NF2FD	200
	NF3FD	200
	NF4FD	200
	NF5FD	200
	NF6FD	200
DFS-6 Die File Kit – Diamond		
662603 91830	DFS-6	
Contains one each of the following:		
	1571	100
	1572	100
	1573	100
	1574	100
	1575	100
	1576	100

PART #	PRODUCT #	DIMENSIONS	ABRASIVE LOCATION	SHAPE	GRIT SIZE
Needle Files – Diamond					
4-1/4" Diamond Length, 8-1/2" Overall Length					
662603 02432	LNF2CD	.400 x .100		Equaling	100
662603 05611	LNF2FD	.400 x .100		Equaling	200
662603 02898	LNF3CD	.450 x .150		Half Round	100
662603 05612	LNF3FD	.485 x .150		Half Round	200
2-3/4" Diamond Length, 5-3/4" Overall Length, With Handle					
662603 91729	1571	.055 x .190		Flat	100
662603 91730	1572	.075 x .210		Half Round	100
662603 91731	1573	.145 x .145		Triangle	100
662603 91732	1574	.100 x .100		Square	100
662603 91733	1575	.120		Round	100
662603 91734	1576	.055 x .190		Pointed Flat	100
3" Diamond Length, 5-1/2" Overall Length, With Handle					
662603 95575	NF1FD	.150 x .105		Oval	200
662603 95576	NF2FD	.218 x .072		Half Round	200
662603 95577	NF3FD	.205 x .058		Equaling	200
662603 95578	NF4FD	.096 x .096		Square	200
662603 95579	NF5FD	.138 x .138		Triangle	200
662603 95580	NF6FD	.118		Round	200

Needle File Shape and Application Key:

Barrette:	A triangle with diamond on the bottom side only
Crossing:	Elongated oval, with more pointed ends than an oval file; has diamonds all around
Equaling:	A rectangle with diamond on all four sides; ideal for filing both sides of an ID simultaneously
Pointed Flat:	A cone with a flat top with diamond on the sides of the cone

Diamond Core Drills ● ■

- High performance on glass and ceramic applications while providing fast, reliable cutting
- Submersed drilling is highly recommended for optimum operating performance



PART #	PRODUCT #	OUTER DIAMETER	INNER DIAMETER	GRIT SIZE
Core Drills – Diamond				
Straight Tube Type, 2" Overall Length				
662603 95530	A1MD	1/16	.023	150
662603 95531	A2MD	3/32	.048	150
662603 95532	A3MD	1/8	.075	150
662603 95533	A4MD	5/32	.110	150
662603 95534	A5CD	3/16	.140	100
662603 95535	A6CD	1/4	.195	100
662603 95536	A7CD	5/16	.255	100

Diamond Twist Drills ● ■

- Recommended for precision drilling on circuit boards containing fiberglass, nylon, and similar tough, abrasive materials
- Diamond twist drills are also useful for drilling plastics and resin composites and have been successful in drilling soft ductile materials as well as "green" carbide
- Operating procedures are similar to those of standard twist drills

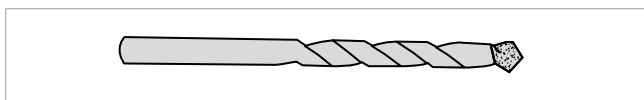

PART #	PRODUCT #	DRILL DIAMETER	DRILL LENGTH	GRIT SIZE
Twist Drills – Diamond				
662603 95549	TW-1/16	1/16	1-3/4	100
662603 95550	TW-1/8	1/8	2-3/4	100
662603 95551	TW-1/4	1/4	4	100

Diameter tolerance equals + or - 1/64.

TARGET MARKET SYMBOLS

- = Ceramics
- ▲ = Tool & Die
- = Composites

Electroplated Saw Blades

Diamond Continuous Rim Cut-off Saw Blades ■

- Ideal for cutting-off highly-abrasive materials such as alumina, fiberglass, plastics, and other nonmetallic composite materials

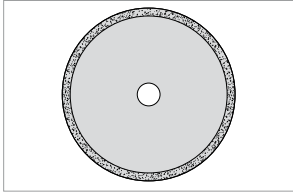

Additional diamond continuous rim and slotted cut-off saw blades, with extended wraps to avoid binding, are available as made-to-order products. Please contact your Norton representative.

Diamond Slotted Cut-off Saw Blades ■

- 3/4" wrap: additional 3/4" of electroplated diamond on the blade core increases life of blade on deep cuts, and reduces binding and grinding on the core

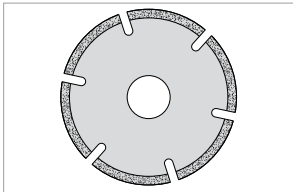

Additional diamond continuous rim and slotted cut-off saw blades, with extended wraps to avoid binding, are available as made-to-order products. Please contact your Norton representative.

Diamond Mounted Saw Blades ■

- Ideal for cutting-off highly-abrasive materials such as alumina, fiberglass, plastics, and other nonmetallic composite materials
- 3/4" wrap - additional 3/4" of electroplated diamond on the blade core increases life of blade on deep cuts, and reduces binding and grinding on the core

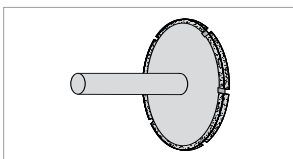

PART #	PRODUCT #	DIAM.	OVERALL THICKNESS	HOLE SIZE	GRIT SIZE
Continuous Rim Cut-off Saw Blades – Diamond					
662603 01990	DS2062-250	2	1/16	1/4	40
662603 91474	DS2094-250	2	3/32	1/4	40
662603 91473	DS3094-250	3	3/32	1/4	40
662603 63036	DS3094-375	3	3/32	3/8	40
662603 95554	DS4094-500	4	3/32	1/2	40
662603 00197	DS4094-750	4	3/32	3/4	40
662603 95557	DS8094-625	8	3/32	5/8	40

PART #	PRODUCT #	DIAM.	OVERALL THICKNESS	HOLE SIZE	GRIT SIZE
Slotted Cut-off Saw Blades – Diamond					
662603 01989	DSS2062-250	2	1/16	1/4	40
662603 64258	DSS3094-250	3	3/32	1/4	40
662603 95559	DSS4094-500	4	3/32	1/2	40
662603 95560	DSS6094-500	6	3/32	1/2	40
662603 62981	DSS10125-625	10	1/8	5/8	40
662603 64253	DSS14156-500	14	5/32	1/2	40
662603 62989	DSS14156-1	14	5/32	1	40
662603 95565	DSS16156-1	16	5/32	1	40
662603 95566	DSS18156-1	18	5/32	1	40
Slotted Cut-off Saw Blades with 3/4" Wrap – Diamond					
662603 13423	DSSW4094-750	4	3/32	3/4	40

PART #	PRODUCT #	DIAM.	OVERALL THICKNESS	HOLE SIZE	GRIT SIZE
Mounted Saw Blades – Diamond					
2" Overall Length					
662603 95422	MDS1CD	1	3/32	1/4	40
662603 95423	MDS1-1/2CD	1-1/2	3/32	1/4	40
662603 95424	MDS2CD	2	3/32	3/8	40

TARGET MARKET SYMBOLS

- = Ceramics
- ▲ = Tool & Die
- = Composites



Norton Winter diamond lapping compound polishes all materials – hard and soft. Diamond powders are uniformly distributed in a liquid vehicle for aggressive polishing and consistent part quality. Easy-to-use plastic syringe for quick clean-up.

Applications:

For mold, die, and tool polishing, polishing to final tolerance of ceramic parts, initial charging of lapping plates and discs, and other processes that require mirror finish and close tolerance performance.

Syringe Size:
Type:

5 and 18 gram syringes
Water soluble – when soap/water is used for clean-up
Oil soluble – when solvent is used for clean-up

PRODUCT #	MICRON GRADE	COLOR	PART #
Diamond Compound – Water Soluble			
5 Gram Syringes			
5PS1/4WSSTD	1/4 Ultra Fine	Gray	662603 00362
5PS1/2WSSTD	1/2 Ultra Fine	Lt. Gray	662603 00417
5PS1WSSTD	1 Ultra Fine	Ivory	662603 00368
5PS3WSSTD	3 Super Fine	Yellow	662603 00667
5PS6WSSTD	6 Super Fine	Orange	662603 00372
5PS9WSSTD	9 Super Fine	Green	662603 00375
5PS12WSSTD	12 Super Fine	Aqua	662603 00376
5PS15WSSTD	15 Fine	Blue	662603 00379
5PS30WSSTD	30 Fine	Red	662603 00383
5PS45WSSTD	45 Fine	Brown	662603 00384
5PS60WSSTD	60 Fine	Purple	662603 00388
5PS90WSSTD	90 Fine	Black	662603 00389
18 Gram Syringes			
18PS1/4WSSTD	1/4 Ultra Fine	Gray	662603 00392
18PS1/2WSSTD	1/2 Ultra Fine	Lt. Gray	662603 00394
18PS1WSSTD	1 Ultra Fine	Ivory	662603 00396
18PS3WSSTD	3 Super Fine	Yellow	662603 00398
18PS6WSSTD	6 Super Fine	Orange	662603 00400
18PS9WSSTD	9 Super Fine	Green	662603 00402
18PS15WSSTD	15 Fine	Blue	662603 00406
18PS20WSSTD	20 Fine	Auburn	662603 00408

PRODUCT #	MICRON GRADE	COLOR	PART #
Diamond Compound – Oil Soluble			
5 Gram Syringes			
5PS1/4OSSTD	1/4 UltraFine	Gray	614636 91123 NS
5PS1/2OSSTD	1/2 UltraFine	Lt. Gray	662603 00363
5PS1OSSTD	1 UltraFine	Ivory	614636 91133
5PS3OSSTD	3 Super Fine	Yellow	614636 91138
5PS6OSSTD	6 Super Fine	Orange	614636 91143
5PS9OSSTD	9 Super Fine	Green	614636 91148
5PS15OSSTD	15 Fine	Blue	614636 91153
5PS30OSSTD	30 Fine	Red	614636 91158
5PS45OSSTD	45 Fine	Brown	614636 91163
5PS60OSSTD	60 Fine	Purple	662603 00386
5PS90OSSTD	90 Fine	Black	662603 00390
18 Gram Syringes			
18PS1/4OSSTD	1/4 UltraFine	Gray	662603 00391
18PS1OSSTD	1 UltraFine	Ivory	614636 91134 NS
18PS3OSSTD	3 Super Fine	Yellow	614636 91139
18PS6OSSTD	6 Super Fine	Orange	662603 00399
18PS9OSSTD	9 Super Fine	Green	614636 91149 NS
18PS15OSSTD	15 Fine	Blue	614636 91154
18PS20OSSTD	20 Fine	Auburn	662603 00407
18PS30OSSTD	30 Fine	Red	662603 00409
18PS45OSSTD	45 Fine	Brown	614636 91164 NS
18PS60OSSTD	60 Fine	Purple	662603 00413
18PS90OSSTD	90 Fine	Black	662603 00415

NS Non-stock; contact your Norton representative for current lead-times.

Marking System

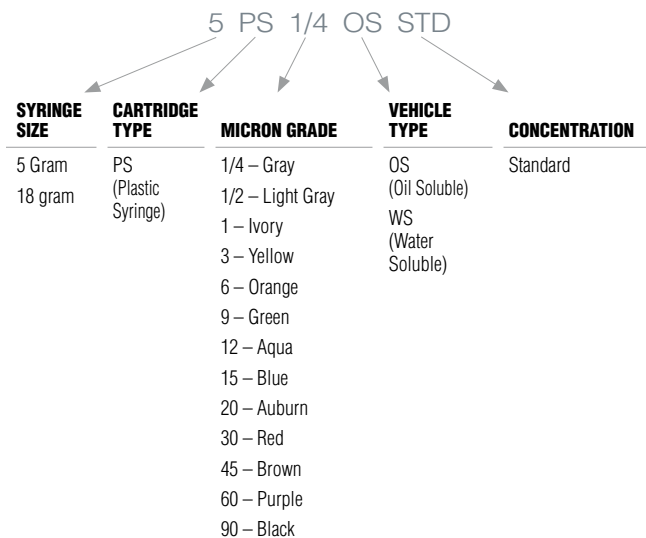

TECH TIP

Diamond Compound Application Guide

APPLICATION	MICRON GRADE	MICRON RANGE	MESH SIZE EQUIV.	COLOR	CONC.
ULTRA FINE Applying finest finishes on metals and ceramics	1/4	(0-1/2)	100,000	Gray	Std.
	1/2	(0-1)	60,000	Lt. Gray	Std.
	1	(0-2)	14,000	Ivory	Std.
SUPER FINE Final finishing of dies, molds, seals, most applications (RMS 4-12)	3	(2-4)	8,000	Yellow	Std.
	6	(4-8)	3,000	Orange	Std.
	9	(8-12)	1,800	Green	Std.
	12	(9-15)	1,500	Aqua	Std.
FINE FINISH Preparatory lapping (RMS 12-20)	15	(12-22)	1,200	Blue	Std.
	20	(15-25)	800	Auburn	Std.
	30	(22-36)	600	Red	Std.
	45	(36-45)	325	Brown	Std.
	60	(54-80)	230	Purple	Std.
	90	(80-100)	170	Black	Std.

the Norton Clipper brand **HITS THE PAVEMENT**

The leader for diamond blades, tools, and light machines for construction and cutting materials is “Redefining Jobsite Muscle – Rugged. Reliable. Affordable.”





With faster cut rates, constant depth of cut, and less downtime, Norton Clipper diamond blades are the choice of professionals versus conventional abrasive blades. Norton Clipper diamond blades are available for high-speed saws, portable hand-held saws, and walk-behind saws. For the full offering of diamond blades, see the Norton Clipper Construction Products Catalog #7719.

- Applications:** Cutting concrete, stone, tile, and other building materials
- Size Range:** 4" – 18"
- Thickness Range:** .080" – .375"
- Segment Height Range:** .210" – .550"
- Abrasive Grain:** Diamond
- Mounting Options:** 1"/20mm universal arbor, 7/8"-5/8"-20mm, DM-7/8"-5/8", 5/8"-11
- Shape:** Type 01
- Machines Used:**



HIGH-SPEED GAS OR ELECTRIC SAW



CIRCULAR SAW



RIGHT-ANGLE GRINDER



WALK-BEHIND SAW

Diamond Blade Rim Types

There are three main diamond blade rim types: segmented, turbo, and continuous rim.

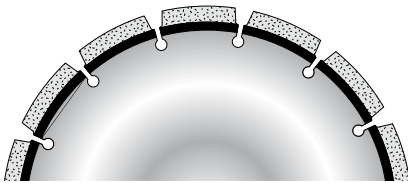

Segmented

- Most aggressive cutting action for general-purpose and masonry applications
- Use when cutting speed and productivity are more important than finish
- Best life, best cut rate, good finish



Turbo

- Aggressive cutting action with a smoother quality of cut than segmented rim blades
- For use on harder materials, such as granite, marble, and stone to reduce chipping
- Better life and cut rate, better finish

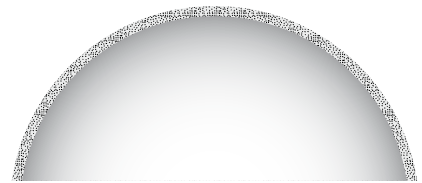

Continuous

- Provides the smoothest of cuts
- Best performance when used wet
- Use on porcelain, tile, marble, and other hard materials requiring a high-quality cut
- Good life, good cut rate, best finish

Material / Application-to-Product Recommendation Guide

Icon	Description	Application
	Multi-Purpose, All Materials	Concrete, reinforced concrete, granite, building materials, thin steel sections, angle iron up to 1/2" material thickness, rebar up to no. 5.
	Natural Stone and Tiles	Ceramic and stone tiles, granite, marble, very hard bricks and other very hard and dense materials.
	Reinforced Concrete and Harder Building Materials	Reinforced concrete, hard bricks, limestone, terrazzo, and other hard materials.
	General Purpose and Masonry Building Materials	Blocks, medium-hard building bricks, paving slabs, concrete roof tiles and other medium-hard materials.
	Asphalt	Asphalt, green concrete, asphalt over concrete, abrasive blocks, mortar and other abrasive materials.

Diamond Performance Tiers

- 5 **Best**
Best Performance
- 4 **Better**
High Performance
- 3 **Value and Good**
Consistent Performance
- 2
- 1

TECH TIP

- Never twist or turn a segmented blade in the cut because it may result in segment breakage
- Never use wet blades dry
- Remove dry blades from cut for 10 seconds of each minute of cut to air cool
- Never operate any saw, wet or dry, without the blade guard



It is the user's responsibility to refer to and comply with ANSI B7.1

For Reinforced Concrete and Harder Building Materials

DRY – Segmented Rim

DUO EVO				
The unique shape of the DUO EVO segments optimizes the angle of attack while enhancing the evacuation of the debris. With a new manufacturing process, the DUO EVO segments provide an exceptional cutting speed for optimum performance and increased life up to 20% over the original DUO EVO design.				
SIZE (D x T x H)	SEGMENT HEIGHT	MAX RPM	PART #	UPC #
12 x .110 x 1"/20mm	.590"	6,300	DUOEVO12110	701846 84217
14 x .118 x 1"/20mm	.590"	5,460	DUOEVO14118	701846 84218
16 x .125 x 1"/20mm	.590"	4,500	DUOEVO16125	701846 93356



DUO				
Our exclusive design has become a dominant name in the market. The unique dual segment per land technology provides excellent cutting speed with low vibration and high comfort of cut. The exclusive arrow shape gullets not only indicate blade direction, but also assist in fast removal of cutting debris. Maximum general purpose performance when cutting medium to low reinforcement, hard materials.				
SIZE (D x T x H)	SEGMENT HEIGHT	MAX RPM	PART #	UPC #
12 x .110 x 1/20mm	.393"	6,300	DUO12110	701846 83611
14 x .110 x 1/20mm	.393"	5,460	DUO14110	701846 83612
14 x .110 x 1/20mm	.393"	5,460	DUO14110 6PK	701846 84430
14 x .110 x 1/20mm	.393"	5,460	DUO14110 12PK	701846 84431
14 x .125 x 1/20mm	.393"	5,460	DUO14125	701846 83613
14 x .125 x 1/20mm	.393"	5,460	DUO14125 6PK	701846 84432
14 x .125 x 1/20mm	.393"	5,460	DUO14125 12PK	701846 84433
16 x .125 x 1/20mm	.393"	4,500	DUO16125	701846 83798



For Asphalt and Abrasive Materials

DRY – Segmented Rim

DUO ASPHALT				
Dry cutting laser-welded blade for asphalt and green concrete. The laser-welded, wear-retardant drop segments extend blade life. Scoop gullets for faster swarf removal increases cut speed. Stroboscopic indicators to control cut depth and show rotation direction.				
SIZE (D x T x H)	SEGMENT HEIGHT	MAX RPM	PART #	UPC #
12 x .110 x 1/20mm	.393"	6,300	DUOASP12125	701846 84543
14 x .125 x 1/20mm	.393"	5,460	DUOASP14125	701846 84315
16 x .125 x 1/20mm	.393"	4,500	DUOASP16125	701846 84544

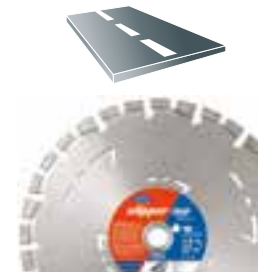

DUO ABRASIVE				
Utilizes the basic characteristics of the original DUO blade and adds a unique segment shape that optimizes the angle of attack while enhancing the evacuation of the particles. The result is an exceptional cutting speed allied with very good performance and life in abrasive materials and concrete block. The bond specification lends additional life when high-speed cutting.				
SIZE (D x T x H)	SEGMENT HEIGHT	MAX RPM	PART #	UPC #
14 x .110 x 1/20mm	.393"	5,460	DUOAB14110	701846 84291
14 x .125 x 1/20mm	.393"	5,460	DUOAB14125	701846 84292



For General-Purpose and Masonry Building Materials

DRY – Segmented Rim

CLASSIC				
The improved bond provides longer life at an economical price in medium-hard materials such as concrete with light to medium reinforcement.				
SIZE (D x T x H)	SEGMENT HEIGHT	MAX RPM	PART #	UPC #
12 x .110 x 1/20mm	.314"	6,300	COHSGP1220	701846 81383
14 x .110 x 1/20mm	.275"	5,460	COHSGP1420	701846 81309
14 x .125 x 1/20mm	.314"	5,460	COHSGP1420P	701846 84268
16 x .125 x 1/20mm	.259"	4,500	COHSGP1620	701846 40356



VALUPLUS				
For value and performance on small- to medium-size jobs. The sintered blade cuts unreinforced soft-to-medium concrete fast on saws up to 13 HP.				
SIZE (D x T x H)	SEGMENT HEIGHT	MAX RPM	PART #	UPC #
12 x .110 x 1/20mm	.393"	6,300	VPHSGP1220	701846 84180
14 x .110 x 1/20mm	.393"	5,460	VPHSGP1420	701846 84181
14 x .110 x 1/20mm	.393"	5,460	VPHSGP1420 20PK	701846 84428



Multi-Purpose, For All Materials

Dry – Segmented Rim  + 



4X4 MAX CUT 

Taking high-speed cutting versatility to an all new level. The same standard features as the 4X4 with its anti-crack gullets and patented depth indicators that not only cool the blade, but also allow the operator to know how deep they are cutting. An all-new bond and diamond specification improves blade life in a wide range of materials while excelling in steel. New segment wear indicators give the operator an idea of remaining blade life.

SIZE (D x T x H)	SEGMENT HEIGHT	MAX RPM	PART #	UPC #
12 x .118 x 1/20mm	.472"	6,300	4X4MC12118	701846 45927
14 x .125 x 1/20mm	.472"	5,460	4X4MC14125	701846 45926



4X4 

Multi-purpose laser welded blade for dry cutting a range of construction materials without sacrificing performance or price. Depth of cut is easily controlled with the patented depth-of-cut indicators cut into the steel core. Anti-crack gullets for enhanced safety cutting steel and metal (up to 5mm thick).

SIZE (D x T x H)	SEGMENT HEIGHT	MAX RPM	PART #	UPC #
12 x .110 x 1/20mm	.393"	6,300	4X412110	701846 84548
14 x .125 x 1/20mm	.393"	5,460	4X414125	701846 84547
16 x .125 x 1/20mm	.393"	4,500	4X416125	701846 45306



3X3 

It's everything expected for high-speed cutting when both performance and price are a factor. The laser welded 3X3 cuts concrete, reinforced concrete, asphalt and abrasive building materials and more. High quality diamond increases the speed of cut on a variety of materials without changing blades. Premium blade characteristics and price point that would normally take multiple sintered blades to achieve.

SIZE (D x T x H)	SEGMENT HEIGHT	MAX RPM	PART #	UPC #
12 x .118 x 1/20mm	.314"	6,300	3X312118	701846 47500
14 x .118 x 1/20mm	.314"	5,460	3X314118	701846 47499



TECH TIP

High-Speed Hand Saw Blades –
Maximum Blade Cutting Depths and
Recommended Operating Speeds

Note: Diamond blade cutting depths listed are approximate. Actual cutting depth will vary with the exact blade diameter or saw type, or the exact diameter of the blade flanges. Cutting depth will also be reduced if saw components extend below the blade flanges.

BLADE DIAMETER	CUTTING DEPTH	MAXIMUM SPEED (RPM)
12"	4"	6,300
14"	5"	5,460
16"	6"	4,500

 It is the user's responsibility to refer to and comply with ANSI B7.1

For Reinforced Concrete and Harder Building Materials

DRY – Crack Chasing

CHARGER				
A heavy V-shaped segment designed with a special bond and diamond content for maximum removal of grout, mortar jointing, crack chasing and crack widening. Fast cutting and long life in abrasive materials using portable tools. Highly competitive to others of its kind in the market.				
SIZE (D x T x H)	SEGMENT HEIGHT	MAX RPM	PART #	UPC #
4 x .375 x 7/8-5/8-20mm	.550"	15,000	CGCC0400	701846 83856
7 x .250 x 7/8-5/8-20mm	.550"	8,730	CGCC0700	701846 83859



For Asphalt and Abrasive Materials

Dry – Tuck Pointing

CLASSIC				
An economical solution for small to medium tuck pointing jobs. High-quality performance for heavy grout removal or mortar jointing. The heavy-duty wide segment reduces wear in abrasive materials.				
SIZE (D x T x H)	SEGMENT HEIGHT	MAX RPM	PART #	UPC #
4 x .250 x 7/8-5/8	.275"	15,000	CHTUCK0400	701846 81776
4-1/2 x .250 x 7/8-5/8	.275"	13,300	CHTUCK0450	701846 81777
5 x .250 x 7/8-5/8	.275"	12,225	CHTUCK0500	701846 81778
7 x .250 x 7/8-5/8	.275"	8,730	CHTUCK0700	701846 81779
8 x .250 x 7/8-5/8	.275"	7,640	CHTUCK0800	701846 81780



For General-Purpose and Masonry Building Materials

Dry – Segmented Rim

CHARGER				
High-performance dry cutting of a variety of materials. The segment specification allows extended life and fast cut for medium to large jobs.				
SIZE (D x T x H)	SEGMENT HEIGHT	MAX RPM	PART #	UPC #
4 x .080 x 7/8-5/8-20mm	.393"	15,000	CGDSEG0400	701846 81505
4-1/2 x .080 x 7/8-5/8-20mm	.393"	13,300	CGDSEG0450	076607 04021
5 x .080 x 7/8-5/8-20mm	.393"	12,225	CGDSEG0500	701846 82851
6 x .080 x 7/8-5/8-20mm	.393"	10,185	CGDSEG0600	701846 83820
7 x .090 x DM-7/8-5/8	.393"	8,730	CGDSEG0700	076607 04020
8 x .090 x DM-7/8-5/8	.393"	7,640	CGDSEG0800	701846 81513
9 x .090 x 7/8-5/8"	.393"	6,600	CGDSEG0900	701846 69483



VALUPLUS				
For value and performance on small- to medium-size jobs cutting soft abrasive materials like brick and tile. The sintered rim delivers a quality cut and good life.				
SIZE (D x T x H)	SEGMENT HEIGHT	MAX RPM	PART #	UPC #
4 x .080 x 7/8-5/8-20mm	.315"	15,000	VPSEG0400	701846 84098
4-1/2 x .080 x 7/8-5/8-20mm	.315"	13,300	VPSEG0450	701846 84099
7 x .090 x DM-7/8-5/8	.315"	8,730	VPSEG0700	701846 84100



Dry – Turbo Rim

CHARGER				
Combines the characteristics of a standard Charger blade with a turbo rim configuration for cutting hard, dense materials with minimal effort. A better bond and diamond concentration for maximum cutting speed, life and quality of cut.				
SIZE (D x T x H)	SEGMENT HEIGHT	MAX RPM	PART #	UPC #
4 x .080 x 7/8-5/8-20mm	.393"	15,000	CGTURB0400	076607 05475
4-1/2 x .080 x 7/8-5/8-20mm	.393"	13,300	CGTURB0450	076607 04023
5 x .080 x 7/8-5/8-20mm	.393"	12,225	CGTURB0500	701846 82853
7 x .090 x DM-7/8-5/8	.393"	8,730	CGTURB0700	076607 04022
8 x .090 x DM-7/8-5/8	.393"	7,640	CGTURB0800	701846 81512



For Natural Stone and Tiles

Dry – Continuous Rim

CLASSIC				
An economical solution for small- to medium-size jobs cutting softer ceramic tile and stone materials with efficient cutting ability.				
SIZE (D x T x H)	SEGMENT HEIGHT	MAX RPM	PART #	UPC #
4 x .080 x 7/8-5/8-20mm	.275"	15,000	CON4DT	076607 02793
4-1/2 x .080 x 7/8-5/8-20mm	.275"	13,300	CON45DT	076607 01194
7 x .090 x DM-7/8-5/8	.275"	8,730	CON7DT	076607 02788



For Reinforced Concrete and Harder Building Materials

WET – Medium Aggregates

CHARGER					
The steel core is designed to keep the cut straight while the .410" segment height prolongs cutting wear. Suitable for cutting medium aggregates with up to 35 HP walk-behind saws.					
SIZE (D x T x H)	SEGMENT HEIGHT	MAX RPM	POWER	PART #	UPC #
14 x .125 x 1	.410"	4,365	35hp	CGWCMD1412	70184681366
18 x .125 x 1	.410"	3,395	35hp	CGWCMD1812	70184681368

CLASSIC					
Laser welded blade at an economical price for general purpose cutting of cured concrete, medium-hard aggregate and no steel reinforcement. The bond and diamond combination allow fast cutting action on limited horse powered walk-behind saws.					
SIZE (D x T x H)	SEGMENT HEIGHT	MAX RPM	POWER	PART #	UPC #
14 x .125 x 1	.326"	4,365	35hp	CHWCGP1412	70184681359
18 x .125 x 1	.326"	3,395	35hp	CHWCGP1812	70184681361



For Asphalt and Abrasive Materials

DRY – Green/Cured Concrete

GMAX – MULTI-PURPOSE					
Designed specifically for our GC55/GC25E down-cut green concrete push saw, the GMAX Multi-Purpose blade is excellent in both green and cured concrete. The unique segment specification and anchor slot gullets allow this blade to be used in a variety of applications with outstanding results.					
SIZE (D x T x H)	SEGMENT HEIGHT	MAX RPM	POWER	PART #	UPC #
8 x .095 x 7/8-5/8	.372"	8,730	6hp	NXDGRN0895	70184683758
9 x .110 x 7/8-5/8	.372"	6,600	6hp	EE9110	70184675125
10 x .110 x 1-7/8-5/8	.372"	6,115	6hp	EE10110	70184684508



WET – Asphalt

CHARGER					
For large road and construction jobs with saws up to 35 HP. Higher diamond content increases productivity and offers faster cutting and longer life in asphalt and green concrete applications.					
SIZE (D x T x H)	SEGMENT HEIGHT	MAX RPM	POWER	PART #	UPC #
14 x .125 x 1	.327"	4,365	35hp	CGWASP1412	70184681478
18 x .125 x 1	.307"	3,395	35hp	CGWASP1812	70184681479

CLASSIC					
An economical choice for fast cutting and good life when performing jobs in a variety of abrasive materials such as green concrete and asphalt on saws up to 35 HP.					
SIZE (D x T x H)	SEGMENT HEIGHT	MAX RPM	POWER	PART #	UPC #
14 x .125 x 1	.326"	4,365	35hp	CHWASP1412	70184681375
18 x .125 x 1	.326"	3,395	35hp	CHWASP1812	70184681376



TECH TIP

Walk-Behind Saw Blades –
Maximum Blade Cutting Depths and
Recommended Operating Speeds

Note: Diamond blade cutting depths listed are approximate. Actual cutting depth will vary with the exact blade diameter or saw type, or the exact diameter of the blade flanges. Cutting depth will also be reduced if saw components extend below the blade flanges.

BLADE DIAMETER	CUTTING DEPTH	IDEAL SPEED (RPM)	MAXIMUM SPEED (RPM)
8"	2"	4,536	7,640
9"	2-1/2"	2,640	6,600
10"	3"	2,446	6,115
14"	4-5/8"	2,592	4,365
18"	6-5/8"	2,016	3,395

It is the user's responsibility to refer to and comply with ANSI B7.1















Norton Clipper cup grinders are available in a range of specifications and diameters providing a solution for a number of applications in the building and construction industry. There are many benefits to diamond grinding. It's very fast, low-cost and creates little noise compared to other concrete cutting options. It has become a very popular choice in the commercial construction and DIY home improvement industries.

- Applications:** Used on right angle grinders to grind concrete, stone and masonry materials.
- Size Range:** 4" – 7"
- Segment Height:** .177", .210"
- Range:**
- Abrasive Grain:** Diamond
- Mounting Options:** 5/8"-11 attachment optimized for all popular angle grinders, 7/8-5/8"-20mm
- Options:** Standard – single row or double row available
iHD (Infiltrated High-Density) has thicker body, larger ventilation holes for better cooling
- Machines Used:**  RIGHT-ANGLE GRINDER



General-Purpose and Masonry Building Materials

Dry – Cup Grinder  

3X3 WITH iHD TECHNOLOGY             













The 3X3 cup grinder ensures very high material removal rate, extreme comfort while working without vibrations and a self-sharpening feature. These new iHD cups offer the best finishing and longest life even on softer, more abrasive materials.

SIZE (D x H)	SEGMENT HEIGHT	MAX RPM	PART #	UPC #
4 x 5/8"-11	.177"	15,000	3X3CG0400	701846 01763
5 x 5/8"-11	.177"	12,225	3X3CG0500	701846 01766
7 x 5/8"-11	.177"	8,730	3X3CG0700	701846 01769

CHARGER WITH iHD TECHNOLOGY            

The Charger cup grinder ensures a high material removal rate and more comfortable work. These new iHD cups provide a better finish and long life on a wide range of materials.

SIZE (D x H)	SEGMENT HEIGHT	MAX RPM	PART #	UPC #
4 x 5/8"-11	.177"	15,000	CGCG0400	701846 01762
5 x 5/8"-11	.177"	12,225	CGCG0500	701846 01765
7 x 5/8"-11	.177"	8,730	CGCG0700	701846 01768

CLASSIC WITH iHD TECHNOLOGY            

The Classic cup grinder provides efficient material removal rate thanks to the small contact surfaces of the segments. The cups also have flat sides to avoid damaging walls or ceilings during flush grinding.

SIZE (D x H)	SEGMENT HEIGHT	MAX RPM	PART #	UPC #
4 x 5/8"-11	.177"	15,000	CCCG0400	701846 01761
5 x 5/8"-11	.177"	12,225	CCCG0500	701846 01764
7 x 5/8"-11	.177"	8,730	CCCG0700	701846 01767

CLASSIC            

Available in a range of sizes and segment designs for optimum performance by life or by speed. Ideal for leveling all types of masonry materials, brick, block, concrete and stone. Strategically placed hole designs help ventilate dust from the surface to extend the life of the cups.

SIZE (D x H)	SEGMENT HEIGHT	MAX RPM	PART #	UPC #
Single Row for Fast Stock Removal				
4 x 7/8-5/8-20mm	.210"	15,000	CHSCPH0400	701846 82585
5 x 7/8-5/8-20mm	.210"	12,225	CHSCPH0500	701846 84035
7 x 7/8-5/8-20mm	.210"	8,730	CHSCPH0700	701846 82594
4 x 5/8"-11	.210"	15,000	CHSCPT0400	701846 82555
5 x 5/8"-11	.210"	12,225	CHSCPT0500	701846 84036
7 x 5/8"-11	.210"	8,730	CHSCPT0700	701846 82593
Double Row for Long Life, Smooth Finish				
4 x 7/8-5/8-20mm	.210"	15,000	CHDCPH0400	701846 82588
5 x 7/8-5/8-20mm	.210"	12,225	CHDCPH0500	701846 84037
7 x 7/8-5/8-20mm	.210"	8,730	CHDCPH0700	701846 82596
4 x 5/8"-11	.210"	15,000	CHDCPT0400	701846 82586
5 x 5/8"-11	.210"	12,225	CHDCPT0500	701846 84038
7 x 5/8"-11	.210"	8,730	CHDCPT0700	701846 82595

Accessories

VACUUM SHROUD KIT

The Vacuum Shroud's design creates a cyclonic affect extracting dust and debris from the work surface into the support vacuum. This prolongs the life of the grinding cup and grinder and provides a smoother surface while decreasing the chance of dust particle inhalation.

DESCRIPTION	UPC #
Kit includes: one shroud, five different adapter rings to fit most popular right-angle grinders, and one 7" Norton Clipper Classic single row cup wheel	701846 41039





Core bits are cutting tools used to remove a cylindrically shaped piece of material. A core drill is designed to cut a hole and remove a core sample or to drill a hole without leaving material behind. Diamond core bits have diamond cutting tips and are frequently used for drilling in materials such as concrete, stone, and asphalt.

- Applications:** Used on core drills in materials such as concrete, stone and other hard materials
- Size Range:** 2" – 10"
- Segment Height Range:** .254", .393"
- Abrasive Grain:** Diamond
- Mounting Options:** 1-1/4"-7 threads
- Machines Used:**



Reinforced Concrete and Harder Building Materials

WET – Hard Aggregates



PARADIGM Premium diamond in the turbo segment permits the core to penetrate quickly and efficiently into the toughest cured concrete, for significantly increased performance. The 14" tube length with 1-1/4"-7 threads fits a wide range of core drill mounting arbors.

SIZE IN INCHES	SIZE IN MM	SEGMENT HEIGHT	MAX RPM	PART #	UPC #
2"	51mm	.490"	2,000	PDBIT0200	701846 01410
2-1/2"	64mm	.490"	1,300	PDBIT0250	701846 01411
3"	76mm	.490"	1,300	PDBIT 0300	701846 01412
3-1/2"	89mm	.490"	1,300	PDBIT0350	701846 01413
4"	102mm	.490"	1,000	PDBIT0400	701846 01414
4-1/2"	114mm	.490"	800	PDBIT0450	701846 01415
5"	127mm	.490"	800	PDBIT0500	701846 01416
6"	152mm	.490"	665	PDBIT0600	701846 01417
7"	178mm	.490"	600	PDBIT0700	701846 01418
8"	203mm	.490"	500	PDBIT0800	701846 01419
10"	254mm	.490"	400	PDBIT1000	701846 01706



CLASSIC Economical choice for use in harder concrete with heavy reinforcement and masonry materials with good performance.

SIZE IN INCHES	SIZE IN MM	SEGMENT HEIGHT	MAX RPM	PART #	UPC #
2"	51mm	.350"	2,000	CHBIT0200	701846 82762
3"	76mm	.350"	1,300	CHBIT0300	701846 82765
4"	102mm	.350"	1,000	CHBIT0400	701846 82767
6"	152mm	.350"	665	CHBIT0600	701846 82771
8"	203mm	.350"	500	CHBIT0800	701846 82773
10"	254mm	.350"	400	CHBIT1000	701846 82774

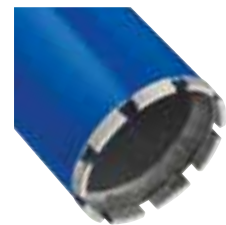

TECH TIP

Core Bits – Minimum and Maximum Recommended Operating Speeds

BIT DIAMETER	MINIMUM RPM	IDEAL SPEED (RPM)	MAXIMUM RPM
1"	2,400	3,200	4,000
2"	1,200	1,600	2,000
3"	800	1,050	1,300
4"	600	800	1,000
5"	475	640	800
6"	400	530	665
7"	340	450	600
8"	300	400	500
10"	240	320	400

Note: For half inch increments, go to the next larger bit diameter.



It is the user's responsibility to refer to and comply with ANSI B7.1



High-Speed Gas Saws

No more pre-mixing oil and fuel – the patented iLube option automatically controls mixing for maximum efficiency, and the saw drops to idle speed when the oil is low – eliminating possible machine damage

Walk-Behind Saws

Proven, robust and functional for ideal user comfort. The professionals' choice for outstanding walk behind cutting performance, wet or dry.

Masonry Saws

Norton introduced the first masonry saw over 70 years ago and they have become the industry standard for masons worldwide.

For the full line of quality Norton Clipper equipment, please contact your local Norton sales representative

High-Speed Gas Saws

CP500 SERIES HIGH-SPEED SAWS

The Norton Clipper CP500 high-speed cut-off saw might be new to the market, but it's destined to be an asset on any crew. It's fully designed with the user in mind to not only cut a smooth, fast track, but it's also fully equipped to handle the everyday performance of any jobsite with unremitting durability and reliability. Select a standard model or upgrade to the world's first patented automatic lubrication system, Norton Clipper iLube.

The patented iLube option automatically controls mixing of oil and fuel for maximum efficiency. An electronic sensor will indicate a low oil level and adjust the engine to idle to prevent engine damage.

DESCRIPTION	SHAFT RPM	PART #	UPC #
12" Standard High-Speed Cut-Off Saw	4,500	CP512-300	701846 47559
12" iLube High-Speed Cut-Off Saw	4,500	CP512-300i iLube	701846 47561
14" Standard High-Speed Cut-Off Saw	4,500	CP514-350	701846 47563
14" iLube High-Speed Cut-Off Saw	4,500	CP514-350i iLube	701846 47565

ACCESSORIES

High-Speed Saw Wheel Kit	005101 09845
High-Speed Saw Tool Kit	005101 09846



Walk-Behind Push Saws



GC55 EARLY ENTRY/GREEN SAW

With a compact, light-weight design backed by the reliable Honda 5HP gasoline engine, the GC55 early entry saw is intended for a variety of applications. From green, cured or decorative concrete cutting to expansion joints, the features of this small push saw are hard to beat in a single saw. The low, wide profile of the frame, along with the front mount blade, contribute to producing a more disciplined cut.

UPC #	MOTOR	WEIGHT	GUARD
701846 30005	Honda GX160	115 lbs	10"



C1318P GASOLINE SAW

The next generation of 13HP saws. The C1318P features shock-absorbing handle bars. The new sleek design of the water tank, with increased capacity and improved securing, adds an additional 1.5 gallons of water over the cut. And, a newly-designed belt tensioning system helps keep the saw cutting true and true. All these features, coupled with the Honda 13HP engine, make the C1318P the premiere choice for rental and service work.

UPC #	MOTOR	WEIGHT	GUARD
701846 42453	Honda GX390	220 lbs	18"



C13PE GASOLINE SAW

Rental equipment has to withstand any and all conditions by user and application. For that reason, the Norton Clipper C13PE or CP14PE suits any rental fleet that both the novice and expert will appreciate to hold-up through tough situations. The 18" blade guard, ride-on water system and quick-release blade guard lock all keep safety in mind while the rugged frame, powerful engine and easy-to-use console makes cutting a breeze.

UPC #	MOTOR	WEIGHT	GUARD
701846 47524	Honda GX390	220 lbs	18"

Large Masonry Saws

BBL BLOCKBUSTER LARGE MASONRY SAWS

Having introduced the first masonry saw over 70 years ago, the Norton Clipper BBL heavy-duty block saws have become the industry standard for masons worldwide. These models are equipped with single-phase electric motors and come with a blade capacity of 14" or 20". Extended water pan and open back frame allow cutting of larger materials. The balanced cutting head makes for effortless cutting depth positioning. Having a rugged all-steel frame design with forklift brackets allows these saws to resist twisting and damage during transport around a job site. For other sizes and horsepower machines, or for gasoline-powered versions, contact your Norton sales representative.

DESCRIPTION	HP	PART #	UPC #
BBL547 Blockbuster Saw with Baldor electric motor; 14" blade guard capacity	5	BBL547	701846 83211
BBL527 Blockbuster Saw with Baldor electric motor; 20" blade guard capacity	5	BBL527	701846 83150

ACCESSORIES

Electric Water Pump – PE-1	701846 68392
Conveyor Cart Replacement for BBL	003100 07390



Electric Water Pump



Conveyor Cart Replacement



Compact Masonry Saws

BBC BLOCKBUSTER COMPACT MASONRY SAWS

Combines the performance of a full size masonry saw with the convenience of portability. Also available in gas or electric versions, the BBC saws have a rugged jig-welded frame, durable enough for even the heaviest work load. Standard rear wheel dolly design and removable legs make transport and set-up easy. For other sizes and horsepower machines, or for gasoline-powered versions, contact your Norton sales representative..

DESCRIPTION	HP	PART #	UPC #
BBC157 Blockbuster Saw with Baldor electric motor; 14" blade guard capacity	1.5	BBC157	701846 82488
BBC207 Blockbuster Saw with Baldor electric motor; 14" blade guard capacity	2	BBC207	701846 82501
BBC207 Blockbuster Saw with Baldor electric motor; 20" blade guard capacity	3	BBC307	701846 30011
BBC547 Blockbuster Saw with Honda gasoline motor; 14" blade guard capacity	5.5	BBC547	701846 82175
BBC507 Blockbuster Saw with Honda gasoline motor; 20" blade guard capacity	5.5	BBC507	701846 30012

ACCESSORIES

Electric Water Pump – PE-1	701846 68392
Conveyor Cart Replacement for BBC	003100 07367



Mini Masonry Saws

BBM BLOCKBUSTER MINI MASONRY SAWS

The innovative design of these small masonry saws has been copied many times due to its compact, all-steel unibody construction, giving the best weight-to-strength distribution. A 14" blade capacity and ergonomically-designed, three-position locking, cutting head provides a safe, clear view of the work area. Whether your choice is the 3HP brush motor or the 1.5HP induction motor for heavier commercial use, both come with features such as overload protection, garden hose connection and a channeled-flow water pan to direct dust and slurry away from the operator.

DESCRIPTION	HP	PART #	UPC #
Blockbuster Mini Masonry Saw with AC universal motor; gear drive	3	BBM307	701846 00684
Blockbuster Mini Masonry Saw with Induction motor; belt drive	2	BBM158	701846 26327

ACCESSORIES

Vacuum Adaptor Kit (includes: back splash, adaptor and hardware)	701846 00753
Wet Kit	701846 00704
Stand	701846 00691



Wet Kit



Stand



All saws on this page come equipped with genuine Norton Clipper diamond blades.

get wired
FOR SUCCESS

Our broad wire brush offering includes the shapes, wire configurations and filament materials you'll need for heavy- to light-duty brushing applications.





Our Norton wire brush broad offering includes all the basic shapes and configurations. Informative, attractive packaging clearly explains dimensions, structure, safety and machine usage. All brushes are individually clamshell packaged unless otherwise noted. When using wire brushes, be sure to comply with ANSI B165 "Power-Driven Brushing Tools: Safety Requirement for the Design, Care and Use."

Applications:

Cleaning rust, scale and dirt; light deburring; edge blending; roughening for adhesion; finishing for appearance; finish preparation prior to plating or painting

Shapes:

Cup, saucer cup, wheel, joint/crack, end brush, hand brush

Wire Design:

Twist knot, crimped, and stringer bead

Other:

Color-coded for easy identification:



Machine Used:

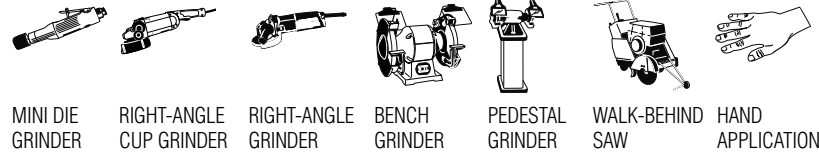

Why Use Wire Brushes vs. Other Brushes, Coated Abrasive, and Surface-Cleaning Products

Norton Wire brushes remove rust and oxidations, paint, slag, weld spatter and other unwanted surface contaminants, without removing any base material. Other products can remove base material along with the surface contaminant. Our flexible wire brushes are able to clean hard-to-reach places and conform to irregular surfaces, which more rigid products cannot do.

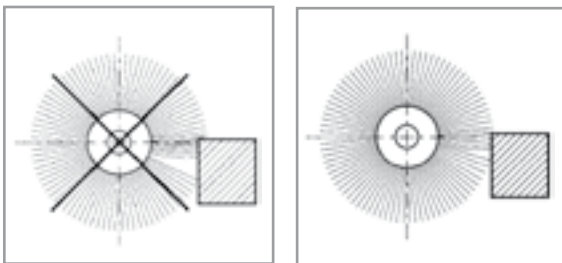

Let the tip of the wire brush do the work – operate the brush with the lightest pressure. If heavy pressure is used, wires will be overstressed, resulting in a wiping action, which, if continued, creates wire fatigue and will shorten brush life. Reversing the rotation periodically sharpens the wire tips for faster cutting action and longer life. Use finest suitable wire size.



Crimped Standard Twist Knot Stringer Bead Twist Knot



Workpiece Material	Carbon Steel	Stainless Steel	Brass	Nylon
ALUMINUM		■	■	■
BRASS		■	■	■
COPPER		■	■	■
IRON	■		■	■
PLASTIC			■	■
CARBON STEEL/METAL	■		■	■
STAINLESS STEEL		■	■	■
WOOD	■	■	■	■

TECH TIP

When to Use Crimped Wire vs. Standard Twist Knot vs. Stringer Bead Twist Knot Brushes

Crimped Wire Brushes

Crimped wire brushes' individual filaments are supported only by each other – creating extra flexibility.

Ideal for work on irregular surfaces, finer surface finishing, and light- to medium-duty contaminant removal applications.

Standard Twist Knot Wire Brushes

Ensuring longer life, making them the choice for more aggressive applications requiring higher-impact action, and a rougher surface finish.

Standard twist knot brushes are made with straight wire filaments that are twisted together to make more rigid rope- or cable-like pieces.

Stringer Bead Twist Knot Wire Brushes

Stringer bead twist knots (vs. standard twist knots) are more tightly twisted to the end of the knot, creating a narrower face and highest-impact action.

The choice for tough weld scale cleaning, removing the bead scale that occurs at the initial joining of two sections of pipe, root and hot weld pass cleaning, and the most aggressive brushing applications.

Wire Diameter

Choose the appropriate wire brush wire diameter for the job

- Very fine to fine wire for light-duty applications
- Medium to coarse wire for heavy-duty applications

Wire	Coarse		Medium to Coarse		Medium		Fine		Very Fine	
DIAMETER IN INCHES	.032	.020	.020	.015	.012	.0104	.010	.008	.006	.005
DIAMETER IN MM	.80	.50	.50	.37	.30	.26	.25	.20	.15	.13

TECH TIP

Trim Length

Choose the appropriate trim length for the job. "Trim Length" equals the amount of usable filament:

- Longer trim lengths are more flexible, making them the choice for irregular surfaces
- Shorter trim lengths are fast acting and more rigid, so better for more severe applications

TECH TIP

Filament Do's and Don'ts

Excessive pressure bends and could break brush filaments. Instead of increasing the pressure applied, consider:

- A more aggressive brush:
 - Increasing wire diameter
 - Shorter trim length
- Different brush type, e.g. twist knot versus crimped wire
- Increasing RPM without exceeding the MAX RPMs marked on the brush



Better choice for deburring, removing rust, paint, corrosion and weld spatter from metal surfaces

BLUEFIRE WIRE BRUSHES

- Perfect for removing rust, scale, paint, and dirt from metal and other surface
- Available in a variety of brush types and sizes for large flat areas to small, tight spaces
- Durable design provides a uniform finish while offering the longest life

Good choice for removing rust oxidation, paint, slag and weld spatter without removing base material

GEMINI WIRE BRUSHES

- Ideal low-impact solution for refining surfaces without removing any base material
- Flexible design for cleaning hard-to-reach places and conforming to irregular surfaces, which more rigid products cannot do
- Economically priced yet solid-performing to complement your projects perfectly while bringing real savings to the bottom line





EXPANDED OFFERING

Deburring; roughing; cleaning rust, scale, paint and oxidation; cleaning corners, recesses, and other hard-to-reach areas and removing concrete and large surfaces

WIRE CUP BRUSHES

- Used on right angle cup grinders
- Twist Knot style for heavy-duty applications
- Crimped cup for light- to medium-duty applications



Twist Knot Wire Saucer Cup Brushes



TIER:	BETTER	BETTER
TRADENAME:	BLUEFIRE	BLUEFIRE
WIRE TYPE:	CARBON	STAINLESS

SIZE	TRIM LENGTH	MAX. RPM	STD. PKG.	PART #	PART #
Twist Knot Wire Saucer Cup Brushes - Single Row - With Arbor Hole					
4" x 0.020" x 5/8"-11	7/8"	15,000	5	662528 33483	
5" x 0.020" x 5/8"-11	1-1/8"	12,500	10	662528 35585	662528 35586

Twist Knot Wire Cup Brushes

- Their more rigid structure allows efficient, high-impact cutting and cleaning on more demanding applications.
- Single row construction limits flaring of the brush on corners and angles



TIER:	BETTER	BETTER	BETTER	BETTER	GOOD	GOOD
TRADENAME:	BLUEFIRE	BLUEFIRE	BLUEFIRE	BLUEFIRE	GEMINI	GEMINI
WIRE TYPE:	CARBON	STAINLESS	CARBON	CARBON	CARBON	STAINLESS

SIZE	TRIM LENGTH	MAX. RPM	STD. PKG.	PART #	PART #	PART #	PART #	PART #	PART #
Twist Knot Wire Cup Brushes - Single Row - With Arbor Hole									
2-3/4" x 0.014" x 5/8"-11	3/4"	14,000	1	699573 70106	699573 70107				
2-3/4" x 0.014" x 5/8"-11	7/8"	14,000	5			662528 38870	662528 38871		
2-3/4" x 0.014" x 5/8"-11	1"	14,000	5			662528 39109			
2-3/4" x 0.020" x 5/8"-11	3/4"	14,000	5	699366 53336	699366 53340				
2-3/4" x 0.020" x 5/8"-11	7/8"	14,000	5			662528 38872			
2-3/4" x 0.020" x 5/8"-11	1"	14,000	10			662528 39033	662528 38812		
2-3/4" x 0.020" x 1/2"-13	3/4"	14,000	1	699573 70108					
2-3/4" x 0.020" x 1/2"-24	3/4"	14,000	1	699573 70109					
2-3/4" x 0.020" x M10 x 1.25	3/4"	15,000	5	699366 53338					
3" x 0.020" x 5/8"-11	7/8"	14,000	5			662528 38835	662528 39127		
3" x 0.020" x M10	7/8"	14,000	5			662528 39075			
3-1/2" x 0.020" x 5/8"-11	7/8"	13,000	5			662528 38813			
3-1/2" x 0.020" x 5/8"-11	1-3/8"	13,000	5			662528 38868			
3-1/2" x 0.023" x 5/8"-11	7/8"	13,000	1	699573 70110					
4" x 0.014" x 5/8"-11	1-1/16"	9,000	1	699573 70111					
4" x 0.014" x 5/8"-11	1-1/4"	9,000	5			662528 39060			
4" x 0.020" x 5/8"-11	1-1/8"	9,000	10			662528 39103			
4" x 0.020" x 5/8"-11 with bridle	1-1/16"	9,000	5	699366 53345	662528 33947				
4" x 0.023" x 5/8"-11	1-1/4"	9,000	5			662528 39090			
6" x 0.014" x 5/8"-11	1-3/8"	6,600	1	699573 70112					
6" x 0.014" x 5/8"-11	1-3/8"	6,600	5			662528 39037			
6" x 0.020" x 5/8"-11	1-3/8"	6,000	5	699366 05965	662533 71115	662528 39104	662528 39129		
6" x 0.023" x 5/8"-11	1-3/8"	6,000	5			662528 39091			
6" x 0.035" x 5/8"-11	1-3/8"	6,000	5	699366 02003					
Twist Knot Wire Cup Brushes - Single Row - With Arbor Hole and Protective Guard									
2-3/4" x 0.020" x 5/8"-11	3/4"	15,000	5			662528 33492			
4" x 0.020" x 5/8"-11	1-1/8"	9,000	5			662528 33496			
5" x 0.020" x 5/8"-11	1-1/8"	6,500	5			662528 33497			
Twist Knot Wire Cup Brushes - Double Row - With Arbor Hole									
6" x 0.020" x 5/8"-11	1-3/8"	6,000	5			699366 53346			

Crimped Wire Cup Brushes

For light- to medium-duty brushing applications on flat or irregular surfaces, and bevel buffing where added flexibility is needed; fast-cutting and flexible, with heavy wire fill

- Machine for cups with arbor holes: right angle cup grinder
- Machine for shank mounted cups: straight in-line grinder, pencil grinder



TIER: **BETTER**
 TRADENAME: **BLUEFIRE**
 WIRE TYPE: **CARBON**

SIZE	TRIM LENGTH	MAX. RPM	STD. PKG.	PART #
High Performance Cable Crimped Wire Cup Brushes - With Arbor Hole and Protective Guard				
3" x (12 x 0.009") x 5/8"-11	7/8"	15,000	5	662528 33493
4" x (12 x 0.009") x 5/8"-11	1-3/16"	9,000	5	662528 33494



TIER: **BETTER** **BETTER** **GOOD**
 TRADENAME: **BLUEFIRE** **BLUEFIRE** **GEMINI**
 WIRE TYPE: **CARBON** **STAINLESS** **CARBON**

SIZE	TRIM LENGTH	MAX. RPM	STD. PKG.	PART #	PART #	PART #
Crimped Wire Cup Brushes – With Arbor Hole						
2-3/4" x 0.014" x 5/8"-11	1"	14,000	5			662528 38856
2-3/4" x 0.020" x 3/8"-24	1"	14,000	5			662528 39080
3" x 0.014" x 5/8"-11	13/16"	14,000	5			662528 39076
3" x 0.014" x 5/8"-11	7/8"	14,000	5	699366 53341	662528 36362	
3" x 0.014" x 5/8"-11	1"	14,000	10			662528 39034
4" x 0.014" x 5/8"-11	1-3/16"	9,000	5	699366 53347		
4" x 0.014" x 5/8"-11	1-1/8"	9,000	10			662528 39121
4" x 0.020" x 5/8"-11	1-3/16"	9,000	5		662528 43844	
5" x 0.014" x 5/8"-11	1-3/8"	8,000	5			662528 39105
6" x 0.014" x 5/8"-11	1-1/8"	6,000	5	699366 53348		
6" x 0.020" x 5/8"-11	1-1/8"	6,000	5	699366 53349		



TIER: **GOOD** **GOOD** **GOOD**
 TRADENAME: **GEMINI** **GEMINI** **GEMINI**
 WIRE TYPE: **CARBON** **STAINLESS** **BRASS**

SIZE	TRIM LENGTH	MAX. RPM	STD. PKG.	PART #	PART #	PART #
Crimped Wire Cup Brushes - Shank Mounted						
5/8" x 0.005" x 1/8"	1/4"	37,000	100			662528 39087
1-3/4" x 0.006" x 1/4"	1/2"	13,000	10	662528 38857		
1-3/4" x 0.012" x 1/4"	1/2"	13,000	10	662528 38858		
1-3/4" x 0.012" x 1/4"	3/4"	13,000	12	662528 39028		
2" x 0.010" x 1/4"	5/8"	10,500	12		662528 38859	
2" x 0.012" x 1/4"	5/8"	13,000	12	662528 39110		
2-1/4" x 0.014" x 1/4"	5/8"	4,500	10	662528 38860		

Applications range from the toughest, more aggressive surface cleaning applications, including removing weld scale, spatter, extra-heavy rust and corrosion, cleaning pipe joints, or surface roughening to light- to medium- duty surface cleaning and contaminant removal



EXPANDED OFFERING

WIRE WHEEL BRUSHES

- Available in Standard Twist Knot, Stringer Bead Twist Knot, and Crimped
- See specific machines for each wire wheel below

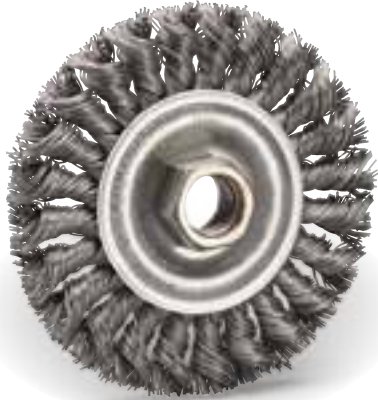

Standard Twist Knot Wire Wheel Brushes

Our twist knot wire design provides added rigidity for extra cutting and cleaning power, and a rougher surface finish.

- Wheel brushes with arbor holes perform well on more aggressive applications requiring high-impact action: tough welding and metal fabrication applications, including removing weld scale, spatter, extra-heavy rust.
- These shank-mounted wheel brushes are used for small-to-medium-duty jobs requiring some flexibility and lighter brushing action for corrosion, or surface roughing applications. These brushes are used on straight shaft, die, pencil grinders, drills and right angle grinders.



TIER:	BETTER	BETTER	BETTER	GOOD	GOOD
TRADENAME:	BLUEFIRE	BLUEFIRE	BLUEFIRE	GEMINI	GEMINI
WIRE TYPE:	CARBON	STAINLESS	PIPELINE	CARBON	STAINLESS

SIZE	FACE WIDTH	TRIM LENGTH	MAX. RPM	STD. PKG.	PART #	PART #	PART #	PART #	PART #
Standard Twist Knot Wire Wheel Brushes – With Arbor Hole									
3" x 0.15" x 1/2"-3/8"	3/8"	5/8"	20,000	6	699366 53314				
3" x 0.014" x 3/8"	3/8"	5/8"	25,000	1				662528 39021	
4" x 0.014" x 5/8"-11	5-16"	7/8"	20,000	5				662528 39011	
4" x 0.014" x 5/8"-11	1/2"	7/8"	20,000	10				662528 39052	
4" x 0.020" x 5/8"-11	1/4"	3/4"	20,000	10					662528 39132
4" x 0.020" x 5/8"-11	1/2"	3/4"	20,000	5	662528 38300				
4" x 0.020" x 5/8"-11	1/2"	7/8"	20,000	10				662528 39035	662528 39020
4" x 0.020" x 5/8"-11	1/2"	7/8"	20,000	5				662528 39078	
4" x 0.020" x 5/8"-11	9/16"	7/8"	20,000	10				662528 39019	
4-1/2" x 0.020" x 5/8"-11	1/2"	1"	20,000	5	699366 06275				
4-1/2" x 0.020" x 5/8"-11 (black hub)	1/2"	1"	20,000	6			662528 40466		
4-1/2" x 0.020" x 5/8"-11	1/2"	1"	20,000	6	699366 53331				
4-1/2" x 0.020" x 5/8"-11	1/2"	1"	20,000	5		699366 53333			
5" x 0.020" x 5/8"-11	1/2"	1"	12,500	5	662528 33487	662528 33488			
6" x 0.014" x 5/8"-11	1/2"	1-1/2"	12,000	5				662528 39014	
6" x 0.020" x 5/8"-11	1/2"	1-3/8"	12,000	5	699366 53352	662533 71540			
6" x 0.020" x 5/8"-11	5/8"	1-1/4"	12,000	5				662528 39107	662528 39594
6" x 0.020" x 5/8"-11	1/2"	1-3/8"	12,000	5	699366 53327				
6" x 0.025" x 5/8"-11	5/8"	1-1/4"	9,000	5				662528 39593	



TIER:	GOOD
TRADENAME:	GEMINI
WIRE TYPE:	CARBON

SIZE	FACE WIDTH	TRIM LENGTH	MAX. RPM	STD. PKG.	PART #
Standard Twist Knot Wire Wheel Brushes - Shank Mounted					
3" x 0.014" x 1/4"	1/4"	5/8"	25,000	12	662528 39015
3-1/4" x 0.014" x 1/4"	3/8"	5/8"	25,000	10	662528 39031
4" x 0.014" x 1/4"	1/2"	7/8"	25,000	8	662528 39032



Stringer Bead Twist Knot Wire Wheel Brushes

The choice for toughest weld scale cleaning; removing the bead scale that occurs at the initial joining of two sections of pipe; root, and hot weld pass cleaning, and the most aggressive brushing applications. Stringer Bead Twist Knot Wire Wheel Brushes are best used on right angle grinders for difficult jobs.



TIER:	BETTER	BETTER	BETTER	BETTER	BETTER	GOOD	GOOD
TRADENAME:	BLUEFIRE	BLUEFIRE	BLUEFIRE	BLUEFIRE	BLUEFIRE	GEMINI	GEMINI
WIRE TYPE:	CARBON	CARBON	CARBON	STAINLESS	STAINLESS	CARBON	STAINLESS
OTHER:		Pipeline	Heavy-Duty		Pipeline		

SIZE	FACE WIDTH	TRIM LENGTH	MAX. RPM	STD. PKG.	PART #	PART #	PART #	PART #	PART #	PART #
Stringer Bead Knot Wire Wheel Brushes – With Arbor Hole										
3" x 0.020" x 1/4"	3/8"	1"	20,000	10						662528 39096
4" x 0.020" x 5/8"-11	3/16"	7/8"	20,000	5	699366 06277		699366 06278			
4" x 0.020" x 5/8"-11	3/16"	7/8"	20,000	6	662528 33489 *	662528 40467 *			662528 42233 *	
4" x 0.020" x 5/8"-11	3/16"	7/8"	20,000	10	662533 70022 *				662528 39036	662528 39039
4" x 0.020" x 5/8"-11	1/4"	7/8"	20,000	5					662528 38997	
4" x 0.020" x 5/8"-11	1/4"	7/8"	20,000	10						662528 38989
4" x 0.020" x 5/8"-11	1/2"	7/8"	20,000	10					662528 39130	
4" x 0.020" x 5/8"-11	1/2"	1"	20,000	10					662528 39106	
4" x 0.020" x M10	3/16"	7/8"	20,000	6			699573 70144			
4" x 0.020" x M10	3/16"	7/8"	20,000	10						662528 39038
4-1/2" x 0.020" x 5/8"-11	3/16"	3/16"	15,000	5					662528 39111	
4-1/2" x 0.020" x 5/8"-11	3/16"	1-1/8"	15,000	6		662528 42299 *	662528 44886			
5" x 0.020" x 5/8"-11	3/16"	7/8"	12,500	10	662528 33490 *			662528 33491 *		
5" x 0.020" x 5/8"-11	1/2"	7/8"	12,500	5					662528 39133	
6" x 0.020" x 5/8"-11	3/16"	1-3/8"	9,000	10	699366 53350	662528 40469 *	662528 44887	699366 53351		
6-7/8" x 0.020" x 5/8"-11	3/16"	1-1/8"	9,000	5					662528 39026	
6-7/8" x 0.020" x 5/8"-11	3/16"	1-1/8"	9,000	10	699366 53329 *	662528 40468 *	662528 43919 *	662533 71116 *		
6-7/8" x 0.020" x 5/8"-11	3/16"	1-1/8"	9,000	6	662528 10992					
Double Hub										
9" x 0.020" x 5/8"-11	3/16"	2-1/8"	6,000	6	662528 37993					
Stringer Bead Knot Wire Wheel - With Arbor Hole – For Joint/Crack Cleaning with Walk-Behind Machines										
12" x 0.035" x 1"-DP	3/8"	3-1/4"	4,500	2	699366 06280					

*Bulk Packed Item



Radial Wheel

Nylon Radial Wheel Brushes are best used for deburring, surface and light cleaning, adding an edge radius, on ferrous and non-ferrous parts. The long trim length is ideal when used on intricate or irregular parts.

- Machine: Bench and Pedestal, Automated CNC, Inline Grinders



TIER:	GOOD
TRADENAME:	GEMINI
WIRE TYPE:	NYLON

SIZE	FACE WIDTH	TRIM LENGTH	MAX. RPM	STD. PKG.	PART #
Radial Wheel					
3" x 3/8" x 5/8"	3/8"	15/16"	15,000	12	662528 38842



TIER:	BETTER	GOOD	GOOD
TRADENAME:	BLUEFIRE	GEMINI	GEMINI
WIRE TYPE:	CARBON	CARBON	STAINLESS

Crimped Wire Wheel Brushes

Shank-mounted wheel brushes are used on straight shaft, die, and pencil grinders, and drills. Wheel brushes with arbor holes are used on bench and pedestal grinders. Their extra flexibility and lower impact makes these brushes an excellent choice for cleaning irregular surfaces and finer surface finishing, and light to medium duty surface contaminant removal applications. May be used individually or stacked on a shaft.

- Narrow-faced brushes are ideal for general-purpose brushing of uneven or difficult-to-reach surfaces.
- Medium-faced brushes clean larger surface areas and have longer life.



Crimped Wire Narrow Face - Carbon Steel - with Arbor hole



Crimped Wire - Carbon Steel - Shank Mounted

SIZE	FACE WIDTH	TRIM LENGTH	MAX. RPM	STD. PKG.	PART #	PART #	PART #
Crimped Wire Wheels Brushes with Narrow Face - With Arbor Hole							
1" x 0.008" x 5/16"	5/32"	3/16"	20,000	20		662528 38949	
2" x 0.014" x 1/2"	3/8"	1/2"	20,000	12		662528 39023	
3" x 0.005" x 1/2"	1/4"	1"	20,000	20			662528 38960
3" x 0.014" x 1/2"	5/8"	1"	20,000	10		662528 39024	
4" x 0.014" x 5/8"-11	7/16"	7/8"	15,000	5		662528 39001	
6" x 0.014" x 1/2"-2	3/4"	1-1/8"	6,500	5	699366 53306		
6" x 0.014" x 5/8"	3/4"	1-1/8"	6,000	5		662528 39097	
6" x 0.014" x 5/8"	3/4"	1-7/16"	6,000	5		662528 39088	
8" x 0.014" x 5/8"	3/4"	1-9/16"	4,000	5		662528 39099	
8" x 0.014" x 5/8"	3/4"	2-1/16"	6,000	5		662528 39089	
8" x 0.014" x 1-1/4"	5/8"	1-1/2"	4,000	5		662528 38978	
Crimped Wire Wheels Brushes with Medium Face - With Arbor Hole							
4-1/2" x 0.014" x 5/8"-11		1"	13,000	6	662533 70278		
6" x 0.014" x 1/2"-2	1"	1-1/8"	6,500	5	699366 53324		
6" x 0.014" x 5/8"	1"	1-1/8"	6,500	5		662528 39098	
8" x 0.014" x 1/2"-2	1-1/16"	1-5/8"	4,500	5	699366 53326		
8" x 0.014" x 5/8"	1"	1-9/16"	4,000	5		662528 39100	
8" x 0.014" x 2"	1"	1-3/8"	4,500	5		662528 39025	
10" x 0.014" x 3/4"	1-9/16"	2-1/2"	3,600	1		662528 39102	
12" x 0.012" x 2"	2"	3-1/4"	3,600	1		662528 39006	



TIER:	GOOD	GOOD	GOOD
TRADENAME:	GEMINI	GEMINI	GEMINI
WIRE TYPE:	CARBON	STAINLESS	BRASS

SIZE	FACE WIDTH	TRIM LENGTH	MAX. RPM	STD. PKG.	PART #	PART #	PART #
Crimped Wire Wheels Brushes with Narrow Face - Shank Mounted							
3/4" x 0.005" x 3/16"	1/32"	3/16"	37,000	100	662528 39084		
1" x 0.005" x 1/8"	1/8"	5/16"	37,000	100			662528 39085
1-1/2" x 0.008" x 1/4"	1/4"	1/4"	25,000	20	662528 38962		
1-1/2" x 0.0118" x 1/4"	7/16"	3/8"	20,000	12	662528 38999		
1-1/2" x 0.014" x 1/4"	1/4"	1/4"	25,000	20	662528 38963		
2" x 0.006" x 1/4"	3/8"	1/2"	20,000	20	662528 39029		
2" x 0.008" x 1/4"	3/8"	7/16"	25,000	20	662528 38964		
2" x 0.0118" x 1/4"	3/8"	1/2"	20,000	20	662528 39030		
2" x 0.014" x 1/4"	3/8"	7/16"	25,000	12	662528 38965		
2" x 0.020" x 1/4"	3/8"	7/16"	25,000	20	662528 38966		
2-1/2" x 0.008" x 1/4"	7/16"	11/16"	25,000	10	662528 38967		
2-1/2" x 0.014" x 1/4"	7/16"	11/16"	25,000	12	662528 38968		
3" x 0.008" x 1/4"	1/2"	1"	20,000	10	662528 39092		
3" x 0.008" x 1/4"	7/16"	3/4"	25,000	10	662528 38969		
3" x 0.008" x 1/4"	7/16"	3/4"	25,000	12		662528 38972	
3" x 0.0118" x 1/4"	1/2"	1"	20,000	10	662528 39093		
3" x 0.014" x 1/4"	3/8"	1/4"	20,000	12	662528 39000		
3" x 0.014" x 1/4"	7/16"	3/4"	25,000	10	662528 38970		
3" x 0.014" x 1/4"	7/16"	3/4"	25,000	12		662528 38973	
3" x 0.014" x 1/4"	1/2"	1"	20,000	20		662528 39048	
3" x 0.020" x 1/4"	7/16"	3/4"	25,000	12	662528 38971		
3" x 0.020" x 1/4"	1/2"	1"	20,000	12	662528 39096		
4" x 0.014" x 1/4"	1/2"	1"	25,000	12	662528 38974		

Clean and deburr recessed areas or inside diameters of tubes and pipes to proper surface finish; rubber and plastic flash removal; paint and rust removal, and mold and tool polishing



EXPANDED OFFERING

END BRUSHES

- Used on CNC, Robotic, die grinders, and drill presses
- Twist knot wire end brushes for more aggressive cutting
- Crimped wire end brushes for lighter brushing action and contoured surfaces



Twist Knot Wire End Brush

Their added wire rigidity makes these brushes the choice for more aggressive cutting.



SIZE	TRIM LENGTH	MAX. RPM	STD. PKG.	TIER:	BETTER	BETTER	GOOD	GOOD
				TRADENAME:	BLUEFIRE	BLUEFIRE	GEMINI	GEMINI
				WIRE TYPE:	CARBON	STAINLESS	CARBON	STAINLESS
				PART #	PART #	PART #	PART #	PART #
Twist Knot Wire End Brushes – Shank-Mounted								
1/2" x 0.006" x 1/4"	1-1/8"	22,000	20				66252838876	
1/2" x 0.014" x 1/4"	1-1/8"	22,000	20				66252838877	
3/4" x 0.014" x 1/8"	7/8"	22,000	20				66252839056	
3/4" x 0.014" x 1/4"	7/8"	22,000	10	699573	70164	699573	70165	
3/4" x 0.014" x 1/4"	7/8"	22,000	20				66252838879	
3/4" x 0.020" x 1/4"	7/8"	22,000	10	699366	53316*	699573	70166	
3/4" x 0.020" x 1/4"	7/8"	22,000	20				66252839057	
3/4" x 0.020" x 1/4"	1"	22,000	20				66252839116	66252839118
3/4" x 0.020" x 1/4"	1-1/8"	22,000	20				66252838878	
1" x 0.006" x 1/4"	1-1/8"	22,000	20					66252838885
1" x 0.010" x 1/4"	1-1/8"	22,000	25					66252838886
1" x 0.014" x 1/4"	7/8"	22,000	10	699366	06279*	699573	70167	
1" x 0.014" x 1/4"	1"	22,000	20				66252838882	66252838887
1" x 0.020" x 1/4"	7/8"	22,000	10	699366	53310*	699573	70168	
1" x 0.020" x 1/4"	1"	22,000	20					66252839119
1" x 0.020" x 1/4"	1"	22,000	25				66252839117	

* Bulk Packed Item



Insert Circular Flared Crimped Wire End Brush

The flared end configuration facilitates interior side cleaning and will not harm the bottom of the hole.



Encapsulated Hollow Center Crimped Wire End Brush

Their hollow centers effectively allow these brushes to clean around protrusions and also prevent the wires from meshing together. Encapsulating a portion of the wires' length shortens the free wires, increasing the wires' stiffness, thereby creating greater control of the brush.



SIZE	TRIM LENGTH	MAX. RPM	STD. PKG.	TIER:	BETTER	GOOD
				TRADENAME:	BLUEFIRE	GEMINI
				WIRE TYPE:	CARBON	CARBON
				PART #	PART #	PART #
Insert Circular Flared Crimped End Brushes – Shank-Mounted						
1-1/2" x 0.006" x 1/4"	1/4"	20,000	10	699573	70161	
1-1/2" x 0.006" x 1/4"	7/8"	20,000	12			66252839108
1-1/2" x 0.020" x 1/4"	1/4"	15,000	10	699573	70160	
1-1/2" x 0.020" x 1/4"	1"	15,000	12			66252838898
2" x 0.010" x 1/4"	1-1/8"	15,000	10			66252838899
2" x 0.0104" x 1/4"	1/2"	15,000	10	699573	70162	
3" x 0.008" x 1/4"	7/8"	16,000	12			66252839047
3" x 0.008" x 1/4"	1"	16,000	10	699573	70163	

TIER: **GOOD**
TRADENAME: **GEMINI**
WIRE TYPE: **CARBON**

SIZE	TRIM LENGTH	MAX. RPM	STD. PKG.	PART #
Encapsulated Hollow Center Crimped Wire End Brush – Shank-Mounted				
1/2" x 0.010" x 1/4"	1"	18,000	20	66252838907



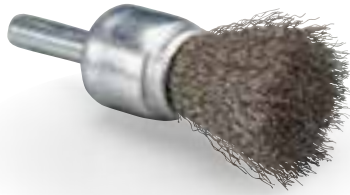

Crimped Wire End Brushes

Designed to generate lighter brushing action and reach into contoured surfaces.



TIER:	BETTER	BETTER	GOOD	GOOD
TRADENAME:	BLUEFIRE	BLUEFIRE	GEMINI	GEMINI
WIRE TYPE:	CARBON	STAINLESS	CARBON	STAINLESS

SIZE	TRIM LENGTH	MAX. RPM	STD. PKG.	PART #	PART #	PART #	PART #
Crimped Wire End Brushes – Shank-Mounted							
1/4" x 0.005" x 1/8"	7/16"	37,000	12				66252839086
1/2" x 0.005" x 1/4"	1"	25,000	20				66252838902
1/2" x 0.006" x 1/4"	3/8"	25,000	20			66252839040	
1/2" x 0.006" x 1/4"	1"	25,000	20			66252838889	66252839043
1/2" x 0.010" x 1/4"	1"	25,000	20			66252838890	66252839044
1/2" x 0.014" x 1/4"	7/8"	25,000	20			66252839042	
1/2" x 0.014" x 1/4"	1"	25,000	20				66252838888
1/2" x 0.020" x 1/4"	1"	25,000	20			66252838891	
3/4" x 0.006" x 1/4"	1"	22,000	10*		69936606145		
3/4" x 0.010" x 1/4"	3/8"	22,000	20			66252839053	
3/4" x 0.014" x 1/4"	1"	22,000	10*	69936653317			
3/4" x 0.020" x 1/4"	7/8"	22,000	20			66252839112	
3/4" x 0.020" x 1/4"	1"	22,000	20			66252838892	
1" x 0.005" x 1/4"	1"	22,000	20				66252838896
1" x 0.006" x 1/4"	1"	22,000	25			66252839045	66252838838
1" x 0.010" x 1/4"	3/8"	22,000	20			66252839054	
1" x 0.010" x 1/4"	1"	22,000	25				66252839055
1" x 0.010" x 1/4"	1"	22,000	20				66252838897
1" x 0.014" x 1/4"	3/4"	20,000	20			66252839094	
1" x 0.014" x 1/4"	1"	22,000	20			66252839046	
1" x 0.020" x 1/4"	7/8"	22,000	20			66252839095	
1" x 0.020" x 1/4"	1"	22,000	20			66262839113	66252839115
1" x 0.020" x 1/4"	1-3/16"	20,000	10*	69936653309			

* Bulk Packed Item

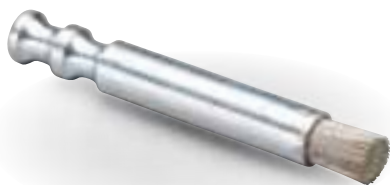

Pencil Crimped Wire End Brush

These brushes are designed to clean counter bores, slots, blind holes, and small crevices; and light spot facing of aluminum or iron sand castings.



TIER:	GOOD
TRADENAME:	GEMINI
WIRE TYPE:	STAINLESS

SIZE	TRIM LENGTH	MAX. RPM	STD. PKG.	PART #
Pencil Crimped Wire End Brush – Shank-Mounted				
1/4" x 0.010" x 5/16"	3/8"	10,000	12	66252838906



Pilot End Brush

Specially designed to clean around rivet or bolt holes; the pilot guides the brushes.



TIER:	GOOD
TRADENAME:	GEMINI
WIRE TYPE:	CARBON

SIZE	TRIM LENGTH	MAX. RPM	STD. PKG.	PART #
Pilot Crimped Wire End Brush – Shank-Mounted				
1/2" x 0.004" x 1/4"	3/8"	25,000	20	66252838904

Cleaning, polishing, reaming, finishing and removing debris, burrs, rust, residues, and surface contaminants inside cylindrical items, including tubes, pipes, bottles, smooth-sided and threaded holes, and other industrial components



EXPANDED OFFERING

TUBE BRUSHES

- Use manually or fastened to portable or fixed machines (including drills, drill presses, and CNC machines)
- Available in single and double stem providing firm support when working internally
- A wide selection of shapes and filament variations to achieve the best results on many different applications

Single Stem, Single Spiral Tube Brush – With Eye Loop

These spiral brushes have a single layer of filament twisted around a stem wire to create additional strength and higher density fill brushes. This spiral configuration ensures consistent and constant abrasive contact with the tube. Formed eye loop at the end of the stem for convenient hand use.



TIER:	GOOD	GOOD	GOOD	GOOD
TRADENAME:	GEMINI	GEMINI	GEMINI	GEMINI
WIRE TYPE:	CARBON	STAINLESS	BRASS	NYLON

SIZE	TRIM LENGTH	MAX. RPM	STD. PKG.	PART #	PART #	PART #	PART #
Single Stem, Single Spiral Tube Brush – With Eye Loop							
3/16" x 0.003" x 0.094"	1-1/2"	2,000	12	662528 38822			
3/16" x 0.004" x 0.094"	5/64"	3,000	12	662528 38913			
1/4" x 0.003" x 0.094"	1-1/2"	2,000	12	662528 38823	662528 38824	662528 38840	
1/4" x 0.004" x 0.115"	5/64"	3,000	12	662528 38914			
1/4" x 0.006" x 0.115"	5/64"	3,000	12	662528 38915			
3/8" x 0.004" x 0.125"	2"	2,000	12		662528 38825	662528 38826	
3/8" x 0.004" x 0.132"	1/8"	3,000	12	662528 38916			
3/8" x 0.006" x 0.168"	1/8"	3,000	12	662528 38917			
3/8" x 0.006" x 0.168"	1-1/2"	3,000	12		662528 38946		
7/16" x 0.010" x 0.125"	7/64"	3,000	12				662528 38947
1/2" x 0.008" x 0.221"	9/64"	3,000	12	662528 38918			



Single Stem, Single Spiral Tube Brush

Similar to the single stem, single spiral tube brushes, but without eye loop. These brushes are ideal for complete internal cleaning and deburring of tubes and pipes and intricate area ensuring constant filament to surface contact.

TIER:	GOOD
TRADENAME:	GEMINI
WIRE TYPE:	CARBON

SIZE	TRIM LENGTH	MAX. RPM	STD. PKG.	PART #
Single Stem, Single Spiral Tube Brush				
7/16" x 0.005" x 0.125"	11/64"	3,000	12	662528 38911*
1" x 0.010" x 0.250"	2-1/2"	2,000	12	662528 39074*

* No eye loop

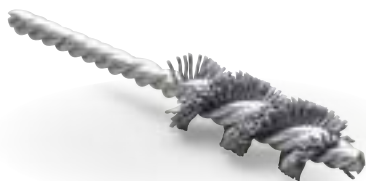

Double Stem, Single Spiral Tube Brush – with Stem

These brushes have two stem wires. This results in a brush with high strength and one with consistent and constant abrasive contact with the tube.

TIER:	GOOD	GOOD
TRADENAME:	GEMINI	GEMINI
WIRE TYPE:	BRASS	NYLON

SIZE	TRIM LENGTH	MAX. RPM	STD. PKG.	PART #	PART #
Double Stem, Single Spiral Tube Brush – With Stem					
1/2" x 0.006" x 0.188"	2"	2,000	12	662528 38839	
3/4" x 0.040" x 0.238"	3/8"	3,000	12		662528 38850

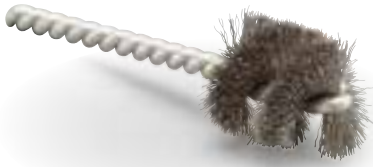

Power Burr, Single Spiral Tube Brush – with Stem

Power burr brushes are used to remove burrs resulting from previous operations. They are designed to remove burrs without creating secondary burrs or leaving sharp edges.



TIER:	GOOD	GOOD
TRADENAME:	GEMINI	GEMINI
WIRE TYPE:	CARBON	STAINLESS

SIZE	TRIM LENGTH	MAX. RPM	STD. PKG.	PART #	PART #
Power Burr Single Spiral Tube Brushes – With Stem					
1/4" x 0.004" x 0.125"	1"	2,000	12	662528 39061	662528 39081
3/8" x 0.004" x 0.125"	1"	2,000	12	662528 39062	662528 39050
3/8" x 0.005" x 0.125"	9/64"	2,000	12	662528 38910	
1/2" x 0.005" x 0.188"	1"	2,000	12	662528 39063	662528 39051
5/8" x 0.005" x 0.188"	1"	2,000	12	662528 39064	
3/4" x 0.006" x 0.219"	1"	2,000	12	662528 39065	662528 39082
1" x 0.005" x 0.125"	15/32"	2,000	12	662528 38912	
1" x 0.005" x 0.250"	1"	2,000	12	662528 39066	662528 39083

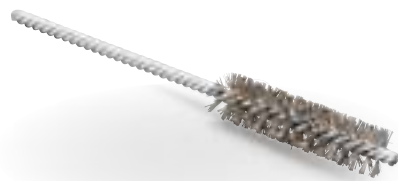

Double Stem, Double Spiral Tube Brush – With Stem

Brush filaments are twisted between two stem wires with two layers of filament bristles. Each layer is perpendicular to the other with a single stem wire in each of the brush's four sections. This configuration ensures consistent and constant abrasive contact with the tube.



TIER:	GOOD	GOOD
TRADENAME:	GEMINI	GEMINI
WIRE TYPE:	CARBON	STAINLESS

SIZE	BRUSH LENGTH	MAX. RPM	STD. PKG.	PART #	PART #
Double Stem, Double Spiral Tube Brush – With Stem					
3/8" x 0.060" x 0.125"	1-1/2"	2,000	12	662528 38827	
1/2" x 0.004" x 0.156"	2"	2,000	12	662528 38828	
1/2" x 0.004" x 0.187"	5/32"	3,000	12	662528 38919	
1/2" x 0.006" x 0.156"	2"	2,000	12	662528 39067	662528 38829
1/2" x 0.006" x 0.187"	5/32"	3,000	12	662528 38920	
5/8" x 0.005" x 0.187"	2"	2,000	12	662528 39068	
5/8" x 0.006" x 0.208"	2"	3,000	12	662528 38921	
5/8" x 0.008" x 0.219"	2"	2,000	12	662528 38831	
5/8" x 0.010" x 0.208"	13/64"	3,000	12	662528 38922	662528 38930
3/4" x 0.004" x 0.250"	2-1/2"	2,000	12	662528 39072	
3/4" x 0.006" x 0.238"	1/4"	3,000	12	662528 38923	
3/4" x 0.006" x 0.250"	2-1/2"	2,000	12	662528 39069	
3/4" x 0.006" x 0.250"	2-1/2"	2,000	12	662528 38832	
3/4" x 0.010" x 0.238"	1/4"	3,000	12	662528 38924	
7/8" x 0.004" x 0.250"	2-1/2"	2,000	12	662528 39073	
7/8" x 0.006" x 0.238"	2"	3,000	12	662528 38925	
7/8" x 0.006" x 0.250"	2-1/2"	2,000	12	662528 39070	
1" x 0.006" x 0.238"	25/64"	3,000	12	662528 38926	
1" x 0.006" x 0.250"	2-1/2"	2,000	12	662528 39071	
1" x 0.010" x 0.238"	2"	3,000	12	662528 38927	
1-1/4" x 0.004" x 0.250"	2-1/2"	2,000	12	662528 38833	
1-1/4" x 0.010" x 0.238"	1/2"	3,000	12	662528 38928	
2" x 0.010" x 0.238"	7/8"	3,000	12	662528 38929	



Encapsulated Double Stem, Double Spiral Tube Brush – With Stem

Encapsulating a portion of the wires' length shortens the free wires, increasing their stiffness, thereby creating greater control of the brush and a brush with the highest filament density and highest strength.



TIER:	GOOD
TRADENAME:	GEMINI
WIRE TYPE:	CARBON

SIZE	BRUSH LENGTH	MAX. RPM	STD. PKG.	PART #
Encapsulated Double Stem, Double Spiral Tube Brush – With Stem				
7/8" x 0.010" x 0.250"	2-1/4"	3,000	20	662528 38948



Flue Double Spiral Tube Brushes – With 1/4" x 2" NPT Pipe Nipple with Stem

These aggressive brushes are designed specifically for efficient pipe and boiler cleaning.



TIER: **GOOD**
TRADENAME: **GEMINI**
WIRE TYPE: **CARBON**

SIZE	TRIM ENTH	MAX. RPM	STD. PKG.	PART #
Flue Double Spiral Tube Brushes – With 1/4" x 2" NPT Pipe Nipple – With Stem				
3/4" x 0.010" x 0.238"	1/4"	3,000	12	662528 38931
1" x 0.010" x 0.313"	25/64"	3,000	12	662528 38932
1-1/4" x 0.012" x 0.313"	1/2"	3,000	12	662528 38933
1-3/4" x 0.012" x 0.313"	1/2"	3,000	12	662528 38934
2-1/4" x 0.012" x 0.313"	1/2"	3,000	12	662528 38935
2-3/4" x 0.014" x 0.313"	1/2"	3,000	12	662528 38936



Side-Action Tube (Burrite) Crimped Wire Tube Brushes – with Stem

Their dense side filament configuration creates increased bristle rigidity with minimal flexing, to aggressively clean the tube without changing its geometry or surface finish.



TIER: **GOOD**
TRADENAME: **GEMINI**
WIRE TYPE: **CARBON**

SIZE	TRIM ENTH	MAX. RPM	STD. PKG.	PART #
Side-Action (Burrite) Crimped Wire Tube Brush – With Stem				
1/4" x 0.003" x 0.094"	5/64"	3,000	12	662528 38908
5/16" x 0.005" x 0.094"	9/16"	2,000	10	662528 38834
5/8" x 0.005" x 0.125"	1/4"	3,000	12	662528 38909



Internal Finishing Crimped Wire Tube Brush

This square-trimmed crimped wire brush is used to clean internal surfaces in a single operation because it can simultaneously brush both the sides and bottom of a hole.



TIER: **GOOD**
TRADENAME: **GEMINI**
WIRE TYPE: **CARBON**

SIZE	TRIM LENGTH	FACE WIDTH	MAX. RPM	STD. PKG.	PART #
Internal Finishing Crimped Wire Tube Brushes – With Stem					
1-1/4" x 0.006" x 0.250"	1/2"	3/8"	4,500	10	662528 38945



Micro Abrasive Single Spiral Nylon Tube Brush – With Stem

Micro brushes are ideal for ultra-fine deburring, cleaning, polishing and finishing applications.



TIER: **GOOD**
TRADENAME: **GEMINI**
WIRE TYPE: **NYLON/AO 600 GRIT**

SIZE	TRIM LENGTH	MAX. RPM	STD. PKG.	PART #
Micro Abrasive Single Spiral Nylon Tube Brushes – With Stem				
3/16" x 0.012" x 0.093"	3/64"	3,000	12	662528 38853
0.190" x 0.012" x 0.087"	1"	1,500	12	662528 38814
0.260" x 0.012" x 0.115"	1"	1,500	12	662528 38815
0.325" x 0.012" x 0.115"	1"	1,500	12	662528 38816
0.325" x 0.012" x 0.121"	1"	3,000	12	662528 38854
33/64" x 0.012" x 0.175"	3/16"	3,000	12	662528 38855
33/64" x 0.022" x 0.175"	3/16"	3,000	12	662528 38851
1-1/64" x 0.022" x 0.255"	3/8"	3,000	12	662528 38852



TIER: **GOOD**
TRADENAME: **GEMINI**
WIRE TYPE: **NYLON**



Single Spiral Nylon Hand Tube Brush – With Eye Loop

These brushes are made with larger stem wires to give them the strength and rigidity needed for manual cleaning applications.

SIZE	TRIM LENGTH	MAX. RPM	STD. PKG.	PART #
Single Spiral Nylon Hand Tube Brush – With Eye Loop				
1/4" x 0.005" x 0.094"	9/64"	3,000	12	662528 38937
1/4" x 0.005" x 0.094"	2"	2,000	12	662528 38818
3/8" x 0.005" x 0.094"	2"	2,000	12	662528 38819
3/8" x 0.005" x 0.094"	9/64"	3,000	12	662528 38938
1/2" x 0.008" x 0.094"	3"	3,000	12	662528 38939
1/2" x 0.010" x 0.125"	3"	2,000	12	662528 38820
3/4" x 0.012" x 0.125"	21/64"	3,000	12	662528 38940
3/4" x 0.012" x 0.125"	3"	2,000	12	662528 38821
1" x 0.010" x 0.156"	25/64"	3,000	12	662528 38941
1" x 0.022" x 0.156"	2-1/2"	1,500	12	662528 38817
1-1/4" x 0.010" x 0.156"	1/2"	3,000	12	662528 38942
1-1/4" x 0.010" x 0.219"	1/2"	3,000	12	662528 38943
2" x 0.010" x 0.219"	1/2"	3,000	12	662528 38944

Hand Brushes

Hand brushes come in a variety of handle and filament shapes and styles for most hand scratching applications. They are favored by many in removing scale, surface coatings, or removing weld debris.

For steel/stainless



HAND BRUSHES

- Long handle and shoe handle brushes are made with a high-carbon, brass-coated steel; stainless steel is made with a 304L stainless
- Plastic ergonomic handle scratch brush with curved face to access hard-to-reach places. Crimped wire for longer life. Wires are wrapped up and around the metal post so they never come out.
- Narrow brush allows access into tight areas and slots



TIER: **BETTER** **BETTER** **BETTER** **BETTER** **BETTER** **BETTER** **BETTER**
TRADENAME: **BLUEFIRE** **BLUEFIRE** **BLUEFIRE** **BLUEFIRE** **BLUEFIRE** **BLUEFIRE** **BLUEFIRE**
WIRE TYPE: **CARBON** **STAINLESS** **CARBON** **STAINLESS** **CARBON** **STAINLESS** **STAINLESS**

SIZE	TRIM LENGTH	MAX. RPM	STD. PKG.	PART #	PART #	PART #	PART #	PART #	PART #	PART #
Hand Scratch Brushes – With Handle										
3" x 19"	1-3/16"	–	12	662528 33948	662528 33950					
4" x 16"	1-3/16"	–	12			662528 33949	662528 33951			
5" x 10"	1-1/8"	–	24					662528 33954	662528 33953	
3" x 7"	1/2"	–	36							662528 33952





When maximum conformability is needed, tough, Norton nylon brushes' flexible nylon filaments embedded with abrasive grain provide exceptional finishing and polishing and eliminate the need for costly and inconsistent hand deburring applications.

Norton nylon brushes are precision-engineered with the highest quality abrasive grains for those markets with the strictest requirements – for easy integration into today's automated machinery, CNC machining centers, transfer lines, robotic cells, and other highly-specialized machinery, as well as hand tools.

- Applications:** Deburring, cleaning, finishing, and polishing
- Brush Configurations:** Radial wheel brushes, narrow face wheel brushes, disc brushes, end brushes, and twisted brushes
- Markets:** Aerospace/aircraft, automotive, construction/utility products, medical, metal finishing, woodworking
- Abrasive Grain:** Ceramic Alumina, Silicon Carbide

Why Choose Nylon Abrasive Brushes?

- Abrasive grain cutting points are increased as the grain is exposed and cut equally when pressure is applied to the side or tip of the filament
- Uniform distribution of grain throughout the filaments allows cutting and finishing performance levels to remain consistent throughout the life of the brush – making Norton abrasive brushes ideal for automated applications
- Heat- and stress-resistant filaments prolong brush life and allow for superior conformability to irregular surface shapes
- The grain impregnated filaments act as a flexible file to deburr and radius edge profiles with precision, without gouging or affecting the overall geometry of a part
- The filaments bend at various angles to fit contours, creating a less prominent, more uniform surface finish in comparison to wire wheels or coated abrasive products
- Brush conformability allows usage on variety of complex part shapes without the need for ultra-precise programming and fixturing that is required with other deburring and finishing tools

Currently, all Norton Blaze ceramic alumina nylon abrasive brushes are custom-made to your exact requirements. The Norton Blaze Nylon Brushes Brochure #8571 provides technical information and product availability. Your Norton representative would be pleased to review availability, quotations, and lead-times with you.



complementing our
ABRASIVES PORTFOLIO

To help you finish the job, Norton tapes, masking products and micro-fiber cloths let you one-stop shop. Our goal is to get it finished faster, easier and with less hassle of multiple vendors and invoices.





Norton masking tapes feature a special solvent-based, rubber adhesive system and strong holding properties. These tapes adhere and release cleanly while providing clean edges on a variety of flat, contoured, and irregular surfaces. Norton sheetings provides superior solvent, paint, and contaminant penetration resistance. Use them during paint preparation and anywhere you need work area protection. Tear-resistant properties allow movement without ripping.

Products:

Attachment Tape, Masking Tape, Masking Film, Sheeting, Masking Paper

Machine Used:



HAND
APPLICATION

Best choice for general industrial application replacing permanent fastening systems (rivets, welds and liquid adhesives)

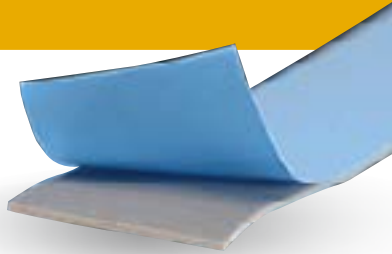

NORTON ATTACHMENT TAPE

- Double sided, gray foam tape used in bonding performance for many interior and exterior commercial applications.
- Incredible conformability and application stretching
- Weather degradation resistance from UV and high temperatures
- Outstanding static shear adhesion
- Excellent performance in T-Block and dynamic shear
- Durable adhesion at elevated temperature
- High shock and stress absorption

DESCRIPTION	THICKNESS	1/4" x 108"	1/2" x 108"	3/4" x 108"	7/8" X 108"	1" X 108"	1-1/2" X 108"
Blue Liner							
Gray Double-Sided Acrylic Foam Tape	.043" (1.1mm)	636425 06044	636425 06045	636425 06046	636425 06047	662611 75888	662611 51041
Rolls/Case		40/1	20/1	10/1	10/1	10/1	6/1
DESCRIPTION	THICKNESS	1/4" X 20 YDS	1/2" X 20 YDS		7/8" X 20 YDS		
Red Liner							
Gray Double-Sided Acrylic Foam Tape	.043" (1.1mm)	636425 05620	636425 05621	-	636425 05622	-	-
Rolls/Case		12/1	12/1		12/1		
Adhesion Promoter							
Brush-Top Can - 220ml		636415 05623					
Rolls/Case		12					

Technical Data

Performance tests are run using standard test procedures. The values presented are typical values and should not be used for specification purposes.

THICKNESS in. (mm)	90° PEEL ADHESION ¹ (3-DAY DWELL) lb/in (N/cm)				T-BLOCK ² lb/in (N/cm)	DYNAMIC SHEAR ³ lb/in (N/cm)	STATIC SHEAR ⁴ 7 Days /1 kg	SERVICE TEMPERATURE
	GLASS	ALUMINUM	S/S	PMMA	ALUMINUM	S/S	S/S	
.043 (1.1)	20 (35)	33 (57)	20 (34)	17 (29)	100 (29)	48 (33)	Pass and Exceeds	-35°F to 200°F (-35°C to 93°C)

¹ Based on ASTM D3330 ² Based on ASTM D897 ³ Based on ASTM D1002 ⁴ Based on ASTM D3654



Best choice for high temperature applications including high-heat curing

PREMIUM HIGH TEMPERATURE GREEN MASKING TAPE

- Ideal for conditions that include exposure to the high-heat curing temperatures found in automobile, truck, bus, and other transportation assembly operations, as well as aerospace manufacturing applications
- Superior strength and excellent cornering ability
- Ideal for high temperatures; can be effectively used up to 250°F (120°C) for 30 minutes without any significant loss of properties or adhesive transfer
- Can also be used up to 175°F (80°C) for one hour without leaving residues after exposure
- UV resistance for 2 days
- Can be exposed to wet sanding without adhesive transfer



Better choice for medium-temperature applications

MEDIUM TEMPERATURE MASKING TAPE

- Designed for excellent performance in moderate-temperature applications
- Can be used up to 220 °F (105°C) for 30 minutes and 175°F (80°C) for one hour without any significant loss of properties; removes cleanly without leaving residues after exposure



Good general-purpose choice

GENERAL PURPOSE MASKING TAPE

- Ideal for splicing, holding, packaging, and general purpose masking
- Good adhesion onto a wide variety of surfaces
- Good performance up to 175°F (80°C) for one hour without any significant loss of properties; removes cleanly without leaving residues after exposure



It delivers very sharp, clean edges on smooth- to moderately-textured surfaces

BLUE CORE 14-DAY TAPE

- Our paint masking tape has a specially formulated adhesive system that provides optimum low- to medium-tack adhesion and clean removal from a variety of surfaces, for up to 14 days
- Blue Core masking tape can be used indoors or out
- The crepe paper backing is designed to enable easy unrolling and to minimize slivering



Better choice for fine line masking needs

FINE LINE BLUE MASKING TAPE

- Masking color separation on plastic (TPO and RIM) automotive fascia, trim, and finished metals in high-temperature OEM bake cycles, aircraft and clean room paint operations
- Thermally-stabilized PVC backing with a rubber-based pressure sensitive adhesive
- Highly conformable, waterproof, and solvent-resistant
- Can be used from 40°F (4.4°C) to 280°F (138°C) without any significant loss of properties; removes cleanly without leaving residues after exposure



TIER:	BEST	BETTER	GOOD	GOOD	BETTER
	PREMIUM HIGH TEMP GREEN	MEDIUM TEMPERATURE	GENERAL PURPOSE	BLUECORE 14 DAY TRAPE	FINE LINE BLUE
CAP CODE	C995	C988	C903		
BACKING	Crepe paper	Crepe paper	Crepe paper	Fine Crepe Paper	PVC
ADHESIVE	Solvent-based rubber	Solvent-based rubber	Solvent-based rubber	Synthetic Rubber	Natural Rubber
TENSILE STRENGTH	3.0 kgf/cm, 29 N/10mm	2.6 kgf/cm, 25 N/10mm	2.5 kgf/cm, 25 N/10mm	23 lbs/in (101 N/25mm)	15 lb/in. of width, 65.6N/25mm
ELONGATION AT BREAK	8.50%	7.0%	7.0%	11%	150%
PEEL ADHESION AT 180° ANGLE	400 gf/cm, 3.9 N/10mm	370 gf/cm, 3.6 N/10mm	300 gf/cm, 2.9 N/10mm		23 oz./in. of width, 6.3N/25mm
TOTAL THICKNESS	120 microns (0.120mm)	110 microns (0.110mm)	100 microns (0.100mm)	5.5 mils (0.14mm)	5.4mils (.14mm)
TEMPERATURE	250°F (120°C) for 30 min. 175°F (80°C) for 1 hour	220°F (105°C) for 30 min. 175°F (80°C) for 1 hour	175°F (80°C) for 1 hour		40°F (4.4°C) to 280°F (138°C)

METRIC	IMPERIAL	ROLLS/CASE	PART #
Premium High-Temp Green Tape			
12mm x 50m	0.47 inches x 54.7 yards	72	699573 10320
18mm x 50m	0.71 inches x 54.7 yards	48	666233 09768
24mm x 50m	0.94 inches x 54.7 yards	36	666233 27752
36mm x 50m	1.42 inches x 54.7 yards	24	699573 10323
48mm x 50m	1.89 inches x 54.7 yards	20	666233 09770
72mm x 50m	2.83 inches x 54.7 yards	12	699573 10325
100mm x 50m	3.93 inches x 54.7 yards	8	699573 45060
200mm x 50m	7.87 inches x 54.7 yards	4	699573 45063
Medium-Temperature Tape			
12mm x 50m	0.47 inches x 54.7 yards	72	699573 10326
18mm x 50m	0.71 inches x 54.7 yards	48	055395 44799
24mm x 50m	0.94 inches x 54.7 yards	36	699573 10327
36mm x 50m	1.42 inches x 54.7 yards	24	662610 70829
48mm x 50m	1.89 inches x 54.7 yards	20	055395 44800
General-Purpose Tape			
18mm x 40m	0.71 inches x 43.7 yards	48	662611 03314
24mm x 40m	0.94 inches x 43.7 yards	36	662611 03315
36mm x 40m	1.42 inches x 43.7 yards	24	699573 45064
48mm x 40m	1.89 inches x 43.7 yards	20	662611 03317
72mm x 40m	2.83 inches x 43.7 yards	12	699573 45065
Blue Core 14-Day Tape			
36mm x 54.8m	1-1/2" x 60 yards	24	076607 21954
48mm x 54.8m	2" x 60 yards	24	076607 21955
<i>Bulk packed as individual rolls</i>			
Fine Line Blue Tape			
3.17mm x 32.9m	1/8 inches x 36 yards	360*	662611 82688
6.35mm x 32.9m	1/4 inches x 36 yards	168*	662611 82686
12.7mm x 32.9m	1/2 inches x 36 yards	78*	662611 82685

* Master case quantity



Good masking choice for multiple transportation applications

ANCHOR BRAND HAND MASK

- IPG's Anchor® brand Hand Mask is a pre-folded, high density polyethylene masking film designed for multiple transportation applications
- The thick and durable 12 micron film is corona treated to resist overspray flaking during paint applications
- This special film is designed with a reinforced top edge formulated to prevent the underlying film from sticking
- Designed to work with multiple hand dispensers and the 1" core fits most masking machines.

	54.8M (60YD) ROLL	90' ROLL	180' ROLL
WIDTH	ROLL HEIGHT	PART #	PART #
24"	5.35"	–	087143 00214
48"	8.78"	–	087143 00216
72"	9.57"	087143 00217	–
99"	13.0"	087143 00218	–
<i>Case</i>		12	12



Good multi-purpose choice provides durability and excellent protection

HIGH DENSITY SHEETING (HDPE)

Our multi-purpose painters' plastic sheeting protects virtually any area from sanding dust and paint overspray with ease – even after repositioning. Our High Density Plastic Sheeting (HDPE) is designed to be one of the strongest most durable products on the market.

- Resists tearing and solvent bleed-through with light weight .31 mil High Density Polyethylene plastic (HDPE)
- Holds in place as it clings to horizontal or vertical surfaces during taping with its natural electrostatic properties
- Attracts and holds sanding debris for a dust-free finish
- Drapes easily over furniture

SIZE	THICKNESS	COLOR	QTY/PACK	PACKS/CASE	PART #
9' x 400'	.31 mil	Clear	1	1	076607 68142
12' x 400'	.31 mil	Clear	1	1	076607 68143

Also available by the pallet.



Good choice for all of your masking needs

GREEN MASKING PAPER

- Made from recyclable virgin wood pulp fiber, recycled fiber, or a combination of the two
- These fibers provide a machine finish kraft paper with non-contaminating cleanliness, sustainability, and superior strength properties
- Smooth paper surface ensures no fiber linting leading to rework
- Flexible, easy to work with and shape; conforms to uneven surfaces

SIZE	3"	6"	12"	18"	20"	24"	36"	46"	69"
DESCRIPTION	PART #	PART #	PART #	PART #	PART #	PART #	PART #	PART #	PART #
(750' boxed)	699573 13146	699573 13147	699573 13148	699573 13149	699573 13151	699573 13152	699573 13153	699573 13154	699573 13155
<i>Logs/Case</i>	12/1	6/1	3/1	2/1	1/1	1/1	1/1	1/1	1/1

Order per number of logs:

Each "log" is a total of 36" wide – comprised of the width of the individual roll in inches x the number of rolls/box, e.g. 6" roll x 6 rolls in the box = one 36" wide log; 12" roll x 3 rolls in the box = one 36" wide log, etc., except for the 24" and 36" rolls which are single logs.



A micro-fiber is a single fiber with a thickness less than a human hair that has been split 16 times and woven into various products. The surface area of a micro-fiber product is increased over 15 times, creating millions of spaces between the fibers which trap dirt, grime or liquids, making this product one of the most absorbent materials. These cloths save you labor, time, and additional costs of multiple cleaning products and chemicals.

Applications:

Cleaning Cloth: Used for general-purpose wet or dry applications. Works best when sprayed with a light water mist to deep clean.

Dry Tack Cloth: This woven terry cloth has a low profile to resist snagging and help pick up embedded debris.

Polishing Cloth: Streak-free cleaning of mirrors, optical lens and highly-polished items.

Other:

Color-coded for easy identification

Cleaning Cloth: Blue

Dry Tack Cloth: Red

Polishing Cloth: Yellow

Machine Used:



HAND
APPLICATION

TECH TIP

- Use these micro-fiber cloths dry for general cleaning
- To remove spills, stains or grime, lightly dampen the cloth for best results
- All micro-fiber cloths can be used with or without chemicals
- Micro-fiber cloths can be washed up to 300+ times without losing cleaning and trapping abilities
- Clean often for best results



It is the user's responsibility to refer to and comply with all safety regulations.



DESCRIPTION	COLOR	STD. PKG.	PART #
Micro-Fiber Cleaning Cloth 16" x 16"	Blue	20	076607 05300
Micro-Fiber Dry Tack Cloth 16" x 16"	Red	20	076607 04025
Micro-Fiber Polishing Cloth 16" x 16"	Yellow	20	076607 05301

100 Years of Safety Leadership

The year 2016 marked the 100-year anniversary of the leadership of the former Norton Company in the creation of the first ever safety code for abrasives.

In 1916, following more than a decade of safety research, advocacy, and leadership by the Norton Company (now Norton | Saint-Gobain Abrasives), "The Safety Code for the Use and Care of Abrasive Wheels" was published. This 13-page booklet, containing an unprecedented set of safety device recommendations and procedures, was the spark that changed the entire future of the abrasives industry.

In the 1970s, this code received the ultimate endorsement when selected by OSHA as the basis of new federal regulations concerning abrasive wheel machinery. Today, the ever-evolving "Safety Requirements for the Use, Care and Protection of Abrasive Wheels" (commonly known as the ANSI B7.1 standard) continues to mirror the latest technologies and remains the global authoritative abrasives safety standard.



Breakages/Personal Injury

In the event of on-machine breakage of Norton abrasive products, call your local Norton distributor immediately. Whether involving personal injury or not, the abrasive user should leave the equipment and other evidence undisturbed until a Norton sales representative has been notified and conducts an investigation. Prompt action on the part of abrasive users, distributor, and Norton sales personnel is important to ensure swift determination of the breakage cause and to guard against recurrence.



It is the user's responsibility to refer to and comply with ANSI B7.1 and B7.7 – Contact us for a free copy.







Abrasive Safety References













UAMA Approved Safety Icons

The UAMA has approved a new set of standardized icons to be used throughout the Abrasive industry to convey safety information to the users. Below are the approved icon types and their definitions.

ICON TYPES	EXAMPLE
Safety Icon: A pictorial whose purpose is to relay safety related information to the user.	
Hazard Alert Icon: This type of safety icon conveys information primarily related to the nature of a hazard. It contains a graphical depiction of the hazard drawn within a yellow equilateral triangle.	
Prohibition Icon: This type of safety icon conveys actions that should not be taken. It consists of a red circular band with a 45° diagonal red band from upper left to lower right. The icon contains a black depiction of what should not be done within the red band on a white background.	
Mandatory Action Icon: This type of safety icon conveys actions that should be taken to avoid hazards. It consists of a white image within a solid blue or black circular surround shape.	
Proper Machine Use Icon: This type of icon is designed to show the use of the wheel on a proper machine. The icon can be a bit more realistic to show components such as a safety guard and an auxiliary handle. The recommended angle of use may also be depicted.	

ICON	MEANING	ICON	MEANING
	Improper use may break wheel and cause serious injury or death.		Always use wheel guard for angle grinder.
	No side grinding. Cutting only.		Always use wheel guard for non-portable machine.
	No side grinding. Cutting only		Protect your eyes.
	No cutting. Side grinding only.		Protect your face.
	No cutting. Side grinding only, grouped icon.		Protect your lungs against dust.

UAMA Approved Safety Icons *continued*

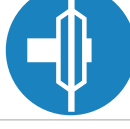
ICON	MEANING	ICON	MEANING
	Do not use a damaged wheel.		Protect your hearing.
	Do not use on High Speed Gas Saws.		Protect your eyes and face.
	Do not use on Angle Grinders.		Protect your eyes and hearing. Combined icon.
	Do not use on die grinders		Protect your eyes, ears and lungs.
	Warning alert symbol.		Protect your hands.
	Read OSHA and ANSI B7.1.		Use matched diameter, relieved flanges.



Coated Abrasive Do's and Don'ts

Coated Abrasive Disc and Wheel Safety Do's and Don'ts

Warning







Improper use may cause wheel breakage and serious injury. Comply with ANSI B7.7, OSHA and safety guide provided with the package. Always follow all manufacturer's recommended procedures and safety instructions. Never exceed tool manufacturer's maximum operating speed.

Exposure to DUST generated from workpiece and/or abrasive materials can result in lung damage and/or other physical injury. Use dust capture or local exhaust as stated in the SDS. Wear government-approved respiratory protection and eye and skin protection. Failure to follow this warning can result in serious lung damage and/or physical injury.

Lead Poisoning can develop as a result of inhalation and/or ingestion of the dust generated from sanding any product containing lead, including lead based paint. Lead Poisoning is an illness which can permanently damage the body's physical, neurological and/or reproductive systems. Care must be taken to avoid the inhalation and/or ingestion of dust containing lead

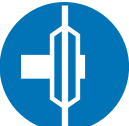
	DO'S	DON'TS
INSPECT / STORAGE / SPEED  	<ul style="list-style-type: none"> • DO read all manuals, operating instructions and warnings • DO read SDS for the disc/wheel and the work-piece material. • DO check all products for damage before mounting. • DO make sure the machine speed does not exceed the speed marked on the package or back up pad. • DO store products prior to use at 35 – 50% relative humidity and 60 – 80°F. 	<ul style="list-style-type: none"> • DON'T use products that have been dropped or damaged. • DON'T use on machines that do not show a MAX RPM speed.
MOUNT / GUARD  	<ul style="list-style-type: none"> • DO use the wheel guard provided with machine. Position it so it protects the operator and covers the wheel. • DO use recommended back up pad or mandrel for the product. • DO run wheels ONLY in direction of directional arrow stenciled on wheel and in core (except Unified Wheels, which can be run in either direction). • DO run discs/wheels in a protected area for one minute before grinding. 	<ul style="list-style-type: none"> • DON'T remove or modify any guard. ALWAYS use a proper guard. • DON'T use excessive pressure when mounting a wheel. Tighten enough only to hold wheel firmly.
PROTECT  	<ul style="list-style-type: none"> • DO wear ANSI Z87+ safety glasses and face protection, if required. • DO wear safety shoes, arm guards, leather gloves and aprons. • DO employ dust controls and/or protective measures appropriate to the material being ground. 	<ul style="list-style-type: none"> • DON'T use products near bystanders if they are not wearing protective equipment.
OPERATE 	<ul style="list-style-type: none"> • DO support work-piece firmly. • DO hold machine firmly in two hands. • DO stop the equipment at once if chattering or vibration occurs during use. Determine cause of the problem and correct before remounting. • DO ease the disc into the work piece at a 5-10o angle to the work piece surface. 	<ul style="list-style-type: none"> • DON'T allow untrained people to handle, store, mount or use discs/wheels. • DON'T twist, jam or bend any wheel. • DON'T force or bump wheel so that the tool motor stalls. • DON'T use discs/wheels in the presence of combustible materials. • DON'T use disc/wheel for applications other than for which they were designed. Refer to ANSI B7.7.

Portable Grinding Safety Do's and Don'ts

	DO'S	DON'TS
INSPECT / SPEED  	<ul style="list-style-type: none"> • DO read all manuals, operating instructions and warnings. • DO read SDS for the wheel and workpiece material. • DO check all wheels for cracks or other damage before mounting. • DO make sure the machine does not exceed the maximum operating speed marked on the wheel. • DO store according to ANSI B7.1. 	<ul style="list-style-type: none"> • DON'T use wheels that have been dropped or damaged. • DON'T use on grinders that do not show a MAX RPM.
MOUNT / GUARD  	<ul style="list-style-type: none"> • DO use an ANSI B7.1 wheel guard. Position it so it protects the operator. • DO be sure wheel hole or threads fit machine properly and that the flanges are clean, flat, undamaged and the proper type. • DO run wheel in a protected area for one minute before grinding. 	<ul style="list-style-type: none"> • DON'T remove or modify any guard. ALWAYS use a proper guard. • DON'T alter a wheel or force it on to the spindle. • DON'T mount more than one wheel on an arbor. • DON'T use excessive pressure when mounting a wheel. Tighten enough only to hold wheel firmly.
PROTECT  	<ul style="list-style-type: none"> • DO wear ANSI Z87+ safety glasses and face protection, if required. • DO wear gloves, hearing and body protection. • DO employ dust controls and/or protective measures appropriate to the material being ground. • DO comply with OSHA regulations 29 CFR 1926.1153 when working on materials containing crystalline silica such as concrete. 	<ul style="list-style-type: none"> • DON'T use wheels near bystanders if they are not wearing protective equipment.
OPERATE 	<ul style="list-style-type: none"> • DO support work-piece firmly. • DO hold grinder firmly with two hands. 	<ul style="list-style-type: none"> • DON'T allow untrained people to handle, store, mount or use wheels. • DON'T use grinding wheels or cutting wheels on pistol grip air Sanders. • DON'T use any cutting wheel for grinding nor apply side pressure on a cutting wheel. Use for CUTTING ONLY. • DON'T use a cutting wheel to cut curves. Cut in straight lines only. • DON'T twist, bend or jam any wheel. • DON'T force or bump wheel so that the tool motor slows or stalls. • DON'T use wheels in the presence of combustible materials. • DON'T use wheels for applications other than for which they were designed.

Dangerous Pairing: Die Grinders and Cut-off Wheels

While die grinders and portable cut-off tools may look similar, they are by no means interchangeable. Several crucial differences exist between the two handheld machines.

GUARD

Cut-off wheels must be used on guarded machines for the safety of the operator and bystanders.

SPEED

Cut-off wheels must be used at or below their maximum operating speed, marked clearly on the side of the wheel. Excessive speed can result in breakage and serious personal injury.

Die grinders often operate above 25,000 rpm and therefore are too fast for abrasive wheels. The speed hazard is increased by the absence of a guard. Portable cut-off tools, however, rotate at speeds compatible with the abrasive wheels for which they are designed. And, their guards prevent use of an oversize wheel.

MOUNTING

Cut-off wheels must be mounted between proper flanges, as described in the national safety standard for abrasive wheels, ANSI B7.1. Die grinders make use of a collet for mounting

Portable cut-off tools use flanges for mounting, flanges designed according to the ANSI B7.1 safety standard.

Now that you have learned the three crucial differences between die grinders and portable cut-off tools – GUARD, SPEED and MOUNTING – be on watch for the dangerous pairing of cut-off wheels and die grinders, and warn your friends and colleagues of the same.

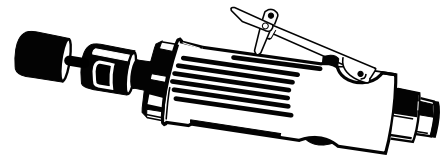

Die Grinder

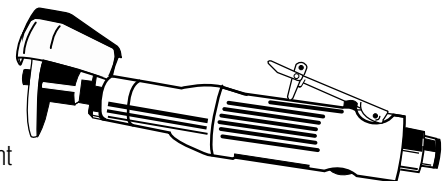

Portable Cut-off Tool

Starting a Grinding Wheel / Ring Test



Pistol Grip Air Sander

A Deadly Equation

Pistol Grip Air Sander + Grinding Wheel = Certain Injury!

- Never use a high-speed air sander as a portable grinder
- Use only sanding discs specifically designed for sanders
- Because the speed of these sanders far exceeds the maximum rated speeds for grinding wheels, a potentially lethal wheel breakage might occur

Starting a Grinding Wheel

ANSI's Procedure for Starting an Abrasive Wheel

This article is designed to remind users of the proper procedure when starting a machine with a new abrasive wheel mounted on it, starting a machine after the machine and wheel have been stored for a period of time, or remounting a wheel. ANSI B7.1 requires the following procedure when starting a newly mounted grinding wheel.

9.8 Starting the Wheel (Requirements)

All abrasive wheels shall be run at operating speeds with the safety guard in place or in a protected enclosure for at least one minute before applying work. During this time no one shall stand in front of or in line with the wheel. (See section 4, for safety guard requirements.) This provision shall apply each time one of the following conditions occur: a) a new wheel has been mounted; or b) a used wheel has been remounted.

E 9.8 Starting the Wheel (Explanatory Information)

An abrasive wheel may be damaged in shipment or storage, or the wheel may be subjected to improper, excessive stresses during mounting. Wheels which have been damaged or are under excessive stress, are likely to fracture within the first minute of rotation at operating speed. While this procedure is most important at the time when an abrasive wheel is mounted or remounted, damage may also occur to a wheel during a shut down of the machine on which it is mounted. The user should evaluate the circumstances and length of machine shut down to determine additional times that the operating rule should be followed.

Improper wheel mounting is a major cause of wheel breakages. Always use proper mounting procedures as outlined in ANSI B7.1, machine manufacturer's instructions and those supplied with the abrasive wheel. Be safe, know and follow the rules!



How to Perform a Ring Test on a Grinding Wheel

One method of grinding wheel inspection is called ring testing. OSHA, ANSI and the grinding wheel manufacturers require this method of grinding wheel inspection. It must be performed BEFORE the wheel is mounted on a grinding machine. Ring testing depends on the damping characteristics of a cracked wheel to alter the sound emitted when the wheel is tapped lightly. It is subject to interpretation by the inspector and is primarily applicable to vitrified bonded wheels. To perform the ring test, wheels should be tapped gently with a light nonmetallic implement, such as the handle of a screw driver for light wheels, or a wooden mallet for heavier wheels.

- Tap wheels about 45 degrees each side of the vertical line and about 1" or 2" from the periphery. Rotate the wheel 45 degrees and repeat the test.
- Large and thick wheels may be given the ring test by striking the wheel on the periphery rather than the side of the wheel.
- A sound and undamaged wheel will give a clear tone. If cracked, there will be a dead sound and not a clear ring and the wheel should not be used.
- Wheels must be dry and free of sawdust when applying the ring test, otherwise the sound may be deadened. The ring test is not applicable to certain wheels because of their size, shape or composition.

Wheel Speed Conversion Table

Conversion Table – Wheel Speeds

REVOLUTIONS PER MINUTE FOR VARIOUS DIAMETERS OF GRINDING WHEELS TO GIVE SURFACE SPEED IN FEET PER MINUTE AS INDICATED (FOR WHEEL MARKING PURPOSES THE CALCULATED RPM FIGURES LISTED BELOW ARE ROUNDED OFF TO THE NEXT 5)

Surface Speed in Feet Per Minute (SFPM)

Diameter of Wheel in Inches	Revolutions Per Minute (RPM)															
	6,500	7,000	7,500	8,000	8,500	9,000	9,500	10,000	12,000	12,500	14,200	16,000	16,500	17,000	19,685	20,000
1	24,828	26,737	28,647	30,558	32,467	34,377	36,287	38,196	45,836	47,745	54,240	61,116	63,025	64,935	75,190	76,395
2	12,414	13,368	14,328	15,278	16,238	17,188	18,143	19,098	22,918	23,875	27,120	30,558	31,510	32,465	37,595	38,195
3	8,276	8,913	9,549	10,186	10,822	11,459	12,096	12,732	15,278	15,915	18,080	20,372	21,010	21,645	25,065	25,465
4	6,207	6,685	7,162	7,640	8,116	8,595	9,072	9,549	11,459	11,940	13,560	15,278	15,755	16,235	18,800	19,100
5	4,966	5,348	5,730	6,112	6,494	6,876	7,258	7,640	9,168	9,550	10,850	12,224	12,605	12,985	15,040	15,280
6	4,138	4,456	4,775	5,092	5,411	5,729	6,048	6,366	7,639	7,960	9,040	10,186	10,505	10,820	12,530	12,730
7	3,547	3,820	4,092	4,366	4,638	4,911	5,183	5,456	6,548	6,820	7,750	8,732	9,005	9,275	10,740	10,915
8	3,103	3,342	3,580	3,820	4,058	4,297	4,535	4,775	5,729	5,970	6,780	7,640	7,880	8,115	9,400	9,550
9	2,758	2,970	3,182	3,396	3,606	3,820	4,032	4,244	5,092	5,305	6,030	6,792	7,000	7,215	8,355	8,490
10	2,483	2,674	2,865	3,056	3,247	3,438	3,629	3,820	4,584	4,775	5,425	6,112	6,300	6,495	7,520	7,640
12	2,069	2,228	2,386	2,546	2,705	2,864	3,023	3,183	3,820	3,980	4,520	5,092	5,250	5,410	6,265	6,365
14	1,773	1,910	2,046	2,182	2,319	2,455	2,592	2,728	3,274	3,410	3,875	4,366	4,500	4,640	5,370	5,455
16	1,552	1,672	1,791	1,910	2,029	2,149	2,268	2,387	2,865	2,985	3,390	3,820	3,940	4,060	4,700	4,775
18	1,379	1,485	1,591	1,698	1,803	1,910	2,016	2,122	2,546	2,655	3,015	3,396	3,500	3,605	4,175	4,245
20	1,241	1,337	1,432	1,528	1,623	1,719	1,814	1,910	2,292	2,390	2,715	3,056	3,150	3,245	3,760	3,820
22	1,128	1,215	1,302	1,388	1,476	1,562	1,649	1,736	2,084	2,170	2,465	2,776	2,865	2,950	3,420	3,470
24	1,034	1,115	1,194	1,274	1,353	1,433	1,512	1,591	1,910	1,990	2,260	2,546	2,625	2,705	3,135	3,185
26	955	1,028	1,101	1,176	1,248	1,322	1,395	1,468	1,762	1,840	2,090	2,352	2,425	2,495	2,890	2,940
28	887	955	1,023	1,092	1,159	1,228	1,296	1,364	1,637	1,705	1,940	2,182	2,250	2,320	2,685	2,730
30	828	891	955	1,018	1,082	1,146	1,210	1,274	1,528	1,595	1,810	2,056	2,100	2,165	2,505	2,545
32	776	836	895	954	1,014	1,074	1,134	1,194	1,432	1,495	1,695	1,910	1,970	2,030	2,350	2,385
34	730	786	843	898	955	1,011	1,067	1,124	1,348	1,405	1,595	1,796	1,855	1,910	2,210	2,245
36	690	742	795	848	902	954	1,007	1,061	1,273	1,330	1,510	1,698	1,750	1,885	2,090	2,120
38	653	704	754	804	854	904	955	1,006	1,206	1,260	1,430	1,608	1,660	1,710	1,980	2,010
40	620	669	716	764	812	860	908	956	1,146	1,195	1,355	1,528	1,575	1,625	1,880	1,910
42	591	636	682	732	775	818	863	908	1,090	1,140	1,295	1,464	1,500	1,545	1,790	1,820

For intermediate diameters not listed use the formula listed in Section 1.2.10 of ANSI B7.1

SFPM = .262 x wheel diameter in inches x RPM.

To convert meters per second (m/s) to SFPM: m/s x 196.85 = SFPM

To convert SFPM to m/s: SFPM/196.85 = m/s.

To convert RPM to SFPM: Wheel Diameter x RPM x 0.262 = SFPM

Silica and What You Need to Know

Background and Health impacts

Silica (SiO₂) is one of the most common minerals in the earth's crust. Glass, beach sand, silicone and granite are all "silica" materials. Products containing silica have been used for thousands of years in building and is a key ingredient in many products we use every day. There are two forms of silica; crystalline and non-crystalline. Crystalline silica is a mineral that occurs in several forms. Quartz, the most common form, is a component of sand, stone, rock concrete, brick, block and mortar. Non-crystalline silica is found in glass, silicon carbide and silicone.

When rocks containing crystalline silica are cut, crushed, ground, drill or used in similar industrial processes, dust particles are produced. These particles are very fine, at least 100 times smaller than ordinary beach sand – known as respirable crystalline silica or RCS. Inhaling very small or respirable crystalline silica particles is most hazardous and may cause multiple diseases such as silicosis, followed in severe cases by lung cancer.

Who is at risk from exposure to crystalline silica?

It is estimated that 2.3 million workers are exposed to crystalline silica on the job. The majority of the workers, about 2 million, are in the construction industry. The hazard exists when specific activities create respirable dust that is released into the air.

The New OSHA Standard

OSHA's recently implemented silica standards for Construction "29 CFR 1926.1153" and General Industry "29 CFR 1910.1053" suggests procedures applicable for work in these environments. This new standard affects all activities that generate silica dust on a jobsite. Trades involving brick, stone, concrete and other materials that are difficult to replace must comply with the standard. This is a change around "process", not specific products.

Impacts on Industry

Industries affected by this regulation include Construction, Glass manufacturing, Pottery products, Structural clay products, Concrete products, Foundries, Cut stone and Stone products, Railroads, Refractory products and Asphalt products manufacturing to name a few. Always read the Safety Data Sheet for the workpiece and abrasive before use.



Product Warranty

WARRANTY – Saint-Gobain Abrasives warrants the products in this catalog to be free from defects in material or workmanship for a period of one year from the date of purchase. Saint-Gobain Abrasives' sole obligation under this warranty shall be to repair or replace, at Saint-Gobain Abrasives' option, any product which is non-conforming provided any such product failure was not caused by a subsequent modification of the product, misuse or a failure to follow any applicable instructions for the product.

EXCEPT FOR THE FOREGOING, SAINT-GOBAIN ABRASIVES EXPRESSLY DISCLAIMS ALL OTHER GUARANTIES AND/OR WARRANTIES, EXPRESS OR IMPLIED, INCLUDING THE WARRANTIES OF MERCHANTABILITY AND FITNESS FOR A PARTICULAR PURPOSE.

Liability Limitation

SAINT-GOBAIN'S LIABILITY FOR ANY LOSS OR DAMAGE ARISING OUT OF OR RESULTING FROM THE USE OF THE PRODUCT SHALL NOT EXCEED THE PURCHASE PRICE THEREOF, REGARDLESS OF WHETHER SUCH LIABILITY ARISES IN CONTRACT, TORT (INCLUDING WITHOUT LIMITATION NEGLIGENCE OR STRICT LIABILITY), OR OTHERWISE, AND IN NO EVENT SHALL SAINT-GOBAIN BE LIABLE FOR INDIRECT, SPECIAL, INCIDENTAL OR CONSEQUENTIAL DAMAGES OF ANY KIND. NO REPRESENTATIVE OF SAINT-GOBAIN, NOR ANY OF SAINT-GOBAIN'S DISTRIBUTORS OR DEALERS, IS AUTHORIZED TO MODIFY THIS WARRANTY OR ISSUE ANY WARRANTY REGARDING THE PRODUCTS IN THIS CATALOG.

Product Quality Complaints

All product quality complaints should be submitted to your local Norton Distributor.

Trademarks

All trademarks used in these pages are trademarks of Saint-Gobain Abrasives unless otherwise indicated.

A275 Original Performance™	Fast Cut™	NorGrip®	Reshaping the World of Precision Grinding™
Abrasive Connection Express®	FastTrack™	NorKut™	Reshaping Your World®
Adalox®	FlexDrum™	NorPor®	RightCut®
Alundum®	FlexEdge™	Norton®	Sand-O-Flex™
AVOS®	Foundry X™	Norton Clipper™	Screen-Bak®
Aztec®	Furioso™	Norton Design® (Parallelogram)	SoftTouch®
Bear-Tex®	Gemini®	Norton Design® (Triple Stripe Design)	Speed-Change™
Because Right Choices Matter™	G-Force™	Norton SG®	Speed-Grip®
Black Ice®	India®	NorZon®	Speed-Lok®
Blaze®	JobPack™	NorZon Plus®	Stick & Sand®
Blue-Bak™	Liquid Ice®	Onyx™	Targa®
Blue-Core™	Long Life™	Pacesetter™	Thin Flex™
BlueFire®	Merit®	Paradigm®	TufBak®
BPR™	MeshPower™	Plyweld®	U-Dex-It™
Century45®	Metalite®	ProSand™	Univel®
Charger™	Mini-Dex™	Pure Ice™	USB™
Classic™	MSL®	QuadroFlex™	Vitrium3®
Clean Bond®	Multi-Air Cyclonic®	Quantum™	Vortex®
Clipper®	Multi-Oilstone®	Rail Cut™	Winter®
Crystolon®	MultiSand™	Rapid Blend®	and others
DiaLast™	The Muscle Behind The Machine®	Rapid Cut™	
Dry Ice®	NEX™	Rapid Finish®	
Duo®	No-Fil®	Rapid Prep™	
Duo Evo™	NORaX®	Rapid Strip®	
Durite®	NorBide®	Red Heat®	



NORTON

SAINT-GOBAIN

The world leader in abrasives for more than 130 years, the Norton brand offers the widest portfolio of grinding, cutting, blending, finishing and polishing solutions which deliver the highest productivity and cost performance ratio in both stock and made-to-order solutions.

NORTON

SAINT-GOBAIN

clipper

For 80 years, the Clipper brand has been a trusted equipment source on the jobsite. Now, the Norton Clipper brand will cut a new path for future growth with an industry-leading line of diamond products, abrasives, and light equipment to tackle even the toughest construction environment.

NORTON

SAINT-GOBAIN

MERIT

The Norton Merit brand offers a comprehensive portfolio of specialty abrasive products for offhand and portable power tools. From quick-change discs and cartridge rolls to flap wheels - feel the power behind Norton Merit.

NORTON

SAINT-GOBAIN

WINTER

The world's leading brand for high-quality, innovative diamond and cBN precision grinding products for the automotive, aerospace, bearing, tools and electronics industries. Norton Winter is quality and precision at its finest.

Reshaping
your
world.

NORTON

SAINT-GOBAIN

CATALOG #7364

ABRASIVE PRODUCTS FOR THE
WELDING AND METAL
FABRICATION MARKET

BECAUSE **RIGHT CHOICES** MATTER™

SAINT-GOBAIN



Our Mission

We offer powerful, precise, user-friendly solutions, which enable our customers to cut, shape and finish all materials even in the most complex and challenging applications. By working closely with end-users and our grinding expert partners, we design and provide customized solutions to secure the best option for performance, cost and safety.

Our Expertise

Norton is the leading brand of Saint-Gobain Abrasives, with more than 135 years of experience in manufacturing abrasives.

We are committed to providing access to our expert's knowledge whenever you need it. Whether it is through our [Process Solutions Program \(PSP\)](#), ongoing training programs, or through on-line expert articles and white papers you can stay up-to-date with Norton where and when you need it.

Bring us your grinding challenges, we have solutions!

Our Commitment

You be the final judge in performance! We are so confident of the superior performance of our abrasive products, as recommended for specific applications, that we invite in-plant tests against any other brand of abrasive product on the market.



Why Tiers Matter

At Norton we believe in delivering right choices that matter. Our abrasives are classified in BEST, BETTER, and GOOD performance/price tiers to help you choose the right product for your specific application every time.

BEST

Our BEST tier products are designed for the customer who is seeking the highest productivity at the lowest total cost.

BETTER

Our BETTER tier products provide an excellent blend of performance and price.

GOOD

And, our GOOD tier products promise the highest quality you expect from the Norton name with a low initial price.

If you need help determining the right tier for your specific needs, don't hesitate to contact us directly or reach out to your Norton sales representative.

METAL FAB CUTTING AND GRINDING

Rough Grinding
Depressed Center Wheels **8**
Cut-off Wheels
Small Diameter Reinforced Cut-off **17**
Circular Saw Reinforced Cut-off **24**
Chop Saw Reinforced Cut-off **25**
High-Speed Reinforced Cut-off **28**
Walk-Behind Reinforced Cut-off **30**
Stationary Saw Reinforced Cut-off **31**
Toolroom Cut-off **32**
Rail Reinforced Cut-off **34**
Foundry
Foundry Cut-off **35**
Portable Snagging **37**

COATED & NON-WOVEN ABRASIVES

Coated Abrasive Basics **42**
Non-Woven Basics **45**
Discs
Fiber Discs **47**
Flap Discs **52**
Non-Woven Discs **58**
Non-Woven Depressed Center Discs **60**
Non-Woven Standard Back-up Pad Discs **62**
Non-Woven Speed-Change Discs **64**
Non-Woven Hook and Loop Discs **65**
Cloth PSA Discs **66**
Paper Discs **69**
Mesh Discs **78**
Film and Foam Finishing Discs **79**
Sanding Accessories **81**
Wheels
Non-Woven Convolute Wheels **84**
Belts
File Belts **89**
Portable Belts **92**
Narrow Belts **94**
Wide Belts **100**
FastTrack Service Made-to-Order Belts **102**
Non-Woven Belts **103**
Rolls / Sheets
Cloth Rolls and Sheets **105**
Paper Rolls and Sheets **108**
Non-Woven Rolls **117**
Sponges / Hand Pads
Abrasive Sponges **118**
Non-Woven Hand Pads and Sponges **120**
Foam Hand Pads **122**

PORTABLE TOOLS AND SPECIALTIES

Mini Angle Sander **124**
Mini Flap Discs **125**
Quick-Change Discs **126**
Non-Woven Quick-Change Discs **134**
Quick-Change Disc Accessories **142**
Die Grinder **143**
Cartridge Rolls **144**
Spiral Rolls **147**
Square/Cross Pads, Overlap Slotted Discs **150**
Spiral Bands **154**
Tapered Cone Points **157**
Mandrels **158**
Test Kits **159**
Non-Woven Specialties **160**
Flap Wheels **162**
Non-Woven Flap Wheels **174**
Arbor Hole (Gangable) Discs **176**
Bore Polishers **177**
Non-Woven Unified Wheels **179**
Mounted Points **183**
Carbide Burrs **184**

PRECISION OFFHAND/ PORTABLE

Bonded Abrasives Basics **189**
Bench and Pedestal Wheels **190**
Mounted Points **194**
Sharpening Stones **200**
Retail Sharpening Stones **202**
Rubbing Bricks **203**

CONSTRUCTION PRODUCTS

Diamond Blades **205**
Diamond Cup Grinders **210**
Diamond Core Bits **211**
Equipment **212**

WIRE BRUSHES

Wire Brush Basics **215**
Wire Cup Brushes **217**
Wire Wheel Brushes **219**
End Brushes **222**
Tube Brushes **224**
Hand Brushes **227**

MASKING PRODUCTS

Tape **229**
Masking Film, Paper, and Sheetting **232**
Micro-Fiber Cloths **233**

SAFETY

Safety Basics **6**
Safety Leadership / References **234**
Safety Icon Meanings **235**
Coated Abrasive Do's and Don'ts **237**
Portable Grinding Safety **238**
Starting a Grinding Wheel / Ring Test **239**
Wheel Speed Conversion Table **240**
Silica Precautions **241**

GENERAL INFORMATION

About Norton **2**
Table of Contents **3**
Machine Index and Catalog Navigation **4**
Product Warranty / Trademarks **242**
Abrasive Solutions **243**



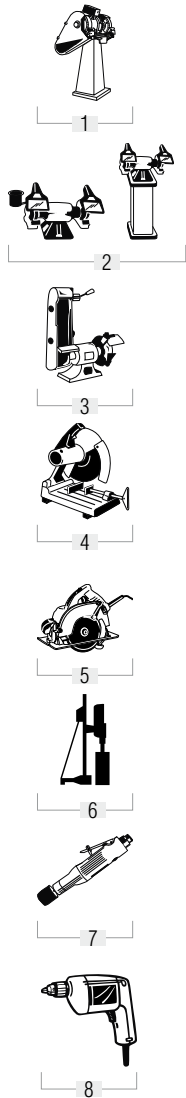

1. Backstand Belt Grinders
Coated Abrasive Backstand Belts 94-95, 99, 102
Non-Woven Backstand Belts 103-104

2. Bench and Pedestal Grinders
Coated Abrasive Large Diameter Flap Wheels 169-172
Non-Woven Convolute Wheels (6"-14" wheels) 84-88
Non-Woven Discs (6"-12" discs) 176
Non-Woven Flap Wheels (6"-8" wheels) 174-175
Non-Woven Unified Wheels (6" wheels) 179-182
Sand-O-Flex Wheels 173
Vitrified Bench and Pedestal Wheels 190-193
Wire Brushes 215-227

3. Benchstand Grinders
Coated Abrasive Benchstand Belts 94-98, 102
Non-Woven Benchstand Belts 103-104

4. Chop Saw Machines
Chop Saw Reinforced Cut-off Wheels 25-27

5. Circular Saws
Circular Saw Diamond Blades 208
Circular Saw Reinforced Cut-off Wheels 24

6. Core Drills
Diamond Core Bits 211

7. Die and Pencil Grinders
Carbide Burrs 184-187
Coated Abrasive Small Diameter Flap Wheels 162-168, 172
Coated Abrasive Specialties 125-133, 142, 143-159
Mounted Points 183, 194-199
Non-Woven Specialties 160-161
Non-Woven Flap Wheels (2"-4" wheels) 174-175
Non-Woven Surface Strip and Unified Wheels (1"-4" wheels) 179-182
Wire Brushes 215-227

8. Drills
Sand-O-Flex Wheels 173
Small Diameter Reinforced Cut-off Wheels (2" and 3" wheels with mandrel) 17-21

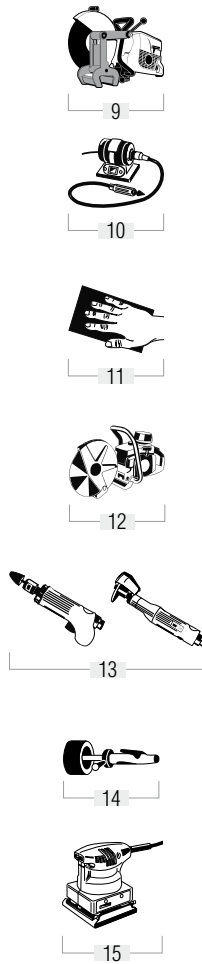

9. Fixed Rail Saws
Rail Reinforced Cut-off Wheels 34

10. Flexible Shaft Motors
Non-Woven Rapid Strip Wheels 179-180
Non-Woven Unified Wheels 179-182

11. Hand Finishing Applications
Coated Abrasive Paper Discs 82
Coated Abrasive Sheets, Rolls and Sponges 105-119
Micro-Fiber Cloths, Masking Tape 229-233
Non-Woven Hand Pads, Rolls and Sponges 117, 120-122
Sharpening Stones and Rubbing Bricks 200-203

12. High-Speed Gas or Electric Saws
High-Speed Reinforced Cut-off Wheels 28-29
High-Speed Saw Diamond Blades 206-207
High-Speed Saws 212

13. Horizontal/Straight Shaft Portable Grinders
Coated Abrasive Flap Wheels with Arbor Holes (3-1/2"-5" wheels) 169-170, 172
Cones and Plugs 37-38, 40
Mounted Points 183, 194-199
Non-Woven Disc Wheels 176
Non-Woven Flap Wheels 162-168
Non-Woven Unified Wheels 179-182
Snagging Straight Wheels 37-39

14. In-Line Drum Sanders
Coated Abrasive Portable Belts 92-93
Non-Woven Portable Belts 103-104

15. Jitterbug Sanders
Coated Abrasive Sheets and Rolls 105-116
Non-Woven Rolls 117
Non-Woven Hand Pads 120-121

Easy-to-Follow Page Guide

Key Questions to Simplify Product Selection

Am I in the right section?

- A** Product
- B** Category overview
- C** General attributes
- D** Correct machine use

How do I narrow choices?

- E** Product design variations

How do I match my end-user needs?

- F** Application recommendations
- G** Best/Better/Good performance color coding
- H** Full application / grit guide

How do I match or upgrade from a competitive product?

- I** Cross reference guide

Machine Index and Catalog Navigation

 16	<p>16. Masonry Saws Large, Compact, and Portable Masonry Saws 213</p>	 22	<p>22. Right Angle/Vertical Shaft Portable Cup Grinders Diamond Cup Grinders 210 Snagging Cup Wheels 37-39 Wire Cup Brushes 215-218</p>
 17	<p>17. Orbital Sanders Coated Abrasive Paper Discs 69-71 Coated Abrasive Small Diameter Cloth PSA Discs 66-68 Film and Foam Finishing Discs 79-80 Mesh Discs 78</p>	 23	<p>23. Sanding Boards Sanding Boards and Coated Abrasive File Strips 111</p>
 18	<p>18. Portable Cut-off Tool Small Diameter Reinforced Cut-off Wheels (1-1/2"-4" wheels) 17-21</p>	 24	<p>24. Stationary Chop Saws Large Diameter Reinforced Cut-off Wheels 31</p>
 19	<p>20. Portable File Belt Sanders Coated Abrasive File Belts 89-91 Non-Woven File Belts 103-104</p>	 25	<p>25. Stationary Disc Sanders Coated Abrasive Large Diameter Cloth PSA Discs (10"-24" discs) 66-68</p>
 20	<p>21. Right Angle/Vertical Shaft Portable Grinders Coated Abrasive Fiber Discs 47-51 Coated Abrasive Film and Foam Finishing Discs 79-80 Coated Abrasive Flap Discs 52-57 Coated Abrasive Paper Discs 69-71 Coated Abrasive Quick-Change Discs 126-133 Depressed Center Grinding Wheels, Notchers, Saucers and Type 29 Wheels 8-15 Diamond Blades 208 Non-Woven Depressed Center Discs 58-61 Non-Woven Discs 62-65, 134-142 Non-Woven Nylon Stem Mounted and End Brushes 222-226 Pneumatic Air Tool 124 Right Angle Grinder Reinforced Cut-off Wheels, Type 01/41 and Type 27/42 17-20, 22-23 Wire Brushes 217-227</p>	 26	<p>26. Walk-Behind Saws Diamond Blades 209 Reinforced Cut-off Wheels 30 Walk-Behind Push Saws 212 Wire Brushes 220</p>
 21			

COATED & NONWOVEN ABRASIVES
Flap Discs

BLAZE R980P CERAMIC ALUMINA

- Latest generation ceramic alumina flap discs with 100% through fiber flap discs in addition, steel, metal, chrome, stainless steel, titanium and copper.
- High performance flap discs with 100% through fiber flap discs in addition, steel, metal, chrome, stainless steel, titanium and copper.
- High strength flap discs with 100% through fiber flap discs in addition, steel, metal, chrome, stainless steel, titanium and copper.
- High strength flap discs with 100% through fiber flap discs in addition, steel, metal, chrome, stainless steel, titanium and copper.

BLUESFIRE R984P ZIRCONIA ALUMINA

- High performance flap discs with 100% through fiber flap discs in addition, steel, metal, chrome, stainless steel, titanium and copper.
- High strength flap discs with 100% through fiber flap discs in addition, steel, metal, chrome, stainless steel, titanium and copper.
- High strength flap discs with 100% through fiber flap discs in addition, steel, metal, chrome, stainless steel, titanium and copper.

GEMINI R766 ALUMINUM OXIDE

- Abrasive flap discs with 100% through fiber flap discs in addition, steel, metal, chrome, stainless steel, titanium and copper.
- High strength flap discs with 100% through fiber flap discs in addition, steel, metal, chrome, stainless steel, titanium and copper.
- High strength flap discs with 100% through fiber flap discs in addition, steel, metal, chrome, stainless steel, titanium and copper.

METAL R826 ZIRCONIA ALUMINA

- Abrasive flap discs with 100% through fiber flap discs in addition, steel, metal, chrome, stainless steel, titanium and copper.
- High strength flap discs with 100% through fiber flap discs in addition, steel, metal, chrome, stainless steel, titanium and copper.
- High strength flap discs with 100% through fiber flap discs in addition, steel, metal, chrome, stainless steel, titanium and copper.

COATED & NONWOVEN ABRASIVES
Flap Discs

Part Number	Material	Size	Weight	Speed	Part Number	Material	Size	Weight	Speed
FLD100	Alumina	100	1.5	10000	FLD100	Alumina	100	1.5	10000
FLD125	Alumina	125	2.0	10000	FLD125	Alumina	125	2.0	10000
FLD150	Alumina	150	2.5	10000	FLD150	Alumina	150	2.5	10000
FLD175	Alumina	175	3.0	10000	FLD175	Alumina	175	3.0	10000
FLD200	Alumina	200	3.5	10000	FLD200	Alumina	200	3.5	10000
FLD225	Alumina	225	4.0	10000	FLD225	Alumina	225	4.0	10000
FLD250	Alumina	250	4.5	10000	FLD250	Alumina	250	4.5	10000
FLD275	Alumina	275	5.0	10000	FLD275	Alumina	275	5.0	10000
FLD300	Alumina	300	5.5	10000	FLD300	Alumina	300	5.5	10000
FLD325	Alumina	325	6.0	10000	FLD325	Alumina	325	6.0	10000
FLD350	Alumina	350	6.5	10000	FLD350	Alumina	350	6.5	10000
FLD375	Alumina	375	7.0	10000	FLD375	Alumina	375	7.0	10000
FLD400	Alumina	400	7.5	10000	FLD400	Alumina	400	7.5	10000
FLD425	Alumina	425	8.0	10000	FLD425	Alumina	425	8.0	10000
FLD450	Alumina	450	8.5	10000	FLD450	Alumina	450	8.5	10000
FLD475	Alumina	475	9.0	10000	FLD475	Alumina	475	9.0	10000
FLD500	Alumina	500	9.5	10000	FLD500	Alumina	500	9.5	10000
FLD525	Alumina	525	10.0	10000	FLD525	Alumina	525	10.0	10000
FLD550	Alumina	550	10.5	10000	FLD550	Alumina	550	10.5	10000
FLD575	Alumina	575	11.0	10000	FLD575	Alumina	575	11.0	10000
FLD600	Alumina	600	11.5	10000	FLD600	Alumina	600	11.5	10000
FLD625	Alumina	625	12.0	10000	FLD625	Alumina	625	12.0	10000
FLD650	Alumina	650	12.5	10000	FLD650	Alumina	650	12.5	10000
FLD675	Alumina	675	13.0	10000	FLD675	Alumina	675	13.0	10000
FLD700	Alumina	700	13.5	10000	FLD700	Alumina	700	13.5	10000
FLD725	Alumina	725	14.0	10000	FLD725	Alumina	725	14.0	10000
FLD750	Alumina	750	14.5	10000	FLD750	Alumina	750	14.5	10000
FLD775	Alumina	775	15.0	10000	FLD775	Alumina	775	15.0	10000
FLD800	Alumina	800	15.5	10000	FLD800	Alumina	800	15.5	10000
FLD825	Alumina	825	16.0	10000	FLD825	Alumina	825	16.0	10000
FLD850	Alumina	850	16.5	10000	FLD850	Alumina	850	16.5	10000
FLD875	Alumina	875	17.0	10000	FLD875	Alumina	875	17.0	10000
FLD900	Alumina	900	17.5	10000	FLD900	Alumina	900	17.5	10000
FLD925	Alumina	925	18.0	10000	FLD925	Alumina	925	18.0	10000
FLD950	Alumina	950	18.5	10000	FLD950	Alumina	950	18.5	10000
FLD975	Alumina	975	19.0	10000	FLD975	Alumina	975	19.0	10000
FLD1000	Alumina	1000	19.5	10000	FLD1000	Alumina	1000	19.5	10000

What are the Leading Products by Tier?

J Tiers by color-coding: Best, Better, Good
K Features and benefits
L New, improved, and/or expanded offering

How Do I Find What I Want Now That I Know What I Want?

M Visual identification
N Key product attributes
O Full specification and product number

⚠ WARNING

Improper use of abrasive products might cause grinding wheel breakage and serious injury. Comply with ANSI B7.1, OSHA and Safety Guide furnished with package. Don't overspeed, abuse, or drop wheel. Always use a guard, personal protective equipment and proper mounting procedures.



Speeds

Check machine spindle speed and speed listed on machine against safe maximum operating speed marked on the grinding wheel. Do not overspeed the wheel.

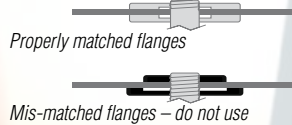

Flanges

When mounting most grinding wheels, use flanges of equal diameter and bearing surface. For exceptions, see ANSI B7.1.



Safety Gloves

Grinding applications are conducted in harsh environments. The use of proper fitting gloves is recommended.



Wheel Guard

Always use the wheel guard as supplied by the machine manufacturer, in the proper position.



Do Not Use Damaged Wheel

Always check each wheel for cracks or damage before use. Never use a damaged wheel.



Eye/Face Protection

Always wear government-approved face and eye protection when using abrasive products.



Hearing Protection

Use of abrasive products can create elevated sound levels. Hearing protection must be worn where required.



Safety Guides, SDS and Wheel Warning Messages

Before using any abrasive materials, READ:

- The Safety Guides
- Wheel Warning Messages
- Safety Data Sheets (SDS)

All Norton products provide information pertaining to safe use. Please take the time to read it carefully. Contact suppliers of the workpiece and abrasive materials for copies of the SDS if one is not readily available.



Dust Protection

Exposure to dust generated from workpiece and/or abrasive materials can result in lung damage and/or other physical injury.

Use dust capture or local exhaust as stated in the SDS. Wear government-approved respiratory protection and eye and skin protection. Failure to follow this warning can result in serious lung damage and/or physical injury.

This is a general dust warning and does not cover specific situations. For more information, refer to the SDS dust warning provided with your products, and workpiece.

Please see pages [234 - 241](#) for additional safety information



when the going
gets rough

**RELY ON
NORTON INNOVATION**

For stock removal, rough blending,
cleaning castings and welds...Norton
depressed center wheels are
constructed to tackle the demanding
work of all material types.



Depressed center wheels may also be referred to as raised hub wheels or by their shape designation of "Type", with Type 27 being the most popular. The depressed center design allows the flange/lock nut to recess within the wheel so that it can be used for various grinding and cutting applications. Depressed center wheels are designed to handle the most severe right angle grinding applications from heavy stock removal to rough blending. More recently, depressed center wheels have been designed to increase the utility of the tool for cut-off applications. While large right angle grinders (7" & 9") have been around for many years, small or mini grinders that handle 4", 4-1/2", 5", and 6" wheels have made this machine, and wheel category, the most popular in power tools.

- Applications:** Grinding, stock removal, edge chamfering, beveling, weld blending, and cutting-off
- Size Range:** 2" – 9"
- Thickness Range:** .040" – 1/4"
- Grit Range:** 24 – 46 grits for stock removal; 60, 80 grits for blending and finishing
- Abrasive Grain:** Ceramic Alumina, Diamond, Zirconia Alumina, Aluminum Oxide, Silicon Carbide
- Mounting Options:** Plain hole (3/8", 5/8" and 7/8") and discard mount (5/8"-11)
- Shape:** Type 27, Type 28, Type 29
- Machine Used:**



RIGHT ANGLE GRINDER

How to Pick the Right Wheel

DEPRESSED CENTER WHEEL DESCRIPTION CODES

BLANK = All Purpose ALU = Aluminum FC = Fast Cut HD = Heavy Duty INOX/SS = Contaminant Free LL = Long Life XXL = Extra Long Life
 ■ = Aluminum ■ = Foundry ■ = Masonry ■ = Stainless ■ = Steel / Metal

DESCRIPTION CODE DEFINITIONS

BLANK = All Purpose	Where an excellent blend of cut rate and life is needed.
ALU = Aluminum	Specially formulated bond for reduced loading and surface contamination while cutting aluminum and soft materials.
FC = Fast Cut	Where fast stock removal is needed, or the application only allows for low-pressure or under-horsepowered grinders.
HD = Heavy Duty	Triple reinforced for the most aggressive foundry applications
INOX/SS = Contaminate Free	Contain <0.1% iron, sulfur or chlorine for rust-free and corrosion-free results. Will not contaminate stainless steel.
LL = Long Life	Where durability is needed due to severe application, and when horsepower of the grinder allows for heavy pressure.
XXL = Extra Long Life	Offers 50% more life and metal removal than standard aluminum oxide wheels.

How to Pick the Right Mount

Most wheel sizes come with a plain hole or a discard mount option. While the plain hole has a small, initial cost advantage, the discard mount can provide a labor cost advantage with the quicker wheel change.

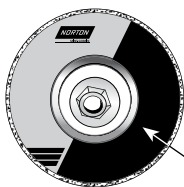

Mini-Mount Hub

Our unique, patented mini-mount hub used on 4-1/2" and 5" depressed center wheels provides up to 30% more wheel life because the hub covers just a small surface area, providing maximum grinding area exposure and usage.

Standard throw-away hub size

Why Choose Depressed Center Wheels?

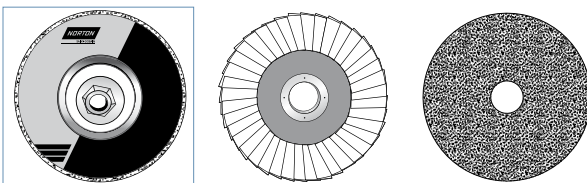

Depressed Center Wheels vs. Flap Discs or Fiber Discs

- Up to 5X life over flap discs, less downtime and inventory
- Up to 100X life over fiber discs, less downtime and inventory
- Rigidity for severe operations and high power grinders
- 1/8" wheels can be used for cutting and grinding
- Can be used to grind inside corners at outer edge of wheel

Type-To-Application Recommendation Guide

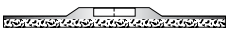
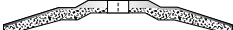
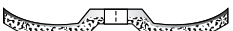
Wheel Type/Thickness	Applications	90° ANGLE	30° ANGLE	15° ANGLE
 TYPE 27 .040", .045", and 1/16" Type 27/42 RightCut 3/32" and .125" Type 27/42	Type 27 wheels are essentially straight wheels that have a "depressed center/ raised hub". Different types of fiberglass reinforcement mesh give the product stability for use on the periphery, on the face, or a combination of the two. Cutting only, where fast cutting and low kerf loss are desired	◆		
1/8" Type 27	For multiple applications ranging from cutting-off, notching and light-duty side grinding	◆	◆	
1/8" Pipe Notcher Type 27	2-1/2 pieces of reinforcement; durable face grinding; root pass grinding without removing pipe material	◆	◆	
1/8" Type 27 Flexible	For light stock/blending/finishing/polishing		◆	
.140" and 1/8" Type 27 Foundry Notchers	Triple-reinforced for grinding steel and dirty/scale-covered castings; removing and cleaning gates and risers	◆	◆	
1/4" Type 27 Foundry Snaggers	For light- to heavy-duty grinding on the bottom/face of the wheel Designed for cleaning parting lines, pads and slag		◆	
1/4" Type 27 Heavy-Duty Foundry	Triple-reinforced for the most aggressive foundry applications		◆	
 TYPE 28 1/4" Type 28 Saucers	Type 28 wheels are constructed with a downward angle built into the grinding section to facilitate a flatter grinding angle. These wheels can only be used on the face and never on the periphery for cutting-off. Smooth, gouge-free grinding at shallow angles			◆
 TYPE 29 1/8" Type 29 Flexible, AVOS	Type 29 wheels are constructed with an upward angle built into the grinding section to provide full face contact for light stock removal and blending operations. These wheels can only be used on the face and never on the periphery for cutting-off. Polishing and blending applications			◆

Material/Application-To-Product Recommendation Guide

	BEST		BETTER	GOOD		
	Quantum3	NorZon Plus	BlueFire	Gemini	Metal	Masonry
CUTTING						
Mild Carbon / High Tensile Steel	◆	◆	◆	◆	◆	
Stainless Steel / Alloys	◆	◆	◆	◆	◆	
Contaminate Free*			◆ FC/INOX/SS	◆ INOX/SS		
Cast Iron	◆	◆		◆		
Gray Iron						
Aluminum / Bronze / Brass				◆ ALU		
Asphalt / Brick / Concrete						◆
Fiberglass / Plastic						◆
NOTCHING						
Mild Carbon / High Tensile Steel	◆	◆	◆	◆	◆	
Stainless Steel / Alloys	◆	◆	◆	◆ INOX/SS		
Contaminate Free*			◆ FC/INOX/SS	◆ INOX/SS		
Cast Iron	◆	◆	◆ Foundry	◆		
GRINDING						
Mild Carbon / High Tensile Steel	◆	◆	◆	◆		
Stainless Steel / Alloys	◆		◆	◆		
Contaminate Free*	◆		◆ FC/INOX/SS	◆ INOX/SS		
Cast Iron		◆	◆ Foundry	◆		
Gray Iron	◆		◆ Foundry	◆		
Aluminum / Bronze / Brass				◆ ALU		
Asphalt / Brick / Concrete						◆
BLENDING						
Mild Carbon / High Tensile Steel				◆ Flexible		
Stainless Steel / Alloys				◆ Flexible		
Aluminum / Bronze / Brass				◆ Flexible		
Fiberglass / Plastic				◆		

Typical Steel, Stainless Steel, Cast Iron Products: Angle Iron, Bar Stock, Ductile Pipe, Channel Iron, Decking, Rebar, I-Beams, Rail Steel, Studs, Tubing, and Welds
 * For use in nuclear and food industry applications that require contaminant free (<0.1% iron, sulfur or chlorine)

Cross Reference Guides

Type 27 and 28 – 1/8" and 1/4"

NORTON	TOTAL PERFORMANCE						INITIAL PRICE				SPECIALTY		
	BEST		BETTER		GOOD		BETTER		GOOD				
	Quantum3	NorZon Plus LL	NorZon Plus	BlueFire	BlueFire FC/INOX/SS	Gemini XXL	Gemini	Gemini Fast Cut	Gemini SS	Metal	BlueFire Foundry	Gemini ALU	Masonry
3M	Cubitron II	-	-	-	-	High Perform., Green Corps	-	-	-	-	-	-	-
Arc	-	-	-	-	-	-	Predator A24R	-	-	-	-	-	-
Brilliant	-	-	-	-	Brill-Max Z24R	-	Brill-Tex A24UHPXL, A30T	Brill-Tex A24R Super-G	Brill-Tex A30P	Hornet Metal	-	Brill-Tex 30ALU	Brill-Tex C30P, Hornet Concrete
Bullard	-	-	TA24S	ZA24R Competitor	ZA24R	-	A24R	A24N	A46Q	A24R Competitor	-	AL36N	C24R
Camel	-	-	-	-	ZA24T	-	A24R	Ultra A24-N-BF, A24T Super Quickie Cut	WA24S	A24N, R&T Fast Cut	-	A30N, Fast Cut	C24R
DeWalt	-	XP Ceramic	-	XP	-	HP	-	-	HP SS	Metal	-	-	-
Flexovit	-	Flexon ZA24P ZA30T	Flexon ZA20Q	Metalhog, AXT24S	-	-	High Perform. A24/30T	High Performance A30S, Specialist A30Q & R	Free Grind A30Q	-	Flexon ZA16U	Specialist A24ALU	High Perform. C24/30P
Metabo	M-Calibur	-	-	ZA24T	-	-	A24R & T	A24N	A360	-	-	A36M	C24N
Pearl	-	-	-	-	Z24T	-	Premium Metal A24S, Redline Max A/WA24S	Premium Metal A24R, Redline Max A/WA24R	WA24R, SRT24	Silver Line A24R & S	-	D.A. Series AL24M	Silver Line C24S
Pferd	SG-Elastic Ceramic C024Q	-	-	ZA SGP, ZA T SGP	ZA R SGP, Z-SG	SG-Elastic	A-PS, A-SG	-	A-SG INOX, A-PS INOX	-	-	A-SG ALU	S-SG, Masonry
Sait	The Ultimate Grind	Saitech Ultimate Perform.	Saitech Attacker, Pipeline	Z24R Z-Tech	Stainless	-	A24R, A24Turbo	A24N	XA24Q	A24T	CA24R - Foundry	A46N-ALU	C24N
Tyrolit	-	-	-	ZA24P-BFX	ZA24N-BFX	-	A30S & Q-BFX	A30R-BFX	A30-BF INOX	A30-BF	ZZA24R-BFX	A36N-BFX WA46-BF	C30-BF
Walter	-	-	-	Allsteel XX	Double-X	Allsteel	HP	-	Stainless	-	-	-	-
Weiler	Tiger Ceramic	-	-	Tiger Zirc	Tiger Inox	Tiger LL	Wolverine A24R	-	-	Wolverine A24N	-	-	-

Type 27 – Flexible 1/8"

GOOD	
NORTON Gemini Flexible	
Brilliant	Brill-Flex
Bullard	Flexlite AC
Camel	FGF, Special Wheel
Flexovit	Flexcel
Metabo	Z-Plus
Pearl	Flexible AC
Pferd	SG-Flex
Sait	Challenger II
Walter	Flexcut





Best choice for stainless and carbon steel applications; efficiently grinds and cuts a variety of materials from alloys to gray iron

QUANTUM3 CERAMIC ALUMINA

- 100% next-generation, uniquely-shaped, ceramic alumina abrasive grain and tough new bond system result in 5-6 times the life of aluminum oxide wheels and up to 100% increase in performance and life over competitive ceramic wheels
- Significantly increase production, for the lowest total grinding cost of any wheel in the market place today
- Better operator control, improved comfort, and exceptional finished part quality with a more robust, sharper, yet smoother cutting action; wheels don't grab or dig



Best for metal plate, pipe, tubing, cast iron, carbon and mild steel, foundry and welding applications, and ceramics

DIALAST DIAMOND WHEELS

- A combination of high-quality diamond and advanced brazed single-layer bonding technology for extra-long life versus conventional abrasives or other vacuum-brazed diamond tools
- Retains diamond grains and wheel shape for full life with low sparks, while keeping a continuous grinding depth for exceptional wheel life; less blade changes reduce downtime and labor costs
- Environmentally friendly design generates minimal dust for less clean-up and safer working conditions



Better choice for stainless steel, carbon steel, alloys and gray iron

BLUEFIRE ZIRCONIA ALUMINA / A/O BLEND

- A blend of the most advanced zirconia alumina and premium aluminum oxide abrasives delivers 2 to 3 times the life of aluminum oxide wheels
- Broad utility; from light-to heavy-pressure applications
- Engineered specifically to deliver fast cut rate; excellent blend of performance and price



Good choice for steel and ferrous metals as well as specialty applications in aluminum and foundries

GEMINI ALUMINUM OXIDE

- Quality aluminum oxide for consistent performance at an economical price
- High-performance bond and wheel hardness are designed for fast cut while retaining excellent wheel life
- Versatile, general purpose specification for use on variety of materials including 400 series stainless, hard carbon steels, soft carbon steels
- Gemini XXL - fastest 100% aluminum oxide wheels on the market today with 50% more life and metal removal than standard aluminum oxide wheels



Good choice for steel/ferrous metal applications with low initial price

METAL ALUMINUM OXIDE

- Durable bond and wheel hardness are designed to provide a good mix of cut rate and life
- Good choice when low initial price is needed for small jobs or newer operators
- Metal (Aluminum Oxide) engineered for all steel/ferrous materials



Good choice for masonry applications with low initial price

MASONRY SILICON CARBIDE

- Durable bond and wheel hardness are designed to provide a good mix of cut rate and life
- Good choice when low initial price is needed for small jobs or newer operators
- Masonry (Silicon Carbide) for masonry materials such as concrete, brick and asphalt



TIER:	BEST	GOOD
TRADENAME:	NORZON PLUS	GEMINI XXL
SHAPE:	Type 27	Type 27
ABRASIVE:	Ceramic Alumina/ Zirconia Alumina	Aluminum Oxide
MATERIAL:	STAINLESS STEEL/METAL	STAINLESS STEEL/METAL

SIZE (D x T x H)	MAX. RPM	STD. PKG.	PART #	PART #
1/8" (5/32") – Pipe Notching – Type 27				
4-1/2 x 1/8 (5/32) x 5/8-11	13,580	10		662533 70272 XXL
4-1/2 x 1/8 (5/32) x 7/8	13,580	25		662533 70271 XXL
5 x 1/8 (5/32) x 5/8-11	12,225	10		662533 70273 XXL
5 x 1/8 (5/32) x 7/8	12,225	25		662528 42038 XXL
6 x 1/8 (5/32) x 5/8-11	10,185	10		662528 41193 XXL
6 x 1/8 (5/32) x 7/8	10,185	20		662528 35580 XXL
7 x 1/8 (5/32) x 5/8-11	8,600	10	662529 39184	662533 70274 XXL
7 x 1/8 (5/32) x 7/8	8,600	20		662528 35581 XXL
9 x 1/8 (5/32) x 5/8-11	6,600	10	662530 49066	662533 70275 XXL
9 x 1/8 (5/32) x 7/8	6,600	20		662533 70276 XXL

Pipe Notchers are to be used for cutting/notching only.

See Type 27 .040" – 1/4" Foundry, Type 28 Saucer, Type 27 Flexible, and Type 29 Blending Wheels at the end of this section.



TIER:	BEST	BEST	BETTER	GOOD	GOOD	GOOD
TRADENAME:	QUANTUM3	NORZON PLUS	BLUEFIRE	GEMINI	METAL	MASONRY
SHAPE:	Type 27	Type 27	Type 27	Type 27	Type 27	Type 27
ABRASIVE:	Ceramic Alumina	Ceramic Alumina/ Zirconia Alumina	Zirconia Alumina/ Aluminum Oxide	Aluminum Oxide	Aluminum Oxide	Silicon Carbide
MATERIAL:	STAINLESS STEEL/METAL	STAINLESS STEEL/METAL	STAINLESS STEEL/METAL	STAINLESS STEEL/METAL	STAINLESS STEEL/METAL	MASONRY

SIZE (D x T x H)	MAX. RPM	STD. PKG.	PART #	PART #	PART #	PART #
1/8" – Cutting / Notching / Light Grinding – Type 27						
3 x 1/8 x 3/8	18,000	25	662528 42177			
4 x 1/8 x 3/8	15,280	25	662528 42004	662528 43178	662528 42016	
4 x 1/8 x 5/8	15,280	25	662528 42005	662528 43176	662528 42017	662528 42014 662528 42013
4-1/2 x 1/8 x 5/8-11	13,580 10 13,580 10	662528 39423	662528 43323	662528 43211	662528 43590	662528 43609
4-1/2 x 1/8 x 7/8	13,580 25 13,580 25	662528 39424	662528 43324	662528 43191 FC/INOX/SS 662528 43212	662528 42029 ALU 46 662528 43591	662528 43611 662528 43601
5 x 1/8 x 5/8-11	12,225 10 12,225 10	662528 39425	662528 43330	662528 43215 662528 43195 FC/INOX/SS		662528 43615
5 x 1/8 x 7/8	12,225 25 12,225 25	662528 39426	662528 43331	662528 43216 662528 43194 FC/INOX/SS	662528 43596	662528 43616
6 x 1/8 x 5/8-11	10,185 10	662528 39427	662528 41891	662528 43199 FC/INOX/SS	662528 33965	
6 x 1/8 x 7/8	10,185 20 10,185 20	662528 39428		662528 43202 662528 43198 FC/INOX/SS	662528 01864	
7 x 1/8 x 5/8-11	8,600 10 8,600 10	662528 39429	662529 38855	662528 43233 662528 43183 FC/INOX/SS	662529 39259	07660 702678
7 x 1/8 x 7/8	8,600 20 8,600 25*	662528 39430	662529 38854	662528 43234	662529 39207	07660 775956 5-Pk
9 x 1/8 x 5/8-11	6,600 10 6,600 10	662528 39431	662530 48897	662528 43244 662528 43187 FC/INOX/SS	662530 48983	
9 x 1/8 x 7/8	6,600 20 6,600 20	662528 39432	662530 48896	662528 43245 662528 43186 FC/INOX/SS	662530 48994	

* 5-wheel Job Packs; wheels are packed 5 wheels/Pack, with 5 Job Packs/carton. Order per each wheel in standard package quantities of 25. Order in multiples of 25.

DEPRESSED CENTER WHEEL DESCRIPTION CODES

BLANK = All Purpose	ALU = Aluminum	FC = Fast Cut	HD = Heavy Duty	INOX/SS = Contaminant Free	LL = Long Life	XXL = Extra Long Life
■ = Aluminum	■ = Foundry	■ = Masonry	■ = Stainless	■ = Steel / Metal		



TIER:	BEST	BEST	BETTER	GOOD	GOOD
TRADENAME:	QUANTUM3	NORZON PLUS	BLUEFIRE	GEMINI / GEMINI XXL	METAL OR MASONRY
SHAPE:	Type 27	Type 27	Type 27	Type 27	Type 27
ABRASIVE:	Ceramic Alumina	Ceramic Alumina/ Zirconia Alumina	Zirconia Alumina/ Aluminum Oxide	Aluminum Oxide	Aluminum Oxide – Metal Silicon Carbide – Masonry
MATERIAL:	STAINLESS STEEL/METAL	STAINLESS STEEL/METAL	STAINLESS STEEL/METAL	STAINLESS STEEL/METAL	STAINLESS STEEL/METAL MASONRY

SIZE (D x T x H)	MAX. RPM	STD. PKG.	PART #	PART #	PART #	PART #	PART #
1/4" – Grinding – Type 27							
3 x 1/4 x 3/8	18,000	25		662528 42178		662528 42179	
4 x 1/4 x 3/8	15,280	25	662533 71180	662528 42002	662528 43179	662528 42018	
4 x 1/4 x 5/8	15,280	25	662533 71181	662528 42003	662528 43177	662528 42020 FC	662528 42011
	15,280	25				662528 42019	662528 42010 Masonry
	15,280	25				662528 42183 ALU 46	
4-1/2 x 3/16 x 7/8	13,580	25		662528 43592		662528 43592	
4-1/2 x 1/4 x 5/8-11	13,580	10	662533 70793	662528 43326	662528 43213	662528 43593	662528 43605
	13,580	10		662528 43327 LL	662528 43193 FC/INOX/SS	662528 43585 FC	662528 43599 Masonry
	13,580	10				662528 42032 INOX/SS	
	13,580	10				662528 43785 XXL	
	13,580	10				662528 42031 ALU 46	
	13,580	40					662528 19559
4-1/2 x 1/4 x 7/8	13,580	10 V		662528 29541 2-Pk	662528 42162 2-Pk	662528 42163 2-Pk	
	13,580	25	662533 70794	662528 43328	662528 43214	662528 43594	662528 43607
	13,580	25			662528 43192 FC/INOX/SS	662528 43584 FC	662528 43600 Masonry
	13,580	25				662528 42033 INOX/SS	
	13,580	25				662528 43784 XXL	
	13,580	25				662528 42034 ALU 46	
5 x 1/4 x 5/8-11	13,580	50					662528 36796
	12,225	10 V		662528 29540 2-Pk	662528 42164 2-Pk	662528 42165 2-Pk	
	12,225	10	662533 70795	662528 43332	662528 43217	662528 43597	662528 43613
5 x 1/4 x 7/8	12,225	10		662528 43333 LL	662528 43197 FC/INOX/SS	662528 43787 XXL	
	12,225	25	662533 70796	662528 43334	662528 43218	662528 43598	662528 43614
	12,225	25				662528 42040 INOX/SS	
	12,225	25				662528 43786 XXL	
6 x 1/4 x 5/8-11	12,225	25				662528 42039 ALU 46	
	10,185	10	662533 70797	662528 41920	662528 43224	662528 32390	
	10,185	10				662528 43789 XXL	
6 x 1/4 x 7/8	10,185	20	662533 70798	662528 09376	662528 43203	662528 01865	
	10,185	20				662528 43788 XXL	
	10,185	20				662528 43788 XXL	
7 x 1/4 x 5/8-11	8,600	10	662533 70799	662529 17881	662528 43235	662529 40147 FC	662529 12633
	8,600	10		662528 35578 LL	662528 43185 FC/INOX/SS	662529 40148 LL	076607 75942 Masonry
	8,600	10				662528 43791 XXL	
	8,600	10				662529 40514 ALU 24	
	8,600	25*					076607 75940 5-Pk
7 x 1/4 x 7/8	8,600	20	662533 70800	662529 17880	662528 43236	662529 40098 LL	
	8,600	20				662528 43790 XXL	
	8,600	20				662529 40516 ALU 24	
	8,600	25*					076607 75936 5-Pk
9 x 1/4 x 5/8-11	6,600	10	662533 70801	662530 21634	662528 43246	662530 49105 FC	076607 75937 Masonry
	6,600	10		662528 30728 LL		662530 49104 LL	
	6,600	10				662528 43793 XXL	
	6,600	10				662530 49045 ALU 24	
	6,600	25*					076607 75938 5-Pk
9 x 1/4 x 7/8	6,600	20	662533 70802	662530 21633	662528 43247	662530 49077 FC	
	6,600	20		662530 49069	662528 43188 FC/INOX/SS	662530 48991 LL	

* 5-wheel Job Packs; wheels are packed 5 wheels/Pack. with 5 Job Packs/carton. Order per each wheel in standard package quantities of 25. Order in multiples of 25.
 V Vendible 2-wheel Package. Ideal for vending machings and small jobs. 5 packs/carton. Order in multiples of 10.

See 1/4 inch thick Type 27 Foundry and Type 28 Saucer Wheels on the next page.

DEPRESSED CENTER WHEEL DESCRIPTION CODES							
BLANK = All Purpose	ALU = Aluminum	FC = Fast Cut	HD = Heavy Duty	INOX/SS = Contaminant Free	LL = Long Life	XXL = Extra Long Life	
■ = Aluminum	■ = Foundry	■ = Masonry	■ = Stainless	■ = Steel / Metal			



TIER:	BEST	BEST	BEST	BEST	BETTER	GOOD
TRADENAME:	QUANTUM3	NORZON PLUS	DIALAST	DIALAST	BLUEFIRE	GEMINI
SHAPE:	Type 28	Type 28	Type 29	Reversible	Type 28	Type 28
ABRASIVE:	Ceramic Alumina	Ceramic Alumina/ Zirconia Alumina	Diamond	Diamond	Zirconia Alumina/ Aluminum Oxide	Aluminum Oxide
MATERIAL:	STAINLESS STEEL/METAL	STAINLESS STEEL/METAL	STAINLESS STEEL/METAL	STAINLESS STEEL/METAL	STAINLESS STEEL/METAL	STAINLESS STEEL/METAL

SIZE (D x T x H)	MAX. RPM	STD. PKG.	PART #	PART #	PART #	PART #	PART #
1/4" – Grinding – Type 28 Saucer							
7 x 1/4 x 5/8-11	8,600	10	662533 70803	662529 05369		662528 43229	662529 40149
7 x 1/4 x 7/8	8,600	20		662529 05368			662529 40095
9 x 1/4 x 5/8-11	6,600	10	662533 70804	662530 06335		662528 43237	662530 49106
9 x 1/4 x 7/8	6,600	20	662533 70805				662530 49081
Light Grinding – Type 29							
4-1/2 x 5/8-11	13,600	1			662533 70009		
5 x 5/8-11	12,225	1			662533 70010		
6 x 5/8-11	10,200	1			662533 70011		
7 x 5/8-11	8,600	1			662533 70012		
1/4" – Grinding – Reversible Grinding Disc							
4-1/2 x 1/4 x 5/8-11	13,600	1				662533 70019	
7 x 1/4 x 5/8-11	8,600	1				662533 70020	



TIER:	BEST	BEST	BEST	BETTER
TRADENAME:	QUANTUM3	NORZON PLUS	DIALAST	BLUEFIRE
SHAPE:	Type 27	Type 27	Type 27	Type 27
ABRASIVE:	Ceramic Alumina	Ceramic Alumina/ Zirconia Alumina	Diamond	Zirconia Alumina/ Silicon Carbide
MATERIAL:	FOUNDRY	FOUNDRY	FOUNDRY	FOUNDRY

SIZE (D x T x H)	MAX. RPM	STD. PKG.	PART #	PART #	PART #	PART #
.140", 1/8" – Cutting / Notching / Lt. Grinding – Type 27						
4-1/2 x 1/8 x 5/8-11	13,580	10				662528 43206
4-1/2 x 1/8 x 7/8	13,580	25				662528 43204
7 x .140 x 5/8-11	8,600	1			662533 70014	
7 x 1/8 x 5/8-11	8,600	10				662528 43232
7 x 1/8 x 7/8	8,600	20				662529 15526
9 x .140 x 5/8-11	6,600	1			662533 70015	
9 x 1/8 x 5/8-11	6,600	10				662528 43240
9 x 1/8 x 7/8	6,600	20				662528 43238
1/4" – Grinding – Type 27						
4 x 1/4 x 3/8	15,280	25				662528 43181
4 x 1/4 x 5/8	15,280	25				662528 43180
4-1/2 x 1/4 x 5/8-11	13,580	10				662528 43207
4-1/2 x 1/4 x 7/8	13,580	25				662528 43205
7 x 1/4 x 5/8-11	8,600	10				662528 43231
7 x 1/4 x 7/8	8,600	20				662528 43230
9 x 1/4 x 5/8-11	6,600	10	662533 70849 HD	662530 07014		662528 43241
		10				662528 43261 HD
9 x 1/4 x 7/8	6,600	20	662533 70848 HD	662530 07013		662528 43239
		20				662528 43260 HD

All Norton foundry wheels are designed and reinforced to withstand the most aggressive foundry applications.

DEPRESSED CENTER WHEEL DESCRIPTION CODES

BLANK = All Purpose	ALU = Aluminum	FC = Fast Cut	HD = Heavy Duty	INOX/SS = Contaminant Free	LL = Long Life	XXL = Extra Long Life
= Aluminum	= Foundry	= Masonry	= Stainless	= Steel / Metal		



TIER:	GOOD	GOOD
TRADENAME:	GEMINI FLEXIBLE	GEMINI
SHAPE:	Type 27	Type 29
ABRASIVE:	Aluminum Oxide	Aluminum Oxide
MATERIAL:	ALUMINUM	ALUMINUM
	STEEL/METAL	STEEL/METAL

SIZE (D x T x H)	MAX. RPM	STD. PKG.	GRIT	PART #	PART #
1/8", 1/4" – Blending – Type 27 and 29					
2 x 1/8 x 3/8	30,560	25	60	662528 35632*	
	30,560	25	80	662528 35633*	
4 x 1/8 x 5/8	15,280	20	36	662435 29721#	
	15,280	20	60	662435 29722#	
4-1/2 x 1/8 x 5/8-11	12,000	10	36		662528 42203
4-1/2 x 1/8 x 7/8	12,000	25	36	662528 30424#	662528 42204
	12,000	25	60	662528 30425#	
5 x 1/8 x 7/8	12,225	25	36		662528 42205
7 x 1/8 x 5/8-11	8,600	10	36	662529 39024	662529 17052
7 x 1/8 x 7/8	8,600	20	36	662529 39028#	662529 17051

*5 wheels per display pack; 5 display packs per standard package.

These wheels are packed 20 per box, and must be used with this specific back plate. Two back plates are included in each box.



Depressed Center Adapter Kit

This reusable adapter kit contains everything you need to mount depressed center wheels and saucers with 7/8" center holes on to portable right angle or vertical shaft grinders. Adapter hubs are threaded for mounting on to standard 5/8"-11 NCRH spindles.

KIT NO.	WHEEL DIAMETER	WHEEL THICKNESS	PART #	STD. PKG.
114	6" thru 9"	1/16" thru 1/4"	076607 89275	1

DEPRESSED CENTER WHEEL DESCRIPTION CODES

BLANK = All Purpose	ALU = Aluminum	FC = Fast Cut	HD = Heavy Duty	INOX/SS = Contaminant Free	LL = Long Life	XXL = Extra Long Life
■ = Aluminum	■ = Foundry	■ = Masonry	■ = Stainless	■ = Steel / Metal		

no short cuts taken here
**SATISFY ALL YOUR
CUT-OFF REQUIREMENTS**

From small diameter portable cut-off wheels to large diameter foundry cut-off wheels; from portable high-speed gas saw wheels to precision toolroom wheels, our Norton offering encompasses the broadest range of applications.



Small Diameter Reinforced Cut-off



The Norton small diameter cut-off wheel line consists of Type 01/41 straight and Type 27/42 depressed center cut-off wheels from 1-1/2" to 9" diameters. These wheels come in ultra thin .035" for quick burn-free and burr-free cutting to .125" for more durable applications. All are reinforced for the demanding nature of portable cut-off.

- Applications:** Cutting sheet metal, cutting pipe, and metal fabrication
- Size Range:** 1-1/2" - 9" diameter
- Thickness Range:** .035", .040", .045", .050", .060", 1/16", .090", 3/32" and .125"
- Abrasive Grain:** Ceramic Alumina / Zirconia Alumina, Zirconia Alumina / Aluminum Oxide, Aluminum Oxide, Silicon Carbide, Diamond
- Shape:** Type 01/41 Straight and Type 27/42 Depressed Center
- Machine Used:**

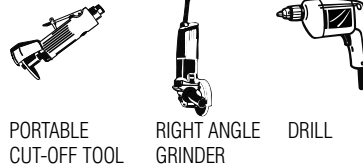

PORTABLE CUT-OFF TOOL RIGHT ANGLE GRINDER DRILL

How to Pick the Right Wheel Type

CUT-OFF WHEEL DESCRIPTION CODES

BLANK = All Purpose	ALU = Aluminum	FC = Fast Cut	INOX/SS = Contaminant Free	LL = Long Life	1-2-3 = Cutting/Notching/Grinding
■ = Masonry	■ = Stainless	■ = Steel / Metal			

DESCRIPTION CODE DEFINITIONS

BLANK = All Purpose	Where an excellent blend of cut rate and life is needed
ALU = Aluminum	Specially formulated bond for reduced loading and surface contamination while cutting aluminum and soft materials
FC = Fast Cut	Where fast stock removal is needed, or the application only allows for low-pressure or under-horsepowered grinders
INOX/SS = Contaminate Free	Contain <0.1% iron, sulfur or chlorine for rust-free and corrosion-free results. Will not contaminate stainless steel
LL = Long Life	Where durability is needed due to severe application, and when horsepower of the grinder allows for heavy pressure
RightCut = Cutting-off Only	RightCut wheels for cutting only, provide noticeably longer life and faster cut rate versus competitive wheels, and less pressure is required for first cut
1-2-3 = Cutting/Notching/Grinding	Can be used in cutting, notching and grinding applications

Type-to-Application Recommendation Guide

Wheel Type/Thickness	Applications	
TYPE 01/41 	Type 01/41 straight cut-off wheels are designed for portable cut-off tool applications. All are supplied with full fiberglass reinforcing.	
.035, .040, .060, and 1/16 .125	Where fast cutting and low kerf loss are desired For tough cutting and notching applications where stability is important	◆ ◆
TYPE 01/41 RIGHTCUT 	Type 01/41 RightCut straight cut-off wheels are designed for use on right angle grinder cut-off applications. All are supplied with full fiberglass reinforcing.	
.035, .040, .045, .050, 1/16 3/32	Where fast cutting and low kerf loss are desired For tough cutting and notching applications where stability is important	◆ ◆
TYPE 27/42 RIGHTCUT 	Type 27/42 RightCut depressed center cut-off wheels are designed for use on right angle grinder cut-off applications. Their depressed center shape provides a recess for the hub, which allows flush cutting. All are supplied with full fiberglass reinforcing.	
.040, .045, 1/16 3/32, .125	Where fast cutting and low kerf loss are desired For tough cutting and notching applications where stability is important	◆ ◆

Small Diameter Reinforced Cut-off

Material-To-Product Recommendation Guide

	BEST		BETTER	GOOD		
	Quantum3	NorZon Plus	BlueFire	Gemini	Metal	Masonry
Mild Carbon / High Tensile Steel	◆	◆	◆		◆	
Stainless Steel / Alloys	◆	◆	◆	◆		
Contaminate Free*				◆ INOX/SS		
Cast Iron	◆	◆	◆	◆		
Aluminum / Bronze / Brass				◆ ALU		
Asphalt / Brick / Concrete						◆

* For use in nuclear and food industry applications that require contaminant free (<0.1% iron, sulfur or chlorine)

Cross Reference Guides

Type 01/41 .035" - .125" Reinforced Cut-off Wheels for Portable Cut-off Tools



NORTON	TOTAL PERFORMANCE ←				INITIAL PRICE →	
	BEST		BETTER	GOOD		
	NorZon Plus	BlueFire	Gemini Free Cut	Gemini Long Life	Metal	
Brilliant	—	Brill-Max ZA	—	—	Safe-Tex FC, LL	
Bullard	—	ZA46T, ZA60T	TA36T	TA46T, TA60T	A36T, A60T Comp.	
Camel	—	ZA60-TBF	A36 RBF	A60 RBF	Fast Cut RBF	
Flexovit	Flexon Fast Cut A46, 60	—	High Perf Fast Grind A36	High Perf Fast Cut A36, 46, 60	—	
Pearl	—	SRT, Zirconia	—	Premium	Silver Line	
Pferd	—	—	—	—	PSF-A	
Sait	Saittech	—	A60S	A24R, A36T, A60T	—	
Spedecut	—	—	—	—	A46, 60 TBXX	
Walter	—	—	A24 ZIP	A60 ZIP	—	

Type 01/41 and Type 27/42 .035" - .125" Reinforced Cut-off Wheels for Right Angle Grinders



90° angle

NORTON	TOTAL PERFORMANCE ←			INITIAL PRICE →		SPECIALTY →		
	BEST		BETTER	GOOD		GOOD		
	Quantum3 .045"	Quantum3 1/16"	BlueFire	Gemini Free Cut	Gemini	Metal	Gemini ALU	Gemini INOX/SS
3M	—	Cubitron II .045	—	—	—	—	—	—
Brilliant	—	—	—	Brill-Blade Extra FC	Brill-Blade Heavy Duty	Hornet Stinger	—	—
Bullard	—	—	ZA60T	SGA60U	TA46T, TA60T, TA60U	A46T, A60T Comp.	AL46N	—
Camel	—	—	ZA Quickie Cut	A36-S-BF	Super Quickie Cut	Quickie Cut	A46 Quickie Cut	A60-T-BF, WA60R, Quickie Cut
DeWalt	XP Ceramic 0.040	XP Ceramic 1/16", XP Ceramic 0.045	XP	—	HP	Metal	—	—
Flexovit	—	—	—	Razorblade A60SST	Razorblade A24T, 30V, 36T	—	Razorblade A30Q	—
Metabo	Slicer Limited Edition .040	M-Calibur 1/16	Super Slicer	—	Slicer-Plus, Original Slicer LL	Original Slicer	—	—
Pearl	—	—	Redline Max Slimcut	—	Slimcut	Slimcut Pro-V, Silverline	—	—
Pferd	SG Elastic, SG Plus 1mm	SG Plus 1.6, SG Elastic 1.6	—	—	—	PS-Forte	SG-ALU	—
Sait	—	The Ultimate Ceramic Cutoff .045, Saitech	Z-tech	SAIT.M.X	Sait .045, The Ultimate Cutoff	—	A46N	XA46R
SpedeCut	—	—	—	—	—	A46, 60 TBXX	—	—
Walter	Zip One	—	Zip+ Xtra	A-30-ZIP	A-60-ZIP	—	A-60-ZIP-ALU	A60-SS-ZIP
Weiler	Tiger Zirc Ultra Cut 1mm, Tiger INOX UltraCut 1mm	Tiger Ceramic .045, Tiger Zirc .045, Tiger INOX .045	—	—	Tiger	Wolverine	—	—

Small Diameter Reinforced Cut-off

SAFETY

Dangerous Pairing: Die Grinders and Cut-off Wheels

While die grinders and cut-off tools may look similar, they are not interchangeable. Small diameter cut-off wheels can be used only on portable cut-off tools. Several crucial differences exist between the two handheld machines.

- Small diameter cut-off wheels must be used on portable cut-off tools with guards for the safety of the operator and bystanders. Also, portable cut-off tool guards prevent use of an oversize wheel.
- These cut-off wheels must be mounted between proper flanges on portable cut-off tools as described in the national safety standard for abrasive wheels, ANSI B7.1. Die grinders make use of a collet for mounting.
- All cut-off wheels must be used at or below their maximum operating speed, marked clearly on the side of the wheel. Die grinders operate above cut-off wheel speeds. Excessive speed can result in breakage and serious personal injury.



It is the user's responsibility to refer to and comply with ANSI B7.1

TECH TIP

Measure Your Wheel's Thickness

Why should you measure your wheel thickness? Many competitors market their wheels as .045", but they are truly thicker. New Norton Quantum3 RightCut wheels are true to size so you can pick the right wheel for the job whether you need precision cutting or rugged durability. Compare our 1/16" Quantum3 with competitive 0.045" ceramic cut-off wheels and you will see the longest life and fastest cut on the market.



It is the user's responsibility to refer to and comply with ANSI B7.1

Norton Quantum3 RightCut Wheels

The Norton Quantum3 RightCut is our top tier cut-off wheel, available in 0.045" and 1/16" thickness. If you want speed of cut and work on thin or hollow materials, the 0.045" will get you there with comfort. If you are cutting thicker materials and life of the wheel is important, then the 1/16" is ideal. Whatever your pick is, experience the extra-smooth cutting action, thanks to our premium ceramic grain.



Norton Quantum3 RightCut: 0.045" versus 1/16"

How to match the wheel to the application

5" x .045" x 7/8"
125 x 1.2 x 22mm

5" x 1/16" x 7/8"
125 x 1.6 x 22mm

PRODUCT	0.045" (FAST CUTTING)	1/16" (LONGEST LIFE)
Abrasive:	Ceramic	Ceramic
Target application:	Thin metals and/or light-style cutting	Thick metals and/or aggressive-style cutting
Strengths:	Fast cutting, smooth easy feel, precise and maneuverable, reduced burrs	Long lasting, durable, aggressive easy feel, versatile across applications and metals

Small Diameter Reinforced Cut-off



NEW

Best choice for stainless steel and carbon steel applications

QUANTUM3 CERAMIC ALUMINA

- 100% advanced ceramic alumina grain with a special shape for comfort and performance guaranteeing 7X the life of aluminum oxide wheels and 3X the life of zirconia alumina wheels
- Unique bond system prevents premature grain release maximizing wheel life
- Available in type 01 straight and type 27 depressed center cut-off wheels from 4-1/2 inch to 6 inch diameters



Best for metal plate, pipe, tubing, cast iron, carbon and mild steel, foundry and welding applications, and ceramics

DIALAST DIAMOND WHEELS

- A combination of high-quality diamond and advanced brazed single-layer bonding technology for extra-long life versus conventional abrasives or other vacuum-brazed diamond tools
- Retains diamond grains and wheel shape for full life with low sparks, while keeping a continuous grinding depth for exceptional wheel life; less blade changes reduces downtime and labor costs
- Environmentally-friendly grinding for minimal dust, less clean-up and safer working conditions



Best choice for highest productivity for steel, stainless steel and all ferrous metals

NORZON PLUS CERAMIC / ZIRCONIA BLEND

- Patented Norton SG ceramic alumina and zirconia alumina grain blend delivers the fastest cutting wheel available on the market, up to 10X faster cutting versus aluminum oxide wheels on 400 series stainless and soft and hard carbon steels
- Ultra-thin side reinforcing creates maximum cut rate and minimum kerf loss; ideal when precise thin cut is desired
- High-performance resin bond adds a freer cut and longest life



Better choice for stainless steel, carbon steel, alloys and gray iron

BLUEFIRE ZIRCONIA ALUMINA / A/O BLEND

- A blend of the most advanced zirconia alumina and premium aluminum oxide abrasives delivers 2 to 3 times the life of aluminum oxide wheels
- Ultra-thin side reinforcing for maximum cut rate with minimum kerf loss; ideal when precise, thin cut is desired
- Broad utility from light-to heavy-pressure applications



Good, versatile choice for steel and ferrous metals

GEMINI ALUMINUM OXIDE

- Quality aluminum oxide for consistent performance at an economical price
- Designed for portable cut-off tool applications where a fast cut and minimum material loss are desired
- Durable bond designed for fast cut while retaining excellent wheel life



Good choice for grinding alloys, metals, steels, and ferrous metals

METAL ALUMINUM OXIDE

- Quality aluminum oxide abrasive for quick cutting action
- Resin bond provides free cutting action with long life
- Good choice when low initial price is needed for small jobs or newer operators

Small Diameter Reinforced Cut-off



TIER:	BEST	BETTER	BETTER	GOOD	GOOD	GOOD
TRADENAME:	NORZON PLUS	BLUEFIRE	A60-OBNA2	GEMINI	GEMINI LONG LIFE	METAL
SHAPE:	Type 01/41	Type 01/41	Type 01/41	Type 01/41	Type 01/41	Type 01/41
ABRASIVE:	Ceramic Alumina/ Zirconia Alumina	Zirconia Alumina/ Aluminum Oxide	Aluminum Oxide	Aluminum Oxide	Aluminum Oxide	Aluminum Oxide
MATERIAL:	STAINLESS STEEL/METAL	STAINLESS STEEL/METAL	STAINLESS STEEL/METAL	STAINLESS STEEL/METAL	STAINLESS STEEL/METAL	STAINLESS STEEL/METAL

SIZE (D x T x H)	MAX. RPM	STD. PKG.	PART #	PART #	PART #	PART #	PART #	PART #	
.035", .040", .060", 1/16" and .125" Type 01/41 – Cut-off									
1-1/2 x .035 x 1/16	40,745	25			662434 27764				
1-1/2 x .035 x 1/8	40,745	25			662434 27831				
1-1/2 x .035 x 1/4	40,745	25			662434 27875				
2 x .035 x 1/8	30,560	25				662434 11392 FC			
2 x .035 x 1/4	30,560	25			662434 28014	662434 11393 FC			
2 x .035 x 3/8	30,560	25				662434 11394 FC			
2 x .060 x 1/8	30,560	25			662434 28041				
2 x 1/16 x 1/4	30,560	25				662434 11395 FC			
2 x 1/16 x 3/8	30,560	25				662434 11396 FC			
2 x .125 x 1/4	30,560	25				662434 11402 FC			
2 x .125 x 3/8	30,560	25				662434 11403 FC			
2-1/2 x .035 x 1/8	30,560	25			662435 28476				
2-1/2 x .035 x 1/4	30,560	25			662435 28425				
2-1/2 x 1/16 x 1/4	30,560	25				662435 10640 FC			
2-1/2 x 1/16 x 3/8	30,560	25				662435 10641 FC			
3 x .035 x 1/4	25,465	25	662435 10668		662435 28573	662435 10627 FC			
	25,465	25*	662435 31753 5-Pk						
3 x .035 x 3/8	25,465	25	662435 10669	662528 43174	662435 28574	662435 10628 FC	662435 37271 LL	076607 89451	
	25,465	25*		662435 34821 5-Pk					
3 x 1/16 x 1/4	25,465	25	662435 10670		662435 28471	662435 10645 FC	662435 10649 LL		
3 x 1/16 x 3/8	25,465	25	662435 10671	662528 43175	662435 28552	662435 10647 FC	662435 10648 LL	662528 35553	
	25,465	25	662435 10835 LL						
	25,465	25*						076607 47767 5-Pk	
	25,465	100						076607 89012	
	25,465	10-Pk†						662528 43624	
								5 Whls & 1 Mandrel/ Pack	
3 x .125 x 1/4	25,465	25				662435 10650 FC			
3 x .125 x 3/8	25,465	25	662435 10673			662435 10651 FC	662435 10653 LL		
4 x .035 x 1/4	15,300	25			662435 29606				
	19,100	25				662435 10629 FC			
4 x .035 x 3/8	19,100	25	662435 10675	662528 43173	662435 29621	662435 10630 FC	662435 37273 LL	076607 89453	
4 x .035 x 1/2	19,100	25			662435 29622				
4 x .035 x 3/4	19,100	25			662435 29609				
4 x .040 x 3/8	19,100	25			662435 29516				
4 x 1/16 x 1/4	19,100	25	662435 10676			662435 10654 FC			
4 x 1/16 x 3/8	19,100	25	662435 10677	662528 43171		662435 10655 FC		662528 43848	
4 x 1/16 x 5/8	19,100	100			662435 27827				
					FabCut				
4 x .125 x 1/4	19,100	25				662435 10658 FC			
4 x .125 x 3/8	19,100	25	662435 10841	662528 43172		662435 10659 FC	662435 10661 LL		
	19,100	25	662435 10680 LL						

* 5-wheel Job Packs; wheels are packed 5 wheels/Pack, with 5 Job Packs/carton. Order per each wheel in standard package quantities of 25. Order in multiples of 25.
† Order per number of pack, in multiples of 10 packs. Priced per pack.



Drill-Mount Mandrel

Used for mounting 2" and 3" x 3/8" hole cut-off wheels on to a drill

DESCRIPTION	STD. PKG.	PART #
Drill-Mount Mandrel	1	076607 47769



CUT-OFF WHEEL DESCRIPTION CODES

BLANK = All Purpose ALU = Aluminum FC = Fast Cut INOX/SS = Contaminant Free LL = Long Life 1-2-3 = Cutting/Notching/Grinding
 ■ = Masonry ■ = Stainless ■ = Steel / Metal

Small Diameter Reinforced Cut-off

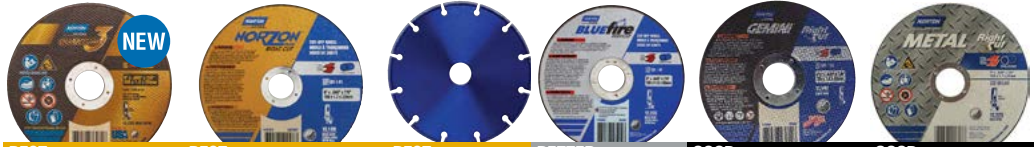

TIER:	BEST	BEST	BEST	BETTER	GOOD	GOOD
TRADENAME:	QUANTUM3 RIGHTCUT	NORZON PLUS RIGHTCUT	DIALAST RIGHTCUT	BLUEFIRE RIGHTCUT	GEMINI RIGHTCUT	METAL RIGHTCUT
SHAPE:	Type 01/41	Type 01/41	Type 01/41	Type 01/41	Type 01/41	Type 01/41
ABRASIVE:	Ceramic Alumina	Ceramic Alumina/ Zirconia Alumina	Diamond	Zirconia Alumina/ Aluminum Oxide	Aluminum Oxide	Aluminum Oxide
MATERIAL:	STAINLESS	STAINLESS	STAINLESS	STAINLESS	STAINLESS	STAINLESS
	STEEL/METAL	STEEL/METAL	STEEL/METAL	STEEL/METAL	STEEL/METAL	STEEL/METAL

SIZE (D x T x H)	MAX. RPM	STD. PKG.	PART #	PART #	PART #	PART #	PART #	PART #
.035", .040", .045", .050", 1/16, and 3/32" Type 01/41 – RightCut Cut-off								
4 x .040 x 5/8	15,280	25						076607 01616
4 x .045 x 5/8	15,280	25					662435 27956	
4 x 3/32 x 5/8	15,280	25					662435 27955	
4-1/2 x .035 x 7/8	13,580	25						662528 43846
4-1/2 x .040 x 7/8	13,580	25					662528 43225	076607 01617
	13,580	50						662533 70222
	13,580	250+						662528 40001
	13,580	25*						662528 42158 5-Pk
4-1/2 x .045 x 7/8	13,580	25	662528 38454				662528 23602	
	13,580	25					662528 41994 ALU	
	13,580	25					662528 41997 INOX/SS	
	13,580	250+					662528 41213	
	13,580	25*					662528 42160 5-Pk	
4-1/2 x .050 x 7/8	13,580	1			662533 70016			
4-1/2 x 1/16 x 7/8	13,580	25	662528 38455			662528 43208		662528 43845
	13,580	25*				662528 42159 5-Pk		
	13,580	250+				662533 71660		
4-1/2 x 3/32 x 7/8	13,580	25					662528 23599	
5 x .040 x 5/8	12,225	25						662528 43847
5 x .040 x 7/8	12,225	25					662528 43226	076607 01618
5 x .045 x 7/8	12,225	25	662528 38460				662528 23603	
	12,225	25					662528 41995 ALU	
	12,225	250+					662528 41214	
	12,225	25*					662528 42170 5-Pk	
5 x .050 x 7/8	12,225	25		662528 09829 NZ ThinCut				
	12,225	1			662533 70017			
5 x 1/16 x 7/8	12,225	25	662528 38462			662528 43209		
	12,225	25*				662528 42169 5-Pk		
5 x 3/32 x 7/8	12,225	25					662528 23600	
6 x .040 x 7/8	10,185	25						076607 02757
	10,185	50						662533 70223
	10,185	250+						662528 41212
6 x .045 x 7/8	10,185	25					662528 23604	
	10,185	25					662528 41996 ALU	
	10,185	25					662528 41999 INOX/SS	
	10,185	250+					662528 41215	
	10,185	25*				662528 42174 5-Pk	662528 42175 5-Pk	
6 x .050 x 7/8	10,185	1			662533 70018			
6 x 1/16 x 7/8	10,185	25	662528 38465			662528 43210		
	10,185	250+				662533 71662		
6 x 3/32 x 7/8	10,185	25					662528 23601	
7 x .045 x 7/8	8,600	25					662528 32323	
	8,600	20					662528 42000 INOX/SS	
7 x 1/16 x 7/8	8,600	25		662529 00652				
	8,600	1				701846 94055		
9 x .060 x 7/8	6,600	1				701846 94056		

RightCut wheels are to be used for cutting only

* 5-wheel Job Packs; wheels are packed 5 wheels/Pack, with 5 Job Packs/carton. Order per each wheel in standard package quantities of 25. Order in multiples of 25.

+ Bulk packed 250 Wheels/carton; 5 inner boxes of 50 wheels each. Order in multiples of 250 wheels.

CUT-OFF WHEEL DESCRIPTION CODES

BLANK = All Purpose ALU = Aluminum FC = Fast Cut INOX/SS = Contaminant Free LL = Long Life 1-2-3 = Cutting/Notching/Grinding
 ■ = Masonry ■ = Stainless ■ = Steel / Metal

Small Diameter Reinforced Cut-off



TIER:	BEST	BEST	BETTER	GOOD	GOOD
TRADENAME:	QUANTUM3	NORZON PLUS	BLUEFIRE	GEMINI	METAL
SHAPE:	Type 27/42	Type 27/42	Type 27/42	Type 27/42	Type 27/42
ABRASIVE:	Ceramic Alumina	Ceramic Alumina/ Zirconia Alumina	Zirconia Alumina/ Aluminum Oxide	Aluminum Oxide	Aluminum Oxide
MATERIAL:		STAINLESS STEEL/METAL	STAINLESS STEEL/METAL	STAINLESS STEEL/METAL	STAINLESS STEEL/METAL
				ALUMINUM	

SIZE (D x T x H)	MAX. RPM	STD. PKG.	PART #	PART #	PART #	PART #	PART #
.040, .045, 1/16" – RightCut Cut-off – Type 27/42							
4 x .045 x 5/8	15,280	25				662528 42180	076607 05249
4-1/2 x .040 x 5/8-11	13,580	10				662528 43227	
4-1/2 x .045 x 5/8-11	13,580	10				662528 42025	
	13,580	10				662528 41913 INOX/SS	
4-1/2 x .045 x 7/8	13,580	25				662528 42026	662528 43604
	13,580	25				662528 41912 INOX/SS	
	13,580	25				662528 41909 ALU 36	
	13,580	25*				662528 42161 5-Pk	
	13,580	250				662533 70065 250-Pk	
4-1/2 x 1/16 x 5/8-11	13,580	10	662528 38457		662528 43223		
4-1/2 x 1/16 x 7/8	13,580	10			662528 43219		
	13,580	25	662528 38456				
5 x .040 x 5/8-11	12,225	10				662528 43228	
5 x .045 x 5/8-11	12,225	10				662528 41939	
5 x .045 x 7/8	12,225	25				662528 42036	662528 43849
	12,225	25				662528 41914 INOX/SS	
	12,225	25				662528 41910 ALU 36	
	12,225	25*				662528 42171 5-Pk	
	12,225	250				662533 70066 250-Pk	
5 x 1/16 x 7/8	12,225	25	662528 38464		662528 43220		
6 x .045 x 5/8-11	10,185	10		662528 42007		662528 30587	
6 x .045 x 7/8	10,185	25				662528 42202	662528 42015
	10,185	25				662528 41916 INOX/SS	
	10,185	25				662528 41911 ALU 36	
	10,185	25*				662528 42176 5-Pk	
	10,185	250				662533 70067 250-Pk	
6 x 1/16 x 7/8	10,185	25	662528 38466		662528 43221		
7 x .045 x 5/8-11	8,600	10				662528 41919 INOX/SS	
7 x .045 x 7/8	8,600	20				662529 12626	
	8,600	20				662528 41918 INOX/SS	
7 x 1/16 x 7/8	8,600	10					076607 05251
9 x 1/16 x 5/8-11	6,600	10				662530 19115	
9 x 1/16 x 7/8	6,600	10				662530 17734	
<i>RightCut wheels are to be used for cutting only.</i>							
3/32", .125" – Cut-off – Type 27/42							
4 x .125 x 3/8	15,280	25		662528 42001			
4-1/2 x 3/32 x 5/8-11	13,580	10				662528 41903	
	13,580	10				662528 42027 INOX/SS	
4-1/2 x 3/32 x 7/8	13,580	25				662528 41940	
	13,580	25				662528 42028 INOX/SS	
	13,580	25				662528 43582 1-2-3	
4-1/2 x .125 x 5/8-11	13,580	10	662528 43321			662528 43588	
4-1/2 x .125 x 7/8	13,580	25	662528 43322			662528 43589	
5 x 3/32 x 5/8-11	12,225	10				662528 41904	
5 x 3/32 x 7/8	12,225	25				662528 42037 INOX/SS	
	12,225	25				662528 43587 LL	
5 x .125 x 7/8	12,225	25				662528 43595	
6 x 3/32 x 5/8-11	10,185	10				662528 41905	
6 x 3/32 x 7/8	10,185	25				662528 41906	
	10,185	25				662528 32487 INOX/SS	
6 x .125 x 5/8-11	10,185	10				662528 41192	
6 x .125 x 7/8	10,185	25				662528 42021	
7 x 3/32 x 5/8-11	8,600	10				662528 41907	
7 x 3/32 x 7/8	8,600	20				662528 41908	
	8,600	20				662529 14638 INOX/SS	
7 x .125 x 5/8-11	8,600	10		662529 12625			
7 x .125 x 7/8	8,600	20		662529 12624		662529 00619	
9 x 3/32 x 5/8-11	6,600	10			662528 42378		
9 x 3/32 x 7/8	6,600	20			662528 42343		

*These wheels are to be used for cutting only. *5-wheel Job Packs; wheels are packed 5 wheels/Pack, with 5 Job Packs/carton. Order per each wheel in standard package quantities of 25. Order in multiples of 25.*

Circular Saw Reinforced Cut-off

A circular saw uses an abrasive wheel to cut different materials using a rotary motion spinning around an arbor. Norton Circular Saw abrasive cut-off wheels are ideal for use in deburring, cleaning, slotting and cutting all types of metal and masonry.

- Applications:**
- Size Range:**
- Thickness Range:**
- Abrasive Grain:**
- Shape:**
- Machine Used:**

Deburring, cleaning, slotting and cutting
 6" - 9" diameter
 .035", .060", 1/16", 1/8", and .125"
 Zirconia Alumina / Aluminum Oxide, Aluminum Oxide, Silicon Carbide, Diamond
 Type 01/41 Straight



CIRCULAR SAW



TIER:	BEST	BETTER	GOOD	GOOD	GOOD
TRADENAME:	DIALAST	CHARGER	GEMINI	METAL	MASONRY
SHAPE:	Type 01/41	Type 01/41	Type 01/41	Type 01/41	Type 01/41
ABRASIVE:	Diamond	Zirconia Alumina/ Aluminum Oxide	Aluminum Oxide	Aluminum Oxide	Silicon Carbide
MATERIAL:	STAINLESS	STEEL/METAL	STEEL/METAL	STEEL/METAL	MASONRY

SIZE (D x T x H)	MAX. RPM	STD. PKG.	PART #	PART #	PART #	PART #	PART #
Type 01/41 – Circular Saw							
6 x .035 x 5/8	10,185	25			662528	09714	
6 x 1/16 x 5/8	10,185	25			662528	09718	
6-1/2 x .125 x DM-5/8	9,405	10				076607	89098
7 x 1/16 x 5/8	8,730	25			662529	05957	
7 x .060 x 7/8	8,600	1	701846	94055			
7 x 1/8 x DM-5/8	8,730	25				076607	89097
8 x 1/16 x 5/8	7,640	25		662530	17771 LL	662530	07025
	7,640	10				662530	17795
8 x 1/8 x DM-5/8	7,640	10				076607	89096
9 x .060 x 7/8	6,600	1	701846	94056			076607
							89086



DM Denotes Diamond Mount; 5/8" hole bushings included

CUT-OFF WHEEL DESCRIPTION CODES				
BLANK = All Purpose	FC = Free Cut	LL = Long Life	■ = Masonry	■ = Stainless
				■ = Steel / Metal

Chop Saw Reinforced Cut-off



A chop saw is a light, low-horsepower portable machine. Although very similar to a compound miter saw, it is designed for cutting denser materials, like metal bar, tubing or pipe. Chop saw cut-off wheels are designed specifically for this machine with finer grit, softer grades, and reinforcement layers that match the application.

- Applications:** Cutting small-diameter metal pieces, bar stock, metal pipe, tubing, decking, cable, drywall studs, and metal plate dimensioning
- Size Range:** 10" - 16" diameter
- Thickness Range:** 3/32" and 7/64"
- Abrasive Grain:** Zirconia Alumina / Aluminum Oxide Blend, Aluminum Oxide, and Diamond
- Shape:** Type 01/41 Straight
- Reinforcement Type:** Side reinforced, centrally reinforced
- Machine Used:**



Cross Reference Guide

	TOTAL PERFORMANCE			INITIAL PRICE			SPECIALTY	
	BETTER			GOOD			GOOD	
NORTON	BlueFire Free Cut	BlueFire Rapid Cut	BlueFire Long Life	Gemini Free Cut	Gemini Rapid Cut	Gemini Long Life	Stud Cutter	Gemini Aluminum
Brilliant	—	—	—	Super-G	Tube/Pipe	—	Drywall Stud	Aluminum
Bullard	ZA36T	—	—	TA36T A46T The Competitor	A36R The Competitor	A36R Ironmaster	A46T Studmaster	AL36R
Camel	—	—	ZA24-S	A36-P, WA36-P	—	A36-S	A30-R Mr. Stud	A30-N
Dewalt	—	—	XP	GP, Stainless Fabrication	—	—	Stud Cutting	—
Flexovit	—	—	—	A30R Fast Cut A30-Q Free Cut	—	A30S Long Life	A30T Drywall Stud	—
Makita	—	—	—	—	General Purpose	—	—	—
Pearl	SRT36	—	—	A36P Premium	A30P Silver Line	—	A46S Stud Cutting	—
Pferd	—	—	—	A 36 K SG CHOP	PSF CHOP	—	A 36 K SG-STUD	—
Sait	Saitech Steel Worker	Z-tech	—	EZ-Chop	EZ-Chop Attacker	Iron Worker	Stud King	Aluminum
Walter	—	—	—	—	A-30	A-30-HC+	—	A30-ALU

Application-to-Product Recommendation Guide

Wheel Type/Reinforcement

TYPE 01/41 STRAIGHT SIDE-REINFORCED CUT-OFF WHEEL

Side-reinforced wheels have two full layers of reinforcing and are designed for a fast cut and the most aggressive applications. All Purpose, Free Cut, and Long Life are side reinforced.



TYPE 01/41 STRAIGHT CENTRALLY-REINFORCED CUT-OFF WHEEL

Centrally-reinforced wheels have a single layer of reinforcing with exposed rough sides for free-cutting, non-binding applications where minimal burr and burn are the key requirements. Rapid Cut wheels are centrally reinforced.



How to Pick the Right Bond Type

DESCRIPTION CODE DEFINITIONS

BLANK = All Purpose	Where an excellent blend of cut rate and life is needed
FC = Free Cut	Used when fast, burn-free cutting is desired or when cutting pieces with larger cross sections
LL = Long Life	Where durability is needed due to severe application, and when cutting parts with small cross sections
RC = Rapid Cut	Where a free cutting, non-binding wheel is needed for burn-free and burr-free cuts
STUD = High-Performance	High-performance aluminum oxide/resin bond combination designed for cleaner cuts and longer life when cutting steel studs
ALU = Aluminum	Specially formulated bond for reduced loading/surface contamination when cutting aluminum/soft materials

Chop Saw Reinforced Cut-off



Designed for cutting steel, metal studs, stainless steel, non-ferrous materials, tile, brick, plastic and much more

DIALAST DIAMOND

- A combination of high-quality diamond and advanced brazed single-layer bonding technology for extra-long life versus conventional abrasives or other vacuum-brazed diamond tools
- Retains diamond grains and wheel shape for full life with low sparks, while keeping a continuous grinding depth for exceptional wheel life; less blade changes reduce downtime and labor costs
- Environmentally-friendly grinding for minimal dust, less clean-up and safer working conditions

Better choice for steel, stainless steel and all other ferrous metals



BLUEFIRE ZIRCONIA ALUMINA / A/O BLEND

- Durable, latest generation zirconia alumina and premium aluminum oxide abrasive blend outperforms competitive chop saw zirconia wheels by 20 percent
- Delivers twice the life and cut rate of aluminum oxide wheels on difficult to cut metals
- High performance resin bond is designed for free cut and long life

Good choice for all steel and ferrous metals as well as specialty applications in aluminum



GEMINI ALUMINUM OXIDE

- Durable, versatile aluminum oxide abrasive engineered for consistent performance and economical price on chop saw cut-off machine applications
- Abrasive and bond combination designed for smooth clean cut on low HP machines
- Good choice for consistent performance at an economical price

Good choice for drywall studs



METAL ALUMINUM OXIDE

- Quality aluminum oxide abrasive designed for cutting alloys, steels and ferrous metals including 400 series stainless, soft and hard carbon steels
- Designed with finer grit and softer grades, specifically for chop saw machines that typically have lower horsepower
- Constructed with full fiberglass reinforcing; Stud Cutter version designed specifically for cutting steel studs

Chop Saw Reinforced Cut-off



TIER:	BEST	BETTER	BETTER	GOOD	GOOD	GOOD	GOOD
TRADENAME:	DIALAST	BLUEFIRE	BLUEFIRE	GEMINI	GEMINI	METAL	METAL
SHAPE:	Type 01/41	Type 01/41	Type 01/41	Type 01/41	Type 01/41	Type 01/41	Type 01/41
ABRASIVE:	Diamond	Zirconia Alumina/ Aluminum Oxide	Zirconia Alumina/ Aluminum Oxide	Aluminum Oxide	Aluminum Oxide	Aluminum Oxide	Aluminum Oxide
REINFORCING:		Side	Central	Side	Central	Side	Central
MATERIAL:	STAINLESS	STAINLESS	STAINLESS	STAINLESS	STAINLESS	STAINLESS	STAINLESS
		STEEL/METAL	STEEL/METAL	STEEL/METAL	STEEL/METAL	STEEL/METAL	STEEL/METAL

SIZE (D x T x H)	MAX. RPM	STD. PKG.	PART #	PART #	PART #	PART #	PART #	PART #	
Type 01/41 Straight Cut-off									
10 x 7/64 x 1	6,110	10				662531	06109 LL		
12 x 7/64 x 1	5,095	10		662528	43250	662532	07554 LL	662532	14561 RC
	5,095	5							076607
14 x 3/32 x 1	4,365	10				662533	06627 FC	662533	13588 RC
	4,365	10				662533	06626 LL		662528
									35554
									076607
									89405
									STUD
	4,365	5 V							076607
14 x 7/64 x 1	4,365	10		662528	43252 FC	662528	43254 RC	662533	14816 ALU
	4,365	10		662528	43253 LL				
	4,365	25							076607
14 x .155 x 1	5,400	1	701846	94053					03970 5-Pk
16 x 7/64 x 1	3,820	10		662528	43256 FC		662534	10198 LL	
	3,820	10		662528	43257 LL				



V Vendible 2-wheel Package. Ideal for vending machings and small jobs. 5 packs/carton. Order in multiples of 10.

CUT-OFF WHEEL DESCRIPTION CODES					
BLANK = All Purpose	ALU = Aluminum	FC = Free Cut	LL = Long Life	RC = Rapid Cut	STUD = Stud Cutter
■ = Masonry	■ = Stainless	■ = Steel / Metal			



High-Speed Reinforced Cut-off



Norton high-speed cut-off abrasive wheels provide the industry's leading performance in all high-speed gas and electric-powered applications.

Applications:

Metalworking: steel, stainless, ductile, cast iron, rail steel and metal decking
Non-Metal Building Materials: concrete, brick, masonry, asphalt aggregate, stone and schedule 40 and 80 PVC pipe

Rescue and Demolition: steel, acrylic, fiberglass, rubber, glass, wood, concrete, brick and asphalt

- Size Range:**
- Thickness Range:**
- Abrasive Grain:**
- Shape:**
- Reinforcement:**

12" – 16" diameter
1/8" and 5/32"
Aluminum Oxide, Silicon Carbide, Silicon Carbide / Aluminum Oxide Blend
Type 01/41 Straight
Wheels are offered in standard two-layer reinforcement as well as three-layer reinforcement for higher-speed saws and heavy-duty applications.

Arbor:

Wheels are offered with patented universal arbor that accommodates both 20mm and all other machines with 1" arbors.

Machine Used:



HIGH-SPEED GAS
OR ELECTRIC SAW

Material / Application-to-Product Recommendation Guide

Icon		Application
	Metal	High-performance aluminum oxide grain wheels designed for general purpose cutting of all steel and stainless parts including rebar, steel pipe, structural steel, sheet metal, cable and small to medium diameter solid pieces.
	Metal Decking	High-performance aluminum oxide abrasive combined with a thicker wheel (5/32") that stands up to the sharp edges of sheet metal and roof decking.
	Ductile/Cast Iron	A special blend of silicon carbide abrasive for cutting and aluminum oxide abrasive for life, designed to cut ductile and cast iron pipe, concrete-lined water pipes, sewer construction and heavy duty PVC.
	Rescue	For ventilation, forcible entry, rescue and demolition. A versatile abrasive formula that can be used on a wide range of materials including all types of metals and masonry.
	Concrete	Coarse grit silicon carbide abrasive provides a low initial cost solution for cutting brick, block, concrete or other masonry materials. For higher-production applications that require optimum speed of cut and product life, please see our complete selection of high-speed diamond wheels in our Norton Construction diamond product line.
	Asphalt	A special blend of extra coarse silicon carbide abrasive grains provides a low initial cost solution for cutting asphalt, green concrete, asphalt over concrete, a wide range of aggregates and abrasive materials.

Cross Reference Guide

NORTON	SPECIALTY				
	GOOD				
	Gemini Metal	Gemini Metal Decking	Gemini Ductile	Gemini Concrete	Gemini Asphalt
Abmast	A 24 R, Kompetitor Metal	A 24 T	AC 24 R, Kompetitor Ductile Iron	C 24 R, Kompetitor Concrete	C 16 T, Kompetitor Asphalt
Brilliant	Metal/Stainless	—	—	Concrete/Masonry	—
Bullard Blaze & Road Warrior	A24R, ZA24Q, The Competitor	TA24R	AC24R	C24R, The Competitor	CC20R
Camel	A24-R	A24-T	AC24-R	C24-R	C16-U
Flexovit	A24/30SB	A24TB	AC24SB	C30UB	C16UB
Husqvarna	Blue XHS, Blue QMS-CM, Blue EHS	Grey QMS-CM	Green QMS-CM, Green EHS	Red XHS, Red QHS-CM, Red EHS	Black QMS-AS
Pearl	SRT, Premium A36S, Silver Line A30R	—	AC30S	Premium C36S, Silver Line C24R	—
Pferd	A 24 R SG	A 24 Q SG-RAIL	AC 24 Q SG	C 24 R SG	—
Sait	A24R, A30S, XFC	Brute	Ductile	C24R	Big M.A.C, XFC
Tyrolit	A30P, A30BF	—	AC24, AC30BF	1C24, C30BF	—
Virginia Abrasives	Metal	—	Ductile	Concrete	Asphalt
Walter	A-24	—	—	—	—

High-Speed Reinforced Cut-off

How to Pick the Right Reinforcement

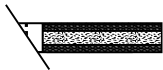

Two full layers of reinforcing are offered for lower power machines, and light-to-medium applications where speed of cut is the primary selection criterion.

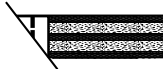

Three full layers of reinforcing are recommended for high-speed, high-power machines where the application is heavy-duty, and durability is the primary selection criterion.



TIER:	GOOD	GOOD	GOOD	GOOD
TRADENAME:	GEMINI METAL HD	GEMINI METAL	GEMINI METAL DECKING	GEMINI RESCUE
SHAPE:	Type 01/41	Type 01/41	Type 01/41	Type 01/41
ABRASIVE:	Aluminum Oxide	Aluminum Oxide	Aluminum Oxide	Silicon Carbide/ Aluminum Oxide Blend
REINFORCING:	3 Layers	2 Layers	2 Layers	2 Layers
MATERIAL:				

SIZE (D x T x H)	MAX. RPM	STD. PKG.	PART #	PART #	PART #	PART #
Type 01/41 Cut-off – for Gas & Electric-Powered Saws						
12 x 1/8 x 1" / 20mm	6,300	10	662528 36708	662528 37838		
14 x 1/8 x 1" / 20mm	5,400	10	662528 35386	662528 37841		662435 78262
14 x 5/32 x 1" / 20mm	5,400	10			662528 32521	
16 x 1/8 x 1" / 20mm	4,800	10		662528 30886		

See additional Rail Cut wheels on the next page for larger-volume jobs.



TIER:	GOOD	GOOD	GOOD	GOOD	GOOD
TRADENAME:	GEMINI DUCTILE HD	GEMINI DUCTILE	GEMINI CONCRETE HD	GEMINI CONCRETE	GEMINI ASPHALT
SHAPE:	Type 01/41	Type 01/41	Type 01/41	Type 01/41	Type 01/41
ABRASIVE:	Silicon Carbide / Aluminum Oxide Blend	Silicon Carbide / Aluminum Oxide Blend	Silicon Carbide	Silicon Carbide	Silicon Carbide
REINFORCING:	3 Layers	2 Layers	3 Layers	2 Layers	2 Layers
MATERIAL:					

SIZE (D x T x H)	MAX. RPM	STD. PKG.	PART #	PART #	PART #	PART #	PART #
Type 01/41 Cut-off – for Gas & Electric-Powered Saws							
12 x 1/8 x 1" / 20mm	6,300	10		662528 37840		662528 37839	701846 70243
14 x 1/8 x 1" / 20mm	5,400	10	662528 35388	662528 37843	662528 35387	662528 37842	701846 72877
16 x 1/8 x 1" / 20mm	4,800	10				701846 23029	



Universal Arbor

Two Blade Sizes in One

Our Norton patented 1"/20mm knock-out arbor fits all gas and electric high-speed saws. A 20mm bushing is pre-mounted into the 1" molded arbor hole. The wheel, with the 20mm bushing, can be mounted directly on any 20mm arbor high-speed saw. With the bushing removed, exposing the 1" arbor hole, the wheel can be mounted on any 1" arbor high-speed saw. Combining this arbor, with heavy-duty triple reinforcing results in a higher performing, extra strong, longer lasting cutting wheel. Once the 20mm bushing is removed, it cannot be replaced.

Walk-Behind Reinforced Cut-off



These powerful, self-propelled machines are designed to cut concrete slabs and asphalt and are normally fitted with diamond blades. For inexperienced operators or small jobs, the machines can accommodate these low initial cost, conventional abrasives wheels.

- Applications:** Cutting straight sections of concrete surfaces
- Size Range:** 14" and 18" diameter
- Thickness Range:** 3/16" – 3/8"
- Abrasive Grain:** Silicon Carbide
- Bond:** Hot Pressed (HP) – for higher-horsepower machine applications where additional durability is needed, may be used wet or dry
Cold Pressed (CP) – for lower-horsepower machines, which need a free-cutting wheel
- Shape:** Type 01/41 Straight
- Arbor:** All are 1" with a drive pin
- Machine Used:**



FLAT SAW /
WALK-BEHIND SAW

Cross Reference Guide

NORTON	SPECIALTY		
	BETTER	GOOD	GOOD
	Gemini Asphalt / Green Concrete – HP	Gemini Asphalt - CP	Gemini Concrete - CP
Abmast	—	C 16 T. Kompetitor Asphalt/Concrete	C 24 R
Bullard Blaze & Road Warrior	—	C16R & T, C16R3	—
Camel	—	C16-U	C24-R
Flexovit	HPC16AG	C16 G.P. C16UB	C20SB/C16TB
Husqvarna	Red GC-7A	Black EWC	Gold RTC, Blue RTC, Blue EWC
Pearl	—	—	Premium C36S, Silver Line C24R
Pferd	—	C 24 R SG ASP	C 24 R SG GP
Sait	Street Runner	C16	C24R, Street Walker
Tyrolit	Concrete/Asphalt CHP	Asphalt CP	Concrete CP
Virginia Abrasives	—	GC/Asphalt	Concrete
Walter	—	—	C-24



TIER:	BETTER	GOOD	GOOD
TRADENAME:	GEMINI ASPHALT - HP	GEMINI ASPHALT - CP	GEMINI CONCRETE - CP
SHAPE:	Type 01/41	Type 01/41	Type 01/41
ABRASIVE:	Silicon Carbide	Silicon Carbide	Silicon Carbide
BOND:	Hot Pressed - Long Life	Cold Pressed - Free Cut	Cold Pressed - Free Cut

MATERIAL:

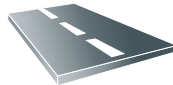

SIZE (D x T x H)	MAX. RPM	STD. PKG.	PART #	PART #	PART #
Type 01/41 Cut-off – For Walk-Behind Saws					
14 x 3/16 x 1 Pin Hole	4,365	10		701846 80324	701846 80323
14 x 1/4 x 1 Pin Hole	4,365	5			701846 70533
18 x 1/4 x 1 Pin Hole	4,250	5	701846 70103		

Stationary Saw Reinforced Cut-off



The Norton stationary saw reinforced cut-off wheel line consists of Type 01/41 straight 10" - 24" wheels, designed to fit on fixed-base stationary saws that are free-standing or mounted on a workbench.

- Applications:** Primary applications are cutting of all metal parts (flat stock, bars, studs, pipes, tubes, angle iron, cable), wire rope and hydraulic hose used in fabrication, construction and plant maintenance.
- Size Range:** 10" – 20" diameter
- Thickness Range:** 3/32", 1/8", 5/32", 3/16"
- Abrasive Grain:** Zirconia Alumina / Aluminium Oxide Blend, Aluminum Oxide, Silicon Carbide
- Shape:** Type 01/41 Straight
- Machine Used:**



STATIONARY SAW

Cross Reference Guide

	TOTAL PERFORMANCE			INITIAL PRICE		SPECIALITY
	BETTER	GOOD	GOOD			GOOD
NORTON	BlueFire	Gemini Free Cut	Gemini Long Life	Gemini Rapid Cut*	Norton Masonry	Foundry Cut**
Abmast	Z 24 R3	A 30 R	—	—	—	AC 24 R3
Brilliant	—	GP Fast Cut	GPX Long Life	XL , XLX	—	—
Bullard	—	A30-R	A30-T	A300	C20R	—
Camel	ZA24-R	A24-R, A46-T	—	—	C24-R	WA24-S
Flexovit	—	A30RB Multi Purpose	A30SB Long Life, A24TB Long Life	—	C24RB	AC24PB Heavy Duty
Metabo	—	A30N, A30R	A30S, A30V	—	C30S	—
Pearl	SRT36	A30P Premium, A30Q Silver Line	A30S Premium, A36R Premium	—	C24 Silver Line	—
Pferd	ZA 24 Q/R SG-HD	A 24 N/P SG-HD	A 24 Q/S SG-HD	—	C 24 0 SG	—
Sait	—	A24N, A36R	A24R	—	C24R	—
Tyrolit	—	A30BF	—	—	C30BF	—
Walter	—	A-24-FC	A-24-RIP	—	—	—

*For Burr-Free applications, please see centrally-reinforced BlueFire Rapid Cut and Gemini Rapid Cut wheels in Chop Saw cut-off wheel section.

** For Foundry and other cut-off wheels, please refer to that section of this Norton Full Line Catalog #7362.



TIER:	BETTER	GOOD	GOOD	GOOD		
TRADENAME:	BLUEFIRE	GEMINI FREE CUT	GEMINI LONG LIFE	MASONRY		
SHAPE:	Type 01/41	Type 01/41	Type 01/41	Type 01/41		
ABRASIVE:	Zirconia Alumina/Aluminum Oxide	Aluminum Oxide	Aluminum Oxide	Silicon Carbide		
MATERIAL:	STAINLESS	STAINLESS	STAINLESS	MASONRY		
	STEEL/METAL	STEEL/METAL	STEEL/METAL			
SIZE (D x T x H)	MAX. RPM	STD. PKG.	PART #	PART #	PART #	PART #
Type 01/41 Straight Cut-Off						
10 x 3/32 x 5/8	6,110	10	662528 43248	662531 06101 FC	662531 06102 LL	
	6,110	5				076607 89391
12 x 1/8 x 1	5,095	10	662528 43249		662532 07548 LL	
	5,095	5				
14 x 1/8 x 1	4,365	10	662528 43251	662533 06609 FC	662533 06611 LL	
	4,365	5				
16 x 5/32 x 1	3,820	10	662528 43255	662534 10183 FC	662534 10184 LL	
18 x 5/32 x 1	3,015	10		662534 10185 FC		
20 x 5/32 x 1	2,710	5	662528 43258 FC	690786 09031 FC	690786 09032 LL	
	2,710	5	662528 43259 LL			
20 x 3/16 x 1	2,710	5		690786 09033 FC	690786 09034 LL	

CUT-OFF WHEEL DESCRIPTION CODES

BLANK = All Purpose FC = Free Cut LL = Long Life ■ = Masonry ■ = Stainless ■ = Steel / Metal

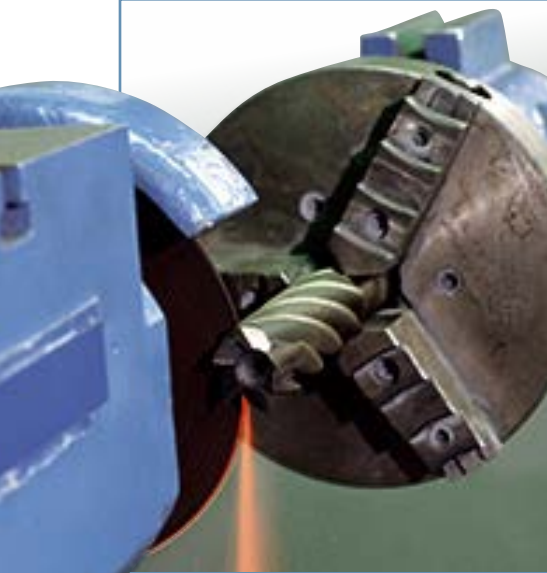

Reinforced and non-reinforced engineered cut-off wheels for cutting all types of tool steel with fixed-based cut-off machines.

Applications:

Reinforced cut-off wheels are designed to resist breakage caused by severe cross-bending and are required on any operation where the work is not securely clamped.

Non-Reinforced cut-off wheels are designed for use on fixed-based machines where the work is securely clamped, guarded, and where the wheel operates on a controlled cutting plane.

Size range:

6" – 12" diameter

Grit range:

36 – 90 grit

Abrasive grain:

Aluminum Oxide

Bond:

Resinoid, Rubber, and Shellac

Shape:

Type 01/41 Straight

Cross Reference Guide

NORTON	BETTER		
	Reinforced A60-QBNA2	Reinforced 57A364-TB25N	Non-Reinforced 57A60-M8B
Bates	A602-T-BF	A36-R-BF	-
Buffalo	A60-R-BF2	-	-
Dia. Tool	A80-SP	A46-SP	-
Radiac	A54-N6-B20	-	A54-N6-B20
Tyrolit	A60-QBF38A2	-	-

TECH TIP

- Smooth side pattern – Used when a precise thickness tolerance is needed
- Rough (R) side pattern – Abrasive particles protrude from sides of wheel

Troubleshooting Guide

PROBLEM	POSSIBLE CAUSES	SUGGESTED CORRECTION
Poor cut rate	Insufficient power used	Increase feed or pressure to full power
	Wheel too hard	Use softer grade, or thinner wheel
	Contact area too large	Reduce contact area
	Wheel too coarse	Use finer grit
	Wheel side out of truth	Check spindle runout
Non-square cuts	Work not clamped properly	Check clamp and clean to remove swarf
	Misaligned spindle bearings	Check for bearing truth and alignment
	Poor coolant distribution	Ensure equal volume of coolant to each wheel side
	Wheel is too hard	Use softer acting wheel: softer grade, or finer grit
Workpiece burn	Insufficient feed rate	Work machine to maximum power available
	Poor coolant flow	Increase volume and direct at cutting point
	Wheel is too coarse	Use finer grit or more machine power
	Wheel is too hard	Use softer grade wheel
	Wheel is running out	Check spindle and flanges
	Wheel speed is too slow	Ensure tight flanges and maximum safe operating speed being used
Poor finish	Too much burr	Use finer grit, or softer grade
	Wheel too coarse	Use finer grit

TECH TIP

- Wheels with a "W" reinforcement (reinforcement around the hole) are not considered to be truly reinforced.
- Clamp or fixture the workpiece for straightest cuts.
- Run wheels at the highest possible speed marked on the wheel and make cuts as quickly as possible. Do not overspeed wheels.
- It is recommended that a cut-off machine should have 1 horsepower for every inch of wheel diameter. For less than this, we recommend using a softer specification.
- Using a harder grade wheel increases wheel life, but it also increases burn, power required and decreases cut rate.
- Using a coarser grit wheel increases wheel life and cut rate, but it also increases burr and power required.

Better choice for cutting tool steel on fixed-based machines when work is not securely clamped



TOOLROOM REINFORCED ALUMINUM OXIDE

- Tough, versatile aluminum oxide grain for toolroom cut-off applications
- Constructed with full diameter fiberglass reinforcement on each side of wheel, to provide greatest possible resistance to side pressure and bending
- OBNA2 full side reinforced, resin bond; yields maximum cut rate and minimum kerf loss; ideal when thin cut is desired
- B25N full side reinforced, resin bond; versatile; durable, free cutting; offer greatest stiffness

SIZE (D x T x H)	MAX. RPM	STD. PKG.	TIER: BETTER		PART #
			SPEC.		
Type O1/41 Straight Cut-off – Reinforced					
6 x .035 x 1/2	10,190	25	A60-OBNA2		662528 35053
6 x .035 x 1-1/4	10,190	25	A60-OBNA2		662528 35055
6 x .060 x 1/2	10,190	25	A60-OBNA2		662528 35164
6 x .060 x 1/2	10,190	25	57A364-TB25N		662528 22969
6 x .060 x 1-1/4	10,190	25	A60-OBNA2		662528 35165
7 x .035 x 1/2	8,730	25	A60-OBNA2		662529 38786
7 x .035 x 1-1/4	8,730	25	A60-OBNA2		662529 38788
7 x .060 x 1/2	8,730	25	A60-OBNA2		662529 38816
7 x .060 x 1-1/4	8,730	25	A60-OBNA2		662529 38796
7 x .060 x 1-1/4	8,730	25	57A364-TB25N		662529 22676

SIZE (D x T x H)	MAX. RPM	STD. PKG.	TIER: BETTER		PART #
			SPEC.		
Type O1/41 Straight Cut-off – Reinforced					
8 x .035 x 1/2	7,640	25	A60-OBNA2		662530 43014
8 x .035 x 1-1/4	7,640	25	A60-OBNA2		662530 42980
8 x .060 x 1/2	7,640	25	A60-OBNA2		662530 43009
8 x .060 x 1-1/4	7,640	25	A60-OBNA2		662530 42983
8 x .060 x 1-1/4	7,640	25	57A364-TB25N		662530 22705
10 x .060 x 5/8	6,110	25	A60-OBNA2		662531 49317
10 x .060 x 1-1/4	6,110	25	A60-OBNA2		662531 49186
12 x .060 x 1	5,095	10	A60-OBNA2		662532 61811
12 x .075 x 1	5,095	10	A60-OBNA2		662532 61910
12 x .075 x 1-1/4	5,095	10	A60-OBNA2		662532 61858

Better choice for cutting tool steel on fixed-based machines when the work is securely clamped



TOOLROOM NON-REINFORCED ALUMINUM OXIDE

- Tough, durable and versatile aluminum oxide grain for toolroom cut-off applications
- Non-reinforced, use on fixed-based machines where the work is securely clamped
- B bond (smooth sides); a mild acting resin bond for light cut-off applications
- B25 bond (smooth sides); a versatile, free-cutting, more durable resin bond; ideal for dry cutting metal in high production runs
- E7 bond (smooth sides); a shellac bond with very mild cutting action, recommended for highly critical applications where no burr, heat checks, or discoloration is permitted
- R30 bond (smooth sides); mild acting rubber bond primarily for wet, ultra-thin cutting

SIZE (D x T x H)	MAX. RPM	STD. PKG.	TIER: BETTER		PART #
			SPEC.		
Type O1/41 Straight Cut-off – Non-Reinforced					
6 x .015 x 1-1/4	6,370	25	57A90-ROR30		662528 22953
6 x .020 x 1-1/4	6,370	25	57A90-ROR30		662528 22954
6 x .035 x 1-1/4	6,370	25	57A60-M8B		662528 22958
6 x .060 x 1/2	7,640	25	57A541-RB25		662528 22970
6 x .060 x 1-1/4	7,640	25	57A60-M8B		662528 22975
7 x .035 x 1-1/4	5,460	25	57A60-M8B		662529 22983
			57A60-O8B		662529 22986
			57A60-Q8B		662529 22987
7 x .035 x 1-1/4	5,460	25	57A601-PB25		662529 22988
			57A601-RB25		662529 22989
			57A60-OE7		662529 22985
7 x .035 x 1-1/4	5,460	25	23A601-PB25		662529 38701
7 x .050 x 1-1/4	5,460	25	23A601-PB25		662529 38724*
7 x .060 x 1/2	6,550	25	57A60-O8B		662529 22672

*Exception: rough sides

SIZE (D x T x H)	MAX. RPM	STD. PKG.	TIER: BETTER		PART #
			SPEC.		
Type O1/41 Straight Cut-off – Non-Reinforced					
7 x .060 x 1-1/4	6,550	25	57A46-M8B		662529 22677
			57A60-M8B		662529 22681
			57A60-O8B		662529 22684
			57A60-OE7		662529 22683
7 x .090 x 1-1/4	6,550	25	57A60-M8B		662529 22690
7 x .125 x 1-1/4	6,550	25	57A60-M8B		662529 22692
8 x .035 x 1-1/4	4,775	25	57A60-N8B		662530 22694
8 x .060 x 1/2	5,730	25	57A60-M8B		662530 22702
8 x .060 x 1-1/4	5,730	25	57A60-M8B		662530 22708
8 x .060 x 1-1/4	4,540	25	57A60-OE7		662530 22709
10 x .060 x 5/8	4,585	25	57A46-Q8BW		662531 22816
			57A60-M8BW		662531 22818
10 x .090 x 5/8	4,585	25	57A60-M8BW		662531 22824



The Norton RailCut line is designed for high-speed fixtured hydraulic or gas-powered rail saws.

- Applications:** Fixed rail track cutting
- Size range:** 14" and 16" diameter
- Thickness range:** 1/8"
- Grit range:** 14 – 16
- Abrasive grain:** Zirconia Alumina / Aluminum Oxide Blend, Zirconia Alumina, and Aluminum Oxide
- Shape:** Type 01/41 Straight
- Reinforcement:** Side reinforced with R (rough) sides
- Speed rating:** All wheels are rated for 20,000 SFPM applications
- Machines Used:**



FIXTURED HYDRAULIC OR
GAS-POWERED RAIL SAW

Cross Reference Guide and Machine-to-Product Recommendation Guide

	BEST	BETTER	GOOD	GOOD
NORTON	RailCut X	RailCut NorZon III	RailCut A30X	RailCut Metal
Bullard Abrasive	Trackmaster Pro ZA24 Q-BF (Blue)	Trackmaster Pro ZA24 Q-BF (Blue)	Trackmaster A30 R-BF (Red)	—
DiaTool	—	—	—	RailMaster Rail Cut 27
Flexovit USA	—	—	A30-PB	—
Giesmar	AM303-R	AM303-R	NR242-Q	NR242-Q
Klingspor	A 24 SX Special	A 24 SX Special	—	—
Portaco	A30 R-BF	A30 R-BF	—	—
Racine Kwik Kut	A24R	A24R	—	—

	BEST	BETTER	GOOD	GOOD	
	RailCut X	RailCut NorZon III	RailCut NorZon III FastCut	RailCut A30X	RailCut Metal
HYDRAULIC SAW	◆	—	—	◆	◆
GAS SAW	—	—	—	—	—
High-Horsepower / Newer Machine	◆	◆	—	◆	◆
Low-Horsepower / Older Machine	◆	◆	◆	◆	◆



Best choice for high-performance cutting of rails on applications where the hydraulic or gas saw is fixtured and has adequate power

RAILCUT X ZIRCONIA ALUMINA / A/O BLEND

- Highest-performance zirconia alumina and engineered aluminum oxide abrasive blend expertly cuts a broad range of rail material
- Rough sides enable fastest cutting and longest lasting wheels
- Achieve highest productivity with lowest total abrasive costs



Good choice for price-sensitive jobs with lowest initial price

RAILCUT METAL ALUMINUM OXIDE

- Quality aluminum oxide abrasive wheels designed for jobs where low initial price is a key purchasing criterion
- Side reinforced with rough sides; rated for 20,000 SFPM applications
- Designed for multi-purpose use; great versatility on a variety of rail materials



	TIER: BEST	BETTER	BETTER	GOOD	GOOD		
TRADENAME:	RAILCUT X	RAILCUT NORZON III	RAILCUT NORZON III FASTCUT	RAILCUT A30X	RAILCUT METAL		
ABRASIVE:	Zirconia Alumina/ Aluminum Oxide Blend	Zirconia Alumina	Zirconia Alumina	Aluminum Oxide	Aluminum Oxide		
SIZE (D x T x H)	MAX. RPM	STD. PKG.	PART #	PART #	PART #		
Type 01/41 Cut-Off							
14 x 1/8 x 1	5,400	10	662533 37716	662533 60493	662533 63694	662532 60462	662434 82068
16 x 1/8 x 1	4,800	10	662533 35024	662534 64607	662534 64415	662532 59935	662434 82066



Foundry cut-off wheels are designed with abrasives, bonds and reinforcement types specific to foundry machine parameters and materials. Most of the specifications are non-stock. This stock listing is designed to provide popular size and starting specifications.

- Size Range:** Reinforced: 14" – 30" diameter; Non-reinforced: 12" – 20" diameter
- Grit Range:** 24 – 46 grit
- Abrasive Grain:** Ceramic Alumina (Norton Quantum; non-stock only), Zirconia Alumina, Aluminum Oxide
- Reinforcement:** Reinforced: Engineered with strengthening fabric or filaments, which make wheels resistant to cross-bending breakage. All portable cut-off, swingframe, locked-head push-through and foundry chop stroke operations require reinforced cut-off wheels.
 B: One or more full diameter pieces of filament molded inside each wheel. This construction leaves the abrasive exposed on the side of the wheel, improving freeness of cut. Used for fixed work operations with low probability of side pressure.
 N: Full diameter pieces of reinforcement on the side of the wheel. Offers greatest possible resistance to side pressure and bending.
 Non-Reinforced: Designed for use on fixed-base types of machines where the work is securely clamped and guarded, and where the wheel operates on a controlled cutting plane.
 W: Reinforcement around the center hole only. These wheels are not considered to be truly reinforced.
- Side Patterns:** Smooth sides: Used for precision cutting applications
 Rough (R) sides: Abrasive particles protrude from sides of wheel
 Used wet or dry on most metals

Material-to-Product Recommendation Guide

	BEST	BETTER	GOOD	GOOD
	Foundry X Quantum*	Foundry X BlueFire	Foundry X	Foundry Metal
INVESTMENT CAST ALLOYS				
Stainless Steel	◆	◆	◆	◆
Titanium	◆	◆	◆	◆
CAST IRON				
	◆	◆	◆	◆
CAST STEEL				
Carbon and Low Alloy	◆	◆	◆	◆
Stainless Steel and High Alloy	◆	◆	◆	◆
Aluminum Alloy	◆	◆	◆	◆
Copper Alloys, Brass, Bronze	◆	◆	◆	◆

*Foundry X Quantum wheels are non-stock, custom-made to your requirements

Cross Reference Guide

	TOTAL PERFORMANCE		INITIAL PRICE	
	BEST	BETTER	GOOD	GOOD
NORTON	Foundry X Quantum and B97 (Non-stock; custom-made to your exact requirements)	Foundry X BlueFire	Foundry X	Foundry Metal
Allison	TA362 R6 8045HA, YW462 MR B2HA	TA302-T6-B6HA, A46-T6-BX5T6A, HF 1247 K – CHALLENGER	—	Economiser
Avery	—	TA30-V680	A 3226 C7A, C11922 W071	92871H
Buckeye	—	Steel Shark	—	—
DiaTool	BV1734R 710	BV 1397-5284-C	—	—
Flexovit	—	ZAX30TB	A24PB, A30RB	—
Klingspor	20A24-QBF	—	—	—
NATAB	—	—	T 1584 HA	—
Rappold	—	6Z30U-B3F2	—	—

Better choice on stainless steel, aerospace alloys, cast iron, and steel



FOUNDRY X BLUEFIRE REINFORCED

- Next generation self-sharpening zirconia alumina abrasive provides fast cuts on foundry cut-off applications
- Improved durability and heat resistance result in longer abrasive life
- More aggressive; can withstand very demanding applications

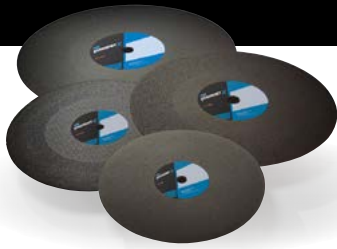

Good choice on general purpose applications

FOUNDRY X ALUMINUM OXIDE

- Durable, versatile aluminum oxide abrasive engineered for consistent performance and economical price on foundry cut-off applications
- Advanced bond technology with improved thermal stability and mechanical strength
- Excellent value on stainless steel and exotic aerospace alloys



Good choice for price-sensitive jobs with lowest initial price

FOUNDRY METAL ALUMINUM OXIDE

- Great versatility from multi-purpose aluminum oxide abrasive formulated specifically for typical foundry applications
- Bond and reinforcement engineered to foundry market machine parameters and materials
- Good choice for small jobs and quick applications where performance is not measured

Reinforced



TIER:	BETTER	GOOD	GOOD
TRADENAME:	FOUNDRY X BLUEFIRE	FOUNDRY X	FOUNDRY METAL
ABRASIVE:	Zirconia Alumina / Aluminum Oxide	Aluminum Oxide	Aluminum Oxide

SIZE (D x T x H)	MAX. RPM	STD. PKG.	SPEC.	PART #	SPEC.	PART #	SPEC.	PART #
Type 01/41 Straight Cut-off – Foundry Reinforced								
14 x 1/8 x 1	4,365	10	NV24-TB75N	662533 47674	U57A30-TB75N	662533 45779	Side Reinforced	662434 85918
	4,365	10	NV24-VB75N	662531 79193	U57A30-VB75N	662531 79191		
	4,365	10	NV24-YB97N	662533 47698				
16 x 5/32 x 1	3,820	10	NV24-TB75N	662533 47676	U57A30-TB75N	662533 45781	Side Reinforced	662434 85919
	3,820	10	NV24-VB75N	662531 79147	U57A30-VB75N	662531 79148		
	3,820	10	NV24-YB97N	662533 47693				
20 x 5/32 x 1	2,710	10	NV24-TB75N	662533 47683	U57A30-TB75N	662533 47546	Side Reinforced	662434 85920
	2,710	10	NV24-VB75N	662531 79363	U57A30-VB75N	662531 79364		
	2,710	10	NV24-YB97N	662533 47694	U57A30-YB97N	662533 47701		
20 x 3/16 x 1	2,710	10	NV24-TB75B	662533 47684	U57A30-TB75B	662533 47547	Centrally Reinforced	662434 85921
	2,710	10	NV24-YB75B	662531 79366	U57A30-VB75B	662531 79367		
	2,710	10	NV24-YB97B	662533 47699	U57A30-YB97B	662533 47702		
24 x 7/32 x 1-3/4	2,260	10	NV24-TB75B	662533 47685				
	2,260	10	NV24-VB75B	662531 79374	U57A30-VB75B	662531 79375		
	2,260	10	NV24-YB97B	662533 47697				
30 x 1/4 x 1-3/4	1,810	10	NV24-TB75B	662533 47722	U57A30-TB75B	662533 47720		
	1,810	10	NV24-YB97B	662533 47723	U57A30-YB97B	662533 47721		

Specifications ending in "B" are centrally reinforced; specifications ending in "N" are side reinforced.

Non-Reinforced



TIER:	BETTER	GOOD
TRADENAME:	U57A	GEMINI
ABRASIVE:	Aluminum Oxide	Aluminum Oxide

SIZE (D x T x H)	MAX. RPM	STD. PKG.	SPEC.	PART #	SPEC.	PART #
Type 01/41 Straight Cut-off – Foundry Non-Reinforced R-Sides						
12 x 3/32 x 1	5,095	10	U57A461-PB25	662532 61887		
16 x 1/8 x 1	3,820	10			AP	662534 22942
20 x 1/8 x 1	2,710	10	U57A304-VB25W	690786 65497		

Ask your Norton representative about our custom, made-to-order Norton Foundry X Quantum ceramic alumina wheels for high alloys, stainless steel, and aerospace applications.

CUT-OFF WHEEL DESCRIPTION CODES

AP = All Purpose

Where a good blend of cut rate and life is needed



For consistent, quality performance in foundries, welding shops, fabrication facilities, steel mills and shipyards, Norton portable snagging wheels maximize your productivity. Used on horizontal/straight shaft grinders or right angle portable cup grinders.

- Applications:** Removing flaws, cracks, gates, risers and parting lines, smoothing weld seams, cleaning castings, and rough beveling
- Size Range:** Type 01 Straight Wheels: 2-1/2" – 8" diameter
Type 06 and 11 Cup Wheels: 4" – 6" diameter
Cones and Plugs: Type 16, 17, 17R, 18 and 18R
- Grit Range:** 14 – 24
- Abrasive Types:** Zirconia Alumina NZ and NV; Zirconia Alumina / Silicon Carbide Blend NVC; Aluminum Oxide 57A and Metal; Aluminum Oxide / Silicon Carbide Blend 57AC, Silicon Carbide 37C and Masonry

Machine Used:



PORTABLE CUT-OFF TOOL

RIGHT ANGLE GRINDER

PORTABLE GRINDER

Material-To-Product Recommendation Guide

	BEST	BETTER	GOOD	
	NorZon Plus	BlueFire	Gemini	Metal
IRON				
Gray	◆ NZ14-R	◆ NV16-Q	◆ 57A16-Q	◆
Ductile/Malleable	◆ NZ14-R	◆ NV16-Q	◆ 57A16-Q	◆
Dirty/Scale-covered		◆ NVC16-Q	◆ 57AC16-Q	
STEEL				
Carbon and Low Alloy	◆ NZ14-Q	◆	◆ 57A16-Q	◆
Stainless and High Alloy	◆ NZ14-P	◆	◆ 57A16-Q	◆
ALUMINUM, COPPER, BRASS, & BRONZE ALLOYS		◆ NVC16-Q	◆ 57AC16-Q	

NOTE: Grade, Grit and Abrasive tuning may be necessary to obtain optimum performance

Cross Reference Guide for Type 01, 06 and 11 Wheels

	TOTAL PERFORMANCE ←			→ INITIAL PRICE	
	BEST	BETTER	GOOD		
NORTON	NorZon Plus	BlueFire NV	Gemini 57A/Metal	Gemini 57AC	Gemini 37C/Masonry
Brilliant	—	ZA16QB	A16QB	—	C16QB
Bullard	—	ZA16PB	A16R	AC16	C16P
Camel	—	—	A	CA	C
Flexovit	ZA16PB	—	A16QB	AC16QB	C16PB
Gulf States	Zirconium	—	A16	—	C16
Pacific	Z, Z-GPC	—	A	CA	—
Pearl	—	—	A16Q	—	C16-Q
Pferd	ZA 16 Q SG	—	A 16 Q SG	—	C 16 Q SG
Sait	—	Z16	A16, 20	CA16	C16
Tyrolit	—	—	A16PB	—	C16PB
Walter	—	—	A	—	C

Best choice for heavy-duty stock removal on medium- and high-horsepower grinders



NORZON PLUS ZIRCONIA ALUMINA

- Tough, durable, premium zirconia alumina grain provides 10X life and 50% faster grinding versus aluminum oxide products
- Engineered to excel on the toughest foundry snagging applications
- Best performance on a wide variety of materials; 300 and 400 series stainless, soft and hard carbon steels, tool steels, titanium, super alloys, soft metals, and cast, ductile and gray iron

Better choice for stock removal on high- and medium-horsepower grinders



BLUEFIRE ZIRCONIA ALUMINA

- Friable zirconia alumina grain and durable resin bond technologies deliver sharper grain longer, for extended wheel life, higher metal removal rates, and faster, freer cutting action than standard zirconia alumina blends
- Ideal for foundry snagging, tool sharpening, portable grinding and stock removal applications on high- and medium-horsepower grinders
- Strong operator preference for these smooth-acting wheels that require less pressure and exertion, while improving productivity
- NVC – zirconia alumina / silicon carbide blend is highly effective on dirty, scale-covered castings
- Available with low odor bond to help reduce odors associated with portable grinding when used in confined spaces

Good choice for steel and ferrous metals as well as specialty applications in aluminum and foundries



GEMINI ALUMINUM OXIDE

- Tough, durable aluminum oxide abrasive for heavy-duty work including foundry snagging, tool sharpening, and stock removal
- Work well with a variety of machines, horsepower, and operations
- Good general-purpose choice for numerous small jobs
- Available with low odor bond to help reduce odors associated with portable grinding when used in confined spaces

Good choice for steel/ferrous metal applications with low initial price



METAL ALUMINUM OXIDE

- Tough, durable aluminum oxide abrasive for heavy-duty work including foundry snagging, tool sharpening, and stock removal
- Work well with a variety of machines, horsepower, and operations
- Good general-purpose choice for numerous small jobs on 300 and 400 series stainless, soft and hard carbon steels, tool steels, titanium, super alloys, soft metals, and cast, ductile and gray iron

Good choice for masonry applications with low initial price







MASONRY ALUMINUM OXIDE

- Sharp silicon carbide abrasive for small-volume snagging jobs
- Delivers rapid stock removal in small areas on a portable cup grinder
- Versatile; good starting specification where initial price is a primary purchasing consideration, especially nonferrous and masonry



TIER:	BEST	BETTER	GOOD	GOOD
TRADENAME:	NORZON PLUS	BLUEFIRE	GEMINI	METAL/MASONRY
SHAPE:	Type 01 and 11	Type 01, 06, and 11	Type 01 and 11	Type 11
ABRASIVE:	Premium Zirconia Alumina	Zirconia Alumina NV Zirconia Alumina/ Silicon Carbide NVC	Aluminum Oxide 57A, Silicon Carbide 37C, Aluminum Oxide/ Silicon Carbide 57AC	Metal – Aluminum Oxide Masonry – Silicon Carbide

SIZE (D x T x H)	MAX. RPM	STD. PKG.	SPEC	PART #	SPEC	PART #	SPEC	PART #	SPEC	PART #
Type 01 Straight 										
2-1/2 x 1/2 x 3/8	21,700	20					57A24-R	662435 22381		
3 x 1/4 x 3/8	20,370	25			NV20-T	662533 43872*	57A24-T	662435 28831		
3 x 3/8 x 3/8	18,080	10					57A24-R	662435 22415		
3 x 1/2 x 3/8	18,080	10					57A24-P	662435 22417		
4 x 1/4 x 3/8	15,280	10			NV20-T	662533 44098	57A24-R	662435 22221		
6 x 1 x 5/8	8,000	5			NV14-R	662531 98589	57A16-QS	662528 09563		
S Webs	8,000	5			NZ III 14-Q	662528 38075				
	8,000	5			NZ III 14-R	662528 37961				
8 x 3/4 x 5/8	6,000	10			NV14-S	662533 44347				
S Webs										
8 x 1 x 5/8	6,000	5	NZ IV 16-Q	662530 30778	NV16-Q	662531 98590				
S Webs	6,000	5	NZ IV 16-Q	662530 44532						
	6,000	10			NV14-R	662533 44355				
	6,000	10			NV14-T	662533 44365				
	6,000	10			NVC16-Q	662531 98592				
Type 06 Straight Cup 										
6 x 2 x 5/8-11	6,000	5			NZ III 16-R	662528 38577				
Rim 2" Back 3/4"										
Type 11 Flaring Cup 										
4/3 x 2 x 5/8-11	9,070	10	NZ IV 16-Q	662435 30761	NV16-Q	662531 98583	57A16-Q	662435 10512	Masonry C16-Q	076607 89431
Rim 3/4" Back 3/4"										
5/3-3/4 x 2 x 5/8-11	7,260	5			NV16-Q	662531 46918	57A16-Q	662528 09598	Metal 16-Q	076607 89430
Rim 1" Back 3/4"	7,260	5			4NZ16-Q RB	690786 40233	57AC16-Q RB	690786 40234		
6/4-3/4 x 2 x 5/8-11	6,000	5			NV16-Q	662531 46925	57A16-Q	662528 25201		
Rim 1" Back 3/4"	6,000	5			NZ III 16-Q	662528 38568				
6/4-3/4 x 2 x 5/8-11	6,000	5	NZ IV 16-P	662528 30765	NV14-R	662533 44371	37C16-P	662528 09609		
Rim 1-1/2" Back 3/4"	6,000	5			NV16-Q	662531 98584	57A16-Q	662528 09618		
	6,000	5			NVC16-Q	662531 46922	57AC16-Q	662528 09608		
	6,000	5			4NZ16-Q RB	690786 40484	9CA16-Q RB Ti	690786 40488		
							57AC16-Q RB	690786 40485		
Type 11 Flaring Cup with Steel Back 										
4/3 x 2 x 5/8-11	9,070	10			NV16-Q	662531 46917				
Rim 3/4" Back 3/4"										
5/3-13/16 x 2 x 5/8-11	7,260	10			NV16-Q	662531 46920				
Rim 1" Back 3/4"										
6/4-13/16 x 2 x 5/8-11	6,000	5			NV14-R	662533 44373	57A16-Q	662528 09599		
Rim 1-1/2" Back 3/4"	6,000	5			NV16-Q	662531 98586	57AC16-Q	662528 09600		
	6,000	5			NVC16-Q	662531 46929	57AC16-Q RB	690786 40486		
	6,000	5			4NZ16-Q RB	690786 40487	9CA16-Q RB Ti	690786 40489		

* Std. Pkg. = 50

RB = Low odor bond. Note: Ti formulation optimized for grinding Titanium

TECH TIP

Norton BlueFire and Gemini Type 11 cup wheels now available in new RB low odor bond to help reduce odors associated with portable grinding when used in confined spaces.



TIER:	BEST	BETTER	GOOD	GOOD
TRADENAME:	NORZON PLUS	BLUEFIRE	GEMINI	METAL
ABRASIVE:	Zirconia Alumina	Zirconia Alumina/Aluminum Oxide	Aluminum Oxide	Aluminum Oxide

SIZE (D x T x H)	MAX. RPM	STD. PKG.	SPEC	PART #	SPEC	PART #	SPEC	PART #	SPEC	PART #
Type 16 Cones										
1 x 3 x 3/8-24 (ME 107019)	36,290	10			NV20-S	662533 44376	57A24-R	614636 22342	Metal 24	662533 49752
1-1/2 x 2-1/2 x 3/8-24 (ME 44436)	24,190	10					57A24-R	614636 22349	Metal 24	662533 49754
1-1/2 x 2-1/2 x 5/8-11 ME 171651	24,190	10					57A24-R	690786 40166	Metal 20	690786 40046
1-1/2 x 3 x 3/8-24 (ME 139029)	24,190	10			NV20-S	662533 44377				
1-1/2 x 3 x 3/8-24 (ME 171652)	24,190	10							Metal 20	690786 40215
1-1/2 x 3 x 5/8-11 (ME 70535)	24,190	10	NZ IV 20-R	614636 44231	NV20-S	662533 44379	57A24-R	614636 22190	Metal 24	662533 49757
1-3/4 x 3 x 3/8-24 (ME49226)	20,735	10					57A24-R	614636 14503	Metal 24	662533 49840
1-3/4 x 3 x 5/8-11 (ME 33432)	20,740	10					57A24-R	614636 22195	Metal 24	662533 49841
2 x 3 x 3/8-24 ME 157287	18,145	10							Metal 24	662534 76413
2 x 3 x 5/8-11 (ME 28229)	18,145	10	NZ IV 20-R	614636 44232	NV20-S	662533 44381	57A24-R	614636 22218	Metal 24	662533 49846
2-3/4 x 3-1/2 x 5/8-11 (ME 18265)	13,195	10			NV20-S	662533 44383	57A24-R	614636 22387	Metal 24	662533 49855
3 x 3 x 5/8-11 (ME70537)	12,100	10							Metal 24	662434 96885
Type 17 Cones, Square Tip										
1-1/2 / 1/2 x 3 x 3/8-24	24,190	10					57A24-R	614636 22194	Metal 24	662533 49753
1-1/2 / 1/2 x 3 x 5/8-11	24,190	10					57A24-R	690786 40225	Metal 20	690786 40224
2 / 1/2 x 3 x 5/8-11	18,145	10					57A24-R	614636 15722	Metal 24	662533 49845
Type 17R Cones, Round Tip										
2 / 3/4 x 3 x 5/8-11 (ME 151373)	18,145	10			NV20-S	662533 44384				
Type 18 Plugs, Square Tip										
1-1/2 x 2-1/2 x 3/8-24	24,190	10					57A24-R	614636 22217	Metal 24	662533 49755
	24,190	1 V					57A24-R	662533 25902		
1-1/2 x 2-1/2 x 5/8-11	24,190	10	NZ IV 20-R	614636 44224	NV20-S	662533 44385	57A24-R	614636 22351	Metal 20	690786 40226
	24,190	1 V					57A24-R	662533 25905		
1-1/2 x 3 x 5/8-11	24,190	10			NV20-S	662533 44386	57A24-R	614636 22191	Metal 24	662533 49838
	24,190	1 V					57A24-R	662533 25909		
2 x 3 x 5/8-11	18,145	10	NZ IV 20-R	614636 44234	NV20-S	662533 44387	57A24-R	614636 22219	Metal 24	662533 49847
	18,145	10					NV24-S	662533 44391		
2 x 4 x 5/8-11	18,145	10					57A24-R	614636 22366	Metal 24	662533 49850
Type 18R Plugs, Round Tip										
1-1/2 x 2-1/2 x 3/8-24	24,190	10					57A24-R	690786 40230	Metal 20	690786 40229
1-1/2 x 2-1/2 x 5/8-11	24,190	10					57A24-R	690786 40228	Metal 20	690786 40227
1-1/2 x 3 x 3/8-24	24,190	10					57A24-R	614636 22192	Metal 24	662533 49756
1-1/2 x 3 x 5/8-11	24,190	10							Metal 24	662434 95628
2 x 3 x 5/8-11	18,145	10			NV20-S	662533 44389	57A24-R	614636 22220	Metal 24	662533 49849
3 x 3 x 3/8-24	12,095	10					57A24-R	690786 40232		
3 x 3 x 5/8-11	12,095	10							Metal 20	690786 40231

V = Vendible Package. Ideal for vending machines and small jobs.

Core Files

These files consist of coarse grit silicon carbide abrasive in a hard grade, resin-bonded to a reinforcing rod. Half-round in shape, they are a frequent choice for easy cleaning of rough castings.



TIER:	GOOD
ABRASIVE:	Silicon Carbide

SIZE (T x W x L)	STD. PKG.	SPEC.	PART #
Stock Resinoid Core Files – Silicon Carbide			
1/2 x 1 x 10	5	37C24-SB	614636 10314

the brightest product
solutions from
**A TOTAL SPECTRUM
OF INNOVATION**

For everything from heavy-to-medium stock removal, to fine finishing, to light blending and polishing, abrasive products are available in many shapes, abrasive grains, specialty coatings and backing configurations to meet many application needs.

Coated Abrasives

A coated abrasive product is made up of three basic raw materials: an abrasive grain, the backing onto which the abrasive is applied, and an adhesive bond.

Abrasive Types

Emery (6)

Emery is a dark gray, round-shaped grain which tends to polish rather than abrade a work surface.

- For polishing and cleaning metal only



Garnet (5)

Garnet is reddish brown in color. This natural abrasive is medium hard and relatively sharp, but not as durable as synthetic abrasives.

- For use on wood only
- Particularly good for soft woods such as pine
- Produces an excellent finish



Silicon Carbide (4)

Silicon carbide is the hardest and sharpest of the manufactured abrasives. Because of its extreme sharpness, this bluish-black abrasive grain permits fast stock removal and cool cut.

- Cast iron
- Non-ferrous metals, i.e. brass, aluminum and bronze
- Non-metallics, i.e. glass, rubber, plastic and stone
- Final finish on wood and stainless steel
- Abrasive planing particleboard



Light Brown Aluminum Oxide (2)

Light brown aluminum oxide is a tough, yet sharp synthetic abrasive characterized by cool cut, long life and the ability to break down under pressure, producing new cutting edges.

- Production wood sanding
- Non-ferrous metal finishing



Brown Aluminum Oxide (2, 7)

Brown aluminum oxide is a tough, durable, synthetic abrasive characterized by the long life and wear resistance of its cutting edges. It offers enormous penetrating strength, even at high speeds.

- Ferrous metals
- Aluminum
- Hardwood



Heat-treated Aluminum Oxide (2)

Heat-treated aluminum oxide is a tough but cool cutting abrasive which gives both long life and freeness of cut on a wide range of materials.

- Ferrous metals
- Wood sanding



Zirconia Alumina (8)

Zirconia alumina is an ultra-tough, synthetic abrasive which provides a free, cool cut for high stock removal applications. It is tougher and sharper than aluminum oxide. It has a micro-crystalline structure which allows for controlled breakdown and self-sharpening.

- Heavy-duty snagging and grinding of all ferrous and non-ferrous metals
- Abrasive planing of wood, plywood and particleboard
- Grinding fiberglass, rubber and plastics



Ceramic Alumina (9)

The sub-micron structure of ceramic alumina allows each grain to continually expose sharp cutting points, resulting in a cooler cutting action and an extended life.

- All ferrous/non-ferrous metals, carbon steel and exotic alloys

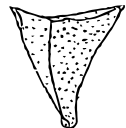

Backing Types

Backings are the base for the abrasive minerals and, combined with the adhesive bond, support and anchor the abrasive mineral. The backings used in the manufacture of coated abrasives are:

Paper

Due to the fine surface of paper, a consistent finish is produced. Paper weights include *A, B, C, D, E* and *F* weights with *A* being the lightest and most flexible and *F* being the heaviest and least flexible. *A, B, C* and *D* weight papers are used for hand sanding and light mechanical operations in the form of sheets, PSA (pressure sensitive adhesive) and hook and loop discs and sheet rolls. *E* and *F* weight papers are primarily used for more aggressive mechanical operations in the form of belts and discs.

Cloth

Cloth backings used for coated abrasives are identified by weight. Cloth backings are filled or "finished" with a variety of materials (glues or resins) to create various backing characteristics, most notably flexibility. Several cloth types are used: cotton, polyester, polyester/nylon and polyester/cotton blends, and rayon.

There are three basic weights of cloth: J-weight or "jeans" is the lightest and most flexible. X-weight or "drills" is a heavier cloth that ranges in flexibility, strength and durability and is used on the broadest range of applications. Y-weight is a heavyweight drills cloth used on heavy-duty, high stock removal operations.

Fiber

Vulcanized fiber (cotton fibers which are chemically treated and then pressed under temperature and pressure to form a very durable backing) is used exclusively as the backing for resin fiber discs.

Film

Polyester film backing comes in 3 mil. and 5 mil. thicknesses, which have high strength and surface smoothness. They are used primarily in disc and roll applications requiring consistent surface finish, including powertrain applications.

Foam

Primarily used as backing for sponges, finer grit finishing discs, and buffing and polishing pads for cleaning and moist finishing applications.

Mesh

Mesh matrix backing comprised of thousands of tiny holes allowing for maximum dust extraction.

Bond Types

An adhesive bond system is required to secure the abrasive mineral to the backing. All coated abrasive products are made with a two stage bonding process, the *make coat* and the *size coat*.

The *make coat* is the first layer of bond applied to the backing. The make coat provides the adhesive base between the abrasive mineral and the backing.

The *size coat* is the second coat, which is applied over the abrasive mineral and make coat to anchor the abrasive mineral and provide the desired physical strength of the finished product.

Glue, urea resin, and phenolic resin are the three basic bonding agents most commonly used. There are many size coat and make coat combinations, such as *glue over glue, urea over glue, and resin over resin*. *Glue over glue* is the most flexible bond while *resin over resin* bond is moisture-resistant, harder, less flexible, heat-resistant and has superior grain retention.

Coating Types

There are two types of abrasive coatings used in the manufacturing of coated abrasives: *open coat* and *closed coat*.

Open Coat

With an open coat, 50% to 75% of the surface is covered by abrasive grain. There are evenly spaced voids between the particles of grain, helping reduce the effect of loading caused by wood dust or metal particles.

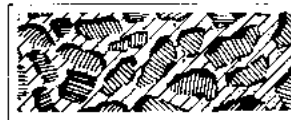

OPEN COAT
(1/3 LESS GRAIN THAN CLOSED)

Closed Coat

With a closed coat, the entire surface is covered with abrasive grain, with no voids between the particles. This is the most typical coating, permitting the greatest degree of stock removal and longest product life.

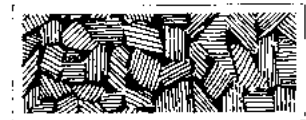

CLOSED COAT

Super Size Coating

The Super Size coat is an optional final coat and grinding aid applied over the size coat to help maintain low grinding temperatures and prevent loading.

How to Read a Coated Abrasive Specification

The Norton coated abrasive marking system includes both a generic and a technical marking, which identifies the actual components which make up the product. The markings identify the tradename, abrasive type, bond, backing, and any special features. An example would be: Norton Blaze R980P.

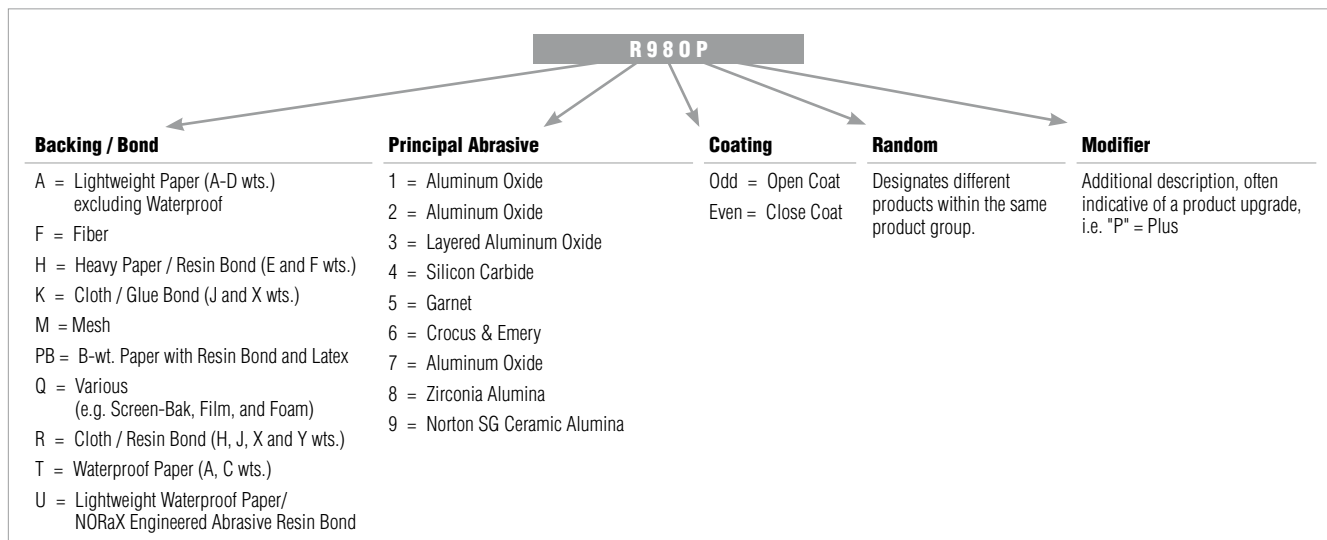

Coated Abrasive Grit Comparison Chart

AVERAGE PARTICLE SIZE IN MICRONS	GRADING SYSTEMS (OTHER THAN EMERY)			EMERY PRODUCTS
	ANSI	FEPA	JIS	
5.0	-	-	-	-
6.0	-	-	3000	-
6.5	1200	-	2500	4/0
8.4	-	P2500	-	-
8.5	-	-	2000	-
9.2	1000	-	-	3/0
10.3	-	P2000	-	-
10.5	-	-	1500	-
12.2	800	-	1200	-
12.6	-	P1500	-	-
15.0	-	-	-	-
15.3	-	P1200	1000	-
16.0	600	-	-	2/0
18.3	-	P1000	800	-
19.7	500	-	-	0
20.0	-	-	-	-
21.8	-	P800	-	-
23.6	400	-	600	-
25.0	-	-	-	-
25.75	-	P600	-	-
28.8	360	-	500	-
30.0	-	P500	-	-
35.0	-	P400	400	-
36.0	320	-	-	-
40.0	-	-	360	-
40.5	-	P360	-	-
44.0	280	-	-	1
45.0	-	-	-	-
46.2	-	P320	320	-
50.0	-	-	-	-
52.5	-	P280	280	-
53.5	240	-	-	-
55.0	-	-	-	-
58.5	-	P240	-	-
60.0	-	-	240	-
64.0	-	-	-	2
65.0	-	P220	220	-
66.0	220	-	-	-
78.0	180	P180	180	-
79.0	-	-	-	3
93.0	150	-	150	-
95.0	-	-	-	FINE
97.0	-	P150	-	-
116.0	120	-	120	-
127.0	-	P120	100	-
136.0	-	-	-	MEDIUM
141.0	100	-	-	-
156.0	-	P100	-	-
189.0	-	-	-	COARSE
192.0	80	-	80	-
197.0	-	P80	-	-
260.0	-	P60	-	-
268.0	60	-	60	-
326.0	-	P50	50	-
341.0	-	-	-	EX. COARSE
351.0	50	-	-	-
412.0	-	P40	40	-
428.0	40	-	-	-
524.0	-	P36	-	-
535.0	36	-	36	-
622.0	-	P30	-	-
638.0	30	-	30	-
715.0	24	-	-	-
740.0	-	P24	24	-
905.0	20	-	-	-
984.0	-	P20	20	-
1320.0	16	-	16	-
1324.0	-	P16	-	-
1764.0	-	P12	-	-
1842.0	12	-	-	-

Coated Abrasive Storage

Stored under proper conditions, coated abrasives will retain their efficiency and usefulness over long periods. Improper or inadequate storage can introduce problems of weakened bond, curl, brittleness, and breakage.

Temperature and humidity are the two most important climatic factors influencing coated abrasive performance. Backings and adhesives are sensitive to climatic changes and will gain or lose moisture according to the relative humidity of their surroundings.

Excessive humidity may cause a softening of some types of adhesive bonds so that the product quickly fills and clogs, or loses its grain during use. Excessive dryness may cause brittleness, reduced flexibility, and distortion of product shapes.

As moisture in the coated abrasive product increases or decreases, dimensional changes can occur. When the backing changes more than the adhesive bond, it causes cupping. High and low humidity can cause concave and convex cupping respectively.

The newer synthetic-backed belts are not affected by moisture. Broad temperature swings will not permanently harm these products either, but cold temperatures will cause a "cold set" condition. Consequently, these products should be allowed to come to room temperature before use.

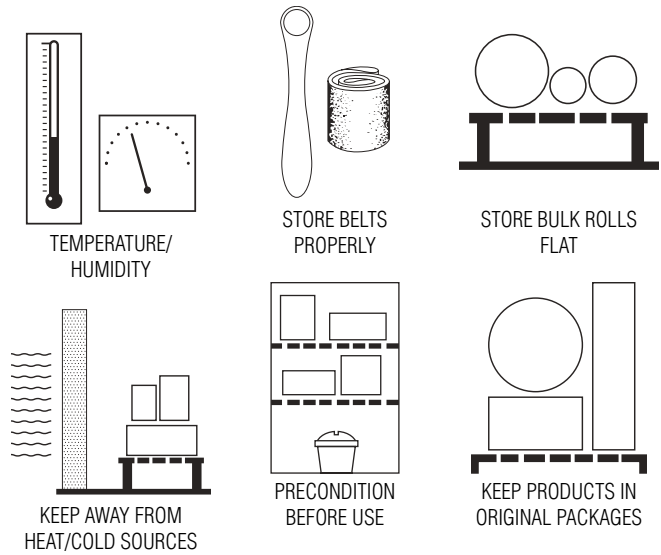

Storage Facilities

The ideal storage (stock) room for coated abrasives would be one in which all the walls are inside partitions, rather than the outside walls of the building.

- Constant levels of humidity and temperature should be maintained. Stockroom temperature should be 60-degrees to 80-degrees F and relative humidity between 35 and 50%.
- Cartons should be kept away from damp or cold walls and floors, where they might absorb moisture.
- Store coated abrasives away from heat sources – steam heated radiators, steam pipes, hot air inlets, heat ducts, or rooms near furnaces or ovens.
- Keep products in original packages. These packages facilitate handling and can be stacked in the most practical and convenient manner.
- Bulk rolls should not be allowed to stand on edge after they have been unpacked. Store flat on shelves or pallets.
- Narrow belts which have been removed from the carton should be rolled up and stored on edge on a clean shelf. Belts may be draped over a large cylinder, such as a gallon can, brake drum, or flanged hanger of the type used for a garden hose. Never hang a belt from a nail – the backing will crease and the abrasive belt might crack. Wide belts should be hung over a tube of at least 4" diameter. Center the belt joint over the tube and add a light weight (such as old packaging tubes) to the bottom loop of the belt to aid in removing set. Condition for 24 hours prior to use.
- For maximum product efficiency, precondition coated abrasive products in a chamber of controlled temperature and humidity before use.

Introduction

Most Norton Bear-Text products consist of a non-woven web of nylon fibers impregnated throughout with abrasive grain and bonded with synthetic resins. This design produces a cushioned, three-dimensional material that is extremely pliable and long lasting. The uniform dispersion of abrasive throughout the web provides a continuous supply of new grain as the old grain and fibers wear away during use.

Norton Bear-Text products, with their open mesh construction, are waterproof, washable, resilient, conformable, non-loading, non-conductive, non-metallic and non-rusting. Non-woven wheels are easily pre-formed to conform to special-shaped work pieces.

Since non-woven products are designed for use where stock removal is not required, they begin where other abrasives leave off. The relatively non-aggressive nature of nylon and grit inherent in the material makes it ideal as a finishing tool. While 60 to 80 grits are considered intermediate sizes in other products, they are considered coarse for non-woven items.

Used wet or dry, Norton Bear-Text non-woven products offer the following advantages: controlled cut (with little or no stock removal) allows for increased productivity, consistent, uniform finish, ability to automate operations, minimized smearing and reduced operator training. These advantages make our non-woven products an excellent alternative to bristle brushes, set-up wheels, greaseless compounds and steel wool.

Product Identification System

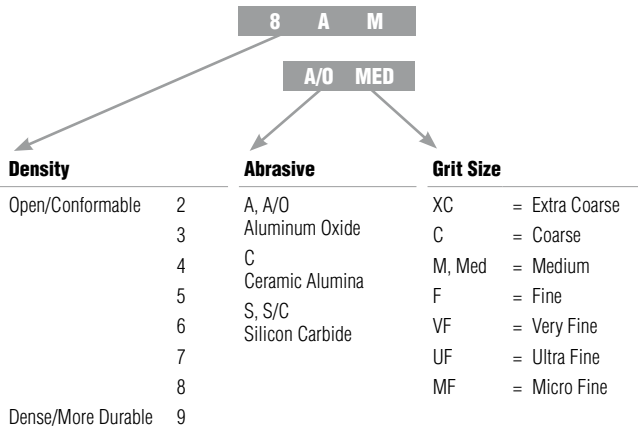

Abrasives

Ceramic alumina, silicon carbide and aluminum oxide abrasives are offered. Ceramic alumina cuts the fastest and is the most cost effective on large-volume applications. Silicon carbide is sharper, cuts faster than aluminum oxide, and produces finer scratch patterns on most surfaces. Aluminum oxide is more durable and tends to last longer. It causes less discoloration on aluminum, and is more aggressive on certain applications such as hardened steel parts. Norton Bear-Text hand pads are also available in a non-abrasive material.

Grits

Grit refers to the size of the abrasive grain impregnated into the nylon web. The coarser the grit, the more aggressive the cut, the rougher the finish. The finer the grit, the less aggressive the cut and the resulting surface finish will be finer, if all other conditions are equal.

GRIT DESIGNATIONS	GRIT SIZE
Extra Coarse (XC)	50
Coarse (C)	60 – 80
Medium (M)	100 – 150
Fine (F)	180 – 220
Very Fine (VF)	240 – 360
Super Fine (SF)	400
Ultra Fine (UF)	600
Micro Fine (MF)	800 – 1200

Densities

The product “density” refers to the number of fibers which have been compressed into the nylon web material. Under identical conditions, harder density wheels cut faster, last longer and produce finer finishes than softer density wheels. Softer density wheels offer greater conformability and have less tendency to load or burn the work piece.

Fiber Sizing

Several nylon fiber sizes are used in the manufacture of Norton Bear-Text and Merit web material because the fiber size is a significant factor in the coating process, as each produces distinct cutting characteristics.

Bonding Agents

Waterproof resins are used in the manufacture of Norton Bear-Text and Merit web material to bond the nylon fibers together and to firmly anchor the abrasive grains throughout the web.

Conventional Finishing Methods Versus Norton Bear-Text Non-Woven Products

The following chart outlines the advantages achievable when using our products as alternatives to other cleaning, blending, deburring and finishing methods. These products are listed in the sequence of normal preference for the application stated. However, because of the numerous variables, only testing can ensure selection of the most cost-effective product.

CONVENTIONAL FINISHING METHOD	KEY APPLICATION	NORTON/MERIT PRODUCT ALTERNATIVES	ADVANTAGES OF NORTON/MERIT PRODUCT VERSUS ALTERNATE FINISHING METHODS
Bristle Brushes	Cleaning	Rapid Strip, Convolute Wheels, and Rapid Prep Discs	Superior cleaning performance Higher productivity No slurry or compound required More consistent finish Eliminate compound dust
Greaseless Compounds	Finishing	Flap Wheels Convolute Wheels Unified Wheels Rapid Prep Discs	Reduced maintenance No compound, instant set-up Elimination of compound dust More uniform finish More consistent work rate
Set-up Wheels	Blending/ Deburring	Convolute Wheels Unified Wheels XHD Discs Rapid Prep Discs	No break-in time required More consistent cut More uniform finish Maintain geometry Safer, no flying wheel pieces
Steel Wool	Cleaning	Rolls Discs Hand Pads	Faster, longer life Less pressure required Non-rusting, cleaner Safer, no splinters

Getting the Most Out of Norton Bear-Tex Wheels

Maximum wheel life and best surface conditioning results can be achieved by closely adhering to the following recommendations.

1) Wheel Direction

Convolute, interleaf flap wheels, and conventional flap wheels must always run in the direction indicated by the arrow printed on the side of each wheel. Unified wheels can be run in either direction.

2) Wheel Speed

Wheel speed is an important factor in that it affects product finish, rate of cut, and wheel life. In general, fast wheel speeds give harder action and a finer finish; whereas, slower speeds give a softer action and a coarser finish for the same wheel density.

The following are recommended operating speeds for the most common applications.

APPLICATION	RECOMMENDED SPEED
Cleaning and upgrading of surface conditions	2200 to 6000 SFPM
Cut-buffing on metal surfaces	6500 to 8000 SFPM
Deburring	5500 to 8000 SFPM
Decorative finishing	500 to 3000 SFPM
Imparting decorative finishes	900 to 3000 SFPM
Oxide removal	3500 to 6500 SFPM

Testing might show that a slower or faster speed is desirable for specific operations. Never exceed the maximum RPM rating of the wheel.

3) Pressure

Light to medium pressure is recommended for most operations. Flap wheels require much lighter pressure to perform properly than other non-woven wheels; unified wheels can withstand much higher pressures in order to perform deburring jobs. In all cases, avoid excessive pressure which might result in wheel deformation and damage to the work surface.

4) Feed Speed

Low feed speed reduces the number of workpieces completed, while producing a shorter scratch pattern. Slow feed speed allows for longer dwell time and permits more work to be done on each piece. Conversely, a fast feed speed increases the number of workpieces completed, while producing a longer scratch pattern.

5) Oscillation

Oscillation may be used to break up scratch lines and produce a more uniform finish. Additionally, an increase in cut might be experienced.

A general starting point for oscillation is 3/8" amplitude at 200 cycles per minute.

6) Lubricants

Lubricants, such as water, water soluble oil, and straight oil, will decrease the heat generated while running, improve the luster, and reduce the surface finish. The higher the viscosity of the lubricant, the lower the surface finish (RMS value) produced.

Factors in Wheel Choice

This chart provides a relative comparison of other Norton Bear-Tex wheel variables. It can serve as a useful guide in choosing the most suitable product for a given application. However, as many other factors affect wheel performance, this chart can only be general in nature. The most cost-effective results can always be obtained by wheel testing on the application.

Factor	Direction	Product/Action
1 Wheel Conformability	MOST CONFORMABLE (SOFT) ←	Flap Wheels, Clean & Finish, Metal Finishing
	→ LEAST CONFORMABLE (HARD)	Rapid Finish GP 7 Density, Rapid Finish GP 8 & 9 Density, Series 4000
2 Wheel Openness	← OPEN MESH	Clean & Finish, Metal Finishing
	→ CLOSED MESH	Rapid Finish GP 7 Density, Rapid Finish GP 8 & 9 Density, Series 4000
3 Wheel Aggressiveness	MOST AGGRESSIVE ←	Metal Finishing
	→ LEAST AGGRESSIVE	Clean & Finish, Rapid Finish GP, Flap Wheels
4 Finishing Action	← COARSER	Metal Finishing, Clean & Finish, Series 4000
	→ FINER	Rapid Finish GP Series 4000, Flap Wheels
5 Pressure for Best Results	LIGHTER ←	Flap Wheels, Clean & Finish
	→ HIGHER	Metal Finishing Rapid Finish GP 7 Density, Rapid Finish GP 8 & 9 Density, Series 4000

* On steel surfaces, silicon carbide wheels will produce a brighter finish than aluminum oxide wheels.

Surface Finish Variables

Changes in any one of many factors can affect the surface finish on the work piece. This chart shows the effect on surface finish by changes in single factors of product specifications. Arrows have been used to signify the trend direction. The arrow length does not signify that the effect of each factor is equal.

Variable Factor	Rough Finish High RMS Reading	Smooth Surface Lower RMS Reading
1 Grit Size	Coarse ←	→ Very Fine
2 Wheel Grade	Soft ←	→ Hard
3 Wheel Speed	Slow ←	→ Fast
4 Feed Speed	Faster (Long Scratch) ←	→ Slower (Short Scratch)
5 Oscillation	No Oscillation ←	→ Oscillation
6 Lubricants and Compounds	Dry ←	→ Straight Oil
	Water ←	→ Soluble Oil
	←	→ Compounds



The strongest of coated abrasive discs with resin-over-resin construction on heavy-duty fiber backing. Designed for applications ranging from heavy stock removal to surface blending. Used with back-up pads on portable angle grinders.

- Applications:** Stock removal, edge chamfering, weld blending, deburring/deflashing, rust removal, cleaning and finishing
- Size Range:** 4" x 5/8" hole, 4-1/2" – 9-1/8" x 7/8" and 5/8"-11 hole
- Grit Range:** 16 – 120
- Abrasive Grain:** Ceramic Alumina, Zirconia Alumina Blend, and Aluminum Oxide
- Product Options:** Conventional, Speed-Change hubs (5/8"-11), and AVOS technology
- Accessories:** Air-cooled, smooth-faced, and AVOS back-up pads
- Machines Used:**

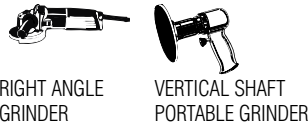

Material-to-Product Recommendation Guide

	BEST		BETTER		GOOD
	BlazeX F970	Blaze F980	BlueFire F826P	Gemini F726	Metal F240
Stainless Steel / Titanium / Super Alloys*		◆	◆	◆	◆
Mild Carbon Steel / Welds	◆		◆	◆	◆
Ferrous Metals / Cast Iron	◆		◆	◆	◆
Brass / Bronze / Aluminum				◆	◆

*Nickel/Cobalt Based – Hastelloy, Inconel, Waspalloy



Application/Grit Recommendation Guide

COARSER (GRINDING) ←										FINER (FINISHING) →									
16	24	30	36	40	50	60	80	100	120	16	24	30	36	40	50	60	80	100	120
Stock Removal				Edge Chamfering						Weld Blending									
Deburring/Deflashing						Rust Removal				Cleaning and Finishing									

Cross Reference Guide

	TOTAL PERFORMANCE ←				INITIAL PRICE →	
	BEST		BETTER		GOOD	
NORTON	BlazeX F970	Blaze F980	BlueFire F826P	Gemini F726	Metal F240	
3M	782C, 982C, 988C	785C, 787C, 985C, 987C	501C	381C	—	
Camel	—	Ceramic	Zirconia	A/O	—	
Flexovit	CG	CG+	ZA	A	—	
GemTex	PMD, Gem Supreme	PMD Supreme, PMD Supreme Plus	Zee-Type, Zee Supreme, Gem Supreme	C-Type	A-Type	
Hermes	—	CR456	RB414X, RB414X Procut	RB514J	RB314	
Klingspor	FS964 ACT	FS966	CS565, CS570	FS764 ACT	CS561	
Metabo	CER	CER	ZA	—	A/O	
Mirka	—	—	Blue, Gold	—	Red	
Pearl	Red Line	—	FZ	Premium A/O	Silver Line	
Pferd	CO-PMD	CO Cool	Z, Z Cool	A Cool	A	
United Abrasives/Sait	7S, 7A-S, 7-11	9S, 9-11	3Z, Z, AZX	3A	A/O, 2A	
SIA	4515, 4580	4515, 4560,	4815, 4819	4924	4919, 4961	
Standard	Ceramic	Ceramic Pro	Zirconia	—	A/O	
VSM	XF760	AF890, AF799, XF885, XF870, XF850	ZF713, ZF714, ZF844	KF808	KF708	
Walter	Walter Coolcut XX	Walter Coolcut XX	Walter Topcut	Walter Coolcut	—	
Weiler	—	Tiger Ceramic	Tiger Zirc, Wolverine Zirc	Tiger A/O	Wolverine A/O	



Best choice for carbon steel and other soft-to-grind materials

BLAZEX F970 CERAMIC ALUMINA

- Improved ceramic alumina micro-fracturing grain constantly exposes sharper grain edges to significantly increase cut rate and life over competitive blended/low-ratio ceramic alumina discs
- Heavier fiber backing for additional strength and tear resistance
- Non-supersized design for cool cutting and long life on carbon steel and other soft-to-grind materials



Best choice for stainless steel, titanium, and super alloys

BLAZE F980 CERAMIC ALUMINA

- 100% ceramic alumina micro-fracturing grain constantly exposes sharper grain edges to significantly increase cut rate and life over competitive blended/low-ratio ceramic alumina discs
- Self-lubricating grinding aid treatment delivers the coolest cut on stainless steel, high alloy steels, super alloys, titanium, and other difficult to grind materials
- Heavier fiber backing for additional strength and tear resistance



Better choice for stainless, super alloys, steel, cast iron and high-pressure applications

BLUEFIRE F826P ZIRCONIA ALUMINA

- High-performance zirconia alumina abrasive blend provides 15% faster cut and longer life with less power draw than conventional zirconia discs
- Advanced resin bond technology with enhanced grain adhesion for extended life
- Heavier fiber backing for additional strength and tear resistance



Good choice for carbon steel and aluminum applications

GEMINI F726 ALUMINUM OXIDE

- Premium aluminum oxide blend for aggressive cut and longer life than competitive aluminum oxide discs
- Full resin bond for strength and durability
- Heavier fiber backing for additional strength and tear resistance



Good choice for small jobs, applications where performance is not measured, and price-sensitive operations

METAL F240 ALUMINUM OXIDE

- Versatile, multi-purpose aluminum oxide abrasive provides consistent performance on numerous materials and small jobs
- Full resin bond for strength and durability
- Heavier fiber backing for additional strength and tear resistance; low initial price

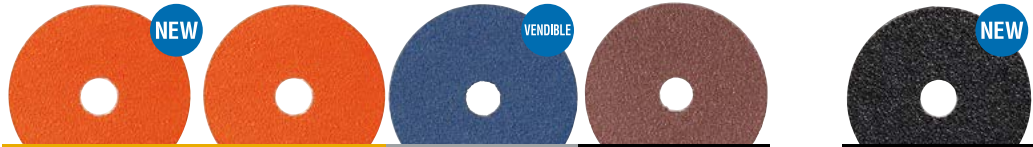

TIER:	BEST	BEST	BETTER	GOOD	GOOD
TRADENAME:	BLAZEX F970	BLAZE F980	BLUEFIRE F826P	METAL F240	GEMINI F726
ABRASIVE:	Ceramic Alumina	Ceramic Alumina	Zirconia Alumina Blend	Aluminum Oxide	Aluminum Oxide
OTHER:		Supersize			

SIZE (D x H)	GRIT	STD. PKG.	PART #	PART #	PART #	PART #	STD. PKG.	PART #
4 x 5/8	24	25				055395 10595	10	666233 95000
	36	25				055395 10594	10	666233 95001
	50	25					10	666233 95002
	60	25				055395 10592		
	80						10	666233 95004
4-1/2 x 7/8	24	25		699573 98000	662611 38457	666233 53309	10	666233 95007
	36	25	699573 70193	699573 98001	662611 38456	666233 53306	10	666233 95008
	36	50 V			666233 77276			
	50	25	699573 70194	699573 98002	662611 38454	666233 53310	10	666233 95009
	60	25	699573 70195	699573 98003	662611 38453	666233 53311	10	666233 95010
	60	50 V			666233 77278			
	80	25	699573 70196	699573 98004	662611 38452	666233 53312	10	666233 95011
	80	50 V			666233 77279			
	100	25				666233 53313	10	666233 95012
	120	25		662544 25332		666233 53314	10	666233 95013
5 x 7/8	16	25				055395 10684		
	24	25		699573 98005	662611 38563	666233 57276	10	666233 95016
	36	25	699573 70197	699573 98006	662611 38562	666233 57277	10	666233 95017
	36	50 V			666233 77283			
	50	25	699573 70198	699573 98007	662611 38561	666233 57278	10	666233 95018
	60	25	699573 70199	699573 98008	662611 38601	666233 57279	10	666233 95019
	80	25	699573 70200	699573 98009	662611 38600	666233 57280	10	666233 95020
	100	25				666233 57281	10	666233 95021
120	25		662544 09084		666233 57282	10	666233 95022	
6 x 7/8	24	25		662611 60033				
	36	25		662611 60034				
	50	25		662611 60035				
	80	25		662611 60037				
	100	25						
7 x 7/8	16	25				055395 10693		
	24	25		699573 98010	662611 38594	666233 57283	10	666233 95029
	36	25	699573 70201	699573 98011	662611 38593	666233 57284	10	666233 95030
	36	50 V			666233 77287			
	50	25	699573 70202	699573 98012	662611 38592	666233 57285	10	666233 95031
	60	25	699573 70203	699573 98013	662611 38591	666233 57286	10	666233 95032
	80	25	699573 70204	699573 98014	662611 38590	666233 57287	10	666233 95033
	100	25				666233 57288	10	666233 95034
	120	25		662544 11528		666233 57289	10	666233 95035
	9-1/8 x 7/8	24	25		699573 98015	662611 38584	055395 10702	10
	36	25		699573 98016	662611 38583	055395 10701	10	666233 95037
	50	25		699573 98017	662611 38582		10	666233 95038
	60	25				055395 10699	10	666233 95039
	80						10	666233 95040
	100						10	666233 95041
	120						10	666233 95042

Note: Fiber discs must be used with back-up pads shown on the last page of this section.
V = Vendible Package. Ideal for vending machines and small jobs. 10 discs/package.

Speed-Change Fiber Discs

These fiber discs feature Norton quick, tool-free, twist-on and -off Speed-Change fasteners. Discs lock to standard back-up pads with a unique nut design and are easily removed, increasing your productivity with more time to grind.

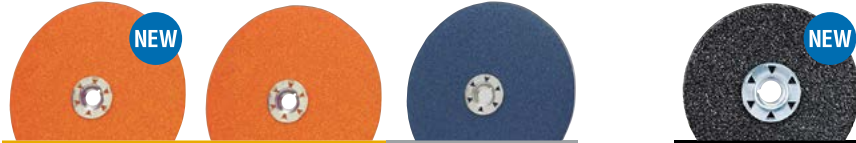

TIER:	BEST	BEST	BETTER	GOOD
TRADENAME:	BLAZEX F970	BLAZE F980	BLUEFIRE F826P	GEMINI F726
ABRASIVE:	Ceramic Alumina	Ceramic Alumina	Zirconia Alumina Blend	Aluminum Oxide
OTHER:		Supersize		

SIZE (D x H)	GRIT	STD. PKG.	PART #	PART #	PART #	STD. PKG.	PART #
4-1/2 x 5/8-11	24	25		662610 23269		10	776960 09702
	36	25	699573 70205	662611 85294		10	776960 09703
	50	25	699573 70206			10	776960 09704
	60	25	699573 70207	662610 42247			
	80	25	699573 70208	666233 28529		10	776960 09715
5 x 5/8-11	24	25		662544 25336	662611 38797		
	36	25	699573 70209	662611 85801	662611 38796	10	666233 95014
	50	25	699573 70210				
	60	25	699573 70211	662611 85803		10	666233 95015
	80	25	699573 70212	666233 16697		10	776960 09728
7 x 5/8-11	24	25		699573 49782	662611 38819	10	666233 95023
	36	25	699573 70213	662610 29863	662611 38818	10	666233 95024
	50	25	699573 70214		662611 38817	10	666233 95025
	60	25	699573 70215	662610 42249	662611 38816		
	80	25	699573 70216	662544 74373		10	666233 95026
	100					10	666233 95027
	120					10	666233 95028

Note: Speed Change fiber discs must always be used with smooth face back-up pads, see next page for details.

Blaze Fiber Disc Test Kits NEW

- Each kit contains one box of 25 BlazeX F970 (36 grit) fiber discs and one box of 25 Blaze F980 (36 grit) fiber discs. Test them for yourself!



TIER:	BEST
TRADENAME:	BLAZEX F970 & BLAZE F980 TEST KITS
ABRASIVE:	Ceramic Alumina

SIZE	GRIT	STD. PKG.	PART #
4-1/2	36	1	776960 95018
5	36	1	776960 95019
7	36	1	776960 95020

AVOS Fiber Discs

- Patented, see-through design allows interrupted cut which reduces heat up to 30% over standard discs
- The scooped holes create air flow to pull swarf away from grinding zone; cool cutting and extended product life
- 15° back-up pad for full utilization of discs – no gouging
- Quick, tool-free, twist-on and -off Speed-Lok fasteners

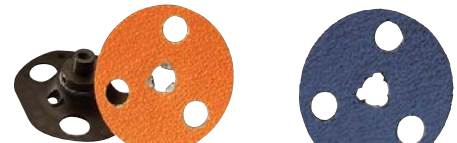

TIER:	BEST	BETTER
BRAND:	Norton	Norton
TRADENAME:	BLAZE F980	BLUEFIRE F826P
ABRASIVE:	Ceramic Alumina	Zirconia Alumina Blend

SIZE	GRIT	STD. PKG.	PART #	PART #
4-1/2 Speed-Lok (3 hole)	24	10	662544 68389	662611 29718
	36	10	662544 68390	662611 29719
	50	10	662544 68391	662611 29720
	60	10	662544 68392	662611 29721
5 Speed-Lok (3 hole)	80	10	662544 68393	662611 29722
	24	10	662544 68385	662611 26556
	36	10	662544 68386	662611 26557
	50	10	662544 68387	662611 26558
7 Speed-Lok (6 hole)	60	10	662544 68388	662611 26559
	80	10		662611 26560
	24	10	662544 68381	662611 37454
	36	10	662544 68382	662611 37455
	50	10	662544 68383	662611 37456
	60	10	662544 68384	
	80	10		662611 37458

Note: AVOS fiber discs must be used with AVOS Speed-Lok back-up pads, see next page for details.



Fiber Disc Accessories



Fiber Disc Baling Unit

- Places 100 discs on a spindle between two plates
- Locks down with a pinch screw
- Maintains the shape of the discs by maintaining pressure to minimize curl
- User-friendly and reusable



Air-Cooled Standard Back-up Pad

Slotted hub design and curved ribs draw heat away from the grinding zone, reducing disc loading and increasing life. All pads have a 5/8"-11 threaded female hub for mounting. We also offer a no-nose pad for shorter-shafted right angle grinders.



Smooth Face Speed-Change Back-up Pad

Molded rubber back-up pads with a smooth face.

- Hard density pads are for aggressive cutting action
- Medium density pads are for all-purpose applications



AVOS Fiber Disc Back-up Pad

- Patented, see-through design allows interrupted cut which reduces heat up to 30% over standard discs
- The scooped holes create air flow to pull swarf away from grinding zone
- 15° back-up pad for full utilization of discs – no gouging
- Quick, tool-free, twist-on and -off Speed-Lok fasteners

DESCRIPTION	MAX. RPM	STD. PKG.	PART #
Fiber Disc Baling Unit			
5"	—	1	776960 01065
7"	—	1	776960 01066
Rubber Back-up Pads			
Air-Cooled Standard for 7/8 Hole Fiber and Non-Woven Discs			
4" Medium	12,000	5	636425 04918
4-1/2" Medium	11,000	5	636425 02122
5" Medium	10,000	5	636425 43421
7" Hard	8,600	5	636425 43425
7" Medium	8,600	5	636425 43422
9" Hard	6,600	5	636425 43426
9" Medium	6,600	5	636425 43423
<i>Note: Retainer nuts are not included with back-up pads. These must be ordered separately.</i>			
Air-Cooled No-Nose			
4-1/2" Medium	11,000	5	636425 04872
5" Medium	10,000	5	636425 03000
Smooth Face for Fiber and Non-Woven Speed-Change Discs			
4-1/2" Medium	20,000	5	662544 92277
5" Medium	12,000	5	636425 43235
7" Hard	8,600	5	636425 43240
7" Medium	8,600	5	636425 43245
7" Soft	8,600	5	636425 43250
9" Medium	7,000	5	636425 43270
AVOS Speed-Lok Back-up Pads			
AVOS Triangular Speed-Lok Back-up Pads			
4-1/2" x 5/8-11	13,000	5	636425 02985
5" x 3/8-24 Pistol Grip*	20,000	5	636425 03029
5" x 5/8-11	13,000	5	636425 02517
5" x 5/8-11 Thicker	13,000	5	636425 03663
5" x 7/16-20 Pistol Grip*	20,000	5	636425 03030
<i>*Use on air pneumatic and high-speed pistol grip sanders</i>			
AVOS Round Speed-Lok Back-up Pads			
7" x 5/8-11 Hard	8,600	5	636425 04873
Tools			
#103 Retainer Nut	—	10	636425 43463
Spanner Wrench	—	5	636425 43005
66NS Short Retainer Nut	—	10	636425 43461

All fiber disc back-up pads are packed in individual boxes within the shipping carton. Each box can be used in a vending machine.



Corner Store Convenience – Right on the Floor

Industry's best selection of vendible abrasive solutions

See the many popular products conveniently pre-packed in small quantity packages

- Perfect for vending machines, pegboards, new test orders, small orders and jobs, and carrying cleanly to job site
- Available in fiber, flap, paper, and quick-change discs, belts, hand pads, depressed center, cut-off and bench wheels, mounted points, cones and plugs, and sharpening stones



Flap discs are versatile grinding and finishing tools having four main components: abrasive flaps, flap density (how the flaps are stacked), backing plate shape (flat or conical), backing plate material (fiberglass or plastic). All flap discs have flaps that are overlapped and glued to the backing plate. The flaps wear during use, exposing new abrasive grain. The different variations of the components above provide a variety of application choices ranging from heavy stock removal to blending to finishing. Flap discs are designed for portable grinder applications and can be the preferred choice over depressed center wheels or fiber discs.

- Applications:** Grinding, stock removal, edge chamfering/beveling, weld blending, deburring/deflashing, rust removal, blending, cleaning and finishing
- Size Range:** 4" : 5/8" hole
4-1/2" - 7" : 5/8"-11 discard mount, 7/8" hole, and 2" - 3" quick-change
- Grit Range:** 24 - 120
- Abrasive Grain:** Ceramic Alumina, Zirconia Alumina, and Aluminum Oxide
- Abrasive Flaps:** Polyester, Cotton/Poly Blend
- Flap Disc Shape:** Type 27 Flat and Type 29 Conical
- Abrasive Flap Density:** Standard or high
- Backing Plate Material:** Fiberglass and plastic
- Machine Used:**  RIGHT ANGLE GRINDER

Flap Disc Shapes



Type 27 Flat – The Best Choice for Finishing

- Used primarily on flat surfaces
- The best choice for blending and smooth finishing

GRIND AT FLATTER ANGLES:
0° – 15°

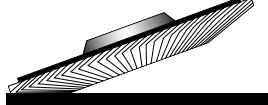

Type 29 Conical – The Best Choice for Aggressive Stock Removal

- Conical flap discs have angled flaps and may be used on both contoured and edge work
- The angle provides greater surface contact for stock removal on flat surfaces
- The best choice when speed and stock removal are primary considerations

GRIND AT STEEPER ANGLES:
15° – 25°

Abrasive Flap Densities



Standard Density

- Excellent for heavy-duty applications and rapid stock removal



High Density

- Ideal when working on uneven or curved surfaces, as well as finer grit blending

Backing Plate Materials

All flap discs are a combination of abrasive flaps adhered to a rigid backing plate. It is the backing plate that provides stability during operation. There are two main materials used: fiberglass and plastic. The fiberglass backing plate, along with the flap shape, helps to absorb vibration and is consumed during use with no smearing. Fiberglass is the most popular material because of its high strength and light weight. The plastic backing plate offers some additional conformability and is trimmable.

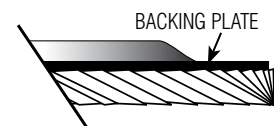

Why Choose Flap Discs?

Flap discs replace both grinding wheels and fiber discs. The same flap disc can be used for applications ranging from stock removal to blending.

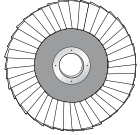

Flap Discs vs. Grinding Wheels

- Faster stock removal
- Smoother finish, no gouging
- Cooler cutting, less glazing
- Lightweight, easier to control
- Less vibration, less operator fatigue
- Reduced noise

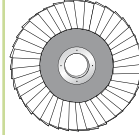
Flap Discs vs. Fiber Discs

- 20X longer life, reduced abrasive cost
- Fewer disc changes, reduced labor cost
- More consistent finish
- No back-up pad required
- Easier storage, no curling
- Reduced loading
- Use flap discs one grit size coarser than fiber discs, except in 36 grit

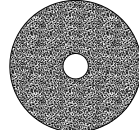

Material-to-Product Recommendation Guide

	BEST Blaze R980P	BETTER BlueFire R884P	GOOD Gemini R766	Metal R828
TYPE 29 FOR STOCK REMOVAL				
Stainless Steel / Titanium / Super Alloys	◆	◆	◆	◆
Mild Carbon Steel / Welds		◆	◆	◆
Ferrous Metals / Cast Iron		◆	◆	◆
Brass / Bronze / Aluminum		◆		
TYPE 27 FOR BLENDING AND FINISHING				
Stainless Steel / Titanium / Super Alloys	◆	◆	◆	◆
Mild Carbon Steel / Welds		◆	◆	◆
Ferrous Metals / Cast Iron		◆	◆	◆
Brass / Bronze / Aluminum		◆	◆	◆

Application/Grit Recommendation Guide

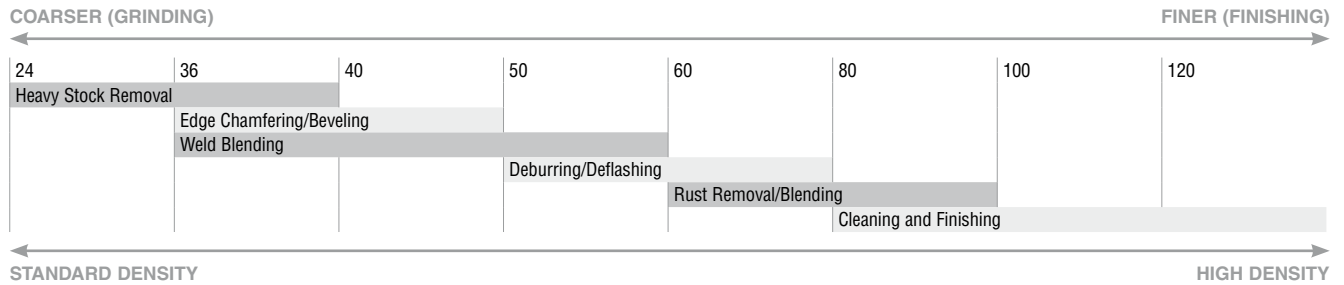

Cross Reference Guide

	TOTAL PERFORMANCE ←		INITIAL PRICE →	
	BEST	BETTER	GOOD	
NORTON	Blaze R980P	BlueFire R884P	Gemini R766	Metal R828
3M	747D, 947D, 967A, 969F	546D, 566A, 577F	—	—
Camel	Ceramic Pro	ZA Pro	A Pro	ZA
CGW/Pasco	Ceramic	Zirconia	A/O	—
DeWalt	XP Ceramic	HP Zirconia	Zirconia	FlexVolt
Flexovit	Zircotex Ceramic	Zircotex, Zirocomax, Tornado	—	—
Garryson	CeramiQ	Zirc+	Zirconium	A/O
GemTex	Ceramic Flaptec	Zirconia Flaptec	A/O Flaptec	—
Hermes	—	FL390	RB48024YX, RB48624YX	Webrax-AN 701
Klingspor	SMT656	SMT624, SMT626, SMT627, SMT630	SMT627	—
Metabo	Flexiamant Super Ceramic	Flexiamant Zirconia, Novoflex	—	—
Mirka	—	—	Blue	—
Pearl	Redline Maxidics, Stainlessmax Maxidics	Zirconia Maxidisc, Silver Line Zirconia	A/O Maxidisc	Silver Line A/O
Pferd	Polifan Z-SG, Polifan SG-CO	Polifan SG Zirkon, Polifan SG ZA, SGP, PSF Zirc	Polifan SG A, A-Cool	Polifan PSF A/O
United Abrasives/Sait	Encore Ceramic, Ovation Ceramic	Ovation, Saitlam U	Ovation Attacker	Encore
SIA	—	—	2824 SIAFlap	—
Standard	Ceramic Pro, Ceramic	Zirconia HP, Zirconia AP	Zirconia GP	—
Tyrolit	Cerabond Ceramic, Premium Ceramic	Fastcut, Premium Longlife	Premium A/O	Basic, Standard
VSM (Lehigh Valley)	Ceramic	Zirconia	A/O	—
Walter	Enduro-Flex Turbo	Enduro-Flex, Enduro-Flex Stainless	Enduro-Flex Alu.	Flexsteel
Weiler	Tiger Ceramic, Tiger X, Tiger Saber Tooth	Tiger Paw, Wolverine	Tiger Premium	Tiger

Best/highest productivity for stainless steel, titanium, and super alloys



BLAZE R980P CERAMIC ALUMINA

- Premium ceramic alumina abrasive grain lasts 50% – 200% longer than many flap discs on stainless steel, cobalt, chrome, inconel, titanium and other hard-to-grind materials
- Y-weight polyester flaps with a supersize grinding aid significantly improve life, grain retention, and fray resistance while providing a cool, noticeably fast cut rate
- High-strength fiberglass back on Type 29 and Type 27 High Density is durable, lightweight, and absorbs vibration; Black, flexible plastic backing plate on Type 27 Quick Trim allows for trimmability of the plate

Better choice for mild carbon steel, and welds



BLUEFIRE R884P ZIRCONIA ALUMINA

- High performance zirconia alumina plus abrasive for aggressive cut and long life, with up to 30% longer life than competitive zirconia alumina products
- Polyester/cotton flaps with semi-open coat provide improved durability and reduces loading on aluminum
- High-strength fiberglass back on Type 29 and Type 27 High Density is durable, lightweight, and absorbs vibration; blue, flexible plastic backing plate on Type 27 Quick Trim allows for trimmability of the plate
- Vendible 2-disc package is ideal for vending machines, small jobs, or carrying to a job site

Good choice for carbon steel and aluminum applications



GEMINI R766 ALUMINUM OXIDE

- Alternating zirconia alumina and aluminum oxide flaps provide higher performance than aluminum oxide while retaining an economical price
- Polyester/cotton flaps are the best choice when speed of job completion and stock removal are primary considerations
- Type 27 Flat with quick trim, flexible plastic backing plate or high-density fiberglass back; Type 29 conical with durable, fiberglass back

Good consistent performance with low initial price



METAL R828 ZIRCONIA ALUMINA

- Durable zirconia grain provide good cut rate and life with consistent finish
- Fiberglass/resin backing plates with high strength, light weight, ability to absorb vibration, and operator comfort
- Good choice for coarse grit blending, deburring, and stock removal



TIER:	BEST	BETTER	GOOD	GOOD	GOOD
TRADENAME:	BLAZE R980P	BLUEFIRE R884P	GEMINI R766	METAL R828	METAL R828
SHAPE:	Type 29 Conical	Type 29 Conical	Type 29 Conical	Type 29 Conical	Type 29 Conical
FLAP DENSITY:	Standard	Standard	Standard	Standard	High
ABRASIVE:	Ceramic Alumina	Zirconia Alumina Plus	Aluminum Oxide	Zirconia Alumina	Zirconia Alumina
BACKING PLATE:	Fiberglass	Fiberglass	Fiberglass	Fiberglass	Fiberglass
OTHER:	Supersize				

SIZE (D x H)	GRIT	MAX. RPM	STD. PKG.	PART #	PART #	PART #	PART #	PART #
Type 29 Conical								
4 x 5/8	36	15,300	10		666233 99049			
	40	15,300	10		666233 99050			
	60	15,300	10		666233 99051			
	80	15,300	10		666233 99052			
4-1/2 x 5/8-11	36	13,300	10	662611 83490	662544 61165	666233 99028	662544 19991	
	36	13,300	10 V		666233 41104 2-Pack			
	40	13,300	10	662611 83491	662544 61167	666233 99029	662544 19994	662611 32535
	60	13,300	10	662611 83492	662544 61170	666233 99030	662544 19996	662611 32536
	60	13,300	10 V		666233 41105 2-Pack			
	80	13,300	10	662611 83493	662544 61173	666233 99173	662544 19997	662611 32537
	80	13,300	10 V		666233 41106 2-Pack			
	120	13,300	10			666233 99174		
4-1/2 x 7/8	24	13,300	10		666233 99204			
	36	13,300	10	662611 83486	662544 61155	666233 99032	662544 19963	
	36	13,300	10 V		666233 41107 2-Pack			
	40	13,300	10	662611 83487	662544 61161	666233 99033	662544 19978	662611 32538
	60	13,300	10	662611 83488	662544 61163	666233 99034	662544 19984	662611 32539
	60	13,300	10 V		666233 41108 2-Pack			
	80	13,300	10	662611 83489	662544 61164	666233 99035	662544 19987	662611 32540
	80	13,300	10 V		666233 41109 2-Pack			
5 x 5/8-11	36	12,000	10		666233 99189			
	40	12,000	10		666233 99190			
	60	12,000	10		666233 99191			
	80	12,000	10		666233 99192	666233 99179		
5 x 7/8	120	12,000	10			666233 99180		
	24	12,000	10		666233 99206			
	36	12,000	10	662611 90001	662544 61174	666233 99036	662544 19998	
	40	12,000	10	662611 90002	662544 61176	666233 99037	662544 20001	
	60	12,000	10	662611 90003	662544 61177	666233 99038	662544 20002	
	80	12,000	10	662611 90004	662544 61178	666233 99039	662544 20003	
	120	12,000	10			666233 99181		
6 x 5/8-11	40	10,200	10			666233 99040	662544 91779	
	60	10,200	10			666233 99041	662544 91780	
	80	10,200	10			666233 99042	662544 91781	
6 x 7/8	24	10,200	10		666233 99066			
	36	10,200	10		666233 99298			
	40	10,200	10		666233 99193	666233 99182	662544 91776	
	60	10,200	10		666233 99194	666233 99183	662544 91777	
	80	10,200	10		666233 99195	666233 99184	662544 91778	
7 x 5/8-11	36	8,600	10	662611 83498	662544 61188	666233 99185	662544 20009	
	40	8,600	10	662611 83499	662544 61190	666233 99043	662544 20010	
	60	8,600	10	662611 83500	662544 61192	666233 99044	662544 20012	
	80	8,600	10	662611 83501	662544 61193	666233 99045	662544 20013	
	120	8,600	10			666233 99186		
7 x 7/8	24	8,600	10		666233 99196			
	36	8,600	10	662611 83494	662544 61180		662544 20004	
	40	8,600	10	662611 83495	662544 61183	666233 99046	662544 20006	
	60	8,600	10	662611 83496	662544 61185		662544 20007	
80	8,600	10	662611 83497	662544 61186				

V = Vendible package. 2 discs/pack; 5 packs/carton. Order in multiples of 10.

See Portable Tools and Specialties section for mini flap discs.



TIER:	BEST	BEST	BETTER	BETTER	GOOD	GOOD	GOOD
TRADENAME:	BLAZE R980P	BLAZE R980P	BLUEFIRE R884P	BLUEFIRE R884P	GEMINI R766	GEMINI R766	METAL R828
SHAPE:	Type 27 Flat	Type 27 Flat	Type 27 Flat	Type 27 Flat	Type 27 Flat	Type 27 Flat	Type 27 Flat
FLAP DENSITY:	Standard	High	Standard	High	Standard	Standard	Standard
ABRASIVE:	Ceramic Alumina	Ceramic Alumina	Zirconia Alumina Plus	Zirconia Alumina Plus	Aluminum Oxide	Aluminum Oxide	Zirconia Alumina
BACKING PLATE:	Quick Trim Plastic	Fiberglass	Quick Trim Plastic	Fiberglass	Quick Trim Plastic	Fiberglass	Fiberglass
OTHER:	Supersize	Supersize					

SIZE (D x H)	GRIT	MAX. RPM	STD. PKG.	PART #	PART #	PART #	PART #	PART #	PART #		
Type 27 Flat											
4-1/2 x 5/8-11	36	13,300	10		662544 99894	666233 99136		666233 99125	666233 99205	662544 72655	
	36	13,300	10 V			666233 41086	2-Pk				
	40	13,300	10	662544 00257	662610 98290	666233 99137	776960 90086	666233 99000	666233 99059	662544 37013	
	60	13,300	10	662544 00258	662610 96435	666233 99138	776960 90087	666233 99001	666233 99060	662544 72656	
	60	13,300	10 V			666233 41087	2-Pk				
	80	13,300	10	662544 00259	662610 96436	666233 99139	776960 90088	666233 99002	666233 99061	662544 72657	
4-1/2 x 7/8	36	13,300	10	636425 01865	662610 97678	666233 99140	776960 90081	666233 99126	666233 99062	662544 72653	
	40	13,300	10	662544 00253	662610 20628	666233 99141	776960 90082	666233 99004	666233 99063	662544 37004	
	60	13,300	10	662544 00254	662610 20633	666233 99142	776960 90083	666233 99005	666233 99064	662544 48989	
	80	13,300	10	662544 00255	662610 20634	666233 99143	776960 90084	666233 99006	666233 99065	662544 48990	
	120	13,300	10	662544 00256			776960 90085	666233 99007			
	5 x 5/8-11	36	12,000	10			666233 99144		666233 99127		
40		12,000	10	776960 90141		666233 99145		666233 99128	666233 99208		
60		12,000	10	776960 90142		666233 99146		666233 99130	666233 99209		
80		12,000	10	776960 90143		666233 99147		666233 99131	666233 99210		
120		12,000	10					666233 99132			
5 x 7/8		36	12,000	10			666233 99148		666233 99133	666233 99211	
	40	12,000	10	662544 00262		666233 99149		666233 99008	666233 99212	662544 72660	
	60	12,000	10	662544 00264		666233 99150		666233 99009	666233 99213	662544 72661	
	80	12,000	10	662544 00265		666233 99151		666233 99010	666233 99214	662544 72662	
	120	12,000	10	662544 00519				666233 99011			
	6 x 5/8-11	40	10,200	10	662611 32128	662611 32145				666233 99219	662544 91773
60		10,200	10	662611 32129	662611 32146				666233 99220	662544 91774	
80		10,200	10	662611 32130	662611 32147				666233 99221	662544 91775	
6 x 7/8		36	10,200	10						666233 99215	
		40	10,200	10	662611 32123		666233 99152		666233 99012	666233 99216	662544 91770
		60	10,200	10	662611 32124	662611 32136	666233 99153		666233 99013	666233 99217	662544 91771
	80	10,200	10	662611 32125		666233 99154		666233 99014	666233 99218		
120	10,200	10					666233 99015				
7 x 5/8-11	36	8,600	10			666233 99155		666233 99134	666233 99222	662544 72669	
	40	8,600	10	662544 61066	662611 32148	666233 99156	776960 90092	666233 99016	666233 99067	662544 72670	
	60	8,600	10	662544 61067	662611 32168	666233 99157	776960 90093	666233 99017	666233 99068	662544 72671	
	80	8,600	10	662544 61068		666233 99158	776960 90094	666233 99018	666233 99069	662544 72672	
	120	8,600	10	662544 61069				666233 99019			
	7 x 7/8	36	8,600	10	636425 01866		666233 99159		666233 99135	666233 99070	
40		8,600	10	662544 61059	662611 32138	666233 99160	776960 90089	666233 99020	666233 99071	662544 72665	
60		8,600	10	662544 61060	662611 32139	666233 99161	776960 90090	666233 99021		662544 72666	
80		8,600	10	662544 61061		666233 99162	776960 90091	666233 99022		662544 72667	
120		8,600	10	662544 61063				666233 99023			

V = Vendible package. Ideal for vending machines & small jobs. 2 Flap Discs/pack, 5 packs/carton. Order in multiples of 10.

See Portable Tools and Specialties section for mini flap discs.

Packaged for retail / walk-in selling / small jobs



BLUEFIRE R884P ZIRCONIA ALUMINA

- Zirconia alumina plus abrasive for aggressive cut and long life
- Individual hang cards provides product selling points; ships in merchandise display case of small quantities
- Available wire rack (with header card) allows merchandising of 4" and 4-1/2" product three ways: hung on pegboard, mounted on an upright, or placed on a shelf/counter



WIRE RACK (WITH HEADER CARD)
ALLOWS MERCHANDISING OF 4"
AND 4-1/2" PRODUCT THREE WAYS:
HUNG ON PEGBOARD, MOUNTED ON
AN UPRIGHT, OR PLACED ON A
SHELF/COUNTER

TIER: **BETTER**
TRADENAME: **BLUEFIRE R884P**
SHAPE: Type 29
FLAP DENSITY: Standard
ABRASIVE: Zirconia Alumina Plus
BACKING PLATE: Fiberglass

SIZE (D x H)	GRIT	MAX. RPM	STD. PKG.	PART #
4 x M-10	40	15,300	5	076607 03214
	60	15,300	5	076607 03215
	80	15,300	5	076607 03216
4-1/2 x 5/8-11	40	13,300	5	076607 03211
	60	13,300	5	076607 03212
	80	13,300	5	076607 03213
7 x 5/8-11	40	8,600	5	076607 03205
	60	8,600	5	076607 03206
	80	8,600	5	076607 03207
Wire Rack			2	076607 04157



See Portable Tools and Specialties section for mini flap discs.



Non-woven depressed center discs have three components: strong synthetic fiber mesh and quality abrasives, bonded together by a smear-resistant adhesive. Rapid Strip discs have an open web construction that enables aggressive cutting action while maintaining a cool, non-loading surface. Rapid Blend discs have a unitized construction with varying weave – from open to tighter – for deburring and finishing. Rapid Prep discs have a more open weave that excels in surface preparation and cleaning. Each product provides excellent cutting action while improving surface finish.

Applications:

Medium-to-light material removal, deburring, blending, cleaning, finishing, and polishing

Size Range:

4-1/2" - 7"

Grit Range:

X-Coarse, Coarse, Medium, Fine, Very Fine

Abrasive Grain:

Ceramic Alumina, Silicon Carbide, Engineered Aluminum Oxide, Aluminum Oxide

Machine Used:



RIGHT ANGLE GRINDER



VERTICAL SHAFT PORTABLE GRINDER

Material/Application-To-Product Recommendation Guide – For All Discs Used on Right Angle Grinders

Stripping Discs

	BEST	BETTER
	Blaze Rapid Strip Ceramic	Rapid Strip Silicon Carbide
Removing scale and coarse welding marks	◆ XC	◆ XC
Removing coatings, epoxy/glue, paint and other clogging material	◆ XC	◆ XC
Removing rust, oxidation, corrosion and residue	◆ XC	◆ XC
Removing parting lines and seams on fiberglass parts	◆ XC	◆ XC
Removing paint/graffiti from concrete/stone	◆ XC	◆ XC

Deburring, Blending, Finishing Discs

	BEST	BETTER
	Vortex Rapid Blend	Rapid Blend Rapid Prep
Removing weld marks and weld spatter	◆ C	◆ C
Stainless steel deburring and cleaning	◆ C	◆ C
Removing small flashings and parting lines	◆ C	◆ C
Surface preparation before coatings/plating		◆ C
Light cleaning		◆ F
Cleaning and prepping welds		◆ M
Removing blemishes after welding stainless		◆ M
Blending and finishing all metal parts	◆ VF	◆ VF
Creating decorative finishes on stainless steel	◆ VF	◆ VF
Final finishing and polishing	◆ VF	◆ VF
Final finishing/polishing where high conformability is needed		◆ VF

XC - Extra Course, C - Coarse, M - Medium, F - Fine, VF - Very Fine

Application/Product Recommendation Guide – For All Discs Used on Right Angle Grinders

MOST AGGRESSIVE / LEAST CONFORMABLE

LEAST AGGRESSIVE / MOST CONFORMABLE

	Blaze Rapid Strip	Vortex Rapid Blend A/O Med. Rapid Blend A/O Coarse	Rapid Blend A/O Medium	Rapid Blend S/C Fine	
Discs With Back-Up Pad		Vortex Rapid Prep Rapid Prep A/O Coarse	Rapid Prep A/O Medium	Rapid Prep A/O Fine	Rapid Prep Very Fine
Scale Removal	Best Choice	Second Choice			
Stock Removal	Best Choice	Best Choice			
Heavy Deburring	Second Choice	Best Choice			
Light Deburring		Best Choice	Second Choice		
Light Finishing		Second Choice	Best Choice		
Blending			Best Choice	Second Choice	
Finishing			Second Choice	Best Choice	
Polishing				Best Choice	Second Choice

Cross Reference Guide – For All Discs Used on Right Angle Grinders

	STRIPPING (EXTRA COARSE)		SURFACE FINISHING (COARSE – MEDIUM – FINE)		SURFACE PREP (VERY FINE)	
	BEST	BETTER	BEST	BETTER	BEST	BETTER
NORTON	Blaze Rapid Strip	Rapid Strip	Vortex Rapid Blend	Rapid Blend	Vortex Rapid Prep	Rapid Prep
3M	Clean & Strip XT PRO, Clean & Strip XT PRO Extra Cut	Clean & Strip X	Debur and Finish PRO, Cut and Polish	EXL	SE, Duraflex	SC, PD, AI, LS
Bibielle	—	SDR Strip-It/Red	—	BUR Unitized	SCHD	SCLS, SCD, SCSB
Camel	—	EZ Strip Black/Red	—	—	—	—
Flexovit	—	Clean & Strip	—	—	—	—
Hermes	Strip Discs	Webrax	—	—	—	—
Pearl	—	S/C Stripping	—	—	—	Surface Preparation
Pferd	—	Policlean	—	Poliflex PUR	—	—
Sait	—	Sait-Strip	—	Unitized	7S, 8S	3Z
SIA	SiaStrip	—	—	—	6260	6250
Standard	—	Cleaning	700/800/900 Series	700/800/900 Series	FE, GP	FE, GP, RC
Superior	—	Stripping	—	XL Unitized	—	FD, GD, CC
Walter	—	FX Cleaning	—	—	—	Blendex Surface Conditioning

Why Choose Non-Woven Depressed Center Discs?



Non-Woven Right Angle Discs vs. Fiber Discs, Wire Wheels, and Depressed Center Wheels

- Deburring, blending and finishing done with one product to reduce the number of steps
- To provide a controlled, sustained finish
- To prevent undercutting and gouging
- To provide a cooler grinding action to lessen the chance of warping or discoloration
- When loading is an issue with fiberglass, adhesives and soft metals
- For stripping coatings and paint off of hard materials like concrete, cement and stone
- Less vibration and quieter for high operator acceptance
- To provide an alternative to wire brushes



Blaze Your Way to Greatest Productivity

Norton Blaze Rapid Strip Type 27 Depressed Center Discs

Strip/clean Cast Iron, Steels, Aluminum, Fiberglass and composites

- Open structure; will not load on sticky coatings, adhesives, and soft metals (e.g. aluminum), or snag and shed like a cloth or fiber disc might
- Norton Blaze ceramic alumina grain provides 2X cut rate and life over silicon carbide
- Will not shed on heavily rust-encrusted pieces
- Extremely versatile; use one disc; stiff enough to stand abuse, but soft enough to prevent gouging and rework
- Use on edge for blending weld root forms
- Apply some pressure to strip or remove coatings; lighter pressure finishes like a surface finishing disc
- Fewer safety, ergonomic, and environmental issues due to fewer change-outs, less downtime, and less production waste/landfill scrap



Rapid Strip

Best choice for quick and easy rough cleaning and stripping of all materials



BLAZE RAPID STRIP CERAMIC ALUMINA

- Blaze ceramic grain provides 2X plus faster, consistent rate and life than silicon carbide discs, leaves a thoroughly cleaned surface, ensuring excellent adhesion in subsequent processes such as painting and soldering
- Open web construction for minimal loading; does not shed or snag on rusty pieces; prevents gouging and rework
- Rapid Strip material provides a unique combination of aggressive performance, long life, and improved finish

Better choice for use on a variety of materials, including metal, fiberglass and stone



RAPID STRIP SILICON CARBIDE

- Sharp silicon carbide abrasive provides fast aggressive cutting action
- Advanced resin bond prevents shedding, snagging, gouging, and rework
- Open web construction for minimal loading; great alternative to wire brushes



TIER: **BEST**

BETTER

TRADENAME: **BLAZE RAPID STRIP**

RAPID STRIP

ABRASIVE: Ceramic Alumina

Silicon Carbide

GRIT SIZE: 36-50

36-50

GRADE: X-Coarse

X-Coarse

TYPE/BACKING: Type 27/Fiberglass

Type 27/Fiberglass

SIZE (D x H)	MAX. RPM	STD. PKG.	PART #	PART #
4-1/2 x 5/8-11	12,000	10	662544 98101	662610 09585
4-1/2 x 7/8	12,000	10	666233 03783	662610 09649
5 x 5/8-11	11,000	10	666233 03915	
5 x 7/8	11,000	10	666233 03916	
7 x 5/8-11	8,000	10	666233 03919	662610 09650
7 x 7/8	8,000	10	666233 03920	662610 09586

Rapid Blend

Best choice with revolutionary technology for heavy deburring and finishing



VORTEX RAPID BLEND ALUMINUM OXIDE

- Proprietary engineered Vortex aluminum oxide agglomerated grain performs the medium to fine grit steps of traditional aluminum oxide discs
- Thick nylon web for 2X longer life and faster finishing vs. traditional aluminum oxide discs, with minimal shedding
- Special resin chemistry resists shedding when used on sharp edges, making it ideal for deburring; no smearing

Better choice for surface prep, deburring, blending and removing parting lines, rust, and coatings



RAPID BLEND NEX A/O / S/C

- Premium aluminum oxide or silicon carbide grain for consistent performance
- Uniform construction extends life and maintains part tolerance; prevents cutting and gouging
- Resin formula produces consistent, smear-free finishes

Consistent smear free performance with low entry price



RAPID BLEND ALUMINUM OXIDE

- Premium aluminum oxide grain; engineered for more demanding applications
- Uniform construction maintains part tolerance; prevents cutting and gouging
- Smear-free bond excels at producing light satin finishes

MOST AGGRESSIVE / LEAST CONFORMABLE ← → LEAST AGGRESSIVE / MOST CONFORMABLE



	BEST		BETTER		BETTER		BETTER		BETTER	
	VORTEX RAPID BLEND		RAPID BLEND NEX		RAPID BLEND NEX		RAPID BLEND NEX		RAPID BLEND	
TRADENAME:	Engineered A/O		Aluminum Oxide		Aluminum Oxide		Silicon Carbide		Aluminum Oxide	
ABRASIVE:	100-120		150-180		220-280		320-400		150-180	
GRIT SIZE:	Vortex 5AM		NEX-2AM		NEX-2AF		NEX-2SF		High Strength Medium	
SPECIFICATION:	Type 27/Fiberglass		Type 27/Fiberglass		Type 27/Fiberglass		Type 27/Fiberglass		Type 27/Fiberglass	
TYPE/BACKING:	PART #		PART #		PART #		PART #		PART #	
SIZE (D x H)	MAX. RPM	STD. PKG.	PART #		PART #		PART #		PART #	
4-1/2 x 5/8-11	12,000	10	662544 29243		662610 23947		662610 23946		662610 23943	
4-1/2 x 7/8	12,000	10	662544 29268		662610 20548		662610 20547		662610 20546	

Non-Woven Standard Back-up Pad Discs

Rapid Prep
7/8" Center Hole

Best choice for aggressive stock removal and blending in one step



RAPID PREP XHD

- Coarse and Medium discs solve your most aggressive stock removal and blending challenges; remove weld lines, weld spatter, weld discoloration and blend surfaces in a single step
- Improve cut control and surface blending over traditional coated flap discs and fiber discs from our unique combination of a conformable fiber matrix and premium ceramic grain
- XHD Coarse discs for aggressive weld removal and surface blending on steels and Medium discs on softer metals/alloys



TIER: **BEST**
 TRADENAME: **RAPID PREP XHD**
 ABRASIVE: Ceramic Alumina

SIZE (D x H)	STD. PKG.	PART #
Coarse		
4-1/2" x 7/8"	40	662611 70275
5" x 7/8"	40	662611 70279
7" x 7/8"	25	662611 70280
Medium		
4-1/2" x 7/8"	40	662611 70282
5" x 7/8"	40	662611 70283
7" x 7/8"	25	662611 70284

All Vortex and Rapid Prep 7/8 hole discs are non-stock. Contact your Norton representative for current order quantities, and lead-times.

Note: Max RPM is determined by corresponding back up pad.

Norton Rapid Prep Surface Conditioning Products

The Perfect Abrasive, Coating, and Bond Built into Every Disc and Belt

- Available in premium Vortex aluminum oxide aggregate grain and Norton aluminum oxide grain; ideal for many aerospace, metal and stainless steel fabrication, and MRO applications
- Our proprietary coating method extends life and delivers consistent finishes by creating a thick layer of grain throughout the product; grain does not sit on top of fibers as other competitive products can
- Our new Clean Bond resin system guarantees smear-free finishes, even on high nickel content alloys; will not load on aluminum and soft metals, as competitive products can



Rapid Prep
7/8" Center Hole

Best choice for finishing and blending applications



VORTEX RAPID PREP ALUMINUM OXIDE DISCS

- High-performing, patented Vortex agglomerated aluminum oxide grain provides the cutting power of a coarser grit with the finish of finer grits
- Premium high-loft nylon fiber bonded to a strong nylon scrim backing allows a thick layer of resin bond and grain for extended life and provides added durability and stiffness
- Proprietary Clean Bond resin technology guarantees smear-free finishes even on high nickel content alloys and reduces loading on aluminum and other soft metals

Better choice for high nickel content alloys, aluminum and other soft metals



RAPID PREP ALUMINUM OXIDE

- Quality aluminum oxide abrasive grain coating provides up to 20% higher cut rate and 50% better performance than competitive products
- Premium high-loft nylon fiber bonded to a strong nylon scrim backing allows a thick layer of resin bond and grain for extended life, added durability and stiffness
- Proprietary Clean Bond resin technology guarantees smear-free finishes even on high nickel content alloys and reduces loading on aluminum and other soft metals



	TIER: BEST		BETTER	
	TRADENAME: VORTEX RAPID PREP		RAPID PREP	
	ABRASIVE: Engineered Aluminum Oxide		Aluminum Oxide	
SIZE (D x H)	STD. PKG.	PART #		PART #
Extra Coarse				
4-1/2" x 7/8"	25			666233 26070
5" x 7/8"	25	666233 34975		
7" x 7/8"	25	666233 41360		
Coarse				
4-1/2" x 7/8"	25	666233 34944		662544 73868
5" x 7/8"	25	666233 34946		662610 08293
7" x 7/8"	25	666233 41362		666233 25138
Medium				
4-1/2" x 7/8"	25	666233 33612		666233 25915
5" x 7/8"	25	666233 34963		662610 17124
7" x 7/8"	25	666233 41364		666233 25919
Fine				
4-1/2" x 7/8"	25	666233 33608		666233 25153
5" x 7/8"	25	666233 34954		662544 69132
7" x 7/8"	25	666233 41366		666233 25897
Very Fine				
4-1/2" x 7/8"	25	666233 33616		
5" x 7/8"	25			666233 25943
7" x 7/8"	25	666233 41368		666233 25959

All these discs are non-stock. Contact your Norton representative for current order quantities, and lead-times.
Note: Max RPM is determined by corresponding back-up pad.

See page 51 for 7/8" Hole Air Cooled Back-up Pads

Rapid Prep

Speed Change 5/8"-11

- These discs feature Norton quick, tool-free, twist-on and -off Speed-Change fasteners. Discs lock to standard back-up pads with a unique nut design and are easily removed, increasing your productivity with more time to grind.



TIER: **BEST**
 TRADENAME: **RAPID PREP XHD**
 ABRASIVE: Ceramic Alumina

SIZE (D x H)	STD. PKG.	PART #
Coarse		
4-1/2" x 5/8-11"	25	662611 70060
5" x 5/8-11"	25	662611 70061
7" x 5/8-11"	25	662611 70288
Medium		
4-1/2" x 5/8-11"	25	662611 70062
5" x 5/8-11"	25	662611 70063
7" x 5/8-11"	25	662611 70289

Max RPM is determined by corresponding back up pad.



TIER: **BEST** | **BETTER**
 TRADENAME: **VORTEX RAPID PREP** | **RAPID PREP**
 ABRASIVE: Engineered Aluminum Oxide | Aluminum Oxide

SIZE (D x H)	STD. PKG.	PART #	PART #
Extra Coarse			
4-1/2" x 5/8-11"	25	666233 73667	666233 73690
5" x 5/8-11"	25	666233 73669	
7" x 5/8-11"	25	666233 73670	666233 73692
Coarse			
4-1/2" x 5/8-11"	25	666233 73671	666233 73693
5" x 5/8-11"	25	666233 73674	662544 98516
7" x 5/8-11"	25	666233 73675	662611 92908
Medium			
4-1/2" x 5/8-11"	25	666233 73678	666233 08157
5" x 5/8-11"	25	666233 73679	666233 73694
7" x 5/8-11"	25	666233 73680	662611 92913
Fine			
4-1/2" x 5/8-11"	25	666233 73681	
5" x 5/8-11"	25	666233 73682	666233 73695
7" x 5/8-11"	25	666233 73684	
Very Fine			
5" x 5/8-11"	25	666233 73686	666233 73699
7" x 5/8-11"	25	666233 73687	666233 73700

Note: Speed Change discs must always be used with smooth face back-up pads.
 Max RPM is determined by corresponding back-up pad.

AVOS Non-Woven Speed-Lok

- Patented hole design allows for interrupted cut, reducing heat up to 30% over standard surface preparation discs for cooler cutting and longer life
- With complete vision into the grinding zone, operators can grind more accurately with less re-work; scooped holes create air glow to pull loose abrasive and swarf away from work surface grinding zone – resulting in extended disc life
- The 15° angle back-up pad lets you grind at 5° - 15° angle allowing for greater utilization of disc surface and eliminates gouging of workpiece

See page 51 for Speed Change and AVOS Back-up Pads



TIER: **BETTER**
 TRADENAME: **RAPID PREP AVOS**
 ABRASIVE: Aluminum Oxide

SIZE (DIAMETER)	STD. PKG.	PART #
Coarse		
4-1/2"	10	662610 10447
5"	10	666233 74818
Medium		
4-1/2"	10	662610 10448
5"	10	666233 74819
Very Fine		
4-1/2"	10	666233 74823
5"	10	666233 74824

Note: AVOS discs must be used with AVOS Speed-Lok back-up pads.
 Max RPM is determined by corresponding back up pad.

Rapid Prep
Non-Woven Hook and Loop Discs



TIER: **BEST**
 TRADENAME: **RAPID PREP XHD**
 ABRASIVE: Ceramic Alumina

SIZE (DIAMETER)	STD. PKG.	PART #
Coarse		
4-1/2	40	662611 70179
5	40	662611 70181
7	25	662611 70182
Medium		
4-1/2	40	662611 70183
5	40	662611 70185
7	25	662611 70186

Max RPM is determined by corresponding back-up pad.
 * Standard Package = 80

Back-up Pads
Hook & Loop Back-up Pads

PAD DIAMETER	SPINDLE OR HOLE SIZE	MAX. RPM	3M EQUIVALENT	STD. PKG.	PART #
Back-up Pads for Hook and Loop Discs					
2	1/4 Steel Shank	23,000	922	5	662610 59352
3	1/4 Steel Shank	20,000	923	5	662610 59354
4	1/4 Steel Shank	18,000	924	5	662610 59356
	5/8-11	13,000	914	5	662610 59304
	M10 x 1.250	13,000		5	662610 59305
4-1/2	5/8-11	10,000	9145	5	662610 06948
5	5/16-24 Male	10,000	905	5	662610 59360
	5/8-11	10,000	915	5	662610 59310
6	5/8-11	8,000	916	5	662610 59312
7	5/8-11	6,000	917	5	662610 59368
8	5/8-11	4,500	918	5	662610 59372



TIER: **BEST** **BETTER**
 TRADENAME: **VORTEX RAPID PREP** **RAPID PREP**
 ABRASIVE: Engineered Aluminum Oxide Aluminum Oxide

SIZE (DIAMETER)	STD. PKG.	PART #	PART #
Extra Coarse			
2	50		662610 17900
3	25	666233 33620	
4-1/2	25	666233 34972	662610 17906
5	25	666233 34974	662610 17215
7	25	666233 34976	662611 92846
Coarse			
2	50	666233 34882	662610 04431 *
3	25	666233 34883	662610 55015
4-1/2	25	666233 34943	662610 17806
5	25	666233 34945	662610 04435
7	25	666233 34951	662610 55027
Medium			
2	50	666233 34958	662610 04441
3	25	666233 34956	662610 04442
4-1/2	25	666233 34961	662610 04444
5	25	666233 34962	662610 55022
7	25	666233 34965	662610 17813
Fine			
2	50	666233 33604	666233 25141
3	25	666233 33605	666233 25143
4-1/2	25	666233 33607	666233 25147
5	25	666233 33609	666233 25154
7	25	666233 34955	662611 99465
Very Fine			
2	50	666233 33613	666233 25926
3	25	666233 33614	666233 25934
4-1/2	25	666233 33615	666233 25936
5	25	666233 33617	666233 25941
7	25	666233 34969	662610 19990

Max RPM is determined by corresponding back-up pad.
 * Standard Package = 80





Norton PSA (pressure sensitive adhesive) individual cloth discs are used on four different types of machines and the application changes depending on which machine they are used on.

Applications:

Pneumatic and Electric Dual-Action (DA) and Electric Random Orbital Sanders – for use on contours or flat surfaces for light- to medium-pressure grinding, blending, leveling, and finishing applications.

Stationary Disc Sanders – used in woodworking and metalworking for stock removal, sanding/grinding flat surfaces, dimensioning and finishing.

Size Range:

5" – 24" diameter

Grit Range:

24 – 180

Abrasive Grain:

Ceramic Alumina, Zirconia Alumina, Aluminum Oxide

Back-up Pads:

Rubber, with hardness variations for different applications, for portable machines. Steel for stationary disc sanders.

Machine Used:



ORBITAL SANDER



STATIONARY DISC SANDERS



Best choice for all hard-to-grind high alloy steels



BLAZE R980P CERAMIC ALUMINA

- 100% ceramic alumina micro-fracturing grain constantly exposes sharper grain edges to provide fastest cut rate and longest life over competitive blended/low-ratio ceramic alumina discs
- Strong resin bond and heavy-duty Y-weight polyester backing for consistent cut, better grain adhesion, edge-tear resistance, and durability
- Self-lubricating grinding aid treatment delivers the coolest cut on stainless steel, high alloy steels, super alloys, titanium, and other difficult to grind materials

Better choice for grinding and deburring stainless steel

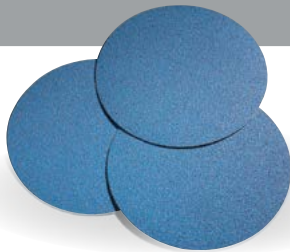

BLUEFIRE R821P ZIRCONIA ALUMINA

- Latest generation of self-sharpening, zirconia alumina abrasive for cooler cut and extended life over aluminum oxide discs
- Heavy-duty Y-weight cotton backing for edge-tear resistance and durability
- Pressure sensitive adhesive makes for easy application and removal

Good choice for general-purpose metalworking



GEMINI R228 ALUMINUM OXIDE

- Premium aluminum oxide abrasive gives an excellent initial cut rate
- Durable X-weight cotton backing makes these discs a good blend of flexibility and life
- The cotton backing provides good resistance to heat

Good option for light- to medium-pressure grinding, blending, leveling and finishing applications



METAL R243 ALUMINUM OXIDE

- Aluminum Oxide grain provides consistent cut for general purpose use
- Improved resin bond system provides longer life
- Flexible J-weight cotton backing for added conformability, tabs allow for easy liner removal

Cloth PSA Discs for Dual-Action and Random Orbital Sanders



TIER:	BEST	GOOD	GOOD
TRADENAME:	BLAZE R980P	GEMINI R228	METAL R243
ABRASIVE:	Ceramic Alumina	Aluminum Oxide	Aluminum Oxide
ATTACHMENT:	PSA Discs	PSA Discs	PSA Discs
OTHER:	Supersize		

SIZE (D)	GRIT	PKG./CASE	PART #	PART #	PART #
5	36	50/250	662544 61506*	662611 36589	
	40	50/250	662544 61507	662611 36588	
	50	50/250	662544 61508	662611 36587	
	60	50/250	662544 61509	662611 36586	
	80	50/250	662544 61510	662611 36585	699573 39967
	100	50/250		662611 36584	699573 39968
	120	50/250	662544 61512	662611 36583	699573 39969
	150	50/250		662611 36582	699573 39970
	180	50/250		662611 36581	699573 39971
	6	60	50/250		662611 36596
80		50/250		662611 36595	699573 39973
100		50/250		662611 36594	699573 39977
120		50/250		662611 36593	699573 39978
150		50/250			699573 39979
8	180	50/250		662611 36592	699573 39986
	36	50/250		662611 36350	
	40	50/250		662611 36351	
	50	50/250		662611 36352	
	60	50/250		662611 36356	
	80	50/250		662611 36354	
	120	50/250		662611 36355	

*PKG./Case: Blaze R980P 5" 36 grit discs = 50/200



Back-up Pads for Cloth PSA Discs

DESCRIPTION	MAX. RPM	STD. PKG.	PART #
Back-up Pads for Cloth PSA Discs			
5" Diameter – Low Profile – Soft	12,000	5	636425 06126
5" Diameter – Low Profile – Medium	12,000	5	636425 06131
5" Diameter – Tapered – Medium	12,000	5	636425 06139
6" Diameter – Low Profile – Soft	10,000	5	636425 06127
6" Diameter – Low Profile – Med	10,000	5	636425 06133
6" Diameter – Tapered – Medium	10,000	5	636425 06141
8" Diameter – Tapered – Medium	6,000	5	636425 43112

Large Diameter Cloth PSA Discs

Used on stationary disc machines for dimensioning and finishing metal workpieces and woodworking. Pressure sensitive adhesive offers fast, convenient mounting. Made without center holes for full-face usage.

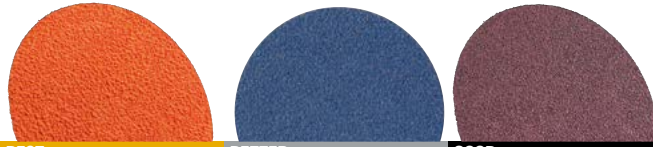

TIER:	BEST	BETTER	GOOD
TRADENAME:	BLAZE R980P	BLUEFIRE R821P	GEMINI R228
ABRASIVE:	Ceramic Alumina	Zirconia Alumina	Aluminum Oxide
ATTACHMENT:	PSA	PSA	PSA
OTHER:	Supersize		

SIZE (D)	GRIT	PKG./CASE	PART #	PART #	PART #
10	36	25/50			662611 36606
	40	25/50		662611 38314	662611 36604
	50	25/50			662611 36607
	60	25/50		662611 38316	662611 36602
	80	25/50		662611 38317	662611 36601
	100	25/50			662611 36600
12	24	25/50		662611 38318	
	36	25/50	662544 16171	662611 38319	662611 36635
	40	25/50	662544 16172	662611 38320	662611 36630
	50	25/50	662544 16173	662611 38321	662611 36625
	60	25/50	662544 16174	662611 38322	662611 36620
	80	25/50	662544 16175	662611 38323	662611 36615
	100	25/50			662611 36614
	120	25/50	662544 16176		662611 36613
15	36	25/50			662611 36666
	60	25/50			662611 36663
	80	25/50			662611 36662
16	36	25/50			662611 36700
	40	25/50			662611 36685
	50	25/50			662611 36684
	60	25/50		662611 38334	662611 36683
	80	25/50			662611 36701
18	36	25/50			662611 36720
	60	25/50			662611 36696
	80	25/50			662611 36723
20	36	25/50	662544 16165	662611 38343	662611 36710
	40	25/50		662611 38344	662611 36709
	50	25/50	662544 16167		662611 36711
	60	25/50	662544 16168	662611 38346	662611 36712
	80	25/50	662544 16169		662611 36706
	120	25/50	662544 16170		
24	36	10/10			662611 36718
	40	10/10			662611 36717
	50	10/10			662611 36725
	60	10/10			662611 36726
	80	10/10			662611 36727



For use on dual action and random orbital sanders. The industry's highest performing and broadest selection of paper discs in PSA (pressure sensitive adhesive) disc rolls and individual discs, and hook and loop discs.

- Applications:** Stripping and preparing primed and painted surfaces for finishing, sanding of plastics, fiberglass and composites, bare wood sanding, light weld blending, preparing and finishing metal, and sanding of all gel coat and body filler compounds.
- Size Range:** 3" – 8"
- Grit Range:** 36 – 1500
- Abrasive Grain:** Ceramic Alumina, Zirconia Alumina, Aluminum Oxide, Silicon Carbide
- Attachment Systems:** PSA (pressure-sensitive adhesive), hook and loop
- Paper Weights:** Heavyweight – E and F; Lightweight – B, C, and D
- Vacuum Holes:** See product availability charts
- Machine Used:**



ORBITAL SANDER



VERTICAL SHAFT PORTABLE GRINDER

Material/Application-to-Product Recommendation Guide

	BEST			BETTER		GOOD	
	Heavy-Medium Stock Removal	Light Stock Removal Finishing		Heavy-Medium Stock Removal		Light Stock Removal Finishing	Light Stock Removal Finishing
	SG H920	Blaze A995	Dry Ice A975	BlueFire H875P	BlueFire H822	A2750P	Gold Reserve A296
Primed, Painted Surfaces		◆	◆	◆		◆	◆
Fiberglass / Composites / Gel Coats		◆	◆	◆		◆	◆
Wood		◆	◆	◆		◆	◆
Metal	◆	◆	◆		◆	◆	◆
Body Fillers / Compounds / Plastics		◆	◆	◆		◆	◆

Application/Grit Recommendation Guide

COARSER (GRINDING)											FINER (FINISHING)								
36	40	60	80	100	120	150	180	220	240	280	320	360	400	500	600	800	1000	1200	1500
Roughing to Intermediate			Intermediate to Finishing							Fine Finishing				Ultra Fine Finishing					

Cross Reference Guide

	TOTAL PERFORMANCE						INITIAL PRICE		
	BEST			BETTER			GOOD		
NORTON	F-Weight SG H920	X-Weight Blaze A995	B- & C-Weight Dry Ice A975	F-Weight BlueFire H822	E-Weight BlueFire H875P	B-Weight A275 OP	B-Weight Durite A475	C-Weight A290	B-Weight Gold Reserve A296
3M	763U	732U, 737U, 755L 775L	334U, 734U, 735U	—	740I, 745I, 750U, 751U, 751I	216U, 255L, 236U, 260L, 334U	405N, 414N, 415U, 426U, 435U	236U, 316U, NX	216U, 236U
Hermes	BW114, CR116	CR116	—	BW115, BW184	BW110, VC153	VC154-LL	SF168	VC151-LL, VC152, WA flex 28	—
Indasa	—	HT Line	HT Line, RedLine	—	HeavyLine	PlusLine	—	WhiteLine, YellowLine	—
Klingspor	PS61	—	PS36	PS21	PS36	PS33, PS73W	PL35, PS14	PS33	PL36
Mirka	—	—	—	—	Royal CRS. Cut	Q-Silver, Royal Micro	CaratFlex, PolarStar	Bulldog Gold, Basecut	Bulldog Gold
SIA	—	—	Siaprime 5550, 1958	1820	1820, 1919, 1948	1940, 1944, 1950	1748	1947, 1960	—
VSM	—	—	—	—	KP510E, KP709	—	CP131A	KP911	—

Heavyweight Paper Discs

Best choice for most demanding stock removal applications



SG H920 CERAMIC ALUMINA

- Durable and friable Norton seeded gel ceramic alumina abrasive ensures fast, aggressive, yet cool cutting action and maximum life
- Strong F-weight paper, synthetically-coated, provides maximum durability and resistance to edge chipping and shedding
- Closed coat and sharp grain make this a premiere product for metal fabricating and blending; ideal for soldered and welded areas

Better choice for aggressive metalworking applications



BLUEFIRE H822 ZIRCONIA ALUMINA

- Patented zirconia alumina abrasive provides 2X-3X life over aluminum oxide products
- Strong F-weight paper, synthetically-coated for excellent durability and chip resistance; pressure sensitive adhesive and linked disc roll format allow easy application, removal, and dispensing
- Non-stearated (no anti-loading agents) for non-contaminating; often required for prime auto and aerospace paint applications

Better choice for soft material and wood applications



BLUEFIRE H875P ZIRCONIA ALUMINA

- Next-generation, self-sharpening zirconia alumina abrasive provides 2-3 times the life of aluminum oxide discs, longer life versus original zirconia alumina discs, improved cut rate, and minimal heat
- Strong E-weight latex/paper backing resists tearing while staying conformable and flexible
- Open coat contributes to minimized loading

Stick & Sand (PSA)
Heavyweight Disc Rolls
Non-Vacuum



				TIER: BEST	BETTER	BETTER
				TRADENAME: SG H920	BLUEFIRE H822	BLUEFIRE H875P
				ABRASIVE: Ceramic Alumina	Zirconia Alumina	Zirconia Alumina
				PAPER BACKING WEIGHT: F-Weight	F-Weight	E-Weight
				FASTENING: PSA	PSA	PSA
SIZE	GRIT	ROLLS/STD. PKG.	DISCS/ ROLL	PART #	PART #	PART #
5	60	4	100	662611 49873	662611 37310	
	80	4	100	662611 49872	662611 37309	662611 24977
	100	4	100	662611 49871	662611 37308	
	120	4	100	662611 49870	662611 37307	
6	60	4	100		662611 37323	
	80	4	100	662611 49876	662611 37322	662611 25573
	120	4	100	662611 49874		
8	100	4	50	662611 49879		
	120	4	50		662611 37333	

Refer to the Sanding Accessories section for back-up pads and accessories.

Heavyweight Paper Discs

Stick & Sand (PSA)
Individual Discs
Non-Vacuum and Vacuum



TIER:	BETTER	BETTER
TRADENAME:	BLUEFIRE H875P	BLUEFIRE H875P
ABRASIVE:	Zirconia Alumina	Zirconia Alumina
PAPER BACKING WEIGHT:	E-Weight	E-Weight
FASTENING:	PSA	PSA Vacuum

SIZE	GRIT	PKG./CASE	PART #	PART #
5	36	50/200	662611 25436	
	40	50/200	662611 25307	
	80	50/200	662611 25244	

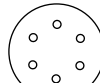

6" x 6 Hole
Die #3371

6	36	50/200	662611 23575	
	40	50/200	662611 23574	662611 23580
	80	50/200	662611 23573	

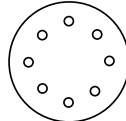

8" x 8 Hole
Die #3370

8	36	25/100	662611 23578	662611 23584
	40	25/100	662611 23577	
	80	25/100	662611 23576	662611 23582

Hook & Loop
Individual Discs
Non-Vacuum and Vacuum



TIER:	BEST	BETTER	BETTER
TRADENAME:	SG H920	BLUEFIRE H875P	BLUEFIRE H875P
ABRASIVE:	Ceramic Alumina	Zirconia Alumina	Zirconia Alumina
PAPER BACKING WEIGHT:	F-Weight	E-Weight	E-Weight
FASTENING:	Hook & Loop	Hook & Loop	Hook & Loop
OTHER:			Vacuum

SIZE	GRIT	PKG./CASE	PART #	PART #	PART #
5	40	25/100		662611 25684	
	60	50/250	662611 49864		
	80	50/250	662611 49865	662611 25444*	
	100	50/250	662611 49866		
	120	50/250	662611 49867		
6	36	25/100		662611 23590	
	40	25/100		662611 23589	
	80	25/100		662611 23588	

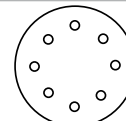

8" x 8 Hole
Die #3370

8	36	25/100		662611 23593	662611 23598
	40	25/100		662611 23592	
	80	25/100		662611 23591	662611 23596

Packaging Standards: Min. / Std. Pkg. * H875P = 25/100

Lightweight Paper Discs

Less dust; more productivity



MULTI-AIR CYCLONIC HOOK & LOOP VACUUM

- Multi-Air Cyclonic precision laser-cut, spiral vacuum hole design maximizes dust extraction for cleanest work environment and less potential for contamination, while delivering coolest, fastest, most consistent cut rate, and longest life of any paper disc
- Water-based, non-pigmented stearate No-Fil coating and open coat provide maximum load resistance and no color transfer to work
- Exceptional choice for the most demanding paper disc sanding applications; hook and loop back for easy disc mounting and changing



TIER:	BEST	BEST
TRADENAME:	BLAZE A995 NO-FIL	DRY ICE A975 NO-FIL
ABRASIVE:	Ceramic Alumina	Ceramic Alumina
PAPER BACKING WEIGHT:	C- & D-Weight	B- & C-Weight
FASTENING:	Hook & Loop	Hook & Loop
OTHER:	P-Graded	P-Graded



SIZE	GRIT	PKG/CASE	PART #	PART #
3 x 0	80	50/200		776960 95005
	120	50/200		776960 95006
	150	50/200		776960 95007
	180	50/200		776960 95008
	220	50/200		776960 95009
	240	50/200		776960 95010
	320	50/200		776960 95011
	400	50/200		776960 95012
	500	50/200		776960 95013
	600	50/200		776960 95014
	800	50/200		776960 95015
1000	50/200		776960 95016	
5 x 11/16 (125mm x 18mm)	80	50/200	636425 97500	776960 07745
	120	50/200	636425 97501	776960 07753
	150	50/200	636425 97502	776960 07755
	180	50/200	636425 97503	776960 07756
	220	50/200	636425 97504	776960 07757
	240	50/200		776960 07760
	280	50/200		776960 07762
	320	50/200		776960 07763
	400	50/200		776960 07765
	500	50/200		776960 07768
	600	50/200		776960 07791
800	50/200		776960 07793	
1000	50/200		776960 07795	
6 x 11/16 (150mm x 18mm)	80	50/200	636425 97505	776960 07770
	120	50/200	636425 97506	776960 07773
	150	50/200	636425 97507	776960 07774
	180	50/200	636425 97508	776960 07775
	220	50/200	636425 97509	776960 07776
	240	50/200		776960 07777
	280	50/200		776960 07778
	320	50/200		776960 07781
	400	50/200		776960 07784
	500	50/200		776960 07785
	600	50/200		776960 07786
800	50/200		776960 07787	
1000	50/200		776960 07788	

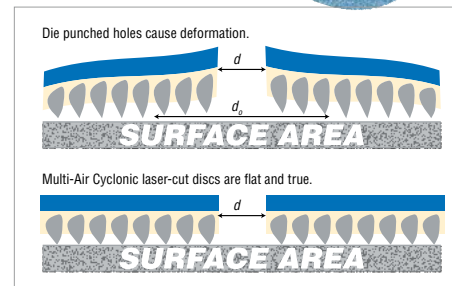

Improved Dust Extraction / Increased Productivity

The upgrade to precise, flat, laser-cut holes instead of die-punched holes, dramatically increases surface area contact allowing Norton Multi-Air Cyclonic discs to improve productivity by 32% versus conventional multi-hole sanding and by 60% versus non-vacuum sanding.

The end result is more holes for dust extraction, more abrasive coverage for a better cut and no deformation – for full surface contact utilizing all the cutting power of the premium ceramic grain.

Refer to the Sanding Accessories section for back-up pads and accessories.

Lightweight Paper Discs



NEW

Best choice for the most demanding coarse grit stripping, blending, and sanding applications

BLAZE A995 NO-FIL CERAMIC ALUMINA

- P-graded, next-generation sharper-edged ceramic aluminum oxide abrasive ensures fastest cut rate and longest life of any paper disc
- Unique polyester-reinforced, D-weight latex saturated backing provides maximum tear strength while retaining flexibility
- Water-based, non-pigmented stearate No-Fil coating and open coat provide maximum load resistance and no color transfer to work



Best choice for the most demanding sanding applications

DRYICE A975 NO-FIL CERAMIC ALUMINA

- P-graded seeded-gel ceramic alumina abrasive for fastest cut rate and longest life of any paper disc
- Unique fiber reinforced, flexible B or C-weight latex saturated backing delivers 50% - 60% improvement in tear strength while retaining flexibility
- Water-based, non-pigmented stearate No-Fil coating and open coat provide maximum load resistance and no color transfer to work



Better choice for high-performance dry finishing on all materials

A2750P NO-FIL ALUMINUM OXIDE

- Premium P-graded, heat treated, toughened aluminum oxide abrasive delivers superior life, fast cut rate, consistent finish
- Unique fiber reinforced, flexible B-weight latex saturated backing provides 50% - 60% improvement in tear strength while retaining flexibility
- Water-based, non-pigmented stearate No-Fil coating and open coat provide maximum load resistance and no color transfer to work
- 5" and 6" individual PSA discs in fine grits have a tabbed, white translucent liner to protect the PSA adhesive from airborne contaminants; the tab allows easier removal of the paper liner



Better choice for hard-to-sand surfaces and wood applications

DURITE A475 NO-FIL SILICON CARBIDE

- Sharp and hard, P-graded, silicon carbide abrasive easily penetrates the hardest material and veneers to create finer finishes where finish is critical
- Flexible, B-weight fiber reinforced, latex paper backing provides flexibility and resistance to tearing
- Water-based, non-pigmented stearate No-Fil coating and open coat provide maximum load resistance and no color transfer to work



Good choice for sanding a broad range of substrates including primed or painted surfaces, wood, composites, aluminum, and ferrous metals

GOLD RESERVE A296 NO-FIL ALUMINUM OXIDE

- P-graded premium aluminum oxide abrasive produces a quick, cool cut and a more consistent surface finish
- Strong B-weight latex/paper backing resists tearing while staying conformable and flexible
- Water-based, non-loading (No-Fil) stearate coating minimizes clogging and increases disc life

Lightweight Paper Discs

Stick & Sand (PSA)
Lightweight Disc Rolls
Non-Vacuum

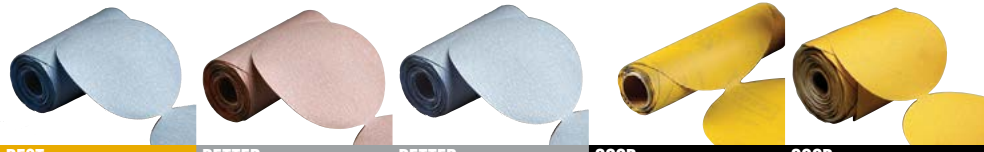

TIER:	BEST	BETTER	BETTER	GOOD	GOOD
TRADENAME:	DRYICE A975 NO-FIL	A2750P NO-FIL	DURITE A475 NO-FIL	GOLD RESERVE A296 NO-FIL	A290 NO-FIL
ABRASIVE:	Ceramic Alumina	Aluminum Oxide	Silicon Carbide	Aluminum Oxide	Aluminum Oxide
PAPER BACKING WEIGHT:	B- & C-Weight	B-Weight	B-Weight	B-Weight	C-Weight
FASTENING:	PSA	PSA	PSA	PSA	PSA
OTHER:	P-Graded	P-Graded	P-Graded	P-Graded	P-Graded

SIZE	GRIT	ROLLS/ STD. PKG.	DISCS/ ROLL	PART #	PART #	PART #	PART #	PART #
3-1/2	80	4	100		662611 36376			
	120	4	100		662611 36375			
	180	4	100		662611 36373			
	220	4	100		662611 36372			
	280	4	100		662611 36370			
	320	4	100		662611 36369			
	400	4	100		662611 36368			
5	60	4	100					662611 49831
	80	4	100	662611 40502	662611 131464 *	662544 87415	662611 183806	662611 49830
	100	4	100	662611 40501	662611 131463 *	662544 87417	662611 183807	662611 49829
	120	4	100	662611 40500	662611 131462 *	662544 87418	662611 183808	662611 49828
	150	4	100	662611 40499	662611 131461 *	662544 87440	662611 183809	662611 49827
	180	4	100	662611 40498	662611 131460 *	662544 87441	662611 183810	662611 49826
	220	4	100	662611 42474	662611 131459 *	662544 87442	662611 183811	662611 49825
	240	4	100	662611 55380	662611 131458 *	662544 87443		662611 49824
	280	4	100	662611 55379	662611 131457 *			662611 49823
	320	4	100	662611 55378	662611 131456 *	662544 87444	662611 183813	662611 49822
	400	4	100	662611 55377	662611 131454 *	662610 65293	662611 183814	662611 49821
	500	4	100		662611 131453 *			
	600	4	100	666233 05608	662611 131452 *	662544 21217		
	800	4	100	662544 80230	662611 131451 *			
6	60	4	100					662611 49847
	80	4	100	662611 40512	662611 131481 *	662544 87446	662611 183815	662611 49842
	100	4	100	662611 40511	662611 131480 *		662611 183816	662611 49841
	120	4	100	662611 40510	662611 131479 *	662544 87447	662611 183817	662611 49840
	150	4	100	662611 40509	662611 131478 *		662611 183818	662611 49839
	180	4	100	662611 40508	662611 131477 *	662544 87448	662611 183819	662611 49838
	220	4	100	662611 48340	662611 131476 *	662544 87449	662611 183820	662611 49837
	240	4	100	662611 55376	662611 131475 *		662611 183821	662611 49836
	280	4	100		662611 131474 *			662611 49835
	320	4	100	662611 55374	662611 131473 *	662544 87450	662611 183822	662611 49834
	400	4	100	662611 55373	662611 131471 *		662611 183823	662611 49833
	500	4	100	636425 06198	662611 131470 *			
	600	4	100	636425 06199	662611 131469 *		662610 40261	
	800	4	100	636425 06200	662611 131468 *		636425 06164	
8	80	4	100		662611 131617			
	120	4	100		662611 131615			
	150	4	100		662611 131614			
	180	4	100		662611 131613			
	220	4	100		662611 131612			
320	4	100		662611 131609				

* Packaging Standards A275 = 6/100

Refer to the Sanding Accessories section for back-up pads and accessories.

Lightweight Paper Discs

Stick & Sand (PSA)
Lightweight Disc Rolls
Vacuum



TIER: **BETTER**
 TRADENAME: **A2750P NO-FIL**
 ABRASIVE: Aluminum Oxide
 PAPER BACKING WEIGHT: B-Weight
 FASTENING: PSA
 OTHER: P-Graded





TIER: **GOOD**
 TRADENAME: **A290 NO-FIL**
 ABRASIVE: Aluminum Oxide
 C-Weight
 PSA
 P-Graded



Stick & Sand (PSA)
Individual Discs
Non-Vacuum



TIER: **BETTER**
 TRADENAME: **A2750P NO-FIL**
 ABRASIVE: Aluminum Oxide
 PAPER BACKING WEIGHT: B-Weight
 FASTENING: PSA Tabbed
 OTHER: P-Graded

SIZE	GRIT	ROLLS/ STD. PKG.	DISCS/ ROLL	PART #	ROLLS/ STD. PKG.	DISCS/ ROLL	PART #
							
				5" x 5 Hole Die #3329			5" x 5 Hole Die #3329
5	60				4	100	662611 30266
	80	6	100	662611 31498	4	100	662611 30265
	100	6	100	662611 31497			
	120	6	100	662611 31496	4	100	662611 30263
	150	6	100	662611 31495	4	100	662611 30262
	180	6	100	662611 31494	4	100	662611 30261
	220	6	100	662611 31493	4	100	662611 30260
	240	6	100	662611 31492			
	320	6	100	662611 31490	4	100	662611 30258
	400	6	100	662611 31488			

SIZE	GRIT	MIN./ STD PKG.	PART #
5	1000	100/400	662611 31450
	1200	100/400	662611 31449
6	1000	100/400	662611 31467
	1200	100/400	662611 31466
	1500	100/400	662611 31465

SIZE	GRIT	ROLLS/ STD. PKG.	DISCS/ ROLL	PART #	ROLLS/ STD. PKG.	DISCS/ ROLL	PART #
							
				6" x 6 Hole Die #3333			6" x 6 Hole Die #3333
6	80	6	100	662611 31515	4	100	662611 30276
	100	6	100	662611 31514	4	100	662611 30275
	120	6	100	662611 31513	4	100	662611 30274
	150	6	100	662611 31512	4	100	662611 30273
	180	6	100	662611 31511	4	100	662611 30272
	220	6	100	662611 31510	4	100	662611 30271
	240	6	100	662611 31509			
	280	6	100	662611 31508			
	320	6	100	662611 31507	4	100	662611 30268
	400	6	100	662611 31505			
	600	6	100	662611 31503			

Refer to the Sanding Accessories section for back-up pads and accessories.

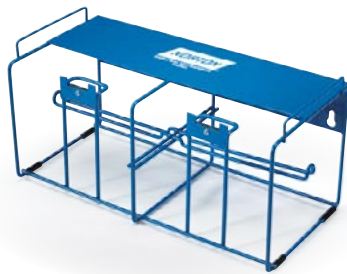

PSA Disc Roll Dispenser

- Norton disc roll dispensers feature heavy-duty construction and a rubberized finish to protect your product, as well as the finish on your workpiece
- These versatile dispensers are designed to accommodate any 5" or 6" disc roll or sheet roll
- They can be attached to a wall or stacked for multi-grit or multi-diameter operations
- Discs are individually dispensed and removed from the roll by a cutter bar

DESCRIPTION	STD. PKG.	PART #
PSA Disc Roll Dispenser		
Single Disc Roll Dispenser	1	636425 42772
Double Disc Roll Dispenser (shown)	1	636425 02981

Lightweight Paper Discs

Hook & Loop
Individual Discs
Non-Vacuum



TIER:	BEST	BEST
CAP CODE:	BLAZE A995 NO-FIL	DRY ICE A975 NO-FIL
ABRASIVE:	Ceramic Alumina	Ceramic Alumina
PAPER BACKING WEIGHT:	D-Weight	B- & C-Weight
FASTENING:	Hook & Loop	Hook & Loop
OTHER:	P-Graded	P-Graded

TIER:	BETTER	BETTER	GOOD	GOOD
CAP CODE:	A2750P NO-FIL	DURITE A475 NO-FIL	GOLD RESERVE A296 NO-FIL	A290 NO-FIL
ABRASIVE:	Aluminum Oxide	Silicon Carbide	Aluminum Oxide	Aluminum Oxide
PAPER BACKING WEIGHT:	B-Weight	B-Weight	B-Weight	C-Weight
FASTENING:	Hook & Loop	Hook & Loop	Hook & Loop	Hook & Loop
OTHER:	P-Graded	P-Graded	P-Graded	P-Graded

SIZE	GRIT	PKG/CASE	PART #	PART #	PKG/CASE	PART #	PART #	PART #	PART #
3	80				50/200	662611 31532			
	100				50/200	662611 44926			
	120				50/200	662611 28688			
	150				50/200	662611 40385			
	180				50/200	662611 31528			
	220				50/200	662611 31527			
	240				50/200	662611 31526			
	320				50/200	662611 31524			
	400				50/200	662611 36995			
	500				50/200	662611 31521			
	600				50/200	662611 36996			
	800				50/200	662611 31519			
	1000				50/200	662611 35900			
	1500				50/200	662611 47434			
	5	60				100/400			
80		50/200		662611 40522	100/400	662611 31549		666233 77539	662611 49907
100		50/200		662611 40521	100/400	662611 31548			662611 49906
120		50/200		662611 40520	100/400	662611 31547		666233 77541	662611 49905
150		50/200		662611 40519	100/400	662611 31546		666233 77542	662611 49904
180		50/200		662611 40518	100/400	662611 31545		666233 77543	662611 49903
220		50/200		662611 49541	100/400	662611 31544		666233 05637	662611 49902
240		50/200		662611 49540	100/400	662611 31543			
280					100/400	662611 31542			
320		50/200		662611 49538	100/400	662611 31541		666233 05638	662611 49900
400		50/200		662611 49537	100/400	662611 31539	662610 52270	666233 05639	662611 49899
500		50/200		662544 80233	100/400	662611 31538			
600					100/400	662611 31537		662611 05390	
800		50/200		662544 80232	100/400	662611 31536	662610 52267	666233 77544	
1000					100/400	662611 31535	662610 52254		
1200				100/400	662611 31534				
1500				100/400	662611 31533				
6	80	50/200	636425 97510	662611 40532	100/400	662611 31566		636425 06236*	662611 49916
	100	50/200		662611 40531	100/400	662611 31565		636425 06235*	662611 49915
	120	50/200	636425 97511	662611 40530	100/400	662611 31564		636425 06234*	662611 49914
	150	50/200	636425 97512	662611 40529	100/400	662611 31563		636425 06233*	662611 49913
	180	50/200	636425 97513	662611 40528	100/400	662611 31562		636425 06232*	662611 49912
	220	50/200	636425 97514	662611 49546	100/400	662611 31561		636425 06231*	662611 49911
	240				100/400	662611 31560		636425 06225*	
	280				100/400	662611 31559			
	320	50/200		662611 49543	100/400	662611 31558		636425 06230*	662611 49909
	400	50/200		662611 49542	100/400	662611 31556		636425 06229*	662611 49908
	500	50/200		636425 06202	100/400	662611 31555		636425 06228*	
	600	50/200		636425 06203	100/400	662611 31554		636425 06227*	
	800	50/200		636425 06204	100/400	662611 31553		636425 06226*	
	1000	50/200		636425 06375	100/400	662611 31552	662610 52255		
	1200	50/200		636425 06376	100/400	662611 31551			
1500	50/200		636425 06377	100/400	662611 31550				
8	120				100/400	662611 31662			
	180				100/400	662611 31661			

Packaging Standards: PKG/CASE A296 = 50/250

Refer to the Sanding Accessories section for back-up pads and accessories.

Lightweight Paper Discs

Hook & Loop
Individual Discs
Vacuum



	TIER: BEST	BETTER	GOOD	GOOD	GOOD		
CAP CODE:	DRY ICE A975 NO-FIL	A2750P NO-FIL	GOLD RESERVE A296 NO-FIL	A290 NO-FIL	A290 NO-FIL		
ABRASIVE:	Ceramic Alumina	Aluminum Oxide	Aluminum Oxide	Aluminum Oxide	Aluminum Oxide		
PAPER BACKING WEIGHT:	B- & C-Weight	B-Weight	B-weight	C-Weight	C-Weight		
FASTENING:	Hook & Loop	Hook & Loop	Hook & Loop	Hook & Loop	Hook & Loop		
OTHER:	P-Graded	P-Graded	P-Graded	P-Graded	P-Graded		
SIZE	GRIT	PKG./CASE	PART #	PART #	PART #	PART #	PART #
			5" x 5 Hole Die #3328	5" x 5 Hole Die #3328	5" x 5 Hole Die #3328	5" x 5 Hole Die #3328	5" x 8 Hole Die #3392
5	60	100/400			662611 30236*		662611 30245*
	80	100/400	662611 40517*	662611 31583	662611 30235*		662611 30244*
	100	100/400		662611 31582	662611 30234*		662611 30243*
	120	100/400	662611 40515*	662611 31581	662611 30233*		662611 30242*
	150	100/400		662611 31580	662611 30232*		662611 30241*
	180	100/400		662611 31579	662611 30231*		662611 30240*
	220	100/400		662611 31578	662611 30230*		662611 30239*
	320	100/400		662611 31575	662611 30227*		662611 30238*
	400	100/400		662611 31573	662611 30226*		
	600	100/400		662611 31571			
			6" x 6 Hole Die #3371	6" x 6 Hole Die #3371	6" x 6 Hole Die #3371	6" x 6 Hole Die #3371	
6	80	100/400	662611 40527*	662611 31600	666233 34786*	662611 30255*	
	100	100/400		662611 31599	666233 34787*		
	120	100/400		662611 31598	666233 34788*	662611 30253*	
	150	100/400		662611 31597			
	180	100/400		662611 31596	666233 34790*	662611 30251*	
	220	100/400		662611 31595	666233 34791*	662611 30250*	
	280	100/400		662611 31593			
	320	100/400		662611 31592	666233 34793*		
	400	100/400		662611 31590	666233 34794*		
	600	100/400		662611 31588	666233 34796*		
	800	100/400		662611 31587	666233 34797*		
	1000	100/400		662611 31586			
	1500	100/400		662611 31584			

Packaging Standards: * A975 Vacuum, A296 Vacuum, A290 Vacuum = 50/200

Refer to the Sanding Accessories section for back-up pads and accessories.



NEW

An alternative to traditional perforated paper discs, mesh discs are a multi-functional abrasive, designed with thousands of holes, created by the unique mesh matrix structure. For use with random orbital and rotary sanders, superior performing mesh discs are engineered for maximum dust extraction on composite, automotive, and other fine finishing applications. Norton mesh discs produce superior finishes with virtually dust free sanding.

Applications: Surface preparation, Sanding, Finishing

Size Range: 5", 6"

Grit Range: 80-400

Machine Used: 
ORBITAL SANDER

Powerful Dust Extraction Means a Cleaner, Safer Work Environment

We've answered the demands for a cleaner and safer working environment with Norton MeshPower discs. The open construction of the mesh backing allows dust particles to flow freely through the thousands of tiny holes, creating a virtually dust free sanding environment. Better for your health, better for your application and better for your business!

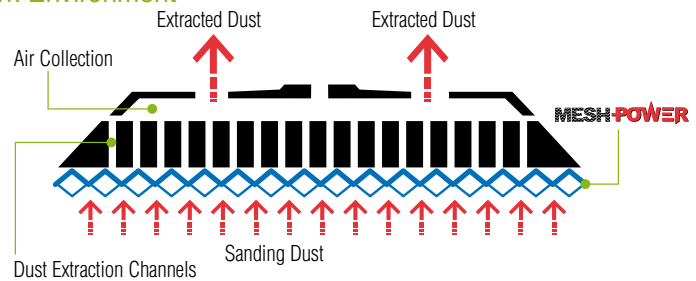

NEW

Good choice for sharp cutting along with powerful dust extraction

MESHPower ALUMINUM OXIDE

- Mesh matrix backing with thousands of tiny holes offers powerful dust extraction for a cleaner, healthier working environment
- Norton No-Fil technology prevents clogging and creates a consistent cut throughout the product life
- Self-grip backing with no designated hole pattern is quick and easy to align to any backing pad – just apply and go!

TIER: **GOOD**
TRADENAME: **MESHPower**
ABRASIVE: Aluminum Oxide

SIZE	GRIT	PKG./CASE	PART #
5	80	50/200	636425 06451
	120	50/200	636425 06452
	180	50/200	636425 06453
	220	50/200	636425 06454
	240	50/200	636425 06455
	320	50/200	636425 06456
6	400	50/200	636425 06457
	80	50/200	636425 06458
	120	50/200	636425 06459
	180	50/200	636425 06460
	220	50/200	636425 06461
	240	50/200	636425 06462
	320	50/200	636425 06463
	400	50/200	636425 06464

Contact your Norton representative for more information on additional grit sizes.

TECH TIP

Increase performance even further by using the Norton MeshPower discs with the Norton Multi-Air back-up pads - it's the ultimate dust extraction experience!

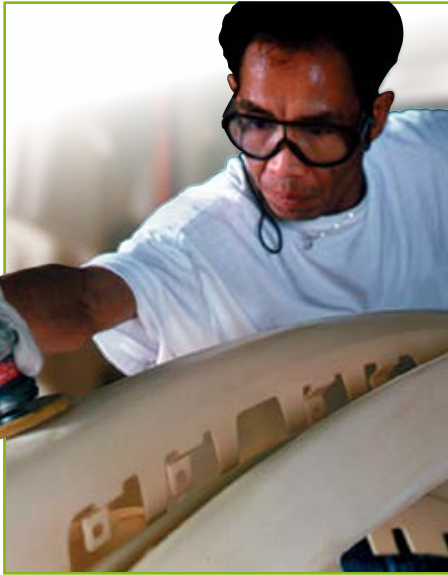

Finishing Film

For use on random orbital and rotary sanders. The industry's highest performing film and foam finishing discs are engineered for composite, automotive, and other fine finishing applications. Norton microfinishing film discs produce superior finishes dry without sacrificing cut rate while Norton foam finishing discs are used moist to produce a semi-polished surface to reduce buffing time.

Applications:

Film discs: final dry finishing of primed and painted surfaces, varnishes, composites, and gel coats before buffing

Foam finishing discs: final moist finishing of clear coat, varnishes, composites, and gel coats before buffing

Compounds and buffing pads: removes swirl marks and sand scratches

Size Range:

3", 5" and 6"

Grit Range:

Film Discs: P80-P1500

Foam Discs: P1500, P2000, P3000

Machine Used:



ORBITAL SANDER



VERTICAL SHAFT PORTABLE GRINDER



MINI ANGLE SANDER

Best choice for final dry finishing of primed and painted surfaces, varnishes, composites, and gel coats

PURE ICE Q175 A/O FINISHING FILM



- White aluminum oxide grain and patented resin system for better life, cut rate, and finish
- 3 mil polyester film backing for better flexibility and flatness of discs; hook and loop attachment for easy mounting and removal
- Color-coded backprint by grit size

Good choice for dry sanding applications, especially uneven, hard-to-sand surfaces

Q275 NO-FIL A/O FINISHING FILM



- Sharp, P-graded, heat-treated premium aluminum oxide grain ensures faster, yet cooler, cut for a longer life
- 3-mil polyester film backing delivers unmatched durability and tear strength with exceptional flatness for a flawless surface finish and reduced leveling and rework; hook and loop attachment for easy mounting and removal
- Water-based stearated No-Fil coating provides maximum load resistance when sanding dry for extended life

Finishing Foam

Best choice for moist finishing of clear coats, varnishes, composites, and gel coats



ICE Q255 A/O FINISHING FOAM

- Premium, P-graded fine grit aluminum oxide grain
- Conformable, integrated foam backing eliminates pigtailed and costly rework; produces a semi-polished finished that can be quickly buffed out; hook and loop attachment
- Open mesh design distributes pressure evenly for quicker sanding and uniform scratch patterns
- Color coded abrasive face by grit size for easy grit identification



TIER:	BEST	GOOD
TRADENAME:	PURE ICE Q175	Q275 NO-FIL
ABRASIVE:	Aluminum Oxide	Aluminum Oxide
BACKING WEIGHT:	3 mil Polyester Film	3 mil Polyester Film
OTHER:	P-Graded	P-Graded

TIER:	BEST
TRADENAME:	ICE Q255
ABRASIVE:	Aluminum Oxide
BACKING WEIGHT:	Foam
OTHER:	P-Graded

SIZE	GRIT	PKG./CASE	COLOR	PART #	PART #	PKG./CASE	COLOR	PART #
3	P800	50/200	Black	776960 88701				
	P1000	50/200	Red	776960 88702				
	P1200	50/200	Green	776960 88703				
	P1500	50/200	Blue	776960 88704		6/24	Blue	636425 06022
	P2000					6/24	Magenta	636425 06021
	P3000					6/24	Green	636425 06020
5	P80	50/200			662611 01614			
	P120	50/200			662611 01613			
	P180	50/200			662611 01610			
	P220	50/200			662611 01609			
	P240	50/200			662611 01608			
	P320	50/200			662611 01607			
	P400	50/200			662611 01606			
	P600	50/200			662611 01604			
	P1200	50/200			662611 01601			
6	P80	50/200			662611 01628			
	P120	50/200			662611 01627			
	P180	50/200			662611 01625			
	P220	50/200			662611 01624			
	P320	50/200			662611 01622			
	P800	50/200	Black	776960 88713	662611 01618			
	P1000	50/200	Red	776960 88714	662611 01617			
	P1200	50/200	Green	776960 88715	662611 01616			
	P1500	50/200	Blue	776960 88716	662611 01615	15/60	Blue	636425 06015
	P2000					15/60	Magenta	636425 06014
	P3000					15/60	Green	636425 06013

Refer to the Sanding Accessories section for back-up pads and accessories.

Multi-Air Foam Interface Pads

- Designed for use with fine grit Multi-Air Cyclonic hook and loop sanding discs to improve both surface finish and cut rate
- Use with Multi-Air hook and loop disc back-up pads
- Align the interface pad with the Multi-Air back up pad then simply attach the disc to the interface pad because the holes do not have to be lined up
- Ideal for use with new Mesh discs



SIZE (D x T)	DESCRIPTION	STD. PKG.	PART #
Multi-Air Foam Interface Pads with Vacuum Holes			
5 x 1/2	Multi-Air Hook & Loop Interface Pad	8	636425 85864
6 x 1/2	Multi-Air Hook & Loop Interface Pad	12	076607 19359

Multi-Air Hook & Loop Back-up Pads with Vacuum Holes

- Innovative design optimized for maximum air flow and powerful dust extraction
- Pads are engineered with a durable urethane foam, heat-resistant plastic, a molded-in 5/16"-24 spindle, and hooked face
- Holes in the disc do not have to be matched up with the holes in the pad, so changeover is fast and easy
- Ideal for use with new Mesh discs



SIZE (D)	DESCRIPTION	MAX. RPM	STD. PKG.	PART #
Multi-Air Hook & Loop Back-up Pads with Vacuum Holes				
5" (125mm) with 5/16"-24 Shank	Medium-Density Urethane Pad	15,000	5	666233 76000
6" (150mm) with 5/16"-24 Shank	Medium-Density Urethane Pad	15,000	5	636425 06160

Low-Profile Pads for Dual Action / Random Orbital Sanders

- Soft density low-profile pads utilize 1/2" thick foam for fine finish sanding and offer moderate conformability
- Medium low-profile pads have 1/2" thick urethane foam for intermediate and finish sanding
- Available with PSA (pressure sensitive adhesive) or hook and loop faces; both designs are shock resistant and have a fiberglass backing plate with a riveted 5/16"-24 threaded shank for added strength and increased heat resistance
- Available with standard hole patterns for vacuum-assist sanding



SIZE (D)	DESCRIPTION	MAX. RPM	STD. PKG.	PART #
Low Profile Pads for DA/Random Orbital Sanders				
3	Hook & Loop Soft Low-Profile	12,000	10	636425 06128
3-1/4	Hook & Loop Buffing Pad		5	662610 85302
5	PSA Soft Low-Profile	12,000	5	636425 06126
5	PSA Medium Low-Profile	15,000	5	636425 06131
5 x 5 holes	PSA Medium Low-Profile	15,000	5	636425 06132
5	Hook & Loop Soft Low-Profile	12,000	5	636425 06129
5	Hook & Loop Medium Low-Profile	15,000	5	636425 06135
5 x 5 holes	Hook & Loop Medium Low-Profile	15,000	5	636425 06136
6	PSA Soft Low-Profile	12,000	5	636425 06127
6	PSA Medium Low-Profile	15,000	5	636425 06133
6	Hook & Loop Soft Low-Profile	12,000	5	636425 06130
6	Hook & Loop Medium Low-Profile	15,000	5	636425 06137
6 x 6 holes	Hook & Loop Medium Low-Profile	15,000	5	636425 06138
8 x 8 holes, 5 screws	Hook & Loop Medium Low-Profile	1,500	5	636425 43712
8 x 8 holes, 6 screws	Hook & Loop Medium Low-Profile	1,500	5	636425 43714

Packed in individual clamshell

Tapered Pads for Dual Action / Random Orbital Sanders

- Designed with medium density polyurethane foam and a tapered edge for conformability, these pads are firm enough for flat surfaces, yet soft enough for severe curves and contours
- Available with either PSA (vinyl, pressure sensitive adhesive) or hook and loop faces in vacuum or non-vacuum
- The 5" and 6" pads are shock resistant and have a fiberglass backing plate with a riveted 5/16"-24 threaded shank for use on random orbital or dual action sanders
- The 8" pads have a 5/8"-11 threaded female hub



SIZE (D)	DESCRIPTION	MAX. RPM	STD. PKG.	PART #
Tapered Pads for DA/Random Orbital Sanders				
5	PSA Medium Tapered	15,000	5	636425 06139
5 x 5 holes	PSA Medium Tapered	15,000	5	636425 06140
5	Hook & Loop Medium Tapered	15,000	5	636425 06143
5 x 5 holes	Hook & Loop Medium Tapered	15,000	5	636425 06144
6	PSA Medium Tapered	15,000	5	636425 06141
6 x 6 holes	PSA Medium Tapered	15,000	5	636425 06142
6	Hook & Loop Medium Tapered	15,000	5	636425 06145
6 x 6 holes	Hook & Loop Medium Tapered	15,000	5	636425 06146
8	PSA Medium Tapered	6,000	5	636425 43112
8	Hook & Loop Medium Tapered	3,200	5	636425 43704

Packed in individual clamshell

Hook & Loop Foam Interface Pads

- Designed for use with our fine grit hook and loop sanding discs
- Improve both surface finish and cut rate
- Use with hook and loop back-up pads



SIZE (D x T)	DESCRIPTION	STD. PKG.	PART #
Foam Hook & Loop Interface Pads			
3 x 1/2	Interface Pad	10	636425 05457
6 x 1/2	Interface Pad	5	636425 42089
5 x 3.4	Interface Pad	2	636425 02161
6 x 3/4	Interface Pad	2	636425 02162

Half Moon Hand Pad

- The unique half moon pad takes a standard 5" hook and loop disc folded in half, which adheres to the hooks on the pad face
- The straight edge of the pad allows the operator to sand corners, contours, narrow crevices and minute imperfections without over-sanding



SIZE (D)	DESCRIPTION	STD. PKG.	PART #
Half Moon Hand Pad			
5	Hook & Loop	10	636425 02768

Polishing Adapter Pad

- Converts your standard hook and loop pad into a soft polishing pad
- The foam adapter is 3/8" thick and is excellent for fine grits where minimal removal is required
- It is ideal for either flat or contour surfaces



SIZE	DESCRIPTION	MAX. RPM	STD. PKG.	PART #
Polishing Adapter Pad				
5	Hook & Loop Adapter Pad	3,786	10	636425 03121

Ergonomic Hand Sanders

- The ergonomic palm sander is uniquely designed to be user-friendly, with finger indentations for the operator
- It quickly converts standard 5" and 6" hook and loop discs into hand sanders for finishing flat surfaces



SIZE (D)	DESCRIPTION	STD. PKG.	PART #
Ergonomic Hand Sander			
5	Hook & Loop	5	636425 03147
6	Hook & Loop	5	636425 03726

Disc Hand Pads

- Hand pads eliminate finger sanding
- The ultra-thin 3/16" thick pad is composed of a single layer of neoprene foam and is designed for maximum flexibility – producing excellent finishes
- The 1" thick pad is composed of two layers, neoprene and polyester foam, for excellent conformability and softness, resulting in fine finishes
- Each pad has an elastic hand strap to hold it firmly in place
- Available with either PSA (vinyl, pressure sensitive adhesive) faces or hook and loop face



SIZE (D x T)	DESCRIPTION	STD. PKG.	PART #
Disc Hand Pads			
5 x 3/16	Soft Foam PSA	10	636425 03111
5 x 1	Soft Foam PSA	10	636425 02842
5 x 1	Soft Foam Hook & Loop	10	636425 03117

Panel and Adhesive Cleaner

- Removes adhesives, tar, grease, wax, body sealers, undercoating sprays, and silicone from most surfaces
- Aggressive cleaner is safe to use on most paint applications
- Packaged with squirt dispenser
- Use as directed



SIZE/DESCRIPTION	STD. PKG.	PART #
Panel and Adhesive Cleaner		
Quart Can	12	076607 82780

Liquid Ice Extra-Cut Compound

- Water soluble; easy to use and easy to clean up
- Engineered to be used with a selection of 3 pads, depending on the finish required



SIZE	DESCRIPTION	STD. PKG.	STD. CASE	PART #
Quart	Liquid Ice Extra-Cut Compound	1	4	636425 97116

Liquid Ice Clean-up / Detailer Spray

- The spray detailer easily cleans up excess buffing residue and produces paint protection
- Spray it on and wipe off with a Norton Microfiber cloth ("Masking Products" section)



SIZE	DESCRIPTION	STD. PKG.	STD. CASE	PART #
32 oz.	Spray Bottle Clean-up Detailer	1	4	636425 42082

Liquid Ice Ultra-Fine Machine Glaze

- Use on its own for fine scratch removal or as Step 3 in place of Norton Liquid Ice Extra-Cut Compound to eliminate swirl marks and produce a high gloss finish
- Ideal for dark-colored vehicles



SIZE	DESCRIPTION	STD. PKG.	STD. CASE	PART #
Quart	Liquid Ice Ultra-Fine Machine Glaze	1	4	636425 06092

8" Hook & Loop Buffing/Polishing Waffle Pads

- These pads can be used with Norton Liquid Ice Extra-Cut Compound

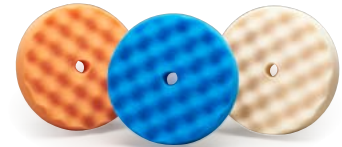

SIZE (D)	DESCRIPTION	STD. PKG.	STD. CASE	PART #
8	Orange Waffle Foam pad - Step 1	1	6	636425 06379
8	Blue Waffle Foam Pad - Step 2	1	6	636425 06380
8	White Waffle Foam Pad - Step 3	1	6	636425 06381

8" and 9" Hook & Loop Buffing/Polishing Pads

- These pads can be used with Norton Liquid Ice Extra-Cut Compound following the step numbers



SIZE (D)	DESCRIPTION	STD. PKG.	STD. CASE	PART #
8	Super Cut Wool Pad - Step 1	1	6	636425 42077
9	Blue Cutting Foam Pad - Step 2	1	6	636425 42078
9	White Finishing Foam Pad - Step 3	1	6	636425 42079

3" Hook & Loop Buffing/Polishing Pads

- For small spot repair



SIZE (D)	DESCRIPTION	STD. PKG.	STD. CASE	PART #
3	Super Cut Wool Pad - Step 1	10	40	636425 43832
3	Blue Cutting Foam Pad - Step 2	10	40	636425 05459
3	White Finishing Foam Pad - Step 3	10	40	636425 05460

Hook & Loop Back-up Pads for 8" and 9" Buffing Pads

- Black plastic back-up plate with hook and loop face. Molded-in 5/8"-11 threaded female hub



SIZE (D)	DESCRIPTION	STD. PKG.	STD. CASE	PART #
8 and 9	Hook & Loop Back-up Pad	1	3	636425 42080

Black Lambswool Hook & Loop Polishing Pads

- Distributing and applying material evenly and consistently, these dense, durable, lambswool pads are designed to repair clearcoat finishes



SIZE	DESCRIPTION	STD. CASE	PART #
3	Pad with Loop - 3/4" nap	40	636425 03670
4	Pad with Loop - 3/4" nap	250	636425 03671



Made from non-woven synthetic fiber mesh, which is impregnated with abrasives and bound with resins, non-woven wheels are designed to create desired surface finish where little or no stock removal is required. Non-woven wheels have an open mesh construction that is waterproof, washable, conformable and non-loading.

Non-Woven Convolute wheels are formed by wrapping and bonding web material impregnated with abrasive grain and resin around a center core.

Applications:

- Burr and flashing removal
- Surface roughness reduction
- Blending weld areas on stainless steel
- Blending scratch patterns
- Weld polishing
- Removing rust and oxides
- Applying decorative finishes including antique patterns

Abrasive Grain:

Aluminum Oxide, Silicon Carbide

Grit Range:

Medium (M), Fine (F), Very Fine (VF)

Machine Used:



BENCH GRINDER



PEDESTAL GRINDER

Application/Grit Recommendation Guide

NORTON	Rapid Finish GP Convolute Wheels	Metal Finishing Convolute Wheels	Clean & Finish Convolute Wheels	Light Finishing Convolute Wheels
Scale Removal				
Stock Removal	Second Choice			
Heavy Deburring	Second Choice			
Decorative Finishing		Best Choice	Second Choice	
Blending	Best Choice	Second Choice		
Cleaning		Second Choice	Best Choice	
Light Deburring	Second Choice			Best Choice
Light Finishing	Second Choice			Best Choice
Polishing				Best Choice
Buffing				

Surface Finish Variables

Changes in any one of many factors can affect the surface finish on the workpiece. This chart shows the effect on surface finish by changes in single factors of product specifications. Arrows have been used to signify the trend direction. The arrow length does not signify that the effect of each factor is equal.

Variable Factor	Rough Finish High RMS Reading	Smooth Surface Lower RMS Reading
1. Wheel Speed	Slow ←	→ Fast
2. Feed Speed	Faster (Long Scratch) ←	→ Slower (Short Scratch)
3. Oscillation	No Oscillation ←	→ Oscillation
4. Lubricants	Dry ←	→ Water ← Soluble Oil ← Straight Oil
		← Compounds →

Non-Woven Marking System

ABRASIVE	SILICON CARBIDE	ALUMINUM OXIDE		
	← SHARPER, FINER/BRIGHTER SCRATCH PATTERN	→ MORE DURABLE, LONGER LASTING, POLISHED FINISH		
GRIT SIZE	XC (50)	C (60-80)	M (100-150)	F (180-220)
	← FASTER, AGGRESSIVE CUT, ROUGHER FINISH	→ REDUCED CUT RATE, FINER FINISH		
DENSITY	2	9		
	← SOFT, OPEN, CONFORMABLE, LESS BURNING/LOADING	→ HARDER, MORE DURABLE, FASTER CUTTING, BETTER FINISH		

Cross Reference Guide

NORTON	BEST	BETTER	BETTER	GOOD	GOOD	GOOD
3M	Rapid Finish P 3M EXL, General Purpose	Series 1000 EXL Deburring	Metal Finishing Metal Finishing	Series 4000 EX2 & EX3	Light Finishing Light Deburring	Clean & Finish Multi Finishing
Standard	General Purpose Plus, Light Deburring	Deburring Convolute	Metal Finishing	GP Plus	LDW	Multi Finishing

Aggressive Deburring

Good choice for heavy deburring applications



SERIES 4000 ALUMINUM OXIDE & SILICON CARBIDE

- High-quality synthetic web provides long life for heavy deburring, edge-breaking, and parting line removal on exotic metals
- Advanced resin bond system ensures free cutting action
- Use both wet and dry

TIER: **GOOD**
TRADENAME: **SERIES 4000**

SIZE (D x T x H)	ABRASIVE	GRIT	MAX. RPM	STD. PKG.	8 DENSITY PART #	9 DENSITY PART #
6 x 1/2 x 1	S/C	F	6,000	4		6626100 4021
6 x 1 x 1	A/O	M	6,000	3	6626100 4208	
	S/C	F	6,000	3	6626100 4142	6626100 4141
8 x 1 x 3	A/O	M	4,500	3	6626100 4165	
	S/C	F	4,500	3	6626100 4123	6626100 4135
12 x 1 x 5	S/C	F	3,000	2	6626100 4284	6626100 4148
12 x 2 x 5	S/C	F	3,000	1		6626100 4011

General Duty



Best choice for broad range of applications: general deburring, blending, and finishing on all materials including metals, wood, glass

RAPID FINISH GENERAL PURPOSE A/O & S/C

- Eliminate smearing and loading on a wide range of workpieces (from high-nickel-content alloys to aluminum and other soft metals with patent-pending Norton Clean Bond resin technology)
- Increase throughput with a 30% faster finish through new Norton grain/bond configuration, decrease wheel changes with a 10-30% longer life, provided by a new fiber and the high-temperature resin bond
- Ease wheel selection with color-coding wheel to match the primary use (maroon for General Purpose), and fiberglass core to match the abrasive (black for silicon carbide and white for aluminum oxide)

TIER: **BEST**
TRADENAME: **RAPID FINISH GENERAL PURPOSE**

SIZE (D x T x H)	ABRASIVE	GRIT	MAX. RPM	STD. PKG.	PRODUCT CODE	6 DENSITY PART #	7 DENSITY PART #	8 DENSITY PART #	9 DENSITY PART #
6 x 1/2 x 1	A/O	M	6,000	4	C2315		662611 34177	662611 34178	662611 34179
	S/C	M	6,000	4	C4315				662611 08076
	S/C	F	6,000	4	C4415		662611 33213	662611 06732	662611 12985
6 x 1 x 1	A/O	M	6,000	3	C2315	662611 34180	662611 34181	662611 34182	662611 34183
	A/O	F	6,000	3	C2408	662611 32100	662611 32322	662611 32324	
	S/C	M	6,000	3	C4315		662611 08074	662611 33215	662611 08075
	S/C	F	6,000	3	C4415	662611 14475	662611 19988	636425 77269	636425 81587
	S/C	VF	6,000	3	C4515	662611 31970			
	S/C	M	6,000	2	C2315		662611 34184		
6 x 2 x 1	S/C	M	6,000	2	C4315		662611 14471		
	S/C	F	6,000	2	C4415		662611 32325		
	S/C	M	4,500	3	C4315		662611 08066	662611 08069	
8 x 1 x 3	S/C	F	4,500	3	C4415	662611 08064	662611 08065	636425 53754	636425 76004
	S/C	VF	4,500	3	C4515				662611 33209
	S/C	M	4,500	2	C4315		662611 14473		
8 x 2 x 3	S/C	F	4,500	2	C4415		662611 14480	662611 14483	662611 14486
	S/C	VF	4,500	2	C4515				662611 33210
	S/C	M	3,600	3	C2315		662611 34185		
10 x 1 x 5	S/C	F	3,600	3	C4415			662611 06554	662611 14488
	S/C	F	3,600	1	C4415			636425 81044	662611 14489
12 x 1 x 5	A/O	M	3,000	2	C2315				662611 34186
	S/C	F	3,000	2	C4415	662611 08053	662611 14481	662611 14484	662611 14074
	S/C	VF	3,000	2	C4515				662611 34187
12 x 2 x 5	S/C	F	3,000	1	C4415		662611 14482	662611 12766	662611 14490

General Duty *continued*

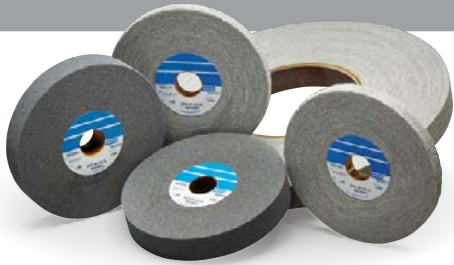

Better choice for general deburring, blending, and final finishing

SERIES 1000 LONG LIFE A/O & S/C

- Offered in variety of web densities: more open, cool-cutting 7 density for light deburring, 8 to 9 density a good starting point for deburring, blending, polishing, and finishing
- Smear- and heat-free resin bond guarantees consistent, high-quality results; uniform grain dispersion and coating clean and condition without gouging or changing dimensions of workpiece
- Conformable and flexible for less operator fatigue

TIER: **BETTER**
TRADENAME: **SERIES 1000 LONG LIFE**

SIZE (D x T x H)	ABRASIVE	GRIT	MAX. RPM	STD. PKG.	7 DENSITY PART #	8 DENSITY PART #	9 DENSITY PART #
6 x 1/2 x 1	A/O	M	6,000	4	662610 18857		662610 18650
	S/C	M	6,000	4			662610 19540
	S/C	F	6,000	4	662610 18628		662610 18629
6 x 1 x 1	A/O	M	6,000	3	699573 97884	662610 18636	662610 19337
	S/C	M	6,000	3	699573 97882	699573 97883	662610 18630
	S/C	F	6,000	3	662610 18631	662610 18774	662610 18632
8 x 1 x 3	A/O	M	4,500	3	699573 97885	662610 18855	662610 18633
	S/C	M	4,500	3	699573 94610	662610 18673	662610 18997
	S/C	F	4,500	3	662610 18639	662610 18640	662610 18641
12 x 1 x 5	A/O	M	3,000	2	699573 97887		662610 18896
	S/C	M	3,000	2		662610 18786	662610 18908
	S/C	F	3,000	2			662610 18626

Aesthetic Finishing



Better choice for decorative finishing, blending, and final finishing

METAL FINISHING ALUMINUM OXIDE

- Premium, medium grit aluminum oxide grain generates uniform distinct satin and antique finishes
- Dense, very durable web allows these wheels to be used for blending applications; strong resin binder provides resiliency and long life
- Uniform grain dispersion and coating clean and condition without gouging or changing dimensions of workpiece

TIER: **BETTER**
TRADENAME: **METAL FINISHING**

SIZE (D x T x H)	ABRASIVE	GRIT	DENSITY	MAX. RPM	STD. PKG.	PART #
6 x 1 x 1	A/O	M	5	6,000	3	662610 07936
	A/O	M	6	6,000	3	662610 10148
6 x 2 x 1	A/O	M	5	6,000	2	662610 07957
	A/O	M	6	6,000	2	662610 09635
8 x 1 x 3	A/O	M	5	4,500	3	662610 07831
8 x 2 x 3	A/O	M	5	4,500	2	662610 07904
	A/O	M	6	4,500	2	662610 12971
12 x 1 x 5	A/O	M	5	3,000	2	662610 07434
	A/O	M	6	3,000	2	662610 09481
12 x 2 x 5	A/O	M	5	3,000	1	662610 07212
14 x 2 x 8	A/O	M	5	2,550	1	662610 07817

Aesthetic Finishing *continued*

Good choice for light deburring, polishing, and fine finishing applications



LIGHT FINISHING SILICON CARBIDE

- Advanced manufacturing process produces a consistent web and grain distribution for a consistent finish on intricate polishing applications
- Superior form holding for consistent, reliable edge breaking and finishing with minimal wheel dressing and reshaping; less dust and shedding with more uniform wear
- Controlled cut rate prevents “over benching”, deburrs and polishes without altering geometry

TIER: **GOOD**

TRADENAME: **LIGHT FINISHING**

SIZE (D x T x H)	ABRASIVE	GRIT	MAX. RPM	6 DENSITY PART #	7 DENSITY PART #	8 DENSITY PART #
6 x 1/2 x 1	S/C	F	6,000	662610 92322	662610 92324	662544 21572
6 x 1 x 1	S/C	F	6,000	662544 03708	662544 03709	662544 21573
8 x 1/2 x 3	S/C	F	4,500	662544 03707	662544 09698	662544 21575
8 x 1 x 3	S/C	F	4,500	662610 95702	662544 09924	662544 21577

All Light Finishing convolute wheels are non-stock. Ask your Norton representative for current lead-times and order quantities.

Good choice for fine finishing with light pressure



CLEAN & FINISH SILICON CARBIDE

- Sharp, more aggressive silicon carbide abrasive leaves a fine/brighter scratch pattern
- Conformable to intricate shapes and contours without changing the workpiece dimension
- Open web construction makes these ideal for low-to moderate-pressure, low speed applications

TIER: **GOOD**

TRADENAME: **CLEAN & FINISH**

SIZE (D x T x H)	ABRASIVE	GRIT	DENSITY	MAX. RPM	STD. PKG.	PART #
4 x 1 x 1	S/C	M	4	4,000	10	662610 58502
		F	4	4,000	10	662610 58501
6 x 1 x 1	S/C	M	4	3,000	4	662610 58507
		F	4	3,000	4	662610 58506
6 x 2 x 1	S/C	M	4	3,000	2	662610 58510
		F	4	3,000	2	662610 58509
6 x 3 x 1	S/C	M	4	3,000	1	662610 58512
6 x 4 x 1	S/C	M	4	3,000	1	662610 58514
8 x 1 x 3	S/C	M	4	2,500	3	662610 58518
8 x 2 x 3	S/C	M	4	2,500	2	662610 58521
8 x 3 x 3	S/C	M	4	2,500	1	662610 58524
8 x 4 x 3	S/C	M	4	2,500	1	662610 58526

Aluminum Reducing Bushings for Flap and Convolute Wheels



- Durable, aluminum one-piece-design flanges with integrated contact washer
- Snug fit; extended usable life
- Available in stock and non-stock sizes in many combinations of ID hole reduction

WHEEL CENTER HOLE	BUSHING REDUCES HOLE SIZE TO	FOR WHEEL DIAMETER	STD. PKG.	PART #
1	3/8	4 - 6	1 Pair	662610 80522
	1/2	4 - 6	1 Pair	662610 80523
	5/8	4 - 6	1 Pair	662610 80524
	3/4	4 - 6	1 Pair	662610 80525
	7/8	4 - 6	1 Pair	662610 80526
2	1/2	6	1 Pair	662610 80527
	5/8	6	1 Pair	662610 80528
3	1	6	1 Pair	662610 80529
	1	8	1 Pair	662610 80531
	1-1/4	8	1 Pair	662610 80532
5	1	10 and 12	1 Pair	662610 80533
	1-1/4	10 and 12	1 Pair	662610 80534
	3	10 and 12	1 Pair	662610 80535
8	1-1/4	14	1 Pair	662610 80536

TECH TIP

- Convolute wheels must always run in the direction indicated by the arrow printed on the side of each wheel.
- Light to medium pressure is recommended. Excessive pressure may result in part damage.
- Lubricants such as water-soluble oil and straight oil will decrease the heat and improve the surface finish and lustre.



It is the user's responsibility to refer to and comply with ANSI B7.1



Portable file belt sanders have replaced tedious hand filing and sanding. First introduced in pneumatic, they are now also available in electric. Increasingly, tool manufacturers are introducing additional fixtures for additional applications. The belts listed are popular stock sizes, but additional sizes, specifications, backing materials, and edge scallops are available made-to-order.

Applications:

Light weld removal and blending, shape and contour sanding, surface preparation prior to coating and plating, removing cutting tool marks from molds and dies, general clean-up and finishing

Size Range:

1/8" to 1" wide, 12" to 30" long

Grit Range:

40 – 120

Abrasive Grain:

Ceramic Alumina, Zirconia Alumina, Aluminum Oxide

Machine Used:



PORTABLE FILE BELT SANDER

Cross Reference Guide

	BEST	BEST	BETTER	GOOD	GOOD
NORTON	Blaze R980P	RedHeat R983	BlueFire R887D/R823P	Gemini R766	Gemini R283
3M	963G/H, 966F, 967F, 997F, 984F, 784F, 947A	747D, 777F, 778F, 784F, 987F, 977F	577F, 551E	361F, 363F	241E, 244E, 251E, 261E
Hermes	CR456	—	RB48624YX, RB48644Z	RB377XY, SB378	RB530J, RB304J, RB306J
Klingspor	CS610	CS912	CS411X, CS416, CS409	CS412, CS413	CS412
SIA	2515, 2503	—	2800,2803, 2815, 2829, 2824	—	—
VSM	XK875X, XK885Y, XK880Y	XK870X, XK870X	ZK713X, ZK713T, KK715X	LK719X, KK711X	KK711E
Sait	—	—	AZ-X	1AX, 2AX	LA-X
Sunmght	—	—	—	P656W	—

Material-to-Product Recommendation Guide

	BEST	BEST	BETTER	GOOD	GOOD	
	Blaze R980P	RedHeat R983	BlueFire R887D	BlueFire R823P	Gemini R766	Gemini R283
Carbon Steel	◆	◆	◆	◆	◆	◆
Stainless Steel / Alloys	◆	◆	◆	◆	◆	◆
Cast Iron	◆	◆	◆	◆	◆	◆
Brass / Bronze	◆	◆	◆	◆	◆	◆
Aluminum	◆	◆	◆	◆	◆	◆



Best for stainless, cobalt, chrome, inconel, titanium, mild and carbon steel

BLAZE R980P CERAMIC ALUMINA

- Next-generation cooler cutting Norton SG ceramic alumina grain lasts 50% to 200% longer on mild and carbon steel, stainless, cobalt, chrome, inconel and titanium with better metal integrity
- Durable Y-weight polyester, waterproof cloth backing for improved grain adhesion, reduced edge-fray, and better body retention, resulting in longer life and product consistency
- Lubricating grinding aid coating means cooler cut, burn-free grinding of heat-sensitive materials, minimized loading, and improved part finish and integrity



Exceptional performance, especially on hard-to-grind alloys

REDHEAT R983 CERAMIC ALUMINA

- Premium ceramic abrasive provides sharp cutting, exceptional life and value, especially on hard-to-grind alloys
- "Supersize" grinding-aid for longer life, cooler cut and minimized loading
- Strong Y-weight polyester, waterproof cloth backing for improved grain adhesion, reduced edge-fray and better body retention, resulting in longer life and product consistency

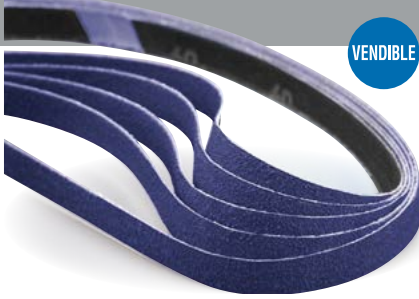

VENDIBLE

Better choice for stainless and carbon steel

BLUEFIRE R887D/R823P ZIRCONIA ALUMINA

- Strong, self-sharpening zirconia alumina abrasive for fast, aggressive cut and 30% longer life than competitive zirconia belts
- Durable resin bond for excellent grain retention and product life
- Strong Y-weight polyester backing - R887D for heavy-duty stock removal applications; flexible X-weight polyester backing - R823P for moderate- to light-pressure applications



Good choice for difficult-to-grind materials (aluminum, brass, bronze, stainless, carbon steel, titanium, etc.)

GEMINI R766 ALUMINUM OXIDE

- Premium aluminum oxide abrasive blend is ideal when primary purchasing criteria is a good-performing, economically-priced, general-purpose belt
- Y-weight waterproof polyester backing withstands light- to moderately-demanding applications and provides extended life on dry grinding applications
- Resin bond system provides improved edge retention and 30% plus improvement in life versus key competitors



Good choice for stainless and carbon steel applications when initial price is the primary purchasing factor

GEMINI R283 ALUMINUM OXIDE

- P-graded premium aluminum oxide abrasive for consistent, cool cut
- Strong, semi-flexible, smooth X-weight rayon waterproof backing is designed for light- to moderate- pressure applications
- Durable resin coating provides excellent grain retention and product life



TIER:	BEST	BEST	BETTER	GOOD	GOOD
TRADENAME:	BLAZE R980P	REDHEAT R983	BLUEFIRE R887D/R823P	GEMINI R766	GEMINI R283
ABRASIVE:	Ceramic Alumina	Ceramic Alumina	Zirconia Alumina	Aluminum Oxide Blend	Aluminum Oxide
BACKING:	Y-Weight Polyester	Y-Weight Polyester	Y- or X-Weight Polyester	Y-Weight Polyester	X-Weight Rayon
OTHER:	Supersize	Supersize			

SIZE (W x L)	GRIT	STD. PKG.	PART #	PART #	PART #	PART #	PART #	
12" Belts								
1/8 x 12	40	50				666233	90000	
	60	50	662544	05345	662544	91522	662610	93029
	80	50			662544	91523		
	120	50	662544	91519	662544	91524		
1/4 x 12	40	50	662544	91520			666233	90003
	60	50	662611	96480		780727	58896	
	80	50			662544	91526	780727	82621
	120	50	662610	63632	662544	91527	780727	82622
1/2 x 12	40	50	699573	98018	662544	91528	662544	92522
	50	50	662610	43759	780727	18700	666233	90006
	60	50	699573	98019	780727	18701	780727	28745
	60	25 V					666233	90008
	80	50	699573	98020	780727	18702	780727	28744
	80	25 V					666233	73754
	100	50	662610	1081180	662544	91529	662544	91534
	120	50	662610	42909	780727	00518	780727	28742
1 x 12	60	50	662610	63641			666233	73755
						780727	53073	780727

Additional sizes, grits and scalloped edge belts are available MTO (made-to-order). Contact your Norton representative for availability, order quantities and lead-times.

40 and 50 grit BlueFire belts are furnished in BlueFire R887D (Y-weight Polyester); 60-120 grits are supplied in BlueFire R823P (X-weight Polyester).

Joints - All belts are PG jointed; a butt joint joined with flexible tape for contour grinding.

V = Vendible package. Ideal for vending machines and small jobs. 5 belts per pack / 5 packs per carton. Order in multiples of 25.

continued



TIER:	BEST	BEST	BETTER	GOOD	GOOD
TRADENAME:	BLAZE R980P	REDHEAT R983	BLUEFIRE R887D/R823P	GEMINI R766	GEMINI R283
ABRASIVE:	Ceramic Alumina	Ceramic Alumina	Zirconia Alumina	Aluminum Oxide Blend	Aluminum Oxide
BACKING:	Y-Weight Polyester	Y-Weight Polyester	Y- or X-Weight Polyester	Y-Weight Polyester	X-Weight Rayon
OTHER:	Supersize	Supersize			

SIZE (W x L)	GRIT	STD. PKG.	PART #	PART #	PART #	PART #	PART #
13" Belts							
3/8 x 13	60	50	699573 45359	780727 45459	780727 40295	666233 90011	780727 32112
	80	50	699573 92150	780727 74916	780727 36062	666233 90012	780727 71323
18" Belts							
1/8 x 18	40	50	662544 75211		662544 91535	666233 90014	
	60	50	662610 80010		780727 60595	666233 90015	
	80	50	662610 89120	780727 89083	780727 60595		
	120	50	662544 75215	780727 89084	636425 95221		
1/4 x 18	40	50	662610 27923	662611 98953	662544 92525	666233 90016	662544 91543
	60	50	699573 47249	780727 74684	780727 43583	666233 90017	780727 71000
	60	25 V			666233 73747		
	80	50	699573 46155	780727 03284	780727 53075		780727 73921
	80	25 V			666233 73748		
	120	50	662610 85071	780727 85655	780727 73764		
1/2 x 18	40	50	699573 98021	780727 66018	662544 44193	666233 90019	780727 27561
	60	50	699573 98022	780727 18704	780727 28569	666233 90020	780727 27560
	60	25 V			666233 73756		
	80	50	699573 98023	780727 18705	780727 28568	666233 90021	780727 27559
	80	25 V			666233 73757		
	120	50	662610 41384	780727 18706	780727 28567		780727 27558
3/4 x 18	40	50	699573 98027	780727 62476	662544 92526	666233 90022	780727 81797
	60	50	699573 98028	780727 45691	780727 09590	666233 90023	780727 39966
	60	25 V			666233 73762		
	80	50	699573 98029	780727 56309	780727 58953	666233 90024	780727 32289
	80	25 V			666233 73763		
	120	25 V			666233 73764		
20-1/2" Belts							
3/4 x 20-1/2	40	50	699573 98030	780727 14398	662544 57869	666233 90025	780727 27573
	50	50	699573 44982	780727 18714	662544 92527	666233 90026	662544 91544
	60	50	699573 98031	780727 18715	780727 28560	666233 90027	780727 27571
	60	25 V			666233 73765		
	80	50	699573 98032	780727 18716	780727 28559	666233 90028	780727 27570
	80	25 V			666233 73766		
	100	50	662610 55516	780727 71151	662610 38911		780727 27569
	120	50	662610 44755	780727 27380	780727 28557		780727 27575
24" Belts							
1/4 x 24	40	50	662611 98631	780727 47823	662544 73499		662544 01929
	60	50	699573 45451	780727 56534	780727 28552	666233 90030	780727 27548
	60	25 V			666233 73750		
	80	50	636425 96940	780727 18340	780727 67713		
1/2 x 24	120	50	662610 80367	780727 70718	780727 28550		
	40	50	699573 98024	780727 60092	662544 92528	666233 90032	780727 27568
	50	50	662610 43757	780727 18707	662544 52237	666233 46910	780727 27567
	60	50	699573 98025	780727 18708	780727 28564	666233 90033	780727 27566
	60	25 V			666233 73759		
	80	50	699573 98026	780727 18709	780727 28566	666233 90034	780727 27565
	80	25 V			666233 73760		
	100	50	662610 42203	780727 45021	780727 53076		662544 91545
120	50	662610 42565	780727 18710	780727 28565		780727 27564	
1 x 24	40	50	699573 50019	662544 91531			
	50	50	699573 44889	780727 10374			662544 91547
	60	50	699573 53375				
	80	50	699573 45419	780727 72209	780727 76498	666233 34206	662610 85068
120	50	662610 85067	662544 91532	780727 30029		662610 85069	
30" Belts							
1 x 30	40	50	662610 53470		662544 78257	666233 90038	662611 89958
	60	50	699573 45985		780727 28583	666233 90039	662544 91549
	80	50	699573 46105	780727 64439	780727 28582	666233 90040	780727 27579
	120	50	662611 93676	780727 81197	780727 66992		780727 27577

Additional sizes, grits and scalloped edge belts are available MTO (made-to-order). Contact your Norton representative for availability, order quantities and lead-times.
40 and 50 grit BlueFire belts are furnished in BlueFire R887D (Y-weight Polyester); 60-120 grits are supplied in BlueFire R823P (X-weight Polyester).

Joints - All belts are PG jointed; a butt joint joined with flexible tape for contour grinding.

V = Vendible package. Ideal for vending machines and small jobs. 5 belts per pack / 5 packs per carton. Order in multiples of 25.



Portable belts are ideal for all your metal and woodworking applications. Choose 36 – 50 grits for rough/heavy-duty applications, 60 – 100 for intermediate, and 100 – 220 for finishing/polishing applications.

The belts listed are popular stock sizes, but additional sizes, specifications, and backing materials, are available made-to-order.

Applications:

Grinding and finishing all metals, blending welds, sanding and finishing wood, glass seaming, and polishing

Size Range:

3" to 4" wide, 15-1/2" to 24" long

Grit Range:

36 – 220

Abrasive Grain:

Ceramic Alumina, Zirconia Alumina, Aluminum Oxide

Machine used:



BELT SANDER



IN-LINE DRUM SANDER

Cross Reference Guide

NORTON	BEST RedHeat R983	BETTER BlueFire R831	GOOD Gemini R215/ Metalite R255
3M	747D, 777F, 778F, 784F, 987F, 977F	577F	240DZ, 340A, 340D
Hermes	—	RB480	RB320
Klingspor	CS912	CS411	LS309XH
Sait	—	Z-H	1A-X, 2A-X, AO-X, LA-X
SIA	—	2800, 2829, 2925	2920, 2928, 2921, 2951, 2925
VSM	XK870X, XK870X	ZK713X	KK504X, KP510E

Material-to-Product Recommendation Guide

	BEST RedHeat R983	BETTER Bluefire R831	GOOD Gemini R215	Metalite R255
Wood		◆	◆	◆
Carbon Steel / Stainless Steel	◆	◆		
Brass / Bronze / Aluminum		◆	◆	◆

Exceptional performance, especially on hard-to-grind alloys



REDHEAT R983 CERAMIC ALUMINA

- Premium ceramic abrasive provides sharp cutting, exceptional life and value, especially on hard-to-grind alloys
- "Supersize" grinding-aid for longer life, cooler cut and minimized loading
- Strong Y-weight polyester, waterproof cloth backing for improved grain adhesion, reduced edge-fray and better body retention, resulting in longer life and product consistency

Better choice for stainless steel and wood

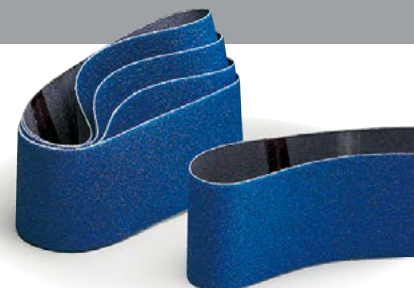

BLUEFIRE R831 ZIRCONIA ALUMINA

- Premium, self-sharpening zirconia alumina abrasive provides superior cut on all surfaces, lasts substantially longer, and cuts faster than the next leading competitor in side-by-side comparisons
- Proprietary patented grain technology produces one of the finest scratch patterns in the industry for finer looking finish; open-coat design and strong Y-weight cotton backing for reduced loading and extended life
- Reversible butt splice allows belt to be used in either direction for longer life

Good choice to minimize loading on wood and soft metals - where initial price is the main concern



GEMINI R215 / METALITE R255 ALUMINUM OXIDE

- Premium aluminum oxide abrasive for fast initial cut rate
- Heavy, durable X-weight cotton backing is ideal for heat sensitive applications
- Strong butt joint that allows the belt to be run in either direction

Portable Belts for Belt Sanders



TIER:	BETTER	GOOD
TRADENAME:	BLUEFIRE R831	GEMINI R215
ABRASIVE:	Zirconia Alumina	Aluminum Oxide
BACKING:	Y-Weight Cotton	X-Weight Cotton
JOINT:	Plyweld	Plyweld
GRAIN COATING:	Open Coat	Open Coat
OTHER:		



GOOD	GOOD
GEMINI R215	METALITE R255
Aluminum Oxide	Aluminum Oxide
X-Weight Cotton	X-Weight Cotton
Plyweld	Plyweld
Open Coat	Open Coat
	UPC Bar Coded

SIZE (W x L)	GRIT	PKG./CASE	PART #	PART #	STD. PKG.	PART #	PART #
3 x 18	36				5		780727 80447
	50	5/25*	076607 49259	076607 00964	10		780727 27994
	80	5/25*	076607 49258	076607 00968	10		780727 27993
	120	5/25*	076607 49256	076607 00969	10		780727 27992
3 x 21	36	5/25*	076607 49266	076607 01741			
	40				10		780727 27927
	50	5/25*	076607 49265	076607 01740	10		780727 27926
	60				10	780727 27925	
	80	5/25*	076607 49264	076607 02064	10		780727 27924
	100	5/25*	076607 49263		10		780727 27923
	120	5/25*	076607 49262	076607 02062	10		780727 27922
	220	5/25*		076607 05287			
3 x 24	36	5/25*	076607 49272	076607 01743	5		780727 81847
	40				10		780727 27937
	50	5/25*	076607 49271	076607 01742	10		780727 27936
	60				10	780727 27935	
	80	5/25*		076607 02067	10		780727 27934
	100	5/25*	076607 49269	076607 02066	10		780727 27933
	120	5/25*	076607 49268	076607 02065	10		780727 27932
4 x 24	36	5/25*	076607 49278	076607 01745	5		780727 80438
	40				10		780727 27947
	50	5/25*	076607 49277	076607 01744	10		780727 27946
	60				10	780727 27945	
	80	5/25*	076607 49276	076607 02069	10		780727 27944
	100	5/25*			10		780727 27943
	120	5/25*	076607 49274	076607 02068	10		780727 27942
	180	5/25*		076607 05285			

*Job Pack packing standards: 5 belts/Job Pack; 5 Job Packs per case. Order by number of packs, in multiples of 5 packs.

Portable Belts for Pneumatic In-Line Drum Sanders

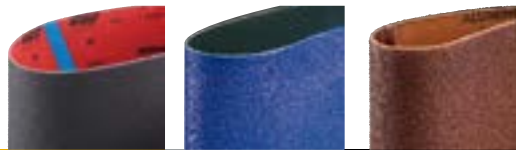

TIER:	BEST	BETTER	GOOD
TRADENAME:	REDHEAT R983	BLUEFIRE R823P	GEMINI R215
ABRASIVE:	Ceramic Alumina	Zirconia Alumina	Aluminum Oxide
BACKING:	Y-Weight Polyester	X-Weight Polyester	X-Weight Cotton
JOINT:	Plyweld	Plyweld	Plyweld
GRAIN COATING:	Closed Coat/Supersize	Closed Coat	Open Coat

SIZE (W x L)	GRIT	STD. PKG.	PART #	PART #	PART #
3-1/2 x 15-1/2	36	10	780727 00783		780727 21997
	60	10	780727 18750		780727 22000
	80	10	780727 18751	780727 53074	780727 21995
	120	10	780727 18753		



A broad selection of sizes and grits for most dimensioning, intermediate grinding and polishing applications.

The belts listed are popular stock sizes, but additional sizes, specifications, and backing materials, are available made-to-order.

Applications:

Benchstand and Backstand Belts: grinding and deburring of all metals, heavy stock removal, blending, dimensioning and shaping, polishing.

Centerless, Conveyor and Platen Belts: intermediate grinding stainless and carbon, moderate-pressure applications, dimensioning and finishing.

Size Range:

1" to 10" wide, 36" to 132" long

Grit Range:

24 – 320

Abrasive Grain:

Ceramic Alumina, Zirconia Alumina, Aluminum Oxide

Machine Used:



BACKSTAND
BELT GRINDER



BENCHSTAND
GRINDER

Cross Reference Guide

	BEST	BEST	BETTER	BETTER	BETTER	GOOD	GOOD
NORTON	Blaze R980P	RedHeat R983	BlueFire R821P	BlueFire R823P	BlueFire R884P	Gemini R766	Gemini R228
3M	963G/H, 966F, 967F, 997F, 984F, 784F, 947A	747D, 777F, 778F, 784F, 987F, 977F	—	551E	561D	361F, 363F	241D, 251D, 341D
Hermes	CR454, CR456	CN464	—	RB486 X, RB346, RB486	RB48024YX, RB48444Z, RB485Z	RB377XY, SB378, RB34MJ	RB320X, HSB
Klingspor	CS610	CS912	CS411X	CS411X, CS416	CS411	CS412, CS413	CS310
SIA	2515, 2503	—	—	—	2820	—	2918, 2928
VSM	XK875X, XK885Y, XK880Y	XK870X, XK870X	—	ZK713X, KK715X	KK716, ZK713T	LK719X, KK711X	KK511X, KK711

Material-to-Product Recommendation Guide

	BEST	BETTER	BETTER	BETTER	GOOD	GOOD
	Blaze R980P	BlueFire R884P	BlueFire R823P	BlueFire 821P	Gemini R766	Gemini R228
Aluminum		◆	◆		◆	
Cast Iron	◆		◆		◆	
Brass / Bronze		◆	◆		◆	
Die Castings	◆		◆		◆	
Carbon Steel	◆		◆		◆	◆
Glass / Ceramics	◆			◆	◆	
Stainless Steel and Alloys	◆	◆	◆		◆	
Wood		◆			◆	

Grit Selection Recommendation Guide

STOCK REMOVAL	INTERMEDIATE	FINISHING
24 – 50 grit	60 – 100 grit	120 – 320 grit

TECH TIP

Troubleshooting Guide

Problem	Correction	Problem	Correction
Loading	Decrease infeed pressure or belt speed	Belt breakage	Reduce belt tension
Shedding	Reduce applied pressure		Use less aggressive contact wheel
	Use a less aggressive contact wheel		Check tracking mechanism for belts tracking erratically
	Dress contact wheel if worn or damaged		
	Use entire surface of belt		



Best for mild and carbon steel, stainless, cobalt, chrome, inconel, titanium

BLAZE R980P CERAMIC ALUMINA

- Next-generation cooler cutting Norton SG ceramic alumina grain lasts 50% to 200% longer on mild and carbon steel, stainless, cobalt, chrome, inconel and titanium with better metal integrity
- Durable Y-weight polyester, waterproof cloth backing for improved grain adhesion, reduced edge-fray, and better body retention, resulting in longer life and product consistency
- Lubricating grinding aid coating means cooler cut, burn-free grinding of heat-sensitive materials, minimized loading, and improved part finish and integrity



Exceptional performance, especially on hard-to-grind alloys

REDHEAT R983 CERAMIC ALUMINA

- Premium ceramic abrasive provides sharp cutting, exceptional life and value, especially on hard-to-grind alloys
- "Supersize" grinding-aid for longer life, cooler cut and minimized loading
- Strong Y-weight polyester, waterproof cloth backing for improved grain adhesion, reduced edge-fray and better body retention, resulting in longer life and product consistency



Better choice for heaviest-pressure applications

BLUEFIRE R821P/R823P/R884P ZIRCONIA ALUMINA

- Strong, self-sharpening zirconia alumina abrasive for fast, aggressive cut and 30% longer life than competitive zirconia belts
- Durable resin bond for excellent grain retention and product life
- R821P Y-weight cotton backing provides durability and even wear on coarser grit stock removal applications;
- R823 has flexible X-weight polyester waterproof backing to excel on light- to moderate-pressure, applications
- R884P has a durable Y-weight polyester waterproof cloth backing that excels on medium- to high pressure applications



Good choice for difficult-to-grind materials (aluminum, brass, bronze, stainless, carbon steel, titanium, etc.)

GEMINI R766 ALUMINUM OXIDE

- Premium aluminum oxide abrasive blend is ideal when primary purchasing criteria is a good-performing, economically-priced, general-purpose belt
- Y-weight waterproof polyester backing withstands light- to moderately-demanding applications and provides extended life on dry grinding applications
- Resin bond system provides improved edge retention and 30% plus improvement in life versus key competitors



Good choice for fine grit metalworking blending and polishing where initial price is the main concern

GEMINI R228 ALUMINUM OXIDE

- Premium aluminum oxide abrasive delivers fast initial cut rate
- Heavy, durable X-weight cotton backing is ideal for heat sensitive applications
- Strong butt joint that allows the belt to be run in either direction

1" to 6" wide, 36" to 72" long



TIER:	BEST	BETTER	BETTER	GOOD	GOOD
TRADENAME:	BLAZE R980P	BLUEFIRE R821P	BLUEFIRE R823P	GEMINI R766	GEMINI R228
ABRASIVE:	Ceramic Alumina	Zirconia Alumina	Zirconia Alumina	Aluminum Oxide Blend	Aluminum Oxide
BACKING:	Y-Weight Polyester	Y-Weight Cotton	X-Weight Polyester	Y-Weight Polyester	X-Weight Cotton
OTHER:	Supersize				

SIZE (W x L)	GRIT	STD. PKG.	PART #	PART #	PART #	PART #	PART #
1 x 42	36	50	662544 76825				780727 91710
	40	50	699573 45887	780727 26905			780727 20910
	50	50	662544 76826	780727 26904		666233 90042	780727 20905
	60	50	699573 45486	780727 26903	780727 28596	666233 34502	780727 20900
	80	50	662610 41539	780727 26902	780727 28594	666233 90043	780727 20895
	100	50	662610 43462		780727 28592		780727 20890
	120	50	662610 38660		780727 28590		780727 20885
	150	50			780727 28588		780727 20880
	180	50			780727 28586		780727 20875
	220	50			780727 00001		780727 20871
	240	50					780727 20870
	320	50					780727 20865
	1-1/2 x 60	36	10	699573 45578			
40		10	636425 95003				
50		10					780727 87807
60		10	699573 45631			666233 90045	
80		10	699573 45579			666233 90046	
100		10			780727 65077		699573 51736
120		10	662610 56493		780727 26984		
2 x 48	24	10					780727 26130
	36	10	636425 92057	780727 27103		666233 90047	780727 21255
	40	10	699573 45193	780727 27102		666233 90048	780727 21250
	50	10	699573 46716	780727 27101			780727 21245
	60	10	699573 44423	780727 27100	780727 28621	666233 90050	780727 21240
	80	10	699573 45100	780727 27099	780727 28619	666233 90051	780727 21235
	100	10	662610 52522		780727 28617		780727 21230
	120	10	662610 52520		780727 28615		780727 21225
	150	10			780727 28613		780727 23246
	180	10			780727 28611		780727 21223
	220	10			780727 28609		780727 63677
	320	10					780727 46387
	2 x 60	24	10				
36		10	699573 45196			666233 90052	780727 01170
40		10	699573 94425	780727 27124			780727 21300
50		10	699573 46149				780727 62537
60		10	699573 44901	780727 27122		666233 90055	780727 21290
80		10	636425 92574	780727 27121		666233 90056	780727 21285
100		10	662610 52222		662610 82976		780727 21280
120		10	662610 42738		780727 61958		
150		10					780727 44018
180		10			780727 02695		780727 20441
220		10			780727 06282		780727 44020
240		10					780727 61862
320		10					780727 02825
2 x 72	24	10	662544 33969				
	36	10	699573 45460	780727 27147		666233 90057	780727 21335
	40	10	699573 46729	780727 27146		666233 90058	780727 21332
	50	10	699573 44966	780727 27145			780727 84894
	60	10	699573 45157	780727 27144	780727 28645	666233 90060	780727 21325
	80	10	699573 44961	780727 27142	780727 28643	666233 34237	780727 21320
	100	10	662610 41897		662610 25537		780727 23235
	120	10	662610 44095		780727 28639		780727 21318
	150	10			780727 61770		780727 61973
	180	10			780727 63853		780727 18488
	220	10			780727 28633		780727 65601
	320	10					780727 21308

* Std. Pkg. = 20 Belts
Continued

1" to 6" wide, 36" to 72" long *continued*



TIER:	BEST	BETTER	BETTER	BETTER	GOOD	GOOD
TRADENAME:	BLAZE R980P	BLUEFIRE R821P	BLUEFIRE R823P	BLUEFIRE R884P	GEMINI R766	GEMINI R228
ABRASIVE:	Ceramic Alumina	Zirconia Alumina	Zirconia Alumina	Zirconia Alumina	Aluminum Oxide Blend	Aluminum Oxide
BACKING:	Y-Weight Polyester	Y-Weight Cotton	X-Weight Polyester	Y-Weight Polyester	Y-Weight Polyester	X-Weight Cotton
OTHER:	Supersize					

SIZE (W x L)	GRIT	STD. PKG.	PART #	PART #	PART #	PART #	PART #	PART #
2-1/2 x 48	36	10					666233 90061	780727 21540
	50	10		780727 27213				780727 21530
	60	10					666233 90064	780727 21525
	80	10					666233 90065	780727 21520
2-1/2 x 60	24	10				780727 37759		780727 08296
	36	10	699573 44963	780727 27235			666233 90066	780727 21610
	40	10	699573 46523	780727 27234			666233 90067	780727 21605
	50	10	699573 45300	780727 27233			666233 90068	780727 21600
	60	10	699573 45002	780727 27232	780727 28692	780727 21383	666233 90069	780727 21595
	80	10	699573 46095	780727 27231	780727 28690		666233 90070	780727 21590
	100	10	662610 41380		780727 68991			780727 21585
	120	10			780727 28686			780727 21580
	180	10			780727 28682			780727 21570
	220	10			780727 78217			780727 21565
4 x 36	36	10					666233 90071	780727 22110
	40	10						780727 22105
	50	10		780727 27475			666233 90073	780727 22100
	60	10			780727 28827		666233 90074	780727 22095
	80	10		780727 27473	780727 28825		666233 90075	780727 22090
	100	10			780727 28823			780727 22085
	120	10			780727 28821			780727 22080
	150	10						780727 22079
	180	10						780727 22075
	240	10						780727 22926
4 x 54	320	10						780727 22071
	36	10						780727 22185
	40	10						780727 22180
	50	10					666233 90078	780727 22175
	60	10	662610 63419	780727 27518	780727 25116			780727 22170
	80	10	699573 45139		780727 82996			780727 22165
	100	10						780727 22160
4 x 60	120	10			780727 28847			780727 22155
	150	10						780727 28381
	24	10	662544 61488					780727 72342
	36	10	699573 45298			780727 37955		780727 05189
	40	10	699573 91732					780727 44693
	50	10	699573 46715					780727 61630
	60	10	636425 94485		780727 74790			780727 62861
4 x 72	80	10	699573 45099		780727 65086			780727 84685
	100	10						780727 63161
	120	10	662544 16188		780727 66229			780727 87840
	36	10				780727 25984		
	6 x 48	36	10	699573 45143	780727 27698			666233 90081
40		10		780727 27697			666233 90082	
50		10		780727 27696			666233 90083	780727 22580
60		10	699573 44422	780727 27695*	780727 28937*		666233 90084	
80		10		780727 27694*	780727 28935*		666233 90085	780727 22570
100		10			780727 28933*			780727 22565
120		10			780727 28931*			780727 22560
150		10			780727 70042			780727 22555
180		10						780727 22550
220		10						780727 22545
240		10						780727 22540
320		10						780727 22543

* Std. Pkg. = 20 Belts
Continued

1" to 6" wide, 36" to 72" long *continued*



TIER:	BEST	BETTER	BETTER	BETTER	GOOD
TRADENAME:	BLAZE R980P	BLUEFIRE R821P	BLUEFIRE R823P	BLUEFIRE R884P	GEMINI R228
ABRASIVE:	Ceramic Alumina	Zirconia Alumina	Zirconia Alumina	Zirconia Alumina	Aluminum Oxide
BACKING:	Y-Weight Polyester	Y-Weight Cotton	X-Weight Polyester	Y-Weight Polyester	X-Weight Cotton
OTHER:	Supersize				

SIZE (W x L)	GRIT	STD. PKG.	PART #	PART #	PART #	PART #	PART #
6 x 54	60	10				780727 46982	
6 x 60	36	10					780727 22680
	40	10		780727 27762			780727 22679
	60	10	699573 45149	780727 28957*			780727 22665*
	80	10			780727 28955		780727 22660*
	100	10	662544 77452				
	120	10					780727 63882

* Std. Pkg. = 20 Belts

Belt Cleaning Stick

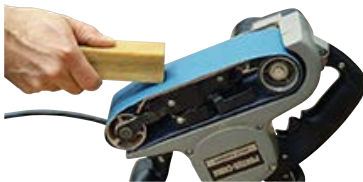

- This solid, rubber cleaning stick is designed to remove wood and other non-metallic materials that build up on belt surface during use
- Apply it to the face of the belt, while running, to remove unwanted materials and prolong the overall life of the belt up to 10 times

DESCRIPTION	STD. PKG.	PART #
1-3/8 x 1-3/8 x 6	10	076607 01717

TECH TIP

A light-bodied grease applied to a benchstand belt surface will reduce loading and greatly enhance the belt life and performance when grinding soft, malleable nonferrous materials such as aluminum, brass, bronze and copper.



For non-stock belts, FastTrack Service offers all the benefits of an ISO 9001 quality manufacturer and the advantages of a coated abrasives express belt service. As the industry's leading producer of abrasive material and backings, our FastTrack service offers an extensive range of Norton made-to-order belts including Blaze ceramic alumina, BlueFire zirconia alumina, and versatile aluminum oxide and silicon carbide belts.

Manufacturing Lead-times:

- Narrow belts: (1/2" – 12" wide) two days
- Wide belts (14" – 52" wide) three days

Size Availability:

- Maximum width: 52"
- 1/2" and greater widths; 25" and greater lengths

Please see the FastTrack Service Made-to-Order Belts section of this catalog for complete details.

2" to 10" wide, over 70" long

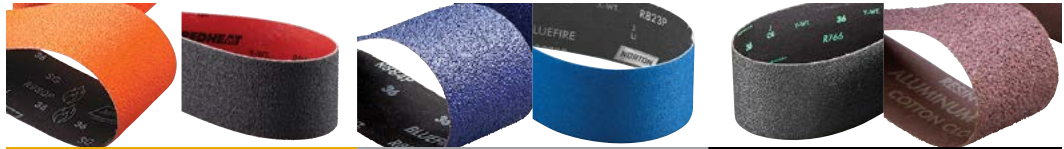

TIER:	BEST	BEST	BETTER	BETTER	GOOD	GOOD
TRADENAME:	BLAZE R980P	REDHEAT R983	BLUEFIRE R884P	BLUEFIRE R823P	GEMINI R766	GEMINI R228
ABRASIVE:	Ceramic Alumina	Ceramic Alumina	Zirconia Alumina	Zirconia Alumina	Aluminum Oxide Blend	Aluminum Oxide
BACKING:	Y-Weight Polyester	Y-Weight Polyester	Y-Weight Polyester	X-Weight Polyester	Y-Weight Polyester	X-Weight Cotton
OTHER:	Supersize	Supersize				

SIZE (W x L)	GRIT	STD. PKG.	PART #	PART #	PART #	PART #	PART #	PART #
2 x 132	36	10		780727 53086	780727 50016		666233 47337	
	40	10			780727 50015		666233 90089	
	50	10		780727 40771	780727 50013		666233 90090	
	60	10			780727 50011		666233 90091	780727 21445
	80	10		780727 01958	780727 50008		666233 90092	780727 21440
	120	10				780727 28662		
3 x 79	50	10	662610 90276					
	60	10			780727 48280			
3 x 90	36	10	699573 46319					780727 85831
3 x 132	24	10			780727 50140			
	36	10	699573 44710	780727 53087	780727 50138 RR		666233 90093	780727 21900
	36	10			780727 50139 L			
	40	10	699573 44964	780727 01614				
	50	10	699573 44763	780727 03709	780727 50135			780727 21890
	60	10	699573 44958			780727 28794	666233 90096	780727 21885
	80	10	699573 44764			780727 28792	666233 90097	780727 21880
	100	10				780727 28790		
	120	10				780727 28789		780727 21870
	180	10				780727 28785		780727 21860
4 x 79	36	10		662610 22622				
	40	10			780727 74955			
4 x 100	36	10			780727 68679			
4 x 132	24	10			780727 50289			
	36	10	699573 43852	780727 39662	780727 50287		666233 26093	
	40	10					666233 90098	
	60	10			780727 50281			
	80	10			780727 50279			780727 22385
	120	10						780727 22375
6 x 78-3/4	40	10			780727 25150			
6 x 79	36	10			780727 38105			
	80	10			780727 79322			
8 x 107	36	10						780727 22795
	50	10						780727 49887
	60	10						780727 22780*
	80	10						780727 22775*
10 x 70-1/2	36	10						780727 22840
	40	10						780727 22835
	50	10						780727 22830
	60	10					666233 47345	780727 22825
	80	10					666233 47346	780727 22820

* Std. Pkg. = 20 Belts



A small selection of stock products in popular sizes are available for wide belt woodworking and metalworking applications.

Applications:

Metalworking

Metalworking wide belts are used for plate dimensioning, slag grinding, machining, deburring, and other general metalworking applications. They are usually cloth and are closed coat.

Woodworking

Cloth woodworking wide belts are used for rough stock removal and dimensioning. Paper woodworking belts are used to upgrade the finish on furniture and other wood components.

Size Range:

Stock: 25" – 52" wide, 48" to 103" long

Grit Range:

Stock: 36 – 220

Abrasive Grain:

Zirconia Alumina, Aluminum Oxide

Metalworking Cloth Belt Recommendation Guide/Cross Reference

	TOTAL PERFORMANCE						INITIAL PRICE	
	BEST		BETTER		GOOD			
	H-wt. Polyester	Y-wt. Polyester	H-wt. Polyester	Y-wt. Polyester	X-wt. Polyester	Y-wt. Polyester	X-wt. Polyester	X-wt. Cotton
NORTON	Blaze R940P	Blaze R980P	BlueFire R840P	BlueFire R887D/R884P	BlueFire R823P	Gemini R766	Gemini R766X	Gemini R228
3M	966F, 984F, 994F, 997F	963G/H, 966F, 967F, 997F, 984F, 784F, 947A	561F	577F, 561D	551E	361F, 363F	353F, 384F	241D, 251D, 341D
Ekamant/ Uneeda	—	PS991, PS992	PZ628	PZ528, PZ633	XZ677	PA631, PG730, PG830	XA911	XA167
Hermes	CB441Z	CR456	SB488YR	RB48624YX, RB48644Z, RB48024YX, RB48444Z, RB485Z	RB486	RB377XY, SB378	RB377XY	RB320X, HSB
Klingspor	—	CS610	CS811	CS409, CS411	CS411X, CS416	CS412, CS413	CS341, CS710	CS310
SIA	—	2515, 2503	C888DP	2803, 2815, 2829, 2824, 2820	—	—	2820	2918, 2928
VSM	XK888Z, XK877Z	XK875X, XK885Y, XK880Y	KK717	KK716	ZK713X, ZK713T, KK715X	LK719X, KK711X	LK719X, KK711X	KK511X

Woodworking Cloth and Paper Belt Recommendation Guide/Cross Reference

	TOTAL PERFORMANCE			INITIAL PRICE		
	BEST		BETTER	GOOD		
	Y-wt. Cotton	F-wt. Paper	Y-wt. Cotton	X-wt. Cotton	F-wt. Paper	F-wt. Paper
NORTON	Dust-Less SG R963	Dust-Less SG 975	BlueFire R831	Gemini R215	Dust-Less H295	Dust-Less H275
3M	960G, 970DZ, 990FZ, 991FZ	966UZ	—	240DZ, 340A, 340D	260UZ	364UZ
Ekamant/ Uneeda	—	—	XZ677	RKX, RKXO	—	ARKFO, EKA1000, EKABlack
Hermes	—	CB115	RB480	RB320	BW114	BW110, BW114, CB115
Klingspor	—	—	C409, CS411	LS309XH	PS22	PS29
SIA	—	—	2803, 2820, 2829	2920, 2928, 2921, 2951	1919	1909, 1918, 1919 CRS, 1993
VSM	XK760X, XK760Y	XP760	KK713X, KK715X	KK504X, KP510E	KK508E	KP709, KP520, KP508E, KP510E

Better choice for all metal and wood applications due to the cut rate and life of the proprietary Norton BlueFire grain

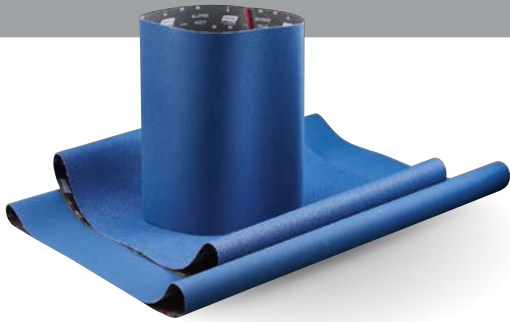

BLUEFIRE R884P/R823P ZIRCONIA ALUMINA CLOTH

- Strong, self-sharpening zirconia alumina abrasive for fast, aggressive cut and 30% longer life than competitive zirconia belts
- Durable resin bond for excellent grain retention and product life
- R884P has a durable Y-weight polyester waterproof cloth backing that excels on medium- to high pressure metal applications
- R823 has flexible X-weight polyester waterproof backing to excel on light- to moderate-pressure metal applications

Good choice for abrasive planing and dimensioning of glued-up stock and banded particleboard



GEMINI R215 ALUMINUM OXIDE CLOTH

- Premium aluminum oxide abrasive for fast initial cut rate
- Heavy, durable X-weight cotton backing is ideal for heat sensitive applications
- Strong butt joint that allows the belt to be run in either direction

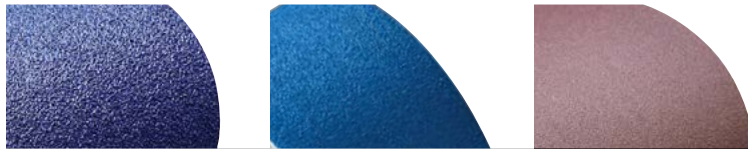

		TIER: BETTER		TIER: BETTER		TIER: GOOD	
		BLUEFIRE R884P		BLUEFIRE R823P		GEMINI R215	
		ABRASIVE: Zirconia Alumina		ABRASIVE: Zirconia Alumina		ABRASIVE: Aluminum Oxide	
		BACKING: Y-Weight Polyester Cloth		BACKING: X-Weight Polyester Cloth		BACKING: X-Weight Cotton Cloth	
		JOINT/FLEX: Plyweld, RR		JOINT/FLEX: Plyweld, RR		JOINT/FLEX: Plyweld, RR	
SIZE (W x L)	GRIT	STD. PKG.	PART #	PART #	PART #	PART #	PART #
25 x 48	80	3		699573 44781			
25 x 60	80	3		699573 28117			
	120	5		699573 28115			
25 x 75	120	5		699573 44791			
36 x 75	36	2	699573 50934				
	60	3	699573 50931				
	120	5		699573 29014			
37 x 60	180	5		699573 44869			
	50	3	699573 06219				
	80	3		699573 29019		699573 25709	
	100	5		699573 28103		699573 25708	
37 x 75	120	5		699573 29018		699573 25707	
	150	5		699573 28102		699573 02955	
	180	5		699573 28101			
	220	5		699573 28100			
	36	2	699573 50959				
	50	3	699573 05107				
	80	3	699573 50955			699573 25957	
52 x 75	100	5			699573 23880		
	120	5		699573 07358		699573 25760	
	150	5			699573 05737		
	180	5		699573 06734			
	120	5		699573 13510			

Due to the wide varieties of machines and applications, the majority of wide belts are non-stock. Our FastTrack belt service is available on the majority of products with 3-day lead-time on orders up to two cases quantity.

TECH TIP

6" wide belts can be used on machines that normally use 37" wide belts.

FastTrack Service Made-to-Order Belts

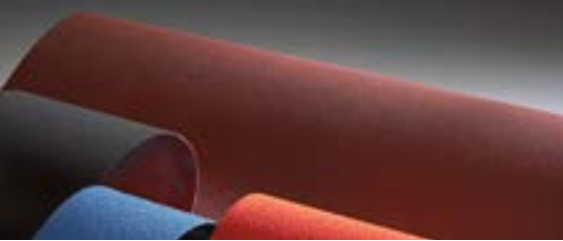

For many non-stock belts, our FastTrack belt service offers all the benefits of an ISO 9001 quality manufacturer and the advantages of a coated abrasives express belt service. As the industry leader of abrasive belts, our FastTrack belt service has an extensive range of Norton made-to-order belts including Blaze ceramic alumina, BlueFire zirconia alumina, versatile aluminum oxide, and silicon carbide belts.

Manufacturing lead-time is two days for narrow belts (1/2" – 12" wide) and three days for wide belts (14" – 52" wide). Please see the FastTrack belt service chart below for complete details on availability and lead-time.

FastTrack Availability* and Lead-time information

WIDTH	GRIT SIZE	MINIMUM ORDER QUANTITY	CASE QUANTITY	MAXIMUM ORDER QUANTITY (EQUALS 2 CASES)	CONVERSION LEAD-TIMES
Narrow Belts					
1/2" through 1"	All	50	200	400	2
Over 1" through 5"	All	10	50	100	2
Over 5" through 9"	All	10	20	40	2
Over 9" through 14"	All	10	10	20	2
Wide Belts					
Over 14" through 20"	All	5	10	20	3
Over 20" through 52"	36 & coarser	2	2	4	3
Over 20" through 52"	40-80	3	3	6	3
Over 20" through 52"	100 & finer	5	5	10	3

* FastTrack belt service applies to belts 25" and greater in length.

How to Place a FastTrack Belt Order

- Check the FastTrack belt availability
- Include a full description of belt: quantity, size, Norton CAP code, and grit size
- Send order electronically, fax, or phone to customer service
- When ordering a belt that does not have an existing part number, please call Customer Service to expedite part number creation

TIER	PRODUCT CAP CODE	SHAPE AVAILABILITY	GRIT SIZE	ABRASIVE GRAIN	BACKING	APPLICATIONS
Metalworking						
Best	R980P	Narrow, Wide	24-120	Blaze Ceramic Alumina	Y-wt. Polyester	Latest-generation Norton SG grain, supersized and designed for high-performance grinding on stainless and other alloys
Best	R984	Narrow, Wide	36-120	SG Ceramic Alumina	Y-wt. Polyester	Norton SG grain for medium-pressure grinding and finishing heat-sensitive alloys
Best	R983	Narrow	P36-P120	Red Heat Ceramic Alumina	Y-wt. Plus	P-graded ceramic alumina abrasive with lubricating supersize coat; engineered for maximum productivity on mild carbon steel, ferrous metal, and cast iron applications
Better	R884P	Narrow, Wide	24, 36-80	BlueFire Zirconia Alumina	Y-wt. Polyester	High-performance zirconia alumina grain designed for medium- to high-pressure grinding
Better	R887D	Narrow, Wide	24, 36-120	BlueFire Zirconia Alumina	Y-wt. Polyester	High-performance zirconia alumina grain, supersized and designed for medium- to high-pressure grinding of heat-sensitive alloys
Better	R823P	Narrow, Wide	60-220	BlueFire Zirconia Alumina	X-wt. Polyester	High-performance zirconia alumina grain on lighter backing designed for light to medium grinding
Good	R766	Narrow	P24-80	Gemini Aluminum Oxide Blend	Y-wt. Polyester	Premium aluminum oxide blend product designed for a variety of applications including soft metals to hard-to-grind stainless and carbon steel
Good	R766X	Narrow, Wide	P60-P400	Gemini Aluminum Oxide Blend	X-wt. Polyester	Quality, P-graded aluminum oxide and broad grit range for stock removal to finer finishing
Good	MX240	Narrow, Wide	P80-P150	Aluminum Oxide	X-wt. Poly/Cotton	P-graded, heat-treated aluminum oxide X-weight cloth with strong, but flexible, cotton/ polyester backing making it an ideal multi-purpose product
Good	R245	Narrow	P80-P240, P320, P400	Aluminum Oxide	J-wt. Polyester	Aluminum oxide on flexible, lightweight polyester backing for moderate- to light- pressure applications on mild steel
Good	KF376	Narrow	P80-P320, P400, P600	Aluminum Oxide	J-wt. Cotton	P-graded, heat-treated aluminum oxide with ceramic coating on a very flexible backing for use wherever flexibility and conformability are needed
Good	R445	Narrow	60-220	Silicon Carbide	X-wt. Polyester	Sharp, silicon carbide grain on medium polyester backing for grinding very hard materials – glass, stone, solid surface
Good	U243	Narrow, Wide to 24"	X80, X65, X45, X30, X22, X16	NORaX Aluminum Oxide	J-wt. Cotton	High-performance, multi-layered NORaX grain on very flexible backing for dry polishing applications
Woodworking						
Best	R963	Narrow, Wide	24-60, P80 100-150	SG Ceramic Alumina	Y-wt. Polyester	Norton SG ceramic alumina grain with anti-static coating for forest product applications (MDF, particleboard, plywood)
Best	R955	Narrow	P36-P120	Red Heat Ceramic Alumina	Y-wt. Cotton	100% ceramic alumina abrasive with Y-weight cloth backing for dimensioning, intermediate sanding of wood
Better	R831	Narrow, Wide	24, 36-120	BlueFire Zirconia Alumina	Y-wt. Cotton	Norton BlueFire open-coat product recommended for dry low-pressure applications or where loading is a problem
Good	R215	Narrow, Wide	50-180	Gemini Aluminum Oxide	X-wt. Cotton	Initial starting specification for woodworking applications where loading is a problem, and initial cost a primary concern
Good	R490	Narrow, Wide	P36-P150	Silicon Carbide	Y-wt. Polyester	Anti-static product for forest product applications (MDF, particle board, plywood) where loading is an issue
Good	R422	Narrow	50-120	Silicon Carbide	X-wt. Cotton	Initial starting specification for woodworking applications where loading is not an issue
Best	H975	Narrow, Wide	60-220	Red Heat Ceramic Alumina	F-wt. Paper	Ceramic alumina grain, antistatic coating, and open coat; the best choice for applications where loading is a problem (soft woods, etc.)
Better	H831	Wide	24,36-120	BlueFire Zirconia Alumina	F-wt. Paper	Durable zirconia alumina grain, antistatic coating, and open coat: the better choice for applications where loading is a problem (soft woods, etc.)
Good	H275B	Narrow, Wide	P60-P220	Aluminum Oxide	F-wt. Paper	Quality aluminum oxide grain, antistatic coating, and open coat make these an economical choice for all heavy-weight paper belt jobs
Better	H475	Narrow, Wide	P120-P400	Onyx Silicon Carbide	F-wt. Paper	Sharp silicon carbide and antistatic coating create finer finishes on hard materials and veneers where finish is critical



Norton non-woven belts are a combination of strong synthetic mesh and quality abrasive, bonded together by a smear-resistant adhesive. The open construction of non-woven material enables aggressive cutting action and improved surface finish while maintaining its non-loading feature.

Watch for new and improved narrow belt and file belt joints.

Applications:

Removing surface defects, light edge burrs, parting lines, flashing, rust, oxides, corrosion, paints, and scale; blending mill marks, tool marks, uneven edges, and applying decorative finishes.

Abrasive Grain:

Engineered Aluminum Oxide, Aluminum Oxide

Grit Range:

Extra Coarse (Black), Coarse (Brown), Medium (Maroon), Fine (Green), Very Fine (Blue)

Machine Used:



Application/Grit Recommendation Guide

	EXTRA COARSE	COARSE	MEDIUM	FINE	VERY FINE
	BEST Choice - Vortex Rapid Prep				
	BETTER Choice - Rapid Prep				
Scale Removal	◆				
Stock Removal		◆			
Heavy Deburring		◆			
Light Deburring			◆		
Light Finishing			◆		
Blending				◆	
Finishing					◆

Vortex Rapid Prep Pump Sleeve Belts

Best choice for finishing and blending applications



VORTEX RAPID PREP ALUMINUM OXIDE

- Patented Vortex agglomerated aluminum oxide grain produces the most consistent cutting and finishing action combining the cutting power of a coarser grit with the finish of finer grits
- Premium high-loft nylon fiber bonded to a strong nylon scrim backing allows a uniformly thick layer of resin bond and grain for extended life, durability, and stiffness
- Proprietary Clean Bond resin technology and open coat guarantee smear-free finishes even on high nickel content alloys and minimize loading on aluminum and other soft metals

	EXTRA COARSE	COARSE	MEDIUM	FINE	VERY FINE
GRIT/COLOR:	EXTRA COARSE	COARSE	MEDIUM	FINE	VERY FINE
TIER:	BEST	BEST	BEST	BEST	BEST
TRADENAME:	VORTEX RAPID PREP	VORTEX RAPID PREP	VORTEX RAPID PREP	VORTEX RAPID PREP	VORTEX RAPID PREP
ABRASIVE:	Engineered A/O	Engineered A/O	Engineered A/O	Engineered A/O	Engineered A/O
WIDTH	3-1/2	3-1/2	3-1/2	3-1/2	3-1/2
LENGTH	15-1/2	15-1/2	15-1/2	15-1/2	15-1/2
STD. PKG.	8	8	8	8	8
PART #	66623333725	66623335042	66623335118	66623333665	66623335139

Rapid Prep File and Narrow Belts

Better choice for finishing and blending applications



RAPID PREP ALUMINUM OXIDE

- Premium aluminum oxide abrasive grain coating provides up to 20% higher cut rate versus other surface conditioning belts
- Durable nylon fiber bonded to a strong Y-weight polyester backing with extremely low stretch is ideal for applications where low-stretch and durability are necessary
- Proprietary Clean Bond resin technology and open coat guarantee smear-free finishes even on high nickel content alloys and minimize loading on aluminum and other soft metals

GRIT/COLOR:	EXTRA COARSE	COARSE	MEDIUM	FINE	VERY FINE
TIER:	BETTER	BETTER	BETTER	BETTER	BETTER
TRADENAME:	RAPID PREP	RAPID PREP	RAPID PREP	RAPID PREP	RAPID PREP
ABRASIVE:	Aluminum Oxide	Aluminum Oxide	Aluminum Oxide	Aluminum Oxide	Aluminum Oxide

WIDTH	LENGTH	STD. PKG.	PART #	PART #	PART #	PART #	PART #
File Belts							
1/4	18	24		66261011420	66261012524	66623333424	66623333511
	24	24		69957392606	66261097565	66623333425	66623333512
1/2	12	24		66261003177	66261006465	66623318175	66254499884
	18	24		66261055309	66261055310	66623333426	66261055311
3/4	24	24		66261055312	66261008972	66254490859	66261019876
	18	12		66261002111	66261015808	66254490858	66261003622
1	20-1/2	12		66261083899	66261003260		66623333515
	18	12		66261007023	66261017898	66623333429	66623333518
	21	12		66623333412	66623336005	66623333430	66623333519
Narrow Belts							
3/4	80	12		66623333411	66623333505	66623333428	66623333516
1	30	12		66261019801	66623336006	66623333431	66261001972
	42	12		66261008317	66254441289	66623333432	66623333521
	60	12					66261055412
	64	12		66623333414	66623301513	66623333434	66261055413
	72	12		66261194240	66261006378	66254493830	66261005583
	132	8		66623314981			
	132	10			66261011414	66254436886	66623333525
1-1/2	60	8		66623333415	66261007644		66623303624
2	18-15/16	12	66261018226		66623333507	66623333436	66623333528
	34	12		66261063309		66623333437	66623333529
	48	10		66261006504	66261006648	66623333438	66623333531
	60	8		66623333416	666233189669	66623333439	66623333532
	72	8		66261002571	66261007757	66623333440	66261002307
	132	6				66261069525	66623333533
2-1/2	60	6		66254429365	66254441491	66623333441	66623333534
2-3/4	15-1/2	10	66623333578	66623333417	66623333508		66623333535
3	10-11/16	12	66623333580	66261018076	66261067469	66623333443	66623333536
	18	10	66254428772	66254496043	66254428776	66623333444	66261019836
	21	10	66623333584	66623333418	66261010870	66623333445	66623333537
	24	10	66254433559	66623314158		66623333446	66261055593
	72	6		66623333419	69957396833	66623333447	66261003176
	80	4		66623333420	66261007149	66623333448	66623333542
	90	4		66623333421		66623333449	66623333541
	118	4		66623333422	66623333510	66623333450	66261047121
	132	4		66254490470	66261055322	66623333451	66623333543
3-1/2	15-1/2	8	66623333595	66261055324	66254444576	66623333452	66261055326
4	24	8	66623333596	66254495931	66261031667		
	36	6			66261002321	66623333454	66623333546
	132	2		66261009056	66261006898	66623333455	66623333547
	168	2		63642576650	66261009174	66623333456	66623333548
6	48	4		66261055330	66261055331	66623333457	66261055332

Most Narrow belts are also available in our Vortex grain. If you do not see the Rapid Prep belts you need in our stock offering contact your Norton Representative for made-to-order availability.



Engineered for flexibility and fast cutting, cloth sheets and rolls have a longer life than paper. They tear cleanly and straight without shedding and are packed in a protective dispenser to eliminate waste and damage.

Categories:

All purpose, fine finishing, and screen-back

Applications:

Scouring and light deburring, scale and rust removal, blending and fine sanding, polishing lathe turnings, rolls and cylinders, and blending machine tool marks

Size Range:

Sheets: 9" x 11"

Rolls: 1" x 10 yds., 1-1/2" – 2" x 25 yds., 1" – 4" x 50 yds.

Grit Range:

40 – 600, extra coarse, coarse, medium, fine

Abrasive Grain:

Aluminum Oxide, Silicon Carbide, Emery

Machine Used:

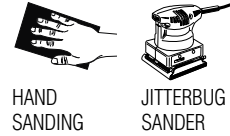

Cross Reference Guide

GOOD				
NORTON	Gemini K225	Metal R243	K622 Emery	Screen-Bak Q421
3M	011K	211K, 314D	011K, Emery Cloth	481W, 483W
Hermes	RB317	RB232J	—	GS91350, GS92400
Klingspor	LS309	KL361, LS309	KL371X	—
Sait/United Abrasives	DA-F	EA-F	—	Sait-Screen
SIA	2915	2601, 2915, 2936	1600, 2601	SIA-Screen
VSM	KK114F	KK505J, KK504X	—	—

Application/Starting Recommendation Guide

Durability/Stock Removal	Conformability	Slower Cut	Waterproof
Fast Cut	Excellent Finish	Fine Finish	Load Resistant
Gemini K225	Metal R243	K622 Emery	Screen-Bak Durite Q421

Good choice for general-purpose metal and woodworking applications

GEMINI K225 ALUMINUM OXIDE

- Premium P-graded aluminum oxide abrasive for greater cut rate on general purpose metalworking application
- Flexible J-weight backing for superior conformability to complex surfaces and better finishes
- Advanced full resin bond system for exceptional grain adhesion for longer life

Good choice for small-volume metal and woodworking applications at a low initial price

METAL R243 ALUMINUM OXIDE

- Quality P-graded aluminum oxide abrasive grain delivers fast cut rate and consistent finish on metals
- Smooth, flexible J-weight cotton backing provides superior conformability to complex surfaces and better finishes
- Advanced full resin bond system provides exceptional grain adhesion for longer life on aluminum, fiberglass, composites, hard woods and soft woods



Good choice for removing rust, paint and scale from metal surfaces



K622 EMERY

- Natural emery abrasive for scouring and polishing non-rated metals and utensils
- Abrasive is durabonded onto a flexible cloth backing for durability
- Close coat for the greatest degree of stock removal and longest life

Good choice for sanding softer materials where loading is a major problem such as plastic, copper, brass, plaster, wood, and drywall

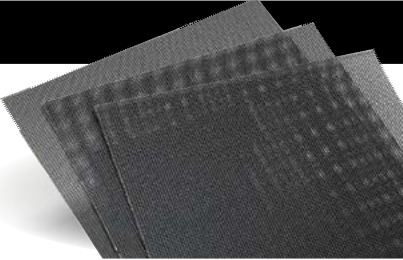

SCREEN-BAK Q421 SILICON CARBIDE

- P-graded silicon carbide for excellent cutting and non-loading properties
- Open weave screen for extreme resistance to loading when removing scale, rust and corrosion
- Open mesh design is waterproof and washable, allowing you to rinse and reuse

Cloth and Screen Rolls



TIER:	GOOD	GOOD	GOOD	GOOD	GOOD
TRADENAME:	GEMINI K225	GEMINI K225	GEMINI K225	GEMINI K225	GEMINI K225
ABRASIVE:	Aluminum Oxide	Aluminum Oxide	Aluminum Oxide	Aluminum Oxide	Aluminum Oxide
BACKING:	J-Weight Cotton	J-Weight Cotton	J-Weight Cotton	J-Weight Cotton	J-Weight Cotton
SIZE:	1" x 10 yds	1" x 50 yds	1-1/2" x 50 yds	2" x 50 yds	4" x 50 yds

GRIT	STD. PKG.	PART #	PART #	PART #	PART #	PART #
40	1		66261058716+	66261058715+	66261058714+	
50	1		66261127728+	66261127730+	66261127732+	
60	1		66261127729+	66261127731+	66261127733+	
80	1	66261134298	66261126276	66261126288	66261126299	
100	1	66261134299	66261126275	66261126287	66261126298	
120	1	66261134300	66261126274	66261126286	66261126297	66261127285*
150	1	66261134301	66261126273	66261126285	66261126296	
180	1	66261134302	66261126272	66261126284	66261126295	
220	1		66261126271	66261126283	66261126294	
240	1	66261134303	66261126270	66261126282	66261126293	
280	1		66261126269	66261126281	66261126292	
320	1	66261134304	66261126268	66261126280	66261126291	
400	1		66261126267	66261126279	66261126290	
600	1		66261126266	66261126278	66261126289	

+ 40 - 60 grit, are supplied in durable, but flexible X-weight cotton backing

* Packaging Standards: 4" Roll Std. Pkg.: 6 rolls



TIER:	GOOD	GOOD	GOOD	GOOD	GOOD
TRADENAME:	METAL R243	METAL R243	METAL R243	SCREEN-BAK Q421	SCREEN-BAK Q421
ABRASIVE:	Aluminum Oxide	Aluminum Oxide	Aluminum Oxide	Silicon Carbide	Silicon Carbide
BACKING:	J-Weight Cotton	J-Weight Cotton	J-Weight Cotton	Mesh	Mesh
SIZE:	1" x 50 yds	1-1/2" x 50 yds	2" x 50 yds	1-1/2" x 25 yds	2" x 25 yds
OTHER:				Waterproof	Waterproof

GRIT	STD. PKG.	PART #	PART #	PART #	PART #	PART #
60	1	66261136178	66261136190	66261136203		
80	1	66261136179	66261136192	66261136204	66261107275*	
100	1	66261136180	66261136194	66261136205		
120	1	66261136181	66261136195	66261136206	66261107270*	66261149811*
150	1	66261136182	66261136196	66261136207		
180	1	66261136186	66261136199	66261136208	66261107265*	
240	1	66261136187	66261136200	66261136209		
320	1	66261136188	66261136201	66261136210		
400	1	66261136189	66261136202	66261136211		

* Packaging Standards: Screen-Bak Q421 Std. Pkg.: 10 rolls

Cloth Sheets



TIER:	GOOD	GOOD	GOOD	GOOD
TRADENAME:	GEMINI K225	METAL R243	K622 EMERY	SCREEN-BAK Q421
ABRASIVE:	Aluminum Oxide	Aluminum Oxide	Emery	Silicon Carbide
BACKING:	J-Weight Cotton	J-Weight Cotton	J-Weight Cotton	Mesh
OTHER:				Waterproof

SIZE (W x L)	GRIT	PKG./CASE	PART #	PART #	PART #	PKG./CASE	PART #
9 x 11	40	25/125	66261 058713+				
	50	25/125	66261 101862+				
	60	25/125	66261 101861+				
	80	25/125	66261 126340	66261 179998		25/125	66261 100960
	100	50/250	66261 126339	66261 181503		25/125	66261 100955
	120	50/250	66261 126338	66261 181504		25/125	66261 100950
	150	50/250	66261 126337	66261 181505		25/125	66261 100945
	180	50/250	66261 126336	66261 180005		25/125	66261 100940
	220	50/250	66261 126335			25/125	66261 100935
	240	50/250	66261 126334	66261 181507			
	280	50/250	66261 126333				
	320	50/250	66261 126332	66261 180006		25/125	66261 100920
	400	50/250	66261 126331	66261 181509		25/125	66261 100915
	600	50/250	66261 126330				
	Extra Coarse	25/125					66261 101255
	Coarse	25/125					076607 01307
	Medium	50/250					076607 01309
	Fine	50/250					076607 01308

+ 40 - 60 grit are supplied in durable, but flexible X-weight cotton backing





Paper sheets and rolls are engineered for optimum performance when sanding metal, wood, composites and painted surfaces. The sheets are packed in protective packaging to eliminate waste and permit easy, neat storage.

Categories:
Applications:

All purpose, wood sanding, stearated (non-loading), waterproof, and heavyweight
Light-duty metal sanding, primer sanding, defect removal from painted surfaces, filler sanding, sanding and finishing of composites and fiberglass, bare wood sanding, sanding between sealer coats

Size Range:
Grit Range:

Full Sheets, Cut Sheets, File Strips and Rolls
36 – 2500

Abrasive Grain:

Ceramic Alumina, Zirconia Alumina, Aluminum Oxide, Silicon Carbide, and Garnet

Paper Weights:

Heavyweight – E; Lightweight – A through D

Machine Used:



Material-to-Product Recommendation Guide

	BEST			BETTER			GOOD						
	Blaze A995	Dry Ice A975	A2750P	Black Ice T214	Black Ice T401	A259PS	Durite A475	Blue-Bak T414	Gold Reserve A296	PB273	Garnet	TufBak T461	Other
Unfinished Metal	◆	◆	◆						◆	◆			
Primed / Painted Surfaces / Between Coats	◆	◆	◆				◆		◆	◆			
Fiberglass / Composites	◆	◆	◆				◆		◆	◆			
Bare Wood	◆	◆	◆								◆		
											A511, A513, A514		
Clear Coat Sanding				◆	◆							◆	
Sealer Sanding	◆	◆	◆				◆		◆	◆			
Lacquer Sanding				◆	◆			◆				◆	
Wet Sanding				◆	◆			◆				◆	
Paint Stripping	◆	◆	◆			◆	◆						A290
All Purpose	◆	◆	◆			◆							A212, A213, A211

Cross Reference Guide

NORTON	3M	Hermes	Klingspor	Mirka	SIA	VSM
STEARATED (NON-LOADING)						
Blaze A995	732U, 737U, 755L, 775L	CR116	—	—	—	—
Dry Ice A975	334U	—	PS36	—	Siaprime 5550	—
A2750P	216U, 255L, 236U, 260L, 334U	VC154-LL	PS33, PS73W	Q-Silver, Royal Micro	1940, 1944, 1950	—
A259PS	216U, 255L, 236U, 260L, 334U	—	—	—	—	—
Durite A475	405N, 414N, 415U, 426U, 435U	SF168	PL35, PS14	CaratFlex, PolarStar	1748	CP131A
Gold Reserve A296 / PB273	216U, 236U, 316U, 315U, NX	VC154-LL	PS33, PS73W	Q-Silver, Royal Micro, Bulldog Gold	19,401,950	MP10
WATERPROOF						
Blue Ice T214	213Q	WAFlex28	—	—	1913, 1951, 1600	—
Blue Ice T401	401Q, 414Q, 486Q	WSFlex16	PL35	Waterproof (A)	—	CP918A
Blue-Bak T414	413Q	WSFlex 16	PS14	Waterproof (A)	—	CP918A/C
TufBak T461	431Q	WSFlex 18	PS14	—	1727	CP918A/C
ALL PURPOSE/WOOD						
A211	230U, 240N, 346U	—	—	—	—	—
A212	210N	—	PL31	—	—	—
A213	230N	—	PL31	—	—	—
Garnet A511	110N	—	PS10	—	1400	—
Garnet A513	130N	GCAB	—	—	—	—
Garnet A514	140N	GCAB	—	—	—	—
HEAVYWEIGHT PAPER						
BlueFire H875P	740I, 745I, 750U, 751U, 751I	BW110	PS36	Royal CRS. Cut	1820, 1919, 1948	KP510E, KP709

Application/Grit Recommendation Guide

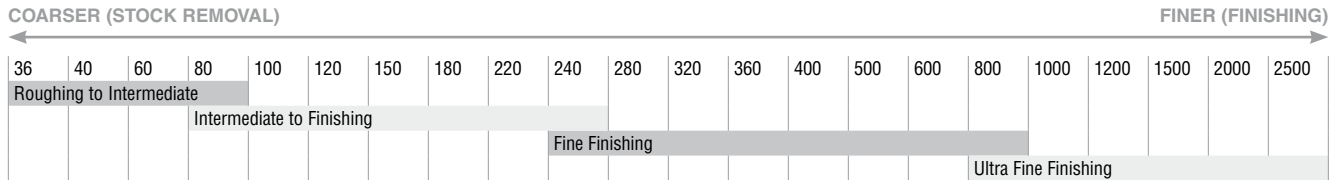

Recommended Backing Weight

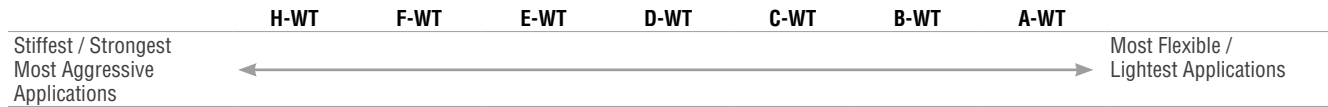

Paper Rolls



Best choice for fast cut rate and maximum dust extraction

BLAZE A995 MULTI-AIR CYCLONIC CERAMIC ALUMINA

- P-graded next-generation ceramic aluminum oxide abrasive for fastest cut rate and longest life with innovative spiral hole design to optimize dust extraction
- Proprietary D-weight Polyester-reinforced, flexible latex-saturated backing for 100% improvement in tear strength and edge durability providing longer life in all applications
- Waterbased, non-loading (No-Fil) stearate resists clogging and increases roll life; hook and loop (NorGrip) back for easy mounting and changing



Best choice for the most demanding dry sanding applications

DRYICE A975 CERAMIC ALUMINA

- P-graded, 100% SG ceramic alumina abrasive delivers fastest cut rate and longest life of any paper roll; available in Multi-Air Cyclonic version with laser-cut, spiral, vacuum-hole design to maximizes dust extraction
- Unique fiber reinforced, flexible B-wt. latex saturated paper backing for 50% - 60% improvement in tear strength while retaining flexibility; perforated for easy sizing
- Water-based non-pigmented stearate No-Fil coating provides improved load resistance and no color transfer to work



Better choice for high performance dry sanding applications

A2750P ALUMINUM OXIDE

- Premium P-graded, heat treated, toughened aluminum oxide abrasive delivers superior life, fast cut rate, consistent finish
- Unique fiber reinforced, flexible B-weight latex saturated backing provides 50% - 60% improvement in tear strength while retaining flexibility
- Water-based, non-pigmented stearate No-Fil coating provides maximum load resistance; available in Multi-Air Cyclonic version for maximum dust collection



Good choice and value for dry sanding and finishing aluminum, fiberglass, composites, hard woods and soft woods

A296 GOLD ALUMINUM OXIDE

- P-graded premium aluminum oxide abrasive produces a quick, cool cut and a more consistent surface finish
- Strong paper backing resists tearing while staying conformable and flexible
- Water-based, non-loading No-Fil stearate coating minimizes clogging and increases disc life

Paper Rolls *continued*

Hook and Loop
Paper Rolls



TIER:	BEST	BEST	BETTER	BEST	
TRADENAME:	BLAZE A995 NO-FIL MULTI-AIR CYCLONIC	DRY ICE A975 NO-FIL MULTI-AIR CYCLONIC	A2750P NO-FIL MULTI-AIR CYCLONIC	DRY ICE A975 NO-FIL	
ABRASIVE:	Ceramic Alumina	Ceramic Alumina	Aluminum Oxide	Ceramic Alumina	
BACKING WEIGHT:	D-Weight.	C- & B-Weight	D-Weight	B-Weight.	
BACKING ATTACHMENT:	Hook & Loop	Hook & Loop	Hook & Loop	Hook & Loop	
OTHER:	P-Graded	P-Graded	P-Graded	P-Graded	
SIZE:	2-3/4" x 13 yd	2-3/4" x 13 yd	2-3/4" x 13 yd	2-3/4" x 13 yd	
GRIT	PKG./CASE	PART #	PART #	PKG./CASE	PART #
80	1/4	699573 08899	636425 06113	1/4	636425 06261
120	1/4	699573 08900	636425 06114	1/4	636425 06259
150	1/4	699573 08901	636425 06117	1/4	636425 06258
180	1/4	699573 08902	636425 06118	1/4	636425 06257
220	1/4	699573 08903	636425 06119	1/4	636425 06256
240	1/4		636425 06120		
320	1/4		636425 06121	1/4	636425 06255
400	1/4		636425 06122	1/4	666233 29518
500	1/4		636425 06123	1/4	666233 29547
600	1/4		636425 06124	1/4	666233 29548

2-3/4" wide hook and loop paper rolls are perforated at 2-3/4" which allows use on all standard lengths of hand blocks and file boards. Additional grit sizes available, contact your Norton rep for more details.

PSA (Pressure Sensitive Adhesive) Paper Rolls



TIER:	BEST	BEST	BEST	BETTER	BETTER	BETTER	BETTER	GOOD
TRADENAME:	DRY ICE A975 NO-FIL	DRY ICE A975 NO-FIL	DRY ICE A975 NO-FIL	A275 OP NO-FIL	A275 OP NO-FIL	A275 OP NO-FIL	A275 OP NO-FIL	GOLD RESERVE A296 NO-FIL
ABRASIVE:	Ceramic Alumina	Ceramic Alumina	Ceramic Alumina	Aluminum Oxide	Aluminum Oxide	Aluminum Oxide	Aluminum Oxide	Aluminum Oxide
BACKING WEIGHT:	C-Weight.	C-Weight.	B-Weight.	B-Weight.	B-Weight.	B-Weight.	B-Weight.	B-Weight
BACKING ATTACHMENT:	PSA	PSA	PSA	PSA	PSA	PSA	PSA	PSA
OTHER:	P-Graded	P-Graded	P-Graded	P-Graded	P-Graded	P-Graded	P-Graded	P-Graded
SIZE:	2-3/4" x 25 yd	2-3/4" x 30 yd	2-3/4" x 45 yd	2-3/4" x 25 yd	2-3/4" x 30 yd	2-3/4" x 45 yd	4-1/2 x 10 yd	2-3/4" x 25 yd
GRIT	PKG./CASE	PART #	PART #	PART #	PART #	PART #	PART #	PART #
80	1/5	662611 49566			662611 131691		662611 131697	636425 06153
100	1/5					662611 131690	662611 131696	
120	1/5		662611 49564			662611 131689	662611 131695	636425 06152
150	1/5			662611 49563			662611 131688	662611 131694
180	1/5			662611 49562			662611 131687	662611 131693
220	1/5			662611 49561			662611 131686	662611 131692
240	1/5						662611 131685	
320	1/5			662611 49558			662611 131683	636425 06148
400	1/5			662611 49557			662611 131681	636425 06147
600	1/5						662611 131679	

Additional attachment options available as non-stock, contact your Norton rep for more details.

Roll Accessories



PSA Roll Dispenser

- Heavy-duty wire dispenser has a vinyl coating to protect the work surface
- Accommodates two 2-3/4" PSA rolls; stackable for multi-grit operations. Attach to wall or mount on cabinet

DESCRIPTION	STD. PKG.	PART #
PSA Roll Dispenser	1	636425 42773

PSA/Hook & Loop Sanding Blocks

- Ergonomically-shaped flexible foam blocks used with 2-3/4" rolls, fit comfortably in your hand
- Firm block produces a truly flat surface
- The soft block is designed for flat surfaces and contours

SIZE	DESCRIPTION	STD. PKG.	BACKING ATTACHMENT: PSA		Hook & Loop	
			PART #	PART #	PART #	PART #
2-3/4 x 5	Soft	5	636425 42090		636425 42092	
2-3/4 x 5	Firm	5	636425 42091		636425 42093	
2-3/4 x 7-3/4	Soft	5			636425 42095	
2-3/4 x 7-3/4	Firm	5	636425 42094			

Paper File Strips

Better choice for soft material applications



BLUEFIRE H875P ZIRCONIA ALUMINA

- Strong zirconia alumina plus abrasive provides 2 - 3 times life over aluminum oxide products
- Strong E-weight paper, synthetically-coated for excellent durability and chip resistance plus superior bond system optimizes grain adhesion and extends product life
- Non-stearated (no anti-loading agents); non-contamination often required for prime auto and aerospace paint applications

Paper File Strips
PSA (Pressure Sensitive Adhesive)
and Non-PSA



TIER:	BEST	BEST	BEST	BEST
TRADENAME:	A2750P NO-FIL	A2750P NO-FIL	A2750P NO-FIL	A2750P NO-FIL
ABRASIVE:	A/O	A/O	A/O	A/O
BACKING WEIGHT:	B-Weight	B-Weight	B-Weight	B-Weight
BACKING ATTACHMENT:	Non-PSA	PSA	Hook/Loop	Hook/Loop Vac
OTHER:	P-Graded	P-Graded	P-Graded	P-Graded

BETTER	BETTER	BETTER
BLUEFIRE H875P	BLUEFIRE H875P	BLUEFIRE H875P
Z/A	Z/A	Z/A
E-Weight	E-Weight	E-Weight
Non-PSA	PSA	Hook/Loop

SIZE (W x L)	GRIT	PKG./CASE	PART #	PART #	PART #	PART #	PKG./CASE	PART #	PART #	PKG./CASE	PART #	
2-3/4 x 16	100	50/500					662611	131657				
	120	50/500					662611	131656				
	180	50/500					662611	131654				
2-3/4 x 16-1/2	36						50/250		662611	123610	25/125 662611	123616
	40						50/250		662611	123609	25/125 662611	123615
	80	50/500		662611	131640	662611	131646	50/250	662611	123608	25/125 662611	123614
	100	50/500		662611	131639	662611	131645					
	120	50/500				662611	131644					
	150	50/500		662611	131637	662611	131643					
	180	50/500		662611	131636	662611	131642					
2-3/4 x 17-1/2	36						50/250	662611	123622			
	40						50/250	662611	123621			
	80	50/500	662611	131652			50/250	662611	123620			
	100	50/500	662611	131651			50/250	662611	126512			
	120	50/500	662611	131650								
	150	50/500	662611	131649								
180	50/500	662611	131648			50/250	662611	126511				
220	50/500	662611	131647									

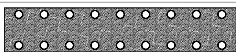

VACUUM HOLE PATTERN FOR
2-3/4 X 16 FILE STRIPS

Sanding Boards



PSA/Non-PSA Sanding Board

- This sanding board has a cushioned surface
- Spring clips mounted at each end securely hold 2-3/4" x 16-1/2" PSA file strips and 2-3/4" x 17-1/2" non-PSA file strips

Hook and Loop and Non-PSA Sanding Board

- Lightweight, rugged design for easy sanding of plastic fillers
- Spring clips mounted at each end securely hold 2-3/4" x 16-1/2" hook and loop file strips and 2-3/4" x 17-1/2" non-PSA file strips
- Air file shoe eliminates the need for clips. The quick-change backing positively locks and unlocks for fast use.

DESCRIPTION	STD. PKG.	PART #
PSA/Non-PSA File Strip Sanding Board	6	636425 42724
Hook and Loop/Non-PSA File Strip Sanding Board	5	636425 52836
Hook and Loop Air File Shoe	5	636425 52835

Stearated (Non-Loading) 9" x 11" Sheets

The best choice for sanding painted surfaces, composites, plastics or any material that tends to load



A2750P NO-FIL ALUMINUM OXIDE

- Premium, P-graded, heat-treated aluminum oxide abrasive for consistent surface finish, exceptional performance on all surfaces and coatings
- Unique fiber-reinforced, B-weight latex-saturated backing for 50 - 60 percent improvement in tear strength, exceptional flexibility, can be folded without cracking
- Non-pigmented, water based stearate (anti-clog) coating, open coat for best resistance to clogging and loading during sanding

Best choice for moderate material removal

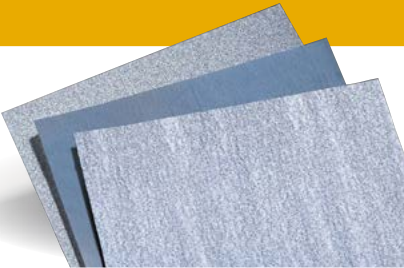

A259PS NO-FIL ALUMINUM OXIDE

- Premium heat-treated abrasive offers faster cut and long sanding life
- Open coat, non-pigmented, water-based stearate coating prevents color transfer and minimizes loading
- Increased backing weight, fiber-reinforcement and latex saturation offers better grain retention and tear-resistance yet is highly flexible for easy folding and unfolding

The better choice for gel coats, hard composite substrates, abrasion-resistant coatings, and woodworking applications



DURITE A475 NO-FIL SILICON CARBIDE

- P-graded, silicon carbide abrasive for easy penetration of the hardest surfaces
- Water based stearate, non-pigmented, No-Fil coating resists loading for the longest usable product life; no color transfer to work
- Fiber-reinforced, latex paper backing provides flexibility and resistance to tearing

Good choice for fast cuts and an even finish



PB273 NO-FIL ALUMINUM OXIDE

- P-graded, sharp light-brown, aluminum oxide abrasive for fast cut rate, extended life and consistent finish
- Water based non-pigmented stearate provides maximum load resistance and extended life; no dye in coating means no risk of color transfer or finish contamination
- Flexible latex-saturated B-weight backing, with a full resin bond and open coat for improved life

Stearated (Non-Loading) 9" x 11" Sheets *continued*

9 x 11
Paper Sheets



		BEST		BETTER		GOOD	
		JOBPACK					
TIER:		BEST		BETTER		GOOD	
TRADENAME:		A2750P NO-FIL		A259PS NO-FIL		DURITE A475 NO-FIL	
ABRASIVE:		Aluminum Oxide		Aluminum Oxide		Silicon Carbide	
BACKING WEIGHT:		B-Weight		C- & B-Weight		B-Weight	
OTHER:		P-Graded		P-Graded		P-Graded	
SIZE (W x L)	GRIT	PKG./ CASE	PART #	PART #	PART #	PART #	
9 x 11	80	50/250	662611 31634	076607 68174*	662544 87393	666233 11878	
	100	100/500	662611 31633	076607 68173*	662544 87394	666233 11877	
	120	100/500	662611 31632	076607 68172*	662544 87395	666233 11876	
	150	100/500	662611 31631	076607 68171*	662544 87396	666233 11875	
	180	100/500	662611 31630	076607 68168*	662544 87397	666233 11874	
	220	100/500	662611 31629	076607 68167*	662544 87398	666233 11873	
	240	100/500	662611 31628		662544 87399	666233 11879	
	280	100/500	662611 31627				
	320	100/500	662611 31626	076607 68166*	662544 87400	666233 11871	
	400	100/500	662611 31624	076607 68165*		666233 11870	
	500	100/500	662611 31623				
	600	100/500	662611 31622				
	800	100/500	662611 31621				
	1000	100/500	662611 31620				
	1200	100/500	662611 31619				
	1500	100/500	662611 31618				

* Packaging Standards: A259PS Job Packs: 20 sheets per pack / 10 packs per standard package for a total of 200 sheets

Rubber Hand Sanding Blocks

- Resilient rubber blocks that conform well to mild contours and flat surfaces

DESCRIPTION	STD. PKG.	PART #
2-3/4 x 5	5	076607 01889



Waterproof 9" x 11" Sheets

Best choice for superior cut and life in wet applications



BLACK ICE T214 ALUMINUM OXIDE WATERPROOF

- Premium, P-graded, heat-treated aluminum oxide abrasive for ultimate cut and life in wet applications
- Strong resin bond for longer life in wet applications
- High-strength B-weight waterproof latex paper backing is extremely flexible, environmentally stable, and resists humidity-caused curling

Best choice for superior finish in wet applications



BLACK ICE T401 SILICON CARBIDE WATERPROOF

- Premium, JIS graded ultra-fine silicon carbide abrasive provides the ultimate finish in wet applications
- Strong resin bond for longer life in wet applications
- High-strength B-weight waterproof latex paper backing is extremely flexible, environmentally stable, and resists humidity-caused curling

Better choice for wet finishing applications

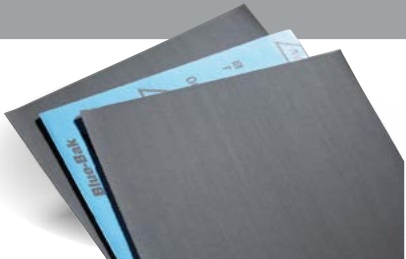

BLUE-BAK T414 SILICON CARBIDE

- Sharp, ANSI graded silicon carbide abrasive for exceptional finishes in wet applications
- Strong resin bond for longer life in wet applications
- High-strength B-weight waterproof latex paper backing is extremely flexible, environmentally stable, and resists humidity-caused curling

Good choice for medium material removal in wet applications



TUFBAK T461 SILICON CARBIDE

- ANSI graded silicon carbide abrasive for fast cutting with excellent finish in wet applications
- Advanced resin bond system for excellent flexibility and abrasive adhesion
- Strong, waterproof C-weight backing is ideal for more aggressive applications while being environmentally stable, resists product curl in humidity

Waterproof 9" x 11" Sheets *continued*

9 x 11
Paper Sheets

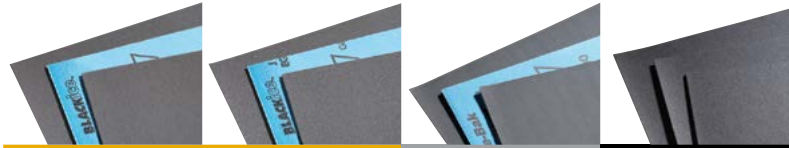

		BEST		BETTER		GOOD	
TIER:		BEST		BETTER		GOOD	
TRADENAME:		BLACK ICE T214		BLACK ICE T401		BLUE-BAK T414	
ABRASIVE:		Aluminum Oxide		Silicon Carbide		Silicon Carbide	
BACKING WEIGHT:		B-Weight		B-Weight		C-Weight	
OTHER:		P-Graded		JIS Graded		ANSI Graded	
SIZE (W x L)	GRIT	PKG./CASE	PART #	PART #	PART #	PART #	
9 x 11	60	50/250				662611 01175	
	80	50/250				662611 01170	
	100	50/250				662611 01165	
	120	50/250				662611 01160	
	150	50/250				662611 01155	
	180	50/250				662611 01150	
	220	50/250		662611 39389		662611 39367	
	240	50/250		662611 39388		662611 39366	
	280	50/250				662611 39365	
	320	50/250		662611 39386		662611 39364	
	360	50/250				662611 39363	
	400	50/250		662611 39385		662611 39362	
	500	50/250		662611 39384		662611 39361	
	600	50/250		662611 39383		662611 39360	
	800	50/250		662611 39382		662611 30334	
	1000	50/250			662611 39381		
	1200	50/250			662611 39380		
1500	50/250			662611 39379			
2000	50/250			662611 39378			
2500	50/250			662611 39377			

Waterproof Sanding Blocks – with “Grabbing” Power

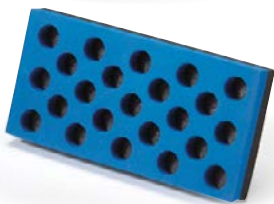

Dual Density Wet Sanding Block

- No adhesive required: simply wrap a 5-1/2" x 9" (9" x 11" cut in half) sheet around the block
- The dense side is for more aggressive blocking, while the soft side is for color sanding
- Equalizes sanding pressure for fine grit applications

Holey Block

- No adhesive required: simply wrap a 5-1/2" x 9" (9" x 11" cut in half) sheet around the block
- A rugged, semi-rigid, multi-purpose sanding block engineered for flat to medium curved surfaces
- A tactical hole pattern side provides numerous cutting edges to create a 30% faster cut rate
- The plain side provides firmness and a comfortable, easy-to-hold surface

DESCRIPTION	STD. PKG.	PART #
Wet Sanding Block	12	636425 03728
Holey Block	8	636425 03729

All-Purpose 9" x 11" Paper Sheets



Good choice for your wood, metal or composite sanding projects

A211/A212/A213 ALUMINUM OXIDE

- P-graded, aluminum oxide grain, open-coat provides aggressive, long-lasting cutting action
- Use for dry, general purpose hand sanding on hardwood, metal, and composites
- Available in multiple backing weights: A212 A-weight; A213 C-weight, A211 D-weight



Good choice for use on soft woods such as pine

A513/A511 GARNET

- Natural garnet abrasive is ideal for soft woods, such as pine, and produces an excellent, consistent finish
- Use dry on bare wood prior to coating
- Available in two backing weights: A511 A-wt. and A513 C-wt. for heavy-duty to light-duty hand sanding

9 x 11
Paper Sheets



TIER:	GOOD	GOOD	GOOD	GOOD	GOOD	GOOD	GOOD
TRADENAME:	A211	A213	A212	JOBPACK MULTISAND A213/A212	A513	A511	JOBPACK WOODSAND A513/A511
ABRASIVE:	Aluminum Oxide	Aluminum Oxide	Aluminum Oxide	Aluminum Oxide	Garnet	Garnet	Garnet
BACKING WEIGHT:	D-Weight	C-Weight	A-Weight	D-, C- & A-Weight	D- & C-Weight	A-Weight	D-, C- & A-Weight
OTHER:	P-Graded	P-Graded	P-Graded	P-Graded			

SIZE (W x L)	GRIT	PKG./CASE	PART #	PART #	PART #	PART #	PART #	PART #	PART #
9 x 11	36	25/125	662611 00335						
	40	25/125	662611 00330						
	50	50/250	662611 00325						
	60	50/250		662611 00320			662611 01560		
	80	50/250		662611 00315			662611 01555	662611 01505	076607 01584*
	100	100/500		662611 00295		076607 00358*	662611 01535	662611 01500	076607 01583*
	120	100/500		662611 00290		076607 00357*	662611 01530	662611 01495	076607 01582*
	150	100/500		662611 00285		076607 00356*	662611 01525	662611 01490	076607 01581*
	180	100/500			662611 00245	076607 00355*		662611 01489	076607 01580*
	220	100/500			076607 00156	076607 00354*		662611 01488	076607 01579*
	Asst+	100/500				076607 00365*			

* Packaging Standards: Job Packs: 25 sheets per pack / 10 packs per standard package for a total of 250 sheets
+ Assorted contains 6 each of 60, 100, 150 grit and 7 each of 220 grit

3-2/3 x 9
Paper Cut Sheets



TIER:	GOOD	GOOD
TRADENAME:	A290 NO-FIL	A213
ABRASIVE:	Aluminum Oxide	Aluminum Oxide
BACKING WEIGHT:	C-Weight	C-Weight
OTHER:	P-Graded	P-Graded

SIZE (W x L)	GRIT	PKG./CASE	PART #	PART #
3-2/3 x 9	60	100/1000		662611 02925
	80	100/1000	662611 01119	662611 02920
	100	100/1000		662611 02900
	180	100/1000	662611 01124	
	220	100/1000	662611 01123	



Surface finishing rolls are made of a non-woven nylon web impregnated with abrasive grain and resin bond.

Applications:

Light- to heavy-duty cleaning, deburring, blending, polishing, and finishing of metal, wood, composite, plastics, stone, solid surface and painted surfaces.

Abrasive Grain:

Aluminum Oxide, Silicon Carbide

Grit Range:

Medium (M), Fine (F), Very Fine (VF), Ultra Fine (UF), Micro Fine (MF)

Roll Features:

- Economical alternative to cut pads
- Can be cut to specific sizes

Machine Used:

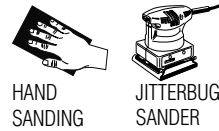

HAND
SANDING

JITTERBUG
SANDER

Application/Grit Recommendation Guide

MORE AGGRESSIVE, ROUGHER FINISH

LESS AGGRESSIVE, FINER FINISH



	#740	#644	#747	#635	#851	#777	HIGH STRENGTH
PRODUCT #:	#740	#644	#747	#635	#851	#777	HIGH STRENGTH
COLOR:	Dark Tan	Maroon	Maroon	Gray	Gray	Maroon	Maroon
DESCRIPTION:	Heavy Duty	GP – Fine	GP Plus – Very Fine	Clean & Finish	General Cleaning	General Purpose	High Strength
ABRASIVE:	AO	AO	AO	SC	SC	AO	AO
GRIT SIZE:	Medium 100 - 150	Fine 180 - 220	Very Fine 240 - 360	Ultra Fine 400 - 600	Very Fine 240 - 360	Very Fine 240 - 360	Medium 100 - 150
STEEL WOOL EQUIVALENT:	4 Extra Coarse	2 Medium Coarse	1 Medium	00 Very Fine	00 Very Fine	1 Medium	4 Extra Coarse
APPLICATIONS:	<ul style="list-style-type: none"> • Smear-free Clean Bond technology • 2X life • Most durable and aggressive cutting pad • Heavy-duty removal <ul style="list-style-type: none"> » rust » oxidation • Deburring 	<ul style="list-style-type: none"> • Cleaning and deburring <ul style="list-style-type: none"> » machinery » metal parts » plastic » solid surface » stone 	<ul style="list-style-type: none"> • Light cleaning, deburring and finishing <ul style="list-style-type: none"> » machinery » metal parts » plastic » solid surface » stone 	<ul style="list-style-type: none"> • Light cleaning and finishing of most surfaces <ul style="list-style-type: none"> » steel, aluminum » denibbing plastic » scuffing acrylics 	<ul style="list-style-type: none"> • Light cleaning and finishing of most surfaces <ul style="list-style-type: none"> » steel, aluminum » denibbing plastic » scuffing acrylics 	<ul style="list-style-type: none"> • Light cleaning, deburring and finishing <ul style="list-style-type: none"> » machinery » metal parts » plastic » solid surface » stone 	<ul style="list-style-type: none"> • Moderate deburring and surface blending

SIZE (W x L)	COLOR	DESCRIPTION	ABRASIVE	GRIT SIZE	STD. PKG.	TIER: BEST BETTER	
						PART #	PART #
Non-Woven Rolls							
4" x 30 Ft.	Maroon	High Strength Roll	A/O	M	3	662610 06358	
	Dark Tan	740 Heavy-Duty Roll	A/O	M	3		662610 10081
	Maroon	644 General Purpose Fine Roll	A/O	F	4		662610 58364
	Maroon	777 General Purpose Very Fine Roll	A/O	VF	4	662610 06373	662610 58361
	Maroon	747 General Purpose Plus Roll	A/O	VF	4		662610 51701
	Gray	851 General Cleaning Roll	S/C	VF	4		662610 58360
	Gray	635 Clean & Finish Roll	S/C	UF	5		662610 58357
6" x 30 Ft.	Maroon	High Strength Roll	A/O	M	2	662610 05182	
	Maroon	747 General Purpose Plus Roll	A/O	VF	3		662610 16430
	Maroon	777 General Purpose Very Fine Roll	A/O	VF	3	662610 04281	662610 58376
	Gray	851 General Cleaning Roll	S/C	VF	3		662610 58377
2" x 15 Ft. Handy Roll Pack	Assorted	1 each A/O Fine, A/O VF, SC MF	–	–	1		662610 08108

For hand-sanding or finishing flat, curved, contoured and hard-to-reach areas on wood, metal, composites, paint and solid surfaces

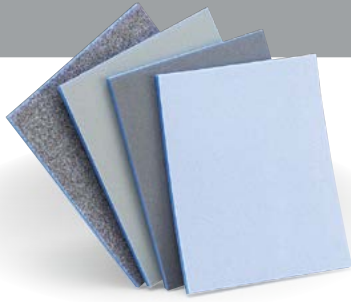

SOFTTOUCH CONTOUR SPONGES – COATED 1 SIDE

- Superior flexibility
- Premium foam substrate provides for an extremely smooth and uniform sanded surface

SIZE (W x L x T)	GRIT	STD. PKG.	PART #
4-1/2 x 5-1/2 x 3/16	60 Medium	80	076607 03074
	100 Fine	80	076607 03075
	180 Super Fine	80	076607 03076
	220 Ultra Fine	80	076607 03077
	280 Micro Fine	80	076607 03078

Good for sanding small diameters and contours



CONTOUR SPONGES – COATED 1 SIDE

- Thin, flexible; good for sanding small diameters and contours such as ceramics, spindles, turnings and railings

SIZE (W x L x T)	GRIT	STD. PKG.	PART #
4-1/2 x 5-1/2 x 3/16	100 Fine	100	076607 02257
	150 Extra Fine	100	076607 02256
	220 Ultra Fine	100	076607 02255

Good for a wide variety of materials and sanding applications where moderate flexibility is needed

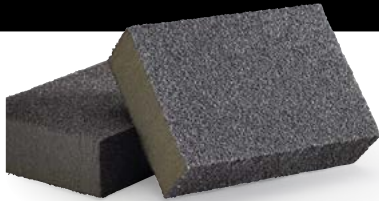

SMALL AREA GENERAL PURPOSE SPONGES – COATED 4 SIDES

- Medium to firm density open cell polyurethane foam provides uniform support and moderately aggressive cutting action while generating a smooth surface

SIZE (W x L x T)	GRIT	STD. PKG.	PART #	BULK PKG.	PART #
4 x 2-3/4 x 1	36/80	24	076607 49505	250	076607 04735
	Ex. Coarse/Med				
	80/80	24	076607 49507	250	076607 01875
	Med/Med				
	80/120	24	076607 49504	250	076607 02600
	Med/Fine				
	120/120	24	076607 49506		
	Fine/Fine				

Good for corners and flat surfaces on wood, metal, plastic and paint



PROFILE SPONGES – COATED 3 SIDES

- Ideal for cabinet sanding of raised profile doors

SIZE (W x L x T)	GRIT	STD. PKG.	PART #
4 x 2-3/4 x 1/2	100 Medium	500	636425 6313

Good for sanding primers, sealers and between coats on furniture and cabinets

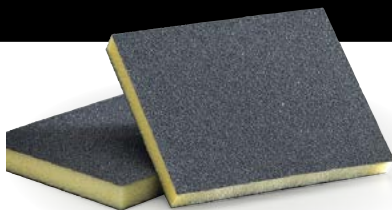

SEALER SANDING SPONGES – COATED 2 SIDES

- Very flexible; silicon carbide abrasive for sanding primers, sealers and between coats on furniture and cabinets

SIZE (W x L x T)	GRIT	BULK PKG.	PART #
4-3/4 x 3-3/4 x 1/2	36 Extra Coarse	250	636425 02538
	60 Coarse	250	636425 52870
	100 Medium	250	636425 52869
	220 Very Fine	250	636425 52868

Ideal for final sanding of surfaces, primer sanding, and between coats sanding



FLEXIBLE ABRASIVE SPONGES – COATED 1 SIDE

- Best initial price point for abrasive sponges

SIZE (W x L x T)	GRIT	STD. PKG.	PART #	BULK PKG.	PART #
3 x 4 x 1/2	60 Coarse	48	076607 04068	108	076607 01110
	80 Medium	48	076607 04067	108	076607 04070
	100 Medium	48	076607 04066	108	076607 00950
	150 Fine	48	076607 04065	108	076607 00949
	220 Very Fine			108	076607 04069

Non-Woven Hand Pads and Sponges



Surface finishing hand pads are made of a non-woven nylon web impregnated with abrasive grain and resin bond.

Applications:

Light- to heavy-duty cleaning, deburring, blending, polishing, and finishing of metal, wood, composite, plastics, stone, solid surface and painted surfaces.

Abrasive Grain:

Aluminum Oxide, Silicon Carbide

Grit Range:

Medium (M), Fine (F), Very Fine (VF), Ultra Fine (UF), Micro Fine (MF), Non-Abrasive (-)

Hand Pad Features:

- Flexible; conform to work surface
- Gentle action easily removes flashing or burrs without affecting dimension of workpiece
- Non-loading; constant supply of new cutting edges
- Non-rusting; no workpiece contamination
- Resilient construction; long life, increased productivity; solvent resistant; waterproof

Sponge Pad Features:

- Non-woven material is laminated to a long-lasting sponge for the convenience of 2 pads in one
- Superior replacement for steel wool

Machine Used:



HAND SANDING



JITTERBUG SANDER

Application/Grit Recommendation Guide

MORE AGGRESSIVE, ROUGHER FINISH

LESS AGGRESSIVE, FINER FINISH



PRODUCT #:	#740	#746	#644	#747	#796	#635	#748	THIN-FLEX VF	THIN-FLEX UF	THIN-FLEX BP	#456
COLOR:	Dark Tan	Gray	Maroon	Maroon	Green	Gray	Gray	Maroon	Gray	Gold	White
DESCRIPTION:	Heavy Duty	Blending	GP - Fine	GP Plus - Very Fine	Scouring	Clean & Finish	Final Shine	Cleaning	Cleaning	Blend Prep	Cleaning
ABRASIVE:	AO	SC	AO	AO	AO	SC	SC	AO	SC	AO	Non-Abrasive
GRIT SIZE:	Medium 100 - 150	Medium 100 - 150	Fine 180 - 220	Very Fine 240 - 360	Very Fine 240 - 360	Ultra Fine 400 - 600	Micro Fine 800 - 1200	Very Fine 240 - 360	Ultra Fine 400 - 600	Micro-Fine 800 - 1200	Non-Abrasive ----
STEEL WOOL EQUIVALENT:	4 Extra Coarse	3 Coarse	2 Medium Coarse	1 Medium	0 Fine	00 Very Fine	00 Very Fine	00 Very Fine	000 Extra Fine	000 Extra Fine	0000 Super Fine
APPLICATIONS:	<ul style="list-style-type: none"> • Smear-free Clean Bond technology • 2X life • Most durable and aggressive cutting pad • Heavy-duty removal <ul style="list-style-type: none"> » rust » oxidation • Deburring 	<ul style="list-style-type: none"> • Blending and deburring <ul style="list-style-type: none"> » welds » aluminum » stainless 	<ul style="list-style-type: none"> • Cleaning and deburring <ul style="list-style-type: none"> » machinery » metal parts » plastic » solid surface » stone 	<ul style="list-style-type: none"> • Light cleaning, deburring and finishing <ul style="list-style-type: none"> » machinery » metal parts » plastic » solid surface » stone 	<ul style="list-style-type: none"> • Removing stains, marks, rust, corrosion or oxidation from stainless equipment • Light cleaning of metal surfaces 	<ul style="list-style-type: none"> • Light cleaning and finishing of most surfaces <ul style="list-style-type: none"> » steel, aluminum » denibbing plastic » scuffing acrylics 	<ul style="list-style-type: none"> • Final finishing <ul style="list-style-type: none"> » final rub on wood » final blend on metal » final finish on plastics and acrylics 	<ul style="list-style-type: none"> • Maximum flexibility for consistent finishes • Cleaning, blending, finishing, and deburring in woodwork, metalwork, MRO, and synthetic applications 	<ul style="list-style-type: none"> • Maximum flexibility for consistent finishes • Cleaning, blending, finishing, and deburring in woodwork, metalwork, MRO, and synthetic applications 	<ul style="list-style-type: none"> • Fine cleaning <ul style="list-style-type: none"> » metal » fiberglass » stone » solid surface » ceramic • Wood <ul style="list-style-type: none"> » high-lighting » rubbing 	<ul style="list-style-type: none"> • Scratch-free cleaning <ul style="list-style-type: none"> » metal » fiberglass » stone » solid surface » ceramic • Wood <ul style="list-style-type: none"> » high-lighting » rubbing

Cross Reference Guide

COARSER

FINER

NORTON	#740	#746	#644	#747/847	#796	#635	#748	Thin-Flex VF	Thin Flex UF	#456
3M	7440	7446	64659	7447/8447 Production Hand Pad	96	64660	7448	Multi-Flex Maroon	Multi-Flex Gray	7445
Camel	Tan	—	—	Maroon	Green	—	Gray	—	—	White
Mirka	—	—	—	Maroon/Red VF	—	—	—	Mirlon Total Maroon	Mirlon Total Gray	—
Sait	Brown	—	—	Maroon	Green	—	Gray	—	—	—
SIA	6912 Brown	6712 Grey	—	6912 Maroon	6312 Green	—	—	—	—	—
Standard	HD-Tan AO	—	—	GP-Maroon VF	Green-AO	HP-VF	UF Gray	—	—	Cleaning White

SIZE (W x L)	COLOR	DESCRIPTION	ABRASIVE	GRIT SIZE	STD. PKG.	TIER: BEST	BETTER
						PART #	PART #
Hand Pads							
4-1/2 x 9	Maroon	Thin Flex Cleaning Pad	A/O	VF	25	666233 98062	
	Grey	Thin Flex Cleaning Pad	S/C	UF	25	666233 98063	
	Gold	Thin Flex Blend Prep	A/O	MF	25	662611 13519	
6 x 9	Dark Tan	740 Heavy-Duty Pad	A/O	Med	40	662610 74000	
	Gray	746 Blending Pad	S/C	Med	40		662610 74600
	Maroon	777 General Purpose Very Fine Pad	A/O	VF	60		662610 77700
	Maroon	747 General Purpose Plus Pad	A/O	VF	60	662610 74700	
	Maroon	847 General Purpose Plus Perforated Pad	A/O	VF	60	662610 84700	
	Green	796 Scouring Pad	A/O	VF	60		662610 79600
	Lt. Green	696 Food Pro Pad	A/O	VF	60		662610 69600
	Gray	851 General Cleaning Pad	S/C	VF	40		662610 85100
	Gray	635 Clean & Finish Pad	S/C	UF	60		662610 63500
	Gray	748 Final Shine Pad	S/C	MF	60		662610 74800
	White	456 Cleaning Pad	None	–	60		662610 45600
	Hand Pad Holder						
3-1/4 x 5-1/2	N/A	Hand Pad Holder			10		662610 47583
Scouring Pads/Sponges							
3-1/4 x 6-1/4 x 3/4	Green/Yellow	893 Scour-N-Sponge Pad	A/O	VF	40		662610 59403
3-1/4 x 6-1/4 x 3/4	White/Yellow	875 Clean-N-Sponge Pad	None	–	40		662610 59402



THIN and FLEXIBLE: Perfect for Tight Spots

Norton Bear-Tex Thin-Flex High-Performance Hand Pads

- Achieve performance benefits of a coarse and fine grain product in one hand pad; fast cut and definitively better finish than competing pads
- Extremely thin and conformable; ideal for deburring, cleaning, blending, and finishing contoured surfaces and tight spaces
- Special coated web design for superior and constant cutting action without added effort from user
- Versatile; ideal for woodworking, metalworking, maintenance operations, and synthetics fabrication

Rotolo Foam Sanding Pads

Application/Grit Recommendation Guide

COARSER ←												→ FINER														
120	150	180	220	240	280	320	400	500	600	800	1000	120	150	180	220	240	280	320	400	500	600	800	1000			
Cleaning/Repairing			Final Sanding			Feather Edging			Basecoat Sanding			Clearcoat Sanding														

The better choice for fine sanding flat and curved surfaces



A2750P NO-FIL ROTOLO FOAM ROLLS

- Premium, P-graded, heat-treated aluminum oxide abrasive for consistent surface finish, exceptional performance on all surfaces and coatings
- Foam backing is perfect for hand sanding primer without leaving finger marks; 50% – 60% improvement in tear strength versus conventional paper rolls; perforated for easy sizing
- Non-pigmented, water based stearate No-Fil coating, open coat for best resistance to clogging and loading during sanding

TIER: **BETTER**
 TRADENAME: **A275 OP ROTOLO**
 ABRASIVE: Aluminum Oxide
 OTHER: P-Graded

SIZE (W x L)	GRIT SIZE	ROLLS/STD. PKG.	PART #
4-1/2" x 82'	120	2	636425 35316
	150	2	636425 57584
	180	2	636425 57599
	220	2	636425 57600
	240	2	636425 57602
	280	2	636425 57604
	320	2	636425 57606
	400	2	636425 57608
	500	2	636425 57611
	600	2	636425 57612
	800	2	636425 57613
1000	2	636425 57616	



power...
**IN THE PALM OF
YOUR HAND**

New Portable Tools and the specialty abrasive products to go along with them. Access hard-to-reach areas with ease with the Norton Merit line of specialty products.





Put the world right in the palm of your hand with our 2" and 3" Norton Mini Angle Sanders. Small, compact enough to get into those hard-to-reach areas, and powerful enough to finish the job fast and efficiently.

Specifications for:

Weight of tool:

Compressed air:

Maximum permissible operating pressure:

Horsepower:

Free speed:

Air consumption @90psi:

Noise characteristic value in accordance with EN ISO 15744 (ISO 15744):

- A-weighted sound pressure level at workstation
- A-weighted sound power level
- Peak C-weighted instantaneous sound pressure level at workstation

Measurement uncertainty (Standard):

Vibration value according to EN ISO 28927-3:

Recommended lubrications:

Sanding tool specifications:

Applications and suitability:

2" Mini Angle Air Sander 3" Mini Angle Air Sander

1.6 lbs. (0.742kg)

6.2 bar (90psi)

6.2 bar (90psi)

.45

22,000 rpm

85 liters/min (3 CFM)

1.8 lbs. (0.816kg)

6.2 bar (90psi)

6.2 bar (90psi)

.9

20,000 rpm

116 liters/min (4.1 CFM)

87.3 dB

98.3 dB

<130 dB

3.00 m/s²

0.84 m/s²

Air oil 20#

Pad Size 2" Collet

Collet Chuck 1/4" (6mm)

Surface preparation, grind welds, spot sanding and light-duty finishing applications.

83.2 dB

94.2 dB

<130 dB

5.92 m/s²

1.09 m/s²

Air oil 20#

Pad size 3" Collet

Collet Chuck 1/4" (6mm)

NEW

Put the power right in the palm of your hand with our Mini Angle Sanders

MINI ANGLE SANDERS

- A double-bearing spindle generates superb concentricity, reducing vibrations allowing for longer use and finer finishes
- Finesse your projects by having the ultimate control in both precision and power with the speed regulator
- Get better tool handling along with reduced fatigue with the ergonomic and streamlined non-slip grip



DESCRIPTION	STD. PKG.	PART #
Mini Angle Sanders and Kits		
2" Mini Angle Sander	1	662611 50076
2" Kit Includes:	1	662611 50077
• 1 – 2" Sander		
• 25 – 2" 36 Grit Blaze R980P 3-Ply TR Discs (662611 62318)		
• 50 – 2" Medium Grit Rapid Prep Non-Woven TR Discs (662610 09190)		
• 1 – 2" Medium Density Back-Up Pad (662610 55103)		
3" Mini Angle Air Sander	1	699573 82154
3" Kit Includes:	1	699573 82155
• 1 – 3" Sander		
• 25 – 3" 36 Grit Blaze R980P 3-Ply TR discs (662611 62328)		
• 25 – 3" Medium Grit Rapid Prep Non-Woven TR discs (662610 17522)		
• 1 – 3" Medium Density Back-Up Pad (662610 55105)		





Mini-flap discs are ideal for use in tight spaces. They feature layered flaps which wear away evenly during use exposing new abrasive grain. The lightweight plastic backing helps to absorb vibration. They can help eliminate the conventional 2-step process in grinding edges and removing welds and rust.

- Applications:** Grinding, stock removal, edge chamfering/beveling, weld blending, deburring/deflashing, rust removal, blending, cleaning, and finishing in small areas or tight spots.
- Size Range:** 2" and 3" Quick-Change
- Grit Range:** 36 – 120
- Abrasive Grain:** Ceramic Alumina, Zirconia Alumina
- Abrasive Flaps:** Polyester, Poly-cotton
- Attachment:** TR (Type III) and TS (Type II)
- Backing Plate Material:** Extra Heavy-Duty Plastic
- Machine Used:**



Best choice for beveling, blending, deburring, and stock removal in tight spaces



BLAZE R980P CERAMIC ALUMINA

- Premium ceramic alumina abrasive grain lasts 50% – 200% longer than many flap discs on stainless steel, cobalt, chrome, Inconel, titanium and other hard-to-grind materials
- Flexible, high-strength, plastic backing plates absorb vibration for optimized ergonomics
- Y-weight polyester flaps with a supersize grinding aid significantly improve life, grain retention, and fray resistance while providing a cool, noticeably faster cut rate

Better choice for blending, deburring, and stock removal in tight places



BLUEFIRE R884P ZIRCONIA ALUMINA PLUS

- High-performance zirconia alumina plus abrasive for aggressive cut and long life
- Flexible, high-strength, plastic backing plates absorb vibration for optimized ergonomics
- Poly-cotton flaps with semi-open coat provide improved durability and minimizes loading on aluminum



TIER:	BEST	BETTER	BEST	BETTER		
TRADENAME:	BLAZE R980P	BLUEFIRE R884P	BLAZE R980P	BLUEFIRE R884P		
ABRASIVE:	Ceramic Alumina	Zirconia Alumina Plus	Ceramic Alumina	Zirconia Alumina Plus		
FLAP:	Polyester	Polyester	Polyester	Polyester		
BACKING MATERIAL:	Extra Heavy-Duty Plastic	Extra Heavy-Duty Plastic	Extra Heavy-Duty Plastic	Extra Heavy-Duty Plastic		
ATTACHMENT:	TR (Type III)	TR (Type III)	TS (Type II)	TS (Type II)		
SIZE (D)	GRIT	STD. PKG.	PART #	PART #	PART #	PART #
2	36	10	776960 90145	776960 90165	776960 90155	776960 90175
	40	10	776960 90146	776960 90166	776960 90156	776960 90176
	60	10	776960 90147	776960 90167	776960 90157	776960 90177
	80	10	776960 90148	776960 90168	776960 90158	776960 90178
3	120	10	776960 90149	776960 90169	776960 90159	776960 90179
	36	10	776960 90150	776960 90170	776960 90160	776960 90180
	40	10	776960 90151	776960 90171	776960 90161	776960 90181
	60	10	776960 90152	776960 90172	776960 90162	776960 90182
	80	10	776960 90153	776960 90173	776960 90163	776960 90183
	120	10	776960 90154	776960 90174	776960 90164	776960 90184

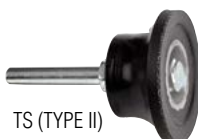

DESCRIPTION	MAX. RPM	STD. PKG.	TR (TYPE III)	TS (TYPE II)
Mini Flap Disc Back-up Pads				
2" and 3" Medium Density Back Up Pads	30,000	1	088341 60172	088341 68539



Tool-free, twist-on and -off fastening systems make fast work of disc changes to maximize productivity by minimizing downtime.

- Applications:** Fiber and NorKut trimmable hard plastic discs: welding, grinding and blending; heavy metal removal; light deburring and finishing
Cloth discs: light- to medium-pressure grinding; blending, leveling and finishing applications; for use on contours or flat surfaces
- Size Range:** 9/16" – 4" diameter
- Grit Range:** 24 – 320
- Abrasive Grain:** Ceramic Alumina, Zirconia Alumina, Aluminum Oxide, Silicon Carbide
- Backing:** Fiber, cloth, or polymer
- Cloth Flex:** 3-ply (more aggressive), 2-ply (standard),
- Attachment:** Type TS (II), Type TR (III), and Type TP (I)
- Back-up Pads:** Rubber with hardness variations for different applications
- Machine Used:**



MINI ANGLE SANDER

Coated Abrasive Quick-Change Disc Availability



Fiber

- The most heavy-duty discs with resin over resin construction on heavy-duty vulcanized fiber backing
- Premium grain for applications from heavy stock removal to surface blending



Cloth 3-Ply

- These heavy-duty, 3-ply polyester laminate construction discs are the most aggressive and durable cloth discs on the market



NorKut

- Unique polymer backing resists cracking and breakage and can be cut down up to the 1" core
- Use the cores to grind "pinch" welds and other hard-to-reach areas



Cloth 2-Ply

- Our standard 2-ply laminate construction creates an aggressive and durable cloth disc for flat surfaces

Quick-Change Attachment Systems and Cross Reference Guide

Each system enables quick, safe disc changes, reducing downtime and operating expenses.

Type TS (Type II)

- Features a turn-on/turn-off style fastener
- Fastener is made of metal



Type TR (Type III)

- Features a roll-on/roll-off style fastener
- Fastener is made of plastic

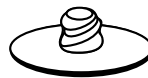

Type TP (Type I)

- Features a snap-on/snap-off style fastener
- Fastener is made of nylon



NORTON MERIT	TS (Type II)	TR (Type III)	TP (Type I)
3M	Roloc TS/TSM	Roloc TR	Roloc TP
Standard	TS (SocAtt)	TR (Lockit)	TP (ClickOn)
Superior	Type S	Type R	–
Arc	Type S	Type R	Type P
Pferd	Type CD	Type CDR	–
Sait	SAIT-LOK	SAIT-LOK-R	–
Camel	Turn On	Roll On	–
Klingspor	QMC	QRC	–
Garryson	Type S	Type R	–

Material/Application-to-Product Recommendation Guide

	BEST	BETTER	GOOD
	Blaze R980P	BlueFire R884P	Aluminum Oxide Silicon Carbide R422
Stainless Steel / Titanium / Super Alloys	◆	◆	◆
Mild Carbon Steel / Welds		◆	◆
Ferrous Metals / Cast Iron		◆	◆
Brass / Bronze / Aluminum		◆	◆
Paint / Glue / Adhesive			◆
Concrete / Stone / Fiberglass			◆

Application/Grit Recommendation Guide

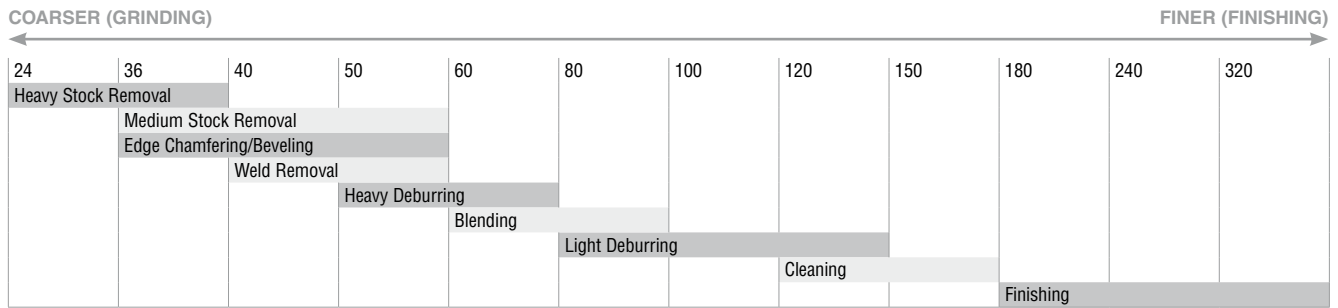

Cross Reference Guide

	TOTAL PERFORMANCE			INITIAL PRICE	
	BEST	BETTER	GOOD		
Abrasive Backing	Ceramic Alumina Fiber	Ceramic Alumina Cloth	Zirconia Alumina Cloth	Aluminum Oxide Cloth	Silicon Carbide Cloth
NORTON	Blaze F980	Blaze R980P	BlueFire R884P		R422
3M	782C, 785C, 787C, 982C, 985C, 987C, 988C	963G/H, 966F, 967F, 997F, 984F, 784F, 947A	561D	361F, 363F	421A, 441D, 461F
Standard	Ceramic, Ceramic Pro	Ceramic Pro, Ceramic	Zirconia	A/O Extra, A/O Pro	Silicon Carbide
Superior	—	Ceramic G.A.	Premium Zirc	A/O with Grinding Aid	—
Arc	—	—	Zirconia/Y Standard	A/O/X Plus Coolant	—
Pferd	CO, CO Cool	Ceramic	ZA Z	Aluminum Oxide A-Plus, Aluminum Oxide A-INOX-FORTE	Silicon Carbide SiC
Sait	7S,7A, 9S	—	Z	3A	C-W
Camel	Ceramic	—	Zirconia AO	—	—
Klingspor	CS570, FS966	CS610	Alumina Zirconia	—	CS333X
Garryson	—	Ceramic	—	—	—



Best choice for tough applications and stainless steel

BLAZE F980 CERAMIC ALUMINA FIBER

- 100% ceramic grain constantly exposes sharper edges to deliver highest productivity at lowest overall costs vs. competitive lower-ratio ceramic discs
- Strong fiber backing, heavier and more rigid than conventional cloth discs, adds strength and tear resistance, and allows additional pressure for better results when grinding difficult materials
- Advanced self-lubricating grain treatment provides coolest cut and significantly faster cut rates; excels on hard-to-grind materials like 300 and 400 Series stainless and exotic alloys



TIER: **BEST**
 TRADENAME: **BLAZE F980**
 ABRASIVE: Ceramic Alumina
 BACKING: Fiber – Heavy Duty
 OTHER: Supersize
 ATTACHMENT: TR (Type III)



SIZE (D)	GRIT	STD. PKG.	PART #
2	24	25	776960 90139
	36	25	662610 58704
	50	25	662610 58705
	60	25	662610 58706
	80	25	662610 58707
3	24	25	776960 90140
	36	25	662610 58708
	50	25	662610 58709
	60	25	662610 58711
	80	25	662610 58712

Quick-Change back-up pads shown at the end of the Quick-Change Disc section.





Best choice for tough applications, titanium, super alloys, and stainless steel (3-ply) or contoured surfaces (2-ply)

BLAZE R980P CERAMIC ALUMINA

- 100% ceramic grain constantly exposes sharper edges to deliver highest productivity at lowest overall costs vs. competitive lower-ratio ceramic discs
- Improved resin bond system maximizes grain retention for longer product life
- Advanced self-lubricating grain treatment provides coolest cut with significantly faster cut rates while minimizing loading on hard-to-grind materials



Better choice for soft metals, wood, stainless steel, and carbon

BLUEFIRE R884P ZIRCONIA ALUMINA

- Premium, versatile, self-sharpening zirconia plus grain provides aggressive cut and up to 30% longer life vs. competitive zirconia discs
- Semi-open coat minimizes loading on soft metals (aluminum, brass, and bronze) and wood, as well as stainless and carbon steels
- Durable Y-weight, polyester waterproof backing stands up to demanding applications: high-pressure and hard-to-grind exotic alloys



Better choice for stainless steel, titanium and other exotic alloys

R801 ZIRCONIA ALUMINA PLUS

- Self-sharpening, zirconia alumina abrasive with grinding aid provides cooler cut, and longer life on hard-to-grind materials
- Durable, Y-weight, 2-ply polyester waterproof blend back stands up to these demanding applications
- Minimized heat build-up allows these discs to outlast conventional aluminum oxide and zirconia alumina discs in many applications



Good choice when initial price is the primary consideration

ALUMINUM OXIDE

- Versatile aluminum oxide abrasive for aggressive cut and longer life than competitive aluminum oxide discs
- Durable Y-weight 2-ply polyester backing and coating for additional life and faster cut rate on moderately-demanding applications
- Good choice when initial price is the primary purchasing consideration



Good choice for non-ferrous materials

R422 SILICON CARBIDE

- Sharp, silicon carbide abrasive provides high initial cut and penetration to resist loading on soft metals
- Strong, X-weight, 2-ply cotton backing construction for extended durability and reduced edge wear
- When completion time is important, sharp silicon carbide abrasive gets non-ferrous blending jobs done quickly

Ceramic Alumina Quick-Change Cloth Discs



TIER:	BEST	BEST	BEST	BEST
TRADENAME:	BLAZE R980P	BLAZE R980P	BLAZE R980P	BLAZE R980P
ABRASIVE:	Ceramic Alumina	Ceramic Alumina	Ceramic Alumina	Ceramic Alumina
BACKING:	Polyester 3-Ply Heavy-Duty	Polyester 3-Ply Heavy-Duty	Polyester 2-Ply Standard	Polyester 2-Ply Standard
OTHER:	Supersize TS (Type II)	Supersize TR (Type III)	Supersize TS (Type II)	Supersize TR (Type III)
ATTACHMENT:				

SIZE (D)	GRIT	STD. PKG.	PART #	PART #	PART #	PART #
1-1/2	36	100	662611 62307	662611 62308	636425 95401	
	50	100	662611 62309	662611 62310	636425 95446	
	60	100	662611 62311	662611 62312	636425 95447	636425 95468
	80	100	662611 62313	662611 62314	636425 95450	
	120	100	662610 43379	662610 43380	662610 43416	
2	36	25	662611 62317	662611 62318	636425 95452	636425 95470
	50	25	662611 62319	662611 62320	636425 95456	636425 95472
	60	25	662611 62321	662611 62322	636425 95458	636425 95476
	80	25	662611 62323	662611 62324	636425 95459	636425 95478
	100	25	662610 43382	662610 43383	662610 43418	662610 43419
	120	25	662610 43384	662610 43386	662610 43420	662610 43421
3	36	25	662611 62327	662611 62328	636425 95460	636425 95479
	50	25	662611 62329	662611 62330	636425 95462	636425 95480
	60	25	662611 62331	662611 62332	636425 95463	636425 95481
	80	25	662611 62333	662611 62334	636425 95464	636425 95493
	100	25	662610 43389	662610 43390	662610 43422	662610 43423
	120	25	662610 43391	662610 43392	662610 43424	662610 43425

Quick-Change back-up pads shown at the end of the Quick-Change Disc section.



Zirconia Alumina Quick-Change Cloth Discs



TIER:	BETTER	BETTER	BETTER	BETTER	BETTER
TRADENAME:	BLUEFIRE R884P	BLUEFIRE R884P	R801 ZIRC PLUS	R801 ZIRC PLUS	R801 ZIRC PLUS
ABRASIVE:	Zirconia Alumina	Zirconia Alumina	Zirconia Alumina	Zirconia Alumina	Zirconia Alumina
BACKING:	Polyester 2-Ply Standard	Polyester 2-Ply Standard	Polyester 2-Ply Standard	Polyester 2-Ply Standard	Polyester 2-Ply Standard
OTHER:			Supersize	Supersize	Supersize
ATTACHMENT:	TS (Type II)	TR (Type III)	TS (Type II)	TR (Type III)	TP (Type I)

SIZE (D)	GRIT	STD. PKG.	PART #	PART #	PART #*	PART #*	PART #*
1	36	100				088341 67093 NS	
	40	100			088341 67052 NS	088341 67094 NS	
	50	100				088341 67095 NS	088341 67011 NS
	60	100	662611 38608			088341 67096 NS	088341 67012 NS
	80	100	662611 38607			088341 67097	088341 67013 NS
	120	100				088341 67099	088341 67015 NS
1-1/2	36	100	662611 38624	662611 21041		088341 67102	088341 67018 NS
	50	100				088341 67103	088341 67019 NS
	60	100	662611 38621	662611 21043	088341 67061	088341 67104	
	80	100	662611 38620	662611 21044	088341 67062	088341 67106	
2	24	100	662611 38638 *	662611 38672 *			
	36	100	662611 38637 *	662611 38671	088341 67065	088341 67107	088341 67023
	40	100			088341 67066	088341 67108	
	50	100	662611 38635 *	662611 38670 *	088341 65583	088341 67109	088341 67025
	60	100	662611 38634 *	662611 21048 *	088341 67068	088341 67110	088341 67026
	80	100	662611 38633 *	662611 21049 *	088341 67069	088341 67111	088341 67027
3	24	50	662611 38665 *	662611 38675 *			
	36	50	662611 38664 *	662611 38674 *	088341 67072	088341 67114	088341 67030
	40	50			088341 67073		
	50	50	662611 38662 *	662611 38673 *	088341 67074	088341 67116	088341 67032
	60	50	662611 38661 *	662611 21053 *	088341 67075	088341 67117	088341 67033
	80	50	662611 38660 *	662611 21054 *	088341 67076	088341 67118	088341 67034
4	120	50			088341 67078	088341 67120	
	36	50	662611 38683 *		088341 67079		
	50	50	662611 38681 *				
	60	50	662611 37343 *				088341 67040 NS
	80	50	662611 38679 *		088341 67083 NS		
	120	50			088341 67085 NS		

* Standard Package = 25 discs

NS Non-stock, contact your Norton representative for current order quantities and lead-times.

Quick-Change back-up pads shown at the end of the Quick-Change Disc section.





Quick-Change Test Kit "D"

- Part # 088341**65001**
- Includes 150 discs, assorted grits, in 1", 2", and 3" diameters and 3" back-up pads
- Primarily aluminum oxide cloth quick-change discs
- Several zirconia alumina and aluminum oxide FlexEdge discs are included

Aluminum Oxide Quick-Change Cloth Discs



TIER:	GOOD	GOOD	GOOD
ABRASIVE:	Aluminum Oxide	Aluminum Oxide	Aluminum Oxide
BACKING:	Polyester	Polyester	Polyester
	2-Ply Standard	2-Ply Standard	2-Ply Standard
ATTACHMENT:	TS (Type II)	TR (Type III)	TP (Type I)
			

SIZE (D)	GRIT	STD. PKG.	PART #	PART #	PART #	
3/4	40	100			699573 99739	
	50	100	699573 99604		699573 99740	
	60	100	699573 99605	699573 99673	699573 99741	
	80	100	699573 99606	699573 99674	699573 99742	
1	36	100	699573 99614	699573 99682	699573 99750	
	40	100			699573 99751	
	50	100	699573 99616		699573 99752	
	60	100	699573 99617	699573 99685	699573 99753	
	80	100	699573 99618	699573 99686	699573 99754	
	100	100	699573 99619	699573 99687	699573 99755	
	120	100	699573 99620	699573 99688	699573 99756	
	180	100	699573 99622	699573 99690	699573 99758	
240	100	699573 99623	699573 99691	699573 99759		
1-1/2	36	100	699573 99626	699573 99694	699573 99762	
	40	100	699573 99627	699573 99695	699573 99763	
	50	100	699573 99628	699573 99696	699573 99764	
	60	100	699573 99629	699573 99697	699573 99765	
	80	100	699573 99630	699573 99698	699573 99766	
	100	100	699573 99631	699573 99699		
	120	100	699573 99632	699573 99700	699573 99768	
	150	100			699573 99769	
	180	100	699573 99634	699573 99702	699573 99770	
	240	100	699573 99635	699573 99703		
2	24	100	699573 99637	699573 99705	699573 99773	
	36	100	699573 99638	699573 99706	699573 99774	
	40	100	699573 99639	699573 99707	699573 99775	
	50	100	699573 99640	699573 99708	699573 99776	
	60	100	699573 99641	699573 99709	699573 99777	
	80	100	699573 99642	699573 99710	699573 99778	
	100	100	699573 99643	699573 99711	699573 99779	
	120	100	699573 99644	699573 99712	699573 99780	
	150	100	699573 99645	699573 99713	699573 99781	
	180	100	699573 99646	699573 99714	699573 99782	
	240	100	699573 99647	699573 99715	699573 99783	
	320	100	699573 99648	699573 99716	699573 99784	
	3	24	50	699573 99649	699573 99717	699573 99785
		36	50	699573 99650	699573 99718	699573 99786
40		50	699573 99651	699573 99719	699573 99787	
50		50	699573 99652	699573 99720	699573 99788	
60		50	699573 99653	699573 99721	699573 99789	
80		50	699573 99654	699573 99722	699573 99790	
100		50	699573 99655	699573 99723	699573 99791	
120		50	699573 99656	699573 99724	699573 99792	
150		50	699573 99657	699573 99725		
180		50	699573 99658	699573 99726	699573 99794	
240		50	699573 99659	699573 99727	699573 99795	
320		50	699573 99660	699573 99728	699573 99796	
4		36	50	699573 99661	699573 99729	
		50	50		699573 99731	
	60	50	699573 99664		699573 99800	
	80	50		699573 99733	699573 99801	

Quick-Change back-up pads shown at the end of the Quick-Change Disc section.

Silicon Carbide Quick-Change Cloth Discs



TIER:	GOOD	GOOD	GOOD
TRADENAME:	R422	R422	R422
ABRASIVE:	Silicon Carbide	Silicon Carbide	Silicon Carbide
BACKING:	Cotton Standard	Cotton Standard	Cotton Standard
ATTACHMENT:	TS (Type II)	TR (Type III)	TP (Type I)



SIZE (D)	GRIT	STD. PKG.	PART #	PART #	PART #
2	40	100	088341 65252	088341 64275	
	60	100	088341 65254	088341 64163	088341 62168
	80	100	088341 65255	088341 66155	088341 62169
	120	100		088341 64837	088341 62171
	180	100	088341 65259	088341 67313	088341 62173
3	40	50	088341 65267	088341 64277	
	60	50		088341 64850	
	80	50		088341 66159	088341 62188
	120	50	088341 65272	088341 66160	088341 62190
	180	50	088341 65274	088341 68177	

Quick-Change back-up pads shown at the end of the Quick-Change Disc section.

Some part number are non-stock, contact your Norton representative for status, order quantities and lead-times.

Specialty Quick-Change Discs

Better choice for hard-to-grind areas where flexibility is not required



NORKUT ZIRCONIA ALUMINA POLYMER

- Durable zirconia alumina grain is resin bonded to a unique polymer backing which resists cracking and breaking; can be trimmed to the 1 Inch core
- Used with a quick change mandrel: 7/16-20 threaded for hand-held pneumatic grinders or 1/4 inch mandrel for automotive drills
- Use for deburring and blending; use the core to grind pinch welds and other hard-to-reach areas

TIER:	BETTER
TRADENAME:	NORKUT
ABRASIVE:	Zirconia Alumina
BACKING:	Extra HD Polymer
ATTACHMENT:	Threaded Hole

SIZE (D)	GRIT	STD. PKG.	PART #
NorKut Discs			
3	24	20	636425 03656
	36	20	636425 03657
	50	20	636425 03658

TIER:	BETTER
ATTACHMENT:	Threaded Hole

SIZE (D)	STD. PKG.	PART #
Mandrels		
7/16-20 Mandrel	5	636425 03659
1/4" Mandrel	5	636425 03660



Non-woven quick-change discs are a combination of strong synthetic mesh and quality abrasives, bonded together by a smear-resistant adhesive. The open construction of the non-woven material enables aggressive cutting action and improved surface finish while maintaining its non-loading feature.

- Applications:** Medium-light stock removal, beveling, deburring/deflashing, rust removal, blending, cleaning and finishing, polishing, and decorative finishing
- Size Range:** 3/4" – 4" diameter
- Grit Range:** X-Coarse, Coarse, Medium, Fine, Very Fine, Super Fine
- Abrasive Grain:** Ceramic Alumina, Engineered Aluminum Oxide, Aluminum Oxide, Silicon Carbide
- Attachment:** Quick-Change Type TR (Type III), Type TS (Type II)
- Back-up Pads:** Rubber with hardness variations for different applications
- Machine Used:**



MINI ANGLE SANDER

Quick-Change Attachment Systems and Cross Reference Guide

Each system enables quick, tool-free, safe disc changes, reducing downtime and operating expenses.

Type TS (Type II)

- Features a turn-on/turn-off style fastener
- Fastener is made of metal



Type TR (Type III)

- Features a roll-on/roll-off style fastener
- Fastener is made of plastic

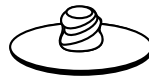

NORTON	TS	TR
3M	Roloc TS/TSM	Roloc TR
Standard	TS (SocAtt)	TR (Lockit)
Superior	Type S	Type R
Arc	Type S	Type R
Pferd	Type CD	Type CDR
Sait	SAIT-LOK	SAIT-LOK-R
Camel	Turn On	Roll On
Klingspor	QMC	QRC
Garryson	Type S	Type R

Application/Grit Recommendation Guide

MOST AGGRESSIVE

LEAST AGGRESSIVE

NORTON MERIT	Rapid Strip	Vortex Rapid Blend Deburring & Blending	Vortex Rapid Prep	Rapid Prep	HS Buffing, Buffing
Scale Removal	Best Choice				
Stock Removal	Best Choice	Second Choice			
Heavy Deburring	Second Choice	Best Choice			
Light Deburring		Best Choice	Second Choice		
Light Finishing			Best Choice	Second Choice	
Blending			Best Choice	Second Choice	
Cleaning			Second Choice	Best Choice	
Finishing				Best Choice	Second Choice

Cross Reference Guide

NORTON MERIT	STRIPPING		HEAVY/LIGHT DEBURRING		LIGHT DEBURRING/BLENDING/CLEANING/FINISHING		
	BEST	BETTER	BEST	BETTER	BEST	BETTER	BETTER
	Blaze Rapid Strip	Rapid Strip	Vortex Rapid Blend	Rapid Blend, Deburring & Blending	Vortex Rapid Prep	Rapid Prep	HS Buffing, Buffing
3M	Clean and Strip XT PRO, Clean and Strip XT PRO Extra Cut	Clean & Strip Clean Strip XT	Deburr and Finish PRO	EXL Unitized	SE	Surf Cond, SL	-
Standard	-	Cleaning Disc	-	500-900 Series Unitized	-	FE, GP, RC	Buff & Blend - HS, Buff & Blend
Fiberal/SIA	-	-	-	-	-	Meteor, Type B & C	-
Superior	-	Type R	-	XL Unitized	-	FD, GD, CC	HS, HD A/O
Arc	-	Arcstrip	-	-	-	Surface Cond	Blend & Finish
Pferd	-	Policlean	-	-	-	Finishing Disc - Hard & Soft	-
Sait	-	SAIT-Strip	-	-	-	HD, GP	Sand-Light Blending
Camel	-	EZ Strip - Black	-	-	-	-	-
Klingspor	-	-	-	-	-	-	-
Garryson	-	-	-	-	-	Surface Cond	-
Bibielle	-	Strip-It Black	-	BUR Unitized	-	DCR	-

Abrasive/Grit/Density Key

ABRASIVE	SILICON CARBIDE			ALUMINUM OXIDE		CERAMIC ALUMINA
	SHARPER, FINER/BRIGHTER SCRATCH PATTERN			MORE DURABLE, LONGER LASTING, POLISHED FINISH		
GRIT SIZE	XC (50)	C (60-80)	M (100-150)	F (180-220)	VF (240-360)	SF (400-600)
	FASTER, AGGRESSIVE CUT, ROUGHER FINISH			REDUCED CUT RATE, FINER FINISH		
DENSITY	2			9		
	SOFT, OPEN, CONFORMABLE, LESS BURNING/LOADING			HARDER, MORE DURABLE, FASTER CUTTING, BETTER FINISH		

3D Quick-Change Stripping Discs



Best choice for removing coatings on a variety of substrates, such as wood, metal and plastics

BLAZE RAPID STRIP CERAMIC ALUMINA

- Blaze ceramic grain cuts 2X faster than competitive discs; leaves a thoroughly cleaned surface, ensuring excellent adhesion in subsequent processes such as coating, painting and soldering
- Open web construction for minimal loading; great alternative to wire brushes
- Rapid Strip material provides a unique combination of aggressive performance, long life, and improved finish



Better choice for removing coatings on a variety of substrates, such as wood, metal and plastics

RAPID STRIP SILICON CARBIDE

- Sharp silicon carbide abrasive provides fast aggressive cutting action
- Open web construction for minimal loading; great alternative to wire brushes
- Advanced resin bond prevents shedding, snagging, gouging, and rework



TIER: **BEST**
 TRADENAME: **BLAZE RAPID STRIP**
 ABRASIVE: Ceramic Alumina
 GRADE: XC
 ATTACHMENT: TR (Type III)

TIER: **BETTER**
 TRADENAME: **RAPID STRIP**
 ABRASIVE: Silicon Carbide
 GRADE: XC
 ATTACHMENT: TR (Type III)



SIZE (DIAMETER)	MAX. RPM	STD. PKG.	PART #	STD. PKG.	PART #
2 x 1/2	15,500	25	666233 03912	10	662610 13402
3 x 1/2	12,000	25	662610 96557	10	662610 13403
4 x 1/2 TR+	8,000	5	666233 03921*	5	662610 16580*

*TR+ attachment show in the group image above

For unified wheels with arbor holes or spindle mounts, see Non-woven Unified Wheels section. Quick-Change back-up pads shown at the end of this section.

3D Quick-Change Deburring & Blending Discs

Best technology for heavy deburring and finishing



BLAZE RAPID BLEND CERAMIC ALUMINA

- Blaze SG ceramic alumina grain provides quickest cut rate and up to 8X longer life than competitive aluminum oxide discs
- Superior resin chemistry resists shedding when used on sharp edges; ideal for deburring
- Abrasive is distributed throughout the entire disc (top, bottom and side) so all three faces can be used versus competitive discs with one bottom layer of abrasive

Best choice for weld blending, polishing and deburring



VORTEX RAPID BLEND ALUMINUM OXIDE

- Patented Vortex agglomerated aluminum oxide grain provides the cutting power of a coarser grit with the finish of finer grits
- Special resin bond for consistent performance with no smearing
- Abrasive is distributed throughout the entire disc (top, bottom and side) so all three faces can be used versus competitive discs with one bottom layer of abrasive

Better choice for light deburring, blending, and cleaning



RAPID BLEND NEX ALUMINUM OXIDE

- Quality aluminum oxide delivers durability and long life
- Resin formula delivers smear-free finishes
- Abrasive is distributed throughout the entire disc (top, bottom and side) so all three faces can be used – versus competitive discs' one bottom layer of abrasive

3D Quick-Change Deburring & Blending TS Discs



TIER:	BEST	BEST
TRADENAME:	BLAZE RAPID BLEND	VORTEX RAPID BLEND
ABRASIVE:	Ceramic Alumina	Engineered Aluminum Oxide
ATTACHMENT:	TS (Type II)	TS (Type II)



SIZE (D x T)	ABRASIVE	GRIT	DENSITY	MAX. RPM	STD. PKG.	PART #	PART #
1 x 1/4	Ceramic Alumina	XC	1	35,000	100	666233 13920	
1-1/2 x 1/4	Ceramic Alumina	XC	1	35,000	80	666233 13922	
2 x 1/4	Ceramic Alumina	XC	1	22,000	25	666233 13925	
	Aluminum Oxide	M	1	22,000	25		662544 97070
3 x 1/4	Ceramic Alumina	XC	1	15,000	25	666233 13931	
	Aluminum Oxide	M	1	15,000	25		662544 97069

3D Quick-Change Deburring & Blending Discs *continued*

3D Quick-Change Deburring & Blending TR Discs



TIER:	BEST	BEST	BETTER
TRADENAME:	BLAZE RAPID BLEND	VORTEX RAPID BLEND	RAPID BLEND NEX
ABRASIVE:	Ceramic Alumina	Engineered Aluminum Oxide	Aluminum Oxide
ATTACHMENT:	TR (Type III)	TR (Type III)	TR (Type III)

SIZE (D x T)	ABR.	GRIT	DENSITY	MAX. RPM	STD. PKG.	PART #	PART #	PART #	
1 x 1/4	Ceramic Alumina	XC	1	35,000	100	6662331 3919			
1-1/2 x 1/4	Ceramic Alumina	XC	1	35,000	80	6662331 3921			
2 x 1/8	Aluminum Oxide	M	4-6	22,000	60		662544 25632		
	Aluminum Oxide	M	7-9	22,000	60		662544 33509		
2 x 3/16	Aluminum Oxide	M	2-3	22,000	60		662544 28236		
2 x 1/4	Ceramic Alumina	XC	1	22,000	25	6662331 3923			
	Aluminum Oxide	C	7-9	22,000	60			662610 14921	
	Aluminum Oxide	M	1	22,000	25		662544 97067		
	Aluminum Oxide	M	2-3	22,000	60		662544 28237	662610 14897	
	Aluminum Oxide	M	4-6	22,000	60		662544 13660	662610 14911	
	Aluminum Oxide	M	7-9	22,000	60		662544 433510	662610 14935	
	Silicon Carbide	F	2	22,000	60			662610 14889	
	Silicon Carbide	F	3	22,000	60			662610 17306	
	3 x 1/8	Aluminum Oxide	M	4-6	15,000	40		662610 93556	
		Aluminum Oxide	M	7-9	15,000	40		662610 90909	
3 x 3/16	Aluminum Oxide	M	7-9	15,000	40		662544 28239		
3 x 1/4	Ceramic Alumina	XC	1	15,000	25	6662331 3930			
	Aluminum Oxide	C	7-9	15,000	40			662610 14922	
	Aluminum Oxide	M	1	15,000	25		662544 97068		
	Aluminum Oxide	M	2-3	15,000	40		662544 28238	662610 14898	
	Aluminum Oxide	M	4-6	15,000	40		662544 13661	662610 14912	
	Aluminum Oxide	M	7-9	15,000	40		662544 06395	662610 14936	
	Aluminum Oxide	F	4-6	15,000	40			662610 15419	
	Silicon Carbide	F	2	15,000	40			662610 14890	
	Silicon Carbide	F	3	15,000	40			662610 16005	

For unified wheels with arbor holes or spindle mounts, see the Non-woven Unified Wheel section. Quick-Change back-up pads shown at the end of this section.

Quick-Change Surface Preparation Discs

Best choice for aggressive stock removal and blending in one step



RAPID PREP XHD

- Coarse and Medium discs solve your most aggressive stock removal and blending challenges, remove weld lines, weld spatter, weld discoloration and blend surfaces in a single step
- Improve cut control and surface blending over traditional coated discs with our unique combination of a conformable fiber matrix and premium ceramic grain
- XHD Coarse discs for aggressive weld removal and surface blending on steels and Medium discs on softer metals/ alloys

TIER: **BEST**
 TRADENAME: **RAPID PREP XHD**
 ABRASIVE: Ceramic Alumina
 ATTACHMENT: TR (Type III)



SIZE (DIAMETER)	MAX. RPM	STD. PKG.	PART #
Coarse			
2	20,000	50	662611 70271
3	18,000	25	662611 70273
4	12,000	25	662611 70274
Medium			
2	20,000	50	662611 70285
3	18,000	25	662611 70286
4	12,000	25	662611 70287



Quick-Change Surface Preparation Discs



Best choice for finishing and blending applications

VORTEX RAPID PREP





- Proprietary engineered Vortex aluminum oxide abrasive grain and coating method combine maximum cutting speed with the consistent finish of finer grits to reduce process times by 50+% by combining multiple grit sequences to 1 step
- Premium high-loft nylon fiber bonded to a strong nylon scrim backing allows a thick layer of resin bond and grain for extended life and provides added durability and stiffness
- Proprietary Clean Bond resin technology guarantees smear-free finishes even on high nickel content alloys and reduces loading on aluminum and other soft metals



Better choice for finishing and blending applications

RAPID PREP ALUMINUM OXIDE

- Quality aluminum oxide abrasive grain coating provides up to 20% higher cut rate and 50% better performance than competitive products
- Thick layer of grain throughout the product extends life; grain does not sit on top of fibers as it does with other competitive products
- Proprietary Clean Bond resin technology guarantees smear-free finishes even on high nickel content alloys and reduces loading on aluminum and other soft metals

TIER:	BEST	BETTER	BEST	BETTER
TRADENAME:	VORTEX RAPID PREP	RAPID PREP	VORTEX RAPID PREP	RAPID PREP
ABRASIVE:	Engineered A/O	Aluminum Oxide	Engineered A/O	Aluminum Oxide
ATTACHMENT:	TR (Type III)	TR (Type III)	TS (Type II)	TS (Type II)
				

SIZE (DIAM.)	MAX. RPM	STD. PKG.	PART #	PART #	PART #	PART #
Extra Coarse						
3/4	25,000	50	666233 25001	666233 40002	666233 35324	
1	25,000	50	666233 25004		666233 25003	666233 40006
1-1/2	20,000	50	666233 25007	666233 40011	666233 25006	666233 40010
2	20,000	50	666233 35326	662610 16373	666233 35325	662610 17819
3	18,000	25	666233 35327	662610 16994	666233 25010	662610 17818
4	12,000	25	666233 35329	662610 16374		
Coarse						
3/4	25,000	50	666233 25013	666233 40021	666233 35410	662610 09515
1	25,000	50	666233 25015	666233 40023	666233 35537	662610 24310
1-1/2	20,000	50	666233 35411	662610 47579	666233 25017	666233 40026
2	20,000	50	666233 35414		666233 35413	662610 09183
3	18,000	25	666233 35417	662610 09194	666233 35416	662610 09186
4	12,000	25	666233 35419	662610 08822		
Medium						
3/4	25,000	50	666233 25020	666233 40032	666233 35420	662544 28059
1	25,000	50	666233 35422	662544 82331	666233 35421	662544 82327
1-1/2	20,000	50	666233 35424	666233 35423	666233 35423	662544 82328
2	20,000	50	666233 35427	662610 09190*	666233 35426	662610 09182
3	18,000	25	666233 35430	662610 17522	666233 35429	662610 09185
4	12,000	25	666233 35432	662610 08821		662610 55350
Fine						
3/4	25,000	50	666233 25026	666233 40058	666233 25025	
1	25,000	50	666233 25029	666233 40064	666233 25028	666233 40062
1-1/2	20,000	50	666233 25032	666233 40070	666233 25031	666233 40068
2	20,000	50	666233 25035	666233 40077	666233 25034	666233 40074
3	18,000	25	666233 25038	666233 40085	666233 25037	666233 40082
4	12,000	25	666233 25041	666233 40092		
Very Fine						
3/4	25,000	50	666233 25044	666233 40044	666233 25043	666233 40042
1	25,000	50	666233 25047	662544 82339	666233 25046	662544 82335
1-1/2	20,000	50	666233 25050	662544 82340	666233 25049	662544 82336
2	20,000	50	666233 35433	662610 09189*	666233 25052	662544 82337
3	18,000	25	666233 35437	662610 09192	666233 35436	662610 09184
4	12,000	25		666233 40053		
Super Fine						
2	20,000	50		662610 091459		
3	18,000	25		662610 091460		

* 25 per standard package.



Quick-Change Buffing/Polishing Discs



Best choice for light removal of paint or rust

BUFFING/POLISHING DISCS

- This aluminum oxide grain and resin bond combination produce a smooth cut rate and smear-free, uniform finish
- Non-woven nylon fibers are laminated to tough yet conformable nylon backing that resists tearing on burrs and sharp edges
- Designed for light removal of coatings oxidation or rust without affecting the base product

TIER:	BEST
TRADENAME:	HIGH-STRENGTH
ABRASIVE:	Aluminum Oxide
ATTACHMENT:	TR (Type III)

BEST	BEST	BETTER	BETTER
HIGH-STRENGTH	HIGH-STRENGTH	BUFFING	BUFFING
Aluminum Oxide	Aluminum Oxide	Aluminum Oxide	Aluminum Oxide
TR (Type III)	TS (Type II)	TR (Type III)	TS (Type II)

SIZE (D)	GRIT	MAX. RPM	STD. PKG.	PART #	STD. PKG.	PART #	PART #	PART #	PART #
1-1/2	M	20,000			100			088341 66368	088341 66392
	F	20,000			100			088341 66369	
2	C	18,000			50			088341 61649	088341 66394
	M	18,000	160	662610 14792	50	088341 64064	088341 64244	088341 66303	088341 66395
	F	18,000			50			088341 66304	088341 66396
	VF	18,000			50	088341 63987	088341 64245	088341 66305	088341 66405
3	C	12,000			25			088341 61651	088341 66397
	M	12,000	80	662610 14793	25	088341 64065	088341 64252	088341 66308	088341 66398
	F	12,000			25			088341 66309	088341 66399
	VF	12,000			25	088341 63559	088341 64255	088341 66310	088341 66403

Quick-Change Back-up Pads

- Hard density pads are for aggressive cutting action
- Medium density pads are for all-purpose applications
- Soft density pads are used for contours and fine finishing work

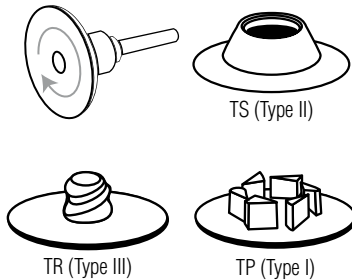

SIZE (DIAMETER)	DENSITY	MAX. RPM	STD. PKG.	TS (TYPE II)	TR (TYPE III)	TP (TYPE I)
Quick-Change Back-up Pads						
9/16		40,000	1	662610 54014 NS		662610 54013 NS
3/4	Medium	40,000	1	088341 64206	088341 64038	088341 64001
1	Medium	40,000	1	088341 64651	088341 64037	088341 64002
1-1/2	Hard	30,000	1	088341 64622		088341 63996
2	Medium	30,000	1	088341 64146	088341 61174	088341 64003
	Hard	30,000	1	088341 64624	088341 64643	088341 63997
	Medium	30,000	1	088341 64198	088341 64922	088341 64004
3	Soft	30,000	1	088341 61625	088341 64641	088341 63949
	Hard	20,000	1	088341 61626	088341 64036	088341 63998
	Medium	20,000	1	088341 64113	088341 64949	088341 64005
4	Soft	20,000	1	088341 64626	088341 64644	088341 63948
	Medium	15,000	1	088341 64135	088341 64655	
4	Medium	8,000	1		636425 55106	
Vendible Quick-Change Back-up Pads						
2	Medium	30,000	5	6662334 1082	6662334 1083	
3	Medium	20,000	5		6662334 1085	

All Quick-Change back-up pads have a 1/4" solid steel shank.

NS Non-stock. Contact your Norton representative for current order quantities and lead-times.

Vendible back-up pad Std. Pkg. Qty: 1 pad per pack; 5 packs per carton. Order in multiples of 5.



Replacement Medium Density Rubber Pads for Quick-Change TP (Type I) Back-up Pads

- When the rubber pad has worn away, but the steel components of your quick-change back-up are still serviceable, order these replacement rubber pads.

SIZE (D)	MODEL #	STD. PKG.	PART #
Quick-Change Replacement Rubber Back-up Pads			
3/4	RR75	1	088341 64008 NS
1	RR10	1	088341 64009 NS
4	RR40	1	088341 64013 NS

NS Non-stock. Contact your Norton representative for current order quantities and lead-times.

Replacement Assemblies and Shanks for Quick-Change Back-up Pad

- Assemblies replace all the steel components of a quick-change back-up pad. This shank replaces the screw-in 1/4" solid steel shank only.

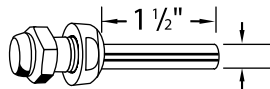

DESCRIPTION	STD. PKG.	PART #
Replacement Mandrels and Nut Assembly		
TP (Type I) Assembly RMN3 for 3 - 4	1	088341 64016 NS
TS (Type II) & TR (Type III) Replacement 1/4" Shank	1	088341 64303

NS Non-stock. Ask your Norton representative for current order quantities and lead-times

Extension Mandrels and Assembly

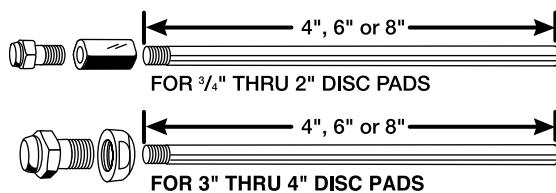

DIAMETER	MODEL #	LENGTH	STD. PKG.	PART #
Extension Mandrels and Assembly - TP (Type I)				
3/4 - 2	EMN-14	4"	1	088341 64017 NS
3/4 - 2	EMN-16	6"	1	088341 64018 NS
3/4 - 2	EMN-18	8"	1	088341 64019 NS
3 - 4	EMN-34	4"	1	088341 64020 NS
3 - 4	EMN-36	6"	1	088341 64026 NS
3 - 4	EMN-38	8"	1	088341 64021 NS

All extension mandrels are non-stock, Contact your Norton representative for current order quantities and lead-times.

MNA-1 Pad Adapters

- Convert a TP (Type I) back-up pad 1/4" diameter solid shank to a threaded shank

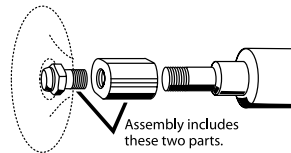

DISC DIAMETER	MODEL NO.	STD. PKG.	PART #
MNA-1 Pad Adapters - TP (Type I)			
3/4 - 2	MNA 1/4-20 THD.	1	088341 61176 NS
3/4 - 2	MNA 3/8-24	1	088341 64055 NS
3/4 - 2	MNA 5/8-11	1	088341 63001 NS
3 - 4	MNA 1/4-20	1	088341 63002 NS
3 - 4	MNA 3/8-24	1	088341 64041 NS
3 - 4	MNA 5/8-11	1	088341 64028 NS

All pad adapters are non-stock. Contact your Norton representative for current order quantities and lead-times.

MNA-23 Pad Adapters

- For use on a right angle grinder: convert TS (Type II) and TR (Type III) back-up pad 1/4" diameter solid shanks to threaded shanks.
- The larger 5/8"-11 adapter (for 4-1/2" discs) is used alone to convert to a 5/8"-11 thread.
- The 3/8"-24 insert (for 4" discs) is screwed into the 5/8"-11 adapter to create a 3/8"-24 thread adapter.

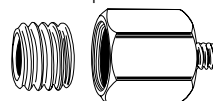

DISC DIAMETER	MODEL #	STD. PKG.	PART #
MNA-23 Pad Adapters - TS (Type II) and TR (Type III)			
3/4 - 4	MNA-23 3/8"-24 and 5/8"-11 THD.	1	088341 62764 NS

NS Non-stock. Ask your Norton representative for current order quantities and lead-times

1/4" Diameter Extension Mandrel

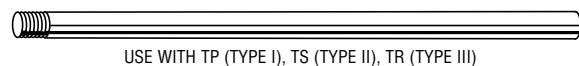

USE WITH TP (TYPE I), TS (TYPE II), TR (TYPE III)

MODEL NO.	LENGTH	STD. PKG.	PART #
1/4" Diameter Extension Mandrel 1/4-20 Thread			
EM-144	4"	1	088341 54185
EM-146	6"	1	088341 54186
EM-148	8"	1	088341 54187



Our new Norton pneumatic die grinder quickly and comfortably accomplishes many portable applications without changing machines – including jobs for abrasive specialties (cartridge and spiral rolls...), small diameter flap wheels, mounted points, and carbide burrs.

- Weight of tool:** 1.4 lbs.
- Compressed air:** 6.2 bar (90psi)
- Maximum permissible operating pressure:** 6.2 bar (90psi)
- Recommended operating pressure:** 6.2 bar (90psi)
- Horsepower:** 0.9HP
- Free speed:** 25,000 rpm
- Air consumption @90psi:** 85 l/min (3 CFM)
- Noise characteristic value in accordance with EN ISO 15744 (ISO 15744):**
 - A-weighted sound pressure level at workstation 87.3 dB
 - A-weighted sound power level 98.3 dB
 - Peak C-weighted instantaneous sound pressure level at workstation < 130 dB
 - Measurement uncertainty (Standard) 3 dB
- Vibration value according to EN ISO 28927-12:** 3.00 m/s²
- Measurement uncertainty (Standard):** 0.84 m/s²
- Recommended lubrications:** Air drill oil 20#
- Sanding tool specifications:** Pad Size 2" Collet
Chuck 1/8" (3 mm) and 1/4" (6 mm)
- Applications and suitability:** Final surface finishing, chamfering, deburring of architectural millwork, sheet metal and surface prep, zinc casting, aluminum products, injection molds, etc.; general sanding and polishing.

Put the power right in the palm of your hand with our die grinder



PNEUMATIC DIE GRINDER

- Comfortable during prolonged use thanks to vibration-limiting technology, ergonomic design, and streamlined non-slip grip
- Adaptable to the needs of each job with speed regulation and two collet inserts in 1/8" and 1/4"
- Compatible with many accessories including cartridge rolls, spiral rolls, square pads, cross pads, overlap slotted discs, flap wheels, mounted points and carbide burrs

DESCRIPTION	STD. PKG.	PART #
Norton Pneumatic Die Grinder		
Single Die Grinder with 1/8" and 1/4" collets	1	699573 08000
Die Grinder Kit*	1	699573 08001
Kit includes:		
1 die grinder with 1/8" and 1/4" collets		
100 – 3/8" x 1-1/2" x 1/8", 80 grit Metal R228 cartridge rolls (088341 80232)		
1- M9 cartridge roll mandrel (088341 81209)		
10 – 1" x 1" x 1/4" shank, 60 grit Blaze R920 flap wheels (662611 51170)		
5 – 1" x 1" W220, 1/4" x 1-1/2" spindle Gemini 38A60-P mounted points (614636 24566)		
1 – 1/2" x 1" SF5 Double-Cut carbide burr (699573 08021)		





Cartridge rolls are strips of abrasive cloth rolled and glued to form a solid shape that is designed to break down during use and reveal the next layer of abrasive. A valuable abrasive tool for reaching into corners, where larger diameter tools cannot work

- Applications:** Used on inside surfaces and inside corners where other abrasive shapes cannot reach. Typically these are used on high-speed air grinders and are always mounted on a mandrel. Ideal for flash removal, polishing or removing machine tool marks, and edge breaking.
- Stock Shapes:** Cartridge rolls, half-glued
- Grit Range:** 36 - 320
- Abrasive Grain:** Ceramic Alumina, Aluminum Oxide
- Backing:** X-weight cotton, X-weight poly-cotton
- Construction:** All cartridge roll part numbers shown are resin bond, half-glued. Quarter and full glue are also available for quotation as made-to-order products.
- Maximum RPM:** 1/8" to 1/2" – 23,000
5/8" to 1" – 18,000
1" to 1-1/2" – 15,000
- Machine Used:**  DIE GRINDER

Application/Grit Recommendation Guide

COARSER (GRINDING) ←					FINER (FINISHING) →				
36	40	50	60	80	120	180	240	320	
Blending Out Heavy Machine Marks									
Removing Heavy Burrs									
Applying Heavy Scratch Pattern									
Removing Flash/Parting Lines									
Removing Rust/Scale/Pit Marks									
		Preparing Metal for Painting							
		Blending Out Medium Machine Marks							
				Blending Metal Surfaces					
				Applying Light Scratch Pattern					
						Fine Blending and Cleaning			
							Metal Finishing and Polishing		

Best choice for hard-to-grind materials including super alloys (cobalt, inconel, and titanium) and stainless steel



BLAZE R920 CERAMIC ALUMINA

- Premium ceramic alumina abrasive grain provides greatest productivity with significantly faster cut rates; resists wear resulting in 50% – 300% longer life; supersized for cool cutting
- X-weight cotton cloth provides extended durability, conformability, and superior wear resistance; strong resin bond system provides good grain retention and life
- Constructed of rolled and half-glued abrasive strips that break down to expose next layer of abrasive

Better choice for accessing tight areas and where long life & fast cut are required



NEW

PINK R928 CERAMIC ALUMINA

- Excellent option for reaching into corners and small areas, ceramic grain provides better performance than aluminum oxide or zirconia alumina alternatives
- Improved resin bond system provides longer life; supersized for cool cutting
- Versatile X-weight poly cotton backing for flexibility and life

Good starting specification for flash removal, polishing, or removing machine tool marks and edge breaking on all types of metal



R228 ALUMINUM OXIDE

- Quality aluminum oxide abrasive delivers long life
- X-weight cotton cloth provides extended durability, conformability, and superior wear resistance; strong resin bond system provides good grain retention and life
- Constructed of rolled and half-glued abrasive strips that break down to expose next layer of abrasive



TIER:	BEST	BETTER
TRADENAME:	BLAZE R920	PINK R928
ABRASIVE:	Ceramic Alumina	Ceramic Alumina
OTHER:	Supersize	Supersize

SIZE (D x L x H)	GRIT	STD. PKG.	PART #	PART #
1/4 x 1-1/2 x 1/8	60	100	662611 94384	699573 39765
Use M-9 Mandrel	80	100	662611 94394	699573 39766
	120	100	662611 94397	699573 39767
3/8 x 1-1/2 x 1/8	60	100	662611 94392	699573 39768
Use M-9 Mandrel	80	100	662611 94395	699573 39769
	120	100	662611 94398	699573 39770
1/2 x 1-1/2 x 1/8	60	100	662611 94393	699573 39771
Use M-9 Mandrel	80	100	662611 94396	699573 39772
	120	100	662611 94399	699573 39774



TIER:	GOOD
TRADENAME:	R228
ABRASIVE:	Aluminum Oxide

SIZE (D x L x H)	GRIT	STD. PKG.	PART #
3/16 x 3/4 x 3/32	80	100	088341 80005
3/16 x 1 x 3/32	60	100	088341 80023
Use M-2E Mandrel	80	100	088341 80024
	100	100	088341 80025
	120	100	088341 80026
	150	100	088341 80027
	180	100	088341 80028
	240	100	088341 80030
1/4 x 3/4 x 1/8	60	100	088341 80042
Use M-3 or M-7 Mandrel	80	100	088341 80043
1/4 x 1 x 1/8	50	100	088341 80060
Use M-4 or M-8 Mandrel	60	100	088341 80061
	80	100	088341 80062
	100	100	088341 80063
	120	100	088341 80064
	150	100	088341 80065
	180	100	088341 80066
	320	100	088341 80070
1/4 x 1-1/2 x 1/8	50	100	088341 80079
Use M-9 Mandrel	60	100	088341 80080
	80	100	088341 80081
	100	100	088341 80082
	120	100	088341 80083
	150	100	088341 80084
	180	100	088341 80085
	320	100	088341 80089
1/4 x 2 x 1/8	80	100	088341 80100
Use M-10 Mandrel	120	100	088341 80102
5/16 x 1 x 1/8	80	100	088341 80138
Use M-4 or M-8 Mandrel	120	100	088341 80140
5/16 x 1-1/2 x 1/8	80	100	088341 80157
Use M-9 Mandrel			

Some part numbers are non-stock; contact your Norton representative for status, order quantities and lead-times.

Continued



TIER:	GOOD
TRADENAME:	R228
ABRASIVE:	Aluminum Oxide

SIZE (D x L x H)	GRIT	STD. PKG.	PART #
3/8 x 3/4 x 1/8	120	100	088341 80197
Use M-7 Mandrel			
3/8 x 1 x 1/8	60	100	088341 80213
Use M-8 Mandrel	80	100	088341 80214
	100	100	088341 80215
	120	100	088341 80216
	150	100	088341 80217
	180	100	088341 80218
	240	100	088341 80220
3/8 x 1-1/2 x 1/8	36	100	088341 80228
Use M-9 Mandrel	40	100	088341 80229
	50	100	088341 80230
	60	100	088341 80231
	80	100	088341 80232
	100	100	088341 80233
	120	100	088341 80234
	180	100	088341 80236
	240	100	088341 80238
	320	100	088341 80240
3/8 x 2 x 1/8	60	100	088341 80250
Use M-10 Mandrel	80	100	088341 80251
	120	100	088341 80253
1/2 x 3/4 x 1/8	80	100	088341 80270
Use M-7 Mandrel			
1/2 x 1 x 1/8	50	100	088341 80287
Use M-8 Mandrel	60	100	088341 80288
	80	100	088341 80289
	100	100	088341 80290
	120	100	088341 80291
	150	100	088341 80292
	180	100	088341 80293
	240	100	088341 80295

Continued

Refer to the back of this section for mandrels.



TIER: **GOOD**
TRADENAME: **R228**
ABRASIVE: Aluminum Oxide

SIZE (D x L x H)	GRIT	STD. PKG.	PART #
1/2 x 1-1/2 x 1/8 Use M-9 Mandrel	36	100	088341 80304
	40	100	088341 80305
	50	100	088341 80306
	60	100	088341 80307
	80	100	088341 80308
	100	100	088341 80309
	120	100	088341 80310
	150	100	088341 80311
	180	100	088341 80312
	240	100	088341 80314
1/2 x 2 x 1/8 Use M-10 Mandrel	320	100	088341 80316
	60	100	088341 80326
	80	100	088341 80327
1/2 x 2 x 3/16 Use M-17 Mandrel	120	100	088341 80329
	60	100	088341 80350
	80	100	088341 80653
1/2 x 2 x 1/4 Use M-22 Mandrel	120	100	088341 80338
	80	100	088341 80351
5/8 x 1 x 3/16 Use M-15 Mandrel	80	100	088341 80364
5/8 x 1-1/2 x 1/8 Use M-9 Mandrel	60	100	088341 80275
	80	100	088341 80789
	120	100	088341 80394
5/8 x 1-1/2 x 3/16 Use M-16 Mandrel	60	100	088341 80382
	80	100	088341 80383
5/8 x 2 x 1/8 Use M-10 Mandrel	60	100	088341 82505
	80	100	088341 81080
5/8 x 2 x 3/16 Use M-10 Mandrel	50	100	088341 80400
	60	100	088341 80401
	80	100	088341 80402
3/4 x 1 x 1/8 Use M-8 Mandrel	80	100	088341 80469
	120	100	088341 81543
3/4 x 1 x 3/16 Use M-15 Mandrel	80	100	088341 80459
	120	100	088341 80461

Some part numbers are non-stock; contact your Norton representative for status, order quantities and lead-times.
Continued



TIER: **GOOD**
TRADENAME: **R228**
ABRASIVE: Aluminum Oxide

SIZE (D x L x H)	GRIT	STD. PKG.	PART #
3/4 x 1-1/2 x 1/8 Use M-9 Mandrel	60	100	088341 80490
	80	100	088341 80527
	120	100	088341 80487
3/4 x 1-1/2 x 3/16 Use M-16 Mandrel	36	100	088341 80474
	50	100	088341 80476
	60	100	088341 80477
	80	100	088341 80478
	120	100	088341 80480
3/4 x 1-1/2 x 1/4 100/box 400/case Use M-21 Mandrel	180	100	088341 80482
	36	100	088341 80907
	60	100	088341 80489
	80	100	088341 80358
1/2 x 2 x 1/8 Use M-10 Mandrel	120	100	088341 80488
	150	100	088341 82807
	60	100	088341 80791
	3/4 x 2 x 3/16 Use M-17 Mandrel	40	100
60		100	088341 80496
80		100	088341 80497
100		100	088341 80498
120		100	088341 80499
3/4 x 2 x 1/4 Use M-22 Mandrel	60	100	088341 80506
	80	100	088341 81297
	100	100	088341 80509
1 x 1-1/2 x 1/8 Use M-9 Mandrel	120	100	088341 80507
	80	100	088341 80584
	1 x 1-1/2 x 1/4 Use M-21 Mandrel	36	100
60		100	088341 80587
80		100	088341 80583
1 x 2 x 3/16 Use M-17 Mandrel	60	100	088341 80591
	80	100	088341 80592
1 x 2 x 1/4 Use M-22 Mandrel	60	100	088341 80603
	80	100	088341 80606

Refer to the back of this section for mandrels.



Spiral rolls are strips of abrasive cloth rolled and glued to form a solid shape that is designed to break down during use and reveal the next layer of abrasive.

Applications:

Used on inside surfaces and inside corners where other abrasive shapes cannot reach. Typically these are used on high-speed air grinders and are always mounted on a mandrel. Ideal for flash removal, polishing, or removing machine tool marks, and edge breaking.

Shapes:

Full taper (all stock part numbers), half taper, and sidewall taper

Grit Range:

36 - 240

Abrasive Grain:

Ceramic Alumina, Aluminum Oxide

Backing:

X-weight cotton, X-weight poly cotton

Construction:

All spiral roll part numbers shown are full tapered, resin bond, half glued
Half-tapered and sidewall-tapered are available for quotation as made-to-order products
Quarter and full glue are also available for quotation as made-to-order products

Maximum RPM:

1/8" to 1/2" - 23,000

5/8" to 1" - 18,000

1" to 1-1/2" - 15,000

Machine Used:

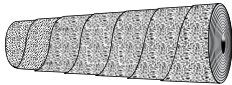

Full Taper

- Especially useful for grinding/polishing of channels, fillets and radii, and deburring small holes
- Full taper used when the area to be finished is hard to reach with a full cartridge roll
- The tapered roll conforms to smaller areas
- Fits into irregular concaves, contours, channels

All part numbers shown are full tapered

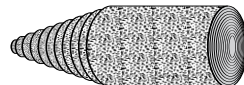

Half Taper

- Used when the area to be finished is not narrow but a beginning point on the roll is needed
- The portion of the roll that is not tapered is then used to finish off the sides

Available for quotation as made-to-order products



Sidewall Taper

- The portion of the roll that is tapered guides the roll down to the area to be finished
- The sidewall then finishes off the sides

Available for quotation as made-to-order products

Application/Grit Recommendation Guide

COARSER (GRINDING)					FINER (FINISHING)			
36	40	50	60	80	120	180	240	320
Blending Out Heavy Machine Marks								
Removing Heavy Burrs								
Applying Heavy Scratch Pattern								
Removing Flash/Parting Lines								
Removing Rust/Scale/Pit Marks								
		Preparing Metal for Painting						
		Blending Out Medium Machine Marks						
				Blending Metal Surfaces				
				Applying Light Scratch Pattern				
						Fine Blending and Cleaning		
							Metal Finishing and Polishing	



Best choice for hard-to-grind materials including super alloys (cobalt, inconel, and titanium) and stainless steel

BLAZE R920 CERAMIC ALUMINA

- See significantly faster, cooler, burn-free results on the toughest jobs from the premium, sharp, longest-lasting P-graded ceramic abrasive grains and advanced grinding aid lubricant; supersized for cool cutting
- X-weight cotton cloth provides extended durability, conformability, and superior wear resistance; strong resin bond system provides good grain retention and life
- Full taper construction consisting of rolled and half-glued abrasive strips that break down to expose next layer of abrasive



NEW

Better choice for accessing tight areas and where long life and fast cut are required

PINK R928 CERAMIC ALUMINA

- Excellent option for reaching into corners and small areas, ceramic grain provides better performance than aluminum oxide or zirconia alumina alternatives
- Improved resin bond system provides longer life; supersized for fast cutting
- Versatile X-weight poly cotton backing for flexibility and life

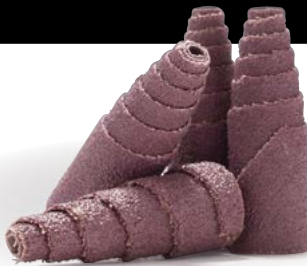

Good choice for cooler grinding/polishing of channels, fillets and radii, and deburring small holes at a low initial price

R228 ALUMINUM OXIDE

- Quality aluminum oxide abrasive delivers long life
- X-weight cotton cloth provides extended durability, conformability, and superior wear resistance; strong resin bond system provides good grain retention and life
- Full taper construction consisting of rolled and half-glued abrasive strips that break down to expose next layer of abrasive





TIER:	BEST	BETTER	GOOD
TRADENAME:	BLAZE R920	PINK R928	R228
ABRASIVE:	Ceramic Alumina	Ceramic Alumina	Aluminum Oxide
OTHER:	Supersize	Supersize	

SIZE (D x L x H)	GRIT	STD. PKG.	PART #	PART #	PART #
3/8 x 1 x 1/8 Use M-8 Mandrel	60	100			088341 81714
	80	100			088341 81715
	120	100			088341 81717
3/8 x 1-1/2 x 1/8 Use M-9 Mandrel	60	100	662611 94481	699573 39775	088341 81724
	80	100	662611 94490	699573 39785	088341 81708
	120	100	662611 94491	699573 39787	088341 81727
	180	100			088341 81709
1/2 x 1 x 1/8 Use M-8 Mandrel	60	100			088341 81734
	80	100			088341 81735
	120	100			088341 81737
1/2 x 1-1/2 x 1/8 Use M-9 Mandrel	36	100			088341 81230
	50	100			088341 81743
	60	100	662611 94484	699573 39790	088341 81744
	80	100	662611 94492	699573 39791	088341 81745
	100	100			088341 81746
	120	100	662611 94495	699573 39792	088341 81747
	180	100			088341 81749
240	100			088341 81750	
1/2 x 2 x 1/8 Use M-10 Mandrel	60	100			088341 81754
	80	100			088341 81755
	120	100			088341 81757
5/8 x 1-1/2 x 1/8 Use M-9 Mandrel	100	100			088341 81776
	120	100			088341 81777
5/8 x 1-1/2 x 3/16 Use M-16 Mandrel	80	100			088341 81444
3/4 x 1-1/2 x 1/8 Use M-9 Mandrel	60	100			088341 81286
	80	100			088341 80886
3/4 x 1-1/2 x 3/16 Use M-16 Mandrel	60	100			088341 81808
	80	100			088341 81809
	120	100			088341 81811
3/4 x 2 x 3/16 Use M-17 Mandrel	60	100			088341 81820
1 x 1-1/2 x 1/8 Use M-9 Mandrel	60	100		699573 39790	088341 81240
1 x 2 x 3/16 Use M-17 Mandrel	36	100			088341 81875
	60	100			088341 81878
	80	100			088341 81879

Some part numbers are non-stock; contact your Norton representative for status, order quantities and lead-times.

Refer to the back of this section for mandrels.



Square pads, cross pads and overlap slotted discs are all used on high-speed pneumatic tools for deburring, blending, cleaning, and polishing applications. All of these abrasive specialties are designed for applications in small, tight, hard-to-access locations on parts that are being finished.

Benefits:

Variety of shapes and sizes to fit application and part geometry
Shapes provide flexibility for the application, while eliminating aggressiveness of the sanding action
Cross pads allow visibility of the surface while sanding, to ensure correct amount of material is removed

Grit Range:

50 – 180

Abrasive Grain:

Ceramic Alumina, Aluminum Oxide

Backing:

X-weight cotton, X-weight poly-cotton

Construction

Standard quick-change eyelet for easy mounting and removal on quick-change mandrel minimizes downtime; Mandrel use increases range and versatility

Maximum RPM:

1" Diameter – 25,000 3" Diameter – 12,000 to 14,000
1-1/2" to 2" Diameter – 18,000 to 23,000 4" Diameter – 8,000 to 12,000
2-1/2" Diameter – 14,000 to 18,000 5" to 6" Diameter – 5,500 to 7,500

Machine Used:



Application/Grit Recommendation Guide

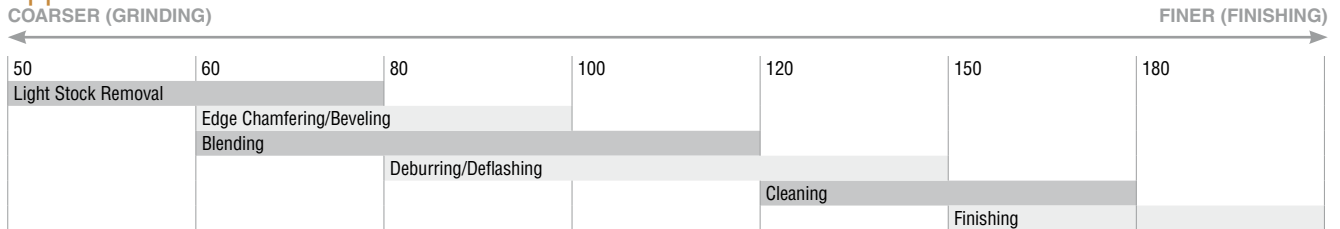

Best choice for hard-to-grind materials including super alloys (cobalt, inconel, and titanium) and stainless steel



BLAZE R920 CERAMIC ALUMINA

- See significantly faster, cooler, burn-free results on the toughest jobs from the sharp, longest-lasting P-graded ceramic abrasive grains and advanced supersize grinding aid for cool cutting
- X-weight cotton cloth provides extended durability, conformability, and superior wear resistance; strong resin bond system provides good grain retention and life
- Corners wear down consistently, exposing fresh abrasive; as these become round, they become less aggressive and run even smoother, with less stock removal – to retain workpiece shape

Better choice for accessing tight areas and where long life & fast cut are required



PINK R928 CERAMIC ALUMINA

- Excellent option for reaching into corners and small areas, ceramic grain provides better performance than aluminum oxide and zirconia alternatives
- Improved resin bond system provides longer life; supersized for cool cutting
- Versatile X-weight poly cotton backing for flexibility and life

Good for most ID deburring and polishing applications



R228 ALUMINUM OXIDE

- Versatile, quality aluminum oxide abrasive grain ensures good cut rate
- X-weight cotton cloth provides extended durability, conformability, and superior wear resistance; strong resin bond system provides good grain retention and life
- Corners wear down consistently, exposing fresh abrasive; as these become round, they become less aggressive and run even smoother, with less stock removal – to retain workpiece shape

Square & Cross Pads, Overlap Slotted Discs

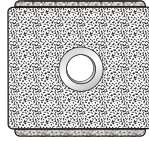

Square Pads

- Corners wear down consistently exposing fresh abrasive; the pad becomes round for less aggressive stock removal
- Grind almost as fast as hard wheels, but are much smoother and easier to control
- For quick blending of channels, fillets, corners, or spotting flat surfaces



		TIER: BEST		BETTE4R		GOOD	
		TRADENAME: BLAZE R920		PINK R928		R228	
		ABRASIVE: Ceramic Alumina		Ceramic Alumina		Aluminum Oxide	
		OTHER: Supersize		Supersize			
SIZE (L x W x T)	EYELET	GRIT	STD. PKG.	PART #	PART #	PART #	
1 x 1 x 6 ply	8-32	80	100			088341	84826
1 x 1 x 8 ply		80	100			088341	84124
1-1/2 x 1-1/2 x 1/2	1/4-20	60	100			088341	84463
		80	100			088341	84125
2 x 2 x 1/2	1/4-20	60	100	662611	94520	699573	40138
		80	100	662611	94552	699573	40139
		120	100	662611	94554	699573	40141
2 x 2 x 3/4	1/4-20	80	100			088341	84394
3 x 3 x 1/4	1/4-20	60	100	662611	94531	699573	40142
		80	100	662611	94555	699573	40143
		120	100	662611	94556	699573	40144
3 x 3 x 1/2	1/4-20	50	100			088341	82152
		60	100	662611	94528	699573	40146
		80	100	662611	94557	699573	40147
		120	100	662611	94558		84336

Some part numbers are non-stock; contact your Norton representative for status, order quantities and lead-times.

Refer to the back of this section for mandrels.

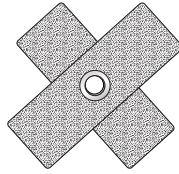

Cross Pads

- The shape of cross pads enables you to see through to the contact area, and provides greater flexibility than square pads to conform to variable internal diameters
- Used for close-tolerance polishing of small radii and channels, deburring, and finishing of bell-mouth configurations
- All pads are furnished with standard quick-change eyelet, as listed
- Plain hole sizes must be specified and are available for quotation as made-to-order products



TIER:	BEST	BETTER	GOOD
TRADENAME:	BLAZE R920	PINK R928	R228
ABRASIVE:	Ceramic Alumina	Ceramic Alumina	Aluminum Oxide
OTHER:	Supersize	Supersize	

SIZE (L x W x T)	PLY	EYELET	GRIT	STD. PKG.	PART #	PART #	PART #
3/4 x 3/4 x 3/8	8	3-48	80	100			088341 85578
1 x 1 x 3/8	8	3-48	60	100			088341 84943
			80	100			088341 85519
			100	100			088341 84195
			120	100			088341 85164
1-1/2 x 1-1/2 x 1/2	8	8-32	60	100	662611 94496	699573 39793	088341 84258
			80	100	662611 94508	699573 39794	088341 84465
			100	100			088341 82196
			120	100	662611 94511	699573 39804	088341 82148
2 x 2 x 1/2	8	8-32	60	100			088341 82156
			80	100			088341 82157
			120	100			088341 82132
2 x 2 x 3/4	8	8-32	60	100	662611 94502	699573 39806	088341 84128
			80	100	662611 94513	699573 40133	088341 84194
			120	100	662611 94516	699573 40134	
2-1/4 x 2-1/4 x 1/2	8	8-32	80	100			088341 84402
2-1/2 x 2-1/2 x 3/4	8	8-32	80	100			088341 84206
3 x 3 x 1	8	1/4-20	60	100	662611 94504		088341 82135
			80	100	662611 94549		088341 84119
			120	100	662611 94551		088341 84116
3 x 3 x 1	8	1/4-20	60	100		699573 40135	
			80	100		699573 40136*	088341 82140
			120	100		699573 40137	
3 x 3 x 1-1/2	10	1/4-20	80	100			088341 82184
4 x 4 x 1	8	1/4-20	60	100			088341 84142
			80	100			088341 84135
			120	100			088341 84377
4 x 4 x 1-1/2	8	1/4-20	80	100			088341 84129

* Pink R928 3 x 3 x 1 are 8 ply.

Ceramic Alumina and Alumina Oxide cross pads are also available upon request as made-to-order products.

Some part numbers are non-stock; contact your Norton representative for status, order quantities and lead-times.

Refer to the back of this section for mandrels.



Overlap Slotted Discs

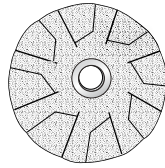

Overlap Slotted Discs

- Used for deburring and polishing radii, holes and cylinder walls
- Our "2 to a set" configuration cuts on the inward motion only
- The "4 to a set" configuration, assembled back to back, cuts on both the inward and outward motions
- All discs are furnished with standard quick-change eyelet
- Plain hole sizes must be specified and are available for quotation as made-to-order products



TIER:	BEST	GOOD
TRADENAME:	BLAZE R920	R228
ABRASIVE:	Ceramic Alumina	Aluminum Oxide
OTHER:	Supersize, 2 Per Set	2 Per Set

DIA.	EYELET	GRIT	STD. PKG.	PART #	PART #
1	8-32	60	100		088341 84346
		80	100		088341 84019
		100	100		088341 84224
		120	100		088341 84151
1-1/4	8-32	60	100		088341 84270
		80	100		088341 84065
		100	100		088341 84291
		120	100		088341 84084
1-1/2	8-32	60	100	662611 95051	088341 84066
		80	100	662611 95368	088341 84079
		100	100		088341 84279
		120	100	662611 95367	088341 86035
1-3/4	8-32	60	100		088341 84655
		80	100		088341 84042
2	8-32	60	100	662611 95054	
		80	100	662611 95055	088341 84076
		100	100		088341 84145
		120	100	662611 95056	088341 84055
2-1/2	8-32	80	100		088341 84444
3	1/4-20	60	100	662611 95057	088341 84041
		80	100	662611 95058	088341 84077
		100	100		088341 84082
		120	100		088341 84344
4	1/4-20	60	100		088341 84000
		120	100		088341 85155
4-1/2	1/4-20	100	100		088341 84431

All overlap slotted discs are available (made-to-order) reinforced with a fiber washer

Ceramic Alumina and Alumina Oxide overlap slotted discs are also available upon request as made-to-order products.

Some part numbers are non-stock; contact your Norton representative for status, order quantities and lead-times.

Quick-Change Mandrels for Overlap Slotted Discs, Square and Cross Pads

CROSS PAD SIZE DIA.	SQUARE PAD SIZE DIA.	OVERALL LENGTH	MODEL NO.	THD. SIZE	PART #
1/4, 3/8, and 1/2 wide		2-1/2	MM48-4	3-48	088341 83162
3/4, 1 wide	Up thru 1-1/2 sq. x 1/2 thick 2 sq. x 1/4 or 3/8 thick	3	MM32-4	8-32	088341 83163
		4	MM-32-4-4	8-32	088341 21680
		6	MM-32-4-6	8-32	088341 21681
All pads 2-1/2 x 1-1/2 and larger	2 sq. x 1/4 or 1/2 thick and larger	3	MM20-4	1/4-20	088341 83164

For overlap slotted discs, choose a mandrel with the same thread size as the disc

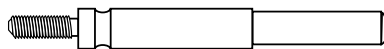

QUICK-CHANGE MANDREL



EXTENDED MANDREL



Best product for blending and polishing contours when smooth running is a primary concern. Used for finishing hard-to-reach areas, removing parting lines, imperfections, and burrs on all surfaces.

- Benefits:** Spiral construction avoids shadow marks and provides smooth, chatter-free cutting action. Achieves close tolerances when finishing curved, contoured, and hard-to-reach areas. Fast cutting and removes toughest metal. Bands are easily removed and replaced.
- Grit Range:** 24 - 320
- Abrasive Grain:** Ceramic Alumina, Aluminum Oxide
- Backing:** X-weight cotton
- Other:** Use with rubber expanding drum
- Machine Used:**  DIE GRINDER

Application/Grit Recommendation Guide

← COARSER (GRINDING)					FINER (FINISHING) →				
24	36	40	50	60	80	120	180	240	320
Heavy Stock Removal									
Blending Out Heavy Machine Marks									
Removing Heavy Burrs									
Applying Heavy Scratch Pattern									
Removing Flash/Parting Lines									
Removing Rust/Scale/Pit Marks									
			Preparing Metal for Painting						
			Blending Out Medium Machine Marks						
					Blending Metal Surfaces				
					Applying Light Scratch Pattern				
							Fine Blending and Cleaning		
								Metal Finishing and Polishing	



Best choice for hard-to-grind materials including super alloys (cobalt, inconel, and titanium) and stainless steel

BLAZE R920 CERAMIC ALUMINA

- See significantly faster, cooler, burn-free results on the toughest jobs from the next-generation of sharp, longest-lasting P-graded ceramic abrasive grains and advanced grinding aid lubricant
- Advanced, full resin bond system designed to promote exceptional grain retention for additional product life
- X-weight cotton backing and spiral construction avoid shadow marks and provide smooth, chatter-free cutting action



Good starting specification for all types of metal

R228 ALUMINUM OXIDE

- Tough and durable quality aluminum oxide abrasive removes tough metal
- X-weight cotton backing and spiral construction avoid shadow marks and provide smooth, chatter-free cutting action
- Achieves close tolerances on curved, contoured, and hard-to-reach areas



TIER: **BEST**
 TRADENAME: **BLAZE R920**
 ABRASIVE: Ceramic Alumina
 OTHER: Supersize

SIZE (D x W)	GRIT	STD. PKG.	PART #
1/2 x 1	40	100	662611 46012
	60	100	662611 46013
	80	100	662611 46014
	120	100	662611 46015
3/4 x 1	40	100	662611 46016
	60	100	662611 46017
	80	100	662611 46018
	120	100	662611 46019
1 x 1	40	100	662611 46020
	60	100	662611 46021
	80	100	662611 46022
	120	100	662611 46023
1-1/2 x 1-1/2	40	100	662611 46024
	60	100	662611 46025
	80	100	662611 46026
	120	100	662611 46027
2 x 2	40	100	662611 46028
	60	100	662611 46029
	80	100	662611 46030
	120	100	662611 46031
3 x 3	40	50	662611 46032
	60	50	662611 46033
	80	50	662611 46034
	120	50	662611 46035



TIER: **GOOD**
 TRADENAME: **R228**
 ABRASIVE: Aluminum Oxide

SIZE (D x W)	GRIT	STOCK PKG. QTY.	NON-STOCK MOQ	PART #
3/8 x 1	80	100/box	300	088341 96645
1/2 x 1/2	50	100/box	300	088341 96228
	80	100/box	300	088341 96179
	100	100/box	300	088341 96189
	120	100/box	300	088341 96069
1/2 x 1	180	100/box	300	088341 96209
	36	100/box	300	088341 96591
	40	100/box	300	088341 96174
	60	100/box	300	088341 96212
1/2 x 2	80	100/box	300	088341 96215
	120	100/box	300	088341 96210
	50	100/box	200	088341 96548
	80	100/box	200	088341 96669
3/4 x 3/4	60	100/box	300	088341 96168
3/4 x 1	80	100/box	300	088341 96161
	36	100/box	300	088341 96261
	40	100/box	300	088341 96517
	50	100/box	300	088341 96515
	60	100/box	300	088341 96070
	80	100/box	300	088341 96071
3/4 x 1-1/2	120	100/box	300	088341 96219
	24	100/box	300	088341 96596
	60	100/box	300	088341 96554
3/4 x 2	80	100/box	300	088341 96249
	80	100/box	200	088341 96756



TIER: **GOOD**
 TRADENAME: **R228**
 ABRASIVE: Aluminum Oxide

SIZE (D x W)	GRIT	STOCK PKG. QTY.	NON-STOCK MOQ	PART #
1 x 1	36	100/box	300	088341 96072
	40	100/box	300	088341 96073
	50	100/box	300	088341 96184
	60	100/box	300	088341 96075
	80	100/box	300	088341 96074
	120	100/box	300	088341 96177
1 x 1-1/2	36	100/box	200	088341 96525
1 x 2	80	100/box	200	088341 96268
	100	100/box	200	088341 96750
1 x 3	36	100/box	100	088341 96665
	50	100/box	100	088341 97688
	60	100/box	100	088341 96676
	80	100/box	100	088341 96195
	120	100/box	100	088341 96197
	1-1/2 x 1-1/2	36	100/box	200
40		100/box	200	088341 96171
50		100/box	200	088341 96176
60		100/box	200	088341 96091
80		100/box	200	088341 96165
120		100/box	200	088341 96066

Some part numbers are non-stock; contact your Norton representative for status, order quantities and lead-times.

Continued



TIER: **GOOD**
TRADENAME: **R228**
ABRASIVE: Aluminum Oxide

SIZE (D x W)	GRIT	STOCK PKG. QTY.	NON-STOCK MOQ	PART #
1-1/2 x 2	60	100/box	200	088341 96067
	80	100/box	200	088341 96533
1-1/2 x 3	36	100/box	100	088341 97063
	60	100/box	100	088341 96703
	80	100/box	100	088341 96809
	120	100/box	100	088341 96343
	180	100/box	100	088341 97869
2 x 1	80	100/box	200	088341 96166
	120	100/box	200	088341 96595
2 x 2	36	100/box	200	088341 96110
	40	100/box	200	088341 96172
	60	100/box	200	088341 96173
	80	100/box	200	088341 96181
	120	100/box	200	088341 96585
2 x 3	50	100/box	100	088341 96152
	60	100/box	100	088341 96175
	80	100/box	100	088341 96198
2-1/4 x 3	36	100/box	100	088341 97140
	50	100/box	100	088341 96620
	80	100/box	100	088341 96270
	120	100/box	100	088341 96729
	150	100/box	100	088341 95857



TIER: **GOOD**
TRADENAME: **R228**
ABRASIVE: Aluminum Oxide

SIZE (D x W)	GRIT	STOCK PKG. QTY.	NON-STOCK MOQ	PART #
3 x 2	40	100/box	100	088341 96090
	50	100/box	100	088341 96264
	60	100/box	100	088341 96530
	80	100/box	100	088341 96265
3 x 3	120	100/box	100	088341 96531
	24	100/box	100	088341 96256
	36	100/box	100	088341 96262
	40	100/box	100	088341 96555
	50	100/box	100	088341 96253
	60	100/box	100	088341 96188
	80	100/box	100	088341 96159
	100	100/box	100	088341 96250
	120	100/box	100	088341 96572
150	100/box	100	088341 96452	
180	100/box	100	088341 96131	
320	100/box	100	088341 97968	

Some part numbers are non-stock; contact your Norton representative for status, order quantities and lead-times.

Expanding Rubber Drums

Spiral Bands are easily removed and replaced on the rubber expanding drum.



TIER: **GOOD**
TRADENAME: **RUBBER EXPANDING DRUMS**

DRUM DIAMETER	WIDTH	SHANK DIAMETER	MAX. RPM	STD. PKG.	PART #
1/4	1/2	1/8	30,000	1	088341 96030
3/8	1/2	1/4	30,000	1	088341 96944 NS
3/8	1	1/8	18,000	1	088341 96011 NS
1/2	1/2	1/4	30,000	1	088341 96904
1/2	1	1/4	15,000	1	088341 96906
1/2	1-1/2	1/4	12,000	1	088341 96907
1/2	2	1/4	10,000	1	088341 96908
3/4	1/2	1/4	27,000	1	088341 96909 NS
3/4	3/4	1/4	24,000	1	088341 96910 NS
3/4	1	1/4	17,000	1	088341 96911
3/4	1-1/2	1/4	10,000	1	088341 96912
3/4	2	1/4	10,000	1	088341 96913

NS Non-stock, contact your Norton representative for current order quantities and lead-times.



TIER: **GOOD**
TRADENAME: **RUBBER EXPANDING DRUMS**

DRUM DIAMETER	WIDTH	SHANK DIAMETER	MAX. RPM	STD. PKG.	PART #
1	1/2	1/4	20,000	1	088341 96914 NS
1	1	1/4	18,000	1	088341 96916
1	1-1/2	1/4	10,000	1	088341 96917
1	2	1/4	8,000	1	088341 96918
1-1/2	1	1/4	12,000	1	088341 96921
1-1/2	1-1/2	1/4	10,000	1	088341 96922
1-1/2	2	1/4	8,000	1	088341 96923
2	1	1/4	11,000	1	088341 96926
2	1-1/2	1/4	8,000	1	088341 96927
2	2	1/4	6,000	1	088341 96928
3	1	3/8	3,000	1	088341 96929 NS
3	2	3/8	3,000	1	088341 96930 NS
3	3	3/8	3,000	1	088341 96931



Tapered cone points are strips of abrasive cloth rolled and glued to form a solid shape that is designed to break down during use and reveal the next layer of abrasive. Tapered cone points are similar to cartridge rolls but their shape lends greater accessibility to many difficult-to-reach work areas. They are used for deburring holes and in close tolerance work areas.

- Applications:** Used on inside surfaces and inside corners where other abrasive shapes cannot reach. Typically these are used on high-speed air grinders and are always mounted on a mandrel. Ideal for flash removal, polishing, or removing machine tool marks, and edge breaking.
- Grit Range:** 50 - 320
- Abrasive Grain:** Aluminum Oxide
- Backing:** X-weight cotton
- Construction:** Popular sizes and mandrels are listed, with additional sizes available upon request as made-to-order products
Ceramic alumina and silicon carbide cone points are available upon request as made-to-order products
- Maximum RPM:** 1/8" to 1/2" – 23,000
5/8" to 1" – 18,000
1" to 1-1/2" – 15,000
- Machine Used:**  DIE GRINDER

Application/Grit Recommendation Guide

COARSER (GRINDING) ←									FINER (FINISHING) →	
36	40	50	60	80	120	180	240	320		
Blending Out Heavy Machine Marks										
Removing Heavy Burrs										
Applying Heavy Scratch Pattern										
Removing Flash/Parting Lines										
Removing Rust/Scale/Pit Marks										
		Preparing Metal for Painting								
		Blending Out Medium Machine Marks								
				Blending Metal Surfaces						
				Applying Light Scratch Pattern						
						Fine Blending and Cleaning				
							Metal Finishing and Polishing			



Good starting specification for flash removal, polishing, or removing machine tool marks and edge breaking on all types of metal in difficult-to-reach work areas

R228 ALUMINUM OXIDE TAPERED CONE POINTS

- Quality aluminum oxide abrasive delivers long life
- X-weight cotton cloth provides extended durability, conformability, and superior wear resistance; strong resin bond system provides good grain retention and life
- Full taper construction consisting of rolled and half-glued abrasive strips that break down to expose next layer of abrasive

TIER: GOOD			
TRADENAME: R228			
ABRASIVE: Aluminum Oxide			
SIZE (D x L x H)	GRIT	STD. PKG.	PART #
3/16 x 1 x 2-1/2° Use K-110 Mandrel	50	500	088341 86892
	60	500	088341 86893
	80	500	088341 80918
	100	500	088341 82197
	120	500	088341 82199
	150	500	088341 82200
	180	500	088341 86894
	240	500	088341 86895
320	500	088341 82855	

TIER: GOOD			
TRADENAME: R228			
ABRASIVE: Aluminum Oxide			
SIZE (D x L x H)	GRIT	STD. PKG.	PART #
5/16 x 1-1/2 x 5° Use B-20 Mandrel	80	500	088341 80873
	100	500	088341 82043
	120	500	088341 82717
	150	500	088341 86890
	180	500	088341 82535
	240	500	088341 82044
	320	500	088341 82537

Refer to next page for mandrels.

Continued

Cartridge and Spiral Roll Mandrels

MODEL #	PILOT DIA.	PILOT LENGTH	SHANK DIA.	SHANK LENGTH	OVERALL LENGTH	PART #
Cartridge and Spiral Roll Mandrels						
M-2E	3/32	3/4	1/4	1	3	088341 83799 NS
M-2	3/32	1	1/8	1	3	088341 81202
M-3	1/8	1/2	1/8	1	2-1/2	088341 81203
M-4	1/8	3/4	1/8	1	2-1/2	088341 81204
M-5	1/8	1	1/8	1	2-3/4	088341 81205
M-6	1/8	1-1/2	1/8	1	2-1/2	088341 81206 NS
M-7	1/8	1/2	1/4	1-1/4	2-1/4	088341 81207
M-8	1/8	3/4	1/4	1-1/4	2-1/2	088341 81208
M-9	1/8	1	1/4	1-1/4	2-3/4	088341 81209
M-10	1/8	1-1/2	1/4	1-1/4	3-1/4	088341 81210
M-11	1/8	2	1/4	1-1/4	4	088341 81211 NS
M-12	3/16	1/2	1/8	1-1/4	2-1/4	088341 81212 NS
M-13	3/16	3/4	1/8	1-1/4	2-1/2	088341 81213 NS
M-14	3/16	1/2	1/4	1-1/4	2-1/2	088341 81214 NS
M-15	3/16	3/4	1/4	1-1/4	2-3/4	088341 81215 NS
M-16	3/16	1	1/4	1-1/4	3	088341 81216
M-17	3/16	1-1/2	1/4	1-1/4	3-1/2	088341 81217
M-18	3/16	2	1/4	1-1/4	4	088341 81218
M-19	1/4	1/2	1/4	1-1/4	2-1/2	088341 81219 NS
M-20	1/4	3/4	1/4	1-1/4	2-3/4	088341 81220 NS
M-21	1/4	1	1/4	1-1/4	3	088341 81221
M-22	1/4	1-1/2	1/4	1-1/4	3-1/2	088341 81222
M-23	1/4	2	1/4	1-1/4	4	088341 81223 NS
M-24	5/16	3/4	1/4	1-1/4	2-3/4	088341 81224 NS
M-25	5/16	1	1/4	1-1/4	3	088341 81225 NS
M-26	5/16	1-1/2	1/4	1-1/4	3-1/2	088341 81226 NS
M-27	5/16	2	1/4	1-1/4	4	088341 81227 NS

NS Non-stock. Contact your Norton representative for current order quantities and lead-times.
Standard Package = 1

Recommended Pilot Length for Mandrels

3/4 Roll Length	Use 1/2 Pilot
1 Roll Length	Use 3/4 Pilot
1-1/2 Roll Length	Use 1 Pilot
2 Roll Length	Use 1-1/2 Pilot

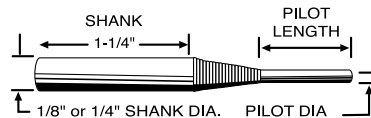

Extra Shank Length Mandrels for Cartridge Rolls and Spiral Rolls

MODEL #	SHANK LENGTH	OVERALL LENGTH	PART NO.
Extras Shank Length Mandrels			
M-8-4	4	5-1/4	088341 80116
M-8-6	6	7-1/4	088341 80122
M-9-2.5	2-1/2	4	088341 80096
M-9-3	3	4-1/2	088341 80129
M-9-4	4	5-1/2	088341 80074 NS
M-9-6	6	7-1/2	088341 80131
M-10-4	1-3/4	4	088341 80092 NS
M-10-6	3-3/4	6	088341 80145

All Extra Shank Length mandrels are 1/4" diameter

NS Non-stock. Contact your Norton representative for current order quantities and lead-times.
Standard Package = 1

Tapered Cone Point Mandrels

DESCRIPTION	SHANK	PART #
Cone Point Mandrels		
A-10	1/4	088341 81300
B-20	1/4	088341 81301
C-30	1/4	088341 81302
D-40	1/4	088341 81303
E-50	1/4	088341 81304
F-60	1/4	088341 81305
G-70	1/4	088341 81306
I-90	1/4	088341 81308
K-110	1/8	088341 81310



Standard Package = 1

These test kits feature the most popular range and sizes of our coated specialty products in convenient kit formats. Ideal for small job shops, or for travelling to a job site. Our cartridge roll kits are great when you need a small quantity, but a wide range of grits and sizes



Ceramic Alumina Cartridge Roll Test Kit

- Part # 662610**66726**
- Kit includes a variety of our ceramic alumina cartridge rolls, spiral rolls and mandrels in popular sizes and grits.



Aluminum Oxide Cartridge Roll Test Kit "CR"

- Part # 088341**181061**
- Includes over 120 pieces of our most popular sizes, grits and shapes with their appropriate mandrels.



General Purpose Test Kit "GP"

- Part # 088341**169025**
- Includes samples of various abrasive specialties. One of these kits could be worth the cost of the entire kit by solving your problems in deburring, polishing and grinding.



Porting Test Kit "APK-MO"

- Part # 088341**169032**
- The samples in this kit highlight specialties for general metal and wood working polishing and finishing applications.



Surface Preparation Stars

The perfect item for ID work



SURFACE PREPARATION STARS

- Star shape design is tough yet conformable to intricate shapes and contours without changing the workpiece dimension
- Premium aluminum oxide grain for excellent cutting and finishing
- Firm durable web for high resistance to tearing on burrs and sharp edges

TIER: **BETTER**
 TRADENAME: **SURFACE PREP**
 ABRASIVE: Aluminum Oxide
 ATTACHMENT: 1/4-20 Eyelet

SIZE (D x EYELET)	GRIT	STD. PKG.	PART #
1-1/2" x 1/4-20	C	100	088341 85923
	M	100	088341 85924
	VF	100	088341 85925
2" x 1/4-20	C	100	088341 85926
	M	100	088341 85927
	VF	100	088341 85928
3" x 1/4-20	C	100	088341 85929
	M	100	088341 85678
	VF	100	088341 85931
4" x 1/4-20	C	100	088341 85932
	M	100	088341 85933
	VF	100	088341 85934

Some part number are non-stock, contact your Norton representative for status, order quantities and lead-times.
 1/4-20 eyelets attach to MM20-4 mandrel, Part # 088341**83164** (See description at end of Overlap Slotted Disc Section.)

Cross Buffs

Best choice for blending, cleaning and polishing



CROSS BUFFS

- Unique design is tough yet conformable to intricate shapes and contours without changing the workpiece dimension
- Premium aluminum oxide grain for excellent cutting and finishing
- Firm durable web for high resistance to tearing on burrs and sharp edges

TIER: **BEST** **BETTER**
 TRADENAME: **HIGH STRENGTH** **BUFFING**
 ABRASIVE: Aluminum Oxide Aluminum Oxide
 ATTACHMENT: 8-32 Eyelet 8-32 Eyelet

SIZE (D x W)	GRIT	PLY	STD. PKG.	PART #	PART #
1-1/2 x 1/2	Coarse	2	100		088341 88761
	Medium	2	100	088341 89306	088341 87312
	Very Fine	2	100	088341 89307	088341 88585
1-1/2 x 1/2	Coarse	3	100		666233 01763
	Medium	3	100	088341 89308	088341 87311
	Very Fine	3	100	088341 89309	088341 88586

8-32 eyelets: Attach to MM32-4 mandrel. Part No. 088341**83163** (See description at end of Overlap Slotted Disc Section)

Non-Woven Disc Wheels with 1/4" Steel Shank

Best choice for all of your tough stripping needs on all kinds of surfaces



BLAZE RAPID STRIP DISCS

- Ceramic alumina grain provides 2X cut rate, 2X life over silicon carbide products
- Advanced resin bond does not shed on rust-encrusted pieces, and prevents gouging and rework; does not snag when used for deburring
- Leave a thoroughly cleaned surface that ensures excellent adhesion for subsequent processes such as coating, painting and soldering

Better choice for light deburring and finishing



DISC WHEELS

- Durable, longer lasting aluminum oxide abrasive leaves a more polished finish
- Discs are ganged together to form a wheel that is tough yet conformable to intricate shapes and contours without changing the workpiece dimension
- These wheels are mounted on a 1/4 inch steel mandrel embedded in a strong epoxy core



TIER: **BEST**
TRADENAME: **BLAZE RAPID STRIP**
ABRASIVE: Ceramic Alumina

SIZE (D x W x 1/4 SHANK)	GRIT	PLY	MAX. RPM	STD. PKG.	PART #
4 x 1/2	Extra Coarse	1 Ply	8,000	5	776960 05713
4 x 1	Extra Coarse	2 Ply	8,000	5	666233 75051



TIER: **BETTER**
ABRASIVE: Aluminum Oxide

SIZE (D x W x 1/4 SHANK)	GRIT	PLY	MAX. RPM	STD. PKG.	PART #
2 x 1/2	Medium	2 Ply	12,000	10	088341 31551
2 x 1	Medium	4 Ply	12,000	10	088341 31554
3 x 1/2	Medium	2 Ply	8,000	10	088341 31558
	Very Fine	3 Ply	8,000	10	088341 31560
3 x 1	Medium	4 Ply	8,000	10	088341 31496
	Fine	5 Ply	8,000	10	088341 31557
	Very Fine	5 Ply	8,000	10	088341 31497
4 x 1/2	Fine	3 Ply	6,000	10	088341 31562
4 x 1	Medium	4 Ply	6,000	10	088341 31564
5 x 1/2	Medium	2 Ply	4,000	10	088341 31567
5 x 1	Medium	4 Ply	4,000	10	088341 31570
	Fine	5 Ply	4,000	10	088341 31571

Disc wheels are constructed by number of plies. The actual face width will vary and will not match the listed width exactly. Face width is given for reference only.



Flap wheels are an ideal choice for a wide variety of blending, deburring and finishing applications common in the metal fabrication and welding industries. Flap wheels are conformable to intricate shapes and contours. Designed to deliver a consistent finish with a uniform rate of cut, flap wheels wear away, continually exposing fresh abrasives.

Applications:

Used for a wide range of metal fabrication and welding applications including stock removal, blending, deburring, cleaning, finishing, and polishing

Size Range:

Flap wheels with mounted steel shanks: 3/8" - 3" diameter
Flap wheels with mounted 1/4"-20 thread: 1" - 3" diameter
Flap wheels with arbor holes: 3" - 16" diameter

Grit Range:

40 - 320

Abrasive Grain:

Ceramic Alumina, Aluminum Oxide Blend, Aluminum Oxide

Machine Used:

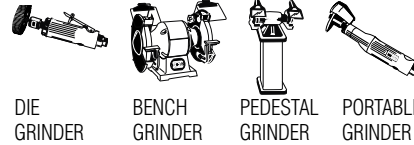



DIE GRINDER

BENCH GRINDER

PEDESTAL GRINDER

PORTABLE GRINDER

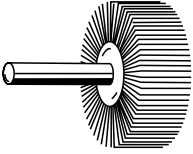
Shape Recommendation Guide

Shape	Description/Application
	<p>Flap Wheels with Mounted Steel Shanks</p> <p>Wheels are designed with a 1/8" or 1/4" steel shank as an integral part of each wheel. These shanks run through the wheel creating better balance, a reduction of chatter, and reduced operator fatigue. They also permit quick changes on air tools when using other abrasive products.</p>
	<p>Flap Wheels with Mounted 1/4"-20 Thread</p> <p>Wheels are designed with a 1/4"-20 thread and flange as an integral part of the wheel. These threads facilitate the quickest changes on air tools using flap wheels exclusively, as there are no special tools needed to change the flap wheel. Also allow extended reach with accessory mandrels.</p>
	<p>Flap Wheels with Arbor Holes</p> <p>For use on larger portable and fixed-base tools where the wheel must fit on an existing arbor.</p>

Application/Grit Recommendation Guide

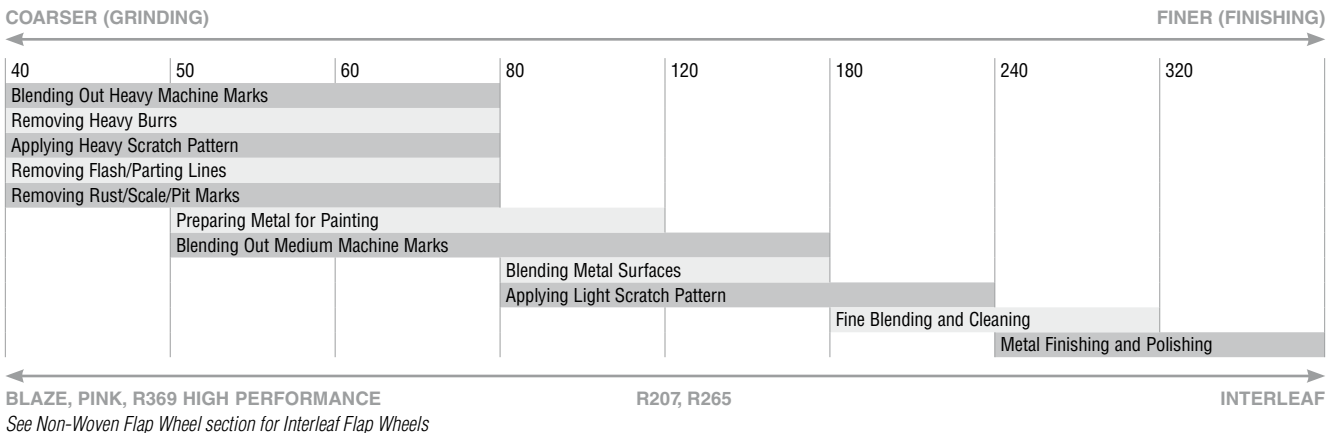



Best choice for hard-to-grind materials, including superalloys (cobalt, inconel, and titanium) and stainless steel!

BLAZE R920 CERAMIC ALUMINA

- See significantly faster, cooler, burn-free results on the toughest jobs from the next-generation of sharp, longest-lasting P-graded ceramic abrasive grains and advanced grinding aid lubricant
- X-weight cotton flaps provide conformability and even wear
- Advanced self-lubricating grain treatment reduces heat on hard-to-grind materials



Better choice for blending, deburring and finishing on a wide range of materials

PINK R928 CERAMIC ALUMINA

- Ceramic grain provides better performance than zirconia alternatives
- Improved resin bond system provides longer life
- Versatile X-weight poly cotton backing for flexibility and life



Good choice for more durable flap wheel applications where aggressive cut and superior life are required

R369 HIGH PERFORMANCE ALUMINUM OXIDE BLEND

- Long-lasting premium aluminum oxide blend with 2 to 3 times longer life
- Delivers an excellent cut rate on finishing operations
- Heavy cotton/polyester blended flaps provide extended durability, conformability, and superior wear resistance



Good choice for more flexible flap wheel applications where finish is required

R207 ALUMINUM OXIDE

- P-graded, solid-performing aluminum oxide abrasive delivers uniform stock removal and long life
- Heavy X-weight cotton flaps provide conformability and even wear
- Good general purpose starting specification for small deburring and cleaning jobs



Good choice when initial price is a key purchasing criteria

R265 ALUMINUM OXIDE

- Quality aluminum oxide abrasive provides good cut rate and life
- Heavy cotton/polyester blended flaps provide extended durability, conformability, and superior wear resistance
- Designed for all-purpose use where price is the major consideration



Micro-Mini Flap Wheels with 1/8" Mounted Steel Shanks

- The smallest flap wheels, ranging from 3/8" to 1-3/16" diameter, mounted on a 1/8" diameter steel shank
- Provide fast polishing and light deburring of internal workpieces with holes or grooves as small as 1/2"



TIER: **GOOD**
 TRADENAME: **R369**
 ABRASIVE: Premium Aluminum Oxide
 BACKING: Y-Weight Cotton

SIZE (D x W x SK.)	GRIT	MAX. RPM	STD. PKG.	PART #
3/8 x 3/8 x 1/8	60	40,000	10	088341 37470
	80	40,000	10	088341 37471
	120	40,000	10	088341 37472
	180	40,000	10	088341 37473
	240	40,000	10	088341 37474
5/8 x 5/8 x 1/8	60	37,000	10	088341 37480
	80	37,000	10	088341 37481
	120	37,000	10	088341 37482
	180	37,000	10	088341 37483
	240	37,000	10	088341 37484
5/8 x 3/4 x 1/8	80	37,000	10	088341 37541
	120	37,000	10	088341 37542
	180	37,000	10	088341 37543
	240	37,000	10	088341 37544
	320	37,000	10	088341 37545
3/4 x 3/16 x 1/8	60	35,000	10	088341 37550
	80	35,000	10	088341 37551
	120	35,000	10	088341 37552
	180	35,000	10	088341 37553
	240	35,000	10	088341 37554
3/4 x 3/8 x 1/8	60	35,000	10	088341 37560
	80	35,000	10	088341 37561
	120	35,000	10	088341 37562
	180	35,000	10	088341 37563
	240	35,000	10	088341 37564
3/4 x 1/2 x 1/8	60	35,000	10	088341 37570
	80	35,000	10	088341 37571
	120	35,000	10	088341 37572
	180	35,000	10	088341 37573
	240	35,000	10	088341 37574
320	35,000	10	088341 37575	



TIER: **GOOD**
 TRADENAME: **R369**
 ABRASIVE: Premium Aluminum Oxide
 BACKING: Y-Weight Cotton

SIZE (D x W x SK.)	GRIT	MAX. RPM	STD. PKG.	PART #
3/4 x 5/8 x 1/8	60	35,000	10	088341 37580
	80	35,000	10	088341 37581
	120	35,000	10	088341 37582
	180	35,000	10	088341 37583
	240	35,000	10	088341 37584
3/4 x 3/4 x 1/8	60	35,000	10	088341 37590
	80	35,000	10	088341 37591
	120	35,000	10	088341 37592
	240	35,000	10	088341 37594
	320	35,000	10	088341 37595
1-3/16 x 1/8 x 1/8	80	30,000	10	088341 37491
	120	35,000	10	088341 37492
	180	35,000	10	088341 37493
	320	35,000	10	088341 37495
1-3/16 x 3/16 x 1/8	60	30,000	10	088341 37508
	80	35,000	10	088341 37501
	120	35,000	10	088341 37502
	180	35,000	10	088341 37503
1-3/16 x 3/8 x 1/8	60	35,000	10	088341 37504
	320	35,000	10	088341 37505
	80	30,000	10	088341 37511
	120	35,000	10	088341 37512
	180	35,000	10	088341 37513
1-3/16 x 3/8 x 1/8	240	35,000	10	088341 37514
	320	35,000	10	088341 37515

Some part numbers are non-stock; contact your Norton representative for status, order quantities and lead-times.

Micro-Mini Test Kit "MMC"

- Part # 088341**31493**
- Includes five wheels, 3/8" to 1-3/16" diameter in various grits, mounted on a 1/8" diameter hardened steel shank
- The "MMC" kit is ideal for fast polishing and light deburring of internal holes or grooves as small as 1/2"





Mini Flap Wheels with 1/4" Mounted Steel Shanks

- Small flap wheels, ranging from 1" to 3" diameter, mounted on a 1/4" diameter steel shank
- Very durable, long-lasting mini flap wheels for demanding, heavy stock removal applications



		TIER: BEST		TIER: BETTER		TIER: GOOD		TIER: GOOD		TIER: GOOD	
		TRADENAME: BLAZE R920		TRADENAME: PINK R928		TRADENAME: R369		TRADENAME: R207		TRADENAME: R265	
		ABRASIVE: Ceramic Alumina		ABRASIVE: Ceramic Alumina		ABRASIVE: Premium Aluminum Oxide		ABRASIVE: Aluminum Oxide		ABRASIVE: Aluminum Oxide	
		BACKING: X-Weight Cotton		BACKING: X-Weight Poly/Cotton		BACKING: Y-Weight Cotton		BACKING: X-Weight Cotton			
SIZE (D x W x SK.)	GRIT	MAX. RPM	STD. PKG.	PART #	PART #	PART #	PART #	PART #	PART #	PART #	PART #
1 x 1/2 x 1/4	80	30,000	10								088341 49801
	120	30,000	10								088341 49802
1 x 5/8 x 1/4	40	30,000	10				088341 137105				
	60	30,000	10				088341 137100		636425 02576		
	80	30,000	10				088341 137101		636425 02577		
	120	30,000	10				088341 137102		636425 02578		
	180	30,000	10				088341 131536				
1 x 1 x 1/4	240	30,000	10				088341 137104				
	40	30,000	10				088341 131259				088341 49803
	60	30,000	10	662611 151170	699573 39701	088341 137310		636425 02580		088341 49804	
	80	30,000	10	662611 151171	699573 39703	088341 137311		636425 02581		088341 49805	
	120	30,000	10	662611 151172	699573 39704	088341 137312		636425 02582		088341 49806	
	180	30,000	10				088341 137313				088341 49807
	240	30,000	10				088341 137114				
1-3/8 x 5/8 x 1/4	320	30,000	10				088341 137315				
	60	30,000	10				088341 137320				
	80	30,000	10				088341 137321				
	120	30,000	10				088341 137322				
1-1/2 x 1/2 x 1/4	180	30,000	10				088341 137323				
	240	30,000	10				088341 137324				
	60	25,000	10							088341 49810	
1-1/2 x 1 x 1/4	80	25,000	10							088341 49811	
	40	25,000	10				088341 135140				
1-1/2 x 1 x 1/4	60	25,000	10				088341 137340		636425 02592		088341 49816
	80	25,000	10				088341 137141		636425 02593		088341 49817
	120	25,000	10				088341 137142		636425 02594		088341 49818
	180	25,000	10				088341 137343				
	240	25,000	10				088341 132101				
1-1/2 x 1-1/2 x 1/4	40	25,000	10				088341 130642				
	60	25,000	10				088341 130643				
	80	25,000	10				088341 130644				
	120	25,000	10				088341 130641				
2 x 1/2 x 1/4	180	25,000	10				088341 130695				
	60	25,000	10							088341 49821	
	80	25,000	10							088341 49822	
2 x 3/4 x 1/4	120	25,000	10							088341 49823	
	40	25,000	10				088341 137158				
	60	25,000	10				088341 137160				
2 x 3/4 x 1/4	80	25,000	10				088341 137161				
	120	25,000	10				088341 137162				
	180	25,000	10				088341 137163				

Some part numbers are non-stock; contact your Norton representative for status, order quantities and lead-times.
Continued

Mini Flap Wheels with 1/4" Mounted Steel Shanks *continued*



		TIER: BEST		TIER: BETTER		TIER: GOOD		TIER: GOOD		TIER: GOOD	
		TRADENAME: BLAZE R920		TRADENAME: PINK R928		TRADENAME: R369		TRADENAME: R207		TRADENAME: R265	
		ABRASIVE: Ceramic Alumina		ABRASIVE: Ceramic Alumina		ABRASIVE: Premium Aluminum Oxide		ABRASIVE: Aluminum Oxide		ABRASIVE: Aluminum Oxide	
		BACKING: X-Weight Cotton		BACKING: X-Weight Poly/Cotton		BACKING: Y-Weight Cotton		BACKING: X-Weight Cotton			
SIZE (D x W x SK.)	GRIT	MAX. RPM	STD. PKG.	PART #	PART #	PART #	PART #	PART #	PART #	PART #	PART #
2 x 1 x 1/4	40	25,000	10		699573 39705	088341 37377				088341 49824	
	50	25,000	10			088341 37169					
	60	25,000	10	662611 51173	699573 39706	088341 37370	636425 02600	088341 49825			
	80	25,000	10	662611 51174	699573 39711	088341 37371	636425 02601	088341 49826			
	120	25,000	10	662611 51175	699573 39712	088341 37372	636425 02602	088341 49827			
	180	25,000	10			088341 37373		088341 49828			
	240	25,000	10			088341 37374					
2 x 1-1/2 x 1/4	320	25,000	10			088341 37375					
	40	25,000	10			088341 37183					
	60	25,000	10			088341 37380					
	80	25,000	10			088341 37381					
	120	25,000	10			088341 37382					
2-1/2 x 1 x 1/4	180	25,000	10			088341 37383					
	40	20,000	10			088341 37408					
	60	20,000	10			088341 37410	636425 02608				
	80	20,000	10			088341 37411	636425 02609				
	120	20,000	10			088341 37412	636425 02610				
	180	20,000	10			088341 37413					
	240	20,000	10			088341 37633					
2-1/2 x 1-1/2 x 1/4	320	20,000	10			088341 37415					
	60	20,000	10			088341 37420					
	80	20,000	10			088341 37421					
	120	20,000	10			088341 37422					
	180	20,000	10					636425 02612	088341 49834		
3 x 1/2 x 1/4	80	20,000	10					636425 02613	088341 49835		
	120	20,000	10					636425 02614			
	180	20,000	10								
3 x 3/4 x 1/4	60	20,000	10			088341 37440					
	80	20,000	10			088341 37441					
3 x 1 x 1/4	60	20,000	10			088341 37456				088341 49836	
	80	20,000	10		699573 39713	088341 37450		636425 02620	088341 49837		
	120	20,000	10	662611 51176	699573 39714	088341 37450	636425 02620	088341 49838			
	180	20,000	10	662611 51177	699573 39715	088341 37451	636425 02621	088341 49839			
	240	20,000	10	662611 51178	699573 39716	088341 37252	636425 02622	088341 49839			
	320	20,000	10			088341 37253				088341 49840	
	360	20,000	10			088341 35339					
3 x 2 x 1/4	40	12,000	10			088341 35341					
	60	12,000	10			088341 37460					
	80	12,000	10			088341 37260					
	120	12,000	10			088341 37261					
	180	12,000	10			088341 37262					
						088341 37263					

Some part numbers are non-stock; contact your Norton representative for status, order quantities and lead-times.



Mini 1/4" Steel Shank Test Kit "CMM"

- Part # 088341**38004**
- Includes ten wheels, 1" to 3" diameter in various grits mounted on a 1/4" diameter hardened steel shank



Mini Flap Wheels with 1/4"-20 Thread

- Mini flap wheels ranging from 1" to 3" diameter, mounted on a 14-20 thread that allows you to quickly spin the wheels on and off with no tools
- Designed for polishing and finishing intricate surfaces; cost-effective replacement for brushes, rubber points, and felt bobs



TIER:	BETTER	GOOD	GOOD
TRADENAME:	PINK R928	R369	R207
ABRASIVE:	Ceramic Alumina	Premium Aluminum Oxide	Aluminum Oxide
BACKING:	X-Weight Poly/Cotton	Y-Weight Cotton	X-Weight Cotton

SIZE (D x W x THD.)	GRIT	MAX. RPM	STD. PKG.	PART #	PART #	PART #
1 x 5/8 x 1/4-20	60	30,000	10		088341 31001	636425 02624
	80	30,000	10		088341 31002	636425 02625
	120	30,000	10		088341 31003	636425 02626
1 x 1 x 1/4-20	40	30,000	10	699573 39718	088341 31027	
	60	30,000	10	699573 39719	088341 31008	636425 02628
	80	30,000	10	699573 39720	088341 31009	636425 02629
	120	30,000	10	699573 39721	088341 31010	636425 02630
	180	30,000	10		088341 31011	
	240	30,000	10		088341 31012	
1-3/8 x 5/8 x 1/4-20	60	30,000	10		088341 32001	636425 02632
	80	30,000	10		088341 32002	636425 02633
	120	30,000	10		088341 32003	636425 02634
1-5/8 x 1 x 1/4-20	40	25,000	10		088341 32051	
	60	25,000	10		088341 32015	636425 02638
	80	25,000	10		088341 32016	636425 02639
	120	25,000	10		088341 32017	636425 02640
	180	25,000	10		088341 32018	
2 x 1/2 x 1/4-20	80	25,000	10			636425 02643
	120	25,000	10			636425 02644
2 x 3/4 x 1/4-20	60	25,000	10		088341 33008	
	80	25,000	10		088341 33009	
	120	25,000	10		088341 33010	
	180	25,000	10		088341 33011	
2 x 1 x 1/4-20	40	25,000	10	699573 39722	088341 33044	
	60	25,000	10	699573 39723	088341 33015	636425 02646
	80	25,000	10	699573 39735	088341 33016	636425 02647
	120	25,000	10	699573 39736	088341 33017	636425 02648
	180	25,000	10		088341 33018	
	240	25,000	10		088341 33019	
2 x 1-1/2 x 1/4-20	60	25,000	10		088341 35201	
	80	25,000	10		088341 35202	
	120	25,000	10		088341 35203	
2-1/2 x 1 x 1/4-20	40	20,000	10		088341 34061	
	60	20,000	10		088341 34022	636425 02654
	80	20,000	10		088341 34023	
	120	20,000	10		088341 34024	
3 x 1/2 x 1/4-20	80	20,000	10			636425 02659
	120	20,000	10			636425 02660
3 x 3/4 x 1/4-20	80	20,000	10		088341 35009	
	120	20,000	10		088341 35010	
3 x 1 x 1/4-20	40	20,000	10	699573 39737	088341 35230	
	60	20,000	10	699573 39738	088341 35015	636425 02664
	80	20,000	10	699573 39739	088341 35016	636425 02665
	120	20,000	10	699573 39740	088341 35017	636425 02666
	180	20,000	10		088341 35018	
240	20,000	10		088341 35019		

Some part numbers are non-stock; contact your Norton representative for status, order quantities and lead-times.
For adapters for flap wheels with 1/4"-20 thread, see the end of this section



Cup-Type Mini Flap Wheels with 1/4" Mounted Steel Shanks

- Primarily used for bottom or side-wall type sanding where conventional tools do not reach
- Cup-type mini flap wheels will not mar your workpiece while reaching flush into areas where other wheels cannot reach

TIER: **GOOD**
 TRADENAME: **R369**
 ABRASIVE: Premium Aluminum Oxide
 BACKING: Y-Weight Cotton

D x W x SK.	MAX. RPM	GRIT	STD. PKG.	PART #
2-1/2 x 1-1/2 x 1/4	20,000	60	10	088341 44463

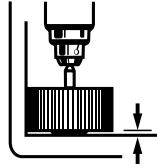

TYPICAL
WHEELS

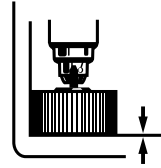

CUP WHEELS GET FLUSH INTO CORNERS
AND THE BOTTOMS OF CYLINDERS

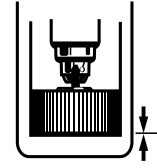

Flap Wheel Test Kits

Mini 1/4"-20 Thread Test Kit "CQ"

- Part # 088341**38001**
- Includes ten, 1" to 3" diameter, 1/4"-20 thread mini flap wheels
- Each kit includes a 1/4"-20 QC-4 quick-change adapter

Mini 1/4" Steel Shank Test Kit "CMM"

- Part # 088341**38004**
- Includes ten wheels, 1" to 3" diameter in various grits
- The flap wheels are mounted on a 1/4" diameter hardened steel shank

Micro Mini 1/8" Steel Shank Test Kit "MMC"

- Part # 088341**31493**
- Includes 5 wheels, 3/8" to 1-3/16" in diameter
- The flap wheels are mounted on a 1/8" diameter hardened steel shank
- Ideal for fast polishing and light deburring of holes or grooves

3" – 8" Flap Wheels with Arbor Holes

- Flap wheels ranging from 3" to 8" diameter with arbor holes
- Heavy cotton backing and premium abrasive grains combine to provide superior life with aggressive cut on a wide range of polishing and finishing applications



TIER:	GOOD	GOOD
TRADENAME:	R369	R207
ABRASIVE:	Premium Aluminum Oxide	Aluminum Oxide
BACKING:	Y-Weight Cotton	X-Weight Cotton

SIZE (D x W x H)	GRIT	MAX. RPM	STD. PKG.	PART #	PART #
3 x 2 x 3/8	60	12,000	10	088341 35050	
	80	12,000	10	088341 35051	
	120	12,000	10	088341 35052	
3-1/2 x 1 x 5/8	40	12,000	10	088341 22001	
	50	12,000	10	088341 22002	
	60	12,000	10	088341 22003	
	80	12,000	10	088341 22004	
	120	12,000	10	088341 22006	
	180	12,000	10	088341 22007	
	240	12,000	10	088341 22008	
3-1/2 x 1-1/2 x 5/8	320	12,000	10	088341 22009	
	40	12,000	10	088341 22011	
	50	12,000	10	088341 22012	
	60	12,000	10	088341 22013	
	80	12,000	10	088341 22014	
	120	12,000	10	088341 22016	
	180	12,000	10	088341 22018	
3-1/2 x 2 x 5/8	320	12,000	10	088341 22020	
	40	12,000	10	088341 22022	
	60	12,000	10	088341 22024	
	80	12,000	10	088341 22025	
	120	12,000	10	088341 22027	
4 x 1 x 5/8	180	12,000	10	088341 22028	
	40	12,000	10	088341 22032	
	50	12,000	10	088341 22033	
	60	12,000	10	088341 22034	636425 02673
	80	12,000	10	088341 22035	636425 02674
4 x 1-1/2 x 5/8	120	12,000	10	088341 22037	636425 02675
	180	12,000	10	088341 22038	
	240	12,000	10	088341 22039	
	320	12,000	10	088341 22040	
	40	12,000	10	088341 22042	
	60	12,000	10	088341 22044	
	80	12,000	10	088341 22045	
4 x 2 x 5/8	120	12,000	10	088341 22047	
	240	12,000	10	088341 22050	
	40	12,000	10	088341 22053	
	60	12,000	10	088341 22055	
	80	12,000	10	088341 22056	
4 x 2 x 5/8	120	12,000	10	088341 22058	
	180	12,000	10	088341 22059	
	240	12,000	10	088341 22060	
	320	12,000	10	088341 22061	

Some part numbers are non-stock; contact your Norton representative for status, order quantities and lead-times.
For flap wheel with arbor hole adapters and bushings, see the end of this section. A set of reducing bushing will be included for 1" center hole wheels at no charge when purchased with flap wheels and specified on the order.
Continued

3" – 8" Flap Wheels with Arbor Holes *continued*



TIER:	BEST	GOOD	GOOD	GOOD
TRADENAME:	BLAZE R920	R369	R207	R265
ABRASIVE:	Ceramic Alumina	Premium Aluminum Oxide	Aluminum Oxide	Aluminum Oxide
BACKING:	X-Weight Cotton	Y-Weight Cotton	X-Weight Cotton	

SIZE (D x W x H)	GRIT	MAX. RPM	STD. PKG.	PART #	PART #	PART #	PART #	
5 x 1-1/2 x 5/8	40	12,000	10		088341 22063			
	50	12,000	10		088341 22064			
	60	12,000	10		088341 22065			
	80	12,000	10		088341 22066			
	120	12,000	10		088341 22068			
	180	12,000	10		088341 22070			
	240	12,000	10		088341 22071			
6 x 1/2 x 1	320	12,000	10		088341 22072			
	40	6,000	10		088341 23001			
	60	6,000	10		088341 23003			
	120	6,000	10		088341 23005			
	150	6,000	10		088341 22198			
6 x 1 x 1	180	6,000	10		088341 23006			
	40	6,000	5		088341 23009		088341 20167	
	50	6,000	5		088341 23010		088341 20168	
	60	6,000	5	662611 46104	088341 23011	636425 02680	088341 20169	
	80	6,000	5	662611 46105	088341 23012	636425 02681	088341 20170	
	100	6,000	5				088341 20171	
	120	6,000	5	662611 46106	088341 23014	636425 02682	088341 20172	
	150	6,000	5		088341 23015			
	180	6,000	5		088341 23016		088341 20174	
	240	6,000	5		088341 23017		088341 20176	
	320	6,000	5		088341 23018		088341 20177	
	6 x 1-1/2 x 1	40	6,000	5		088341 23020		
		50	6,000	5		088341 23021		
		60	6,000	5		088341 23022	636425 02686	
80		6,000	5		088341 23023	636425 02687		
120		6,000	5		088341 23025			
180		6,000	5		088341 23027			
240		6,000	5		088341 23028			
320		6,000	5		088341 23029			
6 x 2 x 1		40	6,000	5		088341 23031		088341 20189
	50	6,000	5		088341 23032			
	60	6,000	5		088341 23033	636425 02691	088341 20191	
	80	6,000	5		088341 23034	636425 02692	088341 20192	
	100	6,000	5				088341 20198	
	120	6,000	5		088341 23036	636425 02694		
	180	6,000	5		088341 23038		088341 20197	
	240	6,000	5		088341 23039		088341 20199	
	320	6,000	5		088341 23040			
6 x 3 x 1	50	6,000	3		088341 23054			
	60	6,000	3		088341 23055			
	80	6,000	3		088341 23056			
	120	6,000	3		088341 23058			
	180	6,000	3		088341 23060			
	240	6,000	3		088341 23061			
8 x 1 x 1	40	4,500	3		088341 23070			
	50	4,500	3		088341 23071			
	60	4,500	3		088341 23072			
	80	4,500	3		088341 23073			
	120	4,500	3		088341 23075			
	180	4,500	3		088341 23077			
8 x 2 x 1	40	4,500	3		088341 23092			
	50	4,500	3		088341 23093			
	60	4,500	3		088341 23094	636425 02700		
	80	4,500	3		088341 23095	636425 02701		
	120	4,500	3		088341 23097			
	180	4,500	3		088341 23099			
	240	4,500	3		088341 23100			
320	4,500	3		088341 23101				

Some part numbers are non-stock; contact your Norton representative for status, order quantities and lead-times.
For flap wheel with arbor hole adapters and bushings, see the end of this section.
A set of reducing bushing will be included for 1" center hole wheels at no charge when purchased with flap wheels and specified on the order.



10" – 16" Large Flap Wheels with Arbor Holes

Wide range of applications:

- For polishing/grinding jobs in production work as well as clean-up and maintenance jobs
- Work on metals, plastic, rubber and wood

Easy to operate:

- No adjustments, dressing, or preparation required before or during operation

Fewer rejected parts:

- More forgiving than other abrasive products
- Reduce the possibility of flattening, gouging and surface deformation

TIER: **GOOD**
TRADENAME: **R369**
ABRASIVE: Premium Aluminum Oxide
BACKING: Y-Weight Cotton

SIZE (D x W x H)	GRIT	MAX. RPM	STD. PKG.	PART #
10 x 1 x 1-3/4	40	4,000	4	088341 2223
	80	4,000	4	088341 24003
	120	4,000	4	088341 24005
	180	4,000	4	088341 24007
	240	4,000	4	088341 22889
10 x 1-1/2 x 1-3/4	320	4,000	4	088341 24009
	60	4,000	4	088341 24022
10 x 2 x 1-3/4	80	4,000	4	088341 24023
	180	4,000	4	088341 24027
10 x 3 x 1-3/4	60	4,000	2	088341 24042
	80	4,000	2	088341 24043
	120	4,000	2	088341 24045
12 x 1 x 1-3/4	180	4,000	2	088341 24047
	60	4,000	2	088341 24077
	80	4,000	2	088341 22316
12 x 2 x 1-3/4	180	4,000	2	088341 22132
	60	3,000	4	088341 24085
	80	3,000	4	088341 22349
12 x 4 x 1-3/4	120	3,000	4	088341 22311
	180	3,000	4	088341 22315
	40	3,000	2	088341 22248
	50	3,000	2	088341 22249
	60	3,000	2	088341 22250
	120	3,000	2	088341 22269
12 x 2 x 1-3/4	150	3,000	2	088341 22270
	180	3,000	2	088341 22271
	240	3,000	2	088341 22273
	320	3,000	2	088341 22275
12 x 4 x 1-3/4	180	2,400	1	088341 20017

TIER: **GOOD**
TRADENAME: **R369**
ABRASIVE: Premium Aluminum Oxide
BACKING: Y-Weight Cotton

SIZE (D x W x H)	GRIT	MAX. RPM	STD. PKG.	PART #
14 x 1 x 1-3/4	60	2,400	1	088341 20020
	120	2,400	1	088341 20022
14 x 2 x 1-3/4	60	2,400	1	088341 20028
	80	2,400	1	088341 23215
	120	2,400	1	088341 22907
14 x 3 x 1-3/4	240	2,400	1	088341 20032
	120	2,400	1	088341 20035
	240	2,000	1	088341 20041
16 x 1 x 1-3/4	80	2,400	1	088341 20043
	120	2,400	1	088341 20044
	240	2,400	1	088341 20046
16 x 2 x 1-3/4	60	2,400	1	088341 20047
	120	2,400	1	088341 20050
	180	2,400	1	088341 20051
16 x 3 x 1-3/4	240	2,400	1	088341 20052
	120	2,400	1	088341 20055

Some part numbers are non-stock; contact your Norton representative for status, order quantities and lead-times.

For flap wheel with arbor hole adapters and bushings, see the end of this section.

Adapter and Bushings for Flap Wheels with Arbor Holes

WHEEL DIAMETER	ADAPTERS	PART #
Shank Adapters		
3-1/2	1/4 Shank	088341 25001
3-1/2	3/8 Shank	088341 25007 NS
4-8	1/4 Shank	088341 25003
Threaded Mounting Adapters		
4-8	5/8-11 Thread	088341 25027
Reducing Bushings		
6-8	1 to 3/8	088341 25016 NS
	1 to 1/2	088341 25017
	1 to 5/8	088341 25018 NS
	1 to 3/4	088341 25019 NS
	1 to 7/8	088341 25020 NS
10-16	1 to 5/8	088341 22069 NS

Standard packages = 1 adapter, 1 pair of bushings
 NS Non-stock. Contact your Norton representative for current order quantities and lead-times.
 For additional aluminum reducing bushings see non-woven convolute wheel section



Adapters for 1/4"-20 Thread Mini and Arbor Hole Flap Wheels

MODEL #	DESCRIPTION	PART #
Adapters		
ADAPT C	Fits 3 x 2 x 3/8 arbor flap wheel	088341 37009 NS
MA-100	Fits A.H. Mini Wheel	088341 37007 NS
QC-8	1/8 x 5/8	088341 37002 NS
QC-4	1/4 SK. Dia. x 5/8 SK. L.	088341 37001
QC-44	1/4 x 4	088341 37003
QC-46	1/4 x 6	088341 37004
QC-48	1/4 x 8	088341 37005
QC-T	1/4-20 Thread	088341 37012
QC-T	3/8-24 Thread	088341 37010

Standard package = 1 adapter
 Other thread sizes available for quotation
 NS Non-stock. Contact your Norton representative for current order quantities and lead-times.

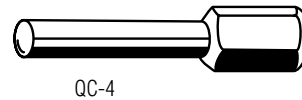

QC-4

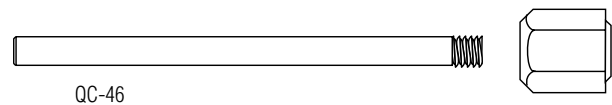

QC-46

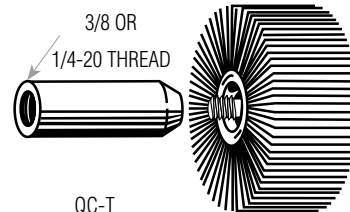

QC-T



Sand-O-Flex Wheels

With their firm cushioning brushes, Sand-O-Flex's abrasive strips are forced into, around and over corners, hollow and fluted surfaces, and small openings. Pressure is distributed evenly over the surface to prevent loss of detail and the flattening of rounded areas; for sanding metals, woods, plastics, rubber and ceramic.

Sand-O-Flex wheels eliminate the need to hand-sand and are designed to fit most standard equipment. They load quickly and easily by turning the index knob as needed, allowing you to change grit size in minutes. Sand-O-Flex refills are available both scored (for finer, less aggressive work) and unscored. And, with the use of adapters, Sand-O-Flex wheels will fit most electric bench grinders.

Sand-O-Flex Wheel – Model 350-RP

- Diameter: 6-1/2" overall, 4" diameter high-impact plastic body
- 1" wide abrasive strips backed by 8 cushioning brushes
- 1/4" diameter steel shank
- Weight: 9-1/2 oz.
- Maximum operating speed: 2,400 RPM
- Special adapter required for bench grinder use
- Some assembly required

TIER: **GOOD**
TRADENAME: **SAND-O-FLEX**
ABRASIVE: Aluminum Oxide

MODEL #	GRIT	STD. PKG.	PART #
Sand-O-Flex Wheel			
350-RP		1	088341 11051
<i>Comes assembled with 80 grit A/O resin bond scored refill and brushes</i>			
Sand-O-Flex Accessories			
Replacement Brushes for 350-RP; 8 per set		1 set	088341 13003
Resin Bond Refills			
350-RP SCORED	60	10	088341 11052
	80	10	088341 11053
	100	10	088341 12114
	120	10	088341 11054
	180	10	088341 11057
Glue Bond Refills			
350-RP SCORED	80	10	088341 12054
	100	10	088341 12055
	120	10	088341 12056
350-RP UNSCORED	80	10	088341 12044





Non-woven surface finishing flap wheels are an ideal choice for a wide variety of blending and finishing applications common in the metal fabrication, welding and polishing industries. Flap wheels are conformable to intricate shapes and contours. Designed to deliver a consistent finish with a uniform rate of cut, flap wheels wear away continually exposing fresh abrasives.

There are two types of non woven flap wheels: non-woven only abrasive flaps where finishing is the primary application, and interleaf with alternating cloth and non-woven abrasive flaps (less conformable, more aggressive) for stock removal and finishing. Interleaf flap wheels must always be run in the direction indicated by the arrow.

Applications: Used for a wide range of metal fabrication and welding applications including blending, deburring, cleaning, finishing, and polishing

Size Range: Flap wheels with mounted steel shanks: 2" – 4" diameter
Flap wheels with arbor holes: 3" – 12" diameter

Grit Range: 60 – 320

Abrasive Grain: Aluminum Oxide

Machine Used:



DIE GRINDER



BENCH GRINDER



PEDESTAL GRINDER



PORTABLE GRINDER

Application/Grit Recommendation Guide

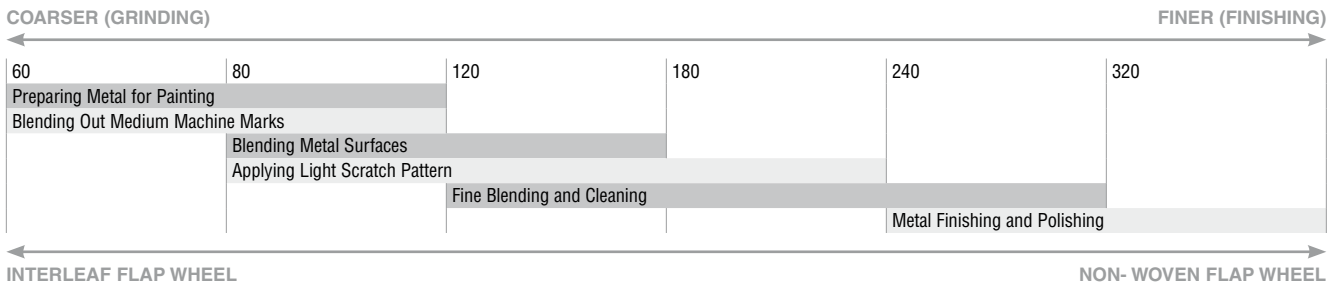

Good choice for fine grit cleaning and blending and finishing applications



INTERLEAF

- Alternating cloth and non-woven flaps make interleaf wheels less conforming and more aggressive than non-woven flap wheels, but less aggressive than all-cloth flap wheels
- Premium aluminum oxide grain with durable resin bond and web that wears away continually exposing fresh abrasives
- Tough yet conformable to intricate shapes and contours without changing the workpiece dimension

Good choice for fine grit light cleaning and finishing



NON-WOVEN

- Premium aluminum oxide grain with durable resin bond and web that wears away continually exposing fresh abrasives
- Tough yet conformable to intricate shapes and contours without changing the workpiece dimension
- Designed with a steel shank as an integral part of the wheel or with an arbor hole

1/4" Mounted Steel Shanks

Wheels are designed with a 1/4" steel shank as an integral part of each wheel. These shanks run through the wheel creating better balance, a reduction of chatter, and reduced operator fatigue. They also permit quick changes on air tools when using other abrasive products.

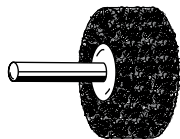

SIZE (D x W x SK.)	ABRASIVE	COATED GRIT	NON-WOVEN GRIT	MAX. RPM	STD. PKG.	TIER: GOOD GOOD	
						TRADENAME: INTERLEAF	NON-WOVEN
						PART #	PART #
2 x 1 x 1/4	A/O	60	Very Fine	12,000	10	088341 38122	
	A/O	80	Very Fine	12,000	10	088341 38123	
	A/O		Medium	12,000	20		662611 89992*
	A/O	120	Very Fine	12,000	10	088341 44457	
	A/O	180	Very Fine	12,000	10	088341 44458	
2 x 1-1/2 x 1/4	A/O	320	Very Fine	12,000	10	088341 44459	699573 99202
	A/O	80	Very Fine	12,000	10	088341 38125	
	A/O	120	Very Fine	12,000	10	088341 38126	
3 x 1 x 1/4	A/O	320	Very Fine	12,000	10	088341 38128	
	A/O	60	Very Fine	12,000	10	088341 38129	
	A/O	80	Very Fine	12,000	10	088341 38130	
3 x 1 x 1/4	A/O		Medium	12,000	10		088341 31921
	A/O	120	Very Fine	12,000	10	088341 38118	
	A/O	180	Fine	12,000	10	088341 38120	
	A/O	320	Very Fine	12,000	10	088341 38119	
	A/O	120	Very Fine	8,000	10	088341 44460	
3 x 2 x 1/4	A/O	180	Very Fine	8,000	10	088341 44461	
	A/O	80	Very Fine	12,000	10	088341 21115	
4 x 2 x 1/4	A/O	120	Very Fine	12,000	10	088341 20458	

*Standard package quantity = 20

Arbor Hole Mounts

For use on larger portable and fixed-base tools where the wheel must fit on an existing arbor.

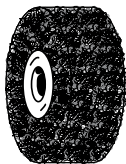

SIZE (D x W x SK.)	ABRASIVE	COATED GRIT	NON-WOVEN GRIT	MAX. RPM	STD. PKG.	TIER: GOOD GOOD	
						TRADENAME: INTERLEAF	NON-WOVEN
						PART #	PART #
3 x 2 x 3/8	A/O	60	Very Fine	12,000	10	088341 39000	
	A/O	120	Very Fine	12,000	10	088341 39001	
	A/O	240	Very Fine	12,000	10	088341 39028	
	A/O	320	Very Fine	12,000	10	088341 39024	
4 x 2 x 5/8	A/O	60	Very Fine	12,000	10	088341 26025	
	A/O	240	Very Fine	12,000	10	088341 26014	
	A/O	320	Very Fine	12,000	10	088341 26027	
6 x 1 x 1	A/O	120	Very Fine	6,000	10	088341 26006	
	A/O	240	Very Fine	6,000	10	088341 26030	
6 x 1 x 2	S/C	-	Very Fine	3,000	4		055395 12658
6 x 2 x 1	A/O	80	Very Fine	6,000	10	088341 26009	
	A/O	180	Very Fine	6,000	10	088341 26018	
6 x 3 x 1	A/O	80	Very Fine	6,000	6	088341 26055	
8 x 2 x 3	A/O	-	Medium	2,500	2		055395 12677
12 x 2 x 5	A/O	-	High Strength	1,900	1		055395 62637

Refer to Non-Woven
Convolute Wheel
section for Flap Wheel
Reducing Bushings.

Non-Woven High Strength Discs

Applications include rust/oxide or coating removal, pipe ID and OD polishing, casting cleaning, highlighting (antiquing), contaminant removal, removal of handling marks, gasket removal, cleaning and blending of surface imperfections, prepping prior to soldering, removal of filling materials, cleaning angles and odd shapes. Will not stretch or shed. Ganging increases versatility. For use on larger portable and fixed-base tools where the wheel must fit on an existing arbor.

Best choice for light deburring and finishing



HIGH STRENGTH DISCS

- Premium aluminum oxide grain; engineered for more demanding applications
- Tough but flexible web resists tearing on burrs and sharp edges; and conforms to intricate shapes and contours without changing the workpiece dimension; can be ganged together and used as a wheel
- Smear-free bond excels at producing light satin finishes

TIER: **BEST**

TRADENAME: **HIGH STRENGTH**

ABRASIVE: Aluminum Oxide

SIZE (D x H)	GRIT	MAX. RPM	STD. PKG.	PART #
6 x 1/4	VF	4,000	70	662610 07628
6 x 1/2	M	4,000	70	662610 05073
	VF	4,000	70	662610 04980
8 x 1/2	M	3,000	50	662610 05491
	VF	3,000	50	662610 04506
12 x 1-1/4	VF	1,900	25	662610 08723



FITS HOLE	FOR DISC WIDTH	FOR DISC DIAMETER	SHANK DIAMETER	OVERALL LENGTH	WASHER DIAMETER	STD. PKG.	PART #
Mandrel Assemblies For Using Discs On Edge							
1/4"	1/2" (Standard)	up to 6"	1/4"	2-1/2"	1-1/2"	1	662610 09502
1/2"	1/2" (Standard)	Up to 8"	1/4"	3-1/8"	2-1/4"	1	662610 59420



Flaps of abrasive cloth are stacked, inserted into a holder, and then attached to a mandrel. The flaps are designed to break down during use and reveal the next layer of abrasive.

To create an interleaf bore polisher, cloth flaps are mixed with non-woven flaps.

Applications:

For deburring, sizing, cleaning and polishing the interior diameters of cylinders, tubes and hydraulic fittings. Flaps adjust automatically to inside diameter, polishing the entire surface area with each pass.

Bore polishers are self-centering, so they apply equal pressure to full wall of inside diameter. Spring action design gives faster inside diameter cleaning, deburring and polishing to cylinders, deep bores and tubes.

Interleafed bore polishers are designed to polish and finish in one easy application. The abrasive flaps cut, while the non-woven flaps apply a fine finish.

Grit Range:

60 - 240

Abrasive Grain:

Aluminum Oxide

Application-to-Product Shape Recommendation Guide

Shape

Solid Flaps
B-3 Series



Application

- For 5/8" to 1" interior diameter bores
- 3 abrasive packs 1-1/2" wide, bonded to hub
- Use with QC-5 mandrel Part # 088341**54182**

Solid Flaps
B-4 Series



- For 1" to 4" interior diameter bores
- 4 abrasive packs 1-1/2" wide, bonded to hub
- Use with BPM-4 mandrel Part # 088341**54183**

Solid Flaps
B-8 Series



- For 2" to 5-7/8" interior diameter bores
- 8 abrasive packs 1-1/2" wide, bonded to hub
- Use with BPM-8 mandrel Part # 088341**54184**

Scored Flaps



Available upon request as made-to-order products.

Interleaf



Cloth flaps are mixed with non-woven flaps. Interleaf bore polishers do double duty. Designed to polish and finish in one easy application, they are the ideal choice when close tolerances must be maintained, while giving an interior a polished finish.

Application/Grit Recommendation Guide

COARSER (MATERIAL REMOVAL)		FINER (FINISHING)		
←		→		
60	80	120	180	240
Blending Out Medium Machine Marks				
Sizing Cylinders				
	Deburring Cylinders			
	Blending Metal Surfaces			
	Cleaning Cylinders			
	Applying Light Scratch Pattern			
			Fine Blending and Cleaning	
			Metal Finishing and Polishing	
← SOLID FLAP		SCORED		INTERLEAF →

Aluminum Oxide Bore Polishers

TIER: **GOOD**
 TRADENAME: **R369**
 ABRASIVE: Aluminum Oxide
 BACKING: Y-weight Cotton/Poly

DESCRIPTION	GRIT	MAX. RPM	STD. PKG.	PART #
Bore Polishers – Solid Flap B-3 and B-4 Series				
B-305	60	25,000	10	088341 54190
Fits ID 5/8 to 1	80	25,000	10	088341 54191
	120	25,000	10	088341 54193
	180	25,000	10	088341 54195
	240	25,000	10	088341 54197
B-405	60	22,000	10	088341 54091
Fits ID 1 to 1-1/2	80	22,000	10	088341 54092
	120	22,000	10	088341 54093
	180	22,000	10	088341 54094
B-410	60	20,000	10	088341 54100
Fits ID 1-1/2 to 2	80	20,000	10	088341 54101
	120	20,000	10	088341 54102
	180	20,000	10	088341 54103
	240	20,000	10	088341 54104
B-415	60	16,000	10	088341 54109
Fits ID 2-1/8 to 2-1/2	80	16,000	10	088341 54110
	120	16,000	10	088341 54111
	180	16,000	10	088341 54112
B-420	60	15,000	10	088341 54118
Fits ID 2-1/2 to 3	80	15,000	10	088341 54119
	120	15,000	10	088341 54120
	180	15,000	10	088341 54121
	240	15,000	10	088341 54122
B-425	60	10,000	10	088341 54127
Fits ID 3-1/8 to 4	80	10,000	10	088341 54128
	120	10,000	10	088341 54129
	180	10,000	10	088341 54130

NS Non-stock. Contact your Norton representative for current order quantities and lead-times.

TIER: **GOOD**
 TRADENAME: **R369**
 ABRASIVE: Aluminum Oxide
 BACKING: Y-weight Cotton/Poly

DESCRIPTION	GRIT	MAX. RPM	STD. PKG.	PART #
Bore Polishers – Solid Flap B-8 Series				
B-810	60	16,000	10	088341 54136
Fits ID 2 to 2-1/2	80	16,000	10	088341 54137
	120	16,000	10	088341 54138
	180	16,000	10	088341 54139 NS
	240	16,000	10	088341 54140 NS
B-815	60	15,000	10	088341 54145
Fits ID 2-5/8 to 3	80	15,000	10	088341 54146
	120	15,000	10	088341 54147
	180	15,000	10	088341 54148 NS
	240	15,000	10	088341 54149 NS
B-820	60	10,000	10	088341 54154
Fits ID 3-1/8 to 4	80	10,000	10	088341 54155
	120	10,000	10	088341 54156
	180	10,000	10	088341 54157
	240	10,000	10	088341 54158 NS
B-825	60	8,000	10	088341 54163
Fits ID 4-1/4 to 5-1/4	80	8,000	10	088341 54164
	120	8,000	10	088341 54165
	180	8,000	10	088341 54166
	240	8,000	10	088341 54167
B-830	60	8,000	10	088341 54172
Fits ID 5-1/4 to 5-7/8	80	8,000	10	088341 54173
	120	8,000	10	088341 54174
	180	8,000	10	088341 54175
	240	8,000	10	088341 54176

Bore Polishers – Scored Flaps

Available on request as made-to-order products

Bore Polishers – Interleaf

B-405 Interleaf	80	22,000	10	088341 50271
Fits ID 1 to 1-1/2	180	22,000	10	088341 50273

Mandrels for Bore Polishers

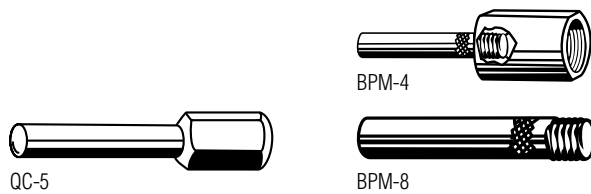

DESCRIPTION	MODEL NO.	THREAD	STD. PKG.	PART #
For B-3 Series	QC-5	5/16-18	1	088341 54182
For B-4 Series	BPM-4	1/2-20	1	088341 54183
For B-8 Series	BPM-8	1/4-20	1	088341 54184

Extension Mandrels for Bore Polishers

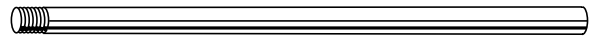

DIAMETER x LENGTH	MODEL NO.	THREAD	STD. PKG.	PART #
1/4 x 4	EM-144	1/4-20	1	088341 54185
1/4 x 6	EM-146	1/4-20	1	088341 54186
1/4 x 8	EM-148	1/4-20	1	088341 54187

To extend a B-4 series bore polisher, attach the adapter piece of the BPM-4 mandrel to the bore polisher, then attach the desired length extension mandrel above to the BPM-4 adapter piece. To extend a B-8 series bore polisher, attach the desired length extension mandrel above directly to the bore polisher.

Bore Polisher Test Kit “BP”

- Part # 088341**54181**
- Contains ten bore polishers and two mini 1/4"-20 thread flap wheels in assorted sizes and grits for finishing 1" to 5" interior diameters, and mandrel for 1/4" chuck.





Made from non-woven synthetic fiber mesh, which is impregnated with abrasives and bound with resins, non-woven wheels are designed to create desired surface finish where little or no stock removal is required. The industry's broadest offering is available for light stock removal, deburring, blending, finishing and polishing. Non-woven wheels have an open mesh construction that is waterproof, washable, conformable and non-loading.

Applications:

Cleaning and removing imperfections on metal surfaces, cleaning built-up residue, deburring or finishing a variety of surfaces, blending weld seams or creating decorative finishes. Non-woven surface finishing products have excellent versatility.

Abrasive Grain:

Ceramic Alumina, Engineered Aluminum Oxide, Aluminum Oxide, Silicon Carbide

Grit Range:

Extra Coarse (XC), Coarse (C), Medium (M), Fine (F)

Machine Used:

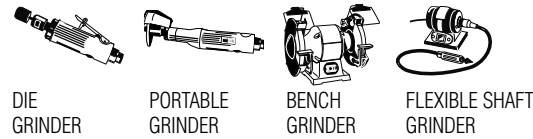

Application/Grit Recommendation Guide

	← MOST AGGRESSIVE		← LEAST AGGRESSIVE →
NORTON	Rapid Strip Wheels	Rapid Blend Unified Wheels	Non-Woven / Interleaf Flap Wheels
Scale Removal	Best Choice		
Painting/Coating Removal	Best Choice		
Stock Removal		Best Choice	
Heavy Deburring		Best Choice	
Polishing			Second Choice
Buffing			Best Choice

Surface Finish Variables

Changes in any one of many factors can affect the surface finish on the workpiece. This chart shows the effect on surface finish by changes in single factors of product specifications. Arrows have been used to signify the trend direction. The arrow length does not signify that the effect of each factor is equal.

Variable Factor	Rough Finish High RMS Reading	Smooth Surface Lower RMS Reading
1. Wheel Speed	Slow ←	→ Fast
2. Feed Speed	Faster (Long Scratch) ←	→ Slower (Short Scratch)
3. Oscillation	No Oscillation ←	→ Oscillation
4. Lubricants	Dry ←	→ Water ←
		→ Soluble Oil ←
		→ Straight Oil
		← Compounds →

Non-Woven Marking System

ABRASIVE	SILICON CARBIDE	ALUMINUM OXIDE		
	← SHARPER, FINER/BRIGHTER SCRATCH PATTERN	→ MORE DURABLE, LONGER LASTING, POLISHED FINISH		
GRIT SIZE	XC (50)	C (60-80)	M (100-150)	F (180-220)
	← FASTER, AGGRESSIVE CUT, ROUGHER FINISH	→ REDUCED CUT RATE, FINER FINISH		
DENSITY	2	9		
	← SOFT, OPEN, CONFORMABLE, LESS BURNING/LOADING	→ HARDER, MORE DURABLE, FASTER CUTTING, BETTER FINISH		

Cross Reference Guide

	STRIPPING	HEAVY/LIGHT DEBURRING	LIGHT DEBURRING/BLENDING/POLISHING	CLEANING/FINISHING	
	BEST	BETTER	BEST	BETTER	GOOD
NORTON	Blaze Rapid Strip	Rapid Strip	Vortex Rapid Blend	Rapid Blend NEX	Non-Woven / Interleaf Flap Wheels
3M	Clean and Strip XT PRO, Clean and Strip XT PRO Extra Cut	Clean Strip	Cut & Polish Unitized, Deburr and Finish PRO	EXL Unitized	Finishing Flap Brush
Standard		Britestrip	800 & 900 Series	500 - 700 Series	Buff & Blend Flap Brush

Rapid Strip Unified Wheels

Best choice for removing rust, scale and paint/coatings on a variety of substrates, such as wood, metal and plastics



BLAZE RAPID STRIP CERAMIC ALUMINA

- Norton Blaze ceramic alumina grain provides 2X cut rate, 2X life over silicon carbide products
- Advanced resin bond does not shed on rust-encrusted pieces, and prevents gouging and rework; does not snag when used for deburring
- Leave a thoroughly cleaned surface that ensures excellent adhesion for subsequent processes such as coating, painting and soldering

Better choice for removing coatings on a variety of substrates such as wood metal and plastics



RAPID STRIP SILICON CARBIDE

- Faster cutting, sharp, extra coarse silicon carbide abrasive provides a unique combination of aggressive performance, long life, and improved finish
- Advanced resin bond prevents shedding on rust-encrusted pieces and gouging and rework; does not snag when used for deburring
- Leaves a thoroughly clean surface that ensures excellent adhesion in subsequent processes such as coating, painting and soldering



TIER:	BEST	BETTER
TRADENAME:	BLAZE RAPID STRIP	RAPID STRIP
ABRASIVE:	Ceramic Alumina	Silicon Carbide
GRIT:	Extra Coarse	Extra Coarse

SIZE (D x H)	MAX. RPM	STD. PKG.	PART #	PART #
Arbor Hole				
4 x 1/4	8,000	25	662610 09324	662610 08008
4 x 1/2	8,000	25	666233 04856	662610 07916
6 x 1/4	4,000	15	666233 40171	662610 07988
6 x 1/2	4,000	15	662610 99378	662610 08051



FITS HOLE	FOR DISC WIDTH	FOR DISC DIAMETER	SHANK DIAMETER	OVERALL LENGTH	WASHER DIAMETER	STD. PKG.	PART #
Mandrel Assemblies For Non-Woven Unified Wheels							
1/4"	1/2" (Standard)	up to 6"	1/4"	2-1/2"	1-1/2"	1	662610 09502
1/2"	1/2" (Standard)	Up to 8"	1/4"	3-1/8"	2-1/4"	1	662610 59420

Rapid Blend Unified Wheels *continued*

Designed for maintenance operations needing an efficient and cost-effective method of deburring, polishing, cleaning or finishing metals and composites. Easily preformed for use on a wide variety of shapes/contours. Hold shape well; less wheel dressing. Non-metallic so no contamination of workpiece. Uniform construction maintains part tolerance; prevents cutting or gouging.



Best choice for light weld bead and weld spatter removal, heavy deburring and finishing applications

VORTEX RAPID BLEND ALUMINUM OXIDE

- High-performance, medium grit, engineered aluminum oxide grain and improved resin bond system provide aggressive, fast, stock removal, reduced cycle times, and excellent part quality
- Thick nylon web delivers 2X longer life and faster finishing – with minimal shedding vs competitive wheels
- Controlled porosity ensures cool cutting and improved cut rate

TIER: **BEST**
TRADENAME: **VORTEX RAPID BLEND**
ABRASIVE: Aluminum Oxide

SIZE (D x T x H)	GRIT SIZE	STD. PKG.	MAX. RPM	3 DENSITY PART #	MAX. RPM	5 DENSITY PART #	MAX. RPM	7 DENSITY PART #	MAX. RPM	9 DENSITY PART #
2 x 1/8 x 1/8	M	60			22,000	662544 25657	20,000	662544 10849		
2 x 1/8 x 1/4	M	60					22,000	66261 191446		
2 x 1/4 x 1/4	M	60	18,000	662544 28456	22,000	662544 33504	22,000	662610 80270		
2 x 1 x 1/4	M	15					22,000	662610 80269		
3 x 1/8 x 1/4	M	40			18,000	662610 93448	18,000	662611 91445		
3 x 1/8 x 3/8	M	40			18,000	662544 33503	18,000	662544 01131		
3 x 1/4 x 1/4	M	40	12,000	662544 28454	18,000	662544 14832	18,000	662611 99696		
3 x 1/4 x 3/8	M	40	12,000	662544 33505	12,000	662544 33506				
3 x 1/2 x 1/4	M	20			18,000	662544 32925	18,000	662610 80267	18,000	662544 33507
3 x 1/2 x 3/8	M	20			18,000	662544 33508	18,000	662610 80266	18,000	662544 20696



Better choice for light deburring and blending

RAPID BLEND NEX ALUMINUM OXIDE AND SILICON CARBIDE

- Uniform construction provides extra long life and holds shape well for less wheel dressing
- Smear free resin binder formula provides smear-free finishes
- A great option for light deburring and blending applications

TIER: **BETTER**
TRADENAME: **RAPID BLEND NEX**

SIZE (D x T x H)	ABRASIVE	GRIT	MAX. RPM	STD. PKG.	2 DENSITY PART #	3 DENSITY PART #	4 DENSITY PART #	6 DENSITY PART #	8 DENSITY PART #
1 x 1 x 3/16	A/O	C	30,000	50					662610 14915
	A/O	M	18,000	50	662610 14891				
	A/O	M	30,000	50				662610 14908	662610 14924
	S/C	F	18,000	50	662610 14883				
	S/C	F	30,000	50				662610 14904	662610 14923
2 x 1/8 x 1/4	A/O	M	22,000	60					662610 14927
2 x 1/4 x 1/4	A/O	M	18,000	60	662610 14892				
	A/O	M	22,000	60					662610 14926
	A/O	F	22,000	60				662610 14901	
	S/C	F	18,000	60	662610 14884				
2 x 1/2 x 1/4	A/O	M	22,000	30					662610 14925
3 x 1/4 x 1/4	A/O	C	18,000	40					662610 14919
	A/O	M	18,000	40				662610 14909	662610 14930
	S/C	F	12,000	40	662610 14886				
3 x 1/4 x 3/8	A/O	C	18,000	40					662610 14920
	A/O	M	12,000	40	662610 14895				
	A/O	M	18,000	40				662610 14910	662610 14933
	A/O	F	12,000	40			662610 14899		
	S/C	F	12,000	40	662610 14887	662610 16006			
3 x 1/2 x 1/4	A/O	M	12,000	20	662610 14893				
	A/O	M	18,000	20				662610 14928	
	S/C	F	12,000	20	662610 14885				
3 x 1/2 x 3/8	A/O	M	18,000	20					662610 14929
3 x 1 x 3/8	S/C	XC	18,000	10				662610 14914	
6 x 1/2 x 1	A/O	M	7,500	4					662610 14931
6 x 1 x 1	S/C	F	5,000	2	662610 14888				

Assemblies and Mandrels for Unified Wheels

FITS WHEEL CENTER HOLE	FOR WHEEL WIDTH	FOR WHEEL DIAMETER	SHANK DIAMETER	OVERALL LENGTH	WASHER DIAMETER	3M EQUIVALENT	STD. PKG.	PART #
Mandrel Assemblies for Unified Wheels and Discs On Edge								
3/16	1/8 – 1/2	1 – 2	1/4	2	7/16	994	1	662610 09852
1/4 – 5/16	Up to 1/2	Up to 2	1/4	2	5/8	932	1	662610 15146
1/4 – 5/16	Up to 1	Up to 2	1/4	2-1/2	5/8	932	1	662610 59422
	Up to 1	2 – 3	1/4	2-1/2	1	933	1	662610 59421
3/8	Up to 1/2	2 – 4	1/4	2-1/2	1	990	1	662610 09851
1/2	Up to 1	3 – 6	1/4	3-1/8	1-5/8	934	1	662610 09850
FOR CENTER HOLE	USE WITH UNIFIED WHEEL	SHANK DIAMETER	SHANK LENGTH			3M EQUIVALENT	STD. PKG.	PART #
Threaded Mandrel for Unified Wheels								
3/16	1 x 1 x 3/16	1/4"	1-3/4"			948	5	662610 47584



MANDREL ASSEMBLY 662610**59421**



THREADED MANDREL 662610**47584**



MANDREL ASSEMBLY 662610**59422**





NEW

Used in a multitude of operations in almost every industry and on a variety of machines, mounted points are small grinding wheels permanently fastened to its own spindle. These vitrified bond mounted points are available in a wide range of shapes.

- Industries:**
- Aerospace
 - Tool and Die
 - Construction
 - Metal Fabrication
 - Automotive
- Cutlery
 - Mold Shops
 - Stainless Steel Equipment
 - Foundries

- Abrasive Grain:** Aluminum Oxide
Shape Availability: A, B, and W
Machine Used:

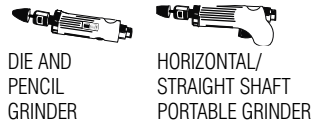

DIE AND
PENCIL
GRINDER

HORIZONTAL/
STRAIGHT SHAFT
PORTABLE GRINDER

Measurement Guide

Description of Overhang

Overhang is the distance between the grinder chuck and the abrasive on the spindle. The larger the overhang, the lower the maximum safe operating speed.

Size

Measured by diameter (D) x thickness (T)

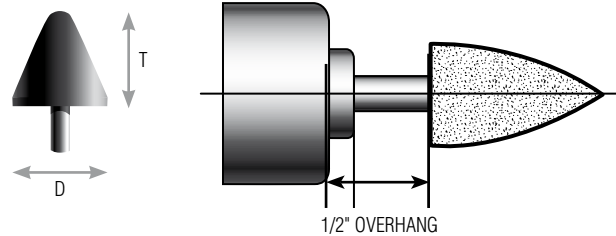

NEW

Better medium grit option for blending and deburring

PINK ALUMINUM OXIDE – VITRIFIED BOND

- Sharp versatile 86A aluminum oxide grain is free cutting and resists burn
- Excellent form holding compared to more friable white aluminum oxides
- Medium grit for blending and deburring

TIER: **BETTER**
TRADENAME: **PINK**
ABRASIVE: 86A Aluminum Oxide

SHAPE	SIZE (D x T)	SPINDLE DIA. †	MAX. RPM*	MIN./STD. PKG.	SPEC	PART #
Vitrified Bond Mounted Points – A Shapes						
A1	3/4 x 2-1/2	1/4	19,800	5/25	86A80-S	690786 45335
A3	1 x 2-3/4	1/4	16,100	5/25	86A80-S	690786 45333
A5	3/4 x 1-1/8	1/4	45,000	5/25	86A80-S	690786 45339
A11	7/8 x 2	1/4	19,860	5/25	86A80-S	690786 45336
A12	11/16 x 1-1/4	1/4	48,000	5/25	86A80-S	690786 45344
A25	1" Ball	1/4	35,620	5/25	86A80-S	690786 45341
A38	1 x 1	1/4	34,500	5/25	86A80-S	690786 45345
Vitrified Bond Mounted Points – B Shapes						
B52	3/8 x 3/4	1/8	45,370	5/25	86A80-S	690786 45334
B53	5/16 x 5/8	1/8	60,000	5/25	86A80-S	690786 45340
B81	3/4 x 3/16	1/8	50,930	5/25	86A80-S	690786 45347
B97	1/8 x 3/8	1/8	105,000	5/25	86A80-S	690786 45337
B121	1/2" Ball	1/8	45,370	5/25	86A80-S	690786 45338
B122	3/8" Ball	1/8	61,650	5/25	86A80-S	690786 45360
B135	1/4 x 1/2	1/8	60,000	5/25	86A80-S	690786 45342
Vitrified Bond Mounted Points – W Shapes						
W163	1/4 x 1/2	1/8	60,000	5/25	86A80-S	690786 45346
W177	3/8 x 3/4	1/8	33,750	5/25	86A80-S	690786 45355
W185	1/2 x 1/2	1/4	61,500	5/25	86A80-S	690786 45354
W200	3/4 x 1/8	1/8	50,930	5/25	86A80-S	690786 45356
W220	1 x 1	1/4	25,500	5/25	86A80-S	690786 45359
W235	1-1/2 x 1/4	1/4	25,470	5/25	86A80-S	690786 45343

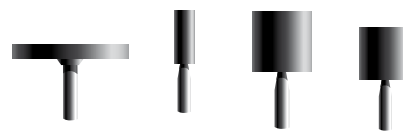
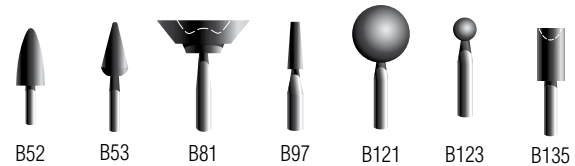
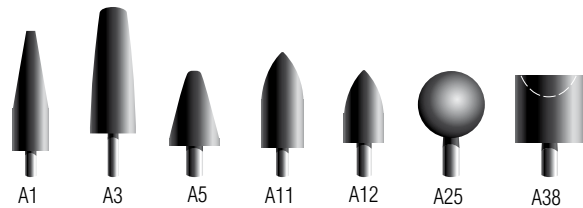

W SHAPES

† Standard spindle size is 1/4" x 1-1/2"

* Maximum RPM valid to 1/2" overhang. See package insert for other overhangs.

Refer to the Precision Offhand/Portable section for the full offering of mounted points.



NEW

Our double-cut style carbide burrs have stronger tooth formulation and numerous cutting edges to outperform other double-cut carbide burrs with better stock removal, granular chip break, and longer life.

Pair up these long-lasting burrs with our pneumatic die grinder to quickly and comfortably accomplish many portable applications on one machine – including jobs using specialties, small diameter flap wheels, and mounted points.

Applications: Deburring, medium-to-light surface cleaning and stock removal, weld removal and prep, chamfering

Shapes: A, B, C, D, E, F, G, H, L, M

Shank Diameter: 1/4"

Machine Used:



DIE GRINDER

Understanding the Product

Burr Dimensions

D1	L1	D2	L2
HEAD DIAMETER	HEAD LENGTH	SHANK DIAMETER	OVERALL BURR LENGTH (OL)

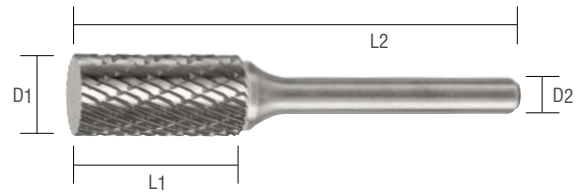

TECH TIP

Each carbide burr is packed individually in a clear, protective plastic case with Norton-blue end-caps. Each burr is marked with the burr head diameter and length for easy identification.

Carbide Burrs Merchandising Display

For those last minute point-of-purchase sales the Carbide Burr merchandiser is an ideal addition to any counter or display shelf. Holds twenty-four burrs in the lockable front display with plenty of storage in the back drawer.



MERCHANDISING DISPLAY

SUB-SHAPE	D	W	H	MIN/STD PKG QTY	PART #
Carbide Burr Merchandising Display	15-1/4"	9-1/4"	16"	1	699573 66825



DISPLAY HEADER CARD



DISPLAY BACKER DECAL

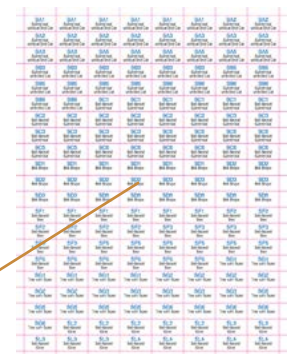

DISPLAY PRODUCT DECALS

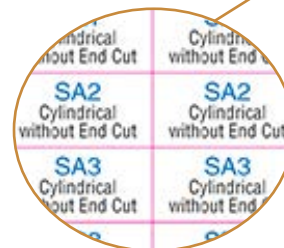



Double cut burrs are a popular choice because of their universal cutting style

DOUBLE CUT CARBIDE BURRS

- Hard tungsten carbide burrs with strong tooth formulations and numerous cutting edges for extended life and less changeover downtime versus other cutting tools
- Higher stock removal, and smaller, granular chip-break on hard-to-grind workpieces versus other carbide burrs
- Perform well at higher temperatures and can be used longer than high-speed steel tools – even if your operation generates some heat

Carbide Burrs for Standard Metal Removal

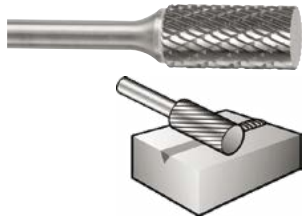

SA Cylindrical without End Cut

The ends of these burrs are flat, with no cutting edges and are used for contour finishing and to get into right-angled corners.

SUB-SHAPE	MAX. RPM	D1	L1	L2	MIN/STD PKG QTY	PART #
SA1	25,000	1/4"	3/4"	2"	1	699573 08002
SA2	25,000	5/16"	3/4"	2-1/2"	1	699573 08003
SA3	25,000	3/8"	3/4"	2-1/2"	1	699573 08004
SA5	25,000	1/2"	1"	2-3/4"	1	699573 08005
SA5	25,000	1/2"	1"	6"	1	699573 60674



SB Cylindrical with End Cut

The cutting edge at the end of the burr makes these burrs a good choice for contour finishing.

SUB-SHAPE	MAX. RPM	D1	L1	L2	MIN/STD PKG QTY	PART #
SB3	25,000	3/8"	3/4"	2-1/2"	1	699573 08006
SB3	25,000	3/8"	3/4"	6"	1	699573 40156
SB5	25,000	1/2"	1"	2-3/4"	1	699573 08007
SB5	25,000	1/2"	1"	6"	1	699573 40157
SB6	25,000	5/8"	1"	2-3/4"	1	699573 08008

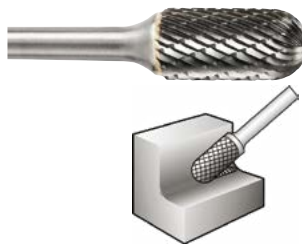

SC Ball-Nosed Cylindrical

Use these round-nosed burrs for smoother operation and better tool control.

SUB-SHAPE	MAX. RPM	D1	L1	L2	MIN/STD PKG QTY	PART #
SC1	25,000	1/4"	3/4"	2"	1	699573 08009
SC2	25,000	5/16"	3/4"	2-1/2"	1	699573 08010
SC3	25,000	3/8"	3/4"	2-1/2"	1	699573 08011
SC3	25,000	3/8"	3/4"	6"	1	699573 60678
SC5	25,000	1/2"	1"	2-3/4"	1	699573 08012
SC5	25,000	1/2"	1"	6"	1	699573 60679
SC5	25,000	1/2"	1"	12"	1	699573 60905
SC6	25,000	5/8"	1"	2-3/4"	1	699573 08013

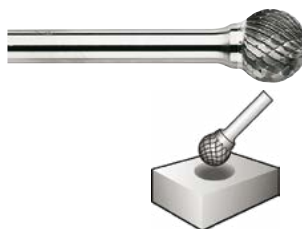

SD Ball Shape

Use these carbide burrs to create a concave and to hollow out a workpiece.

SUB-SHAPE	MAX. RPM	D1	L1	L2	MIN/STD PKG QTY	PART #
SD1	25,000	1/4"	1/4"	2"	1	699573 08014
SD2	25,000	5/16"	1/4"	2"	1	699573 08015
SD3	25,000	3/8"	5/16"	2-1/8"	1	699573 08016
SD5	25,000	1/2"	7/16"	2-3/16"	1	699573 08017
SD5	25,000	1/2"	7/16"	6"	1	699573 60686
SD9	25,000	1"	15/16"	2-15/16"	1	699573 60865

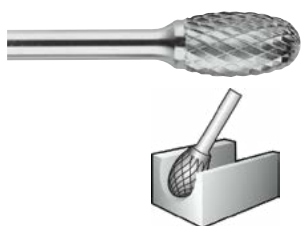

SE Oval Shape

Use the oval-shaped carbide burrs for good reach and round head for shaping.

SUB-SHAPE	MAX. RPM	D1	L1	L2	MIN/STD PKG QTY	PART #
SE3	25,000	3/8"	5/8"	6"	1	699573 40158
SE5	25,000	1/2"	7/8"	6"	1	699573 40159

Carbide Burrs for Standard Metal Removal

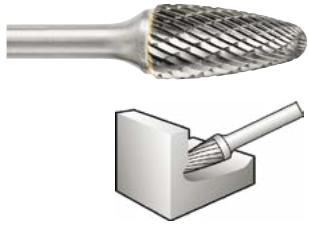

SF **Ball-Nosed Tree**
Designed to round off edges and make concave cuts.

SUB-SHAPE	MAX.-RPM	D1	L1	L2	MIN/STD PKG QTY	PART #
SF1	25,000	1/4"	3/4"	2"	1	699573 08018
SF2	25,000	5/16"	3/4"	2-1/2"	1	699573 08019
SF3	25,000	3/8"	3/4"	2-1/2"	1	699573 08020
SF3	25,000	3/8"	3/4"	6"	1	699573 60689
SF5	25,000	1/2"	1"	2-3/4"	1	699573 08021
SF5	25,000	1/2"	1"	6"	1	699573 60691
SF5	25,000	1/2"	1"	12"	1	699573 60904
SF6	25,000	5/8"	1"	2-3/4"	1	699573 08022



SG **Tree with Taper**
The taper allows access to hard-to-reach areas, such as angled contours.

SUB-SHAPE	MAX.-RPM	D1	L1	L2	MIN/STD PKG QTY	PART #
SG1	25,000	1/4"	3/4"	2"	1	699573 08023
SG2	25,000	5/16"	3/4"	2-1/2"	1	699573 08024
SG3	25,000	3/8"	3/4"	2-1/2"	1	699573 08025
SG5	25,000	1/2"	1"	2-3/4"	1	699573 08026
SG5	25,000	1/2"	1"	6"	1	699573 60712
SG6	25,000	5/8"	1"	2-3/4"	1	699573 08027
SG13	25,000	3/4"	1-1/2"	3/4"	1	699573 66821
SG15	25,000	3/4"	1-1/2"	1/4"	1	699573 60886

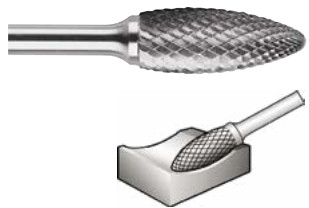

SH **Flame Shape**
Great for channel working and shaping due to its long fluted sides and rounded head.

SUB-SHAPE	MAX.-RPM	D1	L1	L2	MIN/STD PKG QTY	PART #
SH5	25,000	1/2"	1-1/4"	6"	1	699573 66822



SL **Ball-Nosed Cone**
This cone shape is excellent for imparting fine finishes.

SUB-SHAPE	MAX.-RPM	D1	L1	L2	MIN/STD PKG QTY	PART #
SL2	25,000	5/16"	7/8"	2-3/4"	1	699573 08028
SL3	25,000	3/8"	1 3/16"	2-15/16"	1	699573 08029
SL3	25,000	3/8"	1-1/16"	6"	1	699573 60716
SL4	25,000	1/2"	1 3/16"	3"	1	699573 08030
SL4	25,000	1/2"	1-3/16"	6"	1	699573 60720
SL5	25,000	1/2"	1"	6"	1	699573 66823



SM **Pointed Cone**
Ideal for rounded edges or reaching difficult, tight areas.

SUB-SHAPE	MAX.-RPM	D1	L1	L2	MIN/STD PKG QTY	PART #
SM4	25,000	3/8"	5/8"	6"	1	699573 66824
SM5	25,000	1/2"	7/8"	6"	1	699573 60767

Carbide Burr Kit



SUB-SHAPE	MIN/STD PKG QTY	PART #
Carbide Burr Kit*	1	699573 08060

* Kit Includes one each of: SA5 (699573**08005**), SF3 (699573**08020**), SF5 (699573**08021**), SG5 (699573**08026**), and SL4 (699573**08030**)

Carbide Burrs for Aluminum and Non-Ferrous Materials

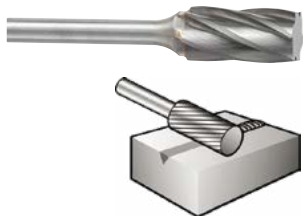

SA Cylindrical without End Cut

The ends of these burrs are flat, with no cutting edges and are used for contour finishing and to get into right-angled corners.

SUB-SHAPE	MAX. RPM	D1	L1	L2	MIN/STD PKG QTY	PART #
SA3 NF	25,000	3/8"	3/4"	2-1/2"	1	699573 40148
SA5 NF	25,000	1/2"	1"	2-3/4"	1	699573 40149

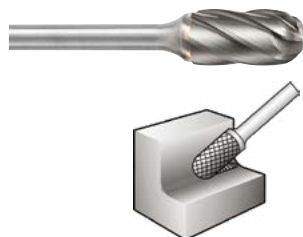

SC Ball-Nosed Cylindrical

Use these round-nosed burrs for smoother operation and better tool control.

SUB-SHAPE	MAX. RPM	D1	L1	L2	MIN/STD PKG QTY	PART #
SC3 NF	25,000	3/8"	3/4"	2-3/4"	1	699573 40150
SC5 NF	25,000	1/2"	1"	6"	1	699573 60657



SD Ball Shape

Use these carbide burrs to create a concave and to hollow out a workpiece.

SUB-SHAPE	MAX. RPM	D1	L1	L2	MIN/STD PKG QTY	PART #
SD3 NF	25,000	3/8"	5/16"	2-1/8"	1	699573 66820
SD5 NF	25,000	1/2"	7/16"	2-3/16"	1	699573 40152

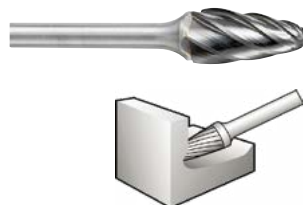

SF Ball-Nosed Tree

Designed to round off edges and make concave cuts.

SUB-SHAPE	MAX. RPM	D1	L1	L2	MIN/STD PKG QTY	PART #
SF1 NF	25,000	1/4"	3/4"	2"	1	699573 40153
SF3 NF	25,000	3/8"	3/4"	2-1/2"	1	699573 40154
SF5 NF	25,000	1/2"	1"	2-3/4"	1	699573 60647



SG Tree with Taper

The taper allows access to hard-to-reach areas, such as angled contours.

SUB-SHAPE	MAX. RPM	D1	L1	L2	MIN/STD PKG QTY	PART #
SG5 NF	25,000	1/2"	1"	2-3/4"	1	699573 60646

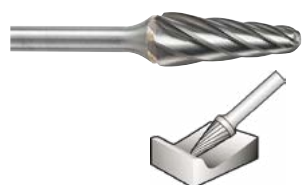

SL Ball-Nosed Cone

This cone shape is excellent for imparting fine finishes.

SUB-SHAPE	MAX. RPM	D1	L1	L2	MIN/STD PKG QTY	PART #
SL4 NF	25,000	1/2"	1-1/4"	6"	1	699573 60651

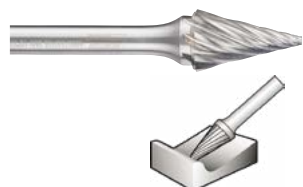

SM Pointed Cone

Ideal for rounded edges or reaching difficult, tight areas.

SUB-SHAPE	MAX. RPM	D1	L1	L2	MIN/STD PKG QTY	PART #
SM3 NF	25,000	1/2"	7/8"	2"	1	699573 40155

we've got you covered
**FROM DIY TO TOOLCRIB
TO PRODUCTION FLOOR**

Our bench wheels keep your tools sharp and productive. Reach tight spots with our wide variety of mounted points. Produce sharp edges with the Norton line of sharpening stones - bringing solutions for craftsmen and hobbyists alike for over 190 years.

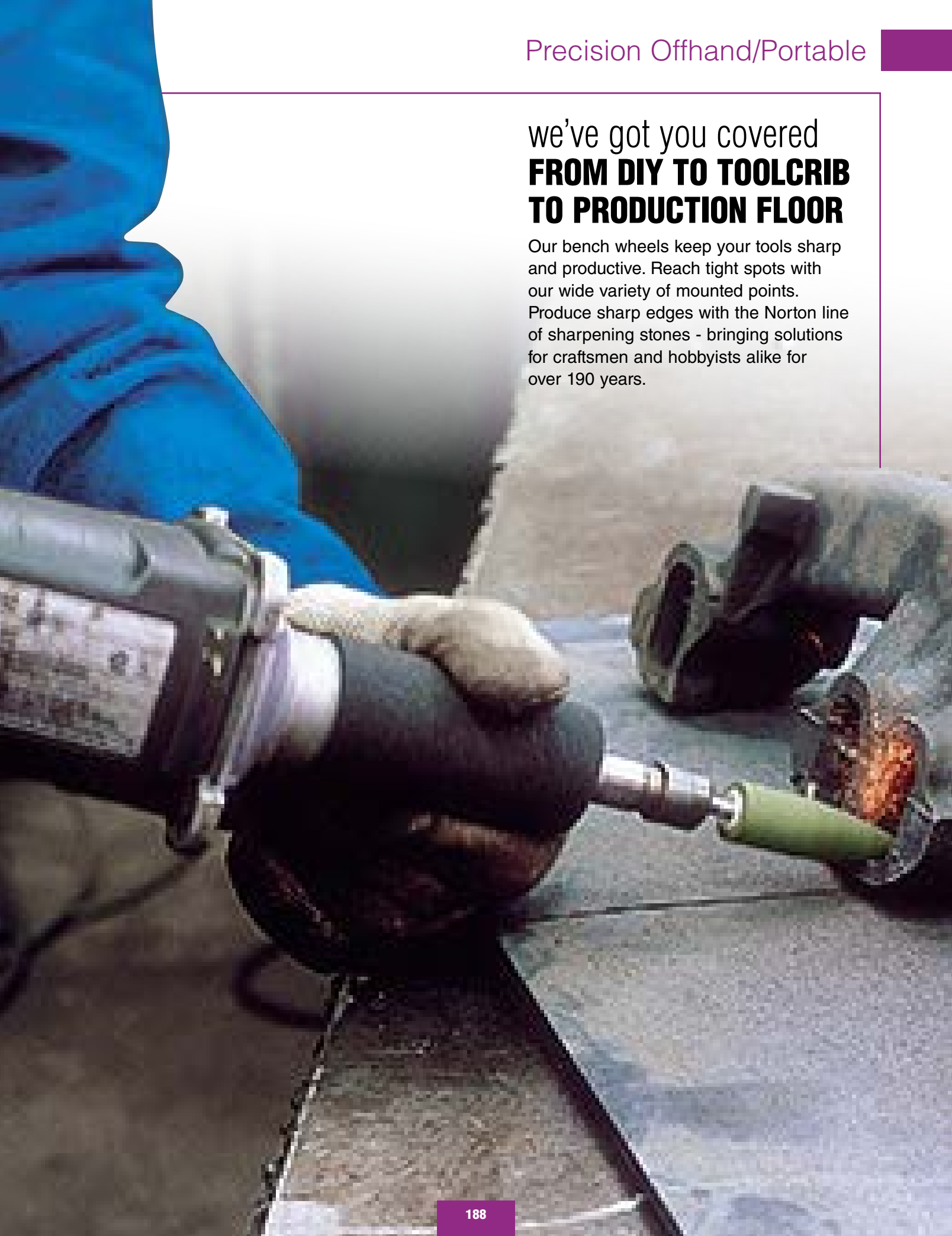

How to Read an Abrasive Product Specification

Conventional Grinding Wheels

32A 46 I 8 V BE

Abrasive			Grit Size			Grade			Structure	Bond Type	Norton Symbol
Aluminum Oxide	Ceramic	Silicon Carbide	Coarse	Medium	Fine	Soft	Medium	Hard	Relative grain spacing	Resin = B	Designates a variation or modification to bond.
23A	Oxide	4N	12	30	80	D	I	Q	Dense	Shellac = E	
25A	3SGP	39C	14	36	90	E	J	R		Plastic = P	
32A	3SGR	4Z	16	46	100	F	K	S		Rubber = R	
32AC (blend)	5SG	5Z	20	54	120	G	L	T		Vitrified = V	
38A	BRG	AZ (blend)	24	60	150	H	M	u			
48A	SG	BlueFire		70	220		N	V			
53A	SXG	Charger (blend)					O	Y			
55A	NorZon Plus (blend)	NZ					P	Z			
57A	NQ	NZC (blend)									
U57A	Quantum	NZIII									
64A	Targa	NZIV									
86A		NorZon									
90A		ZI									
Alundum											
FabCut											
India											
Gemini											
Metal											
Vortex											

Shelf Life and Proper Storage of Grinding Wheels

It has always been Saint-Gobain Abrasives recommendation that resinoid bonded grinding wheels be used within 2 years from the date of manufacture. This recommendation assumes that resinoid bonded grinding wheels have been stored under ideal storage conditions. It might be true that under ideal storage conditions resinoid bonded grinding wheels can survive without any degradation in strength for well over two years. However, it is always wise to suspect any wheels over two years old and have them reinspected or re-speed tested to determine if there has been any degradation in strength. If the wheels are stored under less than ideal conditions, they might have a much shorter shelf life depending upon the severity of storage conditions. These same comments also apply to rubber and shellac bonded grinding wheels.

As for vitrified grinding wheels, the shelf life is less influenced by humidity and adverse storage conditions as compared to resinoid, rubber or shellac, but even vitrified grinding wheels do not have an infinite shelf life. The best procedure and the best rule of thumb is to have any wheel that is two years old or older re-speed tested and reinspected to ensure it is fit for use. The procedure for having this done and the charges will be explained by our Customer Service Department, but the cost of shipping as well as the cost of re-inspection is the customer's responsibility. Also, any wheels rejected or otherwise lost in the re-inspection process will also be the responsibility of the customer.

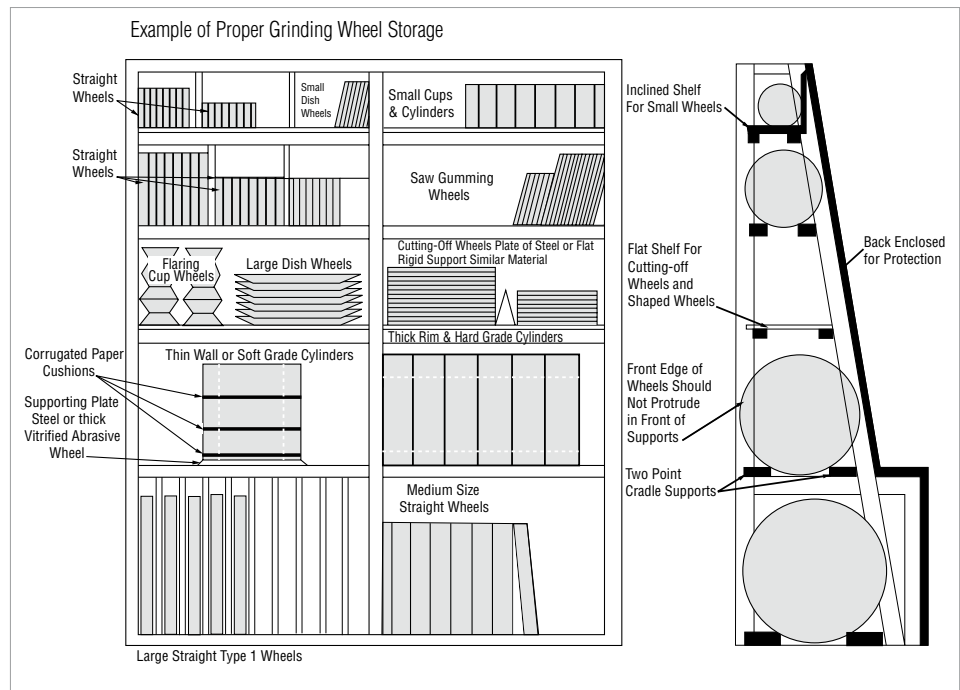

Keep in mind, however, that this procedure is good to verify the reliability of a product but must not be performed until you are ready to consume the wheel. If wheels are sent back after the two year time frame for re-inspection and re-testing and then put back on the shelf, there is no telling how long they will be fit for use after that last inspection. Therefore, these wheels must be consumed as soon as is practical.



The Norton bench and pedestal wheel line consists of numerous wheel diameters and arbor sizes, abrasive types and grit sizes. Our offering answers all metal removal, deburring, shaping and sharpening needs: white aluminum oxide for high-speed tool steels, brown aluminum oxide for carbon steel, and silicon carbide for non-ferrous metals and carbide tooling.

- Applications:** Offhand deburring and sharpening of parts and tools
- Size Range:** 5" – 18"
- Grit Range:** 24 – 150
- Abrasive Types:** Premium Ceramic Alumina, Aluminum Oxide, Silicon Carbide
- Bushings:** Telescopic arbor bushings to fit all popular grinders are packaged with the wheel
- Machine Used:**



BENCH GRINDER



PEDESTAL GRINDER

Application/Grit Recommendation Guide

COARSER (GRINDING)							FINER (FINISHING)
24	36	46	60	80	100	150	
Heavy Stock Removal		Medium Stock Removal			Light Stock Removal		
		Deburring/Shaping			Sharpening		
				Final Finishing			

TECH TIP

- Unsecured machines can move, causing grinding breakage and injury. Fixed-based bench and pedestal grinders **MUST** be secured.
- Do not grind wood, plastic, or any other non-metallic material on a bench or pedestal grinder.
- All bench and pedestal wheels must be dressed to prevent loading. Loading can cause excessive heat, damage to the workpiece, and wheel breakage. Dressing exposes new cutting edges and provides chip clearance.
- Recommended starting dressing stick: 1" x 1" x 6" 37C24-SVK Part # 6146361**0462**



It is the user's responsibility to refer to and comply with ANSI B7.1

iGrind App

Created by Norton engineers and updated based on feedback from you, the Norton iGrind app features calculators and conversion tools designed to help optimize your grinding processes.

With Norton iGrind, you can calculate the starting parameters for traverse or plunge truing your grinding wheel, determine the ideal setup for delivering coolant to the grinding zone, and convert wheel speeds between RPM, SFPM (Surface Feet Per Minute), and M/Sec to ensure a safe grinding operation.

App Features:

- Wheel Speed Converter
- Traverse Diamond Roll Dressing Calculator
- Coolant Calculator
- Plunge Diamond Roll Dressing Calculator
- Stationary Tool Dressing Calculator

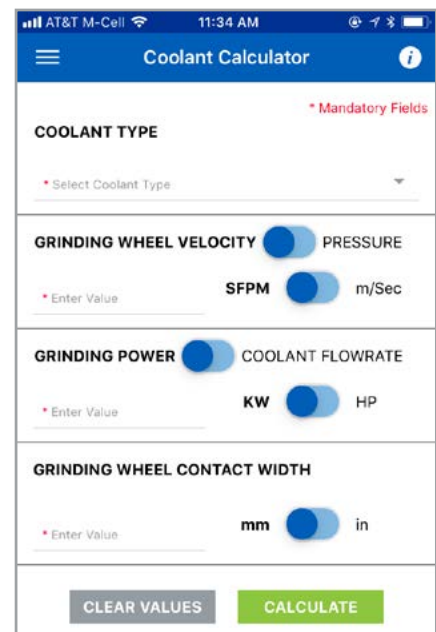
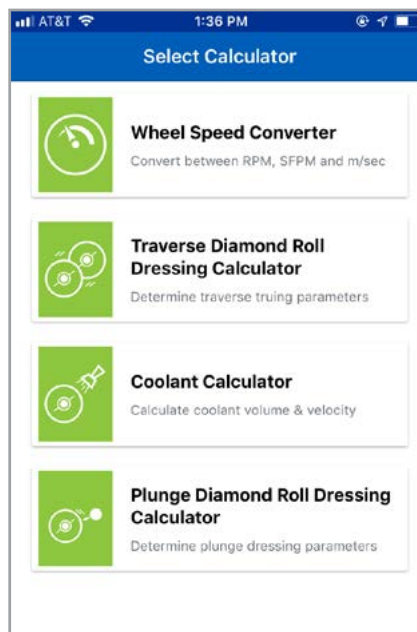



NEW

Best choice for deburring and tool sharpening on bench and pedestal grinders

PREMIUM CERAMIC ALUMINA 3SG

- Type O1 straight wheel with ceramic alumina grain has fast cut, minimal burn, and long wheel life
- High performance bond for versatility and exceptional form holding
- Especially great for hollow grinding of plane blades and chisels; telescoping bushings to fit popular arbor hole sizes



Better choice for light metal removal and sharpening of high-speed tool steels (55 Rc and higher)

PREMIUM WHITE ALUMINUM OXIDE

- Type O1 straight wheel with premium white aluminum oxide for maximum cut rate and cool grinding action on hardened or high-speed tool steels
- Vitrified bonded for superb shape holding and resistance to wear
- Better choice for deburring and tool sharpening on bench and pedestal grinders; telescoping bushings to fit popular arbor hole sizes



Better choice for light to medium stock removal

57A ALUMINUM OXIDE

- Type O1 straight wheel, the better choice for the end-user that needs a specific grit size and hardness for engineered applications
- Vitrified bond for superb shape holding and resistance to wear
- Excellent choice for deburring and tool sharpening on bench and pedestal grinders



Better choice for medium grit and grade for light to medium stock removal on carbide tooling and non-ferrous materials

39C SILICON CARBIDE

- Type O1 straight wheel with sharp, green silicon carbide; use for performance applications on carbide tooling and non-ferrous materials
- Vitrified bond for superb shape holding and resistance to wear
- Excellent choice for deburring and tool sharpening on bench and pedestal grinders



Good choice for all general-purpose bench and pedestal applications

GEMINI ALUMINUM OXIDE

- Type O1 straight wheel with quality, aluminum oxide for general purpose bench and pedestal grinder applications on steel
- Vitrified bond for superb shape holding and resistance to wear
- Good choice for deburring and tool sharpening on bench and pedestal grinders; telescoping bushings to fit popular arbor hole sizes



Good choice for all general-purpose bench and pedestal applications on non-ferrous materials and carbide tooling

GEMINI SILICON CARBIDE

- Type O1 straight wheel with sharp, green silicon carbide for general-purpose applications on carbide tooling and non-ferrous materials
- Vitrified bond for superb shape holding and resistance to wear
- Available in many sizes and coarse to fine grits; for sharpening to fine shaping applications



TIER:	BEST	BETTER	BETTER
TRADENAME:	PREMIUM CERAMIC ALUMINA	PREMIUM ALUMINUM OXIDE	57A
ABRASIVE:	3SG Ceramic Alumina	White Aluminum Oxide	Brown Aluminum Oxide

SIZE (D x T x H)	MAX. RPM	MIN./STD. PKG.	SPEC	PART #	SPEC	PART #	SPEC	PART #
6 x 3/4 x 1	4,140*	1/5	3SG-46K	076607 05411	Medium 60	076607 88246		
	4,140*	1/5	3SG-60I	076607 04684	Fine 100	076607 88247		
	4,140*	1/5	3SG-80K	076607 05412	Very Fine 150	076607 88248		
	4,140*	1/5	3SG-100I	076607 04682				
6 x 1 x 1	4,140*	1/5	3SG-46K	076607 05413	Medium 60	076607 88261		
	4,140*	1/5	3SG-80K	076607 05414	Fine 100	076607 88262		
	4,140	1/5			Very Fine 150	076607 88263		
8 x 1 x 1	3,600	1/5	3SG-46I	076607 04660	Medium 60	076607 88281		
	3,600	1/5	3SG-46K	076607 05421	Fine 100	076607 88282		
	3,600	1/5	3SG-60I	076607 04659	Very Fine 150	076607 88283		
	3,600	1/5	3SG-80K	076607 05422				
	3,600	1/5	3SG-100I	076607 04657				
10 x 1 x 1-1/4	2,485	1/5					57A46-MVBE	662531 16274
	2,485	1/5					57A60-MVBE	662531 16273
10 x 1-1/2 x 1-1/4	2,485	1/5					57A46-MVBE	662531 16280
12 x 1 x 1-1/4	2,070	1/5					57A46-MVBE	662532 20947
12 x 2 x 1-1/2	2,070	1/4					57A30-MVBE	662532 20951
	2,070	1/4					57A36-OVBE	662532 20952
	2,070	1/4					57A46-MVBE	662532 20953
	2,070	1/4					57A60-MVBE	662532 20955
	2,070	1/4					57A24-QVBE	662533 19972
14 x 2 x 1-1/2	1,800	1/3					57A36-OVBE	662533 19973
	1,800	1/3					57A46-MVBE	662533 19974
	1,800	1/3					57A24-QVBE	662533 19976
14 x 2-1/2 x 1-1/2	1,800	1/2					57A46-MVBE	662533 19975
	1,800	1/2					57A36-OVBE	662533 19977
18 x 3 x 1-1/2	1,275	1/2					57A24-QVBE	662534 62610

* Max. RPM for Premium Ceramic Alumina Wheels is 5,410

Bench and Pedestal Wheel Arbor Bushings

WHEEL DIAMETER	WHEEL CENTER HOLE	1/2"	5/8"	3/4"	7/8"	1"	1-1/4"
5", 6", 7"	1"	•	•	•	•		
8"	1"		•	•	•		
10"	1-1/4"			•	•	•	
12" x 2"	1-1/4"					•	
12" and 14"	1-1/2"					•	•

These size bushings shipped free of charge with your wheel order.



TIER: GOOD
TRADENAME: GEMINI ALUMINUM OXIDE
ABRASIVE: Brown Aluminum Oxide



TIER: GOOD
TRADENAME: 39C (GREEN) / 37C (GRAY)
ABRASIVE: Silicon Carbide



TIER: GOOD
TRADENAME: GEMINI SILICON CARBIDE
ABRASIVE: Green Silicon Carbide

SIZE (D x T x H)	MAX. RPM	MIN./STD. PKG.	SPEC	PART #	MIN./STD. PKG.	SPEC	PART #	MIN./STD. PKG.	SPEC	PART #
5 x 1/2 x 1	4,965	1/5	Medium 60/80	076607 88202						
	4,965	1/5	Fine 100/120	076607 88201						
5 x 3/4 x 1	4,965	1/5	Medium 60/80	076607 88210						
	4,965	1/5	Fine 100/120	076607 88205						
5 x 1 x 1	4,965	1/5	Medium 60/80	076607 88225						
	4,140	1/5	Coarse 36/46	662528 36132			1/5	Medium 60	662528 36571	
	4,140	1/5	Medium 60/80	662528 36131			1/5	Fine 80	662528 36572	
6 x 1/2 x 1	4,140	1/5	Fine 100/120	662528 36133			1/5	Extra Fine 120	662528 36573	
	4,140	1/5	Coarse 36/46	076607 88245			1/5	Medium 60	662528 37190	
	4,140	1/5	Medium 60/80	076607 88240			1/5	Fine 80	662528 37191	
6 x 3/4 x 1	4,140	1/5	Fine 100/120	076607 88235			1/5	Extra Fine 120	662528 37192	
	4,140	1/5	Coarse 36/46	076607 88260			1/5	Medium 60	662528 37187	
	4,140	1/5	Medium 60/80	076607 88255			1/5	Fine 80	662528 37193	
6 x 1 x 1	4,140	1/5	Fine 100/120	076607 88250			1/5	Extra Fine 120	662528 37194	
	3,600	1/5	Coarse 36/46	076607 88275			1/5	Medium 60	662529 42300	
	3,600	1/5	Medium 60/80	076607 88270			1/5	Fine 80	662529 42301	
8 x 3/4 x 1	3,600	1/5	Fine 100/120	076607 88265			1/5	Extra Fine 120	662529 42302	
	3,600	1/5	Coarse 36/46	076607 88278						
	3,600	1/5	Medium 60/80	076607 88277						
8 x 1 x 1	3,600	1/5	Fine 100/120	662530 42317						
	3,600	1/5	Very Coarse 24	662530 44454			1/5	Medium 60	662530 44087	
	3,600	1/5	Coarse 36/46	076607 88286			1/5	Fine 80	662530 44534	
10 x 1 x 1-1/4	3,600	1/5	Medium 60/80	076607 88285			1/5	Extra Fine 120	662530 44535	
	3,600	1/5	Fine 100/120	076607 88280						
	2,485	1/2	Very Coarse 24	662531 60788	1/5	39C60-IVK	662531 16262	1/2	Medium 60	662531 44536
10 x 1-1/4 x 1-1/4	2,485	1/2	Coarse 36/46	076607 88295				1/2	Fine 80	662531 60366
	2,485	1/2	Medium 60/80	076607 88290						
	2,485	1/2	Fine 100/120	662531 60350						
10 x 1-1/2 x 1-1/4	2,485	1/2	Coarse 36/46	662531 61250						
	2,485	1/2	Medium 60/80	662531 61251						
	2,485	1/2	Coarse 36/46	662531 61393	1/5	39C60-IVK	662531 16265			
12 x 1-1/2 x 1-1/2	2,485	1/2	Medium 60/80	662531 61395						
	2,070	1/2	Coarse 36/46	662532 63052						
	2,070	1/2	Medium 60/80	662532 63053						
12 x 2 x 1-1/4	2,070							1/2	Medium 60	662532 63359
	2,070							1/2	Fine 80	662532 63360
12 x 2 x 1-1/2	2,070	1/2	Very Coarse 24	662532 63054						
	2,070	1/2	Coarse 36/46	662532 63055						
	2,070	1/2	Medium 60/80	662532 63056	1/4	39C60-KVK	662532 20942			
14 x 2 x 1-1/2	1,800				1/3	37C24-RVK	662533 19967			
	1,800				1/3	39C60-JVK	662533 19968			

Bench and Pedestal Wheel Arbor Bushings

WHEEL DIAMETER	WHEEL CENTER HOLE	1/2"	5/8"	3/4"	7/8"	1"	1-1/4"
5", 6", 7"	1"	•	•	•	•		
8"	1"		•	•	•		
10"	1-1/4"			•	•	•	
12" x 2"	1-1/4"					•	
12" and 14"	1-1/2"					•	•

These size bushings shipped free of charge with your wheel order.



Resin bond, vitrified bond, center lap, and cotton fiber mounted points are available in a wide range of shapes.

- Industries:**
- Aerospace
 - Tool and Die
 - Construction
 - Metal Fabrication
 - Automotive
 - Cutlery
 - Mold Shops
 - Stainless Steel Equipment
 - Foundries

Abrasive Grain: Ceramic Alumina, Zirconia Alumina, Zirconia Alumina / Aluminum Oxide Blend, Aluminum Oxide

Shape Availability: A, B, and W

Machine Used:



DIE AND
PENCIL
GRINDER



HORIZONTAL/
STRAIGHT SHAFT
PORTABLE GRINDER

Measurement Guide

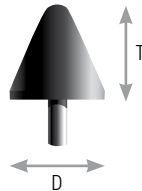
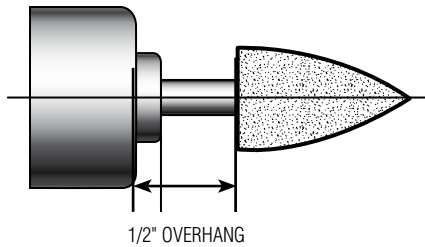

Description of Overhang

Overhang is the distance between the grinder chuck and the abrasive on the spindle. The larger the overhang, the lower the maximum safe operating speed.

Size

Measured by diameter (D) x thickness (T)

Cotton Fiber



Good for blending and polishing

COTTON FIBER ALUMINUM OXIDE - RESIN BOND

- Aluminum oxide grain provides an excellent blend of cut rate and life
- The cotton fibers ensure smooth, chatter-free grinding
- Designed for blending and polishing in one step; use 80 grit for most materials and 120 for polishing and stainless steel applications

TIER: **GOOD**
TRADENAME: **COTTON FIBER**
ABRASIVE: Aluminum Oxide

SHAPE	SIZE (D x T)	SPINDLE DIA. †	MAX. RPM*	MIN./STD. PKG.	SPEC	PART #
Cotton Fiber Mounted Points						
A11	7/8 x 2	1/4	19,860	5/25	A80-HBF3	614636 22664
B52	3/8 x 3/4	1/8	45,370	5/25	A120-HBF3	614636 20242
B121	1/2" Ball	1/8	45,370	5/25	A80-HBF3	614636 22657
W163	1/4 x 1/2	1/8	60,000	5/25	A80-HBF3	614636 22655
			60,000	5/25	A120-HBF3	614636 22656
W176	3/8 x 1/2	1/8	45,370	5/25	A80-HBF3	614636 22654
W185	1/2 x 1/2	1/8	34,500	5/25	A80-HBF3	614636 22649
W187	1/2 x 1	1/8	20,620	5/25	A80-HBF3	614636 22651
W220	1 x 1	1/4	25,500	5/25	A80-HBF3	614636 22646

† Spindle length is 1-1/2"

* Maximum RPM valid to 1/2" overhang. See package insert for other overhangs.

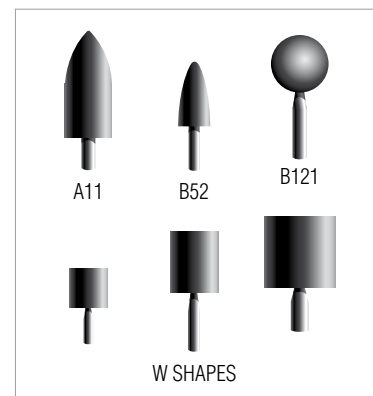

Center Lap



Better for Excell-O center lap and similar machines

CENTER LAP ALUMINUM OXIDE - VITRIFIED BOND

- Specially formulated wheel treatment provides added lubricity to the wheel, minimizing risk of metallurgical damage
- The larger diameter spindle ensures minimal deflection and rigid support
- Precise dimensional tolerances ensure accurate location of part centers

TIER: **BETTER**
 TRADENAME: **CENTER LAP**
 ABRASIVE: Aluminum Oxide

SHAPE	SIZE (D x T)	SPINDLE DIA.†	MAX. RPM*	MIN./STD. PKG.	SPEC	PART #
Center Lap Mounted Points						
-	1/2 x 2**	1/2	65,000	5/25	A80-VVM	614636 21421
-	1 x 2**	1/2	15,900	5/25	A80-VVM	614636 22926

† Spindle length is 1-1/4"

* Maximum RPM valid to 1/2" overhang. See package insert for other overhangs.

** Pointed 60°

TECH TIP

Dress the center lap mounted points frequently to ensure accurate and smooth center holes.



It is the user's responsibility to refer to and comply with ANSI B7.1

Resin Bond



Best choice for fast stock removal

NORZON ZIRCONIA ALUMINA – RESIN BOND

- Zirconia alumina abrasive blend for 2X faster cut rate than standard aluminum oxide
- Strong grain and specially formulated organic bond provide 4X greater life than aluminum oxide points, while reducing vibration and wheel chatter
- Ideal for removing parting lines, fins and small risers from castings, and smoothing and blending of welded areas



Better choice for fast stock removal and long life

CHARGER Z/A & A/O BLEND – RESIN BOND

- Durable zirconia alumina and aluminum oxide abrasive blend delivers 35% faster cut rate than standard aluminum oxide; an aggressive, free cut, and more parts cleaned in less time to substantially increase productivity
- Specially formulated organic bond provides 2X greater life than standard resin bonds while reducing vibration and wheel chatter
- Better choice for removing parting lines, fins and small risers from castings, and smoothing and blending welded areas
- Charger mounted point pre-packed in small packages are ideal for vending machines, pegboards, small jobs, and carrying to job site

TIER: **BEST** | **BETTER**
 TRADENAME: **NORZON** | **CHARGER**
 ABRASIVE: Zirconia Alumina | Zirconia Alumina/Aluminum Oxide

SHAPE	SIZE (D x T)	SPINDLE DIA.†	MAX. RPM*	MIN./STD. PKG.	SPEC	PART #	SPEC	PART #
Resin Bond Mounted Points								
A1	3/4 x 2-1/2	1/4	19,800	5/25	NZ24-UBXR1	614636 16457	Charger	614636 16458
A3	1 x 2-3/4	1/4	16,100	5/25	NZ24-UBXR1	614636 16459	Charger	614636 16460
A5	3/4 x 1-1/8	1/4	45,000	5/25			Charger	614636 16462
A11	7/8 x 2	1/4	19,860	5/25	NZ24-UBXR1	614636 16463	Charger	614636 16464
W189	1/2 x 2	1/4	24,000	5/25	NZ24-UBXR1	614636 16465	Charger	614636 16466
W197	5/8 x 2	1/4	21,000	5/25	NZ24-UBXR1	614636 16467		
W207	3/4 x 1-1/2	1/4	24,000	5/25			Charger	614636 16470
W208	3/4 x 2	1/4	18,750	5/25	NZ24-UBXR1	614636 16471	Charger	614636 16472
W220	1 x 1	1/4	25,500	5/25	NZ24-UBXR1	614636 17520	Charger	614636 17521
			25,500	5 V			Charger	662533 25930
W221	1 x 1-1/2	1/4	19,120	5/25	NZ24-UBXR1	614636 16473	Charger	614636 16474
W222	1 x 2	1/4	15,900	5/25	NZ24-UBXR1	614636 16475	Charger	614636 16476

† Spindle length is 1-1/2"

* Maximum RPM valid to 1/2" overhang. See package insert for other overhangs.

V = Vendible package. Ideal for vending machines and small jobs. Min. Pkg. Qty = number of mounted points per vendible pack. Order in multiples of min qty.

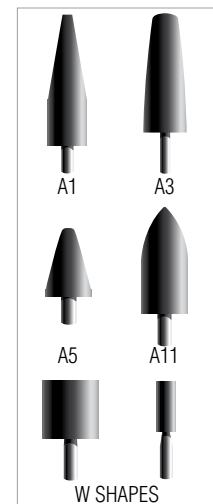

Vitrified Bond



Best choice for high volume operations

QUANTUM CERAMIC ALUMINA – VITRIFIED BOND

- Quantum grain with unique, engineered ceramic grain and shape, specifically developed for high-volume, high-speed alloy grinding operations
- Minimal loading and heat build-up; provide up to 33% longer life and 37% better metal removal rates versus other ceramic points
- Versatile; optimized for all low-, medium-, and high-force vitrified applications
- Oil and Gas 36 grit mounted points; specifically engineered to efficiently grind the carbide matrix material of oil field drill heads



NEW

Better medium grit option for blending and deburring

PINK ALUMINUM OXIDE – VITRIFIED BOND

- Sharp versatile 86A aluminum oxide grain is free cutting and resists burn
- Excellent form holding compared to more friable white aluminum oxides
- Medium grit for blending and deburring



Good value for general purpose, small job shop applications

GEMINI ALUMINUM OXIDE – VITRIFIED BOND

- 38A abrasive is designed to be cool cutting to minimize burn
- High temperature vitrified bond maximizes form holding and life
- Wide grit range for stock removal, blending/deburring, and finishing/polishing

TECH TIP

- For best mounted point performance, always run the mounted point at the maximum allowable speed according to ANSI B7.1. Refer to the speed chart included in each shipment for proper operating speeds.
- Use "A" shapes for medium- to heavy-duty blending.
- Use "B" shapes for light deburring and finishing/polishing.
- Use "W" shapes for offhand and precision grinding of medium to heavy stock.
- Use 36 grit and coarser for rough grinding.
- Use 60 and 90 grits for imparting fine finishes or when grinding on narrow surfaces.



It is the user's responsibility to refer to and comply with ANSI B7.1



Vitrified Bond

TIER:	BEST	BETTER	NEW	GOOD
TRADENAME:	QUANTUM	PINK		GEMINI
ABRASIVE:	Ceramic Alumina	86A Aluminum Oxide		38A Aluminum Oxide

SHAPE	SIZE (D x T)	SPINDLE DIA. †	MAX. RPM*	MIN./STD. PKG.	SPEC	PART #	SPEC	PART #	SPEC	PART #
Vitrified Bond Mounted Points – A Shapes										
A1	3/4 x 2-1/2	1/4	19,800	25/250	Oil & Gas 36	614636 86139				
A1	3/4 x 2-1/2	1/4	19,800	5/25	3NQ80	690831 49139	86A80-S	690786 45335	38A36-T	614636 24374
A1	3/4 x 2-1/2	1/4	19,800	5/25					38A60-P	614636 24375
A3	1 x 2-3/4	1/4	16,100	25/250	Oil & Gas 36	614636 86138				
A3	1 x 2-3/4	1/4	16,100	5/25			86A80-S	690786 45333	38A36-T	614636 24377
A3	1 x 2-3/4	1/4	16,100	5/25					38A60-P	614636 24378
A4	1-1/4 x 1-1/4	1/4	30,560	5/25					38A60-P	614636 24380
A5	3/4 x 1-1/8	1/4	45,000	5/25			86A80-S	690786 45339	38A36-T	614636 24381
A5	3/4 x 1-1/8	1/4	45,000	5/25					38A60-P	614636 24382
A11	7/8 x 2	1/4	19,860	5/25	3NQ80	690831 49141			38A36-T	614636 24384
A11	7/8 x 2	1/4	19,860	5/25			86A80-S	690786 45336	38A60-P	614636 24385
A12	11/16 x 1-1/4	1/4	48,000	5/25			86A80-S	690786 45344	38A60-P	614636 24388
A13	1-1/8 x 1-1/8	1/4	33,950	5/25					38A60-P	614636 24389
A15	1/4 x 1-1/16	1/4	72,750	5/25					38A60-P	614636 24391
A21	1 x 1	1/4	34,500	5/25					38A60-P	614636 24392
A23	3/4 x 1	1/4	39,370	5/25					38A60-P	614636 24394
A24	1/4 x 3/4	1/4	76,500	5/25					38A60-P	614636 24395
A25	1" Ball	1/4	35,620	5/25			86A80-S	690786 45341	38A60-P	614636 24396
A26	5/8" Ball	1/4	61,120	5/25					38A60-P	614636 24397
A31	1-3/8 x 1	1/4	27,780	5/25					38A60-P	614636 24399
A34	1-1/2 x 3/8	1/4	25,470	5/25					38A60-P	614636 24402
A36	1-5/8 x 3/8	1/4	23,520	25/250	Oil & Gas 36	662531 45562				
A36	1-5/8 x 3/8	1/4	23,520	5/25					38A60-P	614636 24404
A37	1-1/4 x 1/4	1/4	30,560	5/25					38A60-P	614636 24405
A38	1 x 1	1/4	34,500	5/25			86A80-S	690786 45345	38A60-P	614636 24406
A39	3/4 x 3/4	1/4	47,250	5/25					38A60-P	614636 24407
A40	3/4" Ball	1/4	47,250	5/25					38A60-P	614636 24408

† Standard spindle size is 1/4" x 1-1/2"

* Maximum RPM valid to 1/2" overhang. See package insert for other overhangs.

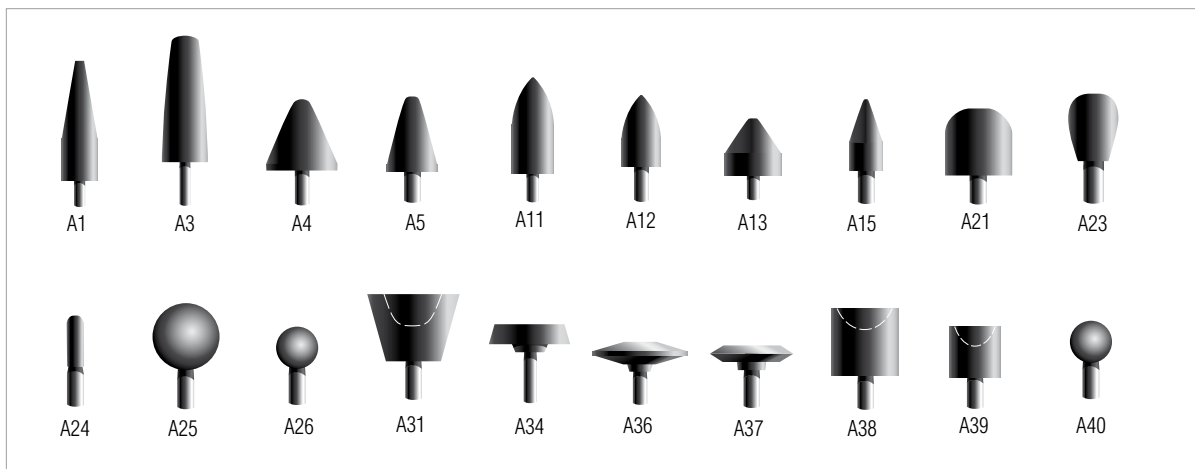

Vitrified Bond

TIER:	BEST	BETTER	NEW	GOOD
TRADENAME:	QUANTUM	PINK		GEMINI
ABRASIVE:	Ceramic Alumina	86A Aluminum Oxide		38A Aluminum Oxide

SHAPE	SIZE (D x T)	SPINDLE DIA. †	MAX. RPM*	MIN./STD. PKG.	SPEC	PART #	SPEC	PART #	SPEC	PART #
Vitrified Bond Mounted Points – B Shapes										
B41	5/8 x 5/8	1/8	33,570	5/25					38A60-P	614636 24410
B42	1/2 X 3/4	1/8	33,570	5/25					38A60-P	614636 24412
B44	7/32 x 3/8	1/8	68,400	5/25					38A60-P	614636 24414
B45	3/16 x 5/16	1/8	104,250	5/25					38A60-P	614636 24415
B46	1/8 x 5/16	1/8	105,000	5/25					38A60-P	614636 24416
B51	7/16 x 3/4	1/8	45,370	5/25					38A60-P	614636 24418
B52	3/8 x 3/4	1/8	45,370	5/25			86A80-S	690786 45334	38A60-P	614636 24420
B52	3/8 x 3/4	1/4	81,000	5/25					38A60-P	614636 24419
B52	3/8 x 3/4	1/8	45,370	5/25					38A90-Q	614636 24422
B53	5/16 x 5/8	1/8	60,000	5/25			86A80-S	690786 45340	38A60-P	614636 24423
B55	1/8 x 1/4	1/8	105,000	5/25					38A60-P	614636 24425
B81	3/4 x 3/16	1/8	50,930	5/25			86A80-S	690786 45347	38A60-P	614636 24437
B91	1/2 x 5/8	1/8	34,500	5/25					38A60-P	614636 24443
B96	1/8 x 1/4	1/8	105,000	5/25					38A90-Q	614636 24449
B97	1/8 x 3/8	1/8	105,000	5/25	3NQ80	690831 49048	86A80-S	690786 45337	38A60-P	614636 24451
B121	1/2" Ball	1/8	45,370	5/25			86A80-S	690786 45338	38A60-P	614636 24466
B122	3/8" Ball	1/8	61,650	5/25	3NQ80	690831 49050	86A80-S	690786 45360	38A60-P	614636 24470
B123	3/16" Ball	1/8	104,250	5/25					38A60-P	614636 24472
B124	1/8" Ball	1/8	105,000	5/25					38A90-Q	614636 24474
B131	1/2 x 1/2	1/8	34,500	5/25					38A60-P	614636 24475
B132	3/8 x 1/2	1/8	45,370	5/25					38A60-P	614636 24479
B135	1/4 x 1/2	1/8	60,000	5/25			86A80-S	690786 45342	38A60-P	614636 24484

† Spindle size is 1/8" or 1/4" x 1-1/2"

* Maximum RPM valid to 1/2" overhang. See package insert for other overhangs.

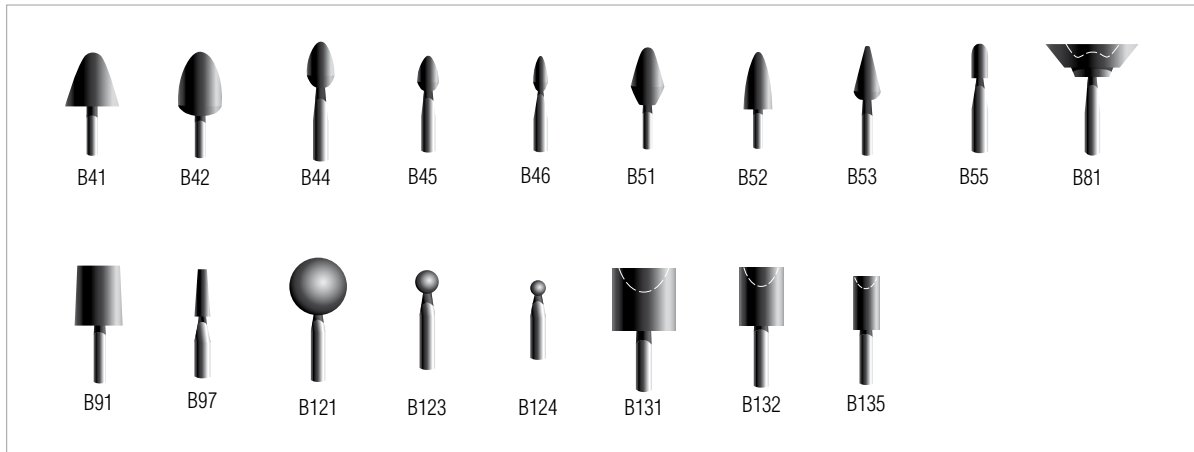

Vitrified Bond

TIER:	BEST	GOOD	NEW	GOOD
TRADENAME:	QUANTUM	PINK		GEMINI
ABRASIVE:	Ceramic Alumina	86A Aluminum Oxide		38A Aluminum Oxide

SHAPE	SIZE (D x T)	SPINDLE DIA. †	MAX. RPM*	MIN./STD. PKG.	SPEC	PART #	SPEC	PART #	SPEC	PART #
Vitrified Bond Mounted Points – W Shapes										
W144	1/8 x 1/4	1/8	105,000	5/25					38A60-P	614636 24488
W145	1/8 x 3/8	1/8	105,000	5/25					38A60-P	614636 24489
W146	1/8 x 1/2	1/8	105,000	5/25					38A60-P	614636 24491
W152	3/16 x 1/4	1/8	105,000	5/25					38A60-P	614636 24495
W153	3/16 x 3/8	1/8	80,850	5/25					38A60-P	614636 24496
W154	3/16 x 1/2	1/8	70,500	5/25	3NQ80	690831 49133			38A60-P	614636 24497
W162	1/4 x 3/8	1/8	64,800	5/25					38A60-P	614636 24503
W163	1/4 x 1/2	1/8	60,000	5/25			86A80-S	690786 45346	38A60-P	614636 24504
W164	1/4 x 3/4	1/8	45,900	5/25					38A60-P	614636 24505
W170	5/16 x 1/2	1/8	52,500	5/25					38A60-P	614636 24511
W175	3/8 x 3/8	1/8	54,000	5/25					38A60-P	614636 24516
W176	3/8 x 1/2	1/8	45,370	5/25					38A60-P	614636 24517
W177	3/8 x 3/4	1/8	33,750	5/25			86A80-S	690786 45355	38A60-P	614636 24518
W179	3/8 x 1-1/4	1/4	20,415	25/250	Oil & Gas 36	690831 54055				
W185	1/2 x 1/2	1/8	34,500	5/25	3NQ80	690831 49137			38A60-P	614636 24525
W185	1/2 x 1/2	1/4	61,500	5/25			86A80-S	690786 45354	38A60-P	614636 24526
W186	1/2 X 3/4	1/4	51,000	5/25					38A60-P	614636 24528
W188	1/2 x 1-1/2	1/4	30,370	5/25					38A60-P	614636 24530
W189	1/2 x 2	1/4	24,000	25/250	Oil & Gas 36	614636 86137				
W189	1/2 x 2	1/4	24,000	5/25					38A60-P	614636 24531
W196	5/8 x 1	1/4	35,250	5/25					38A60-P	614636 24539
W200	3/4 x 1/8	1/8	50,930	5/25			86A80-S	690786 45356	38A60-P	614636 24543
W200	3/4 x 1/8	1/8	50,930	5/25					38A90-Q	614636 24544
W204	3/4 x 3/4	1/4	42,750	5/25					38A60-P	614636 24549
W205	3/4 x 1	1/4	34,500	5/25					38A60-P	614636 24550
W208	3/4 x 2	1/4	18,750	5/25					38A60-P	614636 24553
W215	1 x 1/8	1/8	38,200	5/25					38A60-P	614636 24560
W216	1 x 1/4	1/4	38,200	5/25					38A60-P	614636 24562
W218	1 x 1/2	1/4	38,200	25/250	Oil & Gas 36	690831 54061				
W218	1 x 1/2	1/4	38,200	5/25					38A60-P	614636 24564
W220	1 x 1	1/4	25,500	5/25			86A80-S	690786 45359	38A60-P	614636 24566
W222	1 x 2	1/4	15,900	5/25					38A60-P	614636 24569
W230	1-1/4 x 1-1/4	1/4	20,400	5/25					38A60-P	614636 24578
W235	1-1/2 x 1/4	1/4	25,470	5/25			86A80-S	690786 45343	38A60-P	614636 24583
W236	1-1/2 x 1/2	1/4	25,470	5/25					38A60-P	614636 24585
W237	1-1/2 x 1	1/4	22,500	5/25					38A60-P	614636 24587
W238	1-1/2 x 1-1/2	1/4	15,600	5/25					38A60-P	614636 24588
W242	2 x 1	1/4	19,100	5/25					38A60-P	614636 24592

† Spindle size is 1/8" or 1/4" x 1-1/2"

* Maximum RPM valid to 1/2" overhang. See package insert for other overhangs.

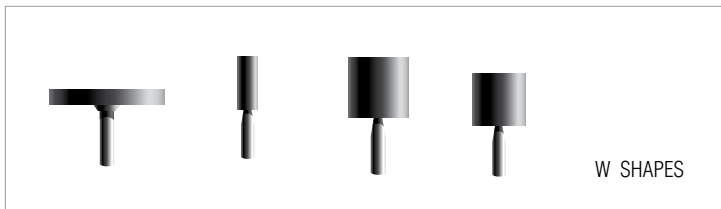



Since 1823, Norton stones have lead the marketplace with benchstones, waterstones, sharpening systems, files, slips and specialty stones for industrial, commercial and DIY sharpening applications. Our comprehensive line of sharpening and finishing products is the industry's broadest line with premier performance and quality.

For additional sharpening products not shown in this catalog, contact your Norton sales representative.

- Applications:** Deburring, dimensioning, sharpening, honing
- Grit Range:** Coarse, Medium, Fine, Extra Fine, Ultra Fine
- Abrasive Types:** Aluminum Oxide (India), Silicon Carbide (Crystolon), Arkansas (Soft and Hard Translucent),
- Machine Used:**



HAND SHARPENING

Better choice for economical solution for general sharpening and finishing with one stone



COMBINATION GRIT ABRASIVE BENCHSTONES

- **Crystolon Combination**
Coarse and fine grit sharp-cutting silicon carbide abrasive surfaces for general sharpening (to moderate tolerances) when the speed of sharpening is more important than the fineness of the cutting edges. Gray in color.
- **India Combination**
Coarse and fine grit aluminum oxide abrasive surfaces produce strong, keen, long-lasting edges on quality tools. Orange/brown in color.
- **Crystolon/India Combination**
Fast-sharpening, medium grit silicon carbide (Crystolon) and fine aluminum oxide (India) abrasive surfaces for keen, long-lasting edges on quality tools. Crystolon side is dark gray in color, India side is orange.
- **Giant Combination Stones**
11-1/2" and 12" bench oil stones are used to sharpen large edge tools with long sweeping strokes.

Application-to-Product Recommendation Guide

	FAST CUT STOCK REMOVAL	INITIAL SHARPENING	FINAL SHARPENING	HONING	SHARPEST EDGE
Grit Size	Coarse	Medium	Fine	Extra Fine	Ultra Fine
Abrasive	Crystolon	Crystolon	India	Soft Arkansas	Hard Arkansas
Product/Color	Grey	Grey	Orange	Milky White	Translucent

TIER: **BETTER**

SIZE (L x W x H)	QTY./CASE	SPEC.	PRODUCT #	PART #
Combination Grit Benchstones – Crystolon (Silicon Carbide)				
4 x 1 Round	5	Coarse/Fine	JB64	614636 85435
4 x 1-3/4 x 5/8	5	Coarse/Fine	JB134	614636 85440
5 x 2 x 3/4	5	Coarse/Fine	JB45	614636 85445
6 x 2 x 1	5	Coarse/Fine with Anniversary Box	JB6	614636 85450
8 x 2 x 1	5	Coarse/Fine with Anniversary Box	JB8	614636 85455
11-1/2 x 2-1/2 x 1	2	Coarse/Fine	JUM3	614636 85840
12 x 2-1/2 x 1-1/2	2	Coarse/Fine	JUM4	614636 85855
Combination Grit Benchstones – India (Aluminum Oxide)				
4 x 1 Round	5	Coarse/Fine	IB64	614636 85545
4 x 1-3/4 x 5/8	5	Coarse/Fine	IB134	614636 85550
5 x 2 x 3/4	5	Coarse/Fine	IB45	614636 85555
6 x 2 x 1	5	Coarse/Fine with Anniversary Box	IB6	614636 85560
8 x 2 x 1	5	Coarse/Fine with Anniversary Box	IB8	614636 85565
11-1/2 x 2-1/2 x 1	2	Coarse/Fine	IM2	614636 85851
Combination Grit Benchstones – Crystolon/India				
6 x 2 x 1	5	Medium/Fine	IC6	614636 85643
11-1/2 x 2 x 1	2	Medium/Fine	IC11	614636 87239



These benchstones are packed in individual boxes within a case. Order in multiples of stones/case.

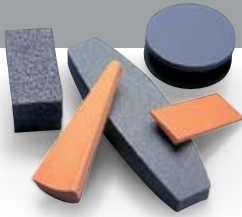

Better choice for specific sharpening or deburring applications

SPECIALTY STONES

- Norton continues to offer specialty stones with optimum specifications and unique shapes that conform to, and quickly sharpen, specific tools

Large Specialty Stones

Tradesmen's Utility Stones

Used for sharpening trimming knives and as an abrasive file in many different industries. The JT910 does not have a handle, while the JT920 and JT930 have wooden handles.

Sickle and Scythe Stones

These silicon carbide stones quickly produce a fast-cutting edge on sickles, scythes, and brush hooks. These stones are most frequently chosen where the speed of sharpening is the primary consideration.

Utility File

A long wedge-shaped stone with four flat sides designed for sharpening coarse cutting edges on cutting implements and edged garden tools. Wooden handles make them easy to use. They will outlast and out-sharpen metal files.

TIER: BETTER				
SIZE	QTY./CASE	SPEC.	PRODUCT #	PART #
Tradesmen's Utility Stones – Crystolon (Silicon Carbide)				
10 x 1-1/4 x 3/4	10	Medium	JT910	614636 87665
14-3/4 Overall (with Handle)	10	Coarse/Fine	JT930	614636 87675
	10	Medium	JT920	614636 87670
Sycle and Scythe Stones				
10 x 1-1/4 x 3/4 Crystolon (Silicon Carbide)	10	Coarse	TJ3	614636 87731
10 x 1-5/16 x 3/4 India (Aluminum Oxide)	10	Coarse	TD1	614636 87715
Utility File – Crystolon (Silicon Carbide)				
14 Overall (w/ Handle)	10	Coarse	JD2	614636 87750

All Large Specialty Stones are bulk packed.

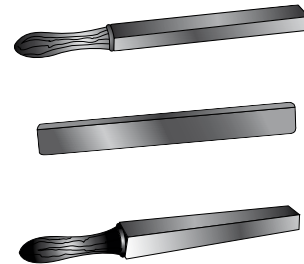

Specialty Stones for Machine Tools

Machine Knife Stone

Crystolon (silicon carbide) machine knife stones offer both coarse and fine sides for sharpening and honing paper and cloth-cutting knives and planer knives on the machine. The groove around the middle of the stone protects fingers and provides a secure hold.

TIER: BETTER				
SIZE	QTY./CASE	SPEC.	PRODUCT #	PART #
Machine Knife Stone – Crystolon (Silicon Carbide)				
4" Diam. x 1-1/2" Thick	5	Coarse/Fine	JB74	614636 87570

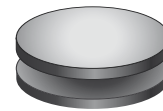

Better choice for improving sharpening stone performance



SHARPENING STONE OIL

- Highly refined lubricating oil which is specifically formulated for sharpening stone use
- Will not load or "gum-up" sharpening stones, meets U.S. Pharmacopoeia standards for mineral oil purity; may be used around food preparation operations
- Equally ideal for all lubricating jobs

TIER: BETTER				
SIZE	QTY./CASE	SPEC.	PRODUCT #	PART #
Sharpening Stone Oil				
4-1/2 oz.	20	Oil	XB1	614636 87760
1 Pint	20	Oil	XB5	614636 87770
1 Quart	5	Oil	XB2	614636 87775
1 Gallon	4	Oil	XB6	662534 57631

TECH TIP

- All oil stones are porous in nature; oil is required to keep the pores open and working efficiently
- Use Norton oil to optimize the performance of Crystolon, India and Arkansas stones
- While sharpening knives, blades and tools, be careful to keep fingers away from sharp edges

Retail Packaged Sharpening Products

Our retail-packaged line brings Norton quality to your distributor showroom, vending machine, tool crib, and your tool box. Each stone is specifically designed for a popular sharpening application and packaged to sell or carry to the job site.

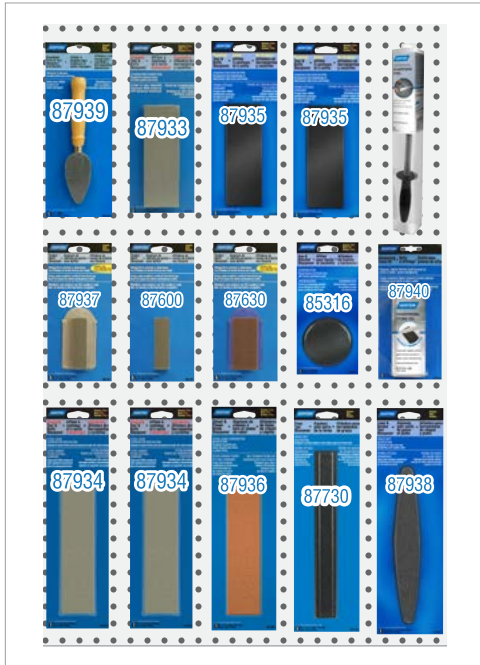

SIZE (L x W x H)	SPEC.	TIER: BETTER	
		QTY./CASE	PART #
Axe and Hatchet Sharpener			
3 x 5/8 round	Coarse/Fine Crystolon (Silicon Carbide)	10	076607 85316
Pocket Knife Sharpener			
3 x 7/8 x 3/8	Fine Crystolon (Silicon Carbide)	5	076607 87600
3 x 7/8 x 3/8 with case	Medium India (Aluminum Oxide)	5	076607 87937
3 x 1-1/2 x 1/2 with case	Coarse/Fine India (Aluminum Oxide)	5	076607 87630
Economy Tool & Knife Benchstone			
6 x 2 x 3/4	Coarse/Fine Crystolon (Silicon Carbide)	5	076607 87933
8 x 2 x 3/4	Coarse/Fine India (Aluminum Oxide)	10	076607 87934
8 x 2 x 1	Coarse/Fine India (Aluminum Oxide)	10	614636 85755
High Quality Tool & Knife Benchstone			
6 x 2 x 3/4	Coarse/Fine Crystolon (Silicon Carbide)	5	076607 87935
Chisel & Planer Blade Sharpener			
8 x 2 x 3/4	Coarse/Fine India (Aluminum Oxide)	10	076607 87936
Household Knife & Tool Sharpener			
7-1/2	Fine Crystolon (Silicon Carbide)	5	076607 87939
Farm Tool Sharpener			
10 x 1-1/4 x 3/4	Coarse Crystolon (Silicon Carbide)	10	076607 87730
Lawn & Garden Tool Sharpener			
9-1/2 x 1-3/8 x 1/2	Medium Crystolon (Silicon Carbide)	10	076607 87938
Sharpening Stone Oil			
4-1/2 oz.	Oil	5	076607 87940
Sharpening Steel			
1/2 x 10	Round file with rubber handle	8	662532 40433
Vitrified Dressing Stick			
1 x 1 x 6	Medium Silicon Carbide	5	076607 10466

Knife and Scissor Sharpener

The knife and scissor mechanical sharpener is a quick and portable tool for hundreds of sharpening applications.

SPECIFICATION	QTY./CASE	PART #
Knife and Scissor Sharpener		
Carbide	6	076607 87520

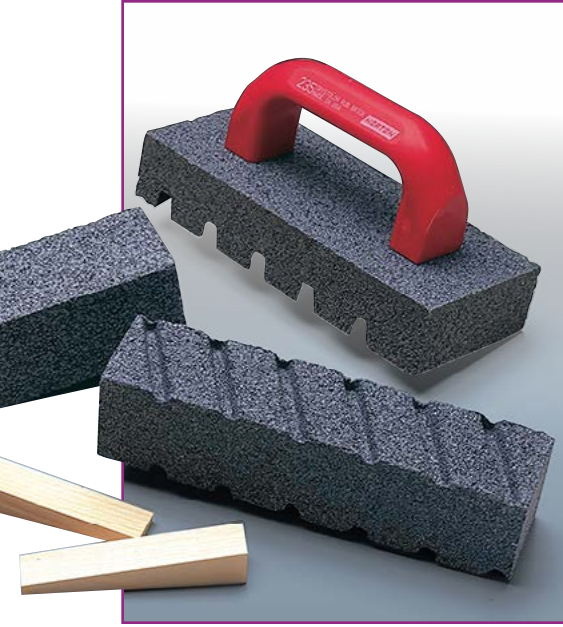

Hard silicon carbide rubbing bricks are used for heavy-duty applications such as rubbing floors, cleaning and scouring castings, rubbing down concrete, and removing mold marks.

Applications:

Floor Rubbing Bricks – are used to rub down concrete and remove mold marks. These are designed to fit the chucks of common concrete floor grinding equipment. Reusable wooden wedges anchor the bricks to the equipment chucks.

Plain Hand Rubbing Bricks – are the choice of mechanics and foundry workers for dressing grinding wheels and cleaning or scouring castings.

Fluted Hand Rubbing Bricks – are used by masons and stone workers for rubbing down concrete and removing mold marks. The diagonal flutes provide sharp edges, a clean shearing action, and carry away debris.

Fluted Hand Rubbing Bricks with Handle – make quick work of removing mold marks and rubbing down concrete. The firmly attached handle reduces fatigue and facilitates overhead, wall, and floor work.

Griddle Bricks – quickly clean away carbon build-up and other residue on your grill without leaving fibers, which grill brushes often do.

Grit Range:
Abrasive Type:
Machine Used:

6 – 120
Silicon Carbide



HAND SANDING



SIZE (L x W x H)	QTY./ CASE	SPEC.	ABRASIVE	PART #
Plain Floor Rubbing Bricks with Wooden Wedges				
4 x 2 x 2	6	C6-R	Silicon Carbide	614636 53292
	6	C10-R	Silicon Carbide	614636 53293
	6	C24-R	Silicon Carbide	614636 53294
	6	C80-R	Silicon Carbide	614636 53295

SIZE (L x W x H)	QTY./ CASE	PART #
Wooden Wedges		
	6	614636 85297

SIZE (L x W x H)	QTY./ CASE	SPEC.	ABRASIVE	PRODUCT #	PART #
Plain Hand Rubbing Bricks					
8 x 2 x 2	5	C24	Silicon Carbide	BP28	614636 87830

SIZE (L x W x H)	QTY./ CASE	SPEC.	ABRASIVE	PRODUCT #	PART #
Fluted Hand Rubbing Bricks					
6 x 2 x 2	5	C20	Silicon Carbide	BF26	614636 87840
8 x 2 x 2	5	C20	Silicon Carbide	BF28	614636 87845

SIZE (L x W x H)	QTY./ CASE	SPEC.	ABRASIVE	PRODUCT #	PART #
Fluted Hand Rubbing Bricks with Handle					
6 x 3 x 1	5	C20	Silicon Carbide	BFH6	614636 87800
8 x 3-1/2 x 1-1/2	5	C20	Silicon Carbide	235	614636 87795

SIZE (L x W x H)	QTY./ CASE	SPEC.	ABRASIVE	PART #
Griddle Brick				
4-1/2 x 3 x 2	5	Medium	Alundum	614636 87870

the Norton Clipper brand **HITS THE PAVEMENT**

The leader for diamond blades, tools, and light machines for construction and cutting materials is “Redefining Jobsite Muscle – Rugged. Reliable. Affordable.”





With faster cut rates, constant depth of cut, and less downtime, Norton Clipper diamond blades are the choice of professionals versus conventional abrasive blades. Norton Clipper diamond blades are available for high-speed saws, portable hand-held saws, and walk-behind saws. For the full offering of diamond blades, see the Norton Clipper Construction Products Catalog #7719.

- Applications:** Cutting concrete, stone, tile, and other building materials
- Size Range:** 4" – 18"
- Thickness Range:** .080" – .375"
- Segment Height Range:** .210" – .550"
- Abrasive Grain:** Diamond
- Mounting Options:** 1"/20mm universal arbor, 7/8"-5/8"-20mm, DM-7/8"-5/8", 5/8"-11
- Shape:** Type 01
- Machines Used:**



HIGH-SPEED GAS OR ELECTRIC SAW



CIRCULAR SAW



RIGHT-ANGLE GRINDER



WALK-BEHIND SAW

Diamond Blade Rim Types

There are three main diamond blade rim types: segmented, turbo, and continuous rim.

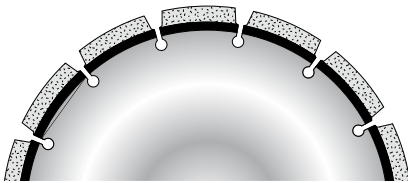

Segmented

- Most aggressive cutting action for general-purpose and masonry applications
- Use when cutting speed and productivity are more important than finish
- Best life, best cut rate, good finish

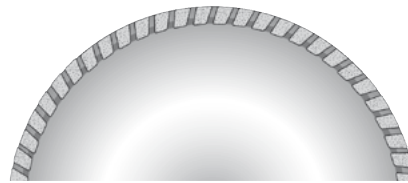

Turbo

- Aggressive cutting action with a smoother quality of cut than segmented rim blades
- For use on harder materials, such as granite, marble, and stone to reduce chipping
- Better life and cut rate, better finish

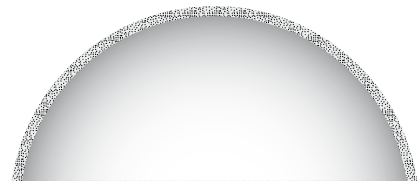

Continuous

- Provides the smoothest of cuts
- Best performance when used wet
- Use on porcelain, tile, marble, and other hard materials requiring a high-quality cut
- Good life, good cut rate, best finish

Material / Application-to-Product Recommendation Guide

Icon	Description	Application
	Multi-Purpose, All Materials	Concrete, reinforced concrete, granite, building materials, thin steel sections, angle iron up to 1/2" material thickness, rebar up to no. 5.
	Natural Stone and Tiles	Ceramic and stone tiles, granite, marble, very hard bricks and other very hard and dense materials.
	Reinforced Concrete and Harder Building Materials	Reinforced concrete, hard bricks, limestone, terrazzo, and other hard materials.
	General Purpose and Masonry Building Materials	Blocks, medium-hard building bricks, paving slabs, concrete roof tiles and other medium-hard materials.
	Asphalt	Asphalt, green concrete, asphalt over concrete, abrasive blocks, mortar and other abrasive materials.

Diamond Performance Tiers

- 5 **Best**
Best Performance
- 4 **Better**
High Performance
- 3 **Value and Good**
Consistent Performance
- 2
- 1

TECH TIP

- Never twist or turn a segmented blade in the cut because it may result in segment breakage
- Never use wet blades dry
- Remove dry blades from cut for 10 seconds of each minute of cut to air cool
- Never operate any saw, wet or dry, without the blade guard



It is the user's responsibility to refer to and comply with ANSI B7.1

For Reinforced Concrete and Harder Building Materials

DRY – Segmented Rim +

DUO EVO				
The unique shape of the DUO EVO segments optimizes the angle of attack while enhancing the evacuation of the debris. With a new manufacturing process, the DUO EVO segments provide an exceptional cutting speed for optimum performance and increased life up to 20% over the original DUO EVO design.				
SIZE (D x T x H)	SEGMENT HEIGHT	MAX RPM	PART #	UPC #
12 x .110 x 1"/20mm	.590"	6,300	DUOEVO12110	701846 84217
14 x .118 x 1"/20mm	.590"	5,460	DUOEVO14118	701846 84218
16 x .125 x 1"/20mm	.590"	4,500	DUOEVO16125	701846 93356



DUO				
Our exclusive design has become a dominant name in the market. The unique dual segment per land technology provides excellent cutting speed with low vibration and high comfort of cut. The exclusive arrow shape gullets not only indicate blade direction, but also assist in fast removal of cutting debris. Maximum general purpose performance when cutting medium to low reinforcement, hard materials.				
SIZE (D x T x H)	SEGMENT HEIGHT	MAX RPM	PART #	UPC #
12 x .110 x 1/20mm	.393"	6,300	DUO12110	701846 83611
14 x .110 x 1/20mm	.393"	5,460	DUO14110	701846 83612
14 x .110 x 1/20mm	.393"	5,460	DUO14110 6PK	701846 84430
14 x .110 x 1/20mm	.393"	5,460	DUO14110 12PK	701846 84431
14 x .125 x 1/20mm	.393"	5,460	DUO14125	701846 83613
14 x .125 x 1/20mm	.393"	5,460	DUO14125 6PK	701846 84432
14 x .125 x 1/20mm	.393"	5,460	DUO14125 12PK	701846 84433
16 x .125 x 1/20mm	.393"	4,500	DUO16125	701846 83798



For Asphalt and Abrasive Materials

DRY – Segmented Rim +

DUO ASPHALT				
Dry cutting laser-welded blade for asphalt and green concrete. The laser-welded, wear-retardant drop segments extend blade life. Scoop gullets for faster swarf removal increases cut speed. Stroboscopic indicators to control cut depth and show rotation direction.				
SIZE (D x T x H)	SEGMENT HEIGHT	MAX RPM	PART #	UPC #
12 x .110 x 1/20mm	.393"	6,300	DUOASP12125	701846 84543
14 x .125 x 1/20mm	.393"	5,460	DUOASP14125	701846 84315
16 x .125 x 1/20mm	.393"	4,500	DUOASP16125	701846 84544



DUO ABRASIVE				
Utilizes the basic characteristics of the original DUO blade and adds a unique segment shape that optimizes the angle of attack while enhancing the evacuation of the particles. The result is an exceptional cutting speed allied with very good performance and life in abrasive materials and concrete block. The bond specification lends additional life when high-speed cutting.				
SIZE (D x T x H)	SEGMENT HEIGHT	MAX RPM	PART #	UPC #
14 x .110 x 1/20mm	.393"	5,460	DUOAB14110	701846 84291
14 x .125 x 1/20mm	.393"	5,460	DUOAB14125	701846 84292



For General-Purpose and Masonry Building Materials

DRY – Segmented Rim +

CLASSIC				
The improved bond provides longer life at an economical price in medium-hard materials such as concrete with light to medium reinforcement.				
SIZE (D x T x H)	SEGMENT HEIGHT	MAX RPM	PART #	UPC #
12 x .110 x 1/20mm	.314"	6,300	COHSGP1220	701846 81383
14 x .110 x 1/20mm	.275"	5,460	COHSGP1420	701846 81309
14 x .125 x 1/20mm	.314"	5,460	COHSGP1420P	701846 84268
16 x .125 x 1/20mm	.259"	4,500	COHSGP1620	701846 40356

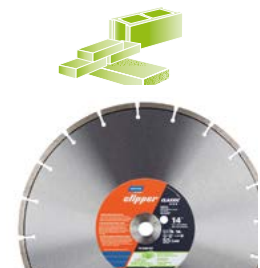

VALUPLUS				
For value and performance on small- to medium-size jobs. The sintered blade cuts unreinforced soft-to-medium concrete fast on saws up to 13 HP.				
SIZE (D x T x H)	SEGMENT HEIGHT	MAX RPM	PART #	UPC #
12 x .110 x 1/20mm	.393"	6,300	VPHSGP1220	701846 84180
14 x .110 x 1/20mm	.393"	5,460	VPHSGP1420	701846 84181
14 x .110 x 1/20mm	.393"	5,460	VPHSGP1420 20PK	701846 84428



Multi-Purpose, For All Materials

Dry – Segmented Rim  + 

4X4 MAX CUT

Taking high-speed cutting versatility to an all new level. The same standard features as the 4X4 with its anti-crack gullets and patented depth indicators that not only cool the blade, but also allow the operator to know how deep they are cutting. An all-new bond and diamond specification improves blade life in a wide range of materials while excelling in steel. New segment wear indicators give the operator an idea of remaining blade life.

SIZE (D x T x H)	SEGMENT HEIGHT	MAX RPM	PART #	UPC #
12 x .118 x 1/20mm	.472"	6,300	4X4MC12118	701846 45927
14 x .125 x 1/20mm	.472"	5,460	4X4MC14125	701846 45926

4X4

Multi-purpose laser welded blade for dry cutting a range of construction materials without sacrificing performance or price. Depth of cut is easily controlled with the patented depth-of-cut indicators cut into the steel core. Anti-crack gullets for enhanced safety cutting steel and metal (up to 5mm thick).

SIZE (D x T x H)	SEGMENT HEIGHT	MAX RPM	PART #	UPC #
12 x .110 x 1/20mm	.393"	6,300	4X412110	701846 84548
14 x .125 x 1/20mm	.393"	5,460	4X414125	701846 84547
16 x .125 x 1/20mm	.393"	4,500	4X416125	701846 45306

3X3

It's everything expected for high-speed cutting when both performance and price are a factor. The laser welded 3X3 cuts concrete, reinforced concrete, asphalt and abrasive building materials and more. High quality diamond increases the speed of cut on a variety of materials without changing blades. Premium blade characteristics and price point that would normally take multiple sintered blades to achieve.

SIZE (D x T x H)	SEGMENT HEIGHT	MAX RPM	PART #	UPC #
12 x .118 x 1/20mm	.314"	6,300	3X312118	701846 47500
14 x .118 x 1/20mm	.314"	5,460	3X314118	701846 47499



TECH TIP

High-Speed Hand Saw Blades –
Maximum Blade Cutting Depths and
Recommended Operating Speeds

Note: Diamond blade cutting depths listed are approximate. Actual cutting depth will vary with the exact blade diameter or saw type, or the exact diameter of the blade flanges. Cutting depth will also be reduced if saw components extend below the blade flanges.





BLADE DIAMETER	CUTTING DEPTH	MAXIMUM SPEED (RPM)
12"	4"	6,300
14"	5"	5,460
16"	6"	4,500



It is the user's responsibility to refer to and comply with ANSI B7.1

For Reinforced Concrete and Harder Building Materials



DRY – Crack Chasing  

CHARGER    				
A heavy V-shaped segment designed with a special bond and diamond content for maximum removal of grout, mortar jointing, crack chasing and crack widening. Fast cutting and long life in abrasive materials using portable tools. Highly competitive to others of its kind in the market.				
SIZE (D x T x H)	SEGMENT HEIGHT	MAX RPM	PART #	UPC #
4 x .375 x 7/8-5/8-20mm	.550"	15,000	CGCC0400	701846 83856
7 x .250 x 7/8-5/8-20mm	.550"	8,730	CGCC0700	701846 83859



For Asphalt and Abrasive Materials





Dry – Tuck Pointing  

CLASSIC   				
An economical solution for small to medium tuck pointing jobs. High-quality performance for heavy grout removal or mortar jointing. The heavy-duty wide segment reduces wear in abrasive materials.				
SIZE (D x T x H)	SEGMENT HEIGHT	MAX RPM	PART #	UPC #
4 x .250 x 7/8-5/8	.275"	15,000	CHTUCK0400	701846 81776
4-1/2 x .250 x 7/8-5/8	.275"	13,300	CHTUCK0450	701846 81777
5 x .250 x 7/8-5/8	.275"	12,225	CHTUCK0500	701846 81778
7 x .250 x 7/8-5/8	.275"	8,730	CHTUCK0700	701846 81779
8 x .250 x 7/8-5/8	.275"	7,640	CHTUCK0800	701846 81780





For General-Purpose and Masonry Building Materials

Dry – Segmented Rim  





CHARGER    				
High-performance dry cutting of a variety of materials. The segment specification allows extended life and fast cut for medium to large jobs.				
SIZE (D x T x H)	SEGMENT HEIGHT	MAX RPM	PART #	UPC #
4 x .080 x 7/8-5/8-20mm	.393"	15,000	CGDSEG0400	701846 81505
4-1/2 x .080 x 7/8-5/8-20mm	.393"	13,300	CGDSEG0450	076607 04021
5 x .080 x 7/8-5/8-20mm	.393"	12,225	CGDSEG0500	701846 82851
6 x .080 x 7/8-5/8-20mm	.393"	10,185	CGDSEG0600	701846 83820
7 x .090 x DM-7/8-5/8	.393"	8,730	CGDSEG0700	076607 04020
8 x .090 x DM-7/8-5/8	.393"	7,640	CGDSEG0800	701846 81513
9 x .090 x 7/8-5/8"	.393"	6,600	CGDSEG0900	701846 69483



VALUPLUS  				
For value and performance on small- to medium-size jobs cutting soft abrasive materials like brick and tile. The sintered rim delivers a quality cut and good life.				
SIZE (D x T x H)	SEGMENT HEIGHT	MAX RPM	PART #	UPC #
4 x .080 x 7/8-5/8-20mm	.315"	15,000	VPSEG0400	701846 84098
4-1/2 x .080 x 7/8-5/8-20mm	.315"	13,300	VPSEG0450	701846 84099
7 x .090 x DM-7/8-5/8	.315"	8,730	VPSEG0700	701846 84100





Dry – Turbo Rim  

CHARGER    				
Combines the characteristics of a standard Charger blade with a turbo rim configuration for cutting hard, dense materials with minimal effort. A better bond and diamond concentration for maximum cutting speed, life and quality of cut.				
SIZE (D x T x H)	SEGMENT HEIGHT	MAX RPM	PART #	UPC #
4 x .080 x 7/8-5/8-20mm	.393"	15,000	CGTURB0400	076607 05475
4-1/2 x .080 x 7/8-5/8-20mm	.393"	13,300	CGTURB0450	076607 04023
5 x .080 x 7/8-5/8-20mm	.393"	12,225	CGTURB0500	701846 82853
7 x .090 x DM-7/8-5/8	.393"	8,730	CGTURB0700	076607 04022
8 x .090 x DM-7/8-5/8	.393"	7,640	CGTURB0800	701846 81512



For Natural Stone and Tiles

Dry – Continuous Rim  

CLASSIC   				
An economical solution for small- to medium-size jobs cutting softer ceramic tile and stone materials with efficient cutting ability.				
SIZE (D x T x H)	SEGMENT HEIGHT	MAX RPM	PART #	UPC #
4 x .080 x 7/8-5/8-20mm	.275"	15,000	CON4DT	076607 02793
4-1/2 x .080 x 7/8-5/8-20mm	.275"	13,300	CON45DT	076607 01194
7 x .090 x DM-7/8-5/8	.275"	8,730	CON7DT	076607 02788



For Reinforced Concrete and Harder Building Materials

WET – Medium Aggregates

CHARGER					
The steel core is designed to keep the cut straight while the .410" segment height prolongs cutting wear. Suitable for cutting medium aggregates with up to 35 HP walk-behind saws.					
SIZE (D x T x H)	SEGMENT HEIGHT	MAX RPM	POWER	PART #	UPC #
14 x .125 x 1	.410"	4,365	35hp	CGWCMD1412	70184681366
18 x .125 x 1	.410"	3,395	35hp	CGWCMD1812	70184681368

CLASSIC					
Laser welded blade at an economical price for general purpose cutting of cured concrete, medium-hard aggregate and no steel reinforcement. The bond and diamond combination allow fast cutting action on limited horse powered walk-behind saws.					
SIZE (D x T x H)	SEGMENT HEIGHT	MAX RPM	POWER	PART #	UPC #
14 x .125 x 1	.326"	4,365	35hp	CHWCGP1412	70184681359
18 x .125 x 1	.326"	3,395	35hp	CHWCGP1812	70184681361



For Asphalt and Abrasive Materials

DRY – Green/Cured Concrete

GMAX – MULTI-PURPOSE					
Designed specifically for our GC55/GC25E down-cut green concrete push saw, the GMAX Multi-Purpose blade is excellent in both green and cured concrete. The unique segment specification and anchor slot gullets allow this blade to be used in a variety of applications with outstanding results.					
SIZE (D x T x H)	SEGMENT HEIGHT	MAX RPM	POWER	PART #	UPC #
8 x .095 x 7/8-5/8	.372"	8,730	6hp	NXDGRN0895	70184683758
9 x .110 x 7/8-5/8	.372"	6,600	6hp	EE9110	70184675125
10 x .110 x 1-7/8-5/8	.372"	6,115	6hp	EE10110	70184684508



WET – Asphalt

CHARGER					
For large road and construction jobs with saws up to 35 HP. Higher diamond content increases productivity and offers faster cutting and longer life in asphalt and green concrete applications.					
SIZE (D x T x H)	SEGMENT HEIGHT	MAX RPM	POWER	PART #	UPC #
14 x .125 x 1	.327"	4,365	35hp	CGWASP1412	70184681478
18 x .125 x 1	.307"	3,395	35hp	CGWASP1812	70184681479

CLASSIC					
An economical choice for fast cutting and good life when performing jobs in a variety of abrasive materials such as green concrete and asphalt on saws up to 35 HP.					
SIZE (D x T x H)	SEGMENT HEIGHT	MAX RPM	POWER	PART #	UPC #
14 x .125 x 1	.326"	4,365	35hp	CHWASP1412	70184681375
18 x .125 x 1	.326"	3,395	35hp	CHWASP1812	70184681376



TECH TIP

Walk-Behind Saw Blades – Maximum Blade Cutting Depths and Recommended Operating Speeds

Note: Diamond blade cutting depths listed are approximate. Actual cutting depth will vary with the exact blade diameter or saw type, or the exact diameter of the blade flanges. Cutting depth will also be reduced if saw components extend below the blade flanges.

BLADE DIAMETER	CUTTING DEPTH	IDEAL SPEED (RPM)	MAXIMUM SPEED (RPM)
8"	2"	4,536	7,640
9"	2-1/2"	2,640	6,600
10"	3"	2,446	6,115
14"	4-5/8"	2,592	4,365
18"	6-5/8"	2,016	3,395

It is the user's responsibility to refer to and comply with ANSI B7.1



Norton Clipper cup grinders are available in a range of specifications and diameters providing a solution for a number of applications in the building and construction industry. There are many benefits to diamond grinding. It's very fast, low-cost and creates little noise compared to other concrete cutting options. It has become a very popular choice in the commercial construction and DIY home improvement industries.

- Applications:** Used on right angle grinders to grind concrete, stone and masonry materials.
- Size Range:** 4" – 7"
- Segment Height Range:** .177", .210"
- Abrasive Grain:** Diamond
- Mounting Options:** 5/8"-11 attachment optimized for all popular angle grinders, 7/8-5/8"-20mm
- Options:** Standard – single row or double row available
iHD (Infiltrated High-Density) has thicker body, larger ventilation holes for better cooling
- Machines Used:**  RIGHT-ANGLE GRINDER

General-Purpose and Masonry Building Materials

Dry – Cup Grinder 

3X3 WITH iHD TECHNOLOGY 
The 3X3 cup grinder ensures very high material removal rate, extreme comfort while working without vibrations and a self-sharpening feature. These new iHD cups offer the best finishing and longest life even on softer, more abrasive materials.

SIZE (D x H)	SEGMENT HEIGHT	MAX RPM	PART #	UPC #
4 x 5/8"-11	.177"	15,000	3X3CG0400	701846 01763
5 x 5/8"-11	.177"	12,225	3X3CG0500	701846 01766
7 x 5/8"-11	.177"	8,730	3X3CG0700	701846 01769

CHARGER WITH iHD TECHNOLOGY 
The Charger cup grinder ensures a high material removal rate and more comfortable work. These new iHD cups provide a better finish and long life on a wide range of materials.

SIZE (D x H)	SEGMENT HEIGHT	MAX RPM	PART #	UPC #
4 x 5/8"-11	.177"	15,000	CGCG0400	701846 01762
5 x 5/8"-11	.177"	12,225	CGCG0500	701846 01765
7 x 5/8"-11	.177"	8,730	CGCG0700	701846 01768

CLASSIC WITH iHD TECHNOLOGY 
The Classic cup grinder provides efficient material removal rate thanks to the small contact surfaces of the segments. The cups also have flat sides to avoid damaging walls or ceilings during flush grinding.

SIZE (D x H)	SEGMENT HEIGHT	MAX RPM	PART #	UPC #
4 x 5/8"-11	.177"	15,000	CCCG0400	701846 01761
5 x 5/8"-11	.177"	12,225	CCCG0500	701846 01764
7 x 5/8"-11	.177"	8,730	CCCG0700	701846 01767

CLASSIC 
Available in a range of sizes and segment designs for optimum performance by life or by speed. Ideal for leveling all types of masonry materials, brick, block, concrete and stone. Strategically placed hole designs help ventilate dust from the surface to extend the life of the cups.

SIZE (D x H)	SEGMENT HEIGHT	MAX RPM	PART #	UPC #
Single Row for Fast Stock Removal				
4 x 7/8-5/8-20mm	.210"	15,000	CHSCPH0400	701846 82585
5 x 7/8-5/8-20mm	.210"	12,225	CHSCPH0500	701846 84035
7 x 7/8-5/8-20mm	.210"	8,730	CHSCPH0700	701846 82594
4 x 5/8"-11	.210"	15,000	CHSCPT0400	701846 82555
5 x 5/8"-11	.210"	12,225	CHSCPT0500	701846 84036
7 x 5/8"-11	.210"	8,730	CHSCPT0700	701846 82593
Double Row for Long Life, Smooth Finish				
4 x 7/8-5/8-20mm	.210"	15,000	CHDCPH0400	701846 82588
5 x 7/8-5/8-20mm	.210"	12,225	CHDCPH0500	701846 84037
7 x 7/8-5/8-20mm	.210"	8,730	CHDCPH0700	701846 82596
4 x 5/8"-11	.210"	15,000	CHDCPT0400	701846 82586
5 x 5/8"-11	.210"	12,225	CHDCPT0500	701846 84038
7 x 5/8"-11	.210"	8,730	CHDCPT0700	701846 82595

Accessories

VACUUM SHROUD KIT
The Vacuum Shroud's design creates a cyclonic affect extracting dust and debris from the work surface into the support vacuum. This prolongs the life of the grinding cup and grinder and provides a smoother surface while decreasing the chance of dust particle inhalation.

DESCRIPTION	UPC #
Kit includes: one shroud, five different adapter rings to fit most popular right-angle grinders, and one 7" Norton Clipper Classic single row cup wheel	701846 41039





Core bits are cutting tools used to remove a cylindrically shaped piece of material. A core drill is designed to cut a hole and remove a core sample or to drill a hole without leaving material behind. Diamond core bits have diamond cutting tips and are frequently used for drilling in materials such as concrete, stone, and asphalt.

- Applications:** Used on core drills in materials such as concrete, stone and other hard materials
- Size Range:** 2" – 10"
- Segment Height Range:** .254", .393"
- Abrasive Grain:** Diamond
- Mounting Options:** 1-1/4"-7 threads
- Machines Used:**



Reinforced Concrete and Harder Building Materials

WET – Hard Aggregates



PARADIGM Premium diamond in the turbo segment permits the core to penetrate quickly and efficiently into the toughest cured concrete, for significantly increased performance. The 14" tube length with 1-1/4"-7 threads fits a wide range of core drill mounting arbors.

SIZE IN INCHES	SIZE IN MM	SEGMENT HEIGHT	MAX RPM	PART #	UPC #
2"	51mm	.490"	2,000	PDBIT0200	701846 01410
2-1/2"	64mm	.490"	1,300	PDBIT0250	701846 01411
3"	76mm	.490"	1,300	PDBIT 0300	701846 01412
3-1/2"	89mm	.490"	1,300	PDBIT0350	701846 01413
4"	102mm	.490"	1,000	PDBIT0400	701846 01414
4-1/2"	114mm	.490"	800	PDBIT0450	701846 01415
5"	127mm	.490"	800	PDBIT0500	701846 01416
6"	152mm	.490"	665	PDBIT0600	701846 01417
7"	178mm	.490"	600	PDBIT0700	701846 01418
8"	203mm	.490"	500	PDBIT0800	701846 01419
10"	254mm	.490"	400	PDBIT1000	701846 01706



CLASSIC Economical choice for use in harder concrete with heavy reinforcement and masonry materials with good performance.

SIZE IN INCHES	SIZE IN MM	SEGMENT HEIGHT	MAX RPM	PART #	UPC #
2"	51mm	.350"	2,000	CHBIT0200	701846 82762
3"	76mm	.350"	1,300	CHBIT0300	701846 82765
4"	102mm	.350"	1,000	CHBIT0400	701846 82767
6"	152mm	.350"	665	CHBIT0600	701846 82771
8"	203mm	.350"	500	CHBIT0800	701846 82773
10"	254mm	.350"	400	CHBIT1000	701846 82774

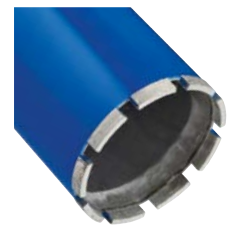

TECH TIP

Core Bits – Minimum and Maximum Recommended Operating Speeds

BIT DIAMETER	MINIMUM RPM	IDEAL SPEED (RPM)	MAXIMUM RPM
1"	2,400	3,200	4,000
2"	1,200	1,600	2,000
3"	800	1,050	1,300
4"	600	800	1,000
5"	475	640	800
6"	400	530	665
7"	340	450	600
8"	300	400	500
10"	240	320	400

Note: For half inch increments, go to the next larger bit diameter.



It is the user's responsibility to refer to and comply with ANSI B7.1



High-Speed Gas Saws

No more pre-mixing oil and fuel – the patented iLube option automatically controls mixing for maximum efficiency, and the saw drops to idle speed when the oil is low – eliminating possible machine damage

Walk-Behind Saws

Proven, robust and functional for ideal user comfort. The professionals' choice for outstanding walk behind cutting performance, wet or dry.

Masonry Saws

Norton introduced the first masonry saw over 70 years ago and they have become the industry standard for masons worldwide.

For the full line of quality Norton Clipper equipment, please contact your local Norton sales representative

High-Speed Gas Saws

CP500 SERIES HIGH-SPEED SAWS

The Norton Clipper CP500 high-speed cut-off saw might be new to the market, but it's destined to be an asset on any crew. It's fully designed with the user in mind to not only cut a smooth, fast track, but it's also fully equipped to handle the everyday performance of any jobsite with unremitting durability and reliability. Select a standard model or upgrade to the world's first patented automatic lubrication system, Norton Clipper iLube.

The patented iLube option automatically controls mixing of oil and fuel for maximum efficiency. An electronic sensor will indicate a low oil level and adjust the engine to idle to prevent engine damage.

DESCRIPTION	SHAFT RPM	PART #	UPC #
12" Standard High-Speed Cut-Off Saw	4,500	CP512-300	701846 47559
12" iLube High-Speed Cut-Off Saw	4,500	CP512-300i iLube	701846 47561
14" Standard High-Speed Cut-Off Saw	4,500	CP514-350	701846 47563
14" iLube High-Speed Cut-Off Saw	4,500	CP514-350i iLube	701846 47565

ACCESSORIES

High-Speed Saw Wheel Kit	005101 09845
High-Speed Saw Tool Kit	005101 09846



iLube®
Intelligent Lubrication

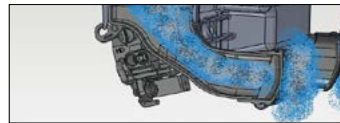
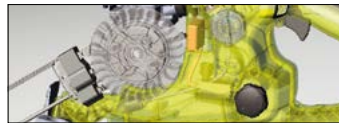

Walk-Behind Push Saws



GC55 EARLY ENTRY/GREEN SAW

With a compact, light-weight design backed by the reliable Honda 5HP gasoline engine, the GC55 early entry saw is intended for a variety of applications. From green, cured or decorative concrete cutting to expansion joints, the features of this small push saw are hard to beat in a single saw. The low, wide profile of the frame, along with the front mount blade, contribute to producing a more disciplined cut.

UPC #	MOTOR	WEIGHT	GUARD
701846 30005	Honda GX160	115 lbs	10"



C1318P GASOLINE SAW

The next generation of 13HP saws. The C1318P features shock-absorbing handle bars. The new sleek design of the water tank, with increased capacity and improved securing, adds an additional 1.5 gallons of water over the cut. And, a newly-designed belt tensioning system helps keep the saw cutting true and true. All these features, coupled with the Honda 13HP engine, make the C1318P the premiere choice for rental and service work.

UPC #	MOTOR	WEIGHT	GUARD
701846 42453	Honda GX390	220 lbs	18"



C13PE GASOLINE SAW

Rental equipment has to withstand any and all conditions by user and application. For that reason, the Norton Clipper C13PE or CP14PE suits any rental fleet that both the novice and expert will appreciate to hold-up through tough situations. The 18" blade guard, ride-on water system and quick-release blade guard lock all keep safety in mind while the rugged frame, powerful engine and easy-to-use console makes cutting a breeze.

UPC #	MOTOR	WEIGHT	GUARD
701846 47524	Honda GX390	220 lbs	18"

Large Masonry Saws

BBL BLOCKBUSTER LARGE MASONRY SAWS

Having introduced the first masonry saw over 70 years ago, the Norton Clipper BBL heavy-duty block saws have become the industry standard for masons worldwide. These models are equipped with single-phase electric motors and come with a blade capacity of 14" or 20". Extended water pan and open back frame allow cutting of larger materials. The balanced cutting head makes for effortless cutting depth positioning. Having a rugged all-steel frame design with forklift brackets allows these saws to resist twisting and damage during transport around a job site. For other sizes and horsepower machines, or for gasoline-powered versions, contact your Norton sales representative.

DESCRIPTION	HP	PART #	UPC #
BBL547 Blockbuster Saw with Baldor electric motor; 14" blade guard capacity	5	BBL547	701846 83211
BBL527 Blockbuster Saw with Baldor electric motor; 20" blade guard capacity	5	BBL527	701846 83150

ACCESSORIES

Electric Water Pump – PE-1	701846 68392
Conveyor Cart Replacement for BBL	003100 7390



Electric Water Pump

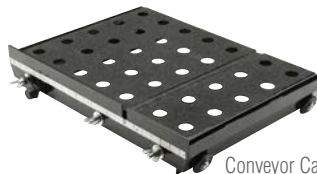

Conveyor Cart Replacement



Compact Masonry Saws

BBC BLOCKBUSTER COMPACT MASONRY SAWS

Combines the performance of a full size masonry saw with the convenience of portability. Also available in gas or electric versions, the BBC saws have a rugged jig-welded frame, durable enough for even the heaviest work load. Standard rear wheel dolly design and removable legs make transport and set-up easy. For other sizes and horsepower machines, or for gasoline-powered versions, contact your Norton sales representative..

DESCRIPTION	HP	PART #	UPC #
BBC157 Blockbuster Saw with Baldor electric motor; 14" blade guard capacity	1.5	BBC157	701846 82488
BBC207 Blockbuster Saw with Baldor electric motor; 14" blade guard capacity	2	BBC207	701846 82501
BBC207 Blockbuster Saw with Baldor electric motor; 20" blade guard capacity	3	BBC307	701846 30011
BBC547 Blockbuster Saw with Honda gasoline motor; 14" blade guard capacity	5.5	BBC547	701846 82175
BBC507 Blockbuster Saw with Honda gasoline motor; 20" blade guard capacity	5.5	BBC507	701846 30012

ACCESSORIES

Electric Water Pump – PE-1	701846 68392
Conveyor Cart Replacement for BBC	003100 7367



Mini Masonry Saws

BBM BLOCKBUSTER MINI MASONRY SAWS

The innovative design of these small masonry saws has been copied many times due to its compact, all-steel unibody construction, giving the best weight-to-strength distribution. A 14" blade capacity and ergonomically-designed, three-position locking, cutting head provides a safe, clear view of the work area. Whether your choice is the 3HP brush motor or the 1.5HP induction motor for heavier commercial use, both come with features such as overload protection, garden hose connection and a channeled-flow water pan to direct dust and slurry away from the operator.

DESCRIPTION	HP	PART #	UPC #
Blockbuster Mini Masonry Saw with AC universal motor; gear drive	3	BBM307	701846 00684
Blockbuster Mini Masonry Saw with Induction motor; belt drive	2	BBM158	701846 26327

ACCESSORIES

Vacuum Adaptor Kit (includes: back splash, adaptor and hardware)	701846 00753
Wet Kit	701846 00704
Stand	701846 00691



Wet Kit



Stand



All saws on this page come equipped with genuine Norton Clipper diamond blades.

get wired
FOR SUCCESS

Our broad wire brush offering includes the shapes, wire configurations and filament materials you'll need for heavy- to light-duty brushing applications.





Our Norton wire brush broad offering includes all the basic shapes and configurations. Informative, attractive packaging clearly explains dimensions, structure, safety and machine usage. All brushes are individually clamshell packaged unless otherwise noted. When using wire brushes, be sure to comply with ANSI B165 "Power-Driven Brushing Tools: Safety Requirement for the Design, Care and Use."

Applications:

Cleaning rust, scale and dirt; light deburring; edge blending; roughening for adhesion; finishing for appearance; finish preparation prior to plating or painting

Shapes:

Cup, saucer cup, wheel, joint/crack, end brush, hand brush

Wire Design:

Twist knot, crimped, and stringer bead

Other:

Color-coded for easy identification:



Machine Used:

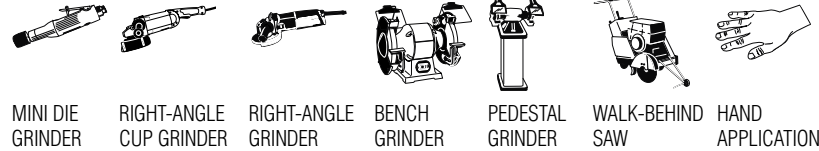

Why Use Wire Brushes vs. Other Brushes, Coated Abrasive, and Surface-Cleaning Products

Norton Wire brushes remove rust and oxidations, paint, slag, weld spatter and other unwanted surface contaminants, without removing any base material. Other products can remove base material along with the surface contaminant. Our flexible wire brushes are able to clean hard-to-reach places and conform to irregular surfaces, which more rigid products cannot do.

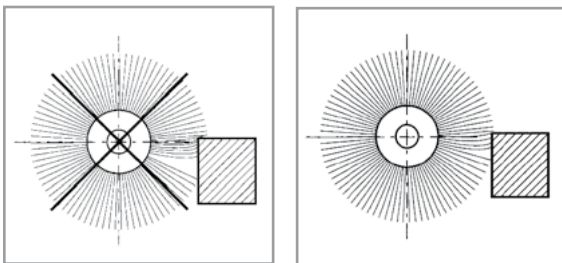

Let the tip of the wire brush do the work – operate the brush with the lightest pressure. If heavy pressure is used, wires will be overstressed, resulting in a wiping action, which, if continued, creates wire fatigue and will shorten brush life. Reversing the rotation periodically sharpens the wire tips for faster cutting action and longer life. Use finest suitable wire size.



Crimped

Standard Twist Knot

Stringer Bead Twist Knot

TECH TIP

When to Use Crimped Wire vs. Standard Twist Knot vs. Stringer Bead Twist Knot Brushes

Crimped Wire Brushes

Crimped wire brushes' individual filaments are supported only by each other – creating extra flexibility.

Ideal for work on irregular surfaces, finer surface finishing, and light- to medium-duty contaminant removal applications.

Standard Twist Knot Wire Brushes

Ensuring longer life, making them the choice for more aggressive applications requiring higher-impact action, and a rougher surface finish.

Standard twist knot brushes are made with straight wire filaments that are twisted together to make more rigid rope- or cable-like pieces.

Stringer Bead Twist Knot Wire Brushes

Stringer bead twist knots (vs. standard twist knots) are more tightly twisted to the end of the knot, creating a narrower face and highest-impact action.

The choice for tough weld scale cleaning, removing the bead scale that occurs at the initial joining of two sections of pipe, root and hot weld pass cleaning, and the most aggressive brushing applications.

Workpiece Material To Wire Brush Recommendation Guide

Workpiece Material	Carbon Steel	Stainless Steel	Brass	Nylon
ALUMINUM		Blue	Orange	Green
BRASS		Blue	Orange	Green
COPPER		Blue	Orange	Green
IRON	Red		Orange	Green
PLASTIC			Orange	Green
CARBON STEEL/METAL	Red		Orange	Green
STAINLESS STEEL		Blue	Orange	Green
WOOD	Red	Blue	Orange	Green

Wire Diameter

Choose the appropriate wire brush wire diameter for the job

- Very fine to fine wire for light-duty applications
- Medium to coarse wire for heavy-duty applications

Wire	Coarse		Medium to Coarse		Medium		Fine		Very Fine	
DIAMETER IN INCHES	.032	.020	.020	.015	.012	.0104	.010	.008	.006	.005
DIAMETER IN MM	.80	.50	.50	.37	.30	.26	.25	.20	.15	.13

TECH TIP

Trim Length

Choose the appropriate trim length for the job. "Trim Length" equals the amount of usable filament:

- Longer trim lengths are more flexible, making them the choice for irregular surfaces
- Shorter trim lengths are fast acting and more rigid, so better for more severe applications

TECH TIP

Filament Do's and Don'ts

Excessive pressure bends and could break brush filaments. Instead of increasing the pressure applied, consider:

- A more aggressive brush:
 - Increasing wire diameter
 - Shorter trim length
- Different brush type, e.g. twist knot versus crimped wire
- Increasing RPM without exceeding the MAX RPMs marked on the brush

We also offer Norton Blaze ceramic alumina nylon abrasive brushes which are custom-made to your exact requirements. For more information download our Blaze Nylon Brushes Brochure #8571 or contact your Norton representative.

Norton representative would be pleased to review availability, quotations, and lead-times with you.

Better choice for deburring, removing rust, paint, corrosion and weld spatter from metal surfaces



BLUEFIRE WIRE BRUSHES

- Perfect for removing rust, scale, paint, and dirt from metal and other surface
- Available in a variety of brush types and sizes for large flat areas to small, tight spaces
- Durable design provides a uniform finish while offering the longest life

Good choice for removing rust oxidation, paint, slag and weld spatter without removing base material



GEMINI WIRE BRUSHES

- Ideal low-impact solution for refining surfaces without removing any base material
- Flexible design for cleaning hard-to-reach places and conforming to irregular surfaces, which more rigid products cannot do
- Economically priced yet solid-performing to complement your projects perfectly while bringing real savings to the bottom line



EXPANDED OFFERING

Deburring; roughing; cleaning rust, scale, paint and oxidation; cleaning corners, recesses, and other hard-to-reach areas and removing concrete and large surfaces

WIRE CUP BRUSHES

- Used on right angle cup grinders
- Twist Knot style for heavy-duty applications
- Crimped cup for light- to medium-duty applications



TIER:	BETTER	BETTER
TRADENAME:	BLUEFIRE	BLUEFIRE
WIRE TYPE:	CARBON	STAINLESS

SIZE	TRIM LENGTH	MAX. RPM	STD. PKG.	PART #	PART #
Twist Knot Wire Saucer Cup Brushes - Single Row - With Arbor Hole					
4" x 0.020" x 5/8"-11	7/8"	15,000	5	662528 33483	
5" x 0.020" x 5/8"-11	1-1/8"	12,500	10	662528 35585	662528 35586

Twist Knot Wire Cup Brushes

- Their more rigid structure allows efficient, high-impact cutting and cleaning on more demanding applications.
- Single row construction limits flaring of the brush on corners and angles



TIER:	BETTER	BETTER	BETTER	BETTER	GOOD	GOOD
TRADENAME:	BLUEFIRE	BLUEFIRE	BLUEFIRE	BLUEFIRE	GEMINI	GEMINI
WIRE TYPE:	CARBON	STAINLESS	CARBON	CARBON	CARBON	STAINLESS

SIZE	TRIM LENGTH	MAX. RPM	STD. PKG.	PART #	PART #	PART #	PART #	PART #	PART #
Twist Knot Wire Cup Brushes - Single Row - With Arbor Hole									
2-3/4" x 0.014" x 5/8"-11	1"	14,000	5					662528 39109	
2-3/4" x 0.014" x 5/8"-11	7/8"	14,000	5					662528 38870	662528 38871
2-3/4" x 0.020" x 5/8"-11	3/4"	14,000	5	699366 53336	699366 53340				
2-3/4" x 0.020" x 5/8"-11	1"	14,000	10					662528 39033	662528 38812
2-3/4" x 0.020" x 5/8"-11	7/8"	14,000	5					662528 38872	
3" x 0.020" x 5/8"-11	7/8"	14,000	5					662528 38835	662528 39127
3" x 0.020" x M10	7/8"	14,000	5					662528 39075	
3-1/2" x 0.020" x 5/8"-11	1-3/8"	13,000	5					662528 38868	
3-1/2" x 0.020" x 5/8"-11	7/8"	13,000	5					662528 38813	
4" x 0.014" x 5/8"-11	1-1/4"	9,000	5					662528 39060	
4" x 0.020" x 5/8"-11	1-1/8"	9,000	10					662528 39103	
4" x 0.020" x 5/8"-11 with bridle	1-1/16"	9,000	5	699366 53345	662528 33947				
4" x 0.023" x 5/8"-11	1-1/4"	9,000	5					662528 39090	
6" x 0.014" x 5/8"-11	1-3/8"	6,600	5					662528 39037	
6" x 0.020" x 5/8"-11	1-3/8"	6,000	5	699366 05965	662533 71115			662528 39104	
6" x 0.023" x 5/8"-11	1-3/8"	6,000	5					662528 39091	
6" x 0.035" x 5/8"-11	1-3/8"	6,000	5	699366 02003					
Twist Knot Wire Cup Brushes - Single Row - With Arbor Hole and Protective Guard									
2-3/4" x 0.020" x 5/8"-11	3/4"	15,000	5				662528 33492		
4" x 0.020" x 5/8"-11	1-1/8"	9,000	5				662528 33496		
5" x 0.020" x 5/8"-11	1-1/8"	6,500	5				662528 33497		
Twist Knot Wire Cup Brushes - Double Row - With Arbor Hole									
6" x 0.020" x 5/8"-11	1-3/8"	6,000	5				699366 53346		

Crimped Wire Cup Brushes

For light- to medium-duty brushing applications on flat or irregular surfaces, and bevel buffing where added flexibility is needed; fast-cutting and flexible, with heavy wire fill

- Machine for cups with arbor holes: right angle cup grinder
- Machine for shank mounted cups: straight in-line grinder, pencil grinder



TIER: **BETTER**
TRADENAME: **BLUEFIRE**
WIRE TYPE: **CARBON**

SIZE	TRIM LENGTH	MAX. RPM	STD. PKG.	PART #
High Performance Cable Crimped Wire Cup Brushes - With Arbor Hole and Protective Guard				
3" x (12 x 0.009") x 5/8"-11	7/8"	15,000	5	662528 33493
4" x (12 x 0.009") x 5/8"-11	1-3/16"	9,000	5	662528 33494



TIER: **BETTER** **BETTER** **GOOD**
TRADENAME: **BLUEFIRE** **BLUEFIRE** **GEMINI**
WIRE TYPE: **CARBON** **STAINLESS** **CARBON**

SIZE	TRIM LENGTH	MAX. RPM	STD. PKG.	PART #	PART #	PART #
Crimped Wire Cup Brushes – With Arbor Hole						
2-3/4" x 0.014" x 5/8"-11	1"	14,000	5			662528 38856
2-3/4" x 0.020" x 3/8"-24	1"	14,000	5			662528 39080
3" x 0.014" x 5/8"-11	13/16"	14,000	5			662528 39076
3" x 0.014" x 5/8"-11	7/8"	14,000	5	699366 53341	662528 36362	
3" x 0.014" x 5/8"-11	1"	14,000	10			662528 39034
4" x 0.014" x 5/8"-11	1-3/16"	9,000	5	699366 53347		
4" x 0.014" x 5/8"-11	1-1/8"	9,000	10			662528 39121
4" x 0.020" x 5/8"-11	1-3/16"	9,000	5		662528 43844	
5" x 0.014" x 5/8"-11	1-3/8"	8,000	5			662528 39105
6" x 0.014" x 5/8"-11	1-1/8"	6,000	5	699366 53348		
6" x 0.020" x 5/8"-11	1-1/8"	6,000	5	699366 53349		



TIER: **GOOD** **GOOD** **GOOD**
TRADENAME: **GEMINI** **GEMINI** **GEMINI**
WIRE TYPE: **CARBON** **STAINLESS** **BRASS**

SIZE	TRIM LENGTH	MAX. RPM	STD. PKG.	PART #	PART #	PART #
Crimped Wire Cup Brushes - Shank Mounted						
5/8" x 0.005" x 1/8"	1/4"	37,000	100			662528 39087
1-3/4" x 0.006" x 1/4"	1/2"	13,000	10	662528 38857		
1-3/4" x 0.012" x 1/4"	1/2"	13,000	10	662528 38858		
1-3/4" x 0.012" x 1/4"	3/4"	13,000	12	662528 39028		
2" x 0.010" x 1/4"	5/8"	10,500	12		662528 38859	
2" x 0.012" x 1/4"	5/8"	13,000	12	662528 39110		
2-1/4" x 0.014" x 1/4"	5/8"	4,500	10	662528 38860		



EXPANDED OFFERING

Applications range from the toughest, more aggressive surface cleaning applications, including removing weld scale, spatter, extra-heavy rust and corrosion, cleaning pipe joints, or surface roughening to light- to medium- duty surface cleaning and contaminant removal

WIRE WHEEL BRUSHES

- Available in Standard Twist Knot, Stringer Bead Twist Knot, and Crimped
- See specific machines for each wire wheel below



Standard Twist Knot Wire Wheel Brushes

Our twist knot wire design provides added rigidity for extra cutting and cleaning power, and a rougher surface finish.

- Wheel brushes with arbor holes perform well on more aggressive applications requiring high-impact action: tough welding and metal fabrication applications, including removing weld scale, spatter, extra-heavy rust.
- These shank-mounted wheel brushes are used for small-to-medium-duty jobs requiring some flexibility and lighter brushing action for corrosion, or surface roughing applications. These brushes are used on straight shaft, die, pencil grinders, drills and right angle grinders.



TIER:	BETTER	BETTER	BETTER	GOOD	GOOD
TRADENAME:	BLUEFIRE	BLUEFIRE	BLUEFIRE	GEMINI	GEMINI
WIRE TYPE:	CARBON	STAINLESS	PIPELINE	CARBON	STAINLESS

SIZE	FACE WIDTH	TRIM LENGTH	MAX. RPM	STD. PKG.	PART #	PART #	PART #	PART #	PART #
Standard Twist Knot Wire Wheel Brushes – With Arbor Hole									
3" x 0.15" x 1/2"-3/8"	3/8"	5/8"	20,000	6	699366 53314				
3" x 0.014" x 3/8"	3/8"	5/8"	25,000	1				662528 39021	
4" x 0.014" x 5/8"-11	5-16"	7/8"	20,000	5				662528 39011	
4" x 0.014" x 5/8"-11	1/2"	7/8"	20,000	10				662528 39052	
4" x 0.020" x 5/8"-11	1/4"	3/4"	20,000	10					662528 39132
4" x 0.020" x 5/8"-11	1/2"	3/4"	20,000	5	662528 38300				
4" x 0.020" x 5/8"-11	1/2"	7/8"	20,000	10				662528 39035	662528 39020
4" x 0.020" x 5/8"-11	1/2"	7/8"	20,000	5				662528 39078	
4" x 0.020" x 5/8"-11	9/16"	7/8"	20,000	10				662528 39019	
4-1/2" x 0.020" x 5/8"-11	1/2"	1"	20,000	5	699366 06275				
4-1/2" x 0.020" x 5/8"-11 (black hub)	1/2"	1"	20,000	6			662528 40466		
4-1/2" x 0.020" x 5/8"-11	1/2"	1"	20,000	6	699366 53331				
4-1/2" x 0.020" x 5/8"-11	1/2"	1"	20,000	5		699366 53333			
5" x 0.020" x 5/8"-11	1/2"	1"	12,500	5	662528 33487	662528 33488			
6" x 0.014" x 5/8"-11	1/2"	1-1/2"	12,000	5				662528 39014	
6" x 0.020" x 5/8"-11	1/2"	1-3/8"	12,000	5	699366 53352	662533 71540			
6" x 0.020" x 5/8"-11	5/8"	1-1/4"	12,000	5				662528 39107	662528 39594
6" x 0.020" x 5/8"-11	1/2"	1-3/8"	12,000	5	699366 53327				
6" x 0.025" x 5/8"-11	5/8"	1-1/4"	9,000	5				662528 39593	



TIER:	GOOD
TRADENAME:	GEMINI
WIRE TYPE:	CARBON

SIZE	FACE WIDTH	TRIM LENGTH	MAX. RPM	STD. PKG.	PART #
Standard Twist Knot Wire Wheel Brushes - Shank Mounted					
3" x 0.014" x 1/4"	1/4"	5/8"	25,000	12	662528 39015
3-1/4" x 0.014" x 1/4"	3/8"	5/8"	25,000	10	662528 39031
4" x 0.014" x 1/4"	1/2"	7/8"	25,000	8	662528 39032



Stringer Bead Twist Knot Wire Wheel Brushes

The choice for toughest weld scale cleaning; removing the bead scale that occurs at the initial joining of two sections of pipe; root, and hot weld pass cleaning, and the most aggressive brushing applications. Stringer Bead Twist Knot Wire Wheel Brushes are best used on right angle grinders for difficult jobs.



TIER:	BETTER	BETTER	BETTER	BETTER	BETTER	GOOD	GOOD
TRADENAME:	BLUEFIRE	BLUEFIRE	BLUEFIRE	BLUEFIRE	BLUEFIRE	GEMINI	GEMINI
WIRE TYPE:	CARBON	CARBON	CARBON	STAINLESS	STAINLESS	CARBON	STAINLESS
OTHER:		Pipeline	Heavy-Duty		Pipeline		

SIZE	FACE WIDTH	TRIM LENGTH	MAX. RPM	STD. PKG.	PART #	PART #	PART #	PART #	PART #	PART #
Stringer Bead Knot Wire Wheel Brushes – With Arbor Hole										
3" x 0.020" x 1/4"		1"	20,000	10						662528 39096
4" x 0.020" x 5/8"-11	3/16"	7/8"	20,000	5	699366 06277					
4" x 0.020" x 5/8"-11	3/16"	7/8"	20,000	6*	662528 33489	662528 40467		699366 06278	662528 42233	
4" x 0.020" x 5/8"-11	3/16"	7/8"	20,000	10*	662533 70022					
4" x 0.020" x 5/8"-11	3/16"	7/8"	20,000	10						662528 39036 662528 39039
4" x 0.020" x 5/8"-11	1/4"	7/8"	20,000	5						662528 38997
4" x 0.020" x 5/8"-11	1/2"	7/8"	20,000	10						662528 39130
4" x 0.020" x 5/8"-11	1/2"	1"	20,000	10						662528 39106
4" x 0.020" x M10	3/16"	7/8"	20,000	10						662528 39038
4-1/2" x 0.020" x 5/8"-11	3/16"	1-1/8"	20,000	6			662528 44886			
4-1/2" x 0.020" x 5/8"-11	3/16"	1-1/8"	20,000	6*		662528 42299				
4-1/2" x 0.020" x 5/8"-11	3/16"	3/16"	15,000	5						662528 39111
5" x 0.020" x 5/8"-11	3/16"	7/8"	12,500	10*	662528 33490			662528 33491		
5" x 0.020" x 5/8"-11	1/2"	7/8"	12,500	5						662528 39133
6" x 0.020" x 5/8"-11	3/16"	1-3/8"	9,000	10	699366 53350		662528 44887	699366 53351		
6" x 0.020" x 5/8"-11	3/16"	1-3/8"	9,000	10*			662528 40469			
6-7/8" x 0.020" x 5/8"-11	3/16"	1-1/8"	9,000	10*	699366 53329	662528 40468	662528 43919	662533 71116		
6-7/8" x 0.020" x 5/8"-11	3/16"	1-1/8"	9,000	5						662528 39026
6-7/8" x 0.020" x 5/8"-11	3/16"	1-1/8"	9,000	6	662528 10992					
Double Hub										
9" x 0.020" x 5/8"-11	3/16"	2-1/8"	6,000	6	662528 37993					
Stringer Bead Knot Wire Wheel - With Arbor Hole – For Walk – Behind Machines										
12" x 0.035" x 1"-DP	3/8"	3-1/4"	4,500	2	699366 06280					

*Bulk Packed Item



Radial Wheel

Nylon Radial Wheel Brushes are best used for deburring, surface and light cleaning, adding an edge radius, on ferrous and non-ferrous parts. The long trim length is ideal when used on intricate or irregular parts.

- Machine: Bench and Pedestal, Automated CNC, Inline Grinders



TIER:	GOOD
TRADENAME:	GEMINI
WIRE TYPE:	NYLON

SIZE	FACE WIDTH	TRIM LENGTH	MAX. RPM	STD. PKG.	PART #
Radial Wheel					
3" x 3/8" x 5/8"	3/8"	15/16"	15,000	12	662528 38842



TIER:	BETTER	GOOD	GOOD
TRADENAME:	BLUEFIRE	GEMINI	GEMINI
WIRE TYPE:	CARBON	CARBON	STAINLESS

Crimped Wire Wheel Brushes

Shank-mounted wheel brushes are used on straight shaft, die, and pencil grinders, and drills. Wheel brushes with arbor holes are used on bench and pedestal grinders. Their extra flexibility and lower impact makes these brushes an excellent choice for cleaning irregular surfaces and finer surface finishing, and light to medium duty surface contaminant removal applications. May be used individually or stacked on a shaft.

- Narrow-faced brushes are ideal for general-purpose brushing of uneven or difficult-to-reach surfaces.
- Medium-faced brushes clean larger surface areas and have longer life.



Crimped Wire Narrow Face - Carbon Steel - with Arbor hole



Crimped Wire - Carbon Steel - Shank Mounted

SIZE	FACE WIDTH	TRIM LENGTH	MAX. RPM	STD. PKG.	PART #	PART #	PART #
Crimped Wire Wheels Brushes with Narrow Face - With Arbor Hole							
1" x 0.008" x 5/16"	5/32"	3/16"	20,000	20		662528 38949	
2" x 0.014" x 1/2"	3/8"	1/2"	20,000	12		662528 39023	
3" x 0.005" x 1/2"	1/4"	1"	20,000	20			662528 38960
3" x 0.014" x 1/2"	5/8"	1"	20,000	10		662528 39024	
4" x 0.014" x 5/8"-11	7/16"	7/8"	15,000	5		662528 39001	
6" x 0.014" x 1/2"-2	3/4"	1-1/8"	6,500	5	699366 53306		
6" x 0.014" x 5/8"	3/4"	1-1/8"	6,000	5		662528 39097	
6" x 0.014" x 5/8"	3/4"	1-7/16"	6,000	5		662528 39088	
8" x 0.014" x 5/8"	3/4"	1-9/16"	4,000	5		662528 39099	
8" x 0.014" x 5/8"	3/4"	2-1/16"	6,000	5		662528 39089	
8" x 0.014" x 1-1/4"	5/8"	1-1/2"	4,000	5		662528 38978	
Crimped Wire Wheels Brushes with Medium Face - With Arbor Hole							
4-1/2" x 0.014" x 5/8"-11		1"	13,000	6	662533 70278		
6" x 0.014" x 1/2"-2	1"	1-1/8"	6,500	5	699366 53324		
6" x 0.014" x 5/8"	1"	1-1/8"	6,500	5		662528 39098	
8" x 0.014" x 1/2"-2	1-1/16"	1-5/8"	4,500	5	699366 53326		
8" x 0.014" x 5/8"	1"	1-9/16"	4,000	5		662528 39100	
8" x 0.014" x 2"	1"	1-3/8"	4,500	5		662528 39025	
10" x 0.014" x 3/4"	1-9/16"	2-1/2"	3,600	1		662528 39102	
12" x 0.012" x 2"	2"	3-1/4"	3,600	1		662528 39006	



TIER:	GOOD	GOOD	GOOD
TRADENAME:	GEMINI	GEMINI	GEMINI
WIRE TYPE:	CARBON	STAINLESS	BRASS

SIZE	FACE WIDTH	TRIM LENGTH	MAX. RPM	STD. PKG.	PART #	PART #	PART #
Crimped Wire Wheels Brushes with Narrow Face - Shank Mounted							
3/4" x 0.005" x 3/16"	1/32"	3/16"	37,000	100	662528 39084		
1" x 0.005" x 1/8"	1/8"	5/16"	37,000	100			662528 39085
1-1/2" x 0.008" x 1/4"	1/4"	1/4"	25,000	20	662528 38962		
1-1/2" x 0.0118" x 1/4"	7/16"	3/8"	20,000	12	662528 38999		
1-1/2" x 0.014" x 1/4"	1/4"	1/4"	25,000	20	662528 38963		
2" x 0.006" x 1/4"	3/8"	1/2"	20,000	20	662528 39029		
2" x 0.008" x 1/4"	3/8"	7/16"	25,000	20	662528 38964		
2" x 0.0118" x 1/4"	3/8"	1/2"	20,000	20	662528 39030		
2" x 0.014" x 1/4"	3/8"	7/16"	25,000	12	662528 38965		
2" x 0.020" x 1/4"	3/8"	7/16"	25,000	20	662528 38966		
2-1/2" x 0.008" x 1/4"	7/16"	11/16"	25,000	10	662528 38967		
2-1/2" x 0.014" x 1/4"	7/16"	11/16"	25,000	12	662528 38968		
3" x 0.008" x 1/4"	1/2"	1"	20,000	10	662528 39092		
3" x 0.008" x 1/4"	7/16"	3/4"	25,000	10	662528 38969		
3" x 0.008" x 1/4"	7/16"	3/4"	25,000	12		662528 38972	
3" x 0.0118" x 1/4"	1/2"	1"	20,000	10	662528 39093		
3" x 0.014" x 1/4"	3/8"	1/4"	20,000	12	662528 39000		
3" x 0.014" x 1/4"	7/16"	3/4"	25,000	10	662528 38970		
3" x 0.014" x 1/4"	7/16"	3/4"	25,000	12		662528 38973	
3" x 0.014" x 1/4"	1/2"	1"	20,000	20		662528 39048	
3" x 0.020" x 1/4"	7/16"	3/4"	25,000	12	662528 38971		
3" x 0.020" x 1/4"	1/2"	1"	20,000	12	662528 39096		
4" x 0.014" x 1/4"	1/2"	1"	25,000	12	662528 38974		

Clean and deburr recessed areas or inside diameters of tubes and pipes to proper surface finish; rubber and plastic flash removal; paint and rust removal, and mold and tool polishing

EXPANDED OFFERING

END BRUSHES

- Used on CNC, Robotic, die grinders, and drill presses
- Twist knot wire end brushes for more aggressive cutting
- Crimped wire end brushes for lighter brushing action and contoured surfaces



Twist Knot Wire End Brush

Their added wire rigidity makes these brushes the choice for more aggressive cutting.

SIZE	TRIM LENGTH	MAX. RPM	STD. PKG.	TIER: BETTER TRADENAME: BLUEFIRE WIRE TYPE: CARBON PART #	GOOD GEMINI CARBON PART #	GOOD GEMINI STAINLESS PART #
Twist Knot Wire End Brushes – Shank-Mounted						
1/2" x 0.006" x 1/4"	1-1/8"	22,000	20		662528 38876	
1/2" x 0.014" x 1/4"	1-1/8"	22,000	20		662528 38877	
3/4" x 0.014" x 1/8"	7/8"	22,000	20		662528 39056	
3/4" x 0.014" x 1/4"	7/8"	22,000	20		662528 38879	
3/4" x 0.020" x 1/4"	7/8"	22,000	20		662528 39057	
3/4" x 0.020" x 1/4"	7/8"	22,000	10*	699366 53316		
3/4" x 0.020" x 1/4"	1"	22,000	20		662528 39116	662528 39118
3/4" x 0.020" x 1/4"	1-1/8"	22,000	20		662528 38878	
1" x 0.006" x 1/4"	1-1/8"	22,000	20			662528 38885
1" x 0.010" x 1/4"	1-1/8"	22,000	25			662528 38886
1" x 0.014" x 1/4"	7/8"	22,000	10*	699366 06279		
1" x 0.014" x 1/4"	1"	22,000	20		662528 38882	662528 38887
1" x 0.020" x 1/4"	7/8"	22,000	10*	699366 53310		
1" x 0.020" x 1/4"	1"	22,000	25		662528 39117	
1" x 0.020" x 1/4"	1"	22,000	20			662528 39119

* Bulk Packed Item



Insert Circular Flared Crimped Wire End Brush

The flared end configuration facilitates interior side cleaning and will not harm the bottom of the hole.



Encapsulated Hollow Center Crimped Wire End Brush

Their hollow centers effectively allow these brushes to clean around protrusions and also prevent the wires from meshing together. Encapsulating a portion of the wires' length shortens the free wires, increasing the wires' stiffness, thereby creating greater control of the brush.

TIER: **GOOD**
TRADENAME: **GEMINI**
WIRE TYPE: **CARBON**

SIZE	TRIM LENGTH	MAX. RPM	STD. PKG.	PART #
Circular Flared Crimped End Brushes – Shank-Mounted				
1-1/2" x 0.006" x 1/4"	7/8"	20,000	12	662528 39108
1-12" x 0.020" x 1/4"	1"	15,000	12	662528 38898
2" x 0.010" x 1/4"	1-1/8"	15,000	10	662528 38899
3" x 0.008" x 1/4"	7/8"	16,000	12	662528 39047

TIER: **GOOD**
TRADENAME: **GEMINI**
WIRE TYPE: **CARBON**

SIZE	TRIM LENGTH	MAX. RPM	STD. PKG.	PART #
Encapsulated Hollow Center Crimped Wire End Brush – Shank-Mounted				
1/2" x 0.010" x 1/4"	1"	18,000	20	662528 38907



Crimped Wire End Brushes

Designed to generate lighter brushing action and reach into contoured surfaces.



TIER:	BETTER	BETTER	GOOD	GOOD
TRADENAME:	BLUEFIRE	BLUEFIRE	GEMINI	GEMINI
WIRE TYPE:	CARBON	STAINLESS	CARBON	STAINLESS

SIZE	TRIM LENGTH	MAX. RPM	STD. PKG.	PART #	PART #	PART #	PART #
Crimped Wire End Brushes – Shank-Mounted							
1/4" x 0.005" x 1/8"	7/16"	37,000	12				66252839086
1/2" x 0.005" x 1/4"	1"	25,000	20				66252838902
1/2" x 0.006" x 1/4"	3/8"	25,000	20			66252839040	
1/2" x 0.006" x 1/4"	1"	25,000	20			66252838889	66252839043
1/2" x 0.010" x 1/4"	1"	25,000	20			66252838890	66252839044
1/2" x 0.014" x 1/4"	7/8"	25,000	20			66252839042	
1/2" x 0.014" x 1/4"	1"	25,000	20				66252838888
1/2" x 0.020" x 1/4"	1"	25,000	20			66252838891	
3/4" x 0.006" x 1/4"	1"	22,000	10*		69936606145		
3/4" x 0.010" x 1/4"	3/8"	22,000	20			66252839053	
3/4" x 0.014" x 1/4"	1"	22,000	10*	69936653317			
3/4" x 0.020" x 1/4"	7/8"	22,000	20			66252839112	
3/4" x 0.020" x 1/4"	1"	22,000	20			66252838892	
1" x 0.005" x 1/4"	1"	22,000	20				66252838896
1" x 0.006" x 1/4"	1"	22,000	25			66252839045	66252838838
1" x 0.010" x 1/4"	3/8"	22,000	20			66252839054	
1" x 0.010" x 1/4"	1"	22,000	25				66252839055
1" x 0.010" x 1/4"	1"	22,000	20				66252838897
1" x 0.014" x 1/4"	3/4"	20,000	20			66252839094	
1" x 0.014" x 1/4"	1"	22,000	20			66252839046	
1" x 0.020" x 1/4"	7/8"	22,000	20			66252839095	
1" x 0.020" x 1/4"	1"	22,000	20			66262839113	66252839115
1" x 0.020" x 1/4"	1-3/16"	20,000	10*	69936653309			

* Bulk Packed Item



Pencil Crimped Wire End Brush

These brushes are designed to clean counter bores, slots, blind holes, and small crevices; and light spot facing of aluminum or iron sand castings.



TIER:	GOOD
TRADENAME:	GEMINI
WIRE TYPE:	STAINLESS

SIZE	TRIM LENGTH	MAX. RPM	STD. PKG.	PART #
Pencil Crimped Wire End Brush – Shank-Mounted				
1/4" x 0.010" x 5/16"	3/8"	10,000	12	66252838906



Pilot End Brush

Specially designed to clean around rivet or bolt holes; the pilot guides the brushes.



TIER:	GOOD
TRADENAME:	GEMINI
WIRE TYPE:	CARBON

SIZE	TRIM LENGTH	MAX. RPM	STD. PKG.	PART #
Pilot Crimped Wire End Brush – Shank-Mounted				
1/2" x 0.004" x 1/4"	3/8"	25,000	20	66252838904

Cleaning, polishing, reaming, finishing and removing debris, burrs, rust, residues, and surface contaminants inside cylindrical items, including tubes, pipes, bottles, smooth-sided and threaded holes, and other industrial components



EXPANDED OFFERING

TUBE BRUSHES

- Use manually or fastened to portable or fixed machines (including drills, drill presses, and CNC machines)
- Available in single and double stem providing firm support when working internally
- A wide selection of shapes and filament variations to achieve the best results on many different applications

Single Stem, Single Spiral Tube Brush – With Eye Loop

These spiral brushes have a single layer of filament twisted around a stem wire to create additional strength and higher density fill brushes. This spiral configuration ensures consistent and constant abrasive contact with the tube. Formed eye loop at the end of the stem for convenient hand use.



TIER:	GOOD	GOOD	GOOD	GOOD
TRADENAME:	GEMINI	GEMINI	GEMINI	GEMINI
WIRE TYPE:	CARBON	STAINLESS	BRASS	NYLON

SIZE	TRIM LENGTH	MAX. RPM	STD. PKG.	PART #	PART #	PART #	PART #
Single Stem, Single Spiral Tube Brush – With Eye Loop							
3/16" x 0.003" x 0.094"	1-1/2"	2,000	12	662528 38822			
3/16" x 0.004" x 0.094"	5/64"	3,000	12	662528 38913			
1/4" x 0.003" x 0.094"	1-1/2"	2,000	12	662528 38823	662528 38824	662528 38840	
1/4" x 0.004" x 0.115"	5/64"	3,000	12	662528 38914			
1/4" x 0.006" x 0.115"	5/64"	3,000	12	662528 38915			
3/8" x 0.004" x 0.125"	2"	2,000	12		662528 38825	662528 38826	
3/8" x 0.004" x 0.132"	1/8"	3,000	12	662528 38916			
3/8" x 0.006" x 0.168"	1/8"	3,000	12	662528 38917			
3/8" x 0.006" x 0.168"	1-1/2"	3,000	12		662528 38946		
7/16" x 0.010" x 0.125"	7/64"	3,000	12				662528 38947
1/2" x 0.008" x 0.221"	9/64"	3,000	12	662528 38918			



Single Stem, Single Spiral Tube Brush

Similar to the single stem, single spiral tube brushes, but without eye loop. These brushes are ideal for complete internal cleaning and deburring of tubes and pipes and intricate area ensuring constant filament to surface contact.

TIER:	GOOD
TRADENAME:	GEMINI
WIRE TYPE:	CARBON

SIZE	TRIM LENGTH	MAX. RPM	STD. PKG.	PART #
Single Stem, Single Spiral Tube Brush				
7/16" x 0.005" x 0.125"	11/64"	3,000	12	662528 38911*
1" x 0.010" x 0.250"	2-1/2"	2,000	12	662528 39074*

* No eye loop



Double Stem, Single Spiral Tube Brush – with Stem

These brushes have two stem wires. This results in a brush with high strength and one with consistent and constant abrasive contact with the tube.

TIER:	GOOD	GOOD
TRADENAME:	GEMINI	GEMINI
WIRE TYPE:	BRASS	NYLON

SIZE	TRIM LENGTH	MAX. RPM	STD. PKG.	PART #	PART #
Double Stem, Single Spiral Tube Brush – With Stem					
1/2" x 0.006" x 0.188"	2"	2,000	12	662528 38839	
3/4" x 0.040" x 0.238"	3/8"	3,000	12		662528 38850



Power Burr, Single Spiral Tube Brush – with Stem

Power burr brushes are used to remove burrs resulting from previous operations. They are designed to remove burrs without creating secondary burrs or leaving sharp edges.



TIER:	GOOD	GOOD
TRADENAME:	GEMINI	GEMINI
WIRE TYPE:	CARBON	STAINLESS

SIZE	TRIM LENGTH	MAX. RPM	STD. PKG.	PART #	PART #
Power Burr Single Spiral Tube Brushes – With Stem					
1/4" x 0.004" x 0.125"	1"	2,000	12	662528 39061	662528 39081
3/8" x 0.004" x 0.125"	1"	2,000	12	662528 39062	662528 39050
3/8" x 0.005" x 0.125"	9/64"	2,000	12	662528 38910	
1/2" x 0.005" x 0.188"	1"	2,000	12	662528 39063	662528 39051
5/8" x 0.005" x 0.188"	1"	2,000	12	662528 39064	
3/4" x 0.006" x 0.219"	1"	2,000	12	662528 39065	662528 39082
1" x 0.005" x 0.125"	15/32"	2,000	12	662528 38912	
1" x 0.005" x 0.250"	1"	2,000	12	662528 39066	662528 39083



Double Stem, Double Spiral Tube Brush – With Stem

Brush filaments are twisted between two stem wires with two layers of filament bristles. Each layer is perpendicular to the other with a single stem wire in each of the brush's four sections. This configuration ensures consistent and constant abrasive contact with the tube.



TIER:	GOOD	GOOD
TRADENAME:	GEMINI	GEMINI
WIRE TYPE:	CARBON	STAINLESS

SIZE	BRUSH LENGTH	MAX. RPM	STD. PKG.	PART #	PART #
Double Stem, Double Spiral Tube Brush – With Stem					
3/8" x 0.060" x 0.125"	1-1/2"	2,000	12	662528 38827	
1/2" x 0.004" x 0.156"	2"	2,000	12	662528 38828	
1/2" x 0.004" x 0.187"	5/32"	3,000	12	662528 38919	
1/2" x 0.006" x 0.156"	2"	2,000	12	662528 39067	662528 38829
1/2" x 0.006" x 0.187"	5/32"	3,000	12	662528 38920	
5/8" x 0.005" x 0.187"	2"	2,000	12	662528 39068	
5/8" x 0.006" x 0.208"	2"	3,000	12	662528 38921	
5/8" x 0.008" x 0.219"	2"	2,000	12	662528 38831	
5/8" x 0.010" x 0.208"	13/64"	3,000	12	662528 38922	662528 38930
3/4" x 0.004" x 0.250"	2-1/2"	2,000	12	662528 39072	
3/4" x 0.006" x 0.238"	1/4"	3,000	12	662528 38923	
3/4" x 0.006" x 0.250"	2-1/2"	2,000	12	662528 39069	
3/4" x 0.006" x 0.250"	2-1/2"	2,000	12	662528 38832	
3/4" x 0.010" x 0.238"	1/4"	3,000	12	662528 38924	
7/8" x 0.004" x 0.250"	2-1/2"	2,000	12	662528 39073	
7/8" x 0.006" x 0.238"	2"	3,000	12	662528 38925	
7/8" x 0.006" x 0.250"	2-1/2"	2,000	12	662528 39070	
1" x 0.006" x 0.238"	25/64"	3,000	12	662528 38926	
1" x 0.006" x 0.250"	2-1/2"	2,000	12	662528 39071	
1" x 0.010" x 0.238"	2"	3,000	12	662528 38927	
1-1/4" x 0.004" x 0.250"	2-1/2"	2,000	12	662528 38833	
1-1/4" x 0.010" x 0.238"	1/2"	3,000	12	662528 38928	
2" x 0.010" x 0.238"	7/8"	3,000	12	662528 38929	



Encapsulated Double Stem, Double Spiral Tube Brush – With Stem

Encapsulating a portion of the wires' length shortens the free wires, increasing their stiffness, thereby creating greater control of the brush and a brush with the highest filament density and highest strength.



TIER:	GOOD
TRADENAME:	GEMINI
WIRE TYPE:	CARBON

SIZE	BRUSH LENGTH	MAX. RPM	STD. PKG.	PART #
Encapsulated Double Stem, Double Spiral Tube Brush – With Stem				
7/8" x 0.010" x 0.250"	2-1/4"	3,000	20	662528 38948



Flue Double Spiral Tube Brushes – With 1/4" x 2" NPT Pipe Nipple with Stem

These aggressive brushes are designed specifically for efficient pipe and boiler cleaning.



TIER: **GOOD**
TRADENAME: **GEMINI**
WIRE TYPE: **CARBON**

SIZE	TRIM ENTH	MAX. RPM	STD. PKG.	PART #
Flue Double Spiral Tube Brushes – With 1/4" x 2" NPT Pipe Nipple – With Stem				
3/4" x 0.010" x 0.238"	1/4"	3,000	12	662528 38931
1" x 0.010" x 0.313"	25/64"	3,000	12	662528 38932
1-1/4" x 0.012" x 0.313"	1/2"	3,000	12	662528 38933
1-3/4" x 0.012" x 0.313"	1/2"	3,000	12	662528 38934
2-1/4" x 0.012" x 0.313"	1/2"	3,000	12	662528 38935
2-3/4" x 0.014" x 0.313"	1/2"	3,000	12	662528 38936



Side-Action Tube (Burrite) Crimped Wire Tube Brushes – with Stem

Their dense side filament configuration creates increased bristle rigidity with minimal flexing, to aggressively clean the tube without changing its geometry or surface finish.



TIER: **GOOD**
TRADENAME: **GEMINI**
WIRE TYPE: **CARBON**

SIZE	TRIM ENTH	MAX. RPM	STD. PKG.	PART #
Side-Action (Burrite) Crimped Wire Tube Brush – With Stem				
1/4" x 0.003" x 0.094"	5/64"	3,000	12	662528 38908
5/16" x 0.005" x 0.094"	9/16"	2,000	10	662528 38834
5/8" x 0.005" x 0.125"	1/4"	3,000	12	662528 38909



Internal Finishing Crimped Wire Tube Brush

This square-trimmed crimped wire brush is used to clean internal surfaces in a single operation because it can simultaneously brush both the sides and bottom of a hole.



TIER: **GOOD**
TRADENAME: **GEMINI**
WIRE TYPE: **CARBON**

SIZE	TRIM LENGTH	FACE WIDTH	MAX. RPM	STD. PKG.	PART #
Internal Finishing Crimped Wire Tube Brushes – With Stem					
1-1/4" x 0.006" x 0.250"	1/2"	3/8"	4,500	10	662528 38945



Micro Abrasive Single Spiral Nylon Tube Brush – With Stem

Micro brushes are ideal for ultra-fine deburring, cleaning, polishing and finishing applications.



TIER: **GOOD**
TRADENAME: **GEMINI**
WIRE TYPE: **NYLON/AO 600 GRIT**

SIZE	TRIM LENGTH	MAX. RPM	STD. PKG.	PART #
Micro Abrasive Single Spiral Nylon Tube Brushes – With Stem				
3/16" x 0.012" x 0.093"	3/64"	3,000	12	662528 38853
0.190" x 0.012" x 0.087"	1"	1,500	12	662528 38814
0.260" x 0.012" x 0.115"	1"	1,500	12	662528 38815
0.325" x 0.012" x 0.115"	1"	1,500	12	662528 38816
0.325" x 0.012" x 0.121"	1"	3,000	12	662528 38854
33/64" x 0.012" x 0.175"	3/16"	3,000	12	662528 38855
33/64" x 0.022" x 0.175"	3/16"	3,000	12	662528 38851
1-1/64" x 0.022" x 0.255"	3/8"	3,000	12	662528 38852



TIER: **GOOD**
TRADENAME: **GEMINI**
WIRE TYPE: **NYLON**



Single Spiral Nylon Hand Tube Brush – With Eye Loop

These brushes are made with larger stem wires to give them the strength and rigidity needed for manual cleaning applications.

SIZE	TRIM LENGTH	MAX. RPM	STD. PKG.	PART #
Single Spiral Nylon Hand Tube Brush – With Eye Loop				
1/4" x 0.005" x 0.094"	9/64"	3,000	12	662528 38937
1/4" x 0.005" x 0.094"	2"	2,000	12	662528 38818
3/8" x 0.005" x 0.094"	2"	2,000	12	662528 38819
3/8" x 0.005" x 0.094"	9/64"	3,000	12	662528 38938
1/2" x 0.008" x 0.094"	3"	3,000	12	662528 38939
1/2" x 0.010" x 0.125"	3"	2,000	12	662528 38820
3/4" x 0.012" x 0.125"	21/64"	3,000	12	662528 38940
3/4" x 0.012" x 0.125"	3"	2,000	12	662528 38821
1" x 0.010" x 0.156"	25/64"	3,000	12	662528 38941
1" x 0.022" x 0.156"	2-1/2"	1,500	12	662528 38817
1-1/4" x 0.010" x 0.156"	1/2"	3,000	12	662528 38942
1-1/4" x 0.010" x 0.219"	1/2"	3,000	12	662528 38943
2" x 0.010" x 0.219"	1/2"	3,000	12	662528 38944

Hand Brushes

Hand brushes come in a variety of handle and filament shapes and styles for most hand scratching applications. They are favored by many in removing scale, surface coatings, or removing weld debris.

For steel/stainless



HAND BRUSHES

- Long handle and shoe handle brushes are made with a high-carbon, brass-coated steel; stainless steel is made with a 304L stainless
- Plastic ergonomic handle scratch brush with curved face to access hard-to-reach places. Crimped wire for longer life. Wires are wrapped up and around the metal post so they never come out.
- Narrow brush allows access into tight areas and slots



TIER: **BETTER** **BETTER** **BETTER** **BETTER** **BETTER** **BETTER** **BETTER**
TRADENAME: **BLUEFIRE** **BLUEFIRE** **BLUEFIRE** **BLUEFIRE** **BLUEFIRE** **BLUEFIRE** **BLUEFIRE**
WIRE TYPE: **CARBON** **STAINLESS** **CARBON** **STAINLESS** **CARBON** **STAINLESS** **STAINLESS**

SIZE	TRIM LENGTH	MAX. RPM	STD. PKG.	PART #	PART #	PART #	PART #	PART #	PART #	PART #
Hand Scratch Brushes – With Handle										
3" x 19"	1-3/16"	–	12	662528 33948	662528 33950					
4" x 16"	1-3/16"	–	12			662528 33949	662528 33951			
5" x 10"	1-1/8"	–	24					662528 33954	662528 33953	
3" x 7"	1/2"	–	36							662528 33952





complementing our
ABRASIVES PORTFOLIO

To help you finish the job, Norton tapes, masking products and micro-fiber cloths let you one-stop shop. Our goal is to get it finished faster, easier and with less hassle of multiple vendors and invoices.



Norton masking tapes feature a special solvent-based, rubber adhesive system and strong holding properties. These tapes adhere and release cleanly while providing clean edges on a variety of flat, contoured, and irregular surfaces. Norton sheetings provides superior solvent, paint, and contaminant penetration resistance. Use them during paint preparation and anywhere you need work area protection. Tear-resistant properties allow movement without ripping.

Products:

Attachment Tape, Masking Tape, Masking Film, Sheeting, Masking Paper

Machine Used:



HAND
APPLICATION

Best choice for general industrial application replacing permanent fastening systems (rivets, welds and liquid adhesives)

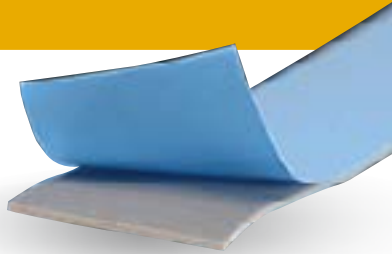

NORTON ATTACHMENT TAPE

- Double sided, gray foam tape used in bonding performance for many interior and exterior commercial applications.
- Incredible conformability and application stretching
- Weather degradation resistance from UV and high temperatures
- Outstanding static shear adhesion
- Excellent performance in T-Block and dynamic shear
- Durable adhesion at elevated temperature
- High shock and stress absorption

DESCRIPTION	THICKNESS	1/4" x 108"	1/2" x 108"	3/4" x 108"	7/8" X 108"	1" X 108"	1-1/2" X 108"
Blue Liner							
Gray Double-Sided Acrylic Foam Tape	.043" (1.1mm)	636425 06044	636425 06045	636425 06046	636425 06047	662611 75888	662611 51041
Rolls/Case		40/1	20/1	10/1	10/1	10/1	6/1
DESCRIPTION	THICKNESS	1/4" X 20 YDS	1/2" X 20 YDS	7/8" X 20 YDS			
Red Liner							
Gray Double-Sided Acrylic Foam Tape	.043" (1.1mm)	636425 05620	636425 05621	-	636425 05622	-	-
Rolls/Case		12/1	12/1		12/1		
Adhesion Promoter							
Brush-Top Can - 220ml		636415 05623					
Rolls/Case		12					

Technical Data

Performance tests are run using standard test procedures. The values presented are typical values and should not be used for specification purposes.

THICKNESS in. (mm)	90° PEEL ADHESION ¹ (3-DAY DWELL) lb/in (N/cm)				T-BLOCK ² lb/in (N/cm)	DYNAMIC SHEAR ³ lb/in (N/cm)	STATIC SHEAR ⁴ 7 Days /1 kg	SERVICE TEMPERATURE
	GLASS	ALUMINUM	S/S	PMMA	ALUMINUM	S/S	S/S	
.043 (1.1)	20 (35)	33 (57)	20 (34)	17 (29)	100 (29)	48 (33)	Pass and Exceeds	-35°F to 200°F (-35°C to 93°C)

¹ Based on ASTM D3330 ² Based on ASTM D897 ³ Based on ASTM D1002 ⁴ Based on ASTM D3654

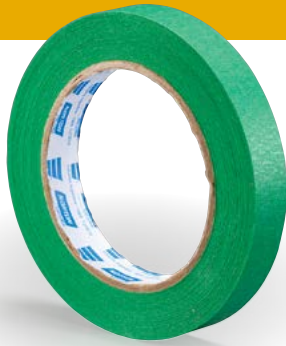

Best choice for high temperature applications including high-heat curing

PREMIUM HIGH TEMPERATURE GREEN MASKING TAPE

- Ideal for conditions that include exposure to the high-heat curing temperatures found in automobile, truck, bus, and other transportation assembly operations, as well as aerospace manufacturing applications
- Superior strength and excellent cornering ability
- Ideal for high temperatures; can be effectively used up to 250°F (120°C) for 30 minutes without any significant loss of properties or adhesive transfer
- Can also be used up to 175°F (80°C) for one hour without leaving residues after exposure
- UV resistance for 2 days
- Can be exposed to wet sanding without adhesive transfer



Better choice for medium-temperature applications

MEDIUM TEMPERATURE MASKING TAPE

- Designed for excellent performance in moderate-temperature applications
- Can be used up to 220 °F (105°C) for 30 minutes and 175°F (80°C) for one hour without any significant loss of properties; removes cleanly without leaving residues after exposure



Good general-purpose choice

GENERAL PURPOSE MASKING TAPE

- Ideal for splicing, holding, packaging, and general purpose masking
- Good adhesion onto a wide variety of surfaces
- Good performance up to 175°F (80°C) for one hour without any significant loss of properties; removes cleanly without leaving residues after exposure



It delivers very sharp, clean edges on smooth- to moderately-textured surfaces

BLUE CORE 14-DAY TAPE

- Our paint masking tape has a specially formulated adhesive system that provides optimum low- to medium-tack adhesion and clean removal from a variety of surfaces, for up to 14 days
- Blue Core masking tape can be used indoors or out
- The crepe paper backing is designed to enable easy unrolling and to minimize slivering



Better choice for fine line masking needs

FINE LINE BLUE MASKING TAPE

- Masking color separation on plastic (TPO and RIM) automotive fascia, trim, and finished metals in high-temperature OEM bake cycles, aircraft and clean room paint operations
- Thermally-stabilized PVC backing with a rubber-based pressure sensitive adhesive
- Highly conformable, waterproof, and solvent-resistant
- Can be used from 40°F (4.4°C) to 280°F (138°C) without any significant loss of properties; removes cleanly without leaving residues after exposure



TIER:	BEST	BETTER	GOOD	GOOD	BETTER
	PREMIUM HIGH TEMP GREEN	MEDIUM TEMPERATURE	GENERAL PURPOSE	BLUECORE 14 DAY TRAPE	FINE LINE BLUE
CAP CODE	C995	C988	C903		
BACKING	Crepe paper	Crepe paper	Crepe paper	Fine Crepe Paper	PVC
ADHESIVE	Solvent-based rubber	Solvent-based rubber	Solvent-based rubber	Synthetic Rubber	Natural Rubber
TENSILE STRENGTH	3.0 kgf/cm, 29 N/10mm	2.6 kgf/cm, 25 N/10mm	2.5 kgf/cm, 25 N/10mm	23 lbs/in (101 N/25mm)	15 lb/in. of width, 65.6N/25mm
ELONGATION AT BREAK	8.50%	7.0%	7.0%	11%	150%
PEEL ADHESION AT 180° ANGLE	400 gf/cm, 3.9 N/10mm	370 gf/cm, 3.6 N/10mm	300 gf/cm, 2.9 N/10mm		23 oz./in. of width, 6.3N/25mm
TOTAL THICKNESS	120 microns (0.120mm)	110 microns (0.110mm)	100 microns (0.100mm)	5.5 mils (0.14mm)	5.4mils (.14mm)
TEMPERATURE	250°F (120°C) for 30 min. 175°F (80°C) for 1 hour	220°F (105°C) for 30 min. 175°F (80°C) for 1 hour	175°F (80°C) for 1 hour		40°F (4.4°C) to 280°F (138°C)

METRIC	IMPERIAL	ROLLS/CASE	PART #
Premium High-Temp Green Tape			
12mm x 50m	0.47 inches x 54.7 yards	72	699573 10320
18mm x 50m	0.71 inches x 54.7 yards	48	666233 09768
24mm x 50m	0.94 inches x 54.7 yards	36	666233 27752
36mm x 50m	1.42 inches x 54.7 yards	24	699573 10323
48mm x 50m	1.89 inches x 54.7 yards	20	666233 09770
72mm x 50m	2.83 inches x 54.7 yards	12	699573 10325
100mm x 50m	3.93 inches x 54.7 yards	8	699573 45060
200mm x 50m	7.87 inches x 54.7 yards	4	699573 45063
Medium-Temperature Tape			
12mm x 50m	0.47 inches x 54.7 yards	72	699573 10326
18mm x 50m	0.71 inches x 54.7 yards	48	055395 44799
24mm x 50m	0.94 inches x 54.7 yards	36	699573 10327
36mm x 50m	1.42 inches x 54.7 yards	24	662610 70829
48mm x 50m	1.89 inches x 54.7 yards	20	055395 44800
General-Purpose Tape			
18mm x 40m	0.71 inches x 43.7 yards	48	662611 03314
24mm x 40m	0.94 inches x 43.7 yards	36	662611 03315
36mm x 40m	1.42 inches x 43.7 yards	24	699573 45064
48mm x 40m	1.89 inches x 43.7 yards	20	662611 03317
72mm x 40m	2.83 inches x 43.7 yards	12	699573 45065
Blue Core 14-Day Tape			
36mm x 54.8m	1-1/2" x 60 yards	24	076607 21954
48mm x 54.8m	2" x 60 yards	24	076607 21955
<i>Bulk packed as individual rolls</i>			
Fine Line Blue Tape			
3.17mm x 32.9m	1/8 inches x 36 yards	360*	662611 82688
6.35mm x 32.9m	1/4 inches x 36 yards	168*	662611 82686
12.7mm x 32.9m	1/2 inches x 36 yards	78*	662611 82685

* Master case quantity



Good masking choice for multiple transportation applications

ANCHOR BRAND HAND MASK

- IPG's Anchor® brand Hand Mask is a pre-folded, high density polyethylene masking film designed for multiple transportation applications
- The thick and durable 12 micron film is corona treated to resist overspray flaking during paint applications
- This special film is designed with a reinforced top edge formulated to prevent the underlying film from sticking
- Designed to work with multiple hand dispensers and the 1" core fits most masking machines.

	54.8M (60YD) ROLL	90' ROLL	180' ROLL
WIDTH	ROLL HEIGHT	PART #	PART #
24"	5.35"	–	087143 00214
48"	8.78"	–	087143 00216
72"	9.57"	087143 00217	–
99"	13.0"	087143 00218	–
<i>Case</i>		12	12

Good multi-purpose choice provides durability and excellent protection



HIGH DENSITY SHEETING (HDPE)

Our multi-purpose painters' plastic sheeting protects virtually any area from sanding dust and paint overspray with ease – even after repositioning. Our High Density Plastic Sheeting (HDPE) is designed to be one of the strongest most durable products on the market.

- Resists tearing and solvent bleed-through with light weight .31 mil High Density Polyethylene plastic (HDPE)
- Holds in place as it clings to horizontal or vertical surfaces during taping with its natural electrostatic properties
- Attracts and holds sanding debris for a dust-free finish
- Drapes easily over furniture

SIZE	THICKNESS	COLOR	QTY/PACK	PACKS/CASE	PART #
9' x 400'	.31 mil	Clear	1	1	076607 68142
12' x 400'	.31 mil	Clear	1	1	076607 68143

Also available by the pallet.

Good choice for all of your masking needs



GREEN MASKING PAPER

- Made from recyclable virgin wood pulp fiber, recycled fiber, or a combination of the two
- These fibers provide a machine finish kraft paper with non-contaminating cleanliness, sustainability, and superior strength properties
- Smooth paper surface ensures no fiber linting leading to rework
- Flexible, easy to work with and shape; conforms to uneven surfaces

SIZE	3"	6"	12"	18"	20"	24"	36"	46"	69"
DESCRIPTION	PART #	PART #	PART #	PART #	PART #	PART #	PART #	PART #	PART #
(750' boxed)	699573 13146	699573 13147	699573 13148	699573 13149	699573 13151	699573 13152	699573 13153	699573 13154	699573 13155
<i>Logs/Case</i>	12/1	6/1	3/1	2/1	1/1	1/1	1/1	1/1	1/1

Order per number of logs:

Each "log" is a total of 36" wide – comprised of the width of the individual roll in inches x the number of rolls/box, e.g. 6" roll x 6 rolls in the box = one 36" wide log; 12" roll x 3 rolls in the box = one 36" wide log, etc., except for the 24" and 36" rolls which are single logs.



A micro-fiber is a single fiber with a thickness less than a human hair that has been split 16 times and woven into various products. The surface area of a micro-fiber product is increased over 15 times, creating millions of spaces between the fibers which trap dirt, grime or liquids, making this product one of the most absorbent materials. These cloths save you labor, time, and additional costs of multiple cleaning products and chemicals.

Applications:

Cleaning Cloth: Used for general-purpose wet or dry applications. Works best when sprayed with a light water mist to deep clean.

Dry Tack Cloth: This woven terry cloth has a low profile to resist snagging and help pick up embedded debris.

Polishing Cloth: Streak-free cleaning of mirrors, optical lens and highly-polished items.

Other:

Color-coded for easy identification

Cleaning Cloth: Blue

Dry Tack Cloth: Red

Polishing Cloth: Yellow

Machine Used:



HAND
APPLICATION

TECH TIP

- Use these micro-fiber cloths dry for general cleaning
- To remove spills, stains or grime, lightly dampen the cloth for best results
- All micro-fiber cloths can be used with or without chemicals
- Micro-fiber cloths can be washed up to 300+ times without losing cleaning and trapping abilities
- Clean often for best results



It is the user's responsibility to refer to and comply with all safety regulations.



DESCRIPTION	COLOR	STD. PKG.	PART #
Micro-Fiber Cleaning Cloth 16" x 16"	Blue	20	076607 05300
Micro-Fiber Dry Tack Cloth 16" x 16"	Red	20	076607 04025
Micro-Fiber Polishing Cloth 16" x 16"	Yellow	20	076607 05301

100 Years of Safety Leadership

The year 2016 marked the 100-year anniversary of the leadership of the former Norton Company in the creation of the first ever safety code for abrasives.

In 1916, following more than a decade of safety research, advocacy, and leadership by the Norton Company (now Norton | Saint-Gobain Abrasives), "The Safety Code for the Use and Care of Abrasive Wheels" was published. This 13-page booklet, containing an unprecedented set of safety device recommendations and procedures, was the spark that changed the entire future of the abrasives industry.

In the 1970s, this code received the ultimate endorsement when selected by OSHA as the basis of new federal regulations concerning abrasive wheel machinery. Today, the ever-evolving "Safety Requirements for the Use, Care and Protection of Abrasive Wheels" (commonly known as the ANSI B7.1 standard) continues to mirror the latest technologies and remains the global authoritative abrasives safety standard.

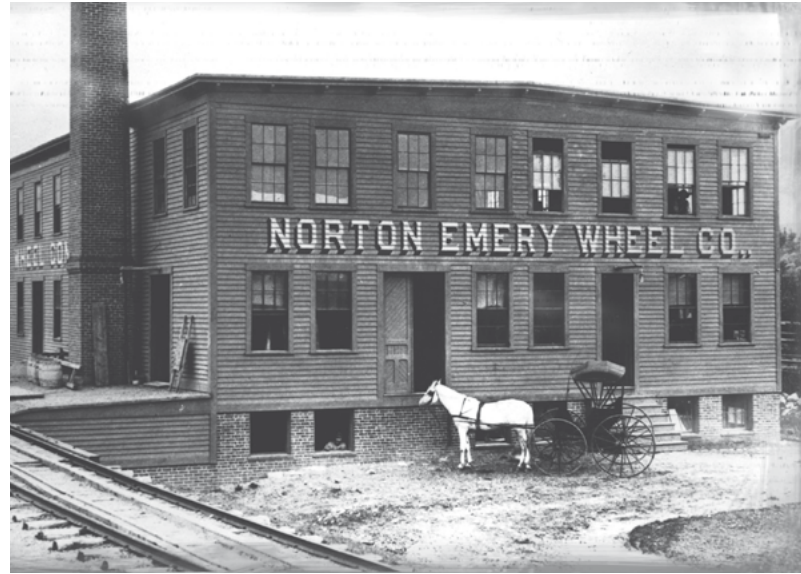

Breakages/Personal Injury

In the event of on-machine breakage of Norton abrasive products, call your local Norton distributor immediately. Whether involving personal injury or not, the abrasive user should leave the equipment and other evidence undisturbed until a Norton sales representative has been notified and conducts an investigation. Prompt action on the part of abrasive users, distributor, and Norton sales personnel is important to ensure swift determination of the breakage cause and to guard against recurrence.



It is the user's responsibility to refer to and comply with ANSI B7.1 and B7.7 – Contact us for a free copy.



Abrasive Safety References



Safety Poster

(Form # 7868-English, 7868-French, 7868-Spanish)











UAMA Approved Safety Icons

The UAMA has approved a new set of standardized icons to be used throughout the Abrasive industry to convey safety information to the users. Below are the approved icon types and their definitions.

ICON TYPES	EXAMPLE
<p>Safety Icon: A pictorial whose purpose is to relay safety related information to the user.</p>	
<p>Hazard Alert Icon: This type of safety icon conveys information primarily related to the nature of a hazard. It contains a graphical depiction of the hazard drawn within a yellow equilateral triangle.</p>	
<p>Prohibition Icon: This type of safety icon conveys actions that should not be taken. It consists of a red circular band with a 45° diagonal red band from upper left to lower right. The icon contains a black depiction of what should not be done within the red band on a white background.</p>	
<p>Mandatory Action Icon: This type of safety icon conveys actions that should be taken to avoid hazards. It consists of a white image within a solid blue or black circular surround shape.</p>	
<p>Proper Machine Use Icon: This type of icon is designed to show the use of the wheel on a proper machine. The icon can be a bit more realistic to show components such as a safety guard and an auxiliary handle. The recommended angle of use may also be depicted.</p>	

ICON	MEANING	ICON	MEANING
	Improper use may break wheel and cause serious injury or death.		Always use wheel guard for angle grinder.
	No side grinding. Cutting only.		Always use wheel guard for non-portable machine.
	No side grinding. Cutting only		Protect your eyes.
	No cutting. Side grinding only.		Protect your face.
	No cutting. Side grinding only, grouped icon.		Protect your lungs against dust.

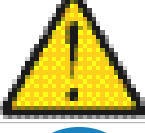
UAMA Approved Safety Icons *continued*

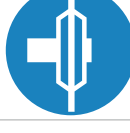
ICON	MEANING	ICON	MEANING
	Do not use a damaged wheel.		Protect your hearing.
	Do not use on High Speed Gas Saws.		Protect your eyes and face.
	Do not use on Angle Grinders.		Protect your eyes and hearing. Combined icon.
	Do not use on die grinders		Protect your eyes, ears and lungs.
	Warning alert symbol.		Protect your hands.
	Read OSHA and ANSI B7.1.		Use matched diameter, relieved flanges.



Coated Abrasive Do's and Don'ts

Coated Abrasive Disc and Wheel Safety Do's and Don'ts

Warning







Improper use may cause wheel breakage and serious injury. Comply with ANSI B7.7, OSHA and safety guide provided with the package. Always follow all manufacturer's recommended procedures and safety instructions. Never exceed tool manufacturer's maximum operating speed.

Exposure to DUST generated from workpiece and/or abrasive materials can result in lung damage and/or other physical injury. Use dust capture or local exhaust as stated in the SDS. Wear government-approved respiratory protection and eye and skin protection. Failure to follow this warning can result in serious lung damage and/or physical injury.

Lead Poisoning can develop as a result of inhalation and/or ingestion of the dust generated from sanding any product containing lead, including lead based paint. Lead Poisoning is an illness which can permanently damage the body's physical, neurological and/or reproductive systems. Care must be taken to avoid the inhalation and/or ingestion of dust containing lead

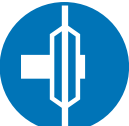
	DO'S	DON'TS
INSPECT / STORAGE / SPEED  	<ul style="list-style-type: none"> • DO read all manuals, operating instructions and warnings • DO read SDS for the disc/wheel and the work-piece material. • DO check all products for damage before mounting. • DO make sure the machine speed does not exceed the speed marked on the package or back up pad. • DO store products prior to use at 35 – 50% relative humidity and 60 – 80°F. 	<ul style="list-style-type: none"> • DON'T use products that have been dropped or damaged. • DON'T use on machines that do not show a MAX RPM speed.
MOUNT / GUARD  	<ul style="list-style-type: none"> • DO use the wheel guard provided with machine. Position it so it protects the operator and covers the wheel. • DO use recommended back up pad or mandrel for the product. • DO run wheels ONLY in direction of directional arrow stenciled on wheel and in core (except Unified Wheels, which can be run in either direction). • DO run discs/wheels in a protected area for one minute before grinding. 	<ul style="list-style-type: none"> • DON'T remove or modify any guard. ALWAYS use a proper guard. • DON'T use excessive pressure when mounting a wheel. Tighten enough only to hold wheel firmly.
PROTECT  	<ul style="list-style-type: none"> • DO wear ANSI Z87+ safety glasses and face protection, if required. • DO wear safety shoes, arm guards, leather gloves and aprons. • DO employ dust controls and/or protective measures appropriate to the material being ground. 	<ul style="list-style-type: none"> • DON'T use products near bystanders if they are not wearing protective equipment.
OPERATE 	<ul style="list-style-type: none"> • DO support work-piece firmly. • DO hold machine firmly in two hands. • DO stop the equipment at once if chattering or vibration occurs during use. Determine cause of the problem and correct before remounting. • DO ease the disc into the work piece at a 5-10o angle to the work piece surface. 	<ul style="list-style-type: none"> • DON'T allow untrained people to handle, store, mount or use discs/wheels. • DON'T twist, jam or bend any wheel. • DON'T force or bump wheel so that the tool motor stalls. • DON'T use discs/wheels in the presence of combustible materials. • DON'T use disc/wheel for applications other than for which they were designed. Refer to ANSI B7.7.

Portable Grinding Safety Do's and Don'ts

	DO'S	DON'TS
INSPECT / SPEED  	<ul style="list-style-type: none"> • DO read all manuals, operating instructions and warnings. • DO read SDS for the wheel and workpiece material. • DO check all wheels for cracks or other damage before mounting. • DO make sure the machine does not exceed the maximum operating speed marked on the wheel. • DO store according to ANSI B7.1. 	<ul style="list-style-type: none"> • DON'T use wheels that have been dropped or damaged. • DON'T use on grinders that do not show a MAX RPM.
MOUNT / GUARD  	<ul style="list-style-type: none"> • DO use an ANSI B7.1 wheel guard. Position it so it protects the operator. • DO be sure wheel hole or threads fit machine properly and that the flanges are clean, flat, undamaged and the proper type. • DO run wheel in a protected area for one minute before grinding. 	<ul style="list-style-type: none"> • DON'T remove or modify any guard. ALWAYS use a proper guard. • DON'T alter a wheel or force it on to the spindle. • DON'T mount more than one wheel on an arbor. • DON'T use excessive pressure when mounting a wheel. Tighten enough only to hold wheel firmly.
PROTECT  	<ul style="list-style-type: none"> • DO wear ANSI Z87+ safety glasses and face protection, if required. • DO wear gloves, hearing and body protection. • DO employ dust controls and/or protective measures appropriate to the material being ground. • DO comply with OSHA regulations 29 CFR 1926.1153 when working on materials containing crystalline silica such as concrete. 	<ul style="list-style-type: none"> • DON'T use wheels near bystanders if they are not wearing protective equipment.
OPERATE 	<ul style="list-style-type: none"> • DO support work-piece firmly. • DO hold grinder firmly with two hands. 	<ul style="list-style-type: none"> • DON'T allow untrained people to handle, store, mount or use wheels. • DON'T use grinding wheels or cutting wheels on pistol grip air Sanders. • DON'T use any cutting wheel for grinding nor apply side pressure on a cutting wheel. Use for CUTTING ONLY. • DON'T use a cutting wheel to cut curves. Cut in straight lines only. • DON'T twist, bend or jam any wheel. • DON'T force or bump wheel so that the tool motor slows or stalls. • DON'T use wheels in the presence of combustible materials. • DON'T use wheels for applications other than for which they were designed.

Dangerous Pairing: Die Grinders and Cut-off Wheels

While die grinders and portable cut-off tools may look similar, they are by no means interchangeable. Several crucial differences exist between the two handheld machines.

GUARD

Cut-off wheels must be used on guarded machines for the safety of the operator and bystanders.

SPEED

Cut-off wheels must be used at or below their maximum operating speed, marked clearly on the side of the wheel. Excessive speed can result in breakage and serious personal injury.

Die grinders often operate above 25,000 rpm and therefore are too fast for abrasive wheels. The speed hazard is increased by the absence of a guard. Portable cut-off tools, however, rotate at speeds compatible with the abrasive wheels for which they are designed. And, their guards prevent use of an oversize wheel.

MOUNTING

Cut-off wheels must be mounted between proper flanges, as described in the national safety standard for abrasive wheels, ANSI B7.1. Die grinders make use of a collet for mounting

Portable cut-off tools use flanges for mounting, flanges designed according to the ANSI B7.1 safety standard.

Now that you have learned the three crucial differences between die grinders and portable cut-off tools – GUARD, SPEED and MOUNTING – be on watch for the dangerous pairing of cut-off wheels and die grinders, and warn your friends and colleagues of the same.

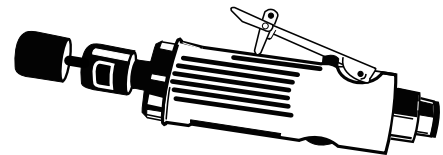

Die Grinder

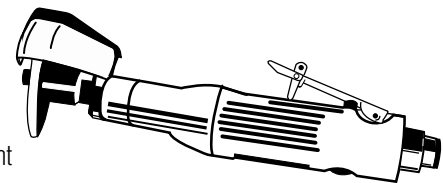

Portable Cut-off Tool

Starting a Grinding Wheel / Ring Test



Pistol Grip Air Sander

A Deadly Equation

Pistol Grip Air Sander + Grinding Wheel = Certain Injury!

- Never use a high-speed air sander as a portable grinder
- Use only sanding discs specifically designed for sanders
- Because the speed of these sanders far exceeds the maximum rated speeds for grinding wheels, a potentially lethal wheel breakage might occur

Starting a Grinding Wheel

ANSI's Procedure for Starting an Abrasive Wheel

This article is designed to remind users of the proper procedure when starting a machine with a new abrasive wheel mounted on it, starting a machine after the machine and wheel have been stored for a period of time, or remounting a wheel. ANSI B7.1 requires the following procedure when starting a newly mounted grinding wheel.

9.8 Starting the Wheel (Requirements)

All abrasive wheels shall be run at operating speeds with the safety guard in place or in a protected enclosure for at least one minute before applying work. During this time no one shall stand in front of or in line with the wheel. (See section 4, for safety guard requirements.) This provision shall apply each time one of the following conditions occur: a) a new wheel has been mounted; or b) a used wheel has been remounted.

E 9.8 Starting the Wheel (Explanatory Information)

An abrasive wheel may be damaged in shipment or storage, or the wheel may be subjected to improper, excessive stresses during mounting. Wheels which have been damaged or are under excessive stress, are likely to fracture within the first minute of rotation at operating speed. While this procedure is most important at the time when an abrasive wheel is mounted or remounted, damage may also occur to a wheel during a shut down of the machine on which it is mounted. The user should evaluate the circumstances and length of machine shut down to determine additional times that the operating rule should be followed.

Improper wheel mounting is a major cause of wheel breakages. Always use proper mounting procedures as outlined in ANSI B7.1, machine manufacturer's instructions and those supplied with the abrasive wheel. Be safe, know and follow the rules!

How to Perform a Ring Test on a Grinding Wheel

One method of grinding wheel inspection is called ring testing. OSHA, ANSI and the grinding wheel manufacturers require this method of grinding wheel inspection. It must be performed BEFORE the wheel is mounted on a grinding machine. Ring testing depends on the damping characteristics of a cracked wheel to alter the sound emitted when the wheel is tapped lightly. It is subject to interpretation by the inspector and is primarily applicable to vitrified bonded wheels. To perform the ring test, wheels should be tapped gently with a light nonmetallic implement, such as the handle of a screw driver for light wheels, or a wooden mallet for heavier wheels.

- Tap wheels about 45 degrees each side of the vertical line and about 1" or 2" from the periphery. Rotate the wheel 45 degrees and repeat the test.
- Large and thick wheels may be given the ring test by striking the wheel on the periphery rather than the side of the wheel.
- A sound and undamaged wheel will give a clear tone. If cracked, there will be a dead sound and not a clear ring and the wheel should not be used.
- Wheels must be dry and free of sawdust when applying the ring test, otherwise the sound may be deadened. The ring test is not applicable to certain wheels because of their size, shape or composition.



Conversion Table – Wheel Speeds

REVOLUTIONS PER MINUTE FOR VARIOUS DIAMETERS OF GRINDING WHEELS TO GIVE SURFACE SPEED IN FEET PER MINUTE AS INDICATED (FOR WHEEL MARKING PURPOSES THE CALCULATED RPM FIGURES LISTED BELOW ARE ROUNDED OFF TO THE NEXT 5)

Surface Speed in Feet Per Minute (SFPM)

Diameter of Wheel in Inches	Revolutions Per Minute (RPM)															
	6,500	7,000	7,500	8,000	8,500	9,000	9,500	10,000	12,000	12,500	14,200	16,000	16,500	17,000	19,685	20,000
1	24,828	26,737	28,647	30,558	32,467	34,377	36,287	38,196	45,836	47,745	54,240	61,116	63,025	64,935	75,190	76,395
2	12,414	13,368	14,328	15,278	16,238	17,188	18,143	19,098	22,918	23,875	27,120	30,558	31,510	32,465	37,595	38,195
3	8,276	8,913	9,549	10,186	10,822	11,459	12,096	12,732	15,278	15,915	18,080	20,372	21,010	21,645	25,065	25,465
4	6,207	6,685	7,162	7,640	8,116	8,595	9,072	9,549	11,459	11,940	13,560	15,278	15,755	16,235	18,800	19,100
5	4,966	5,348	5,730	6,112	6,494	6,876	7,258	7,640	9,168	9,550	10,850	12,224	12,605	12,985	15,040	15,280
6	4,138	4,456	4,775	5,092	5,411	5,729	6,048	6,366	7,639	7,960	9,040	10,186	10,505	10,820	12,530	12,730
7	3,547	3,820	4,092	4,366	4,638	4,911	5,183	5,456	6,548	6,820	7,750	8,732	9,005	9,275	10,740	10,915
8	3,103	3,342	3,580	3,820	4,058	4,297	4,535	4,775	5,729	5,970	6,780	7,640	7,880	8,115	9,400	9,550
9	2,758	2,970	3,182	3,396	3,606	3,820	4,032	4,244	5,092	5,305	6,030	6,792	7,000	7,215	8,355	8,490
10	2,483	2,674	2,865	3,056	3,247	3,438	3,629	3,820	4,584	4,775	5,425	6,112	6,300	6,495	7,520	7,640
12	2,069	2,228	2,386	2,546	2,705	2,864	3,023	3,183	3,820	3,980	4,520	5,092	5,250	5,410	6,265	6,365
14	1,773	1,910	2,046	2,182	2,319	2,455	2,592	2,728	3,274	3,410	3,875	4,366	4,500	4,640	5,370	5,455
16	1,552	1,672	1,791	1,910	2,029	2,149	2,268	2,387	2,865	2,985	3,390	3,820	3,940	4,060	4,700	4,775
18	1,379	1,485	1,591	1,698	1,803	1,910	2,016	2,122	2,546	2,655	3,015	3,396	3,500	3,605	4,175	4,245
20	1,241	1,337	1,432	1,528	1,623	1,719	1,814	1,910	2,292	2,390	2,715	3,056	3,150	3,245	3,760	3,820
22	1,128	1,215	1,302	1,388	1,476	1,562	1,649	1,736	2,084	2,170	2,465	2,776	2,865	2,950	3,420	3,470
24	1,034	1,115	1,194	1,274	1,353	1,433	1,512	1,591	1,910	1,990	2,260	2,546	2,625	2,705	3,135	3,185
26	955	1,028	1,101	1,176	1,248	1,322	1,395	1,468	1,762	1,840	2,090	2,352	2,425	2,495	2,890	2,940
28	887	955	1,023	1,092	1,159	1,228	1,296	1,364	1,637	1,705	1,940	2,182	2,250	2,320	2,685	2,730
30	828	891	955	1,018	1,082	1,146	1,210	1,274	1,528	1,595	1,810	2,056	2,100	2,165	2,505	2,545
32	776	836	895	954	1,014	1,074	1,134	1,194	1,432	1,495	1,695	1,910	1,970	2,030	2,350	2,385
34	730	786	843	898	955	1,011	1,067	1,124	1,348	1,405	1,595	1,796	1,855	1,910	2,210	2,245
36	690	742	795	848	902	954	1,007	1,061	1,273	1,330	1,510	1,698	1,750	1,805	2,090	2,120
38	653	704	754	804	854	904	955	1,006	1,206	1,260	1,430	1,608	1,660	1,710	1,980	2,010
40	620	669	716	764	812	860	908	956	1,146	1,195	1,355	1,528	1,575	1,625	1,880	1,910
42	591	636	682	732	775	818	863	908	1,090	1,140	1,295	1,464	1,500	1,545	1,790	1,820

For intermediate diameters not listed use the formula listed in Section 1.2.10 of ANSI B7.1

SFPM = .262 x wheel diameter in inches x RPM.

To convert meters per second (m/s) to SFPM: m/s x 196.85 = SFPM

To convert SFPM to m/s: SFPM/196.85 = m/s.

To convert RPM to SFPM: Wheel Diameter x RPM x 0.262 = SFPM

Silica and What You Need to Know

Background and Health impacts

Silica (SiO₂) is one of the most common minerals in the earth's crust. Glass, beach sand, silicone and granite are all "silica" materials. Products containing silica have been used for thousands of years in building and is a key ingredient in many products we use every day. There are two forms of silica; crystalline and non-crystalline. Crystalline silica is a mineral that occurs in several forms. Quartz, the most common form, is a component of sand, stone, rock concrete, brick, block and mortar. Non-crystalline silica is found in glass, silicon carbide and silicone.

When rocks containing crystalline silica are cut, crushed, ground, drill or used in similar industrial processes, dust particles are produced. These particles are very fine, at least 100 times smaller than ordinary beach sand – known as respirable crystalline silica or RCS. Inhaling very small or respirable crystalline silica particles is most hazardous and may cause multiple diseases such as silicosis, followed in severe cases by lung cancer.

Who is at risk from exposure to crystalline silica?

It is estimated that 2.3 million workers are exposed to crystalline silica on the job. The majority of the workers, about 2 million, are in the construction industry. The hazard exists when specific activities create respirable dust that is released into the air.

The New OSHA Standard

OSHA's recently implemented silica standards for Construction "29 CFR 1926.1153" and General Industry "29 CFR 1910.1053" suggests procedures applicable for work in these environments. This new standard affects all activities that generate silica dust on a jobsite. Trades involving brick, stone, concrete and other materials that are difficult to replace must comply with the standard. This is a change around "process", not specific products.

Impacts on Industry

Industries affected by this regulation include Construction, Glass manufacturing, Pottery products, Structural clay products, Concrete products, Foundries, Cut stone and Stone products, Railroads, Refractory products and Asphalt products manufacturing to name a few. Always read the Safety Data Sheet for the workpiece and abrasive before use.



Product Warranty

WARRANTY – Saint-Gobain Abrasives warrants the products in this catalog to be free from defects in material or workmanship for a period of one year from the date of purchase. Saint-Gobain Abrasives' sole obligation under this warranty shall be to repair or replace, at Saint-Gobain Abrasives' option, any product which is non-conforming provided any such product failure was not caused by a subsequent modification of the product, misuse or a failure to follow any applicable instructions for the product.

EXCEPT FOR THE FOREGOING, SAINT-GOBAIN ABRASIVES EXPRESSLY DISCLAIMS ALL OTHER GUARANTIES AND/OR WARRANTIES, EXPRESS OR IMPLIED, INCLUDING THE WARRANTIES OF MERCHANTABILITY AND FITNESS FOR A PARTICULAR PURPOSE.

Liability Limitation

SAINT-GOBAIN'S LIABILITY FOR ANY LOSS OR DAMAGE ARISING OUT OF OR RESULTING FROM THE USE OF THE PRODUCT SHALL NOT EXCEED THE PURCHASE PRICE THEREOF, REGARDLESS OF WHETHER SUCH LIABILITY ARISES IN CONTRACT, TORT (INCLUDING WITHOUT LIMITATION NEGLIGENCE OR STRICT LIABILITY), OR OTHERWISE, AND IN NO EVENT SHALL SAINT-GOBAIN BE LIABLE FOR INDIRECT, SPECIAL, INCIDENTAL OR CONSEQUENTIAL DAMAGES OF ANY KIND. NO REPRESENTATIVE OF SAINT-GOBAIN, NOR ANY OF SAINT-GOBAIN'S DISTRIBUTORS OR DEALERS, IS AUTHORIZED TO MODIFY THIS WARRANTY OR ISSUE ANY WARRANTY REGARDING THE PRODUCTS IN THIS CATALOG.

Product Quality Complaints

All product quality complaints should be submitted to your local Norton Distributor.

Trademarks

All trademarks used in these pages are trademarks of Saint-Gobain Abrasives unless otherwise indicated.

A275 Original Performance™	Fast Cut™	NorGrip®	Reshaping the World of Precision Grinding™
Abrasive Connection Express®	FastTrack™	NorKut™	Reshaping Your World®
Adalox®	FlexDrum™	NorPor®	RightCut®
Alundum®	FlexEdge™	Norton®	Sand-O-Flex™
AVOS®	Foundry X™	Norton Clipper™	Screen-Bak®
Aztec®	Furioso™	Norton Design® (Parallelogram)	SoftTouch®
Bear-Tex®	Gemini®	Norton Design® (Triple Stripe Design)	Speed-Change™
Because Right Choices Matter™	G-Force™	Norton SG®	Speed-Grip®
Black Ice®	India®	NorZon®	Speed-Lok®
Blaze®	JobPack™	NorZon Plus®	Stick & Sand®
Blue-Bak™	Liquid Ice®	Onyx™	Targa®
Blue-Core™	Long Life™	Pacesetter™	Thin Flex™
BlueFire®	Merit®	Paradigm®	TufBak®
BPR™	MeshPower™	Plyweld®	U-Dex-It™
Century45®	Metalite®	ProSand™	Univel®
Charger™	Mini-Dex™	Pure Ice™	USB™
Classic™	MSL®	QuadroFlex™	Vitrium3®
Clean Bond®	Multi-Air Cyclonic®	Quantum™	Vortex®
Clipper®	Multi-Oilstone®	Rail Cut™	Winter®
Crystolon®	MultiSand™	Rapid Blend®	and others
DiaLast™	The Muscle Behind The Machine®	Rapid Cut™	
Dry Ice®	NEX™	Rapid Finish®	
Duo®	No-Fil®	Rapid Prep™	
Duo Evo™	NORaX®	Rapid Strip®	
Durite®	NorBide®	Red Heat®	



NORTON

SAINT-GOBAIN

The world leader in abrasives for more than 130 years, the Norton brand offers the widest portfolio of grinding, cutting, blending, finishing and polishing solutions which deliver the highest productivity and cost performance ratio in both stock and made-to-order solutions.

NORTON

SAINT-GOBAIN

clipper

For 80 years, the Clipper brand has been a trusted equipment source on the jobsite. Now, the Norton Clipper brand will cut a new path for future growth with an industry-leading line of diamond products, abrasives, and light equipment to tackle even the toughest construction environment.

NORTON

SAINT-GOBAIN

MERIT

The Norton Merit brand offers a comprehensive portfolio of specialty abrasive products for offhand and portable power tools. From quick-change discs and cartridge rolls to flap wheels - feel the power behind Norton Merit.

BEST

Highest Productivity Lowest Total Cost

BETTER

Excellent Blend of Performance and Price

GOOD

Consistent Performance – Low Initial Price



NORTON

DIAMOND AND cBN SUPERABRASIVES

EFFECTIVE 2014

STANDARD PRODUCTS CATALOG



TABLE OF CONTENTS

TECHNICAL INFORMATION

PSP – Process Solutions Program	3
ANSI Wheel Shape Identification System	6
Wheel Shape Index	7
Product Identification System	9
Competitive Cross Reference	11
Mounting, Truing and Dressing Guide	62
Tech Tips	138
Troubleshooting Guide	138
Material Hardness Scale	138
Decimal and Metric Equivalents of Fractions	139
Expected Surface Finish by Grit Size	139
Recommended Wheel Speeds	139
RPM/SFPM Conversion Table	140
Safety PPE and Safe Operating Practices	141

NORTON STOCK PRODUCTS

Wheel Shape Index	7
General Information	12
How to Select Stock Diamond & cBN Wheels	13
Starting Recommendation Guide	15
Norton Stock Products	17
B105 Diamond Wheels	21
Aztec III cBN Wheels	22
Aztec .007 cBN Wheels	22

NORTON B99 EXPRESS MADE-TO-ORDER RESIN WHEELS

Wheel Shape Index	7
General Information	25
How to Select B99 Express Products	26
B99 Express Made-To-Order Diamond & cBN Resin Products	28

NORTON CNC WHEELS

Wheel Shape Index	7
Product Identification System	9
General Information	54
Diamond Wheels for CNC Machines	55
cBN Wheels for CNC Machines	57
CNC Express Made-To-Order Wheels	59

NORTON OFF-LINE TRUING WHEELS

Conventional Truing Wheels	60
Micro Dressing Wheel	60

NORTON BRAKE-CONTROLLED TRUING DEVICES

Brake-Controlled Truing Devices	61
Mounting, Truing, and Dressing Guide	62

NORTON DRESSING STICKS

Norton Dressing Sticks	63
------------------------	-----------

NORTON ROTARY DIAMOND DRESSING TOOLS

General Information	65
Dressing Spindles	65
Form Rolls (Reverse Plated and Infiltrated)	66
Dressing Discs (infiltrated, BPR and IDW)	68

NORTON STATIONARY DIAMOND DRESSING TOOLS

General Information	71-74, 109
Single Point Tools	75
Toolroom Tools	82
Multi-Point (Grit) Tools	85
Blade Tools	93
Form Tools	96
Cluster Tools	103
Accessories	104
Tool Recommendations by Machine Type	105

NORTON/WINTER FLIESTEN STATIONARY DIAMOND DRESSING TOOLS

General Information	111
Furioso Plate and Shank Tools	114
Fliesen Plates	116
Fliesen Shank Tools	118
Triangle Insert Dressing Tools	119
Diamond Truing Pad	119
Tools by Machine Type Index	120
Competitive Cross Reference	123

NORTON ELECTROPLATED TOOLS AND WHEELS

General Information	125
Diamond and cBN Mounted Points and Mandrels	127
Diamond Tapered Honers for Drawing Dies	130
Diamond Micro Drills and Routers	131
Diamond and cBN Mounted Contour Tools	132
Diamond Wheels	133
Diamond Files	133
Diamond Drills	135
Diamond Saw Blades	136

NORTON DIAMOND LAPPING COMPOUND

Water and Oil Soluble Compounds	137
---------------------------------	------------

GENERAL INFORMATION

Placing an Order	4
Product Tiering	4
UPC # to Page Index	142

NORTON TRADEMARKS

All trademarks used in these pages are trademarks of Saint-Gobain Abrasives, unless otherwise indicated.

Aztec®	Norton®	USB™
Furioso™	Norton Quantum™ (NQ)	U-Dex-It™
G-Force™	Norton SG®	Univel®
MSL®	Pacesetter®	Winter®
Mini-Dex™	Paradigm®	And Others
Multi-Cut™	Targa® (TG)	

MAXIMIZING PRODUCTIVITY



Norton Stock Wheels

250+ USA-made, ISO-certified stock diamond and cBN resin products available now.



Norton B99 Express Made-to-Order Resin Line

65,000+ made-to-order diamond and cBN resin products: 25 wheel shapes, with 2 week (and less!) lead-times for 12" and less diameter wheels (14" wheels and larger are available with standard lead-times).



CNC Wheels

Norton Paradigm, G-Force, Univel, Resin, CNC Express. Our line of CNC diamond and cBN wheels are pre-engineered to satisfy customer requirements from high production cutting tool manufacturing to precision resharpening.



Norton and Fliesen Stationary Truing and Dressing Products

For all your stationary truing and dressing needs: the market's broadest line of stationary diamond tools, brake controlled truing devices, and dressing sticks.



Norton Electroplated Tools and Wheels

Our extensive stock diamond and cBN electroplated offering (mounted points, drills, routers, contour tools, wheels, files, and saw blades) has been engineered to meet the diverse demands of traditional and emerging tool and die, ceramic, and composite applications.



Norton Diamond Lapping Compound

Oil and water soluble compounds for mirror finishes and close-tolerance performance.



REDUCING COSTS

On average, abrasives and cutting tools only account for about 3% of total manufacturing budgets. Norton superabrasive products optimized with Norton's proprietary PSP (process solutions program) helps to optimize your total cost and improve your productivity.

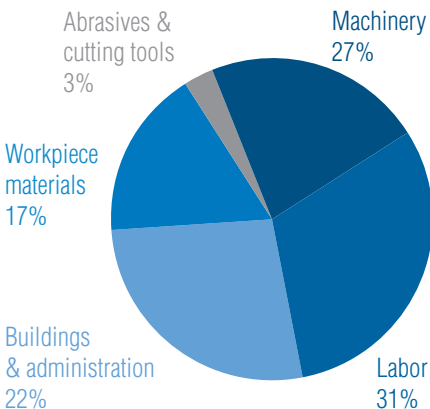

Decreasing the price of abrasives

A 30% price reduction will **only** reduce costs per part by **1%**.

Increasing the life of abrasives

Even a 50% increase in product life will **only** reduce costs per part by **1%**.

Increase overall productivity through PSP

With a 20% decrease in cycle time per part, there will be a **reduced total cost** per part of **more than 15%**.



PLACING AN ORDER

To enable your authorized distributor to fill your order quickly and accurately, please be sure to include your billing and shipping address, purchase order number, and the following product information:

- **UPC Number**
- **The Wheel Shape** – see the “Wheel Shape Index”
- **Product Dimensions** – such as **Diameter x Thickness x Hole for a wheel, or Thickness x Width x Length for a dressing stick, etc.**
- **Complete Specification** – example: **ASD120-R100B99-1/8 (abrasive, grit, grade, concentration, bond, abrasive depth) for a wheel, or 38A220-HVBE for a dressing stick, or NS2M6 for a dressing tool, etc.**
- **Blueprint Number** – if available
- **Quantity Ordered**

NORTON PRODUCT TIERING CONCEPT

Norton offers the industry’s widest selection of products at three separate value levels to meet your exact grinding needs. Norton abrasives are classified in BEST (gold), BETTER (silver), and GOOD (black) performance/price tiers to help you choose the right product for your specific application every time.

To help you compare and contrast the performance and price levels within each Norton line, the product availability charts highlight the product tier level with a color-coded “tiering bar”.

Remember, premium Norton products – BEST and BETTER tiers – will always be the best overall value for your money. While initial unit cost is more, BEST and BETTER products will yield longer life and better performance, resulting in lowest total grinding cost.

BEST

BEST PERFORMANCE

- Represents products that are unmatched in the industry and provide the lowest total grinding cost for the application.
- In many cases, these products are proprietary and only available from Norton.

BETTER

PREMIUM PERFORMANCE

- Represents superior performing products for the user who requires a high level of productivity and low total abrasive cost.

GOOD

EXCELLENT PERFORMANCE, QUALITY AND VALUE

- Represents a value for the user who wants Norton quality products with consistent performance and very competitive prices.

PRODUCT WARRANTY

WARRANTY – Saint-Gobain Abrasives Inc. (SGA) warrants the products in this catalog to be free from defects in material or workmanship for a period of one year from the date of purchase. SGA’s sole obligation under this warranty shall be to repair or replace, at SGA’s option, any product which is non-conforming provided any such product failure was not caused by a subsequent modification of the product, misuse or a failure to follow any applicable instructions for the product.

EXCEPT FOR THE FOREGOING, SGA EXPRESSLY DISCLAIMS ALL OTHER GUARANTIES AND/OR WARRANTIES, EXPRESS OR IMPLIED, INCLUDING THE WARRANTIES OF MERCHANTABILITY AND FITNESS FOR A PARTICULAR PURPOSE.

LIABILITY LIMITATION

SGA’S LIABILITY FOR ANY LOSS OR DAMAGE ARISING OUT OF OR RESULTING FROM THE USE OF THE PRODUCT SHALL NOT EXCEED THE PURCHASE PRICE THEREOF, REGARDLESS OF WHETHER SUCH LIABILITY ARISES IN CONTRACT, TORT (INCLUDING WITHOUT LIMITATION NEGLIGENCE OR STRICT LIABILITY), OR OTHERWISE, AND IN NO EVENT SHALL SGA BE LIABLE FOR INDIRECT, SPECIAL, INCIDENTAL OR CONSEQUENTIAL DAMAGES OF ANY KIND. NO REPRESENTATIVE OF SGA, NOR ANY OF SGA’S DISTRIBUTORS OR DEALERS, IS AUTHORIZED TO MODIFY THIS WARRANTY OR ISSUE ANY WARRANTY REGARDING THE PRODUCTS IN THIS CATALOG.

BREAKAGES/PERSONAL INJURY

In the event of on-machine breakage of Norton abrasive products, call your local Norton Distributor immediately. Whether involving personal injury or not, the abrasive user should leave the equipment and other evidence undisturbed until a Norton Sales Representative has been notified and conducts an investigation. Prompt action on the part of abrasive users, Distributors and Norton sales personnel is important to ensure swift determination of the breakage cause and to guard against recurrence.



ANSI WHEEL SHAPE IDENTIFICATION SYSTEM

The American Standard Code employs a series of numbers and letters to designate the shape of a diamond wheel. Its use involves four simple steps shown at right.

In this example, the complete wheel shape number would read:

6A2C

COURTESY OF ANSI

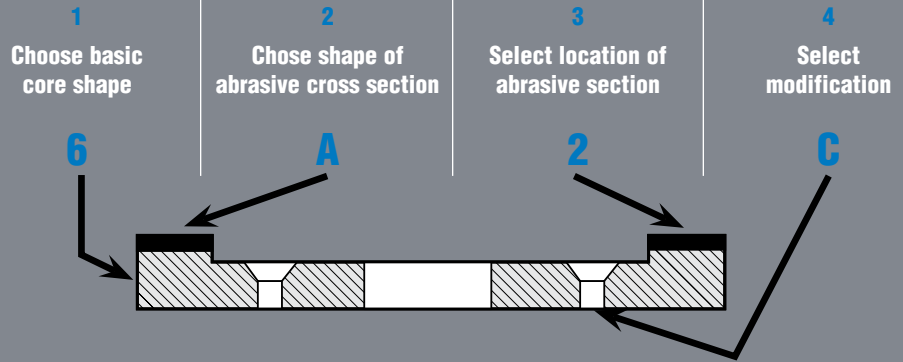

1. BASIC CORE SHAPES AND MARKS

1	2	3	4	6
9	11	12	14	15

2. ABRASIVE CROSS SECTIONS AND MARKS

A	AH	B	C	CH	D	DD	E	EE	F	FF	G	H
J	K	L	LL	M	P	Q	QQ	S	U	V	Y	









3. LOCATION OF ABRASIVE SECTION AND MARKS

1 - PERIPHERY	2 - SIDE	3 - BOTH SIDES	4 - INSIDE BEVEL OR ARC	5 - OUTSIDE BEVEL OR ARC	6 - PART OF PERIPHERY	7 - PART OF SIDE	8 - THROUGHOUT	9 - CORNER	10 - ANNULAR

4. POPULAR MODIFICATIONS AND MARKS

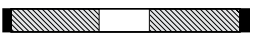
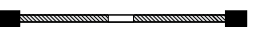
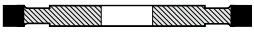
B - DRILL AND COUNTERBORE	C - DRILL AND COUNTERSINK	H - PLAIN HOLE	K - KEYWAY	M - HOLES PLAIN AND THREADED	T - THREADED HOLES	P - RELIEVED ONE SIDE
Q - ABRASIVE SECTION INSERTED	R - RELIEVED TWO SIDES	S - ABRASIVE SECTION SEGMENTED	SS - ABRASIVE SECTION SEGMENTED AND SLOTTED	V - ABRASIVE SECTION INVERTED	W - STEMMED	Y - ABRASIVE SECTION INSERTED AND INVERTED

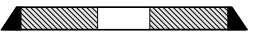
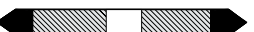
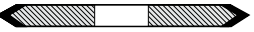
WHEEL SHAPE INDEX

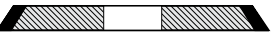
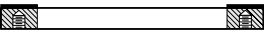
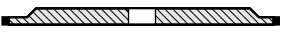
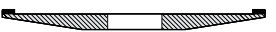
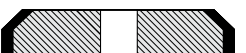
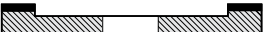
ILLUSTRATION  DIAMOND OR cBN MATERIAL	WHEEL SHAPE	AVAILABILITY		
		NORTON STOCK WHEELS	NORTON B99 EXPRESS MADE-TO-ORDER RESIN WHEELS	CNC WHEELS: NORTON UNIVEL, NORTON G-FORCE NORTON/WINTER NORTON
	DW	PAGE 17		
	HH1	PAGE 17		
	HH2	PAGE 17		
	1A1	PAGES 17 – 18	PAGE 28	PAGES 55, 57
	1A1R	PAGE 19	PAGE 29	
	1A1RN			PAGES 55, 57
	1A8		PAGE 29	
	1B1		PAGE 30	PAGES 55, 57
	1E1		PAGE 30	
	1EE1		PAGE 30	
	1F1		PAGE 31	
	1FF1		PAGE 31	
	1V1	PAGE 19	PAGE 32	PAGES 55 – 57
	2A2T		PAGE 33	
	3A1		PAGE 34	
	4A2 & 4A2P	PAGE 20	PAGE 35	
	4Y1		PAGE 36	
	6A2		PAGE 37	PAGES 56, 57

WHEEL SHAPE INDEX

ILLUSTRATION ■ DIAMOND OR cBN MATERIAL	WHEEL SHAPE	AVAILABILITY		
		NORTON STOCK	NORTON B99 EXPRESS MTO RESIN	CNC WHEELS: NORTON UNIVEL NORTON G-FORCE NORTON/WINTER NORTON
	6A2C	PAGE 20	PAGES 38 – 39	
	6A2H	PAGE 20		
	6A9		PAGE 40	
	11A2	PAGE 20	PAGE 41	PAGES 56, 58
	11V5			PAGES 56, 58
	11V9	PAGES 21 – 22	PAGES 42 – 44	PAGES 56, 58
	12A2	PAGE 23	PAGES 44 – 45	
	12V9	PAGE 23	PAGES 46 – 47	PAGES 56, 58
	14A1		PAGE 48	
	14F1			PAGE 63
	15A2		PAGE 49	
	15V4		PAGE 50	
	15V9	PAGE 23	PAGES 51 – 52	

NORTON DIAMOND PRODUCT IDENTIFICATION SYSTEM / USAGE INFORMATION

ASD 120 – R 75 B99 1/8

ABRASIVE TYPE	GRIT SIZE	GRADE	CONCENTRATION	BOND	ABRASIVE DEPTH
ASD <ul style="list-style-type: none"> Used with B99 and B105 bonds Armored Durable Versatile Wet or dry Carbide/steel operations 	<ul style="list-style-type: none"> 100, 100S – Roughing 120 – Roughing/cutting-off 150 – Combined roughing and finishing 180 – Improving finish 220, 320 & 400 – Finishing only 10/20 mic 6/12 mic 	Resin Bond R – Norton standard N – Free cutting Metal Bond N – Norton standard Vitrified Bond P – Norton standard R – Most durable	50 <ul style="list-style-type: none"> Most economical For broad area of contact 75 <ul style="list-style-type: none"> Norton standard Freer cutting than 100 Dry grinding with ASD 100 <ul style="list-style-type: none"> Very durable For flood coolants Use with 220 grit or finer Use for cutting-off 115 <ul style="list-style-type: none"> For CNC grinding machines 125 <ul style="list-style-type: none"> Form holding For high volume, high pressure coolant, precision applications on high-speed tool steels 	B99 <ul style="list-style-type: none"> Resin bond Wet or dry Tool making; resharpening B105 <ul style="list-style-type: none"> Premium resin bond Advanced heat-reducing bond Dry; reconditioning B610 and B80 <ul style="list-style-type: none"> For CNC grinding machines M99 <ul style="list-style-type: none"> Metal bond 1A1R cut-off Glass and ceramics MSL <ul style="list-style-type: none"> Metal single layer Type 6A2C only Dry Offhand reconditioning/finishing carbide V99 <ul style="list-style-type: none"> Vitrified bond Offhand finishing of carbide tools Plunge grinding 	1/16" 1/8" 1/4" 9/32" 3/8" 1/2" (New!) 3/4" Solid
CD <ul style="list-style-type: none"> Used with B99 bond 					
D <ul style="list-style-type: none"> Used with B99 bond Micron-sized diamond; finishing 					
M3D <ul style="list-style-type: none"> Used with M99 bond 					
M4D <ul style="list-style-type: none"> Used with M99 bond Armored Durable; for non-metallics 					
RMD <ul style="list-style-type: none"> Used with V99 bond 					
SD <ul style="list-style-type: none"> Used with B99 and V99 bonds Norton standard Wet or dry Free cutting Low horsepower (3/4 hp or less) 					

NORTON CBN PRODUCT IDENTIFICATION SYSTEM / USAGE INFORMATION

CB 120 – T B99 1/8

ABRASIVE TYPE	GRIT SIZE	GRADE	BOND	ABRASIVE DEPTH
CB – cubic Boron Nitride <ul style="list-style-type: none"> Used with B99 bond Armored Wet or dry 	<ul style="list-style-type: none"> 100 – Roughing 120 – Roughing/cutting-off 150 – Combined roughing and finishing 180 – Improving finish 220, 320, 400 – For finishing only 	Q <ul style="list-style-type: none"> Approx. 50 concentration Type 6A2 Broad area of contact T <ul style="list-style-type: none"> Approx. 75 concentration Norton standard First choice Lower horsepower Broad area of contact Dry grinding Resharpening applications W <ul style="list-style-type: none"> Approx. 100 concentration Most durable High volume coolant Flute polishing Surface grinding Cylindrical grinding 	B99 <ul style="list-style-type: none"> Resin bond Wet or dry BXD3037 and WBB & WBE <ul style="list-style-type: none"> For CNC grinding machines Aztec III <ul style="list-style-type: none"> Premium resin bond Dry Tool resharpening Aztec .007 <ul style="list-style-type: none"> Premium resin bond Dry Increased feed rates Heavy stock removal Heavier cuts 	1/16" 1/8" 1/4" 1/2" (New!) Solid
BAM & BX – cubic Boron Nitride <ul style="list-style-type: none"> For CNC grinding machines 				

WINTER DIAMOND PRODUCT IDENTIFICATION SYSTEM / USAGE INFORMATION

D 220 – C 100 K+ 925 Y A

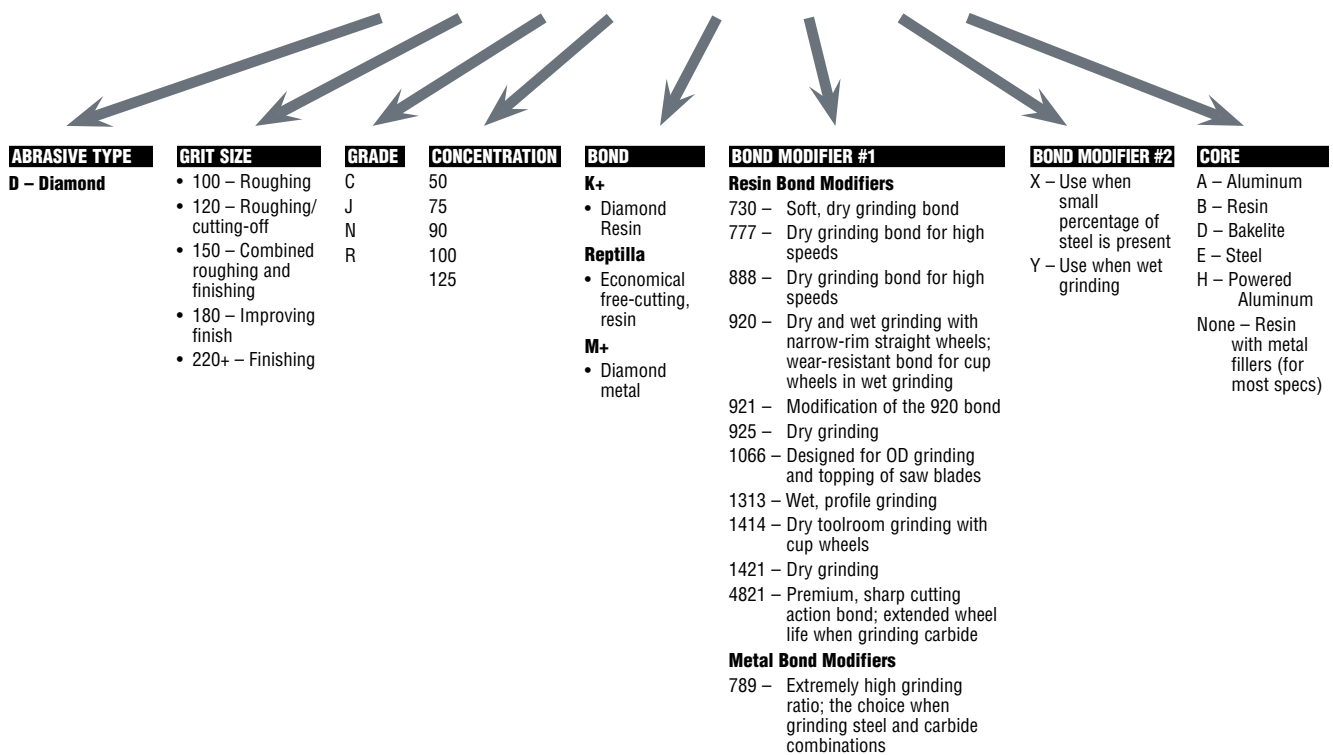

WINTER CBN PRODUCT IDENTIFICATION SYSTEM / USAGE INFORMATION

B 220 – V 240 KSS 920 Y A

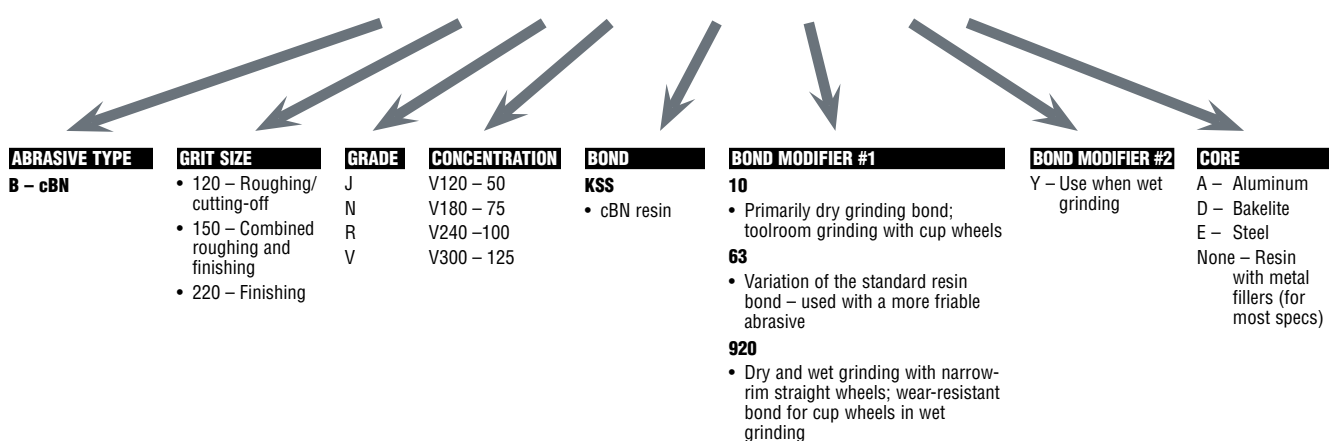

COMPETITIVE CROSS REFERENCE

	NORTON										
	ABRASIVES				BONDS						
	RESIN DIAMOND ASD	RESIN DIAMOND SD	METAL DIAMOND M4D	RESIN/VITRIFIED cBN CB	RESIN DIAMOND B99/B99E	RESIN DIAMOND B105	METAL DIAMOND M99	VITRIFIED DIAMOND V99	RESIN cBN B99/B99E	RESIN cBN B99EF	RESIN cBN AZTEC
3M / General Industrial Diamond / Diamond Productions, Inc	CGD, ND	GD, D, MD		CB	PS			V		BC	
Abrasive Technology	SN	S		cBN	B		M		B		
Accurate Diamond Tool	NCD	D, MD		BN	B		M				
Citco	5SD, 6SD	SD	MD	CB	B43, B52		M		B26	C3	
Engis	NMD	D, MD		cBN, CB							
Noritake				CBC		BX4			BD/B38		BX4
Radiac / US Diamond	NCD, WD, 1WD, MDC	D, MD	MD4C	B, CB, BZ	B7Z, BB, B5, B56, BN		M, MF	V	BZ, BN		
Regal Diamond				B, BB	BJ						
Superabrasives, Inc.	MDN	D, MD		B					B82	B5	
Tyrolit / Wickman / Bay State / Cincinnati	SDM, XDL, XDN, D, 7D, CMD	SD, D, 6D, MD	1D	5B, 1BN, BN, BM	BD, BC, BX33, B52, B6	Amigo	MI, MSS, MB		B72, B56, BG, B7	BXU8	Amigo
Wendt / Slip Naxos / Winterthur	SDK			B, BXW					RN	RR	

	NORTON POLYIMIDE				NORTON/WINTER			
	ABRASIVES		BONDS		ABRASIVES		BONDS	
	DIAMOND AD	cBN BX	DIAMOND AND cBN UNIVEL	DIAMOND AND cBN G-FORCE	DIAMOND D	cBN B	RESIN DIAMOND K+888	RESIN cBN K+920
3M / General Industrial Diamond / Diamond Productions, Inc	D	CB	BP	BPP	CGD, ND	CB	PS	
Abrasive Technology					SN	cBN	B	B
Accurate Diamond Tool					NCD	BN	B	
Citco	SD	CB	P	C5	5SD	CB	B43, B52	B26
Engis					NMD	cBN, CB		
Noritake						CBC		BD/B38
Radiac /					NCD, WD, 1WD, MDC	B, CB, BZ	B7Z, BB, B5, B56, BN	BZ, BN
Regal Diamond						B, BB	BJ	
Superabrasives, Inc.					MDN	B		B82
Tyrolit / Wickman / Bay State / Cincinnati					SDM, XDL, XDN, D, 7D, CMD	5B, 1BN, BN, BM	BD, BC, BX33, B52, B6	B72, BG56, BG, B7
Wendt / Slip Naxos / Winterthur					SDK	B, BXW		RN

The “99” line of quality stock Diamond and cBN (cubic Boron Nitride) grinding products includes resin, vitrified, metal and MS� (metal single layer) bonds. Premium, high performance resin bond diamond and cBN wheels are also available.

TYPICAL APPLICATIONS

Norton B99 Diamond Wheels

- Sharpening cemented carbide cutting tools
- Cutting off carbide rod
- Grinding or cutting off non-ferrous materials such as ceramics or glass
- Surface grinding dies
- O.D. grinding spray coatings

Norton B99 cBN Wheels

- Sharpening high-speed (M2, D2, T15, etc.) steel cutting tools
- Surface and ID grinding hardened steel die components
- Precision grinding steel parts Rc 50 or harder



DIAMOND WHEELS

FEATURES	BENEFITS
■ High quality synthetic diamond	■ High material removal rates; longer wheel life versus conventional green silicon carbide wheels
■ Pre-engineered resin bond – B99	■ Free cutting; superior form holding; efficient wet or dry
■ Premium, heavy-duty resin bond – B105	■ Ideal for dry toolroom reconditioning applications
■ Metal bond – M99	■ Ideal for 1A1R cut-off applications and grinding glass or ceramic materials
■ MS� (metal single layer) diamond	■ Fast stock removal, cool cutting; excellent for dry offhand finishing of carbide tools; no wheel dressing required
■ Vitrified bond – V99	■ Most durable under high grinding forces; excellent for wet, offhand finishing of carbide tools

cBN WHEELS

FEATURES	BENEFITS
■ cBN (cubic Boron Nitride) abrasive material is second in hardness to diamond	■ Easily cuts difficult-to-grind steel parts Rc 50 or harder
■ Pre-engineered resin bond – B99	■ Highly wear resistant and thermally stable
■ Premium Aztec III resin bond	■ Free cutting, superior form holding
■ Premium Aztec .007 resin bond	■ Most efficient for dry tool resharpening
	■ Most efficient for dry tool resharpening where heavy stock removal is desired

TECHtip

- Truing makes the wheel concentric with the spindle.
- Dressing opens the wheel’s cutting face.
- Always true and dress diamond and cBN wheels prior to use.
- Diamond and cBN wheels with grit sizes 100 - 180 can be trued with a Brake Controlled Truing Device.
- Refer to the “Mounting, Truing and Dressing Guide” for more information.



It is the user’s responsibility to refer to and comply with ANSI B7.1

HOW TO SELECT NORTON STOCK DIAMOND WHEELS

SELECT

SHAPE		Use the “Wheel Shape Index” to determine shape and availability.
WHEEL DIMENSIONS	D x T x H Select Diameter x Thickness x Hole from the availability tables. Use blueprint numbers where available.	
ABRASIVE	<p>RESIN BOND WHEELS: ASD Armored diamond, durable. Versatile: can be used wet or dry. Also should be used when carbide and steel are ground in the same operation. D Micron-sized diamond. Used for finishing and polishing operations. SD Free cutting standard. Used wet or dry; should be used on low horsepower (3/4 hp or less) machines.</p> <p>METAL BOND WHEELS: M4D Armored, durable standard. A strong, blocky crystal designed for high performance on glass, ceramics, refractories and other non-metallics.</p> <p>VITRIFIED BOND WHEELS: RMD Medium strength. Specifically designed for use with vitrified bonds. SD Free cutting standard.</p>	Select the abrasive based on horsepower, grinding wet or dry, and contact with steel.
GRIT SIZE	<p>100 Roughing. The most common grit size for roughing operations. 120 For roughing where 100 is too coarse. Also for cut-off applications. 150 Medium stock removal plus good finish. For combined roughing and finishing applications. 180 Medium stock removal plus good finish. To improve finish. 220 Finishing 320 Finishing 400 Fine Finishing 10/12 Mic Super Fine Finishing 6/12 Mic Super Fine Finishing</p>	Select the abrasive grit size based on finish and material removal rate required.
GRADE	<p>RESIN BOND WHEELS: R Norton standard N Free cutting</p> <p>METAL BOND WHEELS: N Norton standard</p> <p>VITRIFIED BOND WHEELS: P Norton standard R Most durable</p>	The hardness of the wheel
CONCENTRATION	<p>50 Most economical. For broad area of contact grinding. 75 Norton standard. Freer cutting than 100 and the most economical for dry grinding with ASD diamond. 100 Very durable. Recommended under flood coolant conditions; for use with 220 grit or finer, when durability is required, and for cut-off applications. 125 Form holding. Used in high-volume, high-pressure coolant, precision applications on high speed tool steels.</p>	Select the abrasive concentration based on grinding wet or dry, material removal rates and form holding requirements.
BOND	<p>RESIN BOND: B99 Norton standard. Versatile enough to be used wet or dry on most tool making or resharpening applications. B105 Premium, heat-reducing bond. For dry toolroom reconditioning applications.</p> <p>METAL BOND: M99 Best suited for 1A1R cut-off applications as well as grinding glass or ceramic materials. MSL Metal Single Layer. Available in shape 6A2C for dry, offhand reconditioning of carbide tools.</p> <p>VITRIFIED BOND: V99 Best for wet offhand finishing of carbide tools as well as plunge grinding of carbide tools.</p>	Select the bond based on the material being ground and grinding application.
ABRASIVE DEPTH	<p>1/16 1/8 1/4 9/32 Solid</p>	Usable abrasive

HOW TO SELECT NORTON STOCK CBN WHEELS

SELECT

SHAPE			Use the “Wheel Shape Index” to determine shape and availability.
WHEEL DIMENSIONS	D x T x H	Select Diameter x Thickness x Hole from the availability tables. Use blueprint numbers where available.	
ABRASIVE	CB	Norton standard coated cBN (cubic Boron Nitride). Optimized for high performance in resin bond systems.	Select Norton cBN abrasive to grind hard tool steels such as A2, D2, T15, etc., and tough alloy steels.
GRIT SIZE	100 120 150	100 Roughing. The most common grit size for roughing operations. 120 For roughing where 100 is too coarse. Also for cut-off applications. 150 Medium stock removal plus good finish. For combined roughing and finishing applications.	Select the grit size based on finish and material removal rate required.
GRADE	Q T W	Q Approximately 50 concentration. Used on wide area of contact applications. T Norton standard. Approximately 75 concentration. T is the first choice for lower horsepower equipment or large area of contact between the wheel and the work piece. Ideal for resharpening applications with 11V9, 12A2, 4A2P, and 15V9 wheel shapes when dry grinding. W Most durable. Approximately 100 concentration, W is recommended for high-volume coolant operations: flute grinding from solid, flute polishing, surface, and cylindrical grinding.	The hardness of the wheel
BOND	B99 Aztec III Aztec .007	B99 Norton standard. Pre-engineered for optimal performance with cBN abrasive. Available in all shapes. Aztec III The Norton advanced heat-reducing, lubricating resin bond. Used for dry grinding tool steels. Aztec .007 The Norton premium resin bond for increased feed rates, high stock removal and heavier cuts – when dry grinding tool steels.	Select the bond depending on the type of grinding application.
ABRASIVE DEPTH	1/16 1/8 1/4 9/32 Solid		Usable abrasive

NORTON OFFERS A COMPREHENSIVE STOCK PRODUCT SELECTION TO SERVICE MOST OF YOUR NEEDS – WITH THE FASTEST DELIVERY AND LOWEST PRICES. SEE THIS CATALOG SECTION FIRST:

- Norton Stock B99 Products

Can’t find the specification in the above section?

Then refer to the Norton B99 Express Made-to-Order Resin Product section on pages 24 - 52 and the Norton CNC Wheel section on pages 53 - 59.

If a product can not be found in the B99 Express offering:

Contact your Norton sales representative or distributor for a custom-made product recommendation.

TECHtip

DIAMOND GRINDS:

In general, diamond is used to grind non-ferrous materials, because it reacts with iron.

- Cemented carbide
- Glass
- Ceramics
- Fiberglass
- Plastics
- Stone
- Abrasives
- Electronic components and materials

cBN GRINDS:

cBN is used to grind ferrous materials.

- High-speed tool steels
- Die steels
- Hardened carbon steels
- Alloy steels
- Aerospace alloys
- Hardened stainless steel
- Abrasion-resistant ferrous materials



It is the user’s responsibility to refer to and comply with ANSI B7.1

SPECcheck

DIAMOND WHEEL STARTING RECOMMENDATION GUIDE

APPLICATION OR COMMON MACHINE TYPE	COMMON WHEEL SIZE, TYPE & BLUEPRINT	APPLICATION VARIABLES	RECOMMENDED SPECIFICATION
CARBIDE GRINDING – TOOLROOM PRODUCTION			
Blanchard Grinding • Vertical Spindle Surface Grinding	10", 11", 16" & 18" diameters Type 2A2T	Wet – solid carbide • 1" or larger pieces – roughing • Small pieces Carbide & steel (combination)	SD100-R75B99E* ASD100-R75B99E* ASD100-R75B99E*
Hand • Burr Grinding	6" x 3/32" x 1-1/4" Type 1V1P V – 20° ME89562	Dry	ASDC320B-R125B99
Centerless (wet) • Throughfeed Grinding • Unison Dedtru Grinder	12", 14", 16", 18", & 20" diameters Type 1A1 7" x 1" x 1-1/4" Type 1A1	Roughing	ASD100-R75B99E* ASD150-R75B99E*
Cutting Off (wet)	6" x .035" x 1-1/4" Type 1A1R ME43572 10" x .050" x 1-1/4" Type 1A1R ME43565	• Most durable • Free cutting	ASD100S-R100B99 SD100-R75B99 SD120-R100B99
Cylindrical Grinding (wet)	10", 12", 14", 16" & 20" diameters Type 1A1	Wet, rough grinding of cemented carbides, hard (55 Rc+) plasma and ceramic spray coatings Wet, finish grinding of all carbides, plasma and ceramic spray coatings	ASD180-R100B99 ASD180-R75B99E* ASD150-R75B99 ASD120-R75B99 SD220-R100B99E*
Tool Sharpener Grinder (wet) • Bench Type	5" x 1" x 1-1/4" Type 6A2H ME27084 Rim Width (W) = 1-1/16	Tool sharpening	SD320-R50B99
Hand Honing (dry)	Various sizes Type HH1 or HH2		ASD100-R100B99 SD320-100V99
Lamination Dies (wet)	Various sizes Type 1A1	Surface grinding of carbide	ASD120-R75B99
Surface Grinding (wet) • Straight Wheels	Various sizes Type 1A1	Roughing • Durable • Free cutting Finishing only General purpose	ASD100S-R100B99E* SD100S-R100B99 SD220-R100B99 ASD150-R75B99
Tool & Cutter Grinding	Various sizes Type 11V9, 12V9 or 15V9	Wet or dry	ASD120-R7599
CARBIDE GRINDING – OFFHAND			
Single-Point Carbide Tools	6" x 3/4" x 1-1/4" Type 6A2C ME27853	Wet roughing • Durable • Free cutting Wet finishing • Durable • Free cutting Wet or dry grinding where free-cutting and self-dressing wheels are required • Roughing • Finishing	RMD150-P50V99* SD150-P50V99 RMD220-P50V99* SD220-P50V99 ASD120-R75B99 SD220-R50B99E*

Note: Diamond depths are not indicated in above listings. When ordering, be sure to include Diamond depth (1/16, 1/8, etc.).
*Non-stock: Refer to the B99E Express Made-to-Order Wheel section.

SPECcheck

CBN WHEEL STARTING RECOMMENDATIONS

APPLICATION OR COMMON MACHINE TYPE	COMMON WHEEL SIZE, TYPE & BLUEPRINT	APPLICATION VARIABLES	RECOMMENDED SPECIFICATION
TOOLROOM GRINDING			
Cutter Sharpening • Milling Cutters, Broaches, Reamers, etc.	3-3/4" x 1-1/2" x 1-1/4" Type 11V9 ME92192	Dry Wet	Aztec III 120T CB120-TB99
	6" x 1" x 1-1/4" Type 12A2 ME27758	Wet or dry	CB120-TB99
	6" x 3/4" x 1-1/4" Type 12V9 ME48666	Wet or dry	CB120-TB99
	6" x 3/4" x 1-1/4" Type 15V9 ME40633	Wet or dry	CB100-WB99E*
	Surface Grinding	10" x 1/2" x 3" Type 1A1	Wet or dry
Cylindrical Grinding	12" x 1/2" x 3" Type 1A1	Wet or dry	CB150-WB99E*
Internal Grinding Tools	Thinner than 1/2" Type DW	Wet or dry	CB100-WB99
	1/2" or thicker Type 1A1	Wet or dry	CB120-TB99E*
	Slotting	7" x .040" x 1-1/4" Type 1A1R	Water-base coolant

Note: cBN depths are not indicated in above listings. When ordering, be sure to include cBN depth (1/16, 1/8, etc.)

* B99 Express made-to-order: Refer to the B99E Express Made-To-Order wheel section.

SIZE D x T	SPECIFICATION	UPC #
TYPE DW MOUNTED POINTS – DIAMOND		
1/8 x 1/4 Steel Spindle 1/8 x 1-1/2	SD220-R100B99-SOLID	69014192236
3/16 x 1/4 Steel Spindle 1/8 x 1-1/2	SD100-R100B99-SOLID	69014192238
1/4 x 1/4 Steel Spindle 1/8 x 1-1/2	SD100-R100B99-SOLID	69014192240
3/8 x 1/4 Steel Spindle 1/8 x 1-1/2	SD100S-R100B99-SOLID	69014192243
1/2 x 1/2 Steel Spindle 1/4 x 1-1/2	SD100S-R100B99-SOLID	69014192248
3/4 x 3/8 Steel Spindle 1/4 x 1-1/2	SD150-R100B99-SOLID	69014192251
1 x 1/2 Steel Spindle 1/4 x 1-1/2	SD100-R100B99-SOLID	69014192428
TYPE DW MOUNTED POINTS – cBN		
3/16 x 1/4 Carbide Spindle .125 x 1-3/4	CB150-WB99-SOLID	69014192258
1/4 x 1/4 Carbide Spindle .125 x 1-3/4	CB120-WB99-SOLID	69014192260
1/2 x 1/2 Carbide Spindle .250 x 2-1/4	CB100-WB99-SOLID	69014192272
3/4 x 1/4 Carbide Spindle .250 x 2-1/4	CB100-WB99-SOLID	69014192276
1 x 1/4 Carbide Spindle .250 x 2-1/4	CB100-WB99-SOLID	69014192277
SIZE T x W x L	SPECIFICATION	UPC #
TYPE HH1 HAND HONES – DIAMOND		
1/4 x 1/4 x 6 One 1/16 deep 1" long insert in one 1/4 surface	ASD220-R100B99-1/16	69014192139
1/4 x 3/8 x 4 One 1/16 deep 1" long insert in one 3/8 surface	ASD100-R100B99-1/16	69014192141
1/4 x 3/8 x 4 One 1/16 deep 1" long insert in one 3/8 surface	ASD180-R100B99-1/16	69014192142
1/4 x 3/8 x 4 One 1/16 deep 1" long insert in one 3/8 surface	ASD220-R100B99-1/16	69014191670
1/4 x 3/8 x 4 One 1/16 deep 1" long insert in one 3/8 surface	ASD320-R100B99-1/16	69014191672
1/4 x 3/8 x 4 One 1/16 deep 1" long insert in one 3/8 surface	ASD400-R100B99-1/16	69014192143
1/4 x 3/8 x 4 One 1/16 deep 1" long insert in one 3/8 surface	D10/20MIC-R100B99-1/16	69014192144
1/4 x 3/8 x 4 One 1/16 deep 1" long insert in one 3/8 surface	SD220-100V99-1/16	69014191671
1/4 x 3/8 x 4 One 1/16 deep 1" long insert in one 3/8 surface	SD320-100V99-1/16	69014192140
TYPE HH2 HAND HONES – DIAMOND		
1/4 x 3/8 x 4 Two 1/16 deep 1" long inserts in one 3/8 surface	ASD120/220-R100B99-1/16	69014192150
1/4 x 3/8 x 4 Two 1/16 deep 1" long inserts in one 3/8 surface	ASD150/320-R100B99-1/16	69014192177
1/4 x 3/8 x 4 Two 1/16 deep 1" long inserts in one 3/8 surface	ASD220/320-R100B99-1/16	69014192178
1/4 x 3/8 x 4 Two 1/16 deep 1" long inserts in one 3/8 surface	ASD220/400-R100B99-1/16	69014192179
1/4 x 3/8 x 4 Two 1/16 deep 1" long inserts in one 3/8 surface	ASD320/400-R100B99-1/16	69014192180
1/4 x 3/8 x 4 Two 1/16 deep 1" long inserts in one 3/8 surface	SD220/320-100V99-1/16	69014192149
1/4 x 3/8 x 4 Two 1/16 deep 1" long inserts in one 3/8 surface	SD320/400-100V99-1/16	69014192182

Type DW

D - DIAMETER
T - THICKNESS
Y - SPINDLE DIAMETER
SP - SPINDLE LENGTH

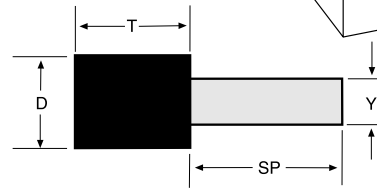

Type HH1

L - LENGTH
L1 - LENGTH OF ABRASIVE
X - ABRASIVE DEPTH
W - WIDTH
T - THICKNESS (BACK)

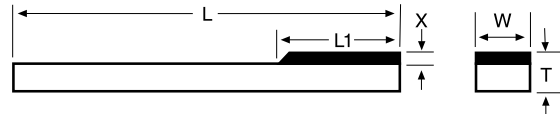

Type HH2

L - LENGTH
L1 - LENGTH OF ABRASIVE
X - ABRASIVE DEPTH
W - WIDTH
T - THICKNESS (BACK)

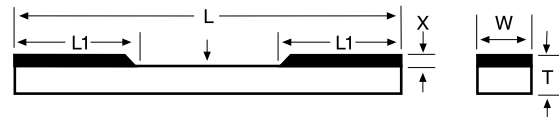

CAN'T FIND YOUR SPECIFICATION HERE?

CHECK OUT THE NORTON/WINTER TOOLROOM SECTION. THEN REFER TO OUR B99 EXPRESS MADE-TO-ORDER RESIN WHEEL SECTION.

The Norton B99 Express service is designed to offer you up to 65,000 made-to-order choices of resin bond Diamond and cBN wheels. Almost all popular sizes are offered. Size and shape availability are shown.

12" and less diameter B99 Express wheels will ship in two weeks or less from the date the order is received by Norton. 14" and larger wheels are available at standard lead-times.

SIZE D x T x H	SPECIFICATION	UPC #
TYPE 1A1 STRAIGHT – DIAMOND		
3/4 x 1/4 x 1/4	ASD150-R100B99-1/8	69014192174
1 x 1/4 x 1/4	SD100-R100B99-1/8	69014192175
1-1/2 x 1/2 x 1/2	D6/12MIC-N100B99-1/8	69014192176
2 x 1/8 x 1/4	SD100-R100B99-1/8	69014192184
3 x 1/4 x 3/4	SD180-N100B99-1/8	69014192187
4 x 1/32 x 1-1/4	SD100S-R100B99-1/4	69014192192
4 x 1/16 x 1-1/4	SD100S-R100B99-1/4	66260273583
	SD150-R100B99-1/4	66260273584
	SD220-R100B99-1/4	66260273586
4 x 1/8 x 3/4	SD150-R100B99-1/4	69014192024
4 x 1/8 x 1-1/4	SD150-R100B99-1/4	69014191677
4 x 1/4 x 1/2	SD150-R100B99-1/4	66260273590
4 x 1/4 x 3/4	SD150-R100B99-1/4	66260273592
4 x 1/4 x 1-1/4	SD100S-R100B99-1/4	66260273587
	SD120-R100B99-1/4	66260273588
	SD150-R100B99-1/4	66260273589
4 x 1/2 x 1-1/4	SD150-R100B99-1/4	66260273594
6 x 1/32 x 1-1/4	SD220-R100B99-1/4	69014192197
6 x 1/16 x 1-1/4	SD100-R100B99-1/4	66260273596
	SD150-R100B99-1/4	66260273597
	SD180-R100B99-1/4	66260273598
	SD220-R100B99-1/4	66260273599
6 x 1/8 x 1-1/4	ASD150-R75B99-1/4	66260273617
	SD100-R100B99-1/4	66260273611
	SD120-R100B99-1/4	66260273612
	SD150-R100B99-1/4	66260273613
	SD180-R100B99-1/4	66260273614
	SD220-R100B99-1/4	66260273615
6 x 1/4 x 1-1/4	ASD100S-R75B99-1/4	69014192205
	ASD120-R75B99-1/4	69014192769
	ASD150-R75B99-1/4	66260273609
	ASD180-R75B99-1/4	69014192770
	ASD220-R75B99-1/4	69014192771
	ASD320-R75B99-1/4	69014192772
	RMD180-P100V99-1/8	69014192203
	SD120-R100B99-1/4	69014191691
	SD150-R100B99-1/4	69014191692
	SD180-R100B99-1/4	69014191693
	SD220-R100B99-1/4	69014192764
6 x 3/8 x 1-1/4	ASD120-R75B99-1/4	69014192773
	ASD150-R75B99-1/4	69014191695
	SD150-R100B99-1/4	69014191696
6 x 1/2 x 1-1/4	ASD120-R75B99-1/4	69014192777
	ASD150-R75B99-1/4	69014191698
	ASD220-R75B99-1/4	69014192779
	ASD320-R75B99-1/4	69014192780
	SD120-R100B99-1/4	66260273557
	SD150-R100B99-1/4	66260273561
	SD180-R100B99-1/4	69014191700
7 x 1/4 x 1-1/4	ASD150-R75B99-1/8	69014191701
	SD100S-R100B99-1/4	69014192210
	SD120-R100B99-1/4	66260273566
	SD150-R100B99-1/4	69014191703
	SD180-R100B99-1/4	69014191704
	SD220-R100B99-1/4	69014191705
7 x 3/8 x 1-1/4	ASD150-R75B99-1/4	69014191848
	SD120-R100B99-1/4	69014191849
	SD220-R100B99-1/4	69014191852
7 x 1/2 x 1-1/4	ASD100-R75B99-1/4	69014192211
	ASD150-R75B99-1/4	69014191853
	ASD180-R75B99-1/4	69014192212
	SD120-R100B99-1/4	69014191854
	SD150-R100B99-1/4	69014191855
	SD180-R100B99-1/4	69014191856
	SD220-R100B99-1/4	69014191857
8 x 1/2 x 1-1/4	SD150-R100B99-1/4	66260273574

STANDARD PACKAGE = 1 MOUNTED POINT, HAND HONE, OR WHEEL
CONTINUED

SIZE D x T x H	SPECIFICATION	UPC #
TYPE 1A1 STRAIGHT – DIAMOND (CONT'D)		
10 x 1/2 x 3	ASD120-R75B99-1/4	69014192305
	ASD180-R100B99-1/4	69014192306
12 x 1/2 x 3	ASD150-R75B99-1/4	69014192310
12 x 1/2 x 5	ASD150-R75B99-1/4	69014192311
12 x 1 x 3	ASD120-R75B99-1/4	69014192312
12 x 1 x 5	ASD120-R75B99-1/4	69014192313
14 x 1/2 x 5	ASD150-R75B99-1/4	69014192314
14 x 1 x 5	ASD120-R75B99-1/4	69014192316
20 x 1 x 12	ASD120-R75B99-1/4	69014192325
TYPE 1A1 STRAIGHT – cBN		
6 x 1/8 x 1-1/4	CB120-TB99-1/4	66260273601
6 x 1/4 x 1-1/4	CB120-TB99-1/4	66260273605
6 x 1/2 x 1-1/4	CB120-TB99-1/4	66260273607
7 x 1/4 x 1-1/4	CB120-TB99-1/4	69014192021
7 x 1/2 x 1-1/4	CB120-TB99-1/4	66260273567
12 x 1/2 x 5	CB150-TB99-1/4	66260273560
12 x 1 x 5	CB150-TB99-1/4	66260273562

STANDARD PACKAGE = 1 WHEEL

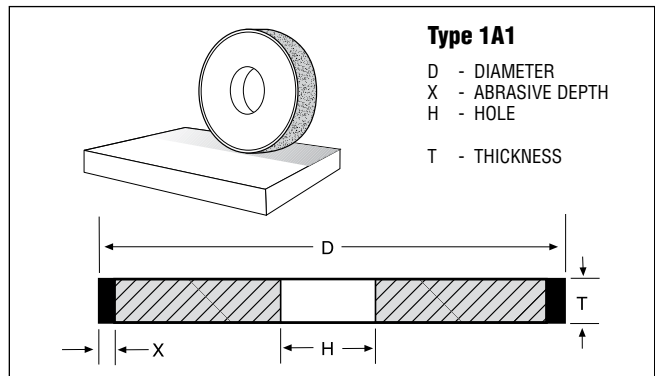

NOTE: 1A1 NORTON STOCK WHEELS WITH 1/8" DIAMOND DEPTH HAVE BEEN CONVERTED TO 1/4" DEPTH – AND PRICED TO DELIVER EXCEPTIONAL VALUE!

TECHtip

CYLINDRICAL GRINDING APPLICATIONS – 1A1 WHEELS:

- Includes all outside grinding of round parts, even though the finished product is not always a true cylinder.
- Infeed at both ends of the traverse to keep wheel face flat.
- Use work supports to prevent deflection.
- Rough grinding traverse speed should be 1/2 to 2/3 of the thickness of the wheel per work revolution.
- Finishing grinding traverse speed should be 1/2" or less per work revolution.

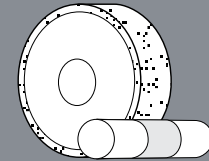

It is the user's responsibility to refer to and comply with ANSI B7.1

DIAMOND GRINDS:

- Cemented carbide
- Glass
- Ceramics
- Fiberglass
- Plastics
- Stone
- Abrasives
- Electronic components and materials

CBN GRINDS:

- High-speed tool steels
- Die steels
- Hardened carbon steels
- Alloy steels
- Aerospace alloys
- Hard stainless steel
- Abrasion-resistant ferrous materials

NORTON STOCK PRODUCTS

SIZE D x T x H	SPECIFICATION	UPC #
TYPE 1A1R CUT-OFF – DIAMOND		
3 x .020 x 1/2 (ME104177)	M4D150-N50M99-1/8	69014192060
4 x .012 x 1/2 (ME104180)	M4D180-N75M99-1/8	69014192063
4 x .020 x 1/2 (ME104180)	M4D220-N75M99-1/8	69014192064
4 x .020 x 1/2 (ME104180)	M4D220-N100M99-1/8	69014192067
4 x .030 x 1/2 (ME104180)	M4D150-N75M99-1/8	69014192068
4 x 1/32 x 3/4 (ME43570)	SD100S-R100B99-1/4	69014192151
4 x 1/32 x 1-1/4 (ME43570)	SD120-R100B99-1/4	69014191706
4 x 1/32 x 1-1/4 (ME43570)	SD100S-R100B99-1/4	69014192152
5 x .015 x 1/2 (ME104180)	M4D150-N100M99-1/8	69014192069
6 x .017 x 1-1/4 (ME104180)	M4D220-N100M99-1/8	69014192070
6 x .017 x 1-1/4 (ME104180)	M4D150-N100M99-1/8	69014192082
6 x .025 x 1-1/4 (ME104180)	M4D220-N100M99-1/8	69014192083
6 x .025 x 1-1/4 (ME104180)	M4D150-N100M99-1/8	69014192086
6 x .035 x 5/8 (ME104177)	M4D100-N75M99-1/8	69014192088
6 x .035 x 1-1/4 (ME43572)	ASD120-R75B99-1/4	69014191707
	SD100-R75B99-1/4	69014192155
	ASD100S-R100B99-1/4	69014192158
	ASD120-R100B99-1/4	69014192159
	SD100-R100B99-1/4	69014191858
	SD100S-R100B99-1/4	69014192156
	SD220-R100B99-1/4	69014192157
6 x .035 x 1-1/4 (ME73316)	ASD100S-R100B99-9/32	69014192164
	ASD120-R100B99-9/32	69014192165
	SD100-R100B99-9/32	69014192161
	SD120-R100B99-9/32	69014192162
	SD150-R100B99-9/32	69014192163
6 x .045 x 1-1/4 (ME83991)	SD100-R50B99-1/8	69014192166
6 x .055 x 1-1/4 (ME104177)	M4D100-N75M99-1/8	69014192099
7 x .035 x 1-1/4 (ME82347)	ASD100-R100B99-1/4	66260238686
7 x .040 x 1-1/4 (ME104177)	M4D120-N75M99-1/8	69014192105
7 x .055 x 1-1/4 (ME104177)	M4D120-N100M99-1/8	69014192108
8 x .030 x 1-1/4 (ME104180)	M4D180-N75M99-1/8	69014192110
8 x .045 x 5/8 (ME43569)	SD120-R100B99-1/4	69014192167
8 x .045 x 1 (ME43569)	SD120-R100B99-1/4	69014192168
8 x .045 x 1-1/4 (ME43569)	SD120-R100B99-1/4	69014192169
8 x .050 x 1-1/4 (ME104180)	M4D180-N75M99-1/8	69014192114
10 x .050 x 1-1/4 (ME 43565)	ASD120-R100B99-1/4	66260230236
	CD100-R100B99-1/4	69014192815
	SD120-R100B99-1/4	69014192170
10 x .050 x 3 (ME 43565)	ASD100S-R75B99-1/4	69014192172
12 x .070 x 3/4 (ME 43567)	SD150-R100B99-1/4	69014192173
14 x .070 x 3/4 (ME 106589)	SD120-R100B99-1/4	66260259011
TYPE 1A1R CUT-OFF – cBN		
6 x .035 x 1-1/4 (ME43572)	CB100-WB99-1/4	69014192160

SIZE D x T x H	SPECIFICATION	UPC #
TYPE 1V1P FLUTING – DIAMOND		
6 x 3/32 x 1-1/4	ASD320B-R125B99-1/4	69014192302
Face Bevel 1 Side	ASDC320C-R100B99-1/4	69014192761
20 Deg		
Copper Core		
(ME89562)		
STANDARD PACKAGE = 1 WHEEL		

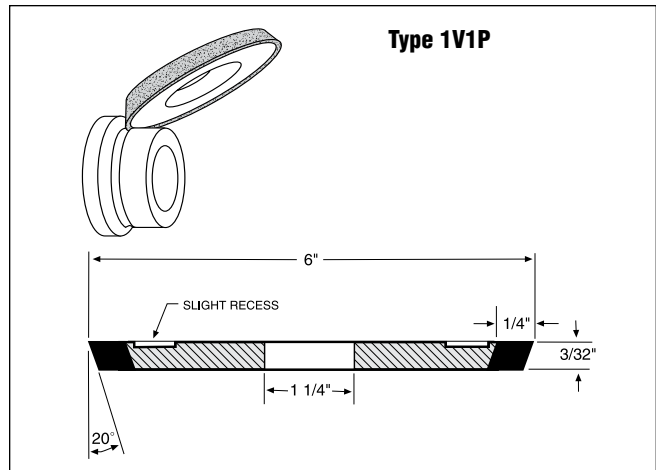
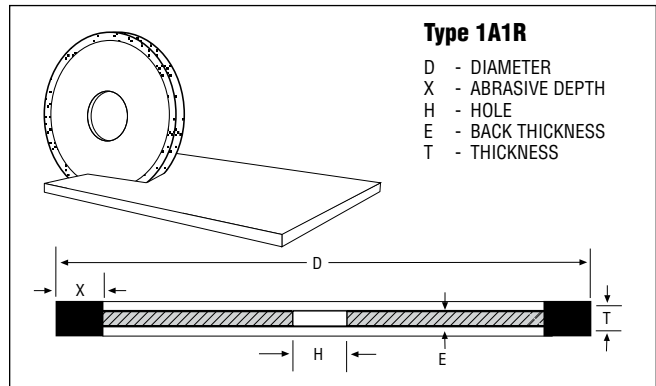

TECHtip

CUT-OFF APPLICATIONS – 1A1R WHEELS:

- Use the largest diameter flanges possible
- Use flanges of equal diameter
- Use the thickest wheel possible for increased stiffness and straightness of cut

cBN wheels are used on hardened steels. Diamond wheel are used to cut or slot carbide, glass or ceramic parts.

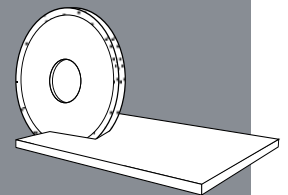

It is the user's responsibility to refer to and comply with ANSI B7.1

SIZE D x T x H	SPECIFICATION	UPC #
TYPE 4A2P DISH – DIAMOND		
6 x 3/8 x 1-1/4 Rim Width 1/4" (ME88369)	ASD120-R75B99-1/16	69014192280
TYPE 6A2C STRAIGHT CUP – DIAMOND		
6 x 7/16 x 1-1/4 Rim Width 1" (0640185M)	D120/140-H-MSL	66260269172
6 x 3/4 x 1-1/4 Rim Width 3/4" (ME27853)	SD220-R50B99-1/16 ASD120-R75B99-1/16 ASD120-R75B99-1/8 SD150-P50V99-1/16 SD220-P50V99-1/8	69014191665 69014191860 69014192786 69014192217 69014191623
6 x 3/4 x 1-1/4 Rim Width 1/2" (ME30621)	ASD120-R75B99-1/8	66260273565
STANDARD PACKAGE = 1 WHEEL		

SIZE D x T x H	SPECIFICATION	UPC #
TYPE 6A2H STRAIGHT CUP – DIAMOND		
5 x 1 x 1-1/4 Rim Width 1-1/16" (ME27084)	SD320-R50B99-1/16	69014192221
TYPE 11A2 FLARING CUP – DIAMOND		
6 x 1-1/2 x 1-1/4 Rim Width 1/4" (ME128467)	ASD150-R100B99-1/4	69014192799
STANDARD PACKAGE = 1 WHEEL		

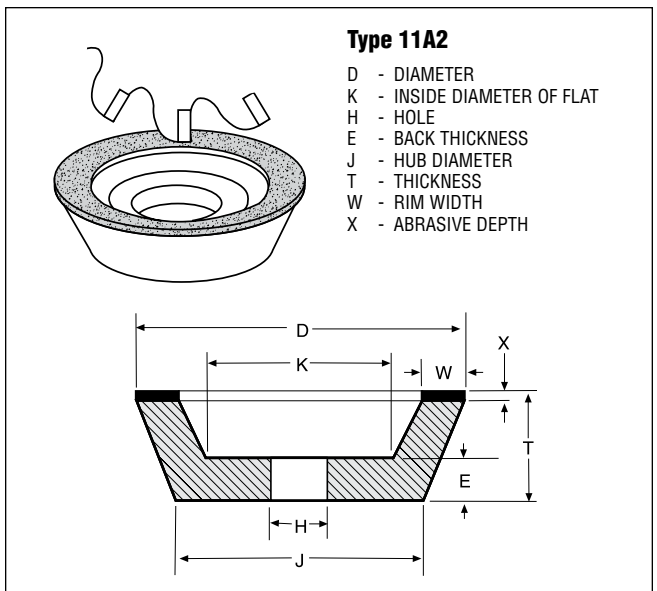
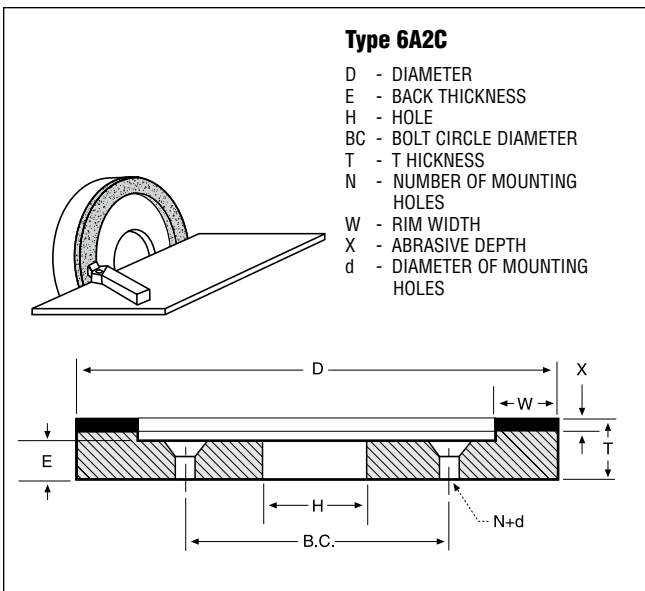
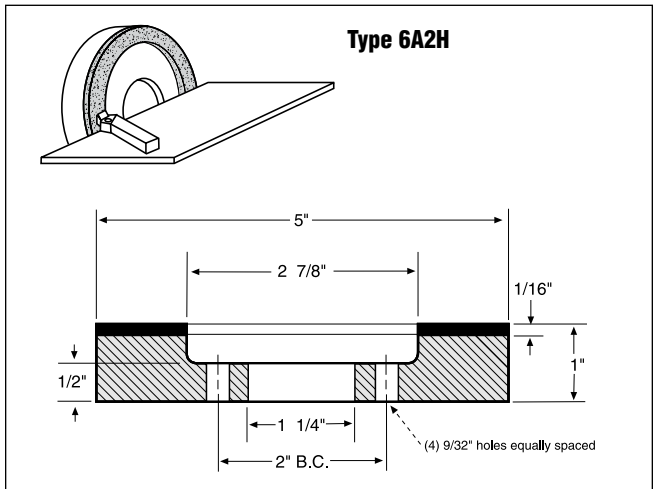
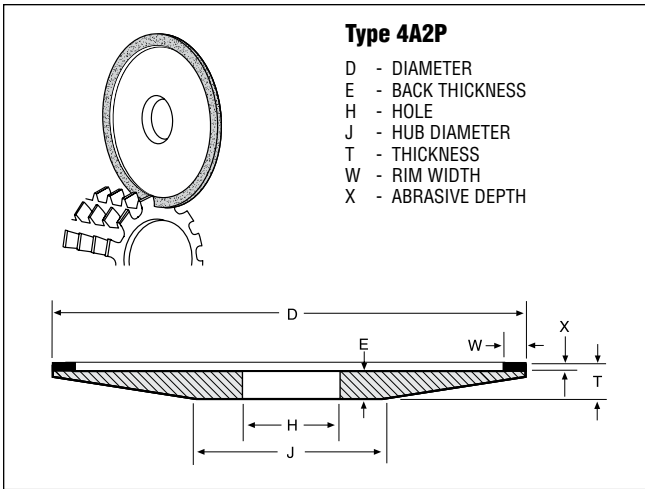

REFER TO "BRAKE CONTROLLED TRUING DEVICES" AND "DRESSING STICKS" SECTIONS FOR TRUING AND DRESSING PRODUCTS.

BEST

ASD DIAMOND / B105 RESIN BOND WHEELS – IDEAL FOR DRY GRINDING CARBIDE TOOLS

FEATURES	BENEFITS
■ Premium quality diamond	■ Produces keen cutting tools that hold their shape, are easier to sharpen, and require fewer reconditionings
■ Advanced, heat-reducing bond	■ Minimizes heat generation and thermal damage to tool ■ Increases tool life and productivity ■ Lasts more than 2X as long as standard diamond wheels ■ Lowest total wheel costs; highest productivity
■ Self-lubricating bond	■ No steel or braze loading ■ Uses less power
■ Unique self-dressing core	■ Eliminates wheel core damage ■ Eliminates downtime to dress core

SIZE D x T x H	SPECIFICATION	UPC #
TYPE 11V9 FLARING CUP – DIAMOND		
3-3/4 x 1-1/2 x 1-1/4	ASD100S-R75B105-1/16	69014191904
Insert Length 3/8" (ME92192)	ASD120-R75B105-1/16	69014191905
	ASD150-R75B105-1/16	69014191906
	ASD100S-R75B105-1/8	69014191908
	ASD120-R75B105-1/8	69014191909
	ASD150-R75B105-1/8	69014191910
5 x 1-3/4 x 1-1/4	ASD120-R75B105-1/16	69014191913
Insert Length 7/16" (ME98298)	ASD150-R75B105-1/16	69014191914
	ASD100S-R75B105-1/8	69014191916
	ASD120-R75B105-1/8	69014191917
	ASD150-R75B105-1/8	69014191918

STANDARD PACKAGE = 1 WHEEL

SIZE D x T x H	SPECIFICATION	UPC #	
TYPE 11V9 FLARING CUP – DIAMOND			
3 x 1-1/4 x 3/4	ASD120-R75B99-1/16	69014192291	
Insert Length 3/8" (ME93912)	ASD150-R75B99-1/16	69014192292	
	SD150-R100B99-1/16	69014192293	
3-3/4 x 1-1/2 x 3/4	ASD120-R75B99-1/16	69014192022	
Insert Length 3/8" (M92192)	ASD150C-R50B99-1/8	69014190751	
	ASD120-R75B99-1/16	69014191660	
Insert Length 3/8" (ME92192)	ASD150-R75B99-1/16	69014191725	
	ASD180-R75B99-1/16	69014191658	
	ASD220-R75B99-1/16	69014192363	
	ASD100S-R75B99-1/8	69014191653	
	ASD120-R75B99-1/8	69014191652	
	ASD150-R75B99-1/8	69014191651	
	ASD180-R75B99-1/8	69014191650	
	SD120-R100B99-1/16	69014191657	
	SD150-R100B99-1/16	69014191656	
	SD220-R100B99-1/16	69014191654	
	SD320-R100B99-1/16	69014192814	
	SD100S-R100B99-1/8	69014192427	
	SD120-R100B99-1/8	69014191649	
	SD150-R100B99-1/8	69014191648	
	SD180-R100B99-1/8	69014191647	
	SD220-R100B99-1/8	69014191646	
	5 x 1-3/4 x 1-1/4 Insert Length 7/16" (ME98298)	ASD100S-R75B99-1/16	69014191645
		ASD120-R75B99-1/16	69014191644
		ASD150-R75B99-1/16	69014191643
		ASD100S-R75B99-1/8	69014191637
ASD120-R75B99-1/8		69014191636	
ASD150-R75B99-1/8		69014191635	
ASD180-R75B99-1/8		69014191634	
ASD320-R75B99-1/8		69014192810	
SD120-R100B99-1/16		69014191641	
SD150-R100B99-1/16		69014191640	
SD180-R100B99-1/16		69014191639	
SD220-R100B99-1/16		69014191638	
SD150-R100B99-1/8	69014191632		
SD180-R100B99-1/8	69014191631		

STANDARD PACKAGE = 1 WHEEL

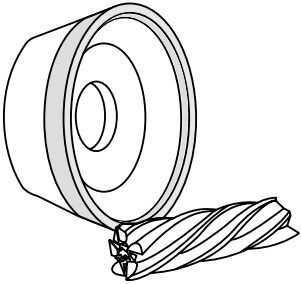

Type 11V9

- D - DIAMETER
- K - INSIDE DIAMETER OF FLAT
- H - HOLE
- E - BACK THICKNESS
- T - THICKNESS
- J - HUB DIAMETER
- U - INSERT LENGTH
- X - ABRASIVE DEPTH
- S - FACE ANGLE

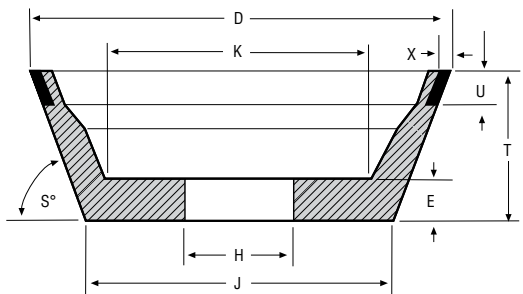

BEST

NORTON AZTEC cBN WHEELS – IDEAL FOR DRY RESHARPENING OF STEEL TOOLS

FEATURES

- Consistent, high quality cBN (cubic Boron Nitride) abrasive
- Advanced heat-reducing bond conducts heat away from the workpiece

BENEFITS

- 85% longer life than standard cBN wheels
- Eliminates heat build-up and damage
- Extends wheel life
- Freer cutting action
- Maintains cutting tool steel integrity
- Extends cutting tool life

Aztec III

- Lubricating bond
- Eliminates steel and braze loading
- Reduces drag
- Allows greater infeeds

Aztec .007

- Allows increased infeed (start at .007)
- High stock removal rate
- Heaviest cuts with less wheel wear
- Lower grinding forces
- Elimination of chatter

SIZE D x T x H	SPECIFICATION	UPC #
TYPE 11V9 FLARING CUP – cBN		
3-3/4 x 1-1/2 x 1-1/4 Insert Length 3/8" (ME92192)	AZTEC .007-100-1/16	69014195683
	AZTEC .007-150-1/16	69014195679
	AZTEC III 100T-1/16	69014191832
	AZTEC III 120T-1/16	69014191833
	AZTEC III 150T-1/16	69014191834
	AZTEC .007-150-1/8	69014195680
	AZTEC III 100T-1/8	69014191838
	AZTEC III 120T-1/8	69014191839
	AZTEC III 150T-1/8	69014191840
	AZTEC III 100W-1/16	69014191835
AZTEC III 150W-1/16	69014191837	
5 x 1-3/4 x 1-1/4 Insert Length 7/16" (ME98298)	AZTEC .007-100-1/16	69014195685
	AZTEC III 100T-1/16	69014191841
	AZTEC III 120T-1/16	69014191842
	AZTEC III 150T-1/16	69014191843
	AZTEC .007-100-1/8	69014195686
	AZTEC .007-150-1/8	69014195682
AZTEC III 100T-1/8	69014191844	

SIZE D x T x H	SPECIFICATION	UPC #
TYPE 11V9 FLARING CUP – cBN		
3-3/4 x 1-1/2 x 1-1/4 Insert Length 3/8" (ME92192)	CB100-TB99-1/16	69014191719
	CB100-TB99-1/8	69014191722
	CB120-TB99-1/8	69014191723
	CB150-TB99-1/8	69014191724
	CB120-WB99-1/16	69014191720
CB150-WB99-1/16	69014191721	
5 x 1-3/4 x 1-1/4 Insert Length 7/16" (ME98298)	CB120-TB99-1/8	69014191715
	CB150-TB99-1/8	69014191716

STANDARD PACKAGE – 1 WHEEL

STANDARD PACKAGE = 1 WHEEL

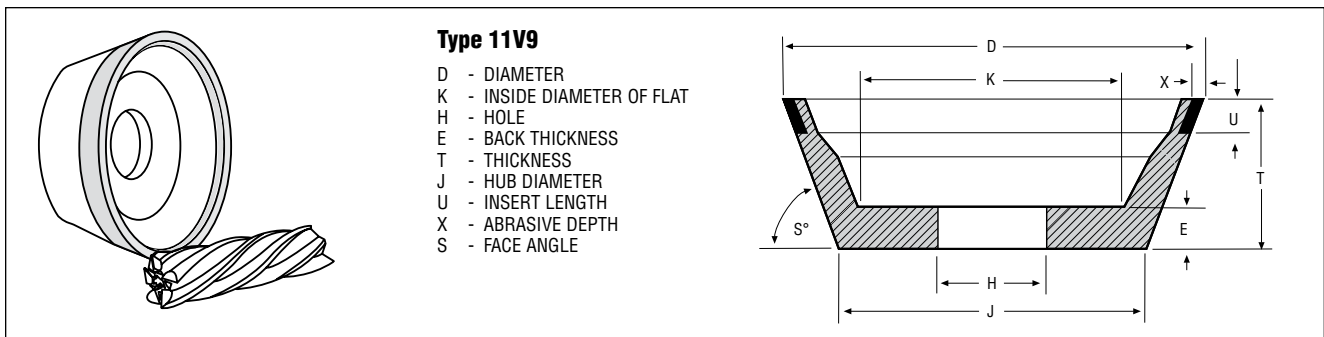

SIZE D x T x H	SPECIFICATION	UPC #
TYPE 12A2 DISH – DIAMOND		
4 x 1/2 x 1-1/4 Rim Width 1/4" (ME40745)	SD180-R75B99-1/8	69014192223
6 x 1 x 1-1/4 Rim Width 3/16" (ME27758)	ASD120-R75B99-1/8 ASD180-R75B99-1/8	69014191630 69014192226
TYPE 12A2 DISH – cBN		
6 x 1 x 1-1/4 Rim Width 3/16" (ME27758)	CB120-TB99-1/16	69014192227
TYPE 12V9 DISH – DIAMOND		
3 x 7/16 x 3/4 Insert Length 7/16" (ME41755)	SD150-R100B99-1/16	69014192228
4 x 1/2 x 1-1/4 Insert Length 1/4" (ME58734)	SD180-R100B99-1/8	69014191629
6 x 3/4 x 1-1/4 Insert Length 3/8" (ME48666)	ASD150-R75B99-1/16	69014191628
TYPE 12V9 DISH – cBN		
4 x 1/2 x 1-1/4 Insert Length 1/4" (ME58734)	CB120-TB99-1/8	69014192229
6 x 3/4 x 1-1/4 Insert Length 3/8" (ME48666)	CB120-TB99-1/8 CB150-TB99-1/8	69014192020 69014192784
TYPE 15V9 DISH – DIAMOND		
6 x 3/4 x 1-1/4 Insert Length 3/8" (ME40633)	SD150-R100B99-1/16	69014192230

STANDARD PACKAGE = 1 WHEEL

NORTON OFFERS A COMPREHENSIVE STOCK PRODUCT SELECTION TO SERVICE MOST OF YOUR NEEDS – WITH THE FASTEST DELIVERY AND LOWEST PRICES. SEE THESE CATALOG SECTIONS FIRST:

- Norton Stock B99 Products
- Norton/Winter Stock Toolroom Products

Can't find the specification in the above sections?

Then refer to the Norton B99 Express Made-to-Order Resin Product section.

If a product can not be found in the B99 Express offering:

Contact your Norton sales representative or distributor for a custom-made product recommendation.

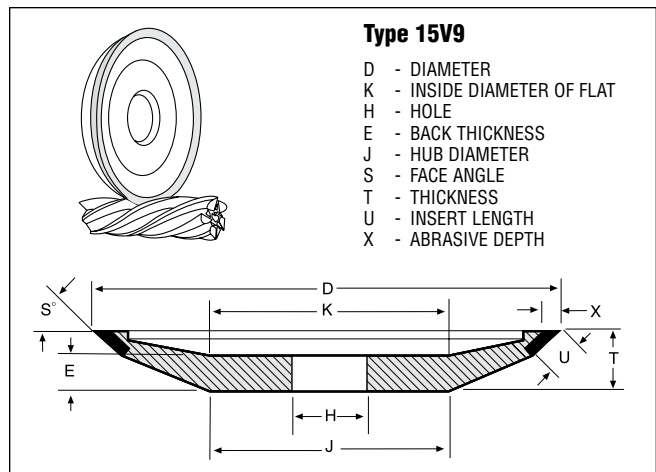
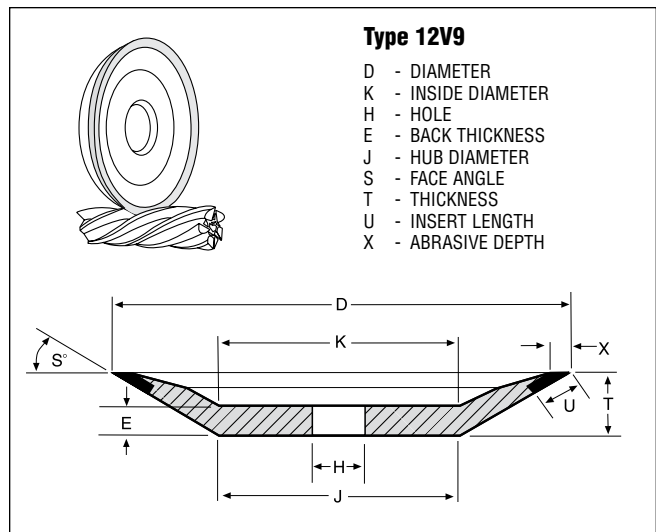
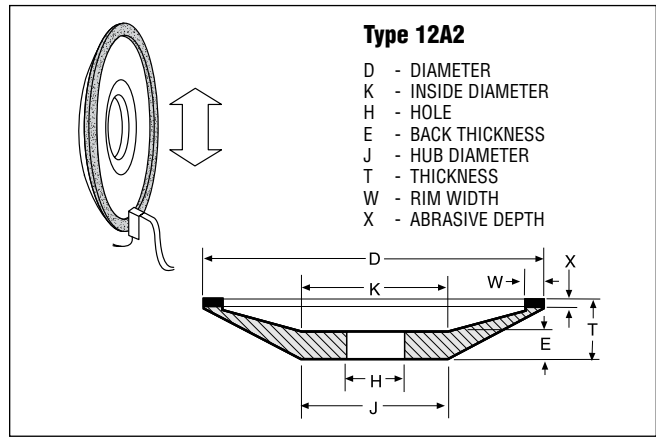

**NORTON B99 EXPRESS
MADE-TO-ORDER RESIN PRODUCTS**



65,000+ made-to-order resin products; 25 wheel shapes, with 2 week lead-times for 12" and less diameter wheels. 14" and larger wheels and 80 grit and coarser wheels are available with standard made-to-order lead-times. If you do not find the resin specification and/or shape you need in our stock offering, you will most likely find it in our B99 Express made-to-order offering.

TYPICAL APPLICATIONS

Norton B99E Diamond Wheels

- Sharpening cemented carbide cutting tools
- Cutting off carbide rod
- Grinding or cutting off non-metallic materials such as ceramics or glass
- Surface grinding dies
- O.D. grinding spray coatings

Norton B99E cBN Wheels

- Sharpening high-speed (M2, D2, T15, etc.) steel cutting tools
- Surface and ID grinding hardened steel die components
- Precision grinding steel parts Rc 50 or harder



BETTER

B99 EXPRESS DIAMOND AND cBN WHEELS

FEATURES	BENEFITS
■ Superior diamond and cBN abrasives in durable resin bond systems	■ These quality wheels will get your job done
■ Thousands of abrasive, grit, grade, concentration, and bond combinations	■ There is a B99 Express wheel for almost every resin bond application
■ Made in our state-of the art, USA, ISO-certified facilities	■ Exceptional quality and performance
■ Priced as stock products	■ Excellent performance/price ratio
■ Two week (and less) lead-times	■ Minimal time from order to production floor

HOW TO SELECT B99 EXPRESS MADE-TO-ORDER DIAMOND WHEELS

SELECT

SHAPE			Use the “Wheel Shape Index” to determine shape and availability.
WHEEL DIMENSIONS	D x T x H	Select Diameter x Thickness x Hole from the availability tables. Use blueprint numbers where available.	
ABRASIVE	ASD SD	Armored diamond; most durable. Versatile: can be used wet or dry. ASD should be used when carbide and steel are ground in the same operation. Free cutting standard. Can be used wet or dry; should be used on low horsepower (3/4 hp or less) machines.	Select the abrasive based on horsepower, grinding wet or dry, and contact with steel.
GRIT SIZE	80 100 120 150 180 220 320 400	Roughing Roughing. The most common grit size for roughing operations. For roughing where 100 is too coarse. Also for cut-off applications. Medium stock removal plus good finish. For combined roughing and finishing applications. Medium stock removal plus good finish. To improve finish. Finishing Finishing Fine finishing	Select the grit size based on finish and material removal rate required. Note: Standrad made-to-order lead-times apply to 80 grit and coarser wheels.
GRADE	R	Resin bond standard	The hardness of the wheel
CONCENTRATION	50 75 100 125	Shape 2A2T only. For broad area of contact grinding. Norton standard. Freer cutting than 100 and the most economical for dry grinding with ASD diamond. Very durable. Recommended under flood coolant conditions. For use with 220 grit or finer, when durability is required. Also for cut-off applications. Improved form holding. Used with B99EF bond only for form holding in high-volume, high-pressure coolant applications. Used with ASD abrasive.	Select the abrasive concentration based on grinding wet or dry, material removal rates and form holding requirements.
BOND	B99E B99EF	Norton standard pre-engineered resin bond. Versatile enough to be used wet or dry on most tool making or resharpening applications as well as for grinding non-metallic materials such as ceramics or glass. Available in all shapes. Improved form holding. More durable than B99E. Improved heat dissipation in wet or dry applications. Available in wheel shapes 1V1, 1B1, 1E1, 1EE1, 1F1 and 1FF1.	Select the bond based on the material being ground and grinding application.
ABRASIVE DEPTH	1/16 1/8 1/4 1/2		Usable abrasive

NORTON OFFERS A COMPREHENSIVE STOCK PRODUCT SELECTION TO SERVICE MOST OF YOUR NEEDS – WITH THE FASTEST DELIVERY AND LOWEST PRICES. SEE THESE CATALOG SECTIONS FIRST:

- Norton Stock B99 Products
- Norton/Winter Stock Toolroom Products
- Norton CNC Products

Can’t find the specification in the above sections?

Then refer to the Norton B99 Express Made-to-Order Resin Product section.

If a product can not be found in the B99 Express offering:

Contact your Norton sales representative or distributor for a custom-made product recommendation.

TECHtip

DIAMOND GRINDS:

In general, diamond is used to grind non-ferrous materials, because it reacts with iron.

- Cemented carbide
- Glass
- Ceramics
- Fiberglass
- Plastics
- Stone
- Abrasives
- Electronic components and materials

cBN GRINDS:

cBN is used to grind ferrous materials.

- High-speed tool steels
- Die steels
- Hardened carbon steels
- Alloy steels
- Aerospace alloys
- Hardened stainless steel
- Abrasion-resistant ferrous materials

HOW TO SELECT B99 EXPRESS MADE-TO-ORDER CBN WHEELS

SELECT

SHAPE			Use the “Wheel Shape Index” to determine shape and availability.
WHEEL DIMENSIONS	D x T x H	Select Diameter x Thickness x Hole from the availability tables. Use blueprint numbers where available.	Note: Standard made-to-order lead-times apply to 14” and larger wheels.
ABRASIVE	CB	Norton standard coated cBN (cubic Boron Nitride). Optimized for high performance in resin bond systems.	Select Norton cBN abrasive to grind hard tool steels such as A2, D2, T15, etc., and tough alloy steels.
GRIT SIZE	100 120 150 180 220 320 400	Roughing. The most common grit size for roughing operations. For roughing where 100 is too coarse. Also for cut-off applications. Medium stock removal plus good finish. For combined roughing and finishing applications. Medium stock removal plus good finish. To improve finish. Finishing Finishing Fine finishing	Select the grit size based on finish and material removal rate required. Note: Standard made-to-order lead-times apply to 80 grit and coarser wheels.
GRADE	T W Z	Norton standard. Approximately 75 concentration, T is the first choice for lower horsepower equipment or wide area of contact between the wheel and the workpiece. Ideal for resharpening applications with 11V9, 12A2, 4A2P, and 15V9 wheel shapes when dry grinding. Very Durable. Approximately 100 concentration, W is recommended for high volume coolant operations: flute grinding from solid, flute polishing, surface, and cylindrical grinding. Form holding. Approximately 125 concentration, Z grade is extremely durable and is recommended where long life or form holding is required in high-volume, high-pressure coolant applications. Used with B99EF bond only.	The hardness of the wheel
BOND	B99E B99EF	Norton standard resin bond. Pre-engineered for optimal performance with cBN abrasive. Available in all shapes. Improved form holding. More durable than B99E. Improved heat dissipation in wet or dry applications. Available in wheel shapes 1V1, 1B1, 1E1, 1EE1, 1F1 and 1FF1.	Select the bond depending on the type of grinding application.
ABRASIVE DEPTH	1/16 1/8 1/4 1/2		Usable abrasive

NORTON B99 EXPRESS MADE-TO-ORDER RESIN PRODUCTS

D	T	X
TYPE 1A1 – STRAIGHT WHEELS		
1	1/16	1/8
1	3/32	1/8
1	1/8	1/8
1	1/4	1/8
1	3/8	1/8
1	1/2	1/8
1	5/8	1/8
1	3/4	1/8
1	1	1/8
1-1/8	1/4	1/8
1-1/8	1/2	1/8
1-1/8	5/8	1/8
1-1/4	1/16	1/8
1-1/4	1/8	1/8
1-1/4	1/4	1/8
1-1/4	3/8	1/8
1-1/4	1/2	1/8
1-1/4	3/4	1/8
1-3/8	1/4	1/8
1-3/8	1/2	1/8
1-1/2	1/16	1/8
1-1/2	1/8	1/8
1-1/2	1/4	1/8
1-1/2	3/8	1/8
1-1/2	1/2	1/8
1-1/2	3/4	1/8
1-1/2	1	1/8
1-3/4	3/16	1/8
1-3/4	1/8	1/8
1-3/4	1/4	1/8
1-3/4	1/2	1/8
1-3/4	1	1/8
2	1/16	1/8
2	3/32	1/8
		1/4
2	1/8	1/8
		1/4
2	3/16	1/8
		1/4
2	1/4	1/8
2	3/8	1/8
		1/4

CONTINUED

D	T	X
TYPE 1A1 – STRAIGHT WHEELS (CONT'D)		
2	1/2	1/8
		1/4
2	3/4	1/8
2	1	1/8
2-1/4	1/2	1/8
		1/4
2-1/2	1/4	1/8
		1/4
2-1/2	1/2	1/8
2-3/4	1/4	1/8
2-3/4	1/2	1/8
3	1/32	1/8
		1/4
3	1/16	1/8
		1/4
3	3/32	1/8
		1/4
3	1/8	1/8
		1/4
3	3/16	1/8
		1/4
3	1/4	1/8
		1/4
3	3/8	1/8
		1/4
3	1/2	1/8
		1/4
3	3/4	1/8
4	1/32	1/8
		1/4
4	1/16	1/8
		1/4
4	3/32	1/8
		1/4
4	1/8	1/8
		1/4
4	3/16	1/8
		1/4
4	1/4	1/8
		1/4
4	5/16	1/8
		1/4

CONTINUED

D	T	X
TYPE 1A1 – STRAIGHT WHEELS (CONT'D)		
4	3/8	1/8
		1/4
4	1/2	1/8
		1/4
4	3/4	1/8
		1/4
4	1	1/8
		1/4
5	1/32	1/8
		1/4
5	1/16	1/8
		1/4
5	3/32	1/8
		1/4
5	1/8	1/4
5	3/16	1/4
5	1/4	1/4
		1/2
5	3/8	1/4
		1/2
5	1/2	1/4
		1/2
6	1/32	1/4
6	1/16	1/4
6	3/32	1/4
6	1/8	1/4
6	3/16	1/4
6	1/4	1/4
		1/2
6	5/16	1/4
		1/2
6	3/8	1/4
		1/2
6	1/2	1/4
		1/2
6	5/8	1/4
		1/2
6	3/4	1/4
		1/2
6	1	1/4
		1/2
7	1/16	1/4
7	3/32	1/4
7	1/8	1/4
7	3/16	1/4
7	1/4	1/4
		1/2
7	5/16	1/4
		1/2
7	3/8	1/4
		1/2
7	1/2	1/4
		1/2
7	1	1/4
		1/2
8	1/16	1/4
8	3/32	1/4
8	1/8	1/4
8	3/16	1/4
8	1/4	1/4
		1/2
8	3/8	1/4
		1/2

CONTINUED

D	T	X
TYPE 1A1 – STRAIGHT WHEELS (CONT'D)		
8	1/2	1/4
		1/2
8	5/8	1/4
		1/2
8	3/4	1/4
		1/2
8	1	1/4
		1/2
9	1/2	1/4
		1/2
10	1/4	1/4
		1/2
10	3/8	1/4
		1/2
10	1/2	1/4
		1/2
10	3/4	1/4
		1/2
10	1	1/4
		1/2
11	1/2	1/4
		1/2
12	1/4	1/4
		1/2
12	3/8	1/4
		1/2
12	1/2	1/4
		1/2
12	5/8	1/4
		1/2
12	3/4	1/4
		1/2
12	1	1/4
		1/2
14	1/2	1/4
		1/2
14	3/4	1/4
		1/2
14	1	1/4
		1/2
16	1/2	1/4
		1/2
16	3/4	1/4
		1/2
16	1	1/4
		1/2
18	1/2	1/4
		1/2
18	1	1/4
		1/2
20	1/2	1/4
		1/2
20	3/4	1/4
		1/2
20	1	1/4
		1/2
24	3/4	1/4
		1/2
24	1	1/4
		1/2
30	1	1/4
		1/2

STANDARD PACKAGE = 1 WHEEL

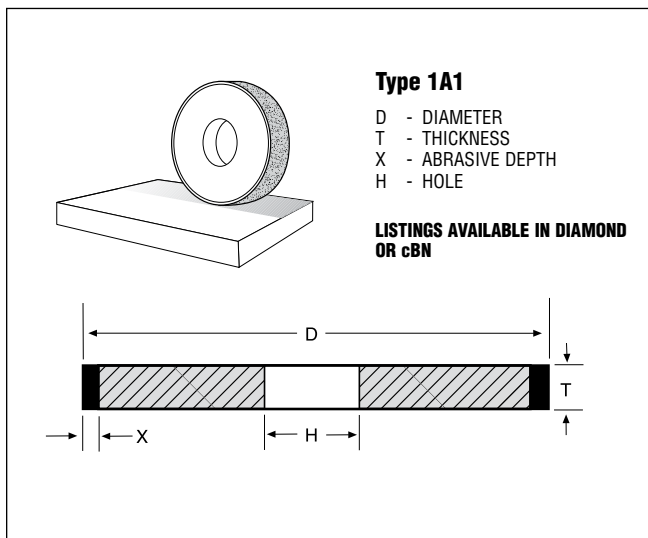

NORTON B99 EXPRESS MADE-TO-ORDER RESIN PRODUCTS

BLUEPRINT NUMBER	D	T	MINIMUM H	E	X	X1
TYPE 1A1R – CUT-OFF WHEELS						
ME43571	3	1/32	1/2	.022	1/4	3/16
ME93308	3	.035	1/2	.027	1/4	3/16
ME87950	4	.025	1/2	.017	1/8	3/32
ME77202	4	.031	1/2	.022	1/8	3/32
ME43570	4	1/32	1/2	.022	1/4	3/16
ME81257	4	.035	1/2	.027	1/8	3/32
ME86670	4	.035	1/2	.027	1/4	3/16
ME65456	4	1/16	1/2	.052	1/4	3/16
ME81104	5	.018	1/2	.015	1/8	3/32
ME80798	5	.025	1/2	.020	1/8	3/32
ME79842	5	.035	1/2	.030	1/8	3/32
ME76331	5	.040	1/2	.035	1/8	3/32
ME89529	5	1/16	1/2	.057	1/8	3/32
ME100815	5	1/8	1/2	.117	1/8	3/32
ME97801	6	.0305	1/2	.022	1/8	3/32
ME89709	6	1/32	1/2	.022	1/8	3/32
ME81121	6	1/32	1/2	.022	1/4	3/16
ME83187	6	.035	5/8	.027	1/8	1/16
ME80676	6	.035	1/2	.027	1/8	3/32
ME43572	6	.035	1/2	.027	1/4	3/16
ME73316	6	.035	1/2	.027	9/32	1/4
ME72577	6	.040	1/2	.032	1/4	3/16
ME83991	6	.045	1/2	.037	1/8	3/32
ME72002	6	.045	1/2	.037	1/4	3/16
ME74626	6	.050	1/2	.042	1/4	3/16
ME82694	6	.062	1/2	.054	1/8	3/32
ME69777	6	.062	1/2	.054	1/4	3/16
ME93344	6	.125	1/2	.117	1/8	3/32
ME82347	7	.035	1/2	.030	1/4	3/16
ME70075	7	.040	1/2	.030	1/4	3/16
ME75148	8	.035	5/8	.027	9/32	1/4
ME73768	8	.040	5/8	.027	1/4	3/16
ME106550	8	.045	5/8	.032	3/16	1/8
ME102293	8	.045	5/8	.027	1/4	3/16
ME43569	8	.045	5/8	.032	1/4	3/16
ME118534	8	.045	5/8	.032	5/16	1/4
ME43565	10	.050	5/8	.036	1/4	3/16
ME85766	10	1/16	5/8	.041	1/4	3/16
ME43567	12	.070	5/8	.056	1/4	3/16
ME106589	14	.070	3/4	.056	1/4	3/16

X1 = USABLE ABRASIVE DEPTH
STANDARD PACKAGE = 1 WHEEL

D	T	H
TYPE 1A8 – ID WHEELS		
1/4	1/8	1/8
5/16	1/4	1/8
3/8	1/32	1/8
3/8	1/4	1/8
3/8	3/8	1/8
3/8	1/2	1/8
3/8	1/2	3/16
7/16	3/8	1/8
7/16	1/2	1/8
1/2	1/4	1/8
1/2	1/4	1/4
1/2	3/8	1/8
1/2	1/2	1/8
1/2	1/2	3/16
1/2	1/2	1/4
1/2	5/8	1/4
9/16	1/2	1/4
9/16	3/4	1/4

D	T	H
TYPE 1A8 – ID WHEELS (CONT'D)		
5/8	1/4	1/4
5/8	3/8	1/4
5/8	1/2	3/16
5/8	1/2	1/4
5/8	5/8	1/4
5/8	3/4	1/4
3/4	1/32	3/16
3/4	1/16	1/8
3/4	1/4	1/4
3/4	3/8	1/4
3/4	1/2	1/4
3/4	3/4	1/4
7/8	1/2	1/4
7/8	5/8	1/4
1	1/16	1/4
1	1/4	1/4
1	1/2	1/4

STANDARD PACKAGE = 1 WHEEL

CONTINUED

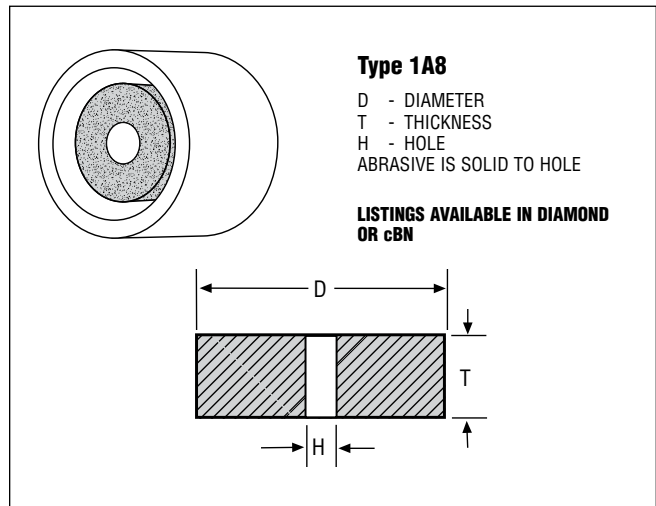
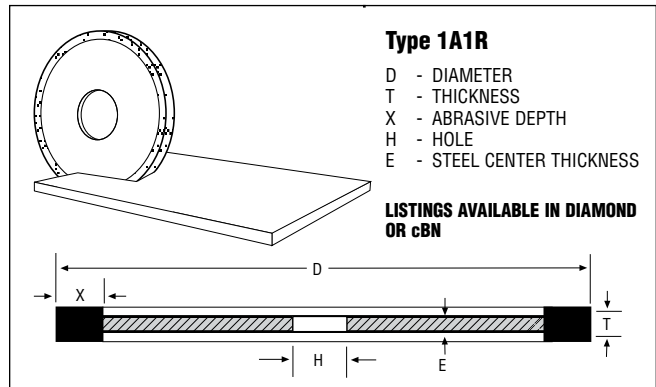

NORTON B99 EXPRESS MADE-TO-ORDER RESIN PRODUCTS

D	T	V	X
TYPE 1B1			
3	1/16	5° - 45°	1/8
3	1/16	5° - 71°	1/4
3	3/32	5° - 63°	1/8
4	1/16	5° - 45°	1/8
4	1/16	5° - 71°	1/4
4	3/32	5° - 33°	1/8
4	3/32	5° - 63°	1/4
6	1/16	5° - 45°	1/8
6	1/16	5° - 71°	1/4
6	3/32	5° - 33°	1/8
6	3/32	5° - 63°	1/4

STANDARD PACKAGE = 1 WHEEL

D	T	V	X
TYPE 1E1			
3	3/32	74° & LARGER	1/8
4	1/16	53° & LARGER	1/8
4	1/8	90° & LARGER	1/8
6	1/16	53° & LARGER	1/8
6	3/32	74° & LARGER	1/8
6	1/8	90° & LARGER	1/8

STANDARD PACKAGE = 1 WHEEL

D	T	V	X
TYPE 1EE1			
3	1/8	60°	1/8
3	1/8	70°	1/8
3	1/8	90°	1/8
3	3/16	60°	1/8
3	3/16	90°	1/8
3	1/4	60°	1/8
3	1/4	70°	1/8
3	1/4	90°	1/8
3	1/4	60°	1/4
3	1/2	90°	1/8
4	1/8	30°	1/8
4	1/8	45°	1/8
4	1/8	50°	1/8
4	1/8	60°	1/8
4	1/8	70°	1/8
4	1/8	90°	1/8
4	1/8	120°	1/8
4	1/4	45°	1/8
4	1/4	60°	1/8
4	1/4	70°	1/8
4	1/4	90°	1/8
4	1/4	60°	1/4
4	3/8	90°	1/8
4	3/8	120°	1/8
4	3/8	90°	1/4
4	3/4	45°	1/8
4	3/4	60°	1/8
5	1/8	45°	1/8
5	1/8	90°	1/8
5	3/8	90°	1/8
5	3/8	90°	1/4
6	1/8	60°	1/8
6	1/8	70°	1/8
6	1/8	90°	1/8
6	1/4	30°	1/8
6	1/4	45°	1/8
6	1/4	60°	1/8
6	1/4	70°	1/8
6	1/4	90°	1/8
6	1/4	60°	1/4
6	1/4	90°	1/4
6	3/8	30°	1/8
6	3/8	60°	1/8
6	3/8	90°	1/8
6	1/2	60°	1/8
6	1/2	90°	1/8
6	3/4	90°	1/8
7	1/8	60°	1/8
7	1/8	90°	1/8
7	1/4	45°	1/8
7	1/4	60°	1/8
7	1/4	70°	1/8
7	1/4	90°	1/8
7	3/8	60°	1/8
7	3/8	90°	1/8
7	3/8	120°	1/8
7	1/2	60°	1/8
7	1/2	90°	1/8
7	1/2	100°	1/8

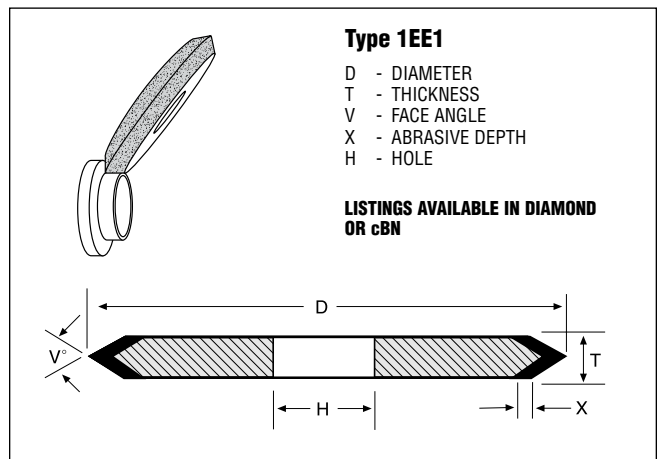
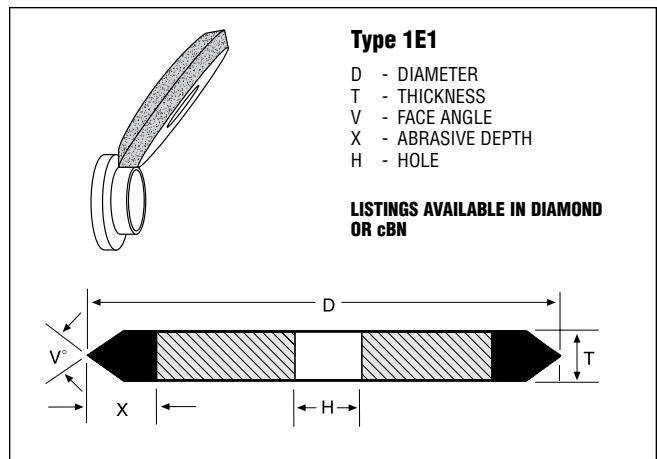
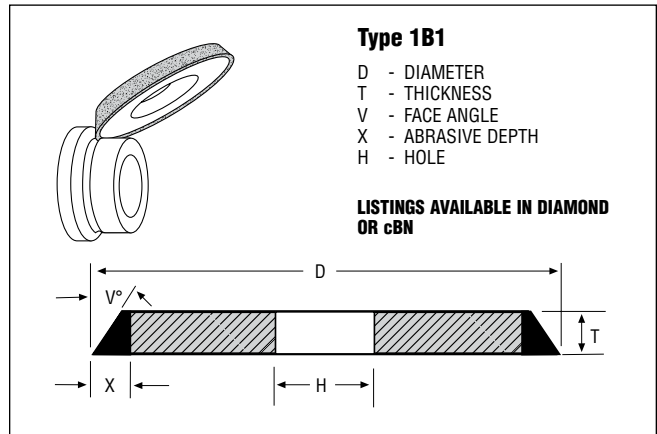

CUSTOMER TO SPECIFY HOLE SIZE, SUBJECT TO SAFETY STANDARDS.

D	T	MIN. R	X
TYPE 1F1 – RADIUS WHEELS			
3	1/16	1/32	1/8 1/4
3	3/32	3/64	1/8 1/4
4	1/16	1/32	1/8 1/4
4	3/32	3/64	1/8 1/4
4	1/8	1/16	1/8 1/4
4	3/16	3/32	1/8 1/4
5	1/16	1/32	1/8 1/4
5	3/32	3/64	1/8 1/4
6	1/16	1/32	1/8 1/4
6	3/32	3/64	1/8 1/4
6	1/8	1/16	1/8 1/4
6	1/4	1/8	1/4

STANDARD PACKAGE = 1 WHEEL

D	T	R	X
TYPE 1FF1 – RADIUS WHEELS			
3	1/8	1/16	1/8
3	1/4	1/8	1/8
3	3/16	3/32	1/8
3	3/8	3/16	1/8
3	1/2	1/4	1/8
4	1/8	1/16	1/8
4	5/32	5/64	1/8
4	3/16	3/32	1/8
4	7/32	7/64	1/8
4	1/4	1/8	1/8 1/4
4	5/16	5/32	1/8
4	3/8	3/16	1/8
4	1/2	1/4	1/8
5	1/8	1/16	1/8
5	3/16	3/32	1/8
5	1/4	1/8	1/8

CONTINUED

D	T	R	X
TYPE 1FF1 – RADIUS WHEELS (CONT'D)			
6	1/8	1/16	1/8
6	5/32	5/64	1/8
6	3/16	3/32	1/8 1/4
6	1/4	1/8	1/8
6	5/16	5/32	1/4
6	3/8	3/16	1/8
6	1/2	1/4	1/8
6	5/8	5/16	1/8
7	1/8	1/16	1/8
7	3/16	3/32	1/8
7	1/4	1/8	1/8
7	3/8	3/16	1/8
7	1/2	1/4	1/8

STANDARD PACKAGE = 1 WHEEL

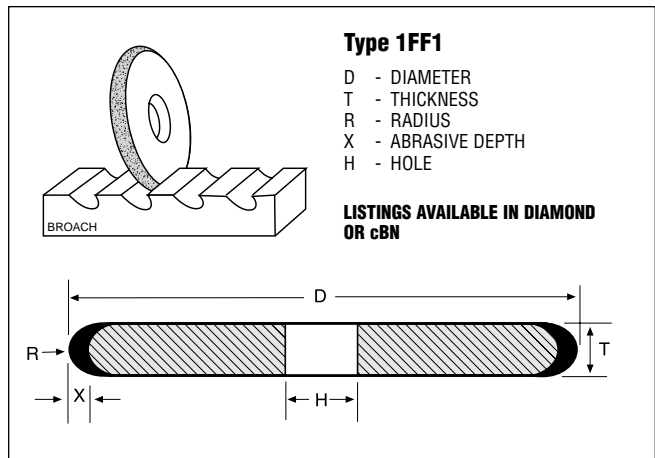
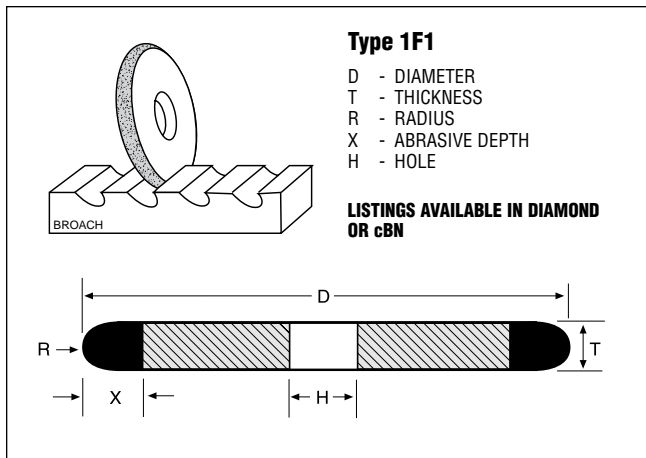

CUSTOMER TO SPECIFY HOLE SIZE, SUBJECT TO SAFETY STANDARDS.

NORTON B99 EXPRESS MADE-TO-ORDER RESIN PRODUCTS

D	T	V	X
TYPE 1V1			
2	1/8	20°	1/8
2	1/8	30°	1/8
2	1/8	45°	1/8
2	1/4	30°	1/8
2	1/4	45°	1/8
3	1/8	15°	1/8
3	1/8	30°	1/8
3	1/8	45°	1/8
3	1/8	60°	1/8
3	1/8	30°	1/4
3	1/8	45°	1/4
3	1/4	20°	1/8
3	1/4	30°	1/8
3	1/4	45°	1/8
4	1/8	15°	1/8
4	1/8	20°	1/8
4	1/8	30°	1/8
4	1/8	45°	1/8
4	1/8	15°	1/4
4	3/16	15°	1/8
4	3/16	20°	1/8
4	3/16	30°	1/8
4	3/16	45°	1/8
4	1/4	15°	1/8
4	1/4	20°	1/8
4	1/4	25°	1/8
4	1/4	30°	1/8
4	1/4	45°	1/8
4	1/4	15°	1/4
4	3/8	15°	1/8
4	3/8	20°	1/8
4	3/8	25°	1/8
4	3/8	30°	1/8
4	3/8	45°	1/8
4	1/2	15°	1/8
4	1/2	30°	1/8
4	1/2	45°	1/8
5	1/8	45°	1/8
5	3/16	45°	1/8
5	1/4	30°	1/8

CONTINUED

D	T	V	X
TYPE 1V1 (CONTD)			
5	1/4	15°	1/4
5	1/4	25°	1/4
5	1/4	30°	1/4
5	3/8	15°	1/4
6	1/8	45°	1/8
6	1/8	15°	1/4
6	1/8	20°	1/4
6	1/8	30°	1/4
6	1/8	45°	1/4
6	3/16	30°	1/8
6	3/16	45°	1/8
6	3/16	15°	1/4
6	1/4	15°	1/8
6	1/4	25°	1/8
6	1/4	30°	1/8
6	1/4	45°	1/8
6	1/4	15°	1/4
6	1/4	30°	1/4
6	1/4	45°	1/4
6	5/16	15°	1/8
6	5/16	12°	1/4
6	3/8	45°	1/8
6	3/8	10°	1/4
6	3/8	20°	1/4
6	3/8	30°	1/4
6	1/2	20°	1/8
6	1/2	45°	1/8
7	1/8	60°	1/8
7	1/4	10°	1/8
7	1/4	20°	1/8
7	1/4	30°	1/8
7	1/4	45°	1/8
7	3/8	10°	1/8
7	3/8	20°	1/8
7	3/8	45°	1/8
7	1/2	25°	1/8
7	1/2	30°	1/8
7	1/2	35°	1/8
7	1/2	45°	1/8

STANDARD PACKAGE = 1 WHEEL

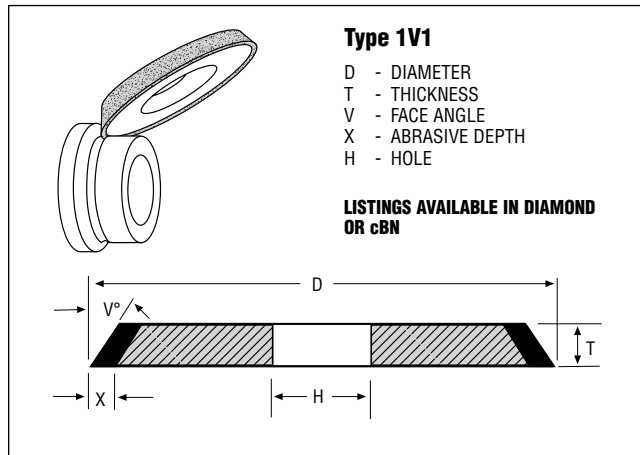

CUSTOMER TO SPECIFY HOLE SIZE, SUBJECT TO SAFETY STANDARDS.

REMEMBER TO CHECK NORTON STOCK AND NORTON/WINTER STOCK AVAILABILITY FIRST, FOR THE FASTEST DELIVERY AND LOWEST PRICE.

BLUEPRINT		D	T	H	W	N	B.C.	TH'D	X
TYPE 2A2T – RING WHEELS									
C	MC37792	10	13/16 15/16	8	1/4	6	9.000	3/8-16 NC	1/8 1/4
B	ME69812	10	13/16	8	3/8	6	9.000	3/8-16 NC	1/8
B	ME65611	10	7/8 1	8	1/2	6	9.000	3/8-16 NC	1/8 1/4
A	ME39973	10	3/4 7/8	9	1/2	6	9.500	1/4-20 NC	1/8 1/4
B	MC93183	10	3/4	8	3/4	6	9.000	3/8-16 NC	1/8
A	MC35771	10	3/4	8	1	6	9.000	3/8-16 NC	1/8
C	MB91584	11	13/16	9	1/4	6	10.000	3/8-16 NC	1/8
C	MC41891	11	13/16 15/16	9	1/2	6	10.000	3/8-16 NC	1/8 1/4
A	MC45060	11	3/4 7/8	9-1/2	3/4	6	10.250	5/16-18 NC	1/8 1/4
A	MB39846	11	3/4	9	1	6	10.000	3/8-16 NC	1/8
A	MC90807	16	3/4	15	1/2	12	15.500	1/4-20 NC	1/8 1/4
B	MC87885	18	7/8 1	16-9/16	1/4	12	17.250	5/16-18 NC	1/8 1/4
B	ME73188	18	7/8 1	16-1/2	3/8	12	17.250	5/16-18 NC	1/8 1/4
B	MC88985	18	7/8 1	16	1/2	12	17.000	3/8-16 NC	1/8 1/4
A	MC47306	18	7/8 1	16-1/2	3/4	12	17.250	5/16-18 NC	1/8 1/4
A	MC38343	18	3/4 7/8	16	1	12	17.000	3/8-16 NC	1/8 1/4

NOTE: 2A2T DOES NOT INCLUDE ADAPTER. CONTACT YOUR LOCAL NORTON DISTRIBUTOR FOR PRICE, DELIVERY AND APPLICATION INFORMATION. STANDARD PACKAGE = 1 WHEEL

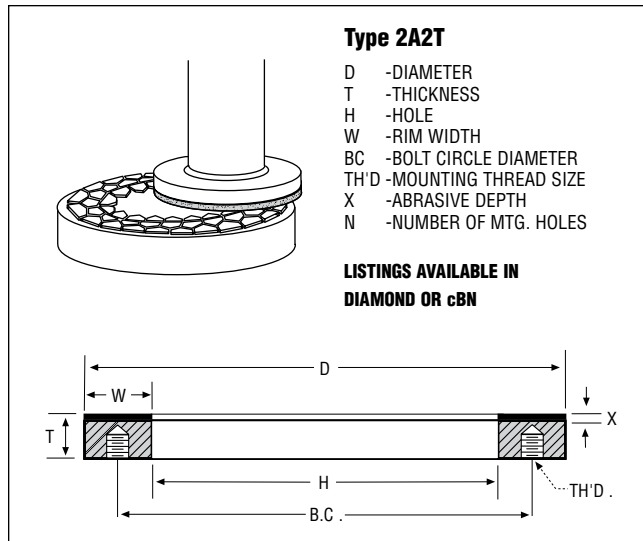
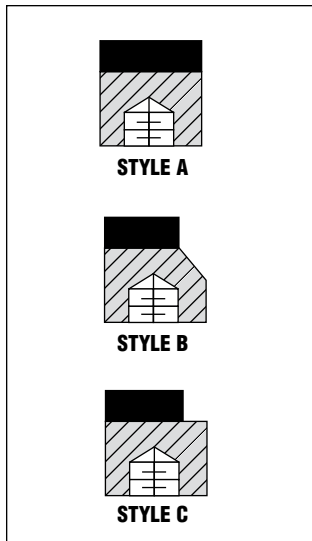

BLUEPRINT NUMBER	D	T	U	J	D2	X
TYPE 3A1 – HUB 1-SIDE WHEELS						
ME114297	3-1/2	1/4	1/8	2-3/4	2-15/16	1/8
ME92383	5	5/16	1/16	3-3/4	4-3/16	1/8
ME66716	5	3/8	1/8	3-3/4	4-3/16	1/8
ME74734	6	1/4	1/8	5-1/16	5-1/4	1/8
ME60795	6	3/8	1/8	5	5-1/2	1/8
ME87172	6	3/8	1/16	4-13/16	5-7/16	1/8
ME87805	6	3/8	1/32	4-15/16	5-5/8	1/8
ME128352	12-1/4	3/8	3/16	11-3/4	—	1/8

STANDARD PACKAGE = 1 WHEEL

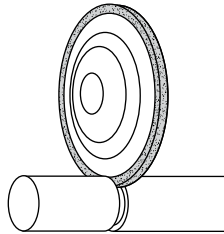

Type 3A1

- D - DIAMETER
- T - THICKNESS
- H - HOLE
- U - ABRASIVE THICKNESS
- J - HUB DIAMETER
- D2 - LARGE HUB DIAMETER
- X - ABRASIVE DEPTH

LISTINGS AVAILABLE IN DIAMOND OR cBN

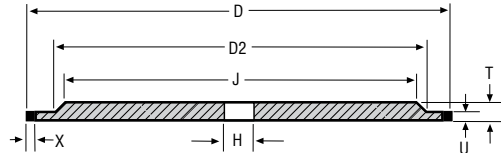

Type 3A1 – Specific Blueprints

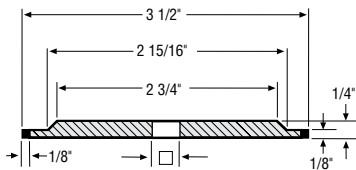

ME114297

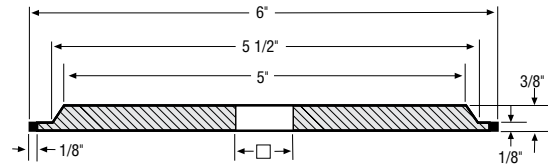

ME60795

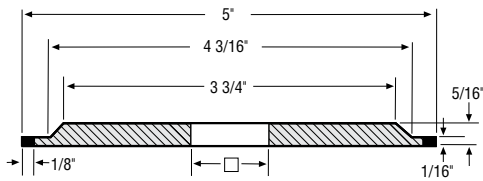

ME92383

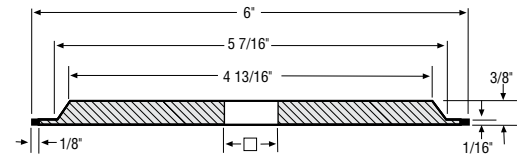

ME87172

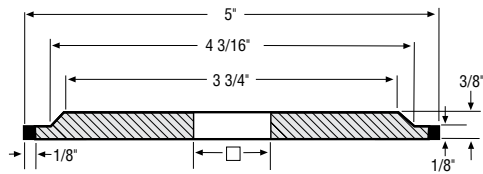

ME66716

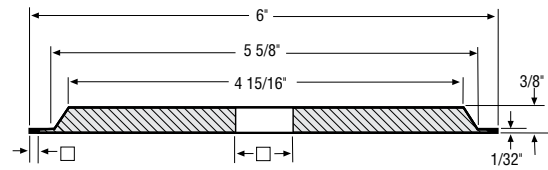

ME87805

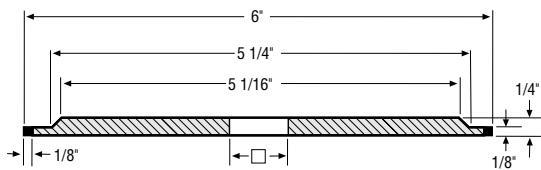

ME74734

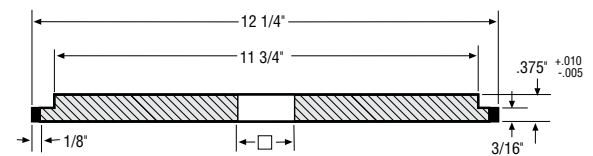

ME128352

VARIABLE

CUSTOMER TO SPECIFY HOLE SIZE, SUBJECT TO SAFETY STANDARDS.

BLUEPRINT NUMBER	D	T	W	J	X
TYPE 4A2P – DISH (SAW SHARPENING) WHEELS					
ME84209	6	3/8 7/16	1/8	2-1/4	1/16 1/8
ME80016	6	3/8 7/16	3/16	2-1/4	1/16 1/8
ME94471	6	1/2 9/16	3/16	3-1/2	1/16 1/8
ME105175	6	17/64 21/64	1/4	3	1/16 1/8
ME88369	6	3/8 7/16	1/4	2-1/4	1/16 1/8
ME97016	6	3/8	1/4	3	1/16
ME91942	6	3/8 7/16	1/4	4-1/4	1/16 1/8
ME83387	6	3/8 7/16	3/8	3	1/16 1/8

STANDARD PACKAGE = 1 WHEEL

Type 4A2P

- D - DIAMETER
- T - THICKNESS
- H - HOLE
- J - HUB DIAMETER
- W - RIM WIDTH
- X - ABRASIVE DEPTH

LISTINGS AVAILABLE IN
DIAMOND OR cBN

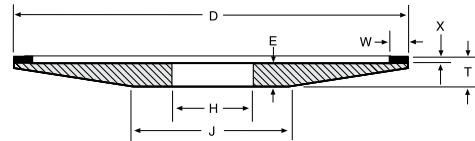
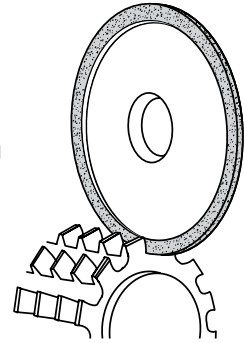

Type 4A2P – Specific Blueprints

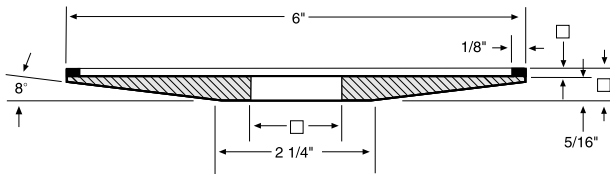

ME84209

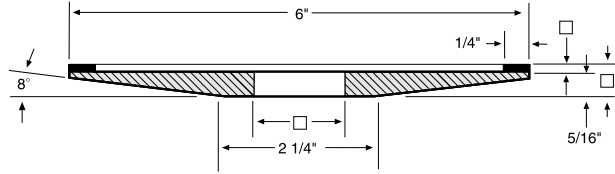

ME88369

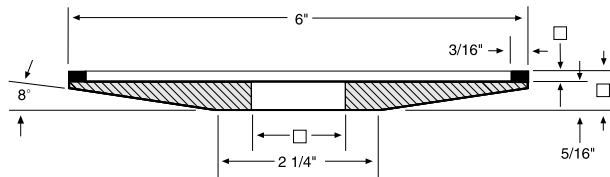

ME80016

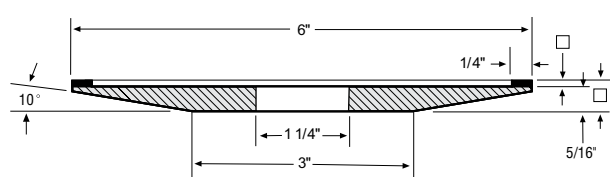

ME97016

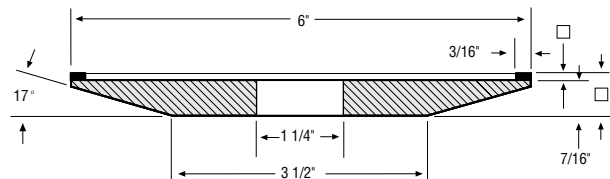

ME94471

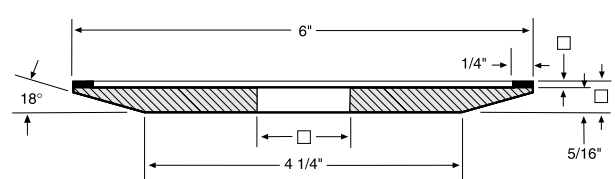

ME91942

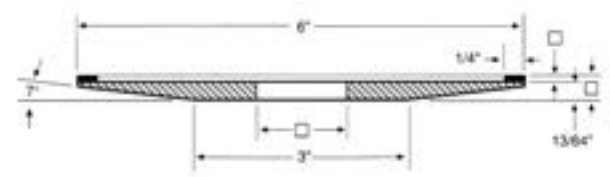

ME105175

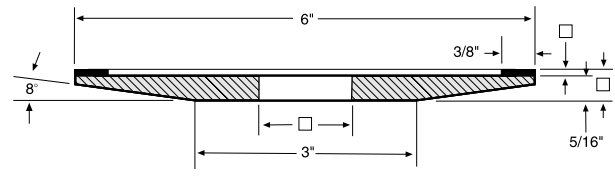

ME83387

VARIABLE

BLUEPRINT NUMBER	D	T	F	V	X
TYPE 4Y1					
ME35789	6	1/8	1/16	45°	1/8
ME65953	6	1/4	1/8	30°	1/8
ME54623	6	1/4	1/8	45°	1/8
ME54649	6	3/8	3/16	45°	1/8
ME38936	6	1/2	1/4	45°	1/8
ME98975	6	1/2	1/4	45°	1/8
ME57664	7	1/4	1/8	45°	1/8
ME68742	7	3/8	3/16	45°	1/8

STANDARD PACKAGE = 1 WHEEL

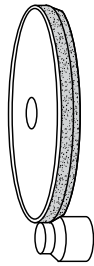

Type 4Y1

- D - DIAMETER
- T - THICKNESS
- H - HOLE
- V - FACE ANGLE
- F - ABRASIVE FLAT
- X - ABRASIVE DEPTH

LISTINGS AVAILABLE IN DIAMOND OR cBN

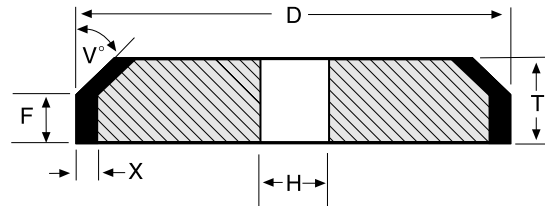

Type 4Y1 – Specific Blueprints

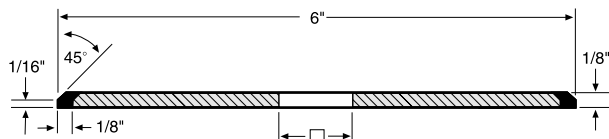

ME35789

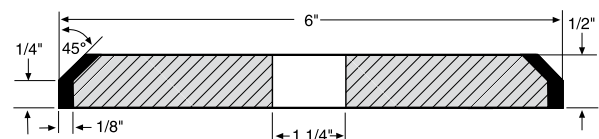

ME38936

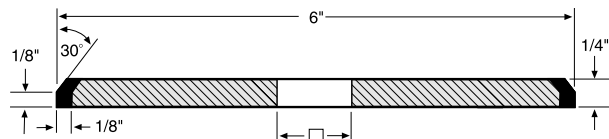

ME65953

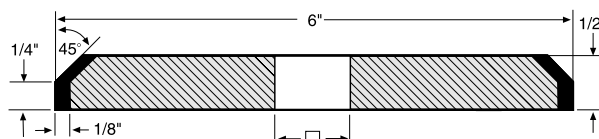

ME98975

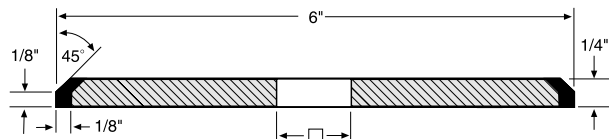

ME54623

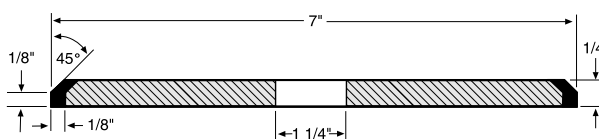

ME57664

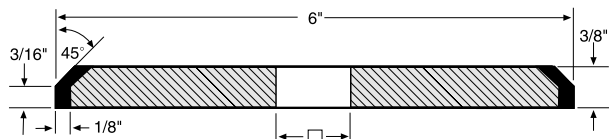

ME54649

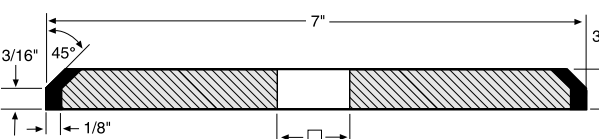

ME68742

VARIABLE

BLUEPRINT NUMBER	D	T	W	E	X
TYPE 6A2 – STRAIGHT CUP WHEELS					
ME156751	2	1/2 9/16	1/2	1/4	1/16 1/8
ME156752	3	3/4 13/16	3/8	3/8	1/16 1/8
ME156755	4	3/4 13/16	1/4	3/8	1/16 1/8
ME156756	4	3/4 13/16	3/8	3/8	1/16 1/8
ME156754	4	3/4 13/16	1/2	3/8	1/16 1/8
ME156757	5	3/4 13/16	3/8	3/8	1/16 1/8
ME156758	6	9/16 5/8	1/4	3/8	1/16 1/8
ME156763	6	3/4 13/16	1/8	3/8	1/16 1/8
ME156761	6	3/4 13/16	3/16	3/8	1/16 1/8
ME156764	6	3/4 13/16	1/4	3/8	1/16 1/8
ME156759	6	3/4 13/16	3/8	3/8	1/16 1/8
ME156762	6	3/4 13/16	1/2	3/8	1/16 1/8
ME156760	6	3/4 13/16	3/4	3/8	1/16 1/8
ME156765	6	3/4 13/16	1	3/8	1/16 1/8
ME156766	6	1.575 1.637	1/2	5/8	1/16 1/8
ME156767	7	3/4 13/16	1/2	3/8	1/16 1/8
ME156768	8	3/4 13/16	3/4	3/8	1/16 1/8
ME156769	10	15/16 1	1	1/2	1/16 1/8

STANDARD PACKAGE = 1 WHEEL

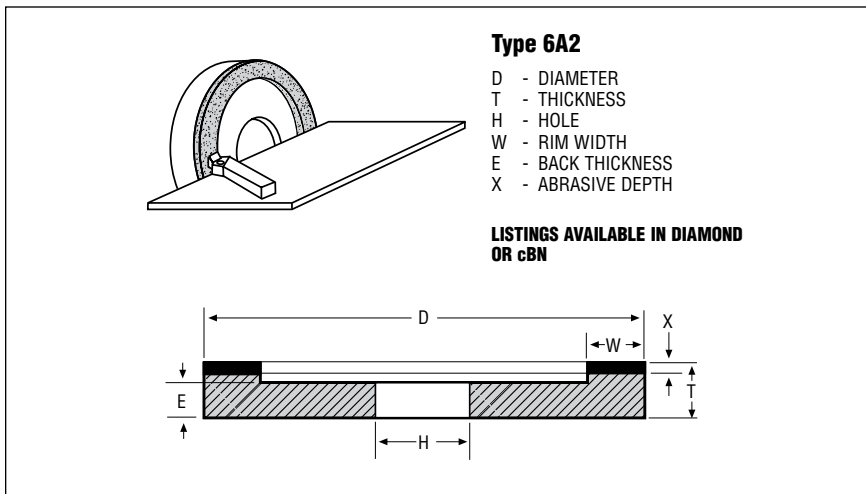

CUSTOMER TO SPECIFY HOLE SIZE, SUBJECT TO SAFETY STANDARDS.

BLUEPRINT NUMBER	D	T	W	N	D	E	B.C.	X
TYPE 6A2C – STRAIGHT CUP WHEELS WITH MOUNTING HOLES								
ME36743	6	3/4 13/16	1/4	4	9/32	7/16	3-1/4	1/16 1/8
ME27852	6	3/4 13/16 13/16	3/8	4	9/32	7/16	3-1/4	1/16 1/8 1/4
ME30621	6	3/4 13/16 13/16	1/2	4	9/32	7/16	3-1/4	1/16 1/8 1/4
ME27853	6	3/4 13/16 13/16	3/4	4	9/32	7/16	3-1/4	1/16 1/8 1/4
ME27854	6	3/4 13/16	1	4	9/32	7/16	3-1/4	1/16 1/8
ME54263	7	1-1/4 1-5/16	1	4	9/32	1/2	1-7/8	1/16 1/8
ME34522	10	1 1-1/16	3/4	6	11/32	3/4	3-1/2	1/16 1/8
ME34647	10	1 1-1/16	1	6	11/32	3/4	3-1/2	1/16 1/8

STANDARD PACKAGE = 1 WHEEL

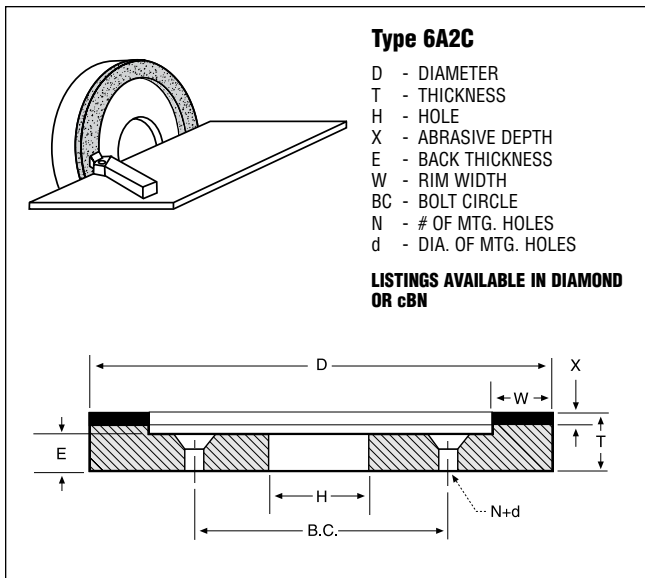

SEE SPECIFIC TYPE 6A2C BLUEPRINTS ON THE FOLLOWING PAGE.

NORTON OFFERS A COMPREHENSIVE STOCK PRODUCT SELECTION TO SERVICE MOST OF YOUR NEEDS – WITH THE FASTEST DELIVERY AND LOWEST PRICES. SEE THESE CATALOG SECTIONS FIRST:

- Norton Stock B99 Products
- Norton/Winter Stock Toolroom Products

Can't find the specification in the above sections?

Then refer to this B99 Express Made-to-Order Resin Product section.

If a product can not be found in the B99 Express offering:

Contact your Norton sales representative or distributor for a custom-made product recommendation.

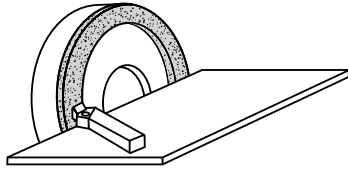

Type 6A2C

- D - DIAMETER
- T - THICKNESS
- H - HOLE
- X - ABRASIVE DEPTH
- E - BACK THICKNESS
- W - RIM WIDTH
- BC - BOLT CIRCLE
- N - # OF MTG. HOLES
- D - DIA. OF MTG. HOLES

LISTINGS AVAILABLE IN DIAMOND OR cBN

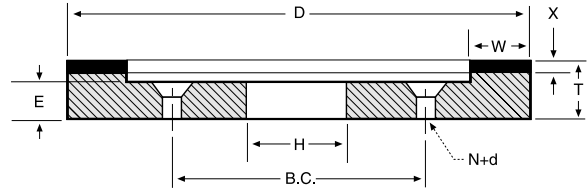

Type 6A2C – Specific Blueprints (Continued)

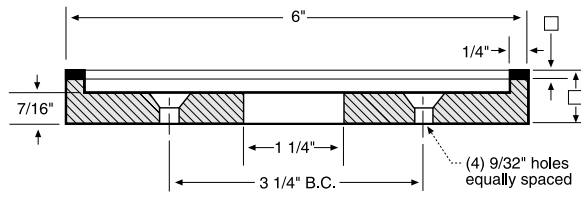

ME36743

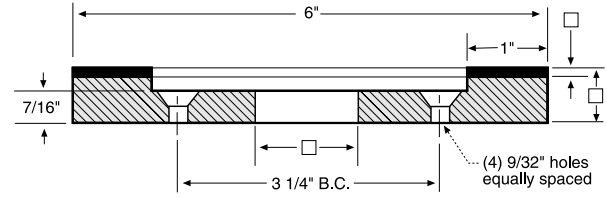

ME27854

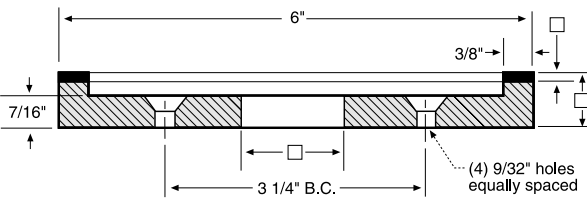

ME27852

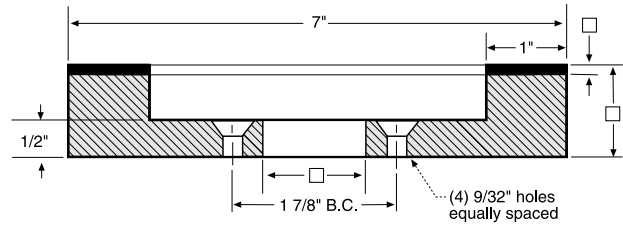

ME54263

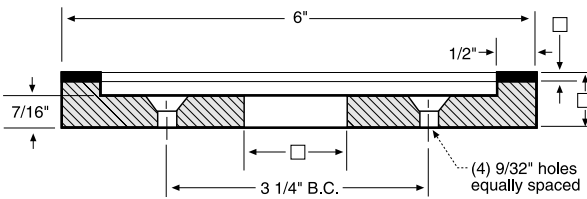

ME30621

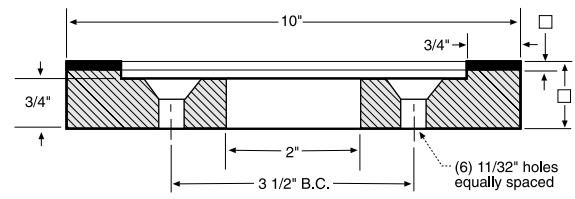

ME34522

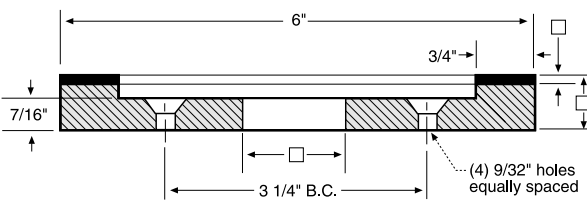

ME27853

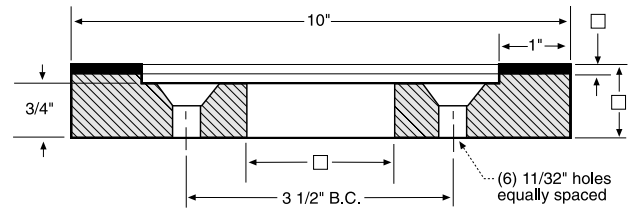

ME34647

VARIABLE

CUSTOMER TO SPECIFY HOLE SIZE, SUBJECT TO SAFETY STANDARDS.

BLUEPRINT NUMBER	D	T	U	E	K	X
TYPE 6A9 – STRAIGHT CUP WHEELS						
ME57851	3	1-1/2	1/2	3/8	2-1/2	1/16 1/8
ME59701	4	1-1/4	3/8	1/2	3	1/16 1/8
ME57805	5	1-1/2	7/16	1/2	4-1/4	1/16 1/8
ME41681	6	1-1/2	7/16	1/2	5-1/16	1/16 1/8
ME100028	8	2	1/2	3/4	7-1/4	1/8
ME106885	12	1-3/8	1/4	1-1/16	11-1/8	3/16

STANDARD PACKAGE = 1 WHEEL

Type 6A9

- D - DIAMETER
- T - THICKNESS
- H - HOLE
- E - BACK THICKNESS
- U - INSERT LENGTH
- K - INSIDE DIAMETER
- X - ABRASIVE DEPTH

LISTINGS AVAILABLE IN DIAMOND OR cBN

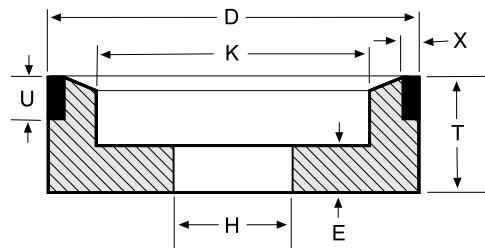

Type 6A9 – Specific Blueprints

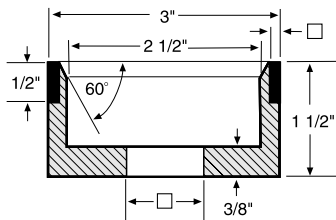

ME57851

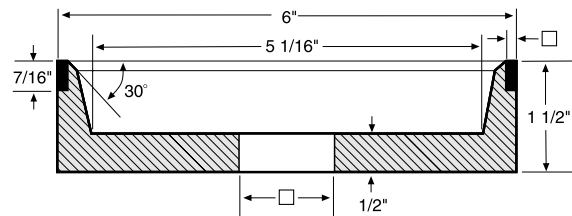

ME41681

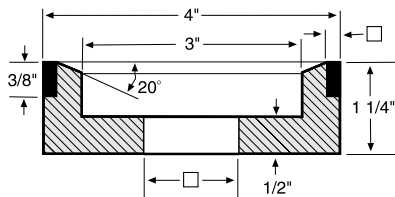

ME59701

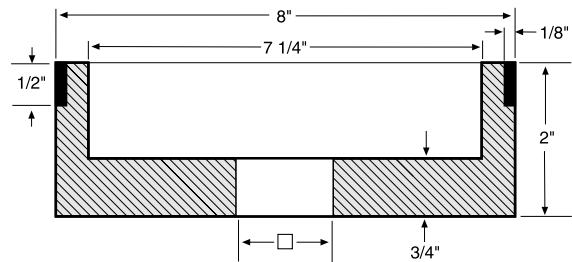

ME100028

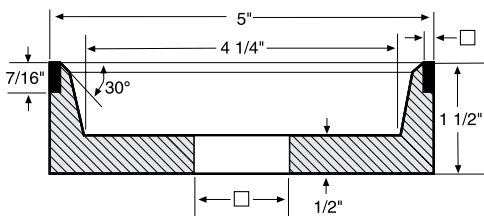

ME57805

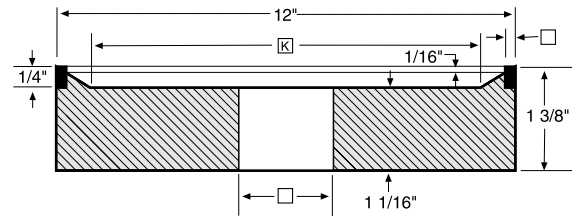

ME106885

□ VARIABLE

BLUEPRINT NUMBER	D	T	W	E	K	X
TYPE 11A2 – CUP WHEELS						
ME26849	3	7/8	3/8	5/16	1-3/4	1/8
ME31815	3	1-5/16	3/8	3/8	1-3/4	1/8
ME28280	3-1/2	1-5/16	3/8	3/8	2-1/4	1/8
ME27793	4	1-1/4	1/2	1/2	2-1/4	1/8
ME33862	5	1-3/4	3/8	1/2	3-1/2	1/8
ME101095	6	1-9/16	3/8	1/2	5-9/64	1/8
		1-11/16				1/4
ME100998	6	1-1/2	1/2	1/2	4-11/16	1/8
		1-5/8				1/4
ME128467	6	1-1/2	1/4	1/2	5-1/32	1/8
					5-3/16	1/4

STANDARD PACKAGE = 1 WHEEL

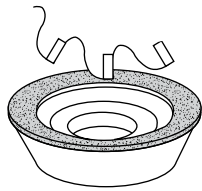

Type 11A2

- D - DIAMETER
- T - THICKNESS
- H - HOLE
- E - BACK THICKNESS
- J - HUB DIAMETER

- K - INSIDE DIAMETER OF FLAT
- W - RIM WIDTH
- X - ABRASIVE DEPTH

LISTINGS AVAILABLE IN
DIAMOND OR cBN

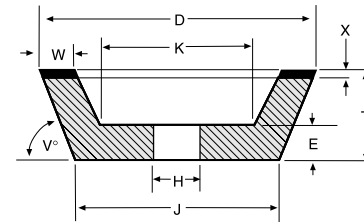

Type 11A2 – Specific Blueprints

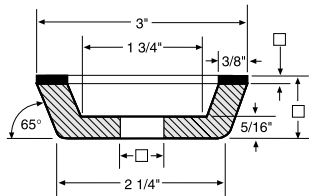

ME26849

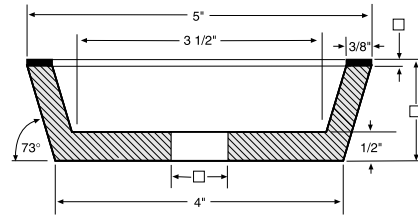

ME33862

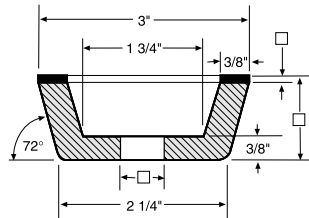

ME31815

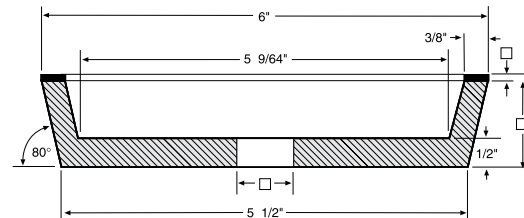

ME101095

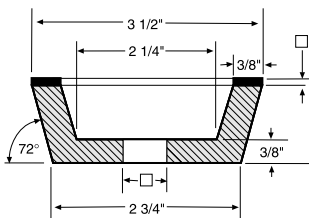

ME28280

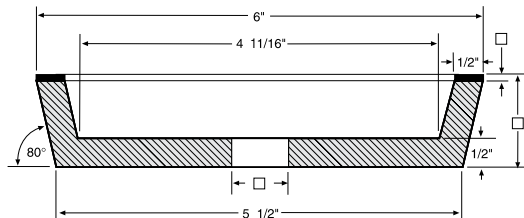

ME100998

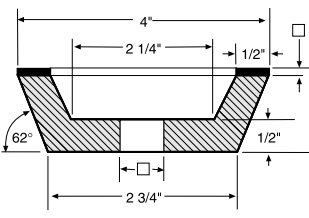

ME27793

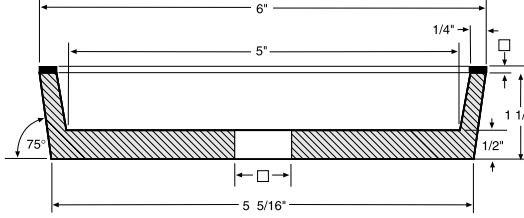

ME128467

VARIABLE

CUSTOMER TO SPECIFY HOLE SIZE, SUBJECT TO SAFETY STANDARDS.

STYLE	BLUEPRINT NUMBER	D	T	S	U	X
TYPE 11V9 – FLARING CUP WHEELS						
B	ME51239*	1	5/8	80°	1/4	1/16 1/8
A	ME88398*	1-1/2	5/8	80°	1/4	1/8
B	ME51238*	1-1/2	5/8	80°	1/4	1/8
B	ME58512*	1-1/2	7/8	70°	1/4	1/16
B	ME89516*	2	5/8	60°	1/4	3/32
B	ME55562*	2	7/8	60°	5/16	1/16 1/8
B	ME42599*	2	1	75°	3/8	1/16 1/8
A	ME93912	3	1-1/4	70°	3/8	1/16 1/8
A	ME92192	3-3/4	1-1/2	70°	3/8	1/16 1/8
A	ME130503	100MM	35MM	70°	6MM	1.5MM 3.0MM
A	ME130500	100MM	35MM	70°	10MM	1.5MM 3.0MM
A	ME130501	125MM	40MM	70°	10MM	1.5MM 3.0MM
A	ME98298	5	1-3/4	70°	7/16	1/16 1/8
A	ME85913	6	1-3/4	70°	1/2	1/16 1/8

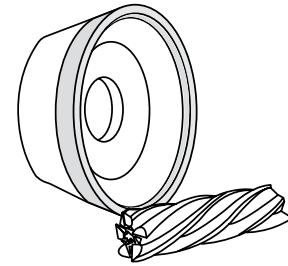

Type 11V9

- D - DIAMETER
- T - THICKNESS
- H - HOLE
- E - BACK DIAMETER
- J - HUB DIAMETER
- K - INSIDE DIAMETER OF FLAT
- U - INSERT LENGTH
- S - FACE ANGLE
- X - ABRASIVE DEPTH

LISTINGS AVAILABLE IN DIAMOND OR cBN

*SEE BLUEPRINT FOR MAXIMUM HOLE SIZE. STANDARD PACKAGE = 1 WHEEL

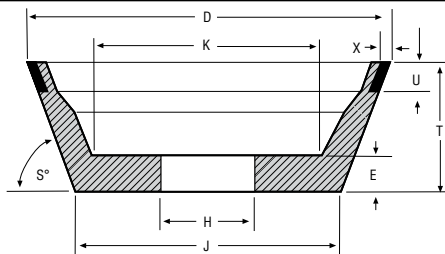

STYLE A

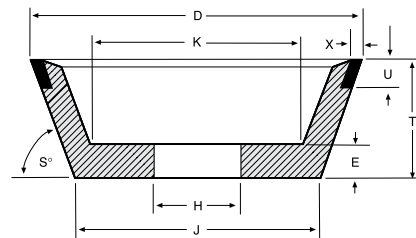

STYLE B

Type 11V9 – Specific Blueprints

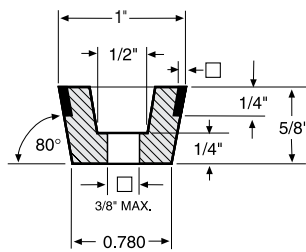

ME51239

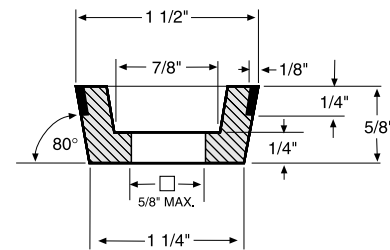

ME51238

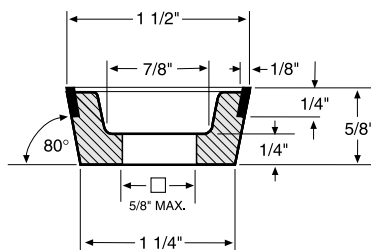

ME88398

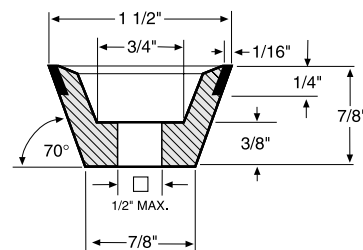

ME58512

VARIABLE

SEE ADDITIONAL TYPE 11V9 BLUEPRINTS ON THE FOLLOWING PAGES.

Type 11V9 – Specific Blueprints (continued)

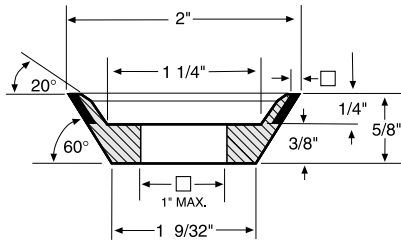

ME89516

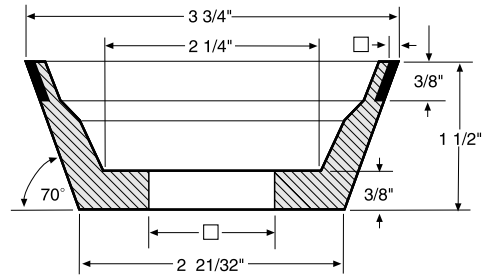

ME92192

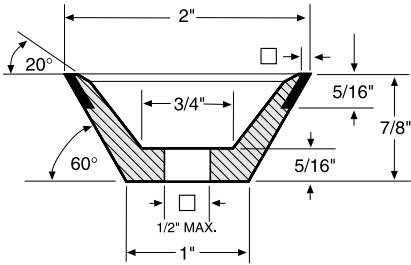

ME55562

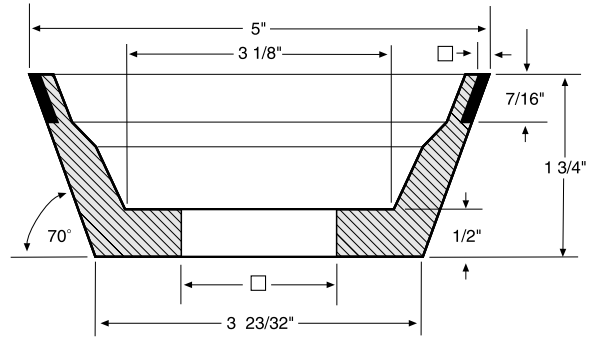

ME98298

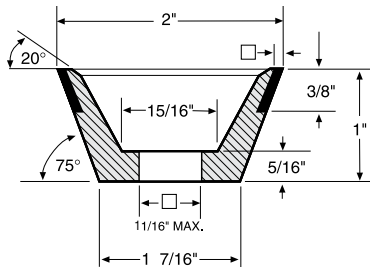

ME42599

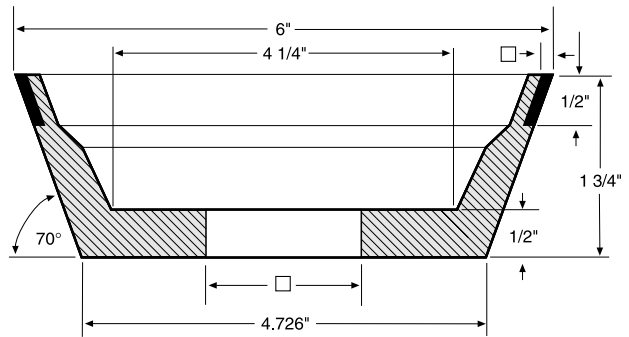

ME85913

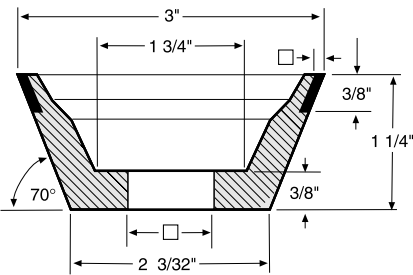

ME93912

VARIABLE

CUSTOMER TO SPECIFY HOLE SIZE, SUBJECT TO SAFETY STANDARDS.

Type 11V9 – Specific Blueprints – Metric

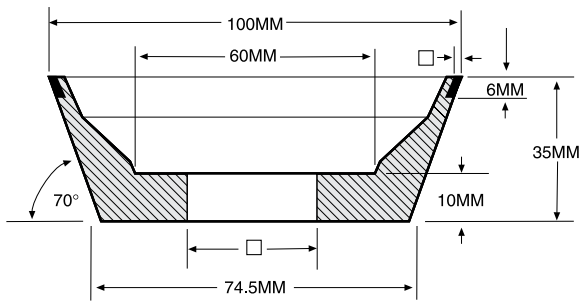

ME130503

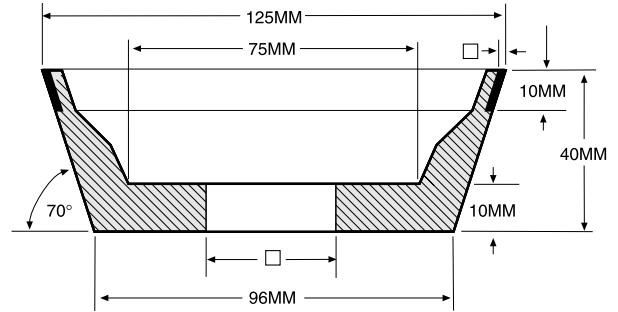

ME130501

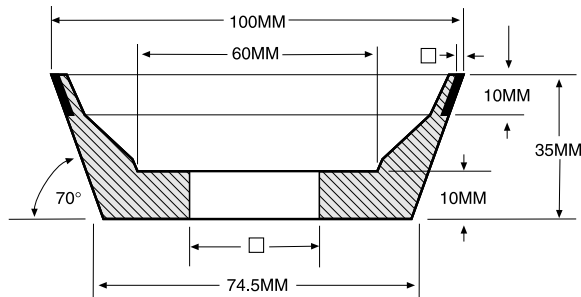

ME130500

VARIABLE

BLUEPRINT NUMBER	D	T	W	E	K	X
TYPE 12A2 – DISH WHEELS						
ME40747	3	9/16	1/4	5/16	1-1/2	1/8
ME27757	3	15/16	1/8	3/8	1-1/2	1/8
ME27174*	3	15/16	1/4	3/8	1-1/2	1/8
ME40745	4	9/16	1/4	5/16	2-1/4	1/8
ME40746	4	9/16	3/8	5/16	2-1/4	1/8
ME73686	6	9/16	3/16	5/16	3-1/4	1/8
ME27758	6	1-1/16	3/16	1/2	2-5/8	1/8
ME27175	6	1-1/16	1/4	1/2	2-5/8	1/8
ME33914	6	1-1/16	3/8	1/2	2-5/8	1/8
ME73752	8	1-3/32	3/8	15/16	4-5/8	5/32

*SEE BLUEPRINT FOR MAXIMUM HOLE SIZE.

STANDARD PACKAGE = 1 WHEEL

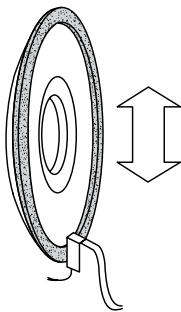

Type 12A2

- D - DIAMETER
- T - THICKNESS
- H - HOLE
- E - BACK THICKNESS
- J - HUB DIAMETER
- K - INSIDE DIAMETER OF FLAT
- W - RIM WIDTH
- X - ABRASIVE DEPTH

**LISTINGS AVAILABLE IN
DIAMOND OR cBN**

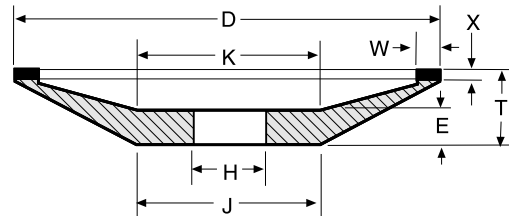

SEE SPECIFIC TYPE 12A2 BLUEPRINTS ON THE FOLLOWING PAGE.

Type 12A2 – Specific Blueprints (continued)

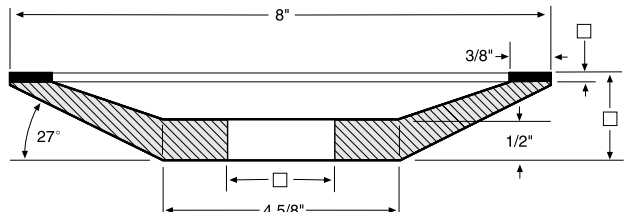
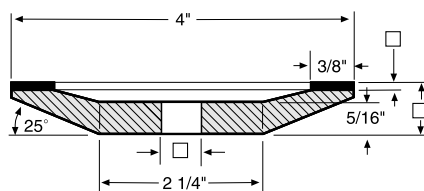
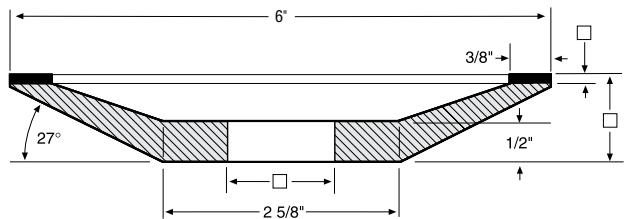
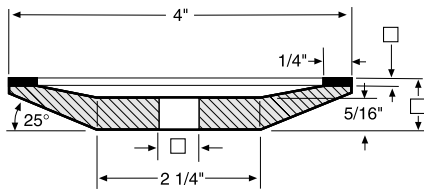
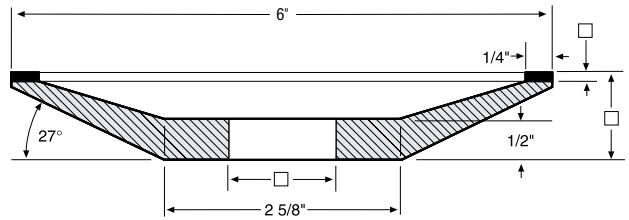
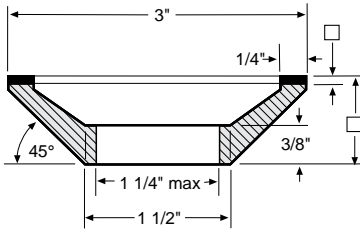
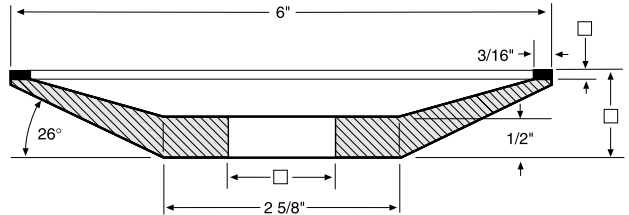
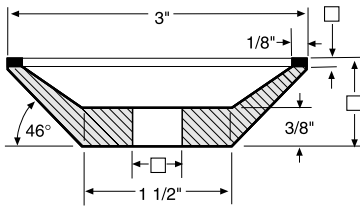
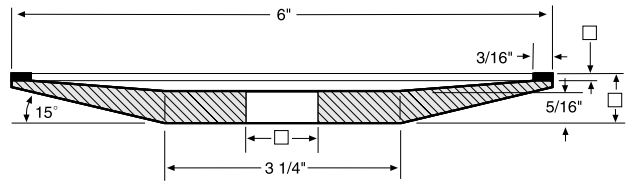
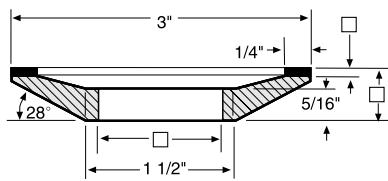

 VARIABLE

CUSTOMER TO SPECIFY HOLE SIZE, SUBJECT TO SAFETY STANDARDS.

REMEMBER TO CHECK NORTON STOCK AND NORTON/WINTER STOCK AVAILABILITY FIRST, FOR THE FASTEST DELIVERY AND LOWEST PRICE.

BLUEPRINT NUMBER	D	T	E	K	S	U	X
TYPE 12V9 – DISH WHEELS							
ME41755	3	7/16	5/16	1-1/2	30°	7/16	1/16 1/8
ME78406*	3	1/2	1/4	1-1/2	30°	1/4	1/8
ME69978	3	13/16	3/8	1-3/8	45°	11/32	1/16 1/8
ME37191*	3	13/16	3/8	1-3/8	45°	1/2	1/16 1/8
ME58734	4	1/2	1/4	2-1/4	30°	1/4	1/16 1/8
ME80849	4	7/8	3/8	2-1/4	45°	13/32	1/16 1/8
ME120095	5	.709	.394	3-13/32	45°	.394	3/32
ME73312	6	1/2	5/16	4-17/64	30°	3/8	1/16 1/8
ME109758	6	3/4	3/8	2-1/4	25°	1/2	1/16
ME98875	6	3/4	.610	2-1/2	25°	1/2	.148
ME48666	6	3/4	3/8	3-13/32	30°	3/8	1/16 1/8
ME118022	6	1	1/2	3-1/32	30°	1/2	1/16 1/8
ME44377	6	1	1/2	4	45°	3/8	1/8
ME54386	6	1-1/2	3/8	3	45°	17/32	1/16

*SEE BLUEPRINT FOR MAXIMUM HOLE SIZE. STANDARD PACKAGE = 1 WHEEL

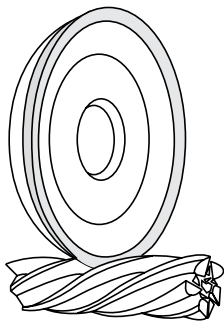

Type 12V9

- D - DIAMETER
- T - THICKNESS
- H - HOLE
- E - BACK THICKNESS
- J - HUB DIAMETER
- K - INSIDE DIAMETER
- U - INSERT LENGTH
- S - FACE ANGLE
- X - ABRASIVE DEPTH

LISTINGS AVAILABLE IN DIAMOND OR CBN

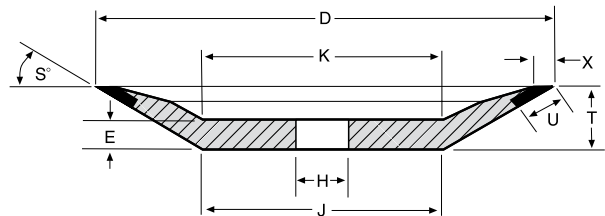

Type 12V9 – Specific Blueprints

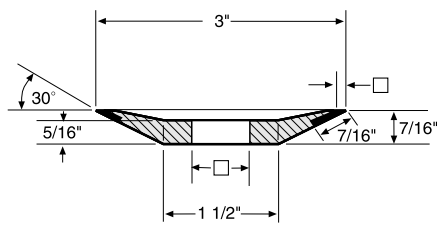

ME41755

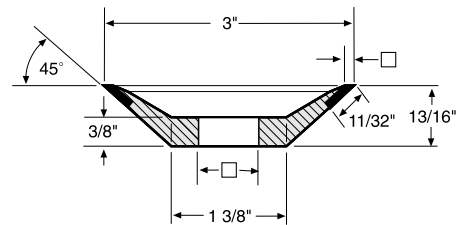

ME69978

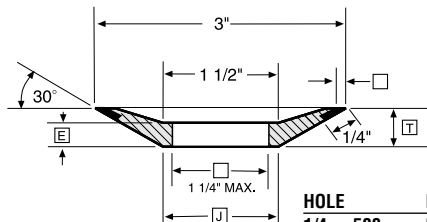

ME78406

HOLE	E	T	J
1/4 - .500	5/16	1/2	1-17-64
.501 - 1-1/4	1/4	7/16	1-33/64

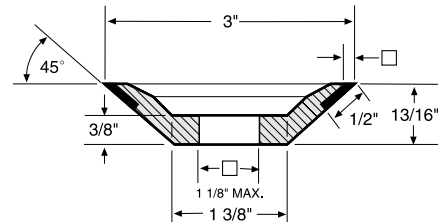

ME37191

VARIABLE

SEE ADDITIONAL SPECIFIC TYPE 12V9 BLUEPRINTS ON THE FOLLOWING PAGE.

Type 12V9 – Specific Blueprints (Continued)

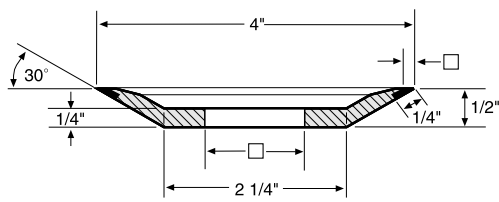

ME58734

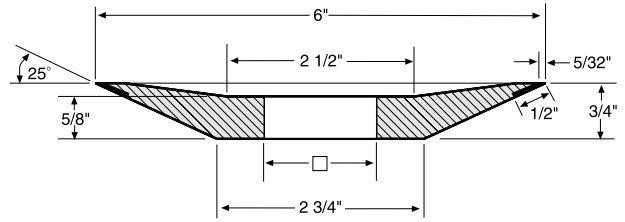

ME98875

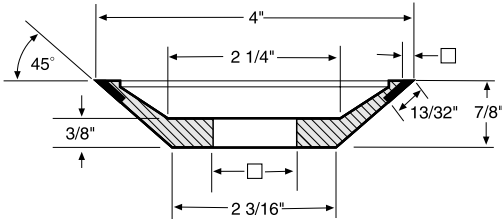

ME80849

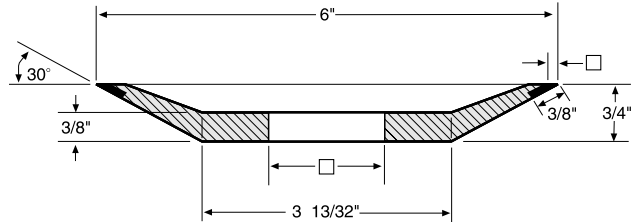

ME48666

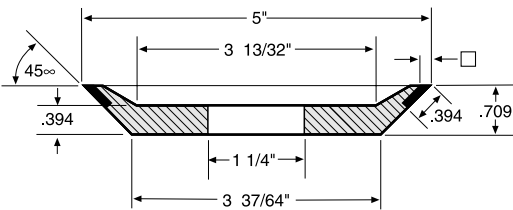

ME120095

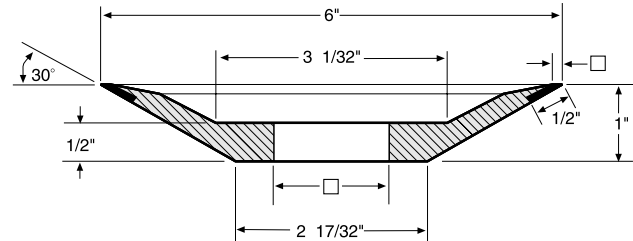

ME118022

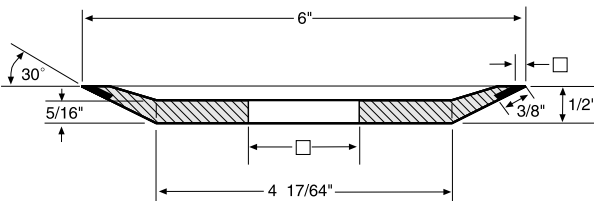

ME73312

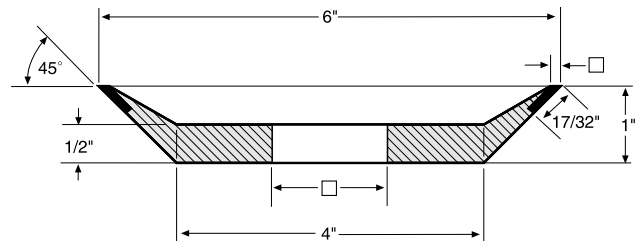

ME44377

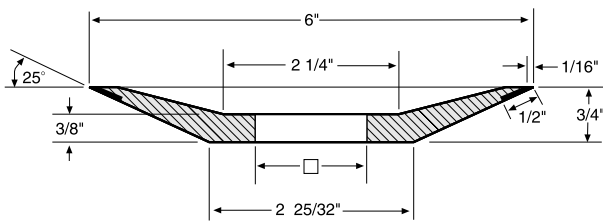

ME109758

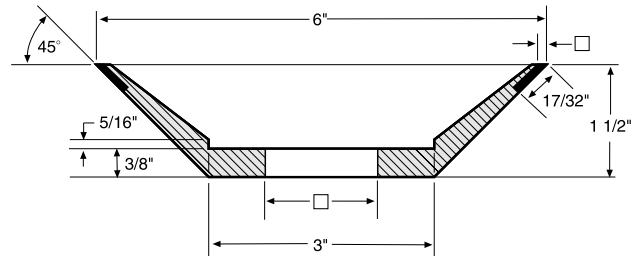

ME54386

 **VARIABLE**

CUSTOMER TO SPECIFY HOLE SIZE, SUBJECT TO SAFETY STANDARDS.

BLUEPRINT NUMBER	D	T	J	U	X
TYPE 14A1 – HUB 2-SIDES WHEELS					
ME54382	6	1/2	4-15/16	1/16	1/8
ME41276	6	1/2	4	1/8	1/16
ME34745	7	1/2	3-15/16	1/8	1/8
ME41385	10	1/2	7	1/4	1/16
					1/8

STANDARD PACKAGE = 1 WHEEL

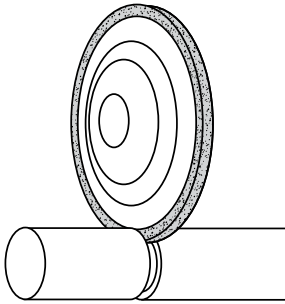

Type 14A1

D - DIAMETER
T - THICKNESS
H - HOLE
D2 - LARGE HUB DIAMETER
X - ABRASIVE DEPTH
U - ABRASIVE THICKNESS
J - HUB DIAMETER

LISTINGS AVAILABLE IN DIAMOND OR cBN

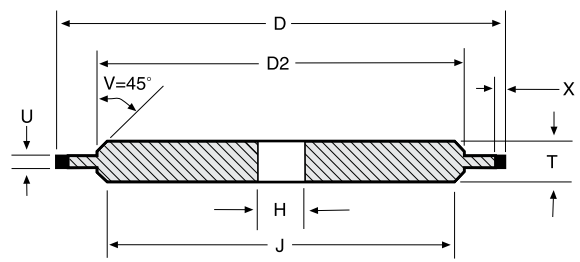

Type 14A1 – Specific Blueprints

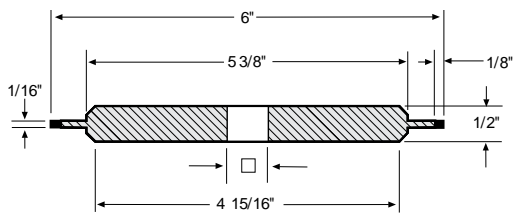

ME54382

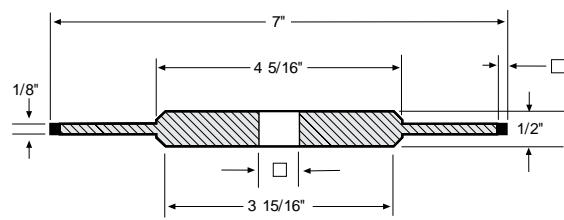

ME34745

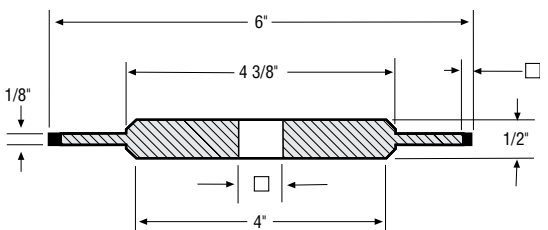

ME41276

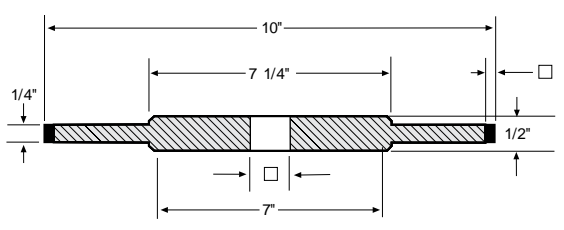

ME41385

VARIABLE

REMEMBER TO CHECK NORTON STOCK AND NORTON/WINTER STOCK AVAILABILITY FIRST, FOR THE FASTEST DELIVERY AND LOWEST PRICE.

BLUEPRINT NUMBER	D	T	W	E	K	S	X
TYPE 15A2 – DISH WHEELS							
ME32717	6	13/16	1/8	7/16	3-1/8	45°	1/8
ME32718	6	13/16	3/16	7/16	3-1/8	45°	1/8
ME32719	6	13/16	1/4	7/16	3-1/8	45°	1/8
ME32720	6	13/16	3/8	7/16	3-1/8	45°	1/8

STANDARD PACKAGE = 1 WHEEL

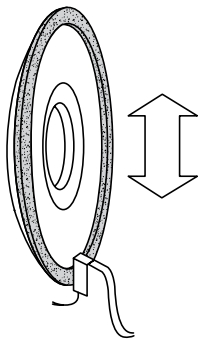

Type 15A2

- D - DIAMETER
- T - THICKNESS
- H - HOLE
- X - ABRASIVE DEPTH
- J - HUB DIAMETER
- W - RIM WIDTH
- E - BACK THICKNESS
- K - INSIDE DIAMETER OF FLAT

LISTINGS AVAILABLE IN DIAMOND OR cBN

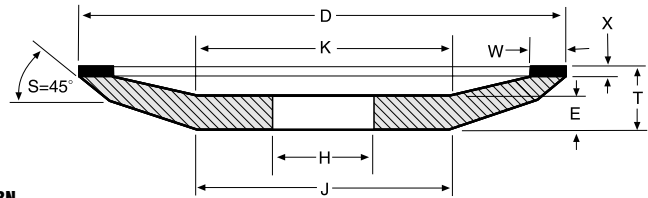

Type 15A2 – Specific Blueprints

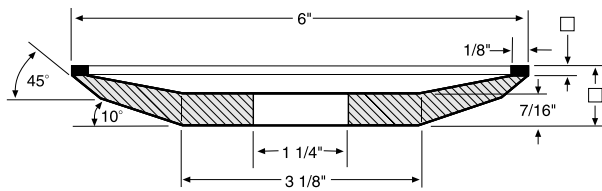

ME32717

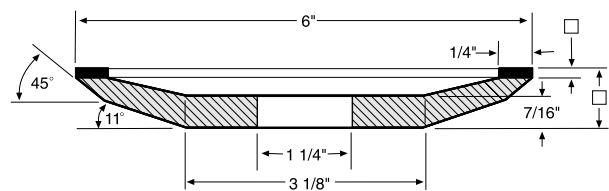

ME32719

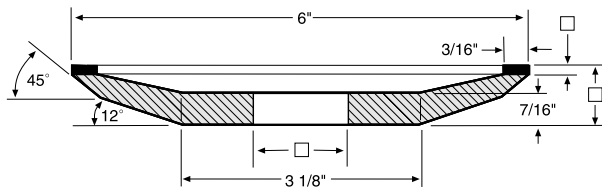

ME32718

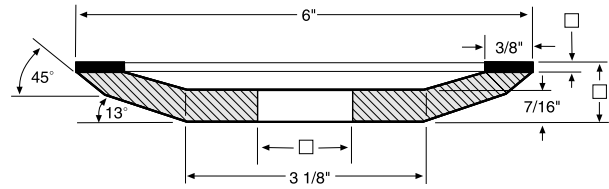

ME32720

VARIABLE

CUSTOMER TO SPECIFY HOLE SIZE, SUBJECT TO SAFETY STANDARDS.

BLUEPRINT NUMBER	D	T	W	E	K	S	X
TYPE 15V4 – DISH WHEELS							
ME29109	3	15/16	1/8	3/8	1-1/2	30°	1/8
ME40846	6	13/16	1/8	7/16	3-1/8	45°	1/8
ME40847	6	13/16	3/8	7/16	3-1/8	45°	1/8
ME40844	6	1-1/16	1/8	1/2	2-5/8	30°	1/8

STANDARD PACKAGE = 1 WHEEL

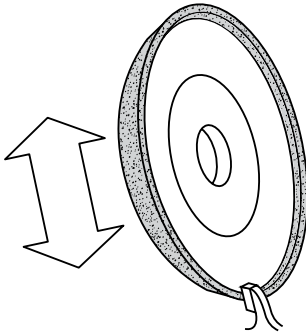

Type 15V4

- D - DIAMETER
- T - THICKNESS
- H - HOLE
- E - BACK THICKNESS
- K - INSIDE DIAMETER OF FLAT
- X - ABRASIVE DEPTH
- V - FACE ANGLE = 10°
- W - RIM WIDTH
- J - HUB DIAMETER
- S - BACK ANGLE

LISTINGS AVAILABLE IN DIAMOND OR cBN

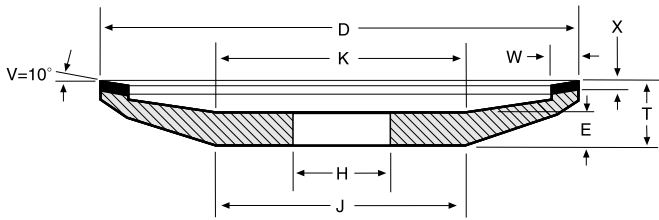

Type 15V4 – Specific Blueprints

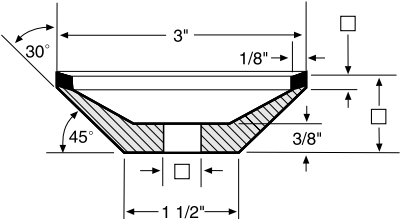

ME29109

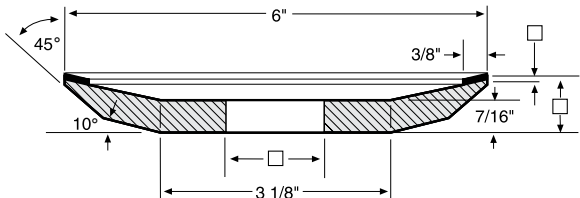

ME40847

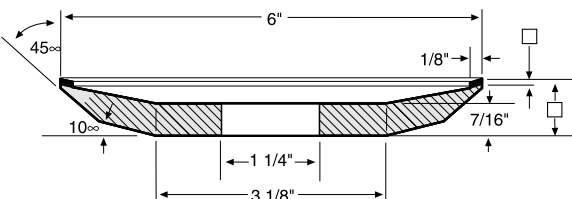

ME40846

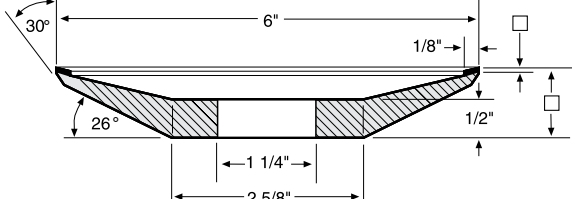

ME40844

VARIABLE

CUSTOMER TO SPECIFY HOLE SIZE, SUBJECT TO SAFETY STANDARDS.

BLUEPRINT NUMBER	D	T	E	S	U	X
TYPE 15V9 – DISH WHEELS						
ME78452*	2	1/2	5/16	45°	3/16	1/8
ME95738*	2-1/2	1/2	3/8	45°	1/4	1/16
ME70688	3	1/2	1/4	45°	5/16	1/16
						1/8
ME106011	3-1/2	3/4	7/16	45°	3/8	1/16
ME109735	4	1/2	5/16	45°	9/32	1/16
						1/8
ME54577	4	3/4	7/16	45°	9/32	1/16
						1/8
ME68744	5	3/4	7/16	45°	9/32	1/8
ME52205	5	1-3/8	1/2	45°	1/2	1/16
						1/8
ME75786	6	3/4	3/8	30°	3/8	1/16
						1/8
ME40633	6	3/4	7/16	45°	3/8	1/16
						1/8
ME55489	8	3/4	7/16	45°	3/8	1/16
					13/32	1/8

*SEE BLUEPRINT FOR MAXIMUM HOLE SIZE.
STANDARD PACKAGE = 1 WHEEL

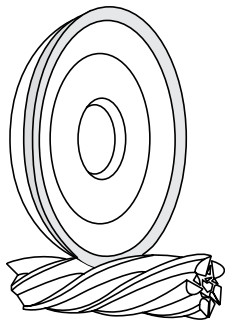

Type 15V9

- D - DIAMETER
- T - THICKNESS
- H - HOLE
- X - ABRASIVE DEPTH
- E - BACK THICKNESS
- J - HUB DIAMETER
- K - INSIDE DIAMETER
- U - INSERT LENGTH
- S - FACE ANGLE

LISTINGS AVAILABLE IN DIAMOND OR cBN

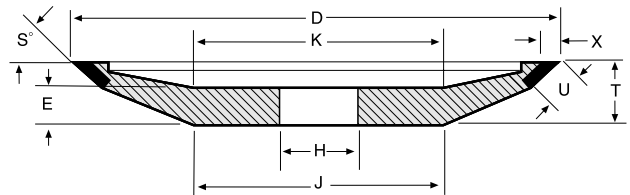

Type 15V9 – Specific Blueprints

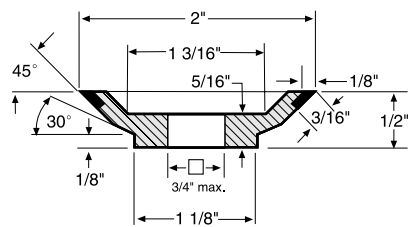

ME78452

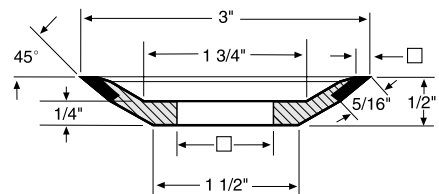

ME70688

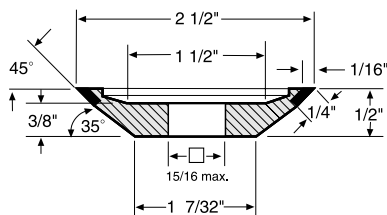

ME95738

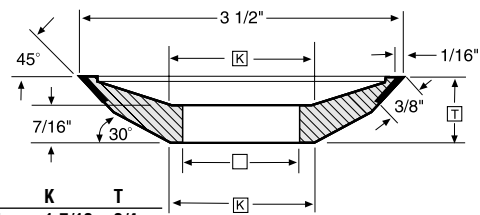

ME106011

HOLE	K	T
1-3/16 or less	1-7/16	3/4
1-1/4	1-1/2	47/64

□ VARIABLE

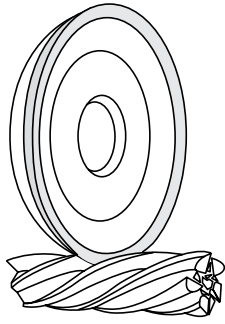

Type 15V9

- D - DIAMETER
- T - THICKNESS
- H - HOLE
- X - ABRASIVE DEPTH
- E - BACK THICKNESS
- J - HUB DIAMETER
- K - INSIDE DIAMETER
- U - INSERT LENGTH
- S - FACE ANGLE

LISTINGS AVAILABLE IN DIAMOND OR cBN

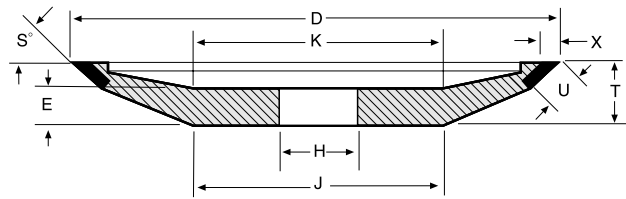

Type 15V9 – Specific Blueprints

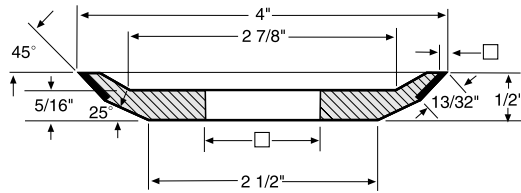

ME109735

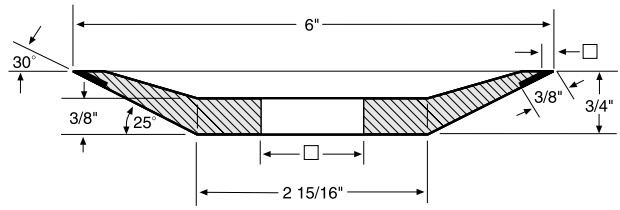

ME75786

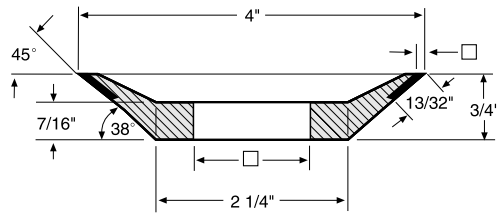

ME54577

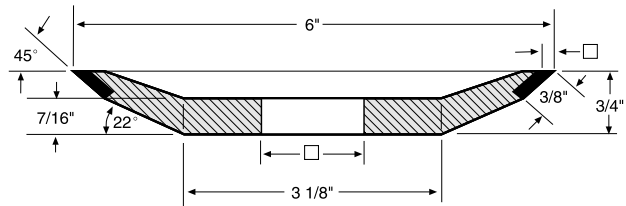

ME40633

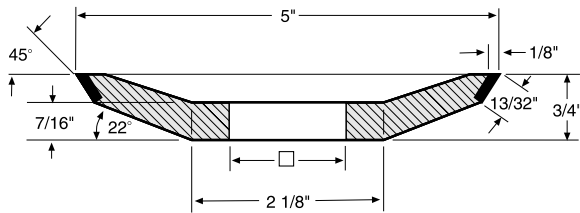

ME68744

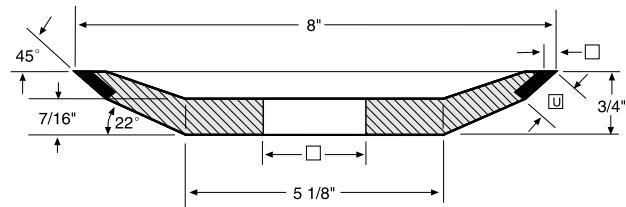

ME55489

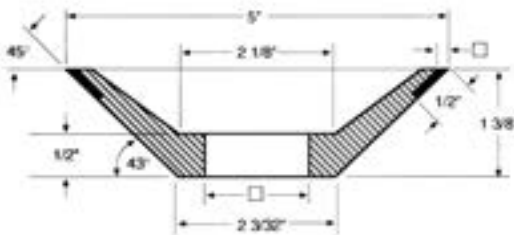

ME52205

VARIABLE

REMEMBER TO CHECK NORTON STOCK AND NORTON/WINTER STOCK AVAILABILITY FIRST, FOR THE FASTEST DELIVERY AND LOWEST PRICE.



These superior, pre-engineered wheels have been specifically developed to meet the demanding needs of precision cutting tool manufacturers as well as re-sharpeners. The use of the highest quality diamond and cBN abrasives matched to superior high temperature bond systems, guarantees high performing wheels. These wheels are manufactured under the strictest quality control protocols ensuring the same, consistent, high-performing product. Cutting tool manufacturers who use these wheels report much improved dimensional accuracy and superior cutting edges.

This product offering provides wheel sizes for most CNC machines and wheels shapes to produce the required cutting tool geometries. If you do not find a wheel in this offering to suit your specific needs, a custom-made wheel can be provided.



TYPICAL APPLICATIONS

- CNC round tool grinding

BEST

NORTON PARADIGM DIAMOND WHEELS – FOR CNC WC ROUND TOOL MANUFACTURING
NORTON G-FORCE CBN WHEELS – FOR CNC HSS ROUND TOOL MANUFACTURING

FEATURES

- Truable
- Wear and load resistant
- High grain retention; uniform structure
- Low specific cutting energy

BENEFITS

- Online and offline truable for maximum productivity
- Superior grinding on 6% to 12% cobalt
- Better control over core growth
- High G-ratio; up to 2.5 times longer life and 30% higher MRR than existing superabrasive wheels
- Faster grinding with lower power draw and less burn

BETTER

NORTON G-FORCE AND POLYIMIDE DIAMOND WHEELS – FOR CNC WC ROUND TOOL MANUFACTURING

FEATURES

Univel and G-Force premium products

- Polyimide bond systems

BENEFITS

- Superior form-holding and lower-power requirements compared to premium competitive wheels
- Reduced frequency of dresses
- Decreased chances of burn and heat damage to the part

G-Force

- Unique bond technology
- Self-dressing
- The only product on the market that is truly rotary dress-able
- Leads the industry in depth of cut, traverse rates and form holding
- Excels on round, carbide and steel tools
- Abrasive is strongly held – and wear-resistant
- Maintains a consistently sharp grinding edge
- Allows for lights-out manufacturing
- Reduces total grinding costs by 30% or more

GOOD

NORTON/WINTER AND NORTON CNC WHEELS – FOR SHORT RUNS AND FREQUENT GEOMETRY CHANGES

FEATURES

Norton/Winter

- A price competitive alternative to Univel and G-Force

BENEFITS

- The product of choice for short-run manufacturing jobs where frequent wheel profile changes are required, and premium wheels can not be cost-justified
- Can be reshaped for numerous short runs
- Great performance/price ratio

Norton

- Ideal for resharping and short-run manufacturing operations
- Free cutting phenolic specifications formulated for oil coolants
- Consistent wheel-to-wheel performance
- Precision tolerances
- Competitively-priced while providing premium performance
- Grind with less heat and pressure – eliminating burning
- Reduced cycle times, less dressing = longer wheel life
- Repeatable part geometry

SEE PRODUCT IDENTIFICATION SYSTEM/USAGE INFORMATION ON PAGES 9-10 FOR ADDITIONAL INFORMATION.

DIAMOND CNC WHEELS

		BEST NORTON PARADIGM			BETTER NORTON G-FORCE/UNIVEL			GOOD NORTON/WINTER AND NORTON					
ABR. WIDTH U,W	ANGLE V	SPECIFICATION		ABR. DEPTH X	UPC #	SPECIFICATION		ABR. DEPTH X	UPC #	SPECIFICATION			
TYPE 1A1 – DIAMOND FLUTE													
4 x 1/2 x 1-1/4		SD320-D168-P100C	3/8	07958783055*	AD320-UP061 G-Force	1/4	60157663909	A4D180-R115B610	1/4	69014118200	D220-C100-K+925	6mm	60157623605
5 x 3/8 x 1-1/4		SD320-D168-P100C	1/2	07958783058*	AD320-UP061 G-Force	1/2	60157668409	A4D220-R115B610	1/2	69014118255	D220-C100-K+925	6mm	60157625123
5 x 1/2 x 1-1/4		SD320-C176-P100C	1/2	07958783061	AD320-UP061 G-Force	1/2	60157662240	A4D180-R115B610	1/2	69014118202	D220-C100-K+925	6mm	60157613099
5 x 5/8 x 1-1/4		SD320-C176-P100C	1/2	07958783063*	AD320-UP061 G-Force	1/2	60157663486*	A4D180-R115B610	1/2	69014118203*	D220-C100-K+925	6mm	60157613099
6 x 1/2 x 1-1/4		SD320-C176-P100C	1/2	07958783064	AD320-UP061 G-Force	1/4	60157682133*	A4D180-R115B610	1/4	69014118216*	D280-N100K+1421	6mm	60157624551
TYPE 1A1 – DIAMOND POLISH													
5 x 1/2 x 1-1/4					80D1000-100UP731 Univel	1/2	07958784316*						
TYPE 1A1 – DIAMOND RELIEF													
6 x 1/2 x 1-1/4		SD320-E168-P100C	1/2	07958783073*	AD320-UP892 G-Force	1/2	69014117684*	A4D180-R115B610	1/2	69014118217*	D280-N100-K+1421	6mm	60157624551
TYPE 1A1RN – DIAMOND FLUTE													
5 x 3/8 x 1-1/4		SD320-D168-P100C	1/2	07958783067*	AD320-UP061 G-Force	1/2	60157663501	A4D180-R115B610	1/2	69014118201	D220-C100-K+925	6mm	60157625123
5 x 1/2 x 1-1/4					AD220-UP061 G-Force	1/2	66260322280						
5 x 5/8 x 1-1/4					AD220-UP061 G-Force	1/2	60157664141						
TYPE 1B1 – DIAMOND FLUTE													
4 x 3/8 x 1-1/4	V=20°	SD320-D168-P100C	3/8	07958783054									
TYPE 1B1 – DIAMOND FLUTE/GASH													
5 x 3/8 x 1-1/4	V=45°	SD320-E168-P100C	1/2	07958783065									
TYPE 1B1 – DIAMOND GASH													
5 x 1/2 x 1-1/4	V= 45°	SD320-E168-P100C	1/4	07958783062*									
5 x 1/2 x 1-1/4	V=60°	SD320-E168-P100C	1/4	07958783060*									
5 x 1/2 x 1-1/4	V=30°	SD320-E168-P100C	3/4	07958783070*				A4D320-R115B610	3/4	69014118207	D220-C100-K+925	6mm	60157613112
5 x 1/2 x 1-1/4	V=45°	SD320-E168-P100C	3/4	07958783068*	AD320-UP531 G-Force	3/4	66260329603	A4D320-R115B610	3/4	69014118208	D220-C100-K+925	6mm	60157623673
TYPE 1V1 – DIAMOND FLUTE													
4 x 3/8 x 1-1/4	V=20°				AD320-UP061 G-Force	1/4	66260316591	A4D180-R115B610	1/4	69014118263			
5 x 1/2 x 1-1/4	V=10°	SD320-C176-P100C	1/2	07958783071*	AD320-UP061 G-Force	1/2	66260116723	A4D180-R115B610	1/2	69014118204			
5 x 1/2 x 1-1/4	V=20°	SD320-C176-P100C	1/2	07958783074	AD320-UP061 G-Force	1/2	60157693843	A4D180-R115B610	1/2	69014118205	D220-C100-K+925	6mm	60157623953
5 x 1/2 x 1-1/4	V=30°	SD320-C176-P100C	1/2	07958783085*	AD320-UP671 G-Force	1/2	60157693841	A4D180-R115B610	1/2	69014118206			

* NON-STOCK: CONTACT YOUR NORTON REPRESENTATIVE FOR CURRENT LEAD-TIMES.
ALL HOLES (BORES) ARE MACHINED TO (H7) CLASS FIT.

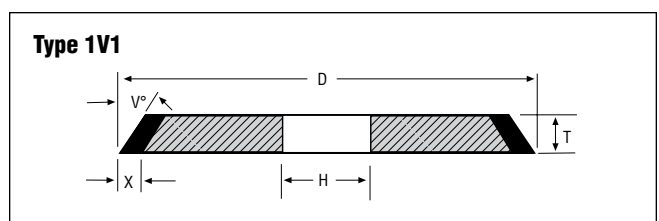
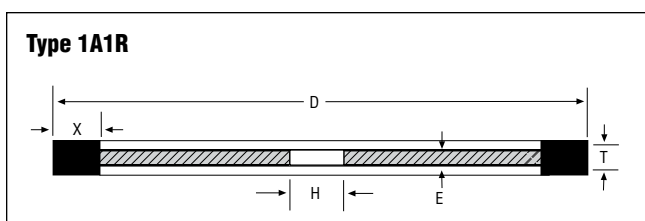
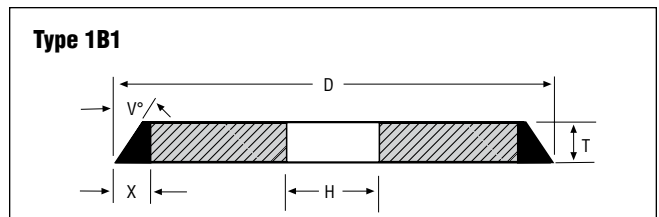
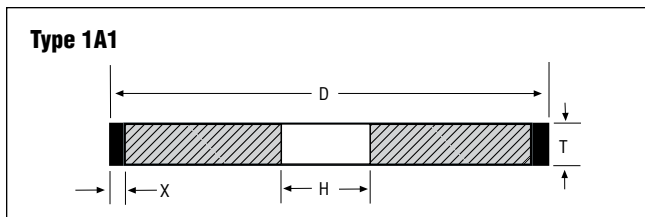

DIAMOND CNC WHEELS

		BEST NORTON PARADIGM			BETTER NORTON G-FORCE/UNIVEL			GOOD NORTON/WINTER AND NORTON		
ABR. WIDTH U, W	ANGLE V	SPECIFICATION	ABR. DEPTH X	UPC #	SPECIFICATION	ABR. DEPTH X	UPC #	SPECIFICATION	ABR. DEPTH X	UPC #
TYPE 1V1 – DIAMOND FLUTE/GASH										
5 x 3/8 x 1-1/4	V=45°				AD320-UP531 G-Force	1/2	60157696562	A4D320-R115B610	1/2	69014118257
TYPE 1V1 – DIAMOND GASH										
5 x 1/2 x 1-1/4	V= 45°				AD320-UP531 G-Force	1/4	66260329604	A4D320-R115B610	1/4	69014118209
5 x 1/2 x 1-1/4	V=60°				AD320-UR331 Univel	1/4	66260329469	A4D320-R115B610	1/4	69014118210
TYPE 6A2 – DIAMOND POINT										
4 x 1-1/4 x 1-1/4		SD320-E168-P100C	1/4	07958783057*	AD320-UP251 G-Force	1/4	69014118644*	ASD320C-R100B56	1/4	69014118219*
W=1/4										
TYPE 11A2 – DIAMOND RELIEF										
3 x 1-1/4 x 1-1/4					10D320-NB100U Univel	1/4	60157692199			
W=1/4										
4 x 1-1/4 x 1-1/4		SD320-E168-P100C	1/4	07958783059*	AD320-UP701 G-Force	1/4	60157696315	ASDC320-R100B80	1/4	69014118213
W=1/4										
4 x 1-1/4 x 1-1/4					AD320-UP561 G-Force	1/4	69014118479*	ASDC320-R100B80	1/4	69014118265*
W=1/4										
TYPE 11V5 – DIAMOND RELIEF										
4 x 1-1/4 x 1-1/4	V=30°				AD320-UP561 G-Force	1/4	69014117838	ASDC320-R100B80	1/4	69014118211
W=1/4										
4 x 1-1/4 x 1-1/4	V=10°				AD320-UP561 G-Force	1/4	69014117812	ASDC320-R100B80	1/4	69014118212
W=3/8										
TYPE 11V9 – DIAMOND RELIEF										
3-3/4 x 1-1/2 x 1-1/4					10D240-PB125-U Univel	1/8	66260322134	ASDC320-R100B80	1/8	69014118259
U=3/8										
5 x 1-3/4 x 1-1/4					10D240-PB125-U Univel	1/8	66260118300	ASDC320-R100B80	1/8	69014118215
U=5/8								D280-R100-K+4821	3mm	60157612443
TYPE 12V9 – DIAMOND RELIEF										
4 x 3/4 x 1-1/4					AD320-UP531 G-Force	1/8	66260127950*	ASDC320-R100B80	1/8	69014118221*
U=3/8								D280-R100K+4821	3mm	60157612442
5 x 3/4 x 1-1/4					AD320-UP531 G-Force	1/8	66260127911*	ASDC320-R100B80	1/8	69014118222*
U=1/2										

* NON-STOCK; CONTACT YOUR NORTON REPRESENTATIVE FOR CURRENT LEAD-TIMES.
ALL HOLES (BORES) ARE MACHINED TO (H7) CLASS FIT.

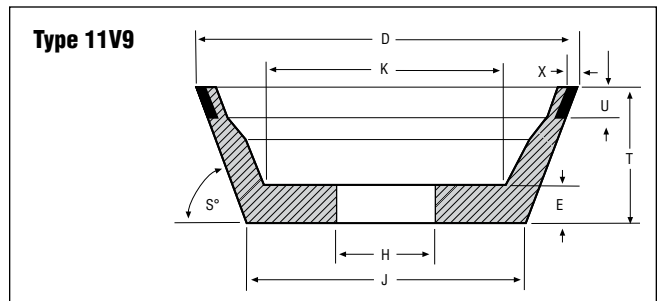
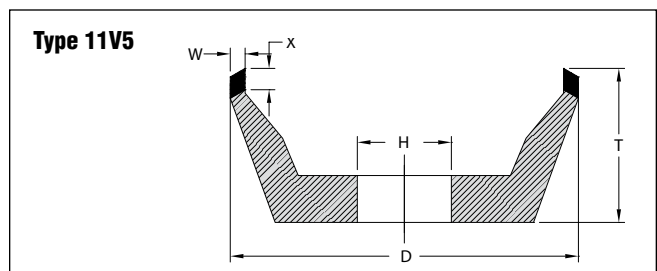
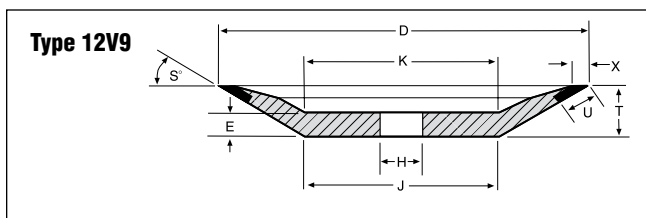
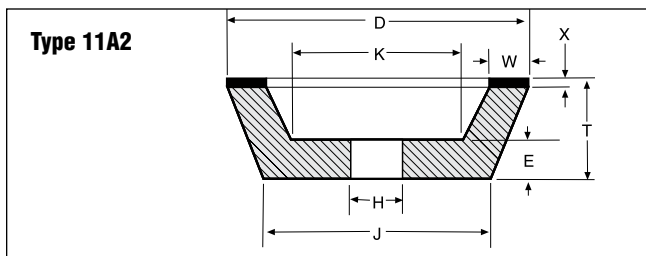
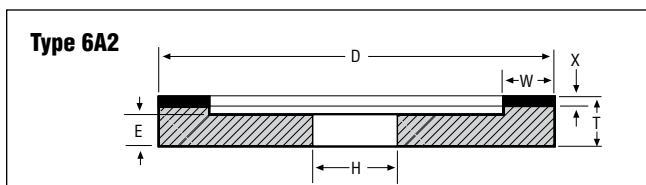

CBN CNC WHEELS

		BEST NORTON G-FORCE/UNIVEL			GOOD NORTON/WINTER AND NORTON		
ABR. WIDTH U,W	ANGLE V	SPECIFICATION	ABR. DEPTH X	UPC #	SPECIFICATION	ABR. DEPTH X	UPC #
TYPE 1A1 – cBN FLUTE							
4 x 1/2 x 1-1/4		BX220-UP241 G-Force	1/4	60157669935*	BAM180-WBXD3037	1/4	69014118223*
					B220-V240-KSS920	6mm	60157623498
5 x 3/8 x 1-1/4		BX220-UP241 G-Force	1/2	69014118436*	BAM320C-WBXD3037	1/2	69014118256*
5 x 1/2 x 1-1/4		BX220-UP241 G-Force	1/2	60157670869*	BAM180-WBXD3037	1/2	69014118224*
					B220-V240-KSS920	6mm	60157602944
5 x 5/8 x 1-1/4		BX220-UP241 G-Force	1/2	66260329385*	BAM180-WBXD3037	1/2	69014118225*
6 x 1/4 x 1-1/4		BX240-UP241 G-Force	1/4	69014118435*	BAM180-WBXD3037	1/4	69014118240*
TYPE 1A1 – cBN RELIEF							
6 x 1/2 x 1-1/4		BX320-UP892 G-Force	1/2	69014117679*	BAM180-WBXD3037	1/2	69014118237*
TYPE 1A1RN – cBN FLUTE							
5 x 1/4 x 1-1/4		BX150-UP241 G-Force	1/2	07958773216*			
5 x 3/8 x 1-1/4		BX150-UP241 G-Force	1/2	07958773217*			
5 x 1/2 x 1-1/4		BX150-UP241 G-Force	1/2	69014141373*			
TYPE 1B1 – cBN GASH							
5 x 1/2 x 1-1/4	V=30°	BX320-UP701 G-Force	3/4	66260329388*	BAM320C-WBXD3037	3/4	69014118229*
5 x 1/2 x 1-1/4	V=45°	BX320-UP531 G-Force	3/4	66260329391*	BAM320C-WBXD3037	3/4	69014118230*
					B220-V240-KSS920	6mm	60157623542
TYPE 1V1 – cBN FLUTE							
4 x 3/8 x 1-1/4	V=20°	BX220-UP241 G-Force	1/4	69014118342*	BAM180C-WBXD3037	1/4	69014118264*
5 x 1/2 x 1-1/4	V=20°	BX220-UP241 G-Force	1/2	60157680042*	BAM180-WBXD3037	1/2	69014118227*
					B220-V240-KSS920	6mm	60157623944
5 x 1/2 x 1-1/4	V=30°	BX220-UP241 G-Force	1/2	60157691380*	BAM180-WBXD3037	1/2	69014118228*
5 x 1/2 x 1-1/4	V=10°	BX220-UP241 G-Force	1/2	66260119876*	BAM180-WBXD3037	1/2	69014118226*
TYPE 1V1 – cBN FLUTE/GASH							
5 x 3/8 x 1-1/4	V=45°	BX220-UP531 G-Force	1/2	60157697699*	BAM320C-WBXD3037	1/4	69014118262*
					B220-V240-KSS920	6mm	60157623524
TYPE 1V1 – cBN GASH							
5 x 1/2 x 1-1/4	V=60°	BX320-UR331 Univel	1/4	66260329461*	BAM320C-WBXD3037	1/4	69014118232*
5 x 1/2 x 1-1/4	V=45°	BX320-UP531 G-Force	1/4	66260329275*	BAM320C-WBXD3037	1/4	69014118231*
					B220-V240-KSS920	6mm	60157623776
TYPE 6A2 – cBN POINT							
4 x 1-1/4 x 1-1/4		BX320-UP241 G-Force	1/4	69014118543*	CB320C-WBB	1/4	69014118239*
5 X 1-1/4 X 1-1/4		BX320-UP241 G-Force	1/4	69014118447*	CB320C-WBB	1/4	69014118238*

* NON-STOCK: CONTACT YOUR NORTON REPRESENTATIVE FOR CURRENT LEAD-TIMES.
ALL HOLES (BORES) ARE MACHINED TO (H7) CLASS FIT.

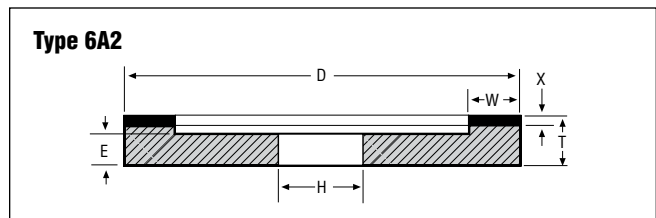
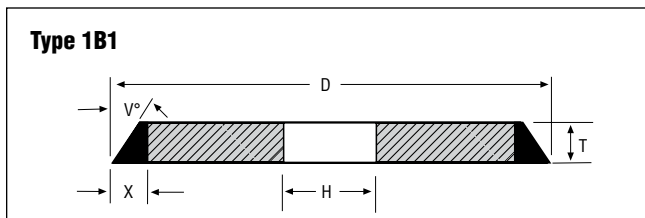
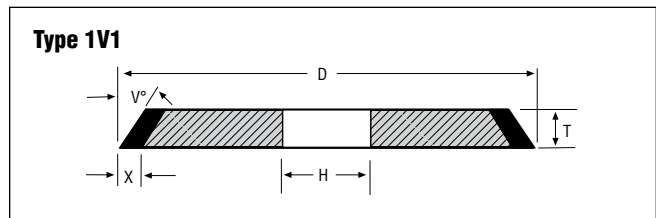
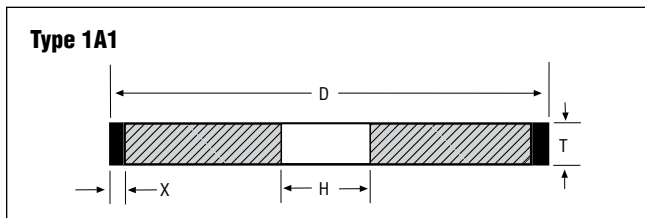

SEE PRODUCT IDENTIFICATION SYSTEM/USAGE INFORMATION ON PAGES 9-10 FOR ADDITIONAL INFORMATION.

TECHtip

DIAMOND GRINDS:

In general, diamond is used to grind non-ferrous materials, because it reacts with iron.

- Cemented carbide
- Glass
- Ceramics
- Fiberglass
- Plastics
- Stone
- Abrasives
- Electronic components and materials

cBN GRINDS:

cBN is used to grind ferrous materials.

- High-speed tool steels
- Die steels
- Hardened carbon steels
- Alloy steels
- Aerospace alloys
- Hardened stainless steel
- Abrasion-resistant ferrous materials



It is the user's responsibility to refer to and comply with ANSI B7.1

CBN CNC WHEELS

		BEST			GOOD		
		NORTON G-FORCE/UNIVEL			NORTON/WINTER AND NORTON		
ABR. WIDTH U, W	ANGLE V	SPECIFICATION	ABR. DEPTH		SPECIFICATION	ABR. DEPTH	
			X	UPC #		X	UPC #
TYPE 11A2 – cBN RELIEF							
5 x 1-1/2 x 2 W=1/4		BX320-UP531 G-Force	1/4	69014118406*	BAM220-WBE	1/4	69014118254*
TYPE 11A2 – cBN RELIEF							
4 x 1-1/4 x 1-1/4 W=1/4		BX320-UP531 G-Force	1/4	69014118445*	BAM220-WBE	1/4	69014118266*
TYPE 11V5 – cBN RELIEF							
4 x 1-1/4 x 1-1/4 W=1/4 V=30°		BX320-UP701 G-Force	1/4	69014117833*	BAM220-WBE	1/4	69014118233*
4 x 1-1/4 x 1-1/4 W=3/8 V=10°		BX320-UP701 G-Force	1/4	69014117820*	B220-J240-KSS63Y	6mm	60157623563
TYPE 11V9 – cBN RELIEF							
3-3/4 x 1-1/2 x 1-1/4 U=3/8		90B240-PB125-U Univel	1/8	69014118345*	BAM220-WBE	1/8	69014118260*
TYPE 11V9 – cBN RELIEF							
3-3/4 x 1-1/2 x 1-1/4 U=3/8		90B240-PB125-U Univel	1/8	69014118029*	BAM220-WBE	1/8	69014118235*
5 x 1-3/4 x 2 U=3/8		90B240-PB125-U Univel	1/8	69014118043*	BAM220-WBE	1/8	69014118248*
TYPE 12V9 – cBN RELIEF							
4 x 3/4 x 1-1/4 U=3/8		BX320-UP531 G-Force	1/8	69014118470*	BAM220-WBE	1/8	69014118241*
5 x 3/4 x 1-1/4 U=1/2		BX320-UP531 G-Force	1/8	69014118441*	BAM220-WBE	1/8	69014118242*

* NON-STOCK: CONTACT YOUR NORTON REPRESENTATIVE FOR CURRENT LEAD-TIMES.
ALL HOLES (BORES) ARE MACHINED TO (H7) CLASS FIT.

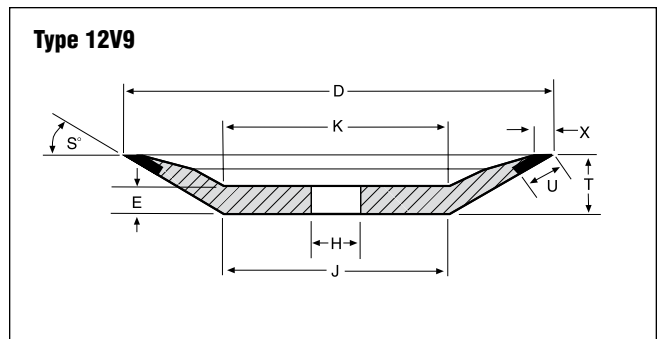
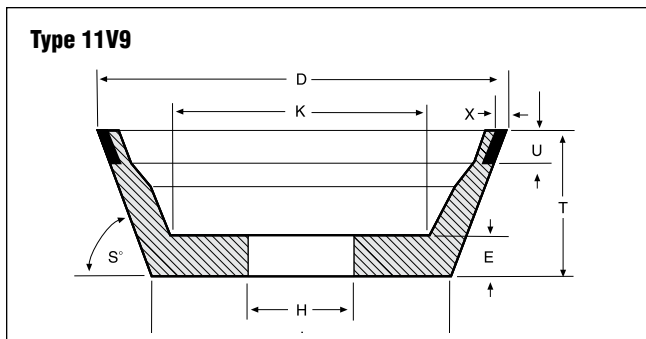
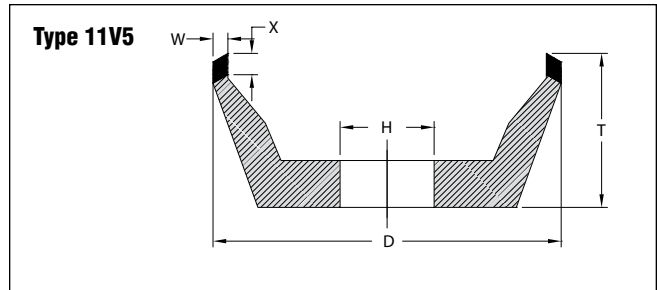
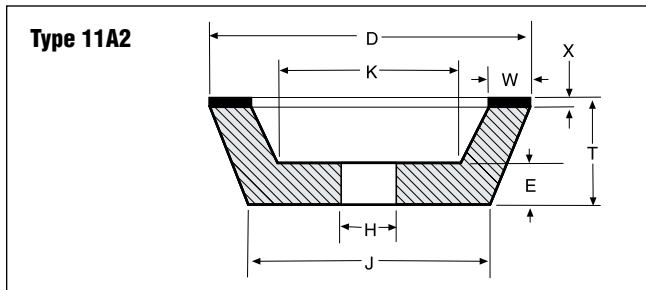

SEE PRODUCT IDENTIFICATION SYSTEM/USAGE INFORMATION ON PAGES 9-10 FOR ADDITIONAL INFORMATION.

NORTON CNC EXPRESS MADE-TO-ORDER WHEELS

Blank Stock Inventory to be altered to your specifications with 5-10 days

Wheel Shape	Tool Material	Application	G-Force Specification AD = Diamond BX = cBN	Diameter D	THK. T	Hole H	Abr. Depth X	Angle (V) or Radius (R)
	WC	Fluting	AD320-UP061E	5	7/16" min. to 1/2" max.	1/2" min. to 2" max.	1/2"	-
	HSS	Fluting	BX320-UP241E	5				
	WC	Fluting	AD320-UP061E	6				
	WC	Fluting	AD320-UP061E	5				
	WC	Fluting	AD320-UP061E	6				1 deg. - 30 deg.
	HSS	Fluting	BX320-UP241E	5				
	WC	Gashing	AD320-UP531E	5				1 deg. - 55 deg.
	HSS	Gashing	BX320-UP531E	5				
	WC	Fluting	AD320-UP061E	5				90 deg. to 178 deg.
	HSS	Fluting	BX320-UP241E	5				
	WC	Fluting	AD320-UP061E	6				
	WC	Fluting	AD320-UP061E	5				
	HSS	Fluting	BX320-UP241E	5				
	WC	Fluting	AD320-UP061E	6				
	WC	Fluting	AD320-UP061E	5	Less than T/2			
	HSS	Fluting	BX320-UP241E	5				
	WC	Fluting	AD320-UP061E	6				
	WC	Fluting	AD320-UP061E	5	Less than T/2			
	HSS	Fluting	BX320-UP241E	5				
	WC	Fluting	AD320-UP061E	6				

Note: all of the wheel shapes listed can also be designated to have .010 relief(s) 1 side, or 2 sides on 1A1P and 1A1RN wheels.

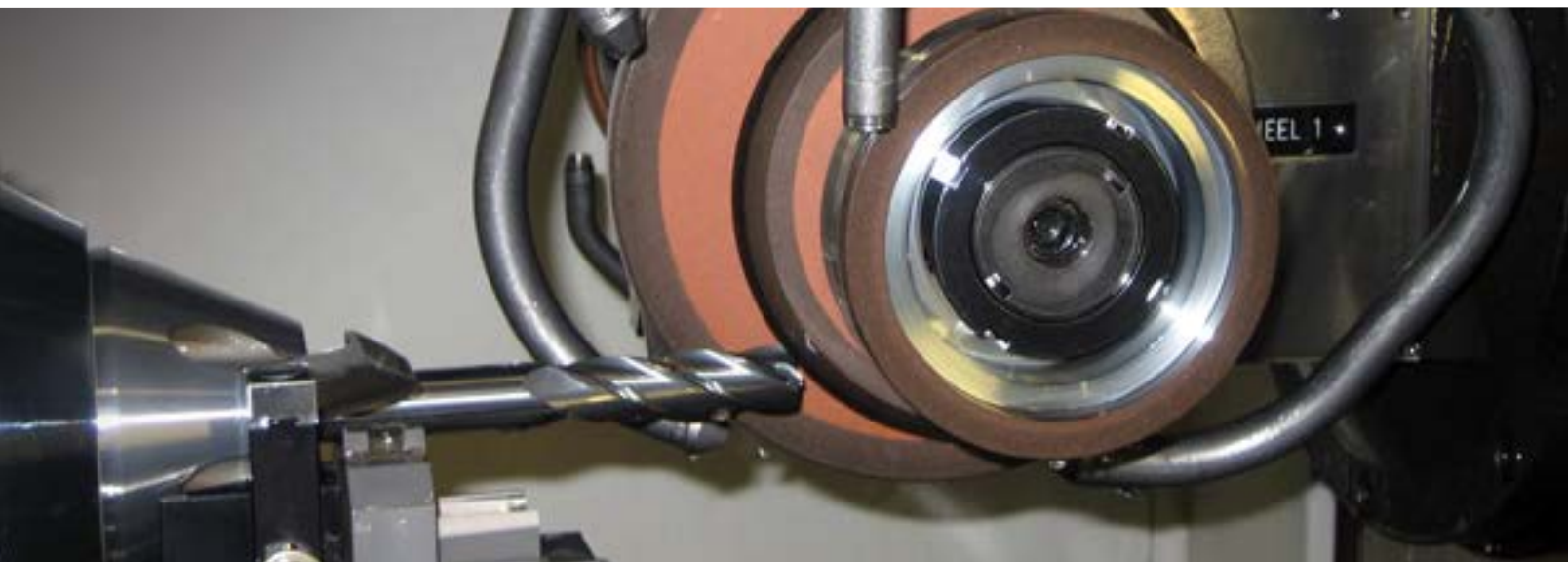

OFF-LINE TRUING WHEELS

Off-line truing is a process used to restore wheel truth to the axis of rotation, wheel profiles, or proper geometry in response to grinding wheel breakdown. Norton truing wheels are available in silicon carbide (39C) or aluminum oxide (38A) formulations.

Silicon Carbide 39C grain is a hard and sharp grain, best used on bond systems like Metal Bond, Polyimide bonds, and very durable phenolic resin bonds.

Aluminum Oxide 38A is a more friable grain, best suited for eroding bond in the truing process. Use this on softer phenolic resin and Paradigm technologies.

MicroDressing Wheels should be used to dress 400 grit or finer diamond and cBN grinding wheels. They can be used in dry or wet dressing conditions.



CONVENTIONAL TRUING WHEELS

SIZE D x T x H	SPECIFICATION	UPC #	STD. PKG.
TYPE 1			
7 x 1/4 x 1-1/4	39C80-JVK	66252940007	10
	39C100-IVK	66252940109	10
	39C120-IVK	66252940111	10
	38A60-IVBE	66252939696	10
	38A60-JVBE	66252939698	10
	38A60-KVBE	66252939700	10
	38A80-IVBE	66252939808	10
	38A80-JVBE	66252939809	10
	38A80-KVBE	66252939812	10
	38A100-IVBE	66252939823	10
	38A100-JVBE	66252939826	10
	38A100-KVBE	66252939827	10
7 x 1/2 x 1-1/4	39C80-IVK	66252941617	10
	39C80-JVK	66252941618	10
	39C100-HVK	66252941622	10
	39C100-IVK	66252941624	10
	39C120-IVK	66252941632	10
	38A60-IVBE	66252941036	10
	38A60-JVBE	66252941038	10
	38A60-KVBE	66252941041	10
	38A80-IVBE	66252941048	10
	38A80-JVBE	66252941049	10
	38A80-KVBE	66252941054	10
	38A100-IVBE	66252941163	10
38A100-JVBE	66252941165	10	
38A100-KVBE	66252941168	10	
7 x 3/4 x 1-1/4	39C80-JVK	66252942096	10
	39C100-JVK	66252942104	10
	38A60-IVBE	66252942207	10
	38A60-KVBE	66252942060	10

SIZE D x T x H	SPECIFICATION	UPC #	STD. PKG.
TYPE 1 (CONTINUED)			
8 x 1/4 x 1-1/4	39C80-IVK	66253014526	10
	38A60-IVBE	66253043431	10
	38A60-JVBE	66253043432	10
	38A60-KVBE	66253010825	10
	38A80-IVBE	66253043437	10
	38A80-JVBE	66253043439	10
	38A80-KVBE	66253043461	10
	38A100-IVBE	66253043445	10
	38A100-KVBE	66253043447	10
	8 x 3/8 x 1-1/4	39C80-IVK	69936664144
8 x 1/2 x 1-1/4	39C80-IVK	66253044015	10
	39C100-IVK	66253044017	10
	38A60-IVBE	66253043757	10
	38A60-JVBE	66253043758	10
	38A60-KVBE	66253043761	10
	38A80-IVBE	66253043766	10
	38A80-JVBE	66253013787	10
	38A80-KVBE	66253043869	10
38A100-KVBE	66253043877	10	
8 x 3/4 x 1-1/4	39C80-IVK	66253350645	10
	39C100-IVK	66253044314	10
	38A60-IVBE	66253044184	10

MICRO DRESSING WHEEL

SIZE D x T x H	SPECIFICATION	UPC #	STD. PKG.
TYPE 1			
200mm x 10mm x 31.75mm	320 S/C Organic	66253296349	1

TECHtip

- Wheel direction of rotation during truing must match the direction or rotation during use.
- Set the speed ratio in SFPM of truing wheel to superabrasive wheel to 3:1
- Use a minimum Truing wheel speed of 4500 SFPM
- Stick dress wheels after truing is recommend when extra abrasive exposure is required.



It is the user's responsibility to refer to and comply with ANSI B7.1

NORTON BRAKE-CONTROLLED TRUING DEVICES

Designed for truing diamond and cBN wheels rapidly, effectively, and with a minimum of superabrasive loss. Recommended for wheels up to 12" in diameter.

TYPICAL APPLICATIONS

- Truing straight, cup and cylinder wheels:
- Straight wheels, used on chip breaker, tool and cutter, surface, and cylindrical grinding machines
- Cup wheels, used on vertical spindle surface grinders
- Internal grinding wheels
- Cut-off wheels



BETTER

4597 TRUING DEVICE

The 4597 is engineered for heavier and more frequent truing applications. The adjustable speeds allow for varying conditions (between 1050 and 1500 SFPM). It comes complete with a reusable case, "True to Form, Dress to Cut" training video, two 3" 38A60-M8VBE* vitrified wheels, Truing Device Tips book and a dressing stick. It can be rebuilt using the 4597RK Rebuild Kit.

Worn #4597 Brake Controlled Truing Devices (UPC 66260195350) in need of reconditioning (beyond new shoes and springs) may be returned to be rebuilt. Contact Customer Service for return instructions and quote.

BETTER

3597 PACESETTER TRUING DEVICE

The Pacesetter model is ideal for light-duty use. The pre-set brake speed requires no adjusting. This model includes one 3" 38A60-M8VBE* vitrified wheel and can be rebuilt using the 3597RK Rebuild Kit.

*The 3" 38A60-MVBE wheel is ideal for general purpose truing of 100 to 180 grit diamond and cBN wheels.

BETTER

4597RK AND 3597RK REBUILD KITS

The truing devices can be rebuilt with these kits, consisting of 3 brake shoes, 3 springs, and 3 screws

ITEM	BETTER		GOOD	
	PRODUCT #	UPC #	PRODUCT #	UPC #
TRUING DEVICES				
4597 Brake-Controlled Truing Device	4597	66260195350		
3597 Pacesetter Brake-Controlled Truing Device	3597	66260135578		
TRUING DEVICE REBUILD KITS				
4597 Rebuild Kit	4597RK	66260195351		
3597 Pacesetter Rebuild Kit	3597RK	66260135595		
REPLACEMENT WHEELS				
3 x 1 x 1/2			38A60-MVBE	66243529145
			38A80-MVBE	66243529146
			37C60-MVK	66243529166
			37C80-HVK	66243529170
			37C80-MVK	66243529171
			37C100-HVK	66243529172
			37C100-MVK	66243529070

SPECcheck

TRUING DIAMOND AND cBN WHEELS

SUPERABRASIVE WHEEL TRUING WHEEL SPECIFICATION

RESIN AND VITRIFIED BOND

80, 100 and 120 grit	38A60-MVBE, 37C60-MVK
150, 180 and 220 grit	38A80-MVBE, 37C80-MVK
320 and finer grits	37C100-HVK

METAL BOND

80, 100 and 120 grit	38A60-MVBE
150, 180 and 220 grit	38A80-MVBE
240 and finer grits	37C80-HVK

TECHtip

- Prior to truing the wheel, run a wax crayon over the wheel face. Important: do NOT use any liquid-based ink on superabrasive wheels.
- Any crayon left on the wheel face after truing will reveal untrued areas.
- Indicate the superabrasive wheel runout before starting... usually within .001" to .002", to minimize wheel loss.
- Mount the device spindle parallel to the wheel spindle to ensure proper straight face truing.
- For cup shaped wheels, the device spindle will be mounted perpendicular to the wheel spindle.
- Always use the Brake Controlled Truing Device dry.
- Bring the diamond/cBN wheel and the truing wheel together until they almost touch.
- Start the diamond/cBN wheel to normal speed; spin the truing wheel in the same direction at point of contact.
- Bring the two wheels together until they touch.
- Make sure the truing wheel is spinning at time of contact.
- Traverse the wheel back and forth at 30 to 60 inches/minute.
- Downfeed .0005" to .001" at the end of each traverse.
- At the end of truing, the diamond/cBN wheel should be smooth and in truth.
- Apply a dressing stick to sharpen the wheel.



It is the user's responsibility to refer to and comply with ANSI B7.1

DIAMOND AND CBN WHEEL MOUNTING, TRUING AND DRESSING GUIDE

To achieve the best results using Norton diamond and cBN products, the following steps for mounting, truing and dressing should be practiced:

MOUNTING – Putting Wheel on Machine Spindle

- Examine wheel flanges and spindle carefully.
- Be sure flanges' surfaces are clean and free of damage.
- Ensure that the mounting flanges are flat and of equal diameter, especially on wheels with rigid centers, such as vitrified bond wheels.
- Paper or plastic blotters should only be used when mounting superabrasive wheels with vitrified cores. Using paper or plastic blotters on any other core material may result in the wheel loosening during grinding.
- Inspect machine spindle for excessive runout.
 - TIR (Total Indicated Runout) should be no greater than 0.0002".
- Mount wheel between hand-tightened flanges.
- Using a dial indicator, tap the wheel lightly with a rubber or wooden block to minimize runout to less than .0010".
- Tighten flange securely and recheck with indicator.
- Allow a newly mounted wheel to operate for one full minute before grinding.
- The use of one permanent mounting for the life of the wheel is recommended whenever possible:
 - If the grinding machine has a tapered spindle, mount each straight, flaring cup or dish wheel on a separate collet or adapter.
 - When changing wheels the entire unit is removed, keeping the wheel in running truth.
 - When needed again, the entire unit can be placed directly on the spindle or arbor, thereby eliminating the time and abrasive lost in retruing.

TRUING – Making Wheel Round and Concentric with the Spindle Axis

- Prior to truing the wheel, run a wax crayon over the wheel face. Important: do not use any liquid-based ink on superabrasive wheels.
- Any crayon left on the wheel face after truing will reveal untrued areas.
- Indicate the superabrasive wheel runout before starting... usually within .001" to .002", to minimize wheel loss.
- Norton brake-controlled truing devices are most commonly used to true Diamond and cBN straight, cup and cylinder wheels.
 - Mount the device spindle parallel to the wheel spindle to ensure proper straight face truing.
 - For cup wheels, the device spindle will be mounted perpendicular to the wheel spindle.
 - Always use brake-controlled truing device dry.
- Bring the diamond/cBN wheel and the truing wheel together until they almost touch.
- Start the diamond/cBN wheel to normal speed; start the truing wheel in the same direction.
- Bring the two wheels together until they touch.
- Make sure the truing wheel is spinning at time of contact.
- Traverse the wheel back and forth at 30 to 60 inches per minute.
- Downfeed .0005" to .001" at the end of each traverse.
- At the end of truing, the diamond/cBN wheel should be smooth and in truth.
- Apply a dressing stick to sharpen the truing wheel.

DRESSING – Opening the Face of a Trued Wheel

- Dressing the abrasive – a cleaning/sharpening process to expose sharp, free-cutting grit:
 - For resinoid and vitrified bond wheels, the dressing stick should be one or two grit sizes finer than the abrasive in the diamond/cBN wheel – in a soft grade such as H or I.
 - For metal bond wheels, choose a stick with the same grit or one grit coarser than the wheel abrasive – in a medium grade (K – N).
 - See the "Dressing Stick" section for recommendations.
- Dressing the core – The core material (the part of the wheel that holds and supports the abrasive-bearing section) should never contact the work piece during grinding; rubbing will generate excessive heat. As the abrasive section of a cup wheel wears, the core material might become exposed, necessitating dressing.
 - Use a single-point carbide or steel tool to dress an exposed resalloy core.
 - Clamp the tool in a vise.
 - Direct the cutting edge accurately to leave a 1/16" of abrasive section exposed.



Properly Dressed Wheel Face

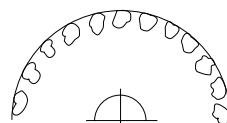

AFTER TRUING
THE WHEEL FACE IS SMOOTH AND CLOSED

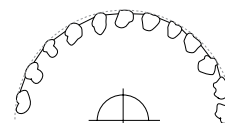

AFTER DRESSING
THE WHEEL FACE IS OPEN WITH THE GRITS EXPOSED, READY FOR EFFICIENT GRINDING ACTION

AFTER DRESSING cBN GRIT



TAIL (BOND SUPPORTING GRIT)

AFTER DRESSING

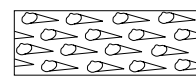

PATH CONNECTING TAILS FOR COOLANT AND CHIP FLOW

Regular use of properly selected dressing sticks will help you achieve maximum performance from your diamond and cBN wheels.

Selecting the appropriate dressing stick for each application depends on the wheel size, type, speed, specification, and grit size, as well as the material being worked. Initial starting specifications are listed below. We recommend testing several sticks to find the best one for your application.



VITRIFIED DRESSING STICKS

SIZE T x W x L	STD. PKG.	SPECIFICATION	UPC #
DRESSING STICKS – ALUMINUM OXIDE			
For dressing cBN wheels, but also work well for diamond wheels			
1/2 x 1/2 x 4	5	38A220-HVBE	61463610555
1/2 x 1/2 x 6	5	38A150-IVBE	61463610303
		38A220-HVBE	61463610103
		38A150-HVBE	61463610291
3/4 x 3/4 x 4	5	38A150-IVBE	61463610368
		38A220-HVBE	61463610290
		38A150-HVBE	61463610280
3/4 x 3/4 x 8	5	38A150-HVBE	61463610405
		38A150-IVBE	61463610453
		38A220-HVBE	61463610406
1 x 1 x 6	5	38A120-IVBE	61463610390
		38A150-IVBE	61463610455
DRESSING STICKS – SILICON CARBIDE			
For dressing metal bond diamond wheels			
1/2 x 1/2 x 6	5	37C150-KV	61463610205
		37C220-KV	61463610214
3/4 x 3/4 x 6	5	37C150-LV	61463610375
1 x 1 x 6	5	37C80-NV	61463610393
		37C150-KV	61463610438
		37C220-KV	61463610398

VITRIFIED SUPERFINE STICKS

SIZE T x W x L	STD. PKG.	SPECIFICATION	UPC #
SUPERFINE STICKS – ALUMINUM OXIDE			
For dressing fine grit diamond and cBN wheels			
1 x 1 x 6	5	PCD Coarse – 400 grit	61463647865
		PCD Fine – 800 grit	61463647867
1 x 1 x 8	5	NSA320-H8V	61463610597
SUPERFINE STICKS – SILICON CARBIDE			
For dressing fine grit diamond and cBN wheels			
1/2 x 1/2 x 6	5	NMVC320-J5VCA	61463610599
		NMVC400-J5VCA	61463650324
1 x 1 x 6	5	NMVC320-J5VCA	61463610605
		NMVC400-J5VCA	61463650450

TECHtip

DRESSING RESIN AND VITRIFIED BOND, DIAMOND AND CBN WHEELS

- Choose a dressing stick one or two grit sizes finer than the abrasive in the wheel – in a soft grade (H or I).

METAL BOND, DIAMOND AND cBN WHEELS

- Choose a stick the same grit size or one grit size coarser than the abrasive in the wheel – in a medium grade (K–N).

It is the user's responsibility to refer to and comply with ANSI B7.1

SPECcheck

STARTING RECOMMENDATIONS – DRESSING DIAMOND AND cBN WHEELS

Selecting the appropriate dressing stick for each application depends on the wheel size, type, speed, specification, and grit size, as well as the workpiece material. Initial starting specifications are listed below. We recommend testing several sticks to find the best one for your application.

SUPERABRASIVE WHEEL	VITRIFIED STICK	SPECIFICATION
PRODUCT		
RESIN AND VITRIFIED BOND WHEELS		
80, 100 and 120 grit	Dressing Stick	38A150-HVBE
150, 180 and 220 grit	Dressing Stick	38A220-HVBE
320 and finer grits	Superfine Stick	NMVC400-J5VCA
METAL BOND		
80, 100 and 120 grit	Dressing Stick	37C80-NV
150, 180 and 220 grit	Dressing Stick	37C150-KV
240 and finer grits	Dressing Stick	37C220-KV



METHODS OF TRUING AND DRESSING



FORM ROLL: PLUNGE DRESSING

- Diamond roll geometry matches geometry of part to be ground
- Roll is fed into grinding wheel to generate the desired form and wheel surface condition
- Used where lowest cycle time and highest accuracy is required

DRESSING DISC: UNI-AXIAL TRAVERSE DRESSING

- Diamond dressing disc has a thin diamond section that is traversed across the face of the grinding wheel
- Profile is generated with a CNC program or template
- Used for simple profiles or where flexibility is necessary

DRESSING SPINDLES

HORSEPOWER	RPM
NORTON AC DRESSING SPINDLES	
0.5 hp	5,500
1.0 hp	3,600
1.5 hp	7,000
NORTON MAXTORQ – DC BRUSHLESS DRESSING SPINDLES	
0.5 hp	8,000
1.0 hp	12,000
2.0 hp	6,000
NORTON HYDRO – HYDRAULIC DRESSING SPINDLES	
1.5 hp	1,800, 2,400, 3,600, 12,000
3.0 hp	7,000
4.0 hp	2,400

*HP LISTED AT 100% EFFICIENCY, 500 PSI @ 5 GPM

NORTON HEAVY-DUTY TWIN GRIP SPINDLES

For heavy duty applications, Norton offers a twin grip heavy duty belt driven system with outboard bearing support. Horsepower and rpm can be customized for the application.

NORTON QUICK-CHANGE HYDRAULIC SYSTEM

For quick changeover, Norton offers an electric motor driven, hydraulic centers clamping system. This is available on select systems with outboard roller support



ACCESSORIES

Various accessories are available for dressing spindles and devices:

- Acoustic Emission Sensors
- Custom Mounting Brackets
- Electrical Enclosure
- Cables
- Drives (DC)
- Suitcase Demo Kit

TYPES OF FORM ROLLS

Norton manufactures two types of plunge dressing rolls: infiltrated diamond form rolls and reverse plated diamond rolls. The following lists comparisons between the two types.

INFILTRATED DIAMOND FORM ROLLS

- Powder Metal-High Temp Proc
- “Lapped” for precision
- Manual setting of diamond
- Lower cost for simple rolls
- Ability to be re-conditioned
- Rugged (good in abusive ops)

REVERSE PLATED DIAMOND FORM ROLLS

- Electroplated Nickel- Low Temp Proc
- Precision built in process
- Mechanical setting of diamond
- Lower cost for complex rolls
- Reconditioning not recommended
- Fragile (Heat and Impact)

INFILTRATED DIAMOND FORM ROLLS

Each diamond is hand set and secured in place with a very tough tungsten/bronze matrix which allows for a wide range of customizable options (concentration, patterns, reinforcement, grit type, etc.). The toughness of the tungsten based matrix makes these diamond rolls ideal for aggressive and harsh environments.

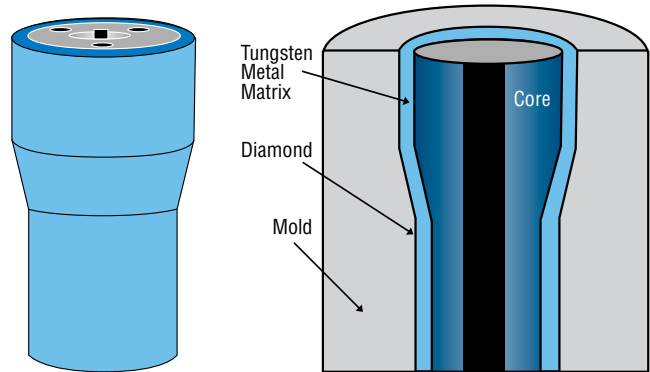

INFILTRATED TECHNOLOGY

Strengths

- Rugged product can withstand rougher treatment
- Can be reconditioned (“relapped”) to extend life
- Broad size range offering (small and large)
- Can be customized (grit size, type, reinforcement, etc.)

Weaknesses

- High labor content (setting and lapping) adds cost to complex forms
- Diamond “lapped” to obtain form accuracy, may close wheel
- High labor content controls lead-times

WHEN TO USE INFILTRATED FORM ROLLS

- Simple Profiles/Forms
- Short Runs- job shop applications
- Abusive operations or applications
- Geometries with thin, tall fins
- Customers with reconditioning programs
- Dry applications, or high heat (like with resin bond)

SPECIFICATIONS EXAMPLE: IFR - D - 2025 - LOC

ROLL TYPE	DIAMOND TYPE	GRIT SIZE	SPECIAL MODIFIERS (FOR INTERNAL USE)
IFR - Infiltrated Form Roll	D - Natural Diamond	Crushed Grit	Combination of up to 11 letters for internal manufacturing use
	SD1 - Medium Quality Synthetic	1618 - 16/18 Mesh	
	SD2 - High Quality Synthetic	1820 - 18/20 Mesh	
		2025 - 20/25 Mesh	
		2530 - 25/30 Mesh	
		3040 - 30/40 Mesh	
		3035 - 30/35 Mesh	
		3540 - 35/40 Mesh	
		4050 - 40/50 Mesh	
		4550 - 45/50 Mesh	
	5060 - 50/60 Mesh		

REVERSE-PLATED DIAMOND FORM ROLLS

Diamond is secured with an electroplated nickel matrix. Diamond is randomly distributed throughout the form roll, with a very high concentration. Because the precision of the diamond profile is designed into the manufacturing process, the diamond is not usually shaped or “lapped”. By not lapping the diamond, the sharp, natural points provide a good dressing action resulting in an open grinding wheel, lower grinding forces and thus a more accurate part. For profiles requiring extremely tight tolerances, lapped reverse-plated form rolls are also available.

This technology is very sensitive to heat and impact and must be used in highly controlled processes

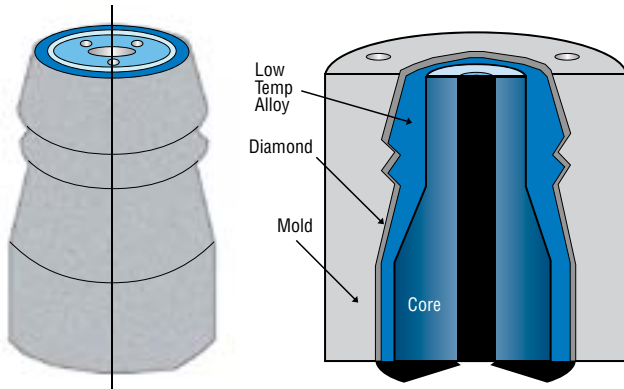

CLOSE-UP OF REVERSE-PLATED DIAMOND FORM ROLL

REVERSE-PLATED TECHNOLOGY

Strengths

- Relative low cost for complex, intricate forms
- High diamond concentration extends form holding / life
- Close tolerances “out of the mold” ($\pm 0.005\text{mm}$ / $\pm .0002$)
- Sharper diamonds, with little or no lapping

Weaknesses

- Fragile! Sensitive to heat and impact
- Reconditioning “re-lap” not usually recommended (closes wheel)
- Not available in smallest sizes (<40mm OD, <12mm wide)
- Electroplating cycle controls lead-times

WHEN TO USE REVERSE-PLATED FORM ROLLS

- Continuous Dress Creep Feed
- Complex forms
 - Fuel injection
 - Thread forms
 - Aerospace root / tree forms
- Long form life
 - Higher diamond concentration
- Most Bearing and Aerospace Customers
 - Exceptions for old equipment or unskilled work force

SPECIFICATIONS EXAMPLE: RPC - D - 2025 - AEP

ROLL TYPE	DIAMOND TYPE	GRIT SIZE	SPECIAL MODIFIERS (FOR INTERNAL USE)
RPC - Reverse Plated Form Roll	D - Natural Diamond	Crushed Grit	Combination of up to 11 letters for internal manufacturing use
	SD1 - Medium Quality Synthetic	1618 - 16/18 Mesh	
	SD2 - High Quality Synthetic	1820 - 18/20 Mesh	
		2025 - 20/25 Mesh	
		2530 - 25/30 Mesh	
		3040 - 30/40 Mesh	
		3035 - 30/35 Mesh	
		3540 - 35/40 Mesh	
		4050 - 40/50 Mesh	
		4550 - 45/50 Mesh	
		5060 - 50/60 Mesh	
		6070 - 60/70 mesh	
		7080 - 70/80 Mesh	
		8001 - 80/100 Mesh	
	0112 - 100/120 Mesh		

INFILTRATED DRESSING DISCS

- Infiltrated dressing discs use the same tough tungsten matrix as infiltrated form rolls making them ideal for aggressive dressing applications.
- Available using synthetic, natural, or CVD log diamonds
- For use where the smallest included angles are needed (down to 0.005" radius)
- Like infiltrated form rolls – these rolls are hand set and can be customized for your application needs.
- Ideal for profiling ceramic and A/O conventional grinding wheels
- Can be re-lapped to achieve longer life



MICROSCOPIC VIEW OF A CVD INFILTRATED DRESSING DISCS EDGE



MICROSCOPIC VIEW OF A CONVENTIONAL INFILTRATED CNC DRESSING DISC EDGE



CLOSE-UP OF INFILTRATED DRESSING DISC EDGE

SPECIFICATIONS EXAMPLE: **ICD - CVD - 201006 - CEF**

ROLL TYPE	DIAMOND TYPE	GRIT SIZE	SPECIAL MODIFIERS (FOR INTERNAL USE)
ICD - Infiltrated CNC Dressing Disc	D - Natural Diamond	Crushed Grit	Combination of up to 11 letters for internal manufacturing use
	SD1 - Medium Quality Synthetic	1618 - 16/18 Mesh	
	SD2 - High Quality Synthetic	1820 - 18/20 Mesh	
	CVD - CVD Synthetic Diamond	2025 - 20/25 Mesh	
		2530 - 25/30 Mesh	
		3040 - 30/40 Mesh	
		3035 - 30/35 Mesh	
		3540 - 35/40 Mesh	
		4050 - 40/50 Mesh	
		4550 - 45/50 Mesh	
		5060 - 50/60 Mesh	
		6070 - 60/70 mesh	
		7080 - 70/80 Mesh	
		8001 - 80/100 Mesh	
	0112 - 100/120 Mesh		
	CVD Grit (For ICD Rolls Only)		
	6 digit number indicating H x L x W of CVD Ex. 300606 = 3 x 0.6 x 0.6 CVD		

BPR DRESSING DISCS

- BPR dressing discs consist of a single consumable layer of high quality synthetic diamond secured with a brazed metal matrix
- Diamond and metal matrix are chemically bonded so diamond retention is not depended on pocket size
- Single layer of consumable diamond eliminates need for lapping resulting in improved life
- Available in 0.005", 0.010", 0.015", 0.020", and 0.025" radii
- Best for truing and dressing Vitrified cBN wheels but can also be used for conventional wheels with low depth of dress.



BPR DRESSING DISC EDGE CLOSE-UP

SPECIFICATIONS EXAMPLE: **BPR - SD2 - 2025 - ALO**

ROLL TYPE	DIAMOND TYPE	GRIT SIZE	SPECIAL MODIFIERS
BPR - BPR CNC Dressing Disc	SD2 - High Quality Synthetic	Crushed Grit	Combination of up to 11 letters for internal manufacturing use
		1820 - 18/20 Mesh	
		2025 - 20/25 Mesh	
		2530 - 25/30 Mesh	
		3040 - 30/40 Mesh	
		3035 - 30/35 Mesh	
		3540 - 35/40 Mesh	
		4050 - 40/50 Mesh	
		4550 - 45/50 Mesh	
		5060 - 50/60 Mesh	
		6070 - 60/70 mesh	
		7080 - 70/80 Mesh	

IDW DRESSING DISCS

- This type of dressing disc consists of diamonds bonded in a hot-pressed metal matrix for superior durability
- Consumable layer of diamond allows for superior life
- Usually up to 2mm flat diamond section width (no radius) – wider widths available based on application.
- This is a specialty product used for straight profiling of Vitrified cBN wheels and is not recommended for use on conventional wheels.
- Has seen most success in straight dressing vitrified cBN wheels in automotive applications (cam and crank).
- Typically available in 30/40 and 40/50 grit mesh sizes – other sizes available based on application needs.



CLOSE-UP OF IDW DRESSING DISC DIAMOND EDGE

SPECIFICATIONS EXAMPLE: **IDW - D - 4050 - ALO**

ROLL TYPE	DIAMOND TYPE	GRIT SIZE	SPECIAL MODIFIERS
IDW - IDW CNC Dressing Disc	D - Natural Diamond	Crushed Grit	Combination of up to 11 letters for internal manufacturing use
		3040 - 30/40 Mesh	
		4050 - 40/50 Mesh	

DRESSING DISC RECOMMENDATIONS

WHEEL TECHNOLOGY	OD STRAIGHT	OD SIMPLE PROFILE	OD COMPLEX PROFILE	OD AND FACE
CONVENTIONAL VITRIFIED ALUMINUM OXIDE	INFILTRATED	INFILTRATED	INFILTRATED	INFILTRATED
CERAMIC VITRIFIED (NORTON QUANTUM X, SG, QUANTUM VS3)	INFILTRATED WITH CVD	INFILTRATED WITH CVD	INFILTRATED WITH CVD	INFILTRATED WITH CVD
RESIN CBN OR DIAMOND (NORTON G-FORCE, B99, ETC)	BPR	BPR	BPR	BPR CUP
VITRIFIED CBN OR DIAMOND	IDW	IDW	BPR	BPR CUP

HOW TO ORDER ROTARY DRESSING TOOLS

Provide the following information to your local sales representative or customer service representative

Legible blueprint of roll, wheel, or part with the following geometry:

- Overall diameter
- Overall length
- Bore size and tolerances required
- Mounting pattern
- Any feature with tolerances less than 0.0002" (5 um) must be clearly defined for engineering review.
- If designing from a part, a fully dimensioned part drawing is required
- Abrasive type (natural diamond, synthetic diamond, CVD stones, etc.)
- Specification of wheel to be dressed (need at least the grit type and size)
- Dressing type (Plunge or CNC Profiling)

GEOMETRIC AVAILABILITY

Diameter: 2.000" - 12.000" [50.80mm - 304.80mm]

Width: 1.000" - 8.500" [25.40mm - 215.90mm] (one piece)

Form Tolerances:

Profile: +/- 0.000080" [0.002mm]

Radius: +/- 0.0002" [0.005mm]

Step Relationship: +/-0.00005" [0.0013mm]

Profile Angularity: +/- 0.00005" [0.0013mm]

Concentricity Band to Bore TIR: 0.00008" [0.002mm]

Diamond to Bore TIR: 0.0002" [0.005mm]

Bore Diameter Tolerance: (+0.0001", -0.0000") [+0.004mm, -0.000mm] up to 4" length

* AVAILABILITY LISTED ABOVE MAY NOT BE AVAILABLE FOR CERTAIN DIAMOND ROLL FORMS OR DIAMOND ROLL TYPES. ALL AVAILABILITY IS SUBJECT TO REVIEW BY NORTON'S DESIGN ENGINEERING TEAM.

**NORTON STATIONARY
DIAMOND DRESSING TOOLS**



NORTON

SAINT-GOBAIN

NORTON LEADS THE TRUING AND DRESSING TOOL INDUSTRY IN ENGINEERING AND MANUFACTURING TECHNOLOGY

Stock Tools

The broadest line of stationary diamond dressing tools and brake-controlled truing devices.

Custom-engineered Tools

We have custom tools for virtually every application. When Norton quality stock products do not fulfill your requirements for diamond quality or geometry, your Norton distributor, Norton sales representative and our product engineering staff will work with you to ensure that you get the right stationary diamond tool for your job on a custom design basis.

Resetting and Relapping Service

Norton offers expert resetting (removing single point diamond, rotating and exposing sharp, new point) and relapping (reconditioning form tool diamonds) of many of our tools – at a significant cost savings vs. new manufacture. Contact the Norton Customer Service group for a quote, current lead-times, and return procedures.

LOWER YOUR COST PER DRESSING APPLICATION

Diamonds are a rare commodity. The larger the stone and the better the quality, the higher the initial cost. The key to successful diamond tool purchasing and use is based on the “cost per dress.” Normally, higher quality diamond dressing tools and a proactive resetting program will result in lowest “cost per dress.”

In those situations where a resetting program is not feasible, or low, initial cost is the primary purchasing criteria, Norton offers an extensive line of non-resettable tools.

See page 109 for information needed for a “Competitive Tool Analysis” – to help you convert to a quality Norton diamond dressing tool.



HOW TO CHOOSE THE CORRECT DIAMOND DRESSING TOOL FOR YOUR APPLICATION

1 If you know the tool:

Find the appropriate tool section, then match your tool to the drawings in that section.

2 If you don't know the tool, but know the wheel form needed:

Find the type of wheel form to be dressed using the wheel form symbols shown throughout the book. Note the appropriate tool(s).

3 If you don't know the tool, but know the machine:

Use the “Stationary Diamond Tool Recommendations by Machine Type” chart on pages 105-108. Note the appropriate tool(s).

4 Then review the recommended tools' features and benefits in their catalog sections to choose the best tool for your operation. If you need engineering assistance, contact your local Norton representative.

RESETTING – MINIMIZING YOUR COST

Buying a higher quality diamond is your best value, especially if you participate in a proactive resetting program. Although initial cost may be higher, the payback comes through several factors:

- Diamond durability, providing longer tool life
- Tighter form tolerances
- Consistent finish rates
- Resetting the diamond lowers the overall tooling cost

Used properly, the overall cost of a higher quality, resettable diamond will compare favorably with that of an inexpensive, non-resettable diamond. Initially, the best diamond point is selected for use. When returned, the next best diamond point is selected for resetting, and so on.

To ensure you get the best value for your diamond:

- Rotate the diamond tool ¼ turn periodically to maintain a sharp point
- Use proper flow of coolant to protect the diamond from heat which can create fracturing of the diamond
- Excessive wear on the diamond point may impact the ability to reset the diamond. The widest point of the diamond is referred to as the girth. The diamond girth is buried in a powder metal matrix. Using a diamond into the girth zone might impact the ability to reset other diamond points

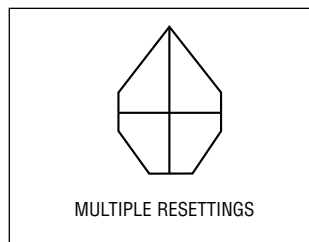
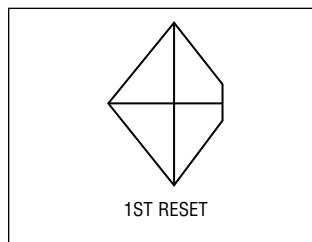
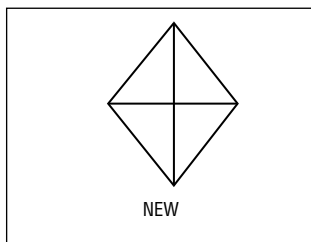

TECHtip

WHEEL CONDITIONING

Stationary diamond dressing tools are used to condition grinding wheels. Wheel conditioning involves two operations: truing and dressing.

Truing the Wheel:

Primarily done during the initial set-up, truing involves three basic operations:

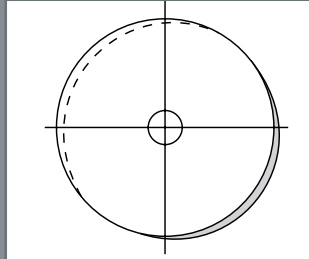

CLEANING THE WHEEL TO MAKE IT RUN TRUE WITH THE AXIS OF ROTATION

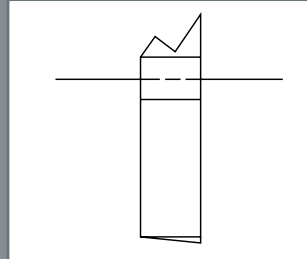

RESTORING THE WHEEL PROFILE TO PROPER GEOMETRY IN RESPONSE TO WHEEL BREAKDOWN

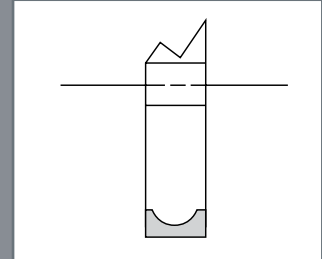

CHANGING THE PROFILE OF THE WHEEL TO THE DESIRED SHAPE

Dressing the Wheel:

Dressing is done intermittently throughout the operation – after a certain number of parts are ground, as wheel loads, closes up, etc. – to keep the wheel at peak performance.

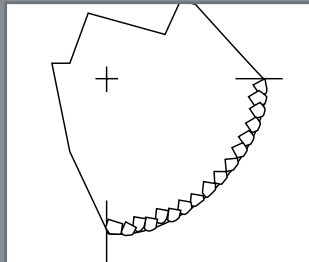

REMOVING DULL ABRASIVE PARTICLES OPENS THE WHEEL, INCREASING STOCK REMOVAL RATES, DECREASING SURFACE FINISH QUALITY.

DULLING THE ABRASIVE PARTICLES CLOSES THE WHEEL, INCREASING SURFACE FINISH QUALITY, DECREASING STOCK REMOVAL RATES.

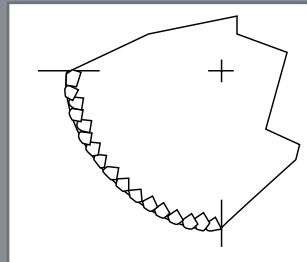

REMOVING FOREIGN MATERIAL FROM A "LOADED" WHEEL OPENS THE WHEEL, EXPOSING NEW CUTTING GRAINS.

TYPICAL WHEEL FORMS DRESSED BY STATIONARY DIAMOND TOOLS

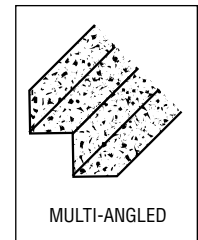
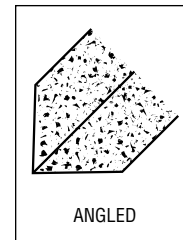
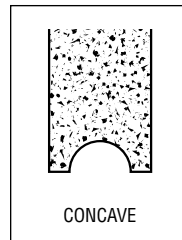
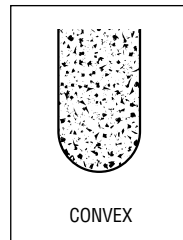
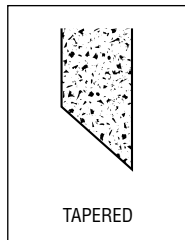
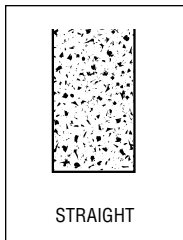

SPECcheck

GUIDELINES FOR LEAD SELECTION

Use the optimum traverse rate of a diamond tool to appropriately condition the wheel face for your grinding operation.

Slower lead (and traverse rate) tends to close up the wheel face to provide:

- Better finishes (low RMS/Ra readings)
- Lower stock removal rates

Faster lead (and traverse rate) tends to open up the wheel face to provide:

- Faster stock removal rates (“hungry” wheel)
- Rougher finishes (high RMS/Ra readings)

Formula for Traverse Rate: Speed of Wheel (RPM) x Lead Selection Per Wheel Revolution = Traverse Rate (Inches Per Minute)

To Convert RPM to SFPM: Multiply wheel diameter in inches X RPM X 0.262

TOOL TYPE	LEAD SELECTION / TRAVERSE RATE
Single Point Tools	Coarse Finish = .008" - .010" per wheel revolution
Form Tools	Medium Finish = .005" - .007" per wheel revolution
	Fine Finish = .002" - .004" per wheel revolution
EXAMPLE – SINGLE POINT	
Wheel:	14 x 1-1/2 x 5" 5SG60-KVS
Tool:	SG5M7 (1/2 carat Single Point)
Wheel Speed:	6500 SFPM = 1773 RPM
Stock Removal/Finish:	Medium/32 RMS
Lead Selection:	.006" per wheel revolution
Travers Rate:	1773 x .006 = 10.6" per minute traverse
Multi-Point (Grit) Tools	Coarse Finish = .023" - .030" per wheel revolution
Blade Tools	Medium Finish = .013" - .022" per wheel revolution
Cluster Tools	Fine Finish = .006" - .012" per wheel revolution
EXAMPLE – MULTI-POINT	
Wheel:	7 x 1 x 1-1/4" 32A60-KVBE
Tool:	1R6J6 (1/4" round tool)
Wheel Speed:	6500 SFPM = 3547 RPM
Stock Removal/Finish:	Coarse/64 RMS
Lead Selection:	.024" per wheel revolution
Traverse Rate:	3547 x .024 = 85.1" per minute traverse



POSITIVE INFLUENCES ON STATIONARY TOOLS

Coolant – Dress Wet

- Use coolant with ample pressure, volume, and filtration whenever possible.
- A stationary tool used with coolant will last longer than a tool used without coolant.

Rigid Tool Holder

- A rigid tool holder will keep vibration to a minimum.
- Vibration in the tool holder will create an inconsistent surface on the grinding wheel and eventually cause the diamond in the tool to crack.

Minimal Infeeds

- Using manufacturer’s suggested amounts will allow for maximum tool life.
- Avoid excessive infeeds – excessive infeed creates damaging heat and a tendency to damage the diamond.

Proper Alignment

- Blade and Chisel-type tools require proper alignment to perform correctly and obtain maximum life expectancy.

SPECcheck

TROUBLESHOOTING GUIDE

PROBLEM	POSSIBLE CAUSES	SUGGESTED CORRECTION
Chatter	Tool not secure Diamond traversing too slowly Wheel loaded Worn diamond	Remount or check for worn or loose holder Use faster traverse Dress more frequently Rotate tool or replace
Burn	Tool traversing too slowly Poor coolant on part and tool Diamond too flat Diamond too large	Increase traverse rate Increase coolant flow at point of contact Rotate or replace tool Reduce size or try multi-point tool
Scratches	Wheel too rough Coolant	Slow down traverse Check filtration
Diamond lines	Traversing too fast No dwell time	Slow down dress rate Increase sparkout
Inaccuracies in parts	Cam worn Poor mounting Worn tool Tool too tight	Replace temple and follower Check mounting and alignment Check rest and locations for movement Tool is bent. Replace.
Parts too hot	Dressing too slowly Diamond too flat	Increase crossfeed rate Rotate or replace tool
Wheel is loaded	Dressed too infrequently Infeed too light	Dress more often Increase infeed amount
Wheel acts too soft	Overdressing	Reduce infeed rate and slow crossfeed
Wheel doesn’t cut	Wheel closed	Increase infeed rate and increase crossfeed
Short diamond life	Vibration Lack of coolant Infeed cycle Poor mounting Hogging	Remove shock from diamond contact area Clean coolant line Reduce excessive infeed Secure tool, do not over-tighten, seat into holder properly Do not exceed recommended infeeds If single-point - rotate tool, use drag angle If multi-point - must be flush with wheel face, increase from single-point crossfeed rate, break in tool correctly
Diamond Breakage	Storage Pressure Temperature	Keep protected from shock Reduce heavy infeed Control sudden changes

SINGLE POINT TOOLS

SINGLE POINT TOOLS

The unparalleled, Norton line of single point tools sets the industry standard for straight and simple form dressing applications. Our extensive offering of numerous, high quality diamond tools includes: resettable and non-resettable products, tools for all abrasive types (conventional and advanced ceramic grains) and the technology-leading Norton "Indexable" tool design.

WHEEL FORMS DRESSED BY THESE TOOLS



STRAIGHT



TAPERED



CONVEX



TECHtip

- Rigidly mount single point tools at a 10° - 15° angle to the wheel centerline with a line drawn through the center of the wheel, pointing in the direction of wheel travel.
- Point of contact should be slightly below centerline of wheel as shown.
- Use coolant whenever possible.
- Normal infeed is .001" per pass.
- Lead selections range from .002" - .010" per wheel revolution.
- Rotate the tool 1/4 turn periodically to maintain a sharp point.

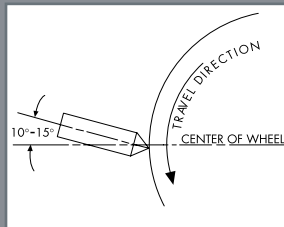

To optimize applications using ceramic abrasives and/or tools, normal dressing parameters must change. Reduce infeed by 25%. Significant reductions in the amount of infeed and frequency of dress will result in substantially lower cost per part ground.

SINGLE POINT DRESS TRAVERSE RATE

Select a Lead Value based on desired Surface Finish and run the formula below.

FINISH	LEAD VALUE (PER WHEEL REVOLUTIONS)
For Coarse Finish (approx. 64 RMS)	.008" to .010"
For Medium Finish (approx. 32 RMS)	.005" to .009"
For Fine Finish (approx. 16 RMS)	.002" to .004"

$$\text{LEAD VALUE} \times \text{WHEEL SPEED (RPM)} = \text{TRAVERSE RATE IN INCHES/MINUTE}$$



- Slower traverse rates result in a closed wheel face and lower surface finish readings on the workpiece.
- Faster traverse rates result in an open wheel face that produces greater stock removal and a rougher workpiece finish.



It is the user's responsibility to refer to and comply with ANSI B7.1

NORTON SINGLE POINT DIAMOND QUALITY LEVEL DESIGNATIONS

Norton adheres to the Industrial Diamond Association's standards for diamond weight tolerances.

QUALITY LEVEL	SETTABLE POINTS	STRUCTURE AND SHAPE	INTEGRITY
AA	Four settable points	Well defined octahedron or dodecahedron	Smooth surfaces, free of cracks, seams or surface imperfections
SG	Three settable points	Well defined dodecahedron with minor surface irregularities	Free of major cracks, may have seams or imperfections
A	Three settable points	Blocky, pointed structure, octahedrons or dodecahedrons, with minor surface irregularities	Free of major cracks, may have seams or imperfections
NS Norton Standard	Two settable points	Blocky structure, octahedrons, or dodecahedrons, with minor surface irregularities	May have cracks, seams or defects away from point
BCSG	One point; non-resettable	One well defined dodecahedron point	May have cracks, seams or defects away from point
BC	One point; non-resettable	Blocky-shaped octahedron with rough surface and irregularities	May have cracks/seams/defects around point. Defects may decrease average tool life
Octahedron:	An 8-sided diamond which can have a maximum of six pyramid-shaped points. 		
Dodecahedron:	A 12-sided diamond which can have a maximum of six broader-shaped points. 		

SPECcheck

SELECTION GUIDE

Stock Tools for Ceramic Abrasive Wheels

SG/Ceramic Engineered for use on ceramic (SG, NQ, Targa, etc.) wheels but may also provide significant benefits when used on conventional abrasive products. These tools are furnished with top quality specially selected diamonds.

BCSG/Ceramic Economical alternative to an “SG” tool. Best choice when a disposable tool is preferred.

Stock Tools for Conventional Abrasive Wheels

NS Engineered for use on conventional abrasives. These high-quality, value-priced tools can be used for a variety of dressing applications.

BC Economical alternative to an “NS” tool. Best choice when a disposable tool is preferred.

SELECTING THE CORRECT SINGLE POINT TOOL:

- Identify the wheel abrasive type: A/O, S/C or Ceramic
- Determine the wheel diameter – to select the optimum carat weight
- Determine the tool holder size – to select appropriate shank diameter

EXAMPLES OF SINGLE POINT TOOL SELECTION

Conventional Wheel Spec:	32A46-IVBE 7" x 1/2" x 1-1/4" Customer's machine has a 7/16" tool holder
Tool Selections:	Resetable: NS2M7 or NSUD2 (Indexable) Non-Resetable: BC2M7 or BCUD2 (Indexable)
Ceramic Wheel Spec:	5SG60-JVS or 5NQ60-IVS 10" x 1" x 3" Customer's machine has a 3/8" tool holder
Tool Selections:	Resetable: SG3M6 Non-Resetable: BCSG3M6

DETERMINING THE BEST VALUE

- Remember that diamonds are a rare commodity—the larger the stone and the better the quality, the higher the initial cost. The key to successful diamond tool productivity and use is based on the “cost per dress.” Normally, higher quality diamonds and a proactive resetting program will result in the lowest “cost per dress.”
- In those situations where a resetting program is not feasible or low initial cost is the primary purchasing consideration, Norton offers a complete line of non-resettable tools.

STOCK SINGLE POINT TOOL MARKING SYSTEM

DIAMOND QUALITY	DIAMOND SIZE	SHANK DESIGN	SHANK DIAMETER
SG/Ceramic	1 = 1/5 (.20) carat	M	6 = 3/8"
BCSG/Ceramic	2 = 1/4 (.25) carat	J	7 = 7/16"
NS	3 = 1/3 (.33) carat		
BC	5 = 1/2 (.50) carat		
	7 = 3/4 (.75) carat		
	10 = 1 carat		

EXAMPLE: NS 2 M 6

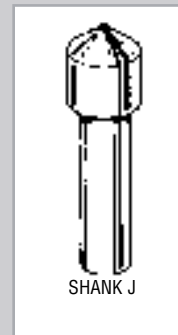

NON-STOCK SINGLE POINT TOOL MARKING SYSTEM

TOOL TYPE	DIAMOND SIZE	DIAMOND QUALITY	SHANK DESIGN	SHANK DIAMETER
SP	1 = 1/5 (.20) carat	AA	M	6 = 3/8"
	2 = 1/4 (.25) carat	A	J	7 = 7/16"
	3 = 1/3 (.33) carat	NS		
	5 = 1/2 (.50) carat	BC		
	7 = 3/4 (.75) carat			
	10 = 1 carat			

EXAMPLE: SP 5 A M 7

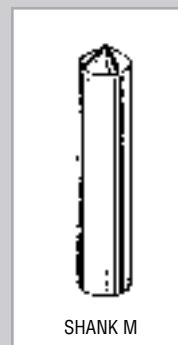

CONTACT YOUR NORTON REPRESENTATIVE FOR ALL YOUR NON-STOCK, CUSTOM CONFIGURATION QUESTIONS, REQUESTS FOR QUOTES, ETC.

SINGLE POINT TOOLS FOR TRUING/DRESSING CERAMIC ABRASIVES

SG/CERAMIC SINGLE POINT TOOLS

FEATURES	BENEFITS
<ul style="list-style-type: none"> ■ Specially selected broad-shaped, diamond ■ Each diamond is hand selected for stone shape, quality and structural integrity ■ Multi-purpose 	<ul style="list-style-type: none"> ■ Withstands the increased grinding pressures of ceramic abrasives ■ Consistent tool performance ■ Accommodates most straight dressing and simple form dressing applications ■ Stands up to ceramic (SG, NQ, TG, etc.) abrasive sharpness; can also be used to dress conventional abrasives



BEST

RESETTABLE SG/CERAMIC SINGLE POINT TOOLS

- Norton high quality diamond and a proactive resetting program will result in the lowest dressing cost per part

GOOD

NON-RESETTABLE BCSG/CERAMIC SINGLE POINT TOOLS

- The best selection when a resetting program is not feasible or low initial cost is the primary purchasing consideration

WHEEL DIAMETER	TOOL CARAT WEIGHT	TOOL DIAMETER	TOOL LENGTH	BEST		GOOD	
				PRODUCT #	3 SETTABLE PTS (2 RESETS) UPC #	PRODUCT #	NON-RESETTABLE UPC #
STOCK SINGLE POINT TOOLS FOR TRUING/DRESSING CERAMIC ABRASIVES							
Up to 7"	1/4 (.25)	3/8"	2"	SG2M6	66260195365	BCSG2M6	66260157007
		7/16"	2"	SG2M7	66260195366	BCSG2M7	66260156905
8" to 10"	1/3 (.33)	3/8"	2"	SG3M6	66260195367	BCSG3M6	66260157008
		7/16"	2"	SG3M7	66260195368	BCSG3M7	66260156906
11" to 14"	1/2 (.50)	3/8"	2"	SG5M6	66260195369	BCSG5M6	66260157009
		7/16"	2"	SG5M7	66260195370	BCSG5M7	66260156907
15" to 20"	3/4 (.75)	3/8"	2"	SG7M6	66260195371	BCSG7M7	66260156908
		7/16"	2"	SG7M7	66260195372	BCSG10M7	66260157010
21"+	1 (1.00)	7/16"	2"				

WHEEL FORMS DRESSED BY THESE TOOLS



STRAIGHT TAPERED CONVEX

NON-STOCK SG RESETTABLE SINGLE POINT TOOLS ARE ALSO AVAILABLE.
STANDARD PACKAGE = 1 TOOL

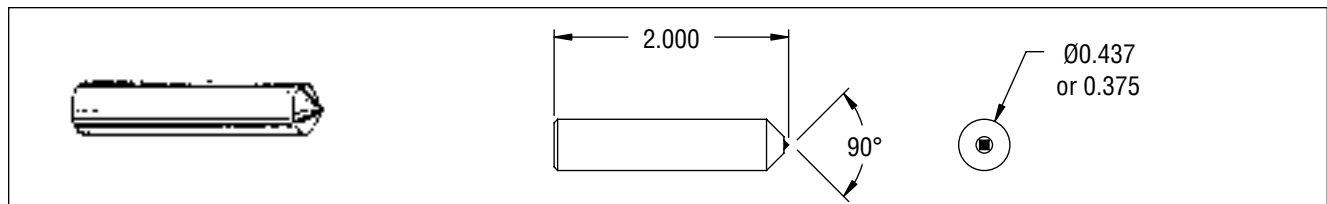

SINGLE POINT TOOLS FOR TRUING/DRESSING CONVENTIONAL ABRASIVES

CONVENTIONAL SINGLE POINT TOOLS

FEATURES	BENEFITS
<ul style="list-style-type: none"> ■ Consistent diamond structure and shape ■ Well defined, sharp diamond point ■ Steeper 60 degree included angle head design 	<ul style="list-style-type: none"> ■ Repeatable dressing performance ■ Durable; maximum cost effectiveness for dressing conventional abrasives ■ Greater machine and part clearance produce forms with tighter tolerances



BEST

RESETTABLE NS (NORTON STANDARD) SINGLE POINT TOOLS

- High quality diamonds, value priced
- Selection of the correct tool and a proactive resetting program will result in the lowest dressing cost per part

GOOD

NON-RESETTABLE BC SINGLE POINT TOOLS

- The best selection when a resetting program is not feasible or low initial cost is the primary purchasing consideration

SINGLE POINT TOOLS FOR TRUING/DRESSING CONVENTIONAL ABRASIVES (CONTINUED)

WHEEL DIAMETER	TOOL CARAT WEIGHT	TOOL DIAMETER	BEST		BETTER		BETTER		GOOD	
			PRODUCT #	UPC #	PRODUCT #	UPC #	PRODUCT #	UPC #	PRODUCT #	UPC #
STOCK SINGLE POINT TOOLS FOR TRUING/DRESSING CONVENTIONAL ABRASIVES										
Internal Wheel	1/5 (.20)	3/8"							BC1M6	66260195021
		7/16"							BC1M7	66260195022
Up to 7"	1/4 (.25)	3/8"					NS2M6	66260195116	BC2M6	66260195000
		7/16"					NS2M7	66260195117	BC2M7	66260195001
8" to 10"	1/3 (.33)	3/8"					NS3M6	66260195121	BC3M6	66260195002
		7/16"					NS3M7	66260195122	BC3M7	66260195003
11" to 14"	1/2 (.50)	3/8"					NS5M6	66260195126	BC5M6	66260195004
		7/16"					NS5M7	66260195127	BC5M7	66260195005
15" to 20"	3/4 (.75)	7/16"					NS7M7	66260195132	BC7M6	66260195006
		7/16"					NS7J7	66260195130	BC7M7	66260195007
21" +	1 (1.00)	3/8"					NS10M6	66260195136	BC10M6	66260195008
		7/16"					NS10M7	66260195137	BC10M7	66260195009
		7/16"					NS10J7 *	66260195135		

* J-SHANK TOOLS ARE AVAILABLE IN 7/16" DIAMETER WITH 5/8" HEAD

NON-STOCK SINGLE POINT TOOLS FOR TRUING/DRESSING CONVENTIONAL ABRASIVES

Internal	1/5 (.20)	3/8"	SP1AAM6	66260195990	SP1AM6	66260196014				
Wheels		7/16"	SP1AAM7	66260195991	SP1AM7	66260196015				
Up to 7"	1/4 (.25)	3/8"	SP2AAM6	66260195994	SP2AM6	66260196018				
		7/16"	SP2AAM7	66260195995	SP2AM7	66260196019				
8" to 10"	1/3 (.33)	3/8"	SP3AAM6	66260195998	SP3AM6	66260196022				
		7/16"	SP3AAM7	66260195999	SP3AM7	66260196023				
11" to 14"	1/2 (.50)	3/8"	SP5AAM6	66260196002	SP5AM6	66260196026				
		7/16"	SP5AAM7	66260196003	SP5AM7	66260196027				
15" to 20"	3/4 (.75)	3/8"	SP7AAM6	66260196006	SP7AM6	66260145772				
		7/16"	SP7AAM7	66260196007	SP7AM7	66260145778				
21" +	1 (1.00)	3/8"	SP10AAM6	66260160468	SP10AM6	66260196034				
		7/16"	SP10AAM7	66260196011	SP10AM7	66260196035				

NON-STOCK "AA" AND "A" DIAMOND QUALITY LEVEL RESETTABLE PRODUCTS ARE TYPICALLY USED FOR PRECISION APPLICATIONS.

ADDITIONAL NON-STOCK AVAILABILITY:

- NON-STOCK TOOLS WITH A "J" SHANK ARE AVAILABLE IN 7/16" DIAMETER WITH 5/8" HEAD
- LARGER CARAT WEIGHT DIAMONDS

STANDARD PACKAGE = ONE TOOL

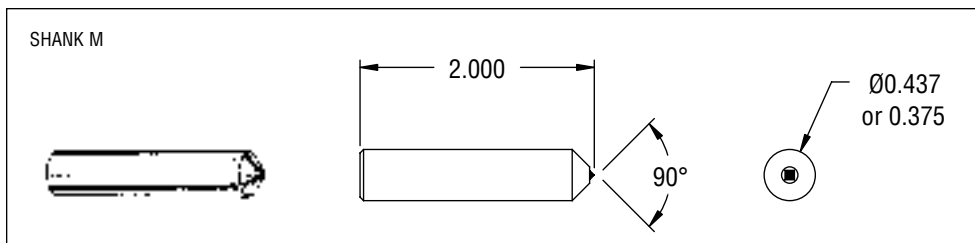
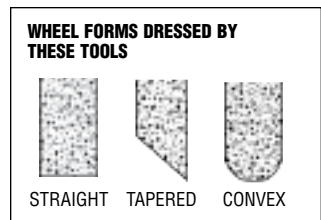
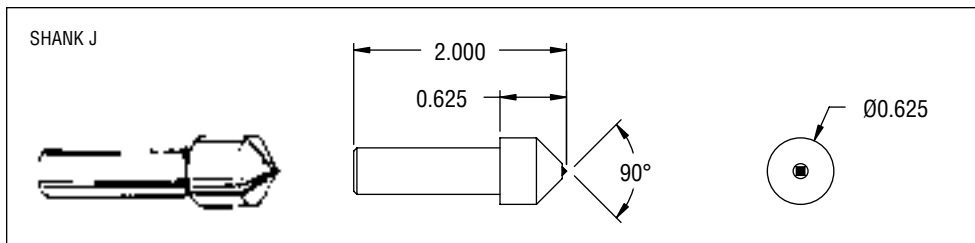

CONTACT YOUR NORTON REPRESENTATIVE FOR ALL YOUR NON-STOCK, CUSTOM CONFIGURATION QUESTIONS, REQUESTS FOR QUOTES, ETC.

INDEXABLE SINGLE POINT TOOLS

Indexable tools are specifically designed to alleviate any misalignment issues and are the tools of choice for CNC grinders. They feature a two-part construction with the head and shank as separate pieces. After the initial installation, operators simply turn the indexable head with a wrench, while the tool shank remains secure (and aligned) in the tool holder.

INDEXABLE SINGLE POINT TOOLS

FEATURES	BENEFITS
<ul style="list-style-type: none"> Easily turned without removing tool from the holder 	<ul style="list-style-type: none"> Easier for operators to turn than conventional tools increasing frequency of beneficial tool turning Extended life; less downtime and increased productivity
<ul style="list-style-type: none"> U-Dex-It and Mini-Dex tools have a 60° included angle head design 	<ul style="list-style-type: none"> Provides additional form versatility through machine and part clearance Excellent choice for regulating wheels



INDEXABLE SINGLE POINT TOOLS FOR TRUING/DRESSING CERAMIC ABRASIVES

GOOD

NON-RESETTABLE BCSGUD/CERAMIC U-DEX-IT INDEXABLE SINGLE POINT TOOLS

- These U-Dex-It tools contain specially selected diamonds to withstand increased ceramic (SG, Norton Quantum NQ, Targa TG, etc.) grinding pressures
- Ideal for centerless grinders; the head can be turned, using standard 5/8" wrench, through the hole in the side of the wheel guard without removing the guard
- The best selection when a resetting program is not feasible or low initial cost is the primary purchasing consideration

				GOOD	
WHEEL DIAMETER	TOOL CARAT WEIGHT	TOOL SIZE	PRODUCT #	NON-RESETTABLE UPC #	
STOCK INDEXABLE SINGLE POINT TOOLS FOR TRUING/DRESSING CERAMIC ABRASIVES					
Up to 7"	1/4 (.25)	7/16" x 1-7/16" with 5/8" head	BCSGUD2	66260162669	
8" to 10"	1/3 (.33)	7/16" x 1-7/16" with 5/8" head	BCSGUD3	66260162668 +	
11" to 14"	1/2 (.50)	7/16" x 1-7/16" with 5/8" head	BCSGUD5	66260159894	

STANDARD PACKAGE = ONE TOOL

+ Available as stock while supplies last, then available as non-stock.

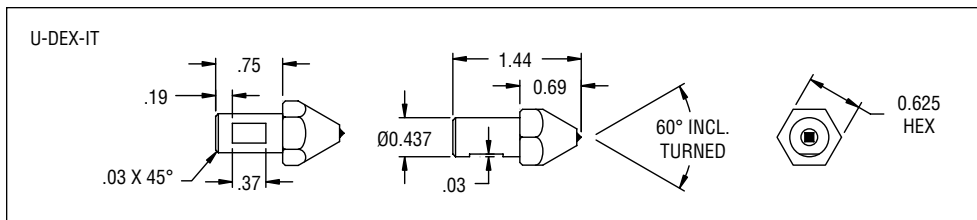

WHEEL FORMS DRESSED BY THESE TOOLS

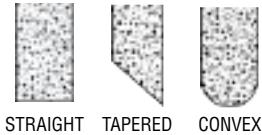

INDEXABLE SINGLE POINT TOOLS FOR TRUING/DRESSING CONVENTIONAL ABRASIVES

BETTER

RESETTABLE NORTON STANDARD NSUD U-DEX-IT INDEXABLE SINGLE POINT TOOLS

- High quality diamonds, value priced
- Ideal for centerless grinders; the head can be turned, using standard 5/8" wrench, through the hole in the side of the wheel guard without removing the guard
- Selection of the correct tool and a proactive resetting program will usually result in the lowest dressing cost per part

BETTER

RESETTABLE NORTON STANDARD NSMD MINI-DEX INDEXABLE SINGLE POINT TOOLS

- High quality diamonds, value priced
- Use a standard 7/16" wrench to turn; designed for internal, bearing race and twist drill flute machines
- Selection of the correct tool and a proactive resetting program will usually result in the lowest dressing cost per part

GOOD

NON-RESETTABLE BCUU U-DEX-IT INDEXABLE SINGLE POINT TOOLS

- Ideal for centerless grinders; the head can be turned, using standard 5/8" wrench, through the hole in the side of the wheel guard without removing the guard
- The best selection when a resetting program is not feasible or low initial cost is the primary purchasing consideration

INDEXABLE SINGLE POINT TOOLS FOR TRUING/DRESSING CONVENTIONAL ABRASIVES (CONTINUED)

WHEEL DIAMETER	TOOL CARAT WEIGHT	TOOL SIZE	BETTER		GOOD	
			PRODUCT #	2 SETTABLE PTS (1 RESET) UPC #	PRODUCT #	NON-RESETTABLE UPC #
STOCK INDEXABLE SINGLE POINT TOOLS FOR TRUING/DRESSING CONVENTIONAL ABRASIVES						
Up to 7"	1/4 (.25)	7/16" x 1-7/16" with 5/8" head 1/4" x 1-3/16" with 7/16" head	NSMD2	66260195171	BCUD2	66260195023
8" to 10"	1/3 (.33)	7/16" x 1-7/16" with 5/8" head 1/4" x 1-3/16" with 7/16" head	NSUD3	66260195162	BCUD3	66260195024
11" to 14"	1/2 (.50)	7/16" x 1-7/16" with 5/8" head 1/4" x 1-3/16" with 7/16" head	NSUD5	66260195163	BCUD5	66260195025
15" to 20"	3/4 (.75)	7/16" x 1-7/16" with 5/8" head	NSMD5	66260195173 +		
			NSUD7	66260195164		

STANDARD PACKAGE = ONE TOOL

+ AVAILABLE AS STOCK WHILE SUPPLIES LAST, THEN AVAILABLE AS NON-STOCK.

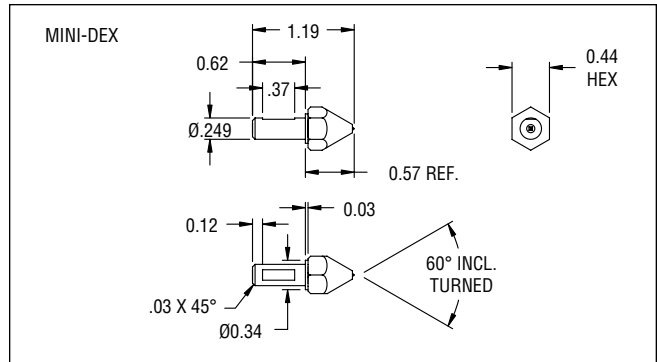
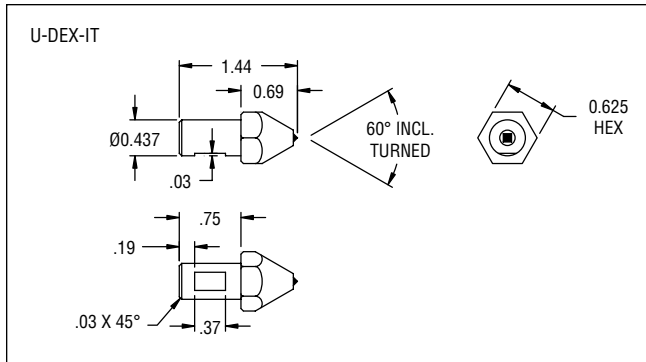

INTERNAL GRINDING TOOLS

BEST RESETTABLE INTERNAL GRINDING TOOLS

■ Q style shank is used on a Heald internal grinder (resettable).



MACHINE TYPE	CARAT WEIGHT	SHANK DIAMETER	TOOL LENGTH	BEST	
				PRODUCT #	2 SETTABLE PTS (1 RESET) UPC #
STOCK INTERNAL GRINDING TOOLS					
Heald	1/5 (.20)	7/16"	1"	NI21Q7	66260195180

STANDARD PACKAGE = 1 TOOL

WHEEL FORMS DRESSED BY THESE TOOLS



STRAIGHT



TAPERED



CONVEX



CONCAVE

SHANK Q FOR HEALD MACHINE

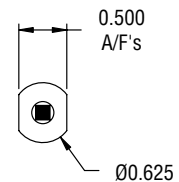
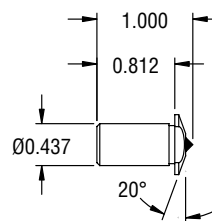

THREAD GRINDING TOOLS

BEST

RESETTABLE SG/CERAMIC THREAD GRINDING TOOLS

- These wheels are used on J & L and Excello thread grinding machines to accurately dress the grinding wheels that form the desired thread configuration (non-resettable).



MACHINE TYPE	SHANK DIAMETER	TOOL LENGTH	INCLUDED ANGLE	MAX RADIUS ON POINT	BEST	
					PRODUCT #	NON-RESETTABLE UPC #
STOCK THREAD GRINDING TOOLS						
J & L	1/4"	1"			38RL4	66260195100
J & L	1/4"	1"	80°	.010"	NT1L4	66260195187
EXCELLO	3/8"	1-5/8"	60°	.010"	NT106	66260195190
NON-STOCK THREAD GRINDING TOOLS						
J & L	1/4"	1"	80°	.010"	NX-57475	66260195185
EXCELLO	3/8"	1-5/8"	60°	.010"	48-4105	66260195188

STANDARD PACKAGE = 1 TOOL

WHEEL FORMS DRESSED BY THESE TOOLS



STRAIGHT



TAPERED

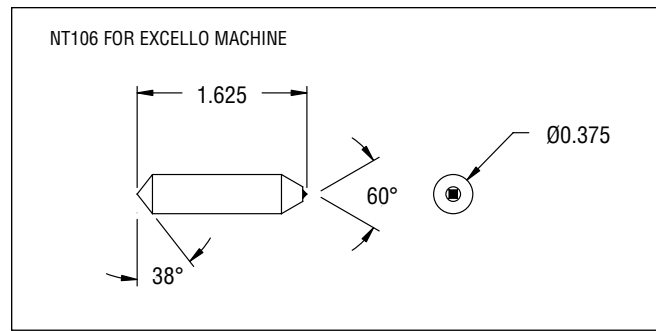
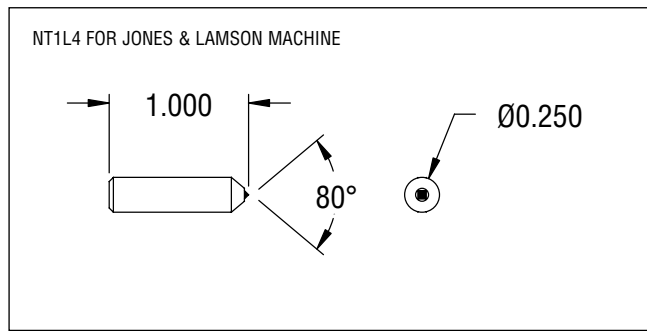

CONTACT YOUR NORTON REPRESENTATIVE FOR ALL YOUR NON-STOCK, CUSTOM CONFIGURATION QUESTIONS, REQUESTS FOR QUOTES, ETC.

TOOLROOM TOOLS

Norton Toolroom Dressing Tools are primarily used on surface grinders to form the grinding wheel to an exact concave or convex radius. Although some tools are designed for use on a specific machine, many radius tools can be used on any grinder having the correct set-up.

Used generally on 8" diameter and smaller vitrified toolroom wheels, Norton offers a selection of phono-point, conventional radius, and full ball radius tools.

WHEEL FORMS DRESSED BY THESE TOOLS



STRAIGHT



CONCAVE



CONVEX



MULTI-ANGLED



PHONO-POINT TOOLS

For general toolroom concave and convex dressing on small diameter grinding wheels. Not resettable.

INCLUDED ANGLE	SHANK DIAMETER	TOOL LENGTH	BETTER		GOOD	
			PRODUCT #	NON-RESETTABLE UPC #	PRODUCT #	NON-RESETTABLE UPC #
STOCK PHONO-POINT TOOLS						
60°	1/8"	1"	NP1M2	66260195225	BCPP-60	66260195017
	3/16"		NP1M3	66260195226		
	1/4"		NP1M4	66260195227		
75°	1/8"	1"	NP2M2	66260195228	BCPP-75	66260195018
	1/4"		NP2M4	66260195230		
90°	1/8"	1"	NP3M2	66260195231	BCPP-90	66260195019
	3/16"		NP3M3	66260195232		
	1/4"		NP3M4	66260195233		

STANDARD PACKAGE = ONE TOOL

WHEEL FORMS DRESSED BY THESE TOOLS



CONVEX



CONCAVE



CONVEX

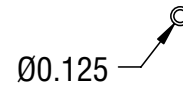
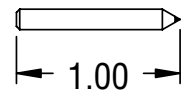

TYPICAL WHEEL FORMS

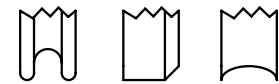

TECHtip

HOW TO USE TOOLROOM TOOLS

- We recommend dressing with coolant. However, if dressing totally dry, allow three to five seconds between passes for diamond to cool.
- Use extremely light cuts from .0002" to .001" maximum.
- Rotate tool if the application and set-up allow.
- Full Ball Radius Tools should be returned for relap after minimum wear.

SPECcheck

PHONO-POINT TOOL MARKING SYSTEM

TOOL TYPE	INCLUDED ANGLE ON DIAMOND	SHANK STYLE	SHANK DIAMETER
NP	1 = 60°	M	2 = 1/8"
BCPP	2 = 75°		3 = 3/16"
	3 = 90°		4 = 1/4"

EXAMPLE: NP 1 M 3

RADIUS TOOLS

Concave Radius Tools

This line offers a specially-shaped single point diamond, designed for forming concave radii on small diameter grinding wheels. Not resettable.

Convex Radius Tools

This line offers a specially-shaped single point diamond, designed for forming convex radii on small diameter grinding wheels. Not resettable.

Half-Circle Concave Radius Tools (Available as Non-stock Only)

This line offers a specially-shaped diamond set in the side of the shank for forming half-circle radii on small diameter grinding wheels. The tool is rotated to form the radius. Commonly called a "rat tail dresser." Not resettable.

RADIUS SIZE TO BE DRESSED	SHANK DIAMETER	BEST			GOOD		
		TOOL LENGTH	PRODUCT #	NON-RESETTABLE UPC #	TOOL LENGTH	PRODUCT #	NON-RESETTABLE UPC #
STOCK CONCAVE RADIUS TOOLS							
.010" to .015"	3/8"	2"	NR1P6	66260195210			
.016" to .020"	3/8"	2"	NR2P6	66260195211			
.021" to .032"	3/8"	2"	NR3P6	66260195212			
.033" to .062"	3/8"	2"	NR4P6	66260195213	2"	BCRD	66260195016
.063" to .125"	3/8"	2"	NR5P6	66260195214	2"	BCRD	66260195016
.126" to .250"	3/8"	2"	NR6P6	66260195215	2"	BCRD	66260195016
STOCK CONVEX RADIUS TOOLS							
.020" to .125"	3/8"	2"	NR2M6	66260195216			
.126" to .250"	3/8"	2"	NR12M6	66260195217			
.251" to .500"	3/8"	2"	NR25M6	66260195218			
NON-STOCK HALF-CIRCLE CONCAVE RADIUS TOOLS							
.032"	3/8"	2-1/2"	NR3N6	66260195219 *			
.062"	3/8"	2-1/2"	NR6N6	66260195220 *			
.125"	3/8"	2-1/2"	NR12N6	66260195221 *			

STANDARD PACKAGE = ONE TOOL

* NON-STOCK; CONTACT YOUR NORTON REPRESENTATIVE FOR CURRENT LEAD-TIMES.

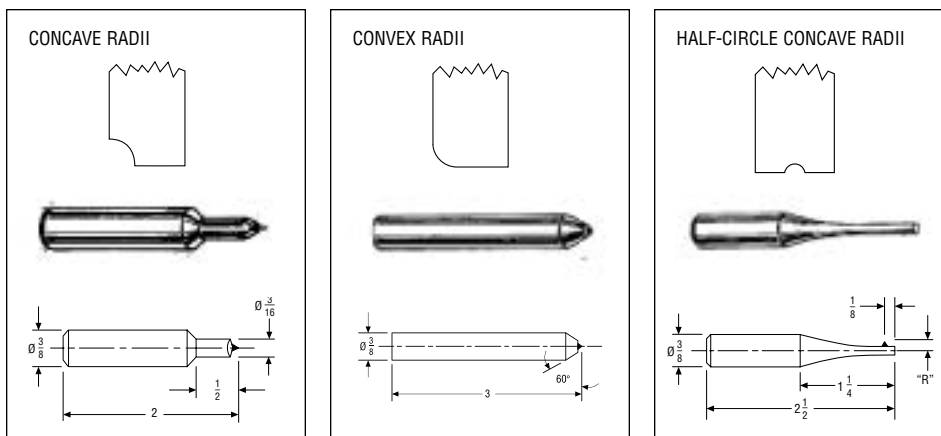

FULL BALL RADIUS TOOLS

For precision plunge form dressing, Full Ball Radius tools are designed to plunge dress a concave radius in the center of a grinding wheel. Frequent turning of the tool will maintain accuracy over a long period of use. Can be relapped.

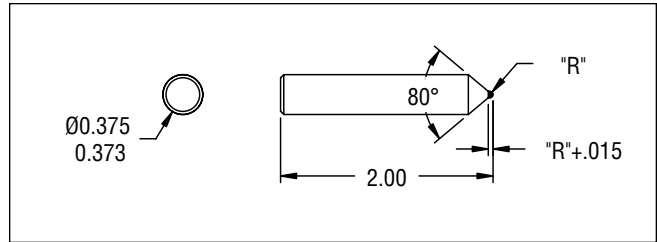

RADIUS SIZE TO BE DRESSED	SHANK DIAMETER	TOOL LENGTH	BETTER	
			PRODUCT #	RELAPPABLE UPC #
NON-STOCK FULL BALL RADIUS TOOLS				
.010"	3/8"	2"	FB10	66260195255
.015"	3/8"	2"	FB15	66260195256
.020"	3/8"	2"	FB20	66260195257
.025"	3/8"	2"	FB25	66260195258
.030"	3/8"	2"	FB30	66260195259
.035"	3/8"	2"	FB35	66260195260
.040"	3/8"	2"	FB40	66260195261
.045"	3/8"	2"	FB45	66260195262
.050"	3/8"	2"	FB50	66260195263

**LARGER RADIUS SIZES ARE AVAILABLE UPON REQUEST.
STANDARD PACKAGE = ONE TOOL**



SPECcheck

FULL BALL RADIUS TOOL MARKING SYSTEM

TOOL TYPE	RADIUS REQUIRED ON DIAMOND IN THOUSANDS OF AN INCH
FB	10 = .010"
	15 = .015"
	20 = .020"
	25 = .025"
	30 = .030"
	35 = .035"
	40 = .040"
	45 = .045"
	50 = .050"

EXAMPLE: FB 25

CONTACT YOUR NORTON REPRESENTATIVE FOR ALL YOUR NON-STOCK, CUSTOM CONFIGURATION QUESTIONS, REQUESTS FOR QUOTES, ETC.

MULTI-POINT (GRIT) TOOLS

Since Norton conventional and high-performance Multi-Point tools never need turning or resetting, they are the most economical way to accomplish a variety of straight, tapered, and step dressing operations on all sizes of cylindrical, centerless, surface, and toolroom grinding wheel applications.

WHEEL FORMS DRESSED BY THESE TOOLS



STRAIGHT



TAPERED



NORTON MULTI-POINT TOOLS

FEATURES

- Uniformly distributed diamonds in a tough, durable matrix
- Fresh, multiple diamond points exposed in truing operation; no turning or resetting required
- Overall diamond weight exceeds equivalent single point tool

BENEFITS

- Consistent performance throughout tool life
- Faster, more consistent straight face dressing with maximum efficiency and longer tool life than single point tools
- The most economical way to dress straight and tapered forms

TECHtip

MULTI-POINT TOOLS – STRAIGHT FACE DRESSING AND TRUING

- Most multi-point tools are used for straight face dressing.
- Tool should have full face contact with the wheel.
- With new tool, 3–5 passes at .005" per pass should be taken to expose diamonds.
- Infeed per pass .001" - .002"
- Use coolant whenever possible.
- Use appropriate lead (and traverse rate).
- Contact your Norton representative for proper tool selection for Targa wheels.

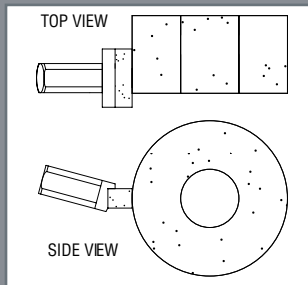

MULTI-POINT DRESS TRAVERSE RATE

Select a Lead Value based on desired Surface Finish and run the formula below.

FINISH	LEAD VALUE (PER WHEEL REVOLUTIONS)
For Coarse Finish (approx. 64 RMS)	.023" to .030" (.58mm – .76mm)
For Medium Finish (approx. 32 RMS)	.013" to .022" (.33mm – .57mm)
For Fine Finish (approx. 16 RMS)	.006" to .012" (.15mm – .33mm)

$$\text{LEAD VALUE} \times \text{WHEEL SPEED (RPM)} = \text{TRAVERSE RATE IN INCHES/MINUTE}$$

- Slower traverse rates result in a closed wheel face that produces less stock removal and improved workpiece finish.
- Faster traverse rates result in an open wheel face that produces greater stock removal and a rougher workpiece finish.



It is the user's responsibility to refer to and comply with ANSI B7.1

SPECcheck

SELECTING THE CORRECT MULTI-POINT TOOL

- Identify the wheel abrasive type: ceramic (SG, Norton Quantum NQ, Targa TG), A/O, or S/C
- Determine the wheel diameter and grit size
- Determine the tool's approach angle to the centerline of the wheel
- Identify the tool holder diameter
- Use 1E shape for angular wheel slide, cylindrical grinding and for shoulder or step truing

EXAMPLES OF MULTI-POINT TOOL SELECTION

Conventional Wheel Spec: 32A46-IVBE 7" x 1/2" x 1-1/4"
Customer's machine has a 3/8" tool holder 1R6J6

Tool Selection:

Ceramic Wheel Spec: 5SG60-JVS or 5NQ60-IVS 10" x 1" x 3"
Customer's machine has a 7/16" tool holder SG1R6J7

Tool Selections:

SPECcheck



MULTI-POINT TOOL DIAMOND SECTION SPECIFICATIONS

SHAPE	WIDTH	LENGTH	DEPTH	TOOL APPROACH ANGLE TO WHEEL	FOR WHEEL DIAMETER
1A	1/4"	3/4"	5/16"	0°	Over 20"
2A	1/4"	1/2"	3/8"	0°	15" – 20"
3A	5/32"	3/8"	1/4"	0°	Over 20"
1E	5/32"	3/8"	5/16"	–	
2E	1/4"	1/2"	1/2"	–	20" x 2" and up
1R	1/4" Round		1/4"	0°	Up to 10"
2R	3/8" Round		3/8"	0°	11" – 14"



A SHAPE IS USED PRIMARILY FOR STRAIGHT FACE DRESSING.

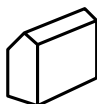

E SHAPE (DOUBLE ANGLE TOP FACE) IS USED FOR STANDARD N-FACE WHEELS, ANGULAR WHEELS, FACE AND SIDE TRUING OF CYLINDRICAL WHEELS, AND IN STEP DRESSING.



R SHAPE IS USED FOR STRAIGHT FACE DRESSING WHERE THE TOOL HOLDER IS PERPENDICULAR TO THE WHEEL FACE (NO DRAG ANGLE), AND ON THREAD GRINDING MACHINES.

MULTI-POINT TOOL MARKING SYSTEM

DIAMOND SHAPE	TOOL DIAMOND SIZE	TO DRESS GRINDING WHEELS WITH GRIT SIZE OF:	SHANK DESIGN	SHANK DIAMETER
1A	4	= 46 grit	See the following pages for shank configurations	6 = 3/8"
2A	6	= 54 - 100 grit		7 = 7/16"
3A	8	= 120 - 150 grit		8 = 1/2"
1E	12	= 150+ grit		
2E	14	= Special Applications		
1R				
2R				

EXAMPLE: 1A 6 A 7

MULTI-POINT TOOLS FOR TRUING/DRESSING CERAMIC ABRASIVES

Tool Shape and Shank Availability

SG1R

For general purpose dressing of toolroom, cylindrical, and surface grinding wheels up to 10" in diameter.

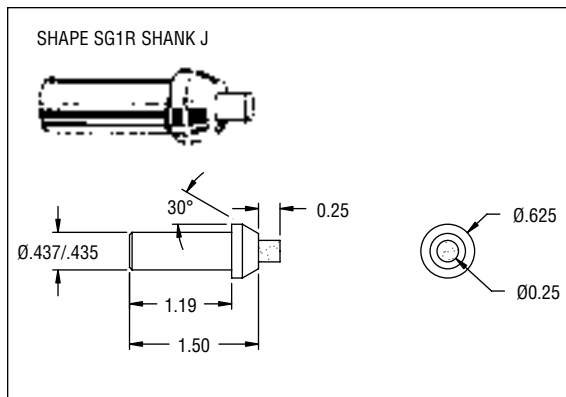
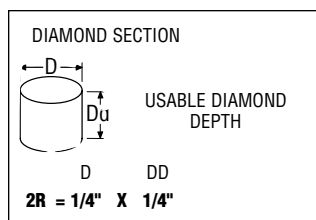

SG2R

For use on cylindrical, centerless, and surface grinding wheels 11" to 14" in diameter.

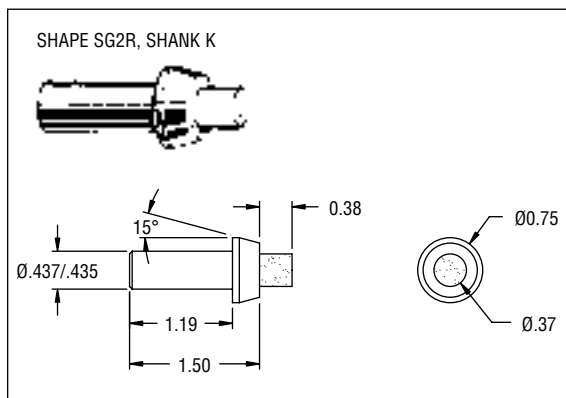
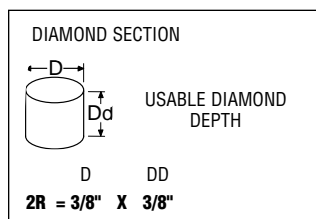

TECHtip

- To optimize applications using ceramic abrasives/tools, normal dressing parameters must change. Significant reductions in the amount of infeed and frequency of dress will result in significantly lower cost per part ground.
- While all Norton SG/Ceramic tools have been designed to improve the efficiency of ceramic grinding applications, they can also offer significant benefits in many applications using conventional abrasives.
- When first using a Norton SG/ Ceramic tool, make 3 to 5 passes at .005" infeed to ensure full face contact between the dressing tool and wheel face.
- Reduce normal dressing infeed by half. Do not exceed infeed of .002" per pass.
- The lead selection should be between .006"-.030" per wheel revolution. Faster traverse with a Norton SG/Ceramic tool generally provides an open wheel face that can maximize productivity of the ceramic abrasive.

MULTI-POINT TOOLS FOR TRUING/DRESSING CERAMIC ABRASIVES (CONTINUED)

Tool Shape and Shank Availability

SG2A

For use on 15" to 20" diameter cylindrical, surface or centerless grinding wheels.

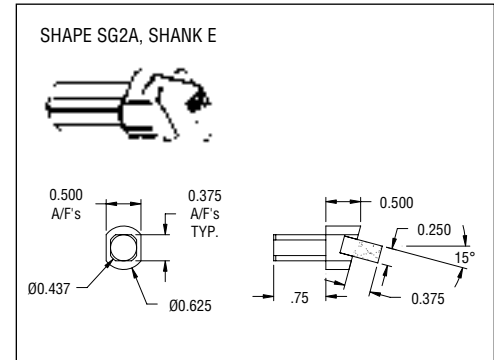
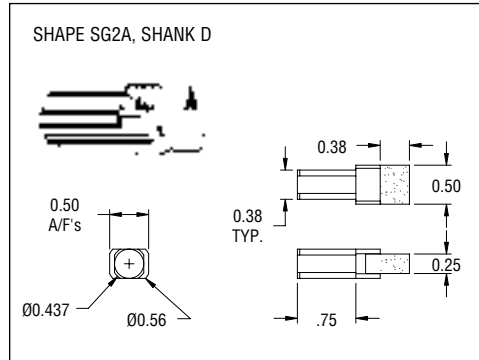
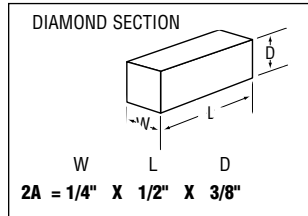

SG1A

For use on cylindrical, centerless, and surface grinding wheels over 20" in diameter

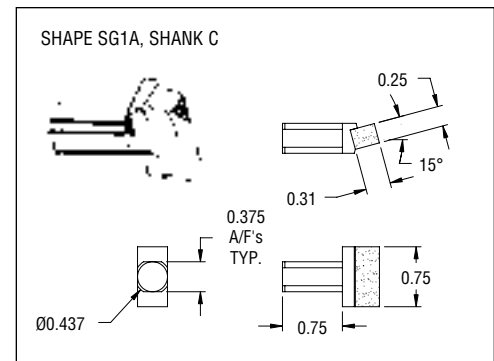
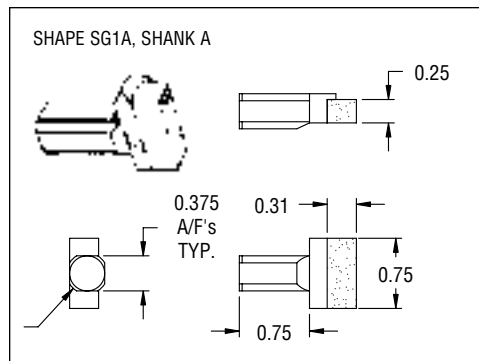
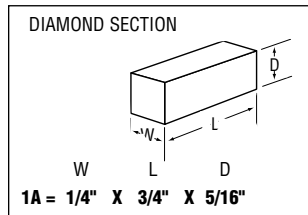

BEST

SG/CERAMIC MULTI-POINT TOOLS

- Designed specifically for use on ceramic (SG, Norton Quantum NQ, Targa TG. etc.) abrasives, SG tools contain a higher diamond concentration to withstand the increased grinding pressures generated by the ceramic abrasives. These tools have improved life and dress quality; they can also offer significant benefits in many applications using conventional abrasives.

WHEEL DIAMETER	WHEEL GRIT SIZE	TOOL APPROACH ANGLE	TOOL DIAMETER	BEST	
				CERAMIC ABRASIVES PRODUCT #	UPC #
STOCK MULTI-POINT TOOLS FOR TRUING/DRESSING CERAMIC ABRASIVES					
Up to 10"	54 to 100	0°	7/16"	SG1R6J7	66260195377
11" to 14"	54 to 100	0°	7/16"	SG2R6K7	66260195378
15" to 20"	54 to 100	0°	7/16"	SG2A6D7	66260195375
		15°	7/16"	SG2A6E7	66260195376
21" +	54 to 100	0°	7/16"	SG1A6A7	66260195373
		15°	7/16"	SG1A6C7	66260195374

STANDARD PACKAGE = ONE TOOL

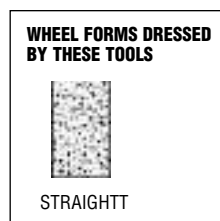

CONTACT YOUR NORTON REPRESENTATIVE FOR ALL YOUR NON-STOCK, CUSTOM CONFIGURATION QUESTIONS, REQUESTS FOR QUOTES, ETC.

MULTI-POINT TOOLS FOR TRUING AND STRAIGHT DRESSING CONVENTIONAL ABRASIVES

Tool Shape and Shank Availability

1R

For general purpose dressing of toolroom, cylindrical, and surface grinding wheels up to 10" in diameter.

Diamond Size Availability: 6, 8

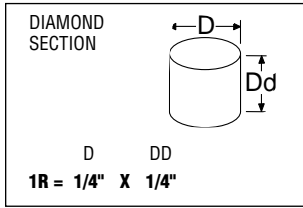

2R

For use on cylindrical, centerless and surface grinding wheels 11" to 14" in diameter.

Diamond Size Availability: 4, 6, 8

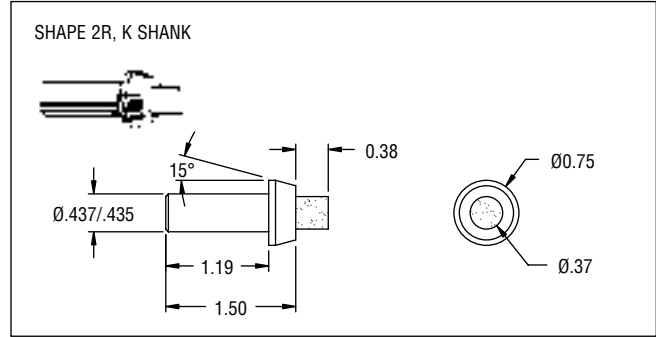
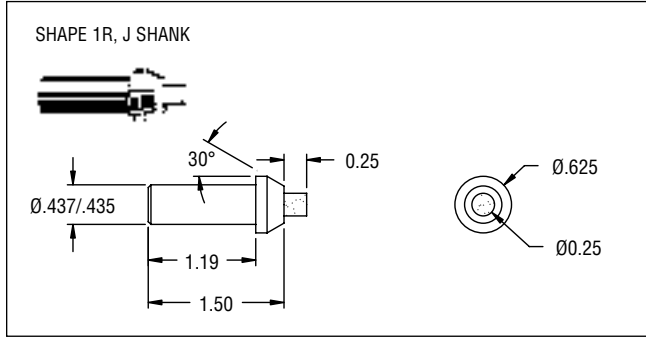
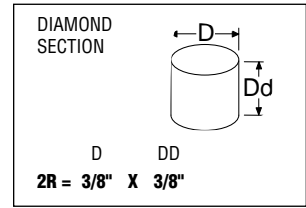

2A

For use on 15" to 20" cylindrical, surface, and centerless wheels.

Diamond Size Availability: 4, 6, 8

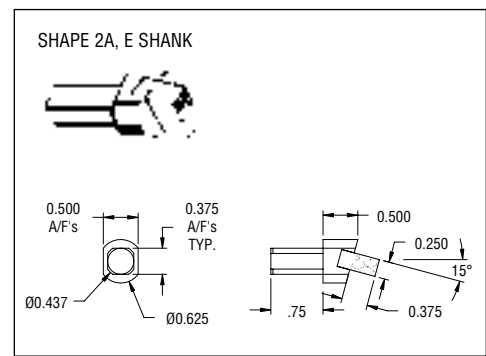
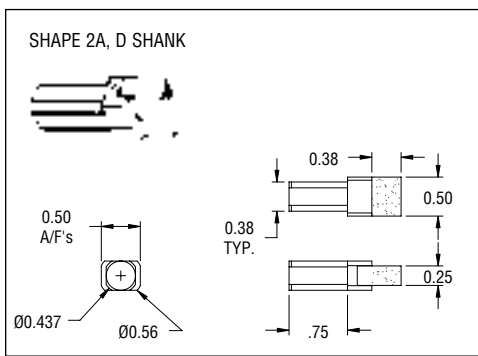
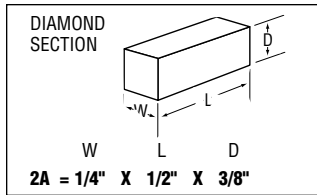

1A

For use on cylindrical and surface grinding wheels over 20" in diameter.

Diamond Size Availability: 4, 6, 8

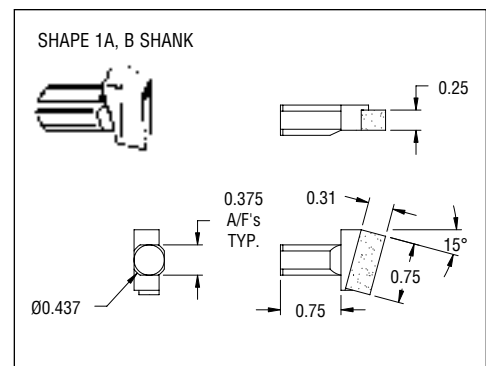
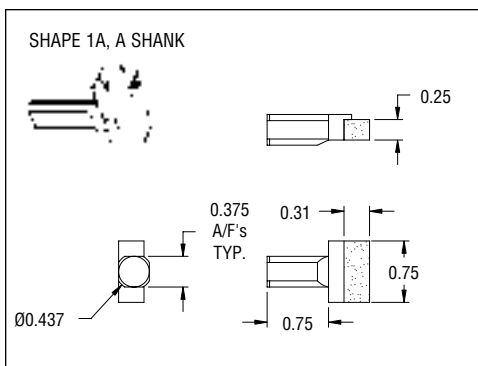
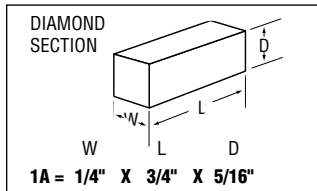

DIAMOND SIZE KEY

DIAMOND SIZE	TO DRESS WHEEL WITH GRIT SIZE OF:
4	46
6	54 - 100
8	120 - 150

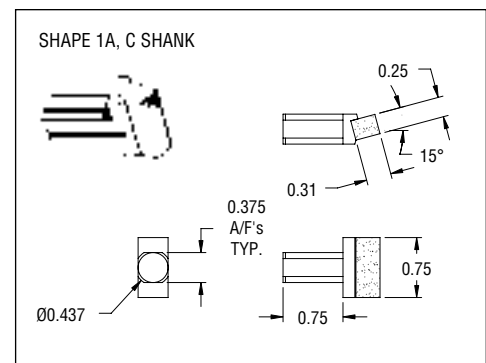

MULTI-POINT TOOLS FOR TRUING AND STRAIGHT DRESSING CONVENTIONAL ABRASIVES (CONT'D)

BETTER STANDARD MULTI-POINT TOOLS

■ The best selection for use on conventional abrasives in high-production applications

WHEEL DIAMETER	WHEEL GRIT SIZE	TOOL APPROACH ANGLE	TOOL DIAMETER	BETTER		
				PRODUCT #	UPC #	
STOCK MULTI-POINT TOOLS FOR STRAIGHT DRESSING CONVENTIONAL ABRASIVES						
Up to 10"	54 to 100	0°	7/16"	1R6J7	66260195088	
		0°	3/8"	1R6J6	66260195085	
11" to 14"	46	0°	7/16"	2R4K7	66260195095	
	54 to 100	0°	7/16"	2R6K7	66260195096	
		0°	7/16"	2R8K7	66260195097	
15" to 20"	46	0°	7/16"	2A4D7	66260195045	
		15°	7/16"	2A4E7	66260195048	
		15°	7/16"	IB4D7	66260195060	
	54 to 100	0°	7/16"	2A6D7	66260195046	
		15°	7/16"	2A6E7	66260195049	
		0°	7/16"	2A8D7	66260195047	
	120 to 150	15°	7/16"	2A8E7	66260195050	
		46	0°	7/16"	1A4A7	66260195030
			15°	7/16"	1A4C7	66260195038
			0°	7/16"	1A6A7	66260195031
54 to 100	15°	7/16"	1A6B7	66260195035		
	15°	7/16"	1A6C7	66260195039		
	NON-STOCK MULTI-POINT TOOLS FOR STRAIGHT DRESSING CONVENTIONAL ABRASIVES					
	Up to 10"	120 to 150	0°	7/16"	1R8J7	66260195089
0°			3/8"	1R8J6	66260195086	
21" +	46	15°	7/16"	1A4B7	66260195034	
		0°	7/16"	1A8A7	66260195032	
	120 to 150	15°	7/16"	1A8B7	66260195036	
		15°	7/16"	1A8C7	66260195040	



STANDARD PACKAGE = ONE TOOL

SPECIALTY MULTI-POINT TOOLS FOR FORM, SHAPE, OR STEP TRUING CONVENTIONAL ABRASIVES

Tool Shape and Shank Availability

3A

For use on all types of grinders where form, shape or step truing is required.

Diamond Size Availability: 6, 8

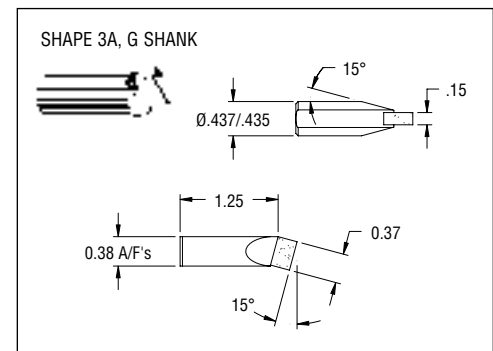
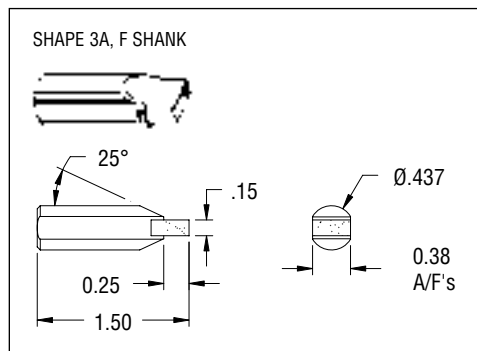
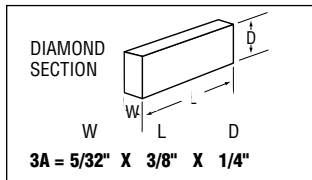

WHEEL DIAMETER	WHEEL GRIT SIZE	TOOL APPROACH ANGLE	TOOL DIAMETER	BETTER	
				PRODUCT #	UPC #
STOCK SPECIALTY MULTI-POINT TOOLS FOR CONVENTIONAL ABRASIVES					
All	54 to 100	0°	7/16"	3A6F7	66260195055
		15°	7/16"	3A6G7	66260195975
	120 to 150	15°	7/16"	3A8G7	66260195058
NON-STOCK SPECIALTY MULTI-POINT TOOLS FOR CONVENTIONAL ABRASIVES					
All	120 to 150	0°	7/16"	3A8F7	66260195056

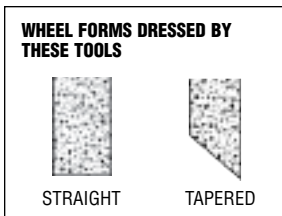

STANDARD PACKAGE = ONE TOOL

MULTI-POINT TOOLS FOR ANGULAR DRESSING CONVENTIONAL ABRASIVES

Tool Shape and Shank Availability

1E

For use on angular grinding machines with wheels up to 24" in diameter.

Diamond Size Availability: 6

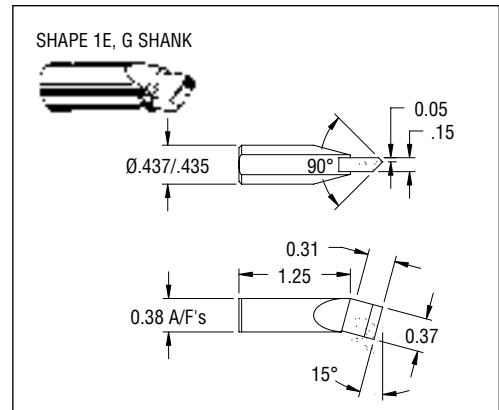
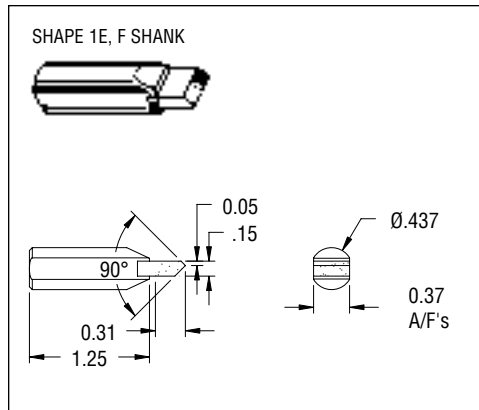
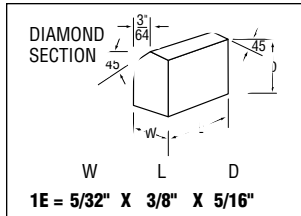

2E

For use on angular grinding machines, with wheels up to 30" in diameter.

Diamond Size Availability: 6

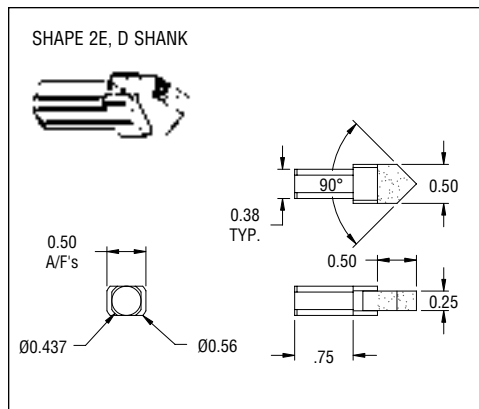
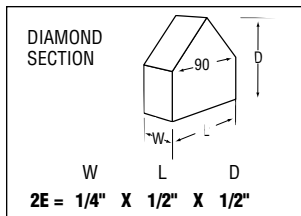

WHEEL DIAMETER	WHEEL GRIT SIZE	TOOL APPROACH ANGLE	TOOL DIAMETER	BETTER	
				PRODUCT #	UPC #
STOCK MULTI-POINT TOOLS FOR ANGULAR DRESSING CONVENTIONAL ABRASIVES					
All	54 to 100	0°	7/16"	1E6F7	66260195080
NON-STOCK MULTI-POINT TOOLS FOR ANGULAR DRESSING CONVENTIONAL ABRASIVES					
All	54 to 100	15°	7/16"	1E6G7	66260195081
		0°	7/16"	2E6D7	66260195083

STANDARD PACKAGE = ONE TOOL

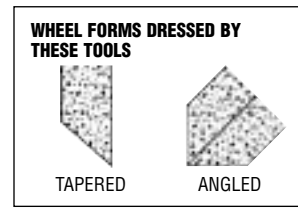

DIAMOND SIZE KEY	
DIAMOND SIZE	TO DRESS WHEEL WITH GRIT SIZE OF:
4	46
6	54 - 100
8	120 - 150

CONTACT YOUR NORTON REPRESENTATIVE FOR ALL YOUR NON-STOCK, CUSTOM CONFIGURATION QUESTIONS, REQUESTS FOR QUOTES, ETC.

MULTI-POINT TOOLS FOR TRUING/DRESSING TOOLROOM ABRASIVES

Tool Shape and Shank Availability

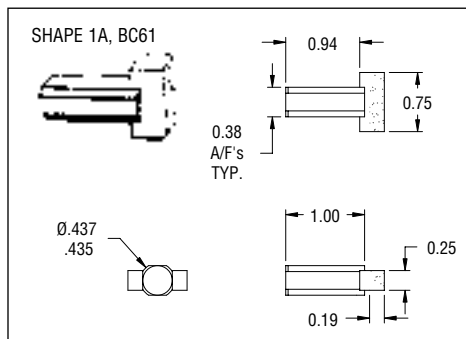
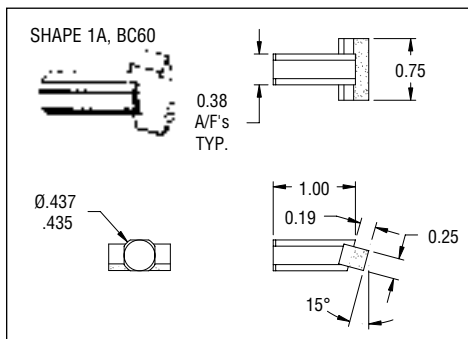
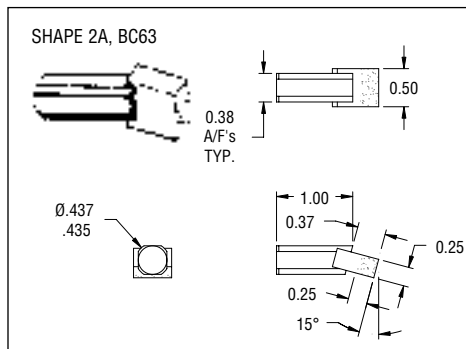
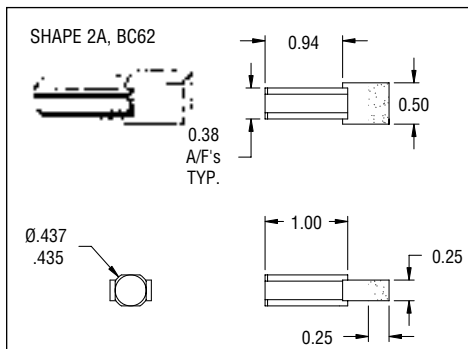
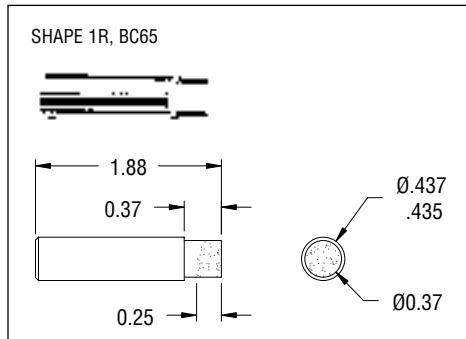
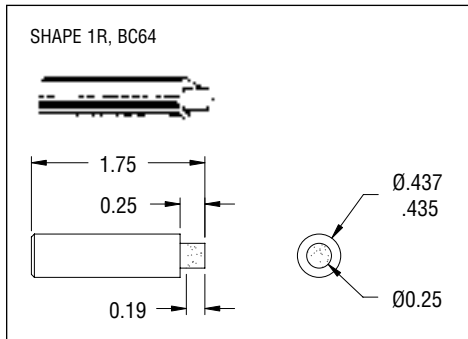

BC

All "BC" Multi-Point tools contain a specially selected diamond size for a broad range of dressing applications.

REFER TO PREVIOUS PAGES FOR EACH TOOL SHAPES APPLICATION DETAILS.

WHEEL FORMS DRESSED BY THESE TOOLS



STRAIGHT

GOOD BC MULTI-POINT TOOLS

- These general purpose tools are the ideal selection for conventional toolroom applications

WHEEL DIAMETER	WHEEL GRIT SIZE	TOOL APPROACH ANGLE	TOOL DIAMETER	GOOD	
				PRODUCT #	UPC #
STOCK MULTI-POINT TOOLS FOR TRUING CONVENTIONAL TOOLROOM ABRASIVES					
Up to 10"	54 to 100	0°	7/16"	BC64	66260195014
11" to 14"	54 to 100	0°	7/16"	BC65	66260195015
15" to 20"	54 to 100	0°	7/16"	BC62	66260195012
		15°	7/16"	BC63	66260195013
21" +	54 to 100	0°	7/16"	BC61	66260195011
		15°	7/16"	BC60	66260195010

STANDARD PACKAGE = ONE TOOL

CONTACT YOUR NORTON REPRESENTATIVE FOR ALL YOUR NON-STOCK, CUSTOM CONFIGURATION QUESTIONS, REQUESTS FOR QUOTES, ETC.

MACHINE TYPE	WHEEL DIAMETER	DIAMOND SECTION SIZE	SHANK DIAMETER	SHANK LENGTH UNDER HEAD	GOOD	
					PRODUCT #	UPC #
MULTI-POINT TOOLS FOR TRUING cBN TOOLROOM ABRASIVES						
Cylindrical	Up to 12"	1/4 x 3/4 x 5/16 @ 15° Angle	7/16	3/4	1A14C7	66260195041*
			7/16	1-13/16	2R14K7	66260195098*
Surface	6" and less	1/4 dia x 3/8 long	7/16	1-13/16	1R14J7	66260195090*
			7/16	1-13/16	2R14K7	66260195098*
Toolroom	Up to 12"	3/8 dia x 3/8 long	7/16	1-13/16	2R14K7	66260195098*

NOTE: FOR WHEEL DIAMETERS >12", CONTACT YOUR LOCAL NORTON REPRESENTATIVE FOR A RECOMMENDATION.

* NON-STOCK; CONTACT YOUR NORTON REPRESENTATIVE FOR CURRENT LEAD-TIME.



HIGH PERFORMANCE GRIT TOOLS

Norton High Performance Grit Tools are used in the same manner as multi-point tools, but are designed to produce a superior finish. They are used on 120 - 150 grit wheels. The traverse rates are equal to or faster than ordinary tools. Mounted on standard shanks, standard High Performance Grit Tools have a 3/8" wide by .100" thick diamond impregnated blade with a greater number of sharp points than in ordinary multi-point tools. Since High Performance Grit Tools contain a higher concentration of diamond than found in standard multi-point tools, they are well suited for ceramic abrasive applications.

Typical Machines and Applications

- Large angle-head cylindrical machines, grinding shoulders, faces, and bearing diameters
- Cylindrical machines used for grinding main bearings and lobes on camshafts
- Centerless machines that plunge grind on multi-diameter shafts
- Centerless machines used for step grinding

Standard High Performance Grit Tool Shapes

HP4439
HP4439 is designed for cylindrical machines, grinding thrust walls, bearing diameters, and multi-diameter shafts with radii. Shank length is 1-1/4" with 15° angle.

HP4511
HP4511 is designed for angular machines that plunge grind on multi-diameter shafts, or plunge grind on dual-wheel form grinding jobs. Shank length is 1-1/4". Tool should be mounted perpendicular to the wheel face.

HP4595
HP4595 is designed for cylindrical machines used for grinding main bearing and lobes on camshafts. Shank length is 1-1/4". Tool should be mounted perpendicular to the wheel face.

HP4596
HP4596 is designed for centerless machines used for step grinding, and for machines which perform dual-wheel grinding on transmission shafts. Shank length is 1-1/4" with 15° drag angle.

WHEEL DIAMETER	WHEEL GRIT SIZE	SHANK DIAMETER	TOOL LENGTH	BEST	
				PRODUCT #	UPC #
STOCK HIGH PERFORMANCE GRIT TOOLS					
Up to 20"	120 to 150	7/16"	1-9/16"	HP4439	66260195270
Up to 20"	120 to 150	7/16"	1-9/16"	HP4511	66260195271
Up to 20"	120 to 150	7/16"	1-9/16"	HP4595	66260195272
Up to 20"	120 to 150	7/16"	1-9/16"	HP4596	66260195273

STANDARD PACKAGE = ONE TOOL

WHEEL FORMS DRESSED BY THESE TOOLS

STRAIGHT TAPERED

BLADE TOOLS

With the choice of natural and synthetic diamond in three performance/price tiers, Norton blade tools can meet all your angle, step, and radius dressing requirements for cylindrical, surface, and centerless grinding.

WHEEL FORMS DRESSED BY THESE TOOLS



STRAIGHT



TAPERED

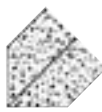

ANGLED



MULTI-ANGLED



BEST

SYNTHETIC BLADE TOOLS

FEATURES

- USB
- Norton Quantum (NQ)
- Synthetic diamond with a controlled diamond shape provides a constant cross section of diamond to the wheel throughout the life of the tool

BENEFITS

- For dressing aluminum oxide
- For dressing ceramics and silicon carbide
- Provides consistent wheel conditioning from the first dress to last
- Ideal for close tolerance wheel dressing on manual and CNC grinders, long production runs, and critical form and finish applications (e.g. automotive cam, crank, and valve grinding)
- Economical, long-lasting alternative to chisel-type tools for centerless form grinding

BETTER

MULTI-CUT BLADE TOOLS

FEATURES

- Manufactured with top quality elongated-shaped natural diamond

BENEFITS

- The best choice when natural diamond is preferred on surface, cylindrical, and centerless grinders
- Durable performing tools in a medium price range

GOOD

LONG LIFE BLADE TOOLS

FEATURES

- Manufactured with processed elongated shaped natural diamond

BENEFITS

- Developed as the first generation of the blade tool line for surface, cylindrical, and centerless grinders
- The choice when initial price is the primary purchasing consideration

TECHtip

MOUNTING BLADE TOOLS

- Blade Tools should be mounted with the centerline of the wheel. The tool is mounted so that all the diamonds are perpendicular to the wheel face. This illustrates the proper dressing position and angle for common centerless and cylindrical applications.
- Mounted with a 15° post holder, the shank of the tool is at a 15° angle with the wheel centerline.
- On straight applications, the tool is mounted perpendicular to the wheel face with no drag angle.

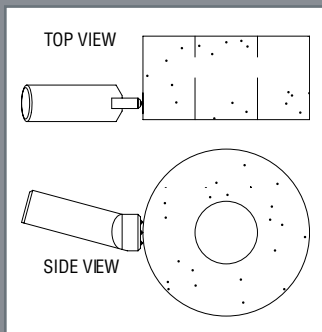

HOW TO USE BLADE TOOLS

- Mount the tool on a flat, so that the tool is square in the holder. Tools that are offset will cause the form to cut wide.
- Mount the tool so that all the diamonds are vertical to the wheel face.
- When using a layer tool, the tool may become dull between layers. Four or five heavy infeed passes at .002" to .004" will correct this situation.
- Blade Tools are not resettable and should not be rotated.
- Use a 3/8" stream of coolant at the point of contact ensuring that both sides of the diamond section are protected.
- Use appropriate truing lead.
- Whenever mounting a new grinding wheel, make certain that the truing system is fully retracted.



It is the user's responsibility to refer to and comply with ANSI B7.1

SPECcheck

USB BLADE TOOL MARKING SYSTEM

SYNTHETIC DIAMOND TYPE	NUMBER OF DIAMONDS	TOOL APPROACH ANGLE	DIAMOND SETTING POSITION	SHANK DIAMETER	MINIMUM RADIUS TO BE DRESSED
USC = CVD	2	0°	A = Angled	7 = 7/16"	.008"
	3	10°		6 = 3/8"	.0"
	5	15°		11 = 11mm	.05"

EXAMPLE: USC 3 10 A 7

USB Blade Tools

- Use a 3/8" diameter stream of coolant directed at point of contact with the wheel.
- Normal infeed should not exceed .001" for aluminum oxide wheels. Decrease by 25% when dressing ceramic SG and Norton Quantum NQ wheels and by 50% when dressing ceramic Targa TG wheels.
- To calculate traverse rate (the speed the tool moves across the wheel):
Wheel RPM x .015" = Traverse Rate inches/minute
A slower traverse rate equals lower surface finish readings.
- Mount tools with all diamonds contacting the wheel. Position row of diamonds vertically.

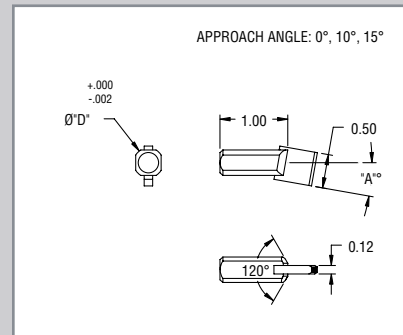

MULTI-CUT BLADE TOOL MARKING SYSTEM

TOOL TYPE	NUMBER OF DIAMONDS	APPROXIMATE DIAMETER OF DIAMONDS	MINIMUM AND CONCAVE RADIUS TO BE DRESSED
MC = 15° Drag Angle	2 = 1 layer of 2 diamonds	55 = .055"	.028"
MCS = 0° Drag Angle	3 = 1 layer of 3 diamonds	75 = .075"	.038"
		90 = .090"	.045"

EXAMPLE: MC 3 75

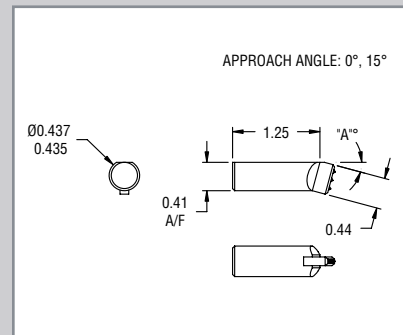

LONG LIFE BLADE TOOL MARKING SYSTEM

TOOL TYPE	STYLE	NUMBER OF LAYERS	APPROXIMATE DIAMETER OF DIAMONDS	MINIMUM RADIUS TO BE DRESSED
LL =	20 = 5 stones @ 15° Drag Angle	1 = 1 layer	A = .030"	.015"
Long Life	27 = 5 stones @ 0° Drag Angle	Non-stock:	B = .040"	.020"
		2 and 3 layers are available	C = .050"	.025"
		on request	D = .060"	.030"

EXAMPLE: LL 20 1 A

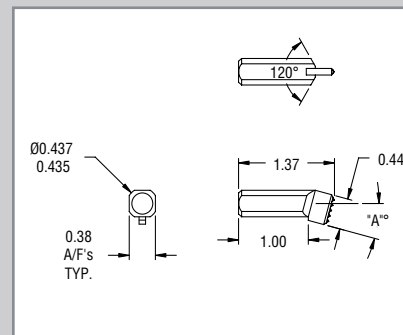

BLADE TOOLS

WHEEL DIAMETER (WIDTH ≤ 9")	TOOL APPROACH ANGLE	SHANK DIAMETER	BEST NQTOOLS		BEST USB TOOLS		BETTER MULTI-CUT TOOLS		GOOD LONG LIFE TOOLS	
			PRODUCT #	UPC #	PRODUCT #	UPC #	PRODUCT #	UPC #	PRODUCT #	UPC #
STOCK BLADE TOOLS										
12" to 17"	0°	7/16"	NQ20A7	07958747944						
	15°	7/16"	NQ215A7	07958747945			MC355	66260195266		
18" to 29"	0°	7/16"	NQ30A7	07958747946						
	15°	7/16"	NQ315A7	07958747947			MC375	66260195267		
30" to 36"	0°	7/16"	NQ50A7	07958747948						
	15°	7/16"	NQ515A7	07958747950						
NON-STOCK BLADE TOOLS										
Up to 11"	0°	7/16"					MCS255	66260148412	LL271A	66260196447
	15°	7/16"					MC255	66260195265	LL201A	66260196446
12" to 17"	0°	7/16"			USC20A7	66260103532	MCS355	66260195268	LL271B	66260196449
	10°	7/16"			USC210A7	66260103534				
	15°	7/16"			USC215A7	66260103535			LL201B	66260196448
18" to 29"	0°	7/16"			USC30A7	66260103305	MCS375	66260148417	LL271C	66260196451
	10°	7/16"			USC310A7	66260103545				
	15°	7/16"			USC315A7	66260103303			LL201C	66260196450
30" to 36"	0°	7/16"			USC50A7	66260103306	MCS390	66260148418	LL271D	66260196453
	10°	7/16"			USC510A7	66260103555				
	15°	7/16"			USC515A7	66260103307	MC390	66260196266	LL201D	66260196452

THESE TOOLS ARE NOT RESETTABLE OR RELAPPABLE.
OTHER SHANK DIAMETERS AND CONFIGURATIONS ARE AVAILABLE.
BLADE TOOLS FOR DRESSING WHEEL WIDTHS > 9" ARE ALSO AVAILABLE.
STANDARD PACKAGE = ONE TOOL

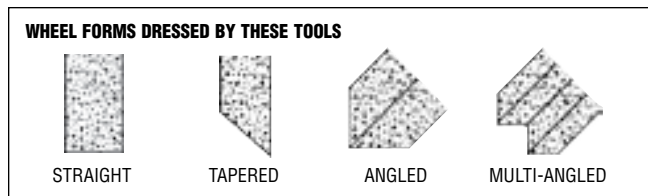

CONTACT YOUR NORTON REPRESENTATIVE FOR ALL YOUR NON-STOCK, CUSTOM CONFIGURATION QUESTIONS, REQUESTS FOR QUOTES, ETC.

FORM TOOLS

Norton Form Tools have diamond lapped to specific angles and radii required for a particular application, machine, contour dressing system or CNC operation. Due to the high degree of accuracy necessary, the diamond is of special shape and quality.

WHEEL FORMS DRESSED BY THESE TOOLS



CONVEX



CONCAVE

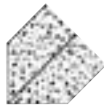

ANGLED



MULTI-ANGLED



TECHtip

HOW TO USE FORM DRESSING TOOLS

- Form Tools should be used in compliance with the guidelines established for the machine or dress.
- Proper centerline and light infeeds are essential to minimize side pressure. Excessive pressure will cause the diamond to fracture.
- Chisel Point Tools should be rotated 180° when dulling or contour problems occur.
- Cone point tools should be rotated approximately 1/4 turn daily.

BEST

CONE POINT TOOLS

- The Norton vacuum braze technology used in the manufacturing of cone points surpasses all traditional diamond retention methods.
- Benefits of this technology include absolute diamond retention, diamond pullout prevention during the dressing cycle, and longer tool life through multiple relaps.
- Because the diamond is accurately coned to the specific included angle and radius, these tools are ideal when the most intricate, precise forms and radii are required.
- Can be relapped.

U-DEX-IT CONE POINT TOOL

Used for precision dressing of intricate forms and radii. Specially designed with 5/8" indexable head for easy turning during use. These tools can be relapped.

					BEST	
INCLUDED ANGLE ON DIAMOND	RADIUS ON DIAMOND	TOOL CARAT WEIGHT	SHANK DIAM.	TOOL LENGTH	NPRODUCT #	RELAPPABLE UPC #
75°	.020"	.50	7/16"	1.678"	CPUD720-7	66260158981

STOCK U-DEX-IT CONE POINT TOOL

STANDARD PACKAGE = ONE TOOL

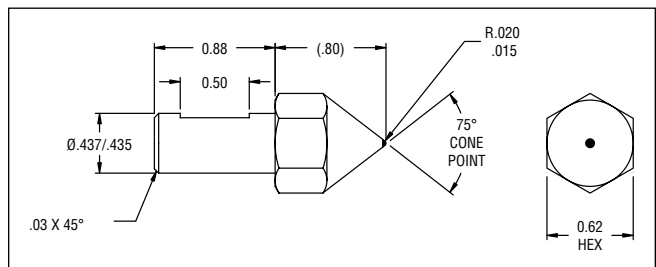

WHEEL FORMS DRESSED BY THESE TOOLS



CONVEX



CONCAVE



ANGLED



MULTI-ANGLED

SPE *check*

CONE POINT TOOL MARKING SYSTEM

TOOL TYPE	INCLUDED ANGLE ON DIAMOND	RADIUS ON DIAMOND	CARAT WEIGHT	SHANK DIAMETER
CP	6 = 60°	05 = .005"	L = .10 - .15	6 = 3/8"
	7 = 75°	10 = .010"	M = .20 - .25	7 = 7/16"
	9 = 90°	15 = .015"	H = .33	
		20 = .020"	X = .50	
		25 = .025"		
		30 = .030"		

EXAMPLE: CP 6 10 M-6

STANDARD CONE POINT TOOLS

These tools are used for precision dressing when the most intricate forms and radii are required. Can be relapped.

INCLUDED ANGLE ON DIAMOND	RADIUS ON DIAMOND	TOOL CARAT WEIGHT	SHANK DIAMETER	TOOL LENGTH	BEST	
					PRODUCT #	RELAPPABLE UPC #
STOCK STANDARD CONE POINT TOOLS						
60°	.010"	.20 - .25	3/8"	2"	CP610M-6	66260195240

STANDARD PACKAGE = ONE TOOL

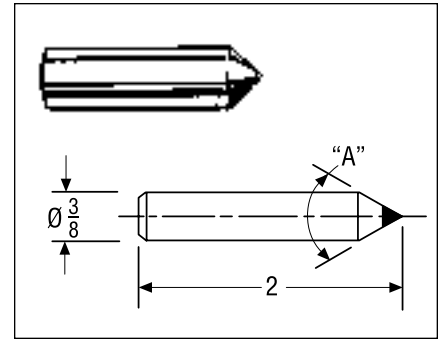

NON-STOCK STANDARD CONE POINT TOOLS

WHEEL DIAMETER	INCLUDED ANGLE ON DIAMOND	RADIUS ON DIAMOND	TOOL CARAT WEIGHT	SHANK DIAMETER	TOOL LENGTH	BEST	
						PRODUCT #	RELAPPABLE UPC #
NON-STOCK STANDARD CONE POINT TOOLS							
Up to 10"	60°	.005"	.10 - .15	3/8"	2"	CP65L-6	66260196098
11" - 14"			.20 - .25			CP65M-6	66260196100
15" - 20"			0.33			CP65H-6	66260196103
21" - 24"			0.50			CP65X-6	66260196109
Up to 10"	60°	.010"	.10 - .15	3/8"	2"	CP610L-6	66260196099
11" - 14"			.20 - .25			CP610M-6	66260195240*
15" - 20"			0.33			CP610H-6	66260196104
21" - 24"			0.50			CP610X-6	66260196110
Up to 10"	60°	.015"	.10 - .15	3/8"	2"	CP615L-6	66260195176
11" - 14"			.20 - .25			CP615M-6	66260196101
15" - 20"			0.33			CP615H-6	66260196105
21" - 24"			0.50			CP615X-6	66260196111
Up to 10"	60°	.020"	.10 - .15	3/8"	2"	CP620L-6	
11" - 14"			.20 - .25			CP620M-6	66260196102
15" - 20"			0.33			CP620H-6	66260196106
21" - 24"			0.50			CP620X-6	66260196112
Up to 10"	60°	.025"	.10 - .15	3/8"	2"	CP625L-6	
11" - 14"			.20 - .25			CP625M-6	66260151328
15" - 20"			0.33			CP625H-6	66260196107
21" - 24"			0.50			CP625X-6	66260196113
Up to 10"	60°	.030"	.10 - .15	3/8"	2"	CP630L-6	
11" - 14"			.20 - .25			CP630M-6	66260151357
15" - 20"			0.33			CP630H-6	66260196108
21" - 24"			0.50			CP630X-6	66260196114

*STOCK

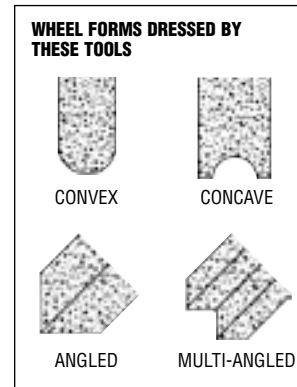

TECHtip

HOW TO ORDER NON-STOCK CONE POINT TOOLS

- Order by tool type, included angle, radius, and carat weight required.
- Unless otherwise specified, tools will be furnished in 3/8" x 2" shank as illustrated. Prices for radii not listed and/or other included angles will be quoted upon request.
- 7/16" diameter shank is available at no additional cost.

SPECcheck

CONE POINT TOOL MARKING SYSTEM

TOOL TYPE	INCLUDED ANGLE ON DIAMOND	RADIUS ON DIAMOND	CARAT WEIGHT	SHANK DIAMETER
CP	6 = 60°	05 = .005"	L = .10 - .15	6 = 3/8"
	7 = 75°	10 = .010"	M = .20 - .25	7 = 7/16"
	9 = 90°	15 = .015"	H = .33	
		20 = .020"	X = .50	
		25 = .025"		
		30 = .030"		

EXAMPLE: CP 6 10 M-6

CONTACT YOUR NORTON REPRESENTATIVE FOR ALL YOUR NON-STOCK, CUSTOM CONFIGURATION QUESTIONS, REQUESTS FOR QUOTES, ETC.

NON-STOCK STANDARD CONE POINT TOOLS (CONTINUED)

WHEEL DIAMETER	INCLUDED ANGLE ON DIAMOND	RADIUS ON DIAMOND	TOOL CARAT WEIGHT	SHANK DIAMETER	TOOL LENGTH	BEST	
						PRODUCT #	RELAPPABLE UPC #
NON-STOCK STANDARD CONE POINT TOOLS (CONTINUED)							
Up to 10"	75°	.005"	.10 - .15	3/8"	2"	CP75L-6	66260196115
11" - 14"			.20 - .25			CP75M-6	66260196117
15" - 20"			0.33			CP75H-6	66260196120
21" - 24"			0.50			CP75X-6	66260196126
Up to 10"	75°	.010"	.10 - .15	3/8"	2"	CP710L-6	66260196116
11" - 14"			.20 - .25			CP710M-6	66260195241
15" - 20"			0.33			CP710H-6	66260196121
21" - 24"			0.50			CP710X-6	66260196127
Up to 10"	75°	.015"	.10 - .15	3/8"	2"	CP715L-6	66260196118
11" - 14"			.20 - .25			CP715M-6	66260196118
15" - 20"			0.33			CP715H-6	66260196122
21" - 24"			0.50			CP715X-6	66260196128
Up to 10"	75°	.020"	.10 - .15	3/8"	2"	CP720L-6	66260196119
11" - 14"			.20 - .25			CP720M-6	66260196119
15" - 20"			0.33			CP720H-6	66260196123
21" - 24"			0.50			CP720X-6	66260196129
Up to 10"	75°	.025"	.10 - .15	3/8"	2"	CP725L-6	66260151448
11" - 14"			.20 - .25			CP725M-6	66260151448
15" - 20"			0.33			CP725H-6	66260196124
21" - 24"			0.50			CP725X-6	66260196130
Up to 10"	75°	.030"	.10 - .15	3/8"	2"	CP730L-6	66260196125
11" - 14"			.20 - .25			CP730M-6	66260196131
15" - 20"			0.33			CP730H-6	66260196125
21" - 24"			0.50			CP730X-6	66260196131
Up to 10"	90°	.005"	.10 - .15	3/8"	2"	CP95L-6	66260196132
11" - 14"			.20 - .25			CP95M-6	66260196134
15" - 20"			0.33			CP95H-6	66260196137
21" - 24"			0.50			CP95X-6	66260196143
Up to 10"	90°	.010"	.10 - .15	3/8"	2"	CP910L-6	66260196133
11" - 14"			.20 - .25			CP910M-6	66260195242
15" - 20"			0.33			CP910H-6	66260196138
21" - 24"			0.50			CP910X-6	66260196144
Up to 10"	90°	.015"	.10 - .15	3/8"	2"	CP915L-6	66260158012
11" - 14"			.20 - .25			CP915M-6	66260196135
15" - 20"			0.33			CP915H-6	66260196139
21" - 24"			0.50			CP915X-6	66260196145
Up to 10"	90°	.020"	.10 - .15	3/8"	2"	CP920L-6	66260196136
11" - 14"			.20 - .25			CP920M-6	66260196136
15" - 20"			0.33			CP920H-6	66260196140
21" - 24"			0.50			CP920X-6	66260196146
Up to 10"	90°	.025"	.10 - .15	3/8"	2"	CP925L-6	66260151645
11" - 14"			.20 - .25			CP925M-6	66260151645
15" - 20"			0.33			CP925H-6	66260196141
21" - 24"			0.50			CP925X-6	66260196147
Up to 10"	90°	.030"	.10 - .15	3/8"	2"	CP930L-6	66260151673
11" - 14"			.20 - .25			CP930M-6	66260151673
15" - 20"			0.33			CP930H-6	66260196142
21" - 24"			0.50			CP930X-6	66260196148

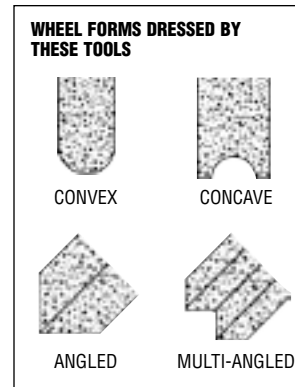

CONTACT YOUR NORTON REPRESENTATIVE FOR ALL YOUR NON-STOCK, CUSTOM CONFIGURATION QUESTIONS, REQUESTS FOR QUOTES, ETC.

CHISEL POINT TOOL FOR TOYODA GRINDERS

High precision chisel point tool designed for forming intricate shapes and radii. Specifically engineered to fit Toyoda machine series GL32 and GL4, it can also be used on various straight and angle-head grinders – for dressing conventional and ceramic abrasive wheels, sizes 12" to 24". This tool can be reset/relapped.

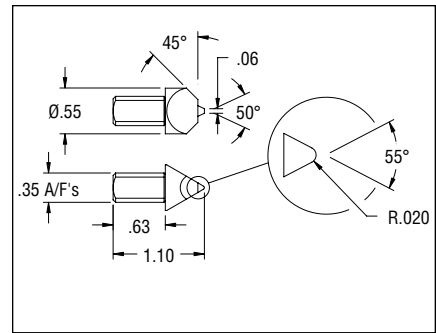

INCLUDED ANGLE ON DIAMOND	RADIUS ON DIAMOND	TOOL CARAT WEIGHT	SHANK DIAMETER	TOOL LENGTH	BEST	
					PRODUCT #	RELAPPABLE UPC #
STOCK CHISEL POINT TOOL						
55°	.020"	.75	7/16"	1.10"	CHT520-7	66260103741
STANDARD PACKAGE = ONE TOOL						

TECHtip

Chisel Point Tools should be rotated 180° when dulling or contour problems occur.

NON-STOCK STANDARD CHISEL POINT TOOLS

This line offers precision tools designed to form intricate radii, steps or contours on toolroom-type applications. Can be relapped or reset/relapped.

WHEEL DIAMETER	INCLUDED ANGLE ON DIAMOND	RADIUS ON DIAMOND	TOOL CARAT WEIGHT	SHANK DIAMETER	TOOL LENGTH	BEST	
						PRODUCT #	RELAPPABLE UPC #
NON-STOCK STANDARD CHISEL POINT TOOLS							
Up to 10"	60°	.005"	.10 - .15	3/8"	2"	CH65L-6	66260196150
11" - 14"			.20 - .25			CH65M-6	66260196154
15" - 20"			0.33			CH65H-6	66260196160
21" - 24"			0.50			CH65X-6	66260196166
Up to 10"	60°	.010"	.10 - .15	3/8"	2"	CH610L-6	66260196151
11" - 14"			.20 - .25			CH610M-6	66260196155
15" - 20"			0.33			CH610H-6	66260195245
21" - 24"			0.50			CH610X-6	66260196167
Up to 10"	60°	.015"	.10 - .15	3/8"	2"	CH615L-6	66260196152
11" - 14"			.20 - .25			CH615M-6	66260196156
15" - 20"			0.33			CH615H-6	66260196161
21" - 24"			0.50			CH615X-6	66260196168
Up to 10"	60°	.020"	.10 - .15	3/8"	2"	CH620L-6	66260196157
11" - 14"			.20 - .25			CH620M-6	66260196157
15" - 20"			0.33			CH620H-6	66260196162
21" - 24"			0.50			CH620X-6	66260196169
Up to 10"	60°	.025"	.10 - .15	3/8"	2"	CH625L-6	66260196158
11" - 14"			.20 - .25			CH625M-6	66260196158
15" - 20"			0.33			CH625H-6	66260196163
21" - 24"			0.50			CH625X-6	66260196170
Up to 10"	60°	.030"	.10 - .15	3/8"	2"	CH630L-6	66260158176
11" - 14"			.20 - .25			CH630M-6	66260196164
15" - 20"			0.33			CH630H-6	66260196164
21" - 24"			0.50			CH630X-6	66260196492
Up to 10"	75°	.005"	.10 - .15	3/8"	2"	CH75L-6	66260196172
11" - 14"			.20 - .25			CH75M-6	66260196176
15" - 20"			0.33			CH75H-6	66260196182
21" - 24"			0.50			CH75X-6	66260196189
Up to 10"	75°	.010"	.10 - .15	3/8"	2"	CH710L-6	66260196173
11" - 14"			.20 - .25			CH710M-6	66260196177
15" - 20"			0.33			CH710H-6	66260196183
21" - 24"			0.50			CH710X-6	66260196190

CONTINUED

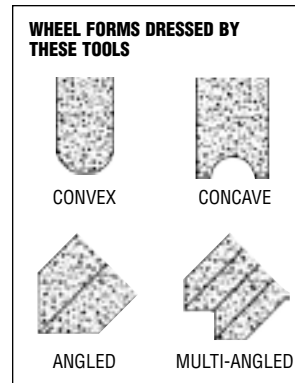
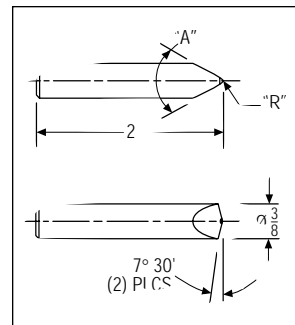

CONTACT YOUR NORTON REPRESENTATIVE FOR ALL YOUR NON-STOCK, CUSTOM CONFIGURATION QUESTIONS, REQUESTS FOR QUOTES, ETC.

NON-STOCK STANDARD CHISEL POINT TOOLS (CONTINUED)

WHEEL DIAMETER	INCLUDED ANGLE ON DIAMOND	RADIUS ON DIAMOND	TOOL CARAT WEIGHT	SHANK DIAMETER	TOOL LENGTH	BEST	
						PRODUCT #	RELAPPABLE UPC #
NON-STOCK STANDARD CHISEL POINT TOOLS							
Up to 10"	75°	.015"	.10 - .15	3/8"	2"	CH715L-6	66260196174
11" - 14"			.20 - .25			CH715M-6	66260196178
15" - 20"			0.33			CH715H-6	66260196184
21" - 24"			0.50			CH715X-6	66260196191
Up to 10"	75°	.020"	.10 - .15	3/8"	2"	CH720L-6	
11" - 14"			.20 - .25			CH720M-6	66260196179
15" - 20"			0.33			CH720H-6	66260196185
21" - 24"			0.50			CH720X-6	66260196192
Up to 10"	75°	.025"	.10 - .15	3/8"	2"	CH725L-6	
11" - 14"			.20 - .25			CH725M-6	66260196180
15" - 20"			0.33			CH725H-6	66260196186
21" - 24"			0.50			CH725X-6	66260196193
Up to 10"	75°	.030"	.10 - .15	3/8"	2"	CH730L-6	
11" - 14"			.20 - .25			CH730M-6	
15" - 20"			0.33			CH730H-6	66260196187
21" - 24"			0.50			CH730X-6	66260196194
Up to 10"	90°	.005"	.10 - .15	3/8"	2"	CH95L-6	66260196196
11" - 14"			.20 - .25			CH95M-6	66260196202
15" - 20"			0.33			CH95H-6	66260196208
21" - 24"			0.50			CH95X-6	66260196215
Up to 10"	90°	.010"	.10 - .15	3/8"	2"	CH910L-6	66260196197
11" - 14"			.20 - .25			CH910M-6	66260196203
15" - 20"			0.33			CH910H-6	66260196209
21" - 24"			0.50			CH910X-6	66260196493
Up to 10"	90°	.015"	.10 - .15	3/8"	2"	CH915L-6	66260196198
11" - 14"			.20 - .25			CH915M-6	66260196204
15" - 20"			0.33			CH915H-6	66260196210
21" - 24"			0.50			CH915X-6	66260196216
Up to 10"	90°	.020"	.10 - .15	3/8"	2"	CH920L-6	
11" - 14"			.20 - .25			CH920M-6	66260196205
15" - 20"			0.33			CH920H-6	66260196211
21" - 24"			0.50			CH920X-6	66260196217
Up to 10"	90°	.025"	.10 - .15	3/8"	2"	CH925L-6	
11" - 14"			.20 - .25			CH925M-6	66260196206
15" - 20"			0.33			CH925H-6	66260196212
21" - 24"			0.50			CH925X-6	66260196218
Up to 10"	90°	.030"	.10 - .15	3/8"	2"	CH930L-6	
11" - 14"			.20 - .25			CH930M-6	66260163376
15" - 20"			0.33			CH930H-6	66260196213
21" - 24"			0.50			CH930X-6	66260196219

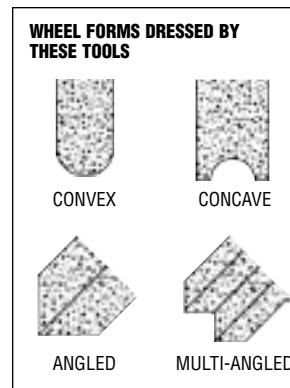

TECHtip

HOW TO ORDER NON-STOCK CHISEL POINT TOOLS

- Order by tool type, included angle, radius, and carat weight required.
- Tools will be furnished in 3/8" x 2" shank as illustrated. Prices for radii not listed and/or other included angles will be quoted upon request.
- 7/16" diameter shank is available at no additional cost.

SPECcheck

CONE POINT TOOL MARKING SYSTEM

TOOL TYPE	INCLUDED ANGLE ON DIAMOND	RADIUS ON DIAMOND	CARAT WEIGHT	SHANK DIAMETER	
CH = Natural Diamond	6 = 60°	05 = .005"	L = .10 - .15	6 = 3/8"	
	7 = 75°	10 = .010"	M = .20 - .25	7 = 7/16"	
	9 = 90°	15 = .015"	H = .33		
		20 = .020"	X = .50		
		25 = .025"			
		30 = .030"			

EXAMPLE: CH 9 5 M-6

STANDARD FORM TOOLS FOR JONES & LAMSON MACHINES

BEST FORM TOOLS – JONES & LAMSON MACHINES

- Used primarily on Jones & Lamson machines; 9/32" x 1-1/4" shank
- The applications dictates the tool to choose
- Can be relapped or reset/relapped

INCLUDED ANGLE ON DIAMOND	RADIUS ON DIAMOND	BEST	
		PRODUCT #	RELAPPABLE UPC #
NON-STOCK JONES & LAMSON FORM TOOLS			
50°	0.005"	JL105	66260158847
	0.010"	JL110	66260159824
	0.015"	JL115	66260141699
	0.020"	JL120	66260141700
40°	0.005"	JL205	66260142524
	0.010"	JL210	66260155893
	0.015"	JL215	
30°	0.005"	JL305	66260141701
	0.010"	JL310	66260142528
	0.015"	JL315	66260142529
	0.020"	JL320	66260158989

STANDARD PACKAGE = 1 TOOL

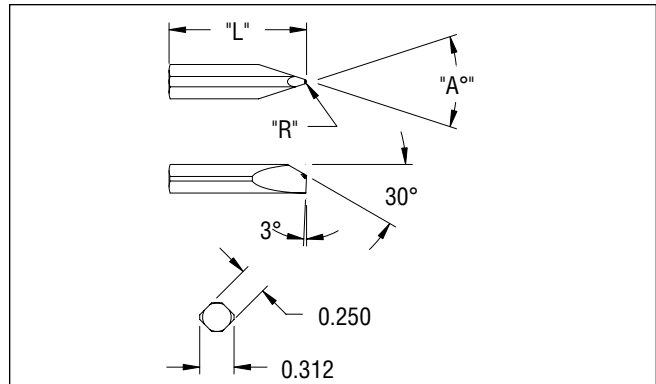

SPECcheck

JONES & LAMSON TOOL MARKING SYSTEM

TOOL TYPE	INCLUDED ANGLE ON DIAMOND	RADIUS ON DIAMOND
JL = Natural Diamond	1 = 50°	05 = .005"
	2 = 40°	10 = .010"
	3 = 30°	15 = .015"
		20 = .020"

EXAMPLE: JL 1 10

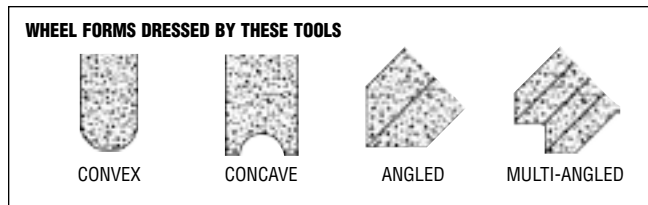

STANDARD FORM TOOLS FOR MOORE PANTOGRAPH MACHINES

BEST FORM TOOLS – MOORE PANTOGRAPH MACHINES

- Used primarily on Moore Pantograph machines; 1/4" x 1-9/16" shank
- The applications dictates the tool to choose
- Can be relapped or reset/relapped

INCLUDED ANGLE ON DIAMOND	RADIUS ON DIAMOND	BEST	
		PRODUCT #	RELAPPABLE UPC #
NON-STOCK MOORE PANTOGRAPH FORM TOOLS			
30°	0.005"	M053056	66260195280
	0.010"	M0103056	66260195281
	0.015"	M0153056	66260195282
	0.020"	M0203056	66260196282
	0.025"	M0253056	66260196283
60°	0.005"	M056056	66260196276
	0.010"	M0106056	66260196277
	0.015"	M0156056	66260196278
	0.020"	M0206056	66260196286
	0.025"	M0256056	66260196287

40° AND 90° INCLUDED ANGLES ARE ALSO AVAILABLE.

STANDARD PACKAGE = 1 TOOL

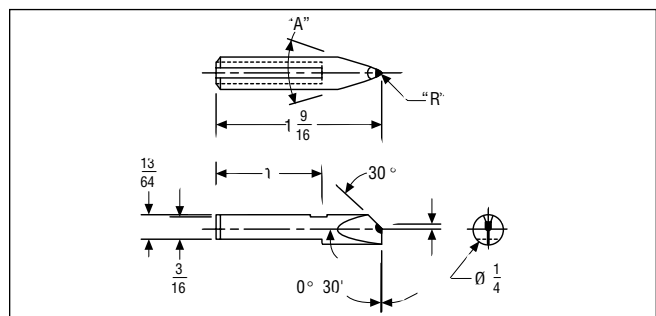

SPECcheck

MOORE PANTOGRAPH TOOL MARKING SYSTEM

TOOL TYPE	RADIUS ON DIAMONDS	INCLUDED ANGLE ON DIAMOND	SHANK DIAMETER
MO = Natural Diamond	05 = .005"	30 = 30°	56 = 1-9/16"
	10 = .010"	40 = 40°	
	15 = .015"	60 = 60°	
	20 = .020"	90 = 90°	
	25 = .025"		

EXAMPLE: MO 5 30 56

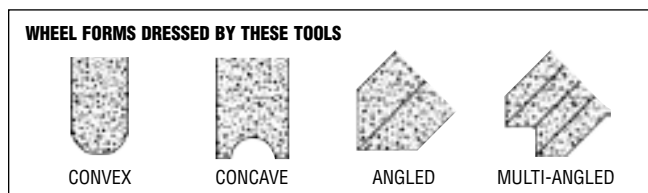

STANDARD FORM TOOLS FOR HOG Lund MACHINES

BEST

FORM TOOLS – HOG Lund MACHINES

- Used primarily on Hoglund machines
- The applications dictates the tool to choose

INCLUDED ANGLE ON DIAMOND	RADIUS ON DIAMOND	BEST	
		PRODUCT #	UPC #
NON-STOCK HOG Lund FORM TOOLS			
42°	0.005"	HG54262	66260142466
	0.010"	HG104262	66260142489
	0.015"	HG154262	66260142346
	0.020"	HG204262	66260142403
	0.025"	HG254262	66260142459
60°	0.005"	HG56062	66260142470
	0.010"	HG106062	66260142294
	0.015"	HG156062	66260142351
	0.020"	HG206062	66260142407
	0.025"	HG256062	66260142463

48° AND 72° INCLUDED ANGLES ARE ALSO AVAILABLE, AS ARE 1-1/2 AND 1-3/4" TOOL LENGTHS. STANDARD PACKAGE = 1 TOOL

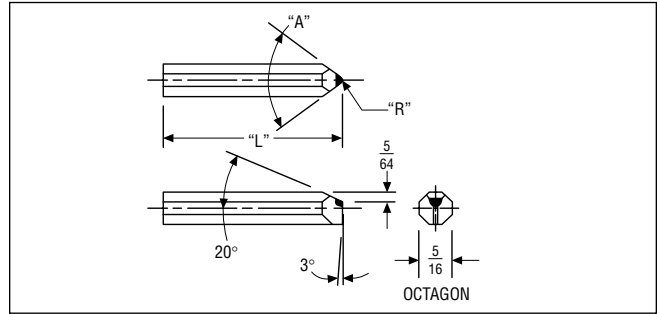

SPECcheck

HOG Lund TOOL MARKING SYSTEM

TOOL TYPE	RADIUS ON DIAMOND	INCLUDED ANGLE ON DIAMOND	TOOL LENGTH	
HG =	05 = .005"	42 = 42°	50 = 1-1/2"	
	Natural	10 = .010"	62 = 1-5/8"	
	Diamond	15 = .015"	60 = 60°	75 = 1-3/4"
		20 = .020"	72 = 72°	
		25 = .025"		

EXAMPLE: HG 10 42 62

WHEEL FORMS DRESSED BY THESE TOOLS

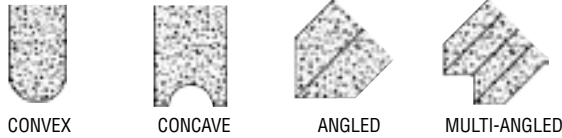

STANDARD FORM TOOLS FOR DIA-FORM MACHINES

BEST

FORM TOOLS – DIA-FORM MACHINES

- Used primarily on Dia-Form machines
- The applications dictates the tool to choose
- Can be relapped or reset/relapped

INCLUDED ANGLE ON DIAMOND	RADIUS ON DIAMOND	BEST	
		PRODUCT #	RELAPPABLE UPC #
NON-STOCK DIA-FORM TOOLS			
40°	0.005"	DI052138	66260196310
	0.010"	DI102138	66260196311
	0.015"	DI152138	66260196312
	0.020"	DI202138	66260196314
	0.025"	DI252138	66260196316
60°	0.005"	DI051138	66260195289
	0.010"	DI101138	66260195290
	0.015"	DI151138	66260195292
	0.020"	DI201138	66260196313
	0.025"	DI251138	66260196315

1-3/4" AND 2-1/4" TOOL LENGTHS ARE ALSO AVAILABLE. STANDARD PACKAGE = 1 TOOL

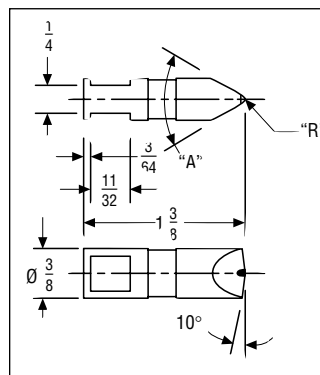

WHEEL FORMS DRESSED BY THESE TOOLS

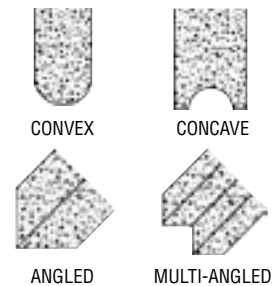

SPECcheck

DIA-FORM TOOL MARKING SYSTEM

TOOL TYPE	RADIUS ON DIAMOND	INCLUDED ANGLE ON DIAMOND	TOOL LENGTH	
DI =	05 = .005"	1 = 60°	138 = 1-3/8"	
	Natural	10 = .010"	175 = 1-3/4"	
	Diamond	15 = .015"	2 = 40°	225 = 2-1/4"
		20 = .020"		
		25 = .025"		

EXAMPLE: DI 05 1 138

CONTACT YOUR NORTON REPRESENTATIVE FOR ALL YOUR NON-STOCK, CUSTOM CONFIGURATION QUESTIONS, REQUESTS FOR QUOTES, ETC.

CLUSTER TOOLS

Norton Cluster Tools are designed specifically for straight face dressing of large diameter, coarse grit grinding wheels on single or double disc, centerless, or surface grinders.

WHEEL FORMS DRESSED BY THESE TOOLS



CONVEX



TAPERED



MULTI-POINT CLUSTER TOOLS

Multi-Point Cluster tools are typically used for straight face dressing on disc and centerless operations. For greatest efficiency, these tools should be mounted at a 15° angle so that three diamonds are in contact with the wheel face at all times. The tool should be rotated at frequent intervals. Not resettable.

BETTER				
DIAMONDS ON FACE	SHANK DIAMETER	TOOL LENGTH	PRODUCT #	NON-RESETTABLE UPC #
STOCK MULTI-POINT CLUSTER TOOLS				
7	7/16"	1-5/16"	NC7K7	66260195206

STANDARD PACKAGE = 1 TOOL

BEST				
DIAMONDS ON FACE	SHANK DIAMETER	TOOL LENGTH	PRODUCT #	NON-RESETTABLE UPC #
NON-STOCK MULTI-POINT CLUSTER TOOLS				
7	7/16"	1-5/16"	MP77	66260195205

STANDARD PACKAGE = 1 TOOL

DIA-PAK TOOLS

Dia-Pak tools are primarily used in straight face disc grinding, but are extremely versatile and may also be used in centerless and surface operations. Designed for maximum economy, three layers of diamond are carefully arranged so that a new layer is exposed before the previous layer is completely worn away. Not resettable.

BETTER					
FOR WHEEL DIAMETERS	DIAMONDS PER LAYER	SHANK DIAM.	TOOL LENGTH	PRODUCT #	NON-RESETTABLE UPC #
STOCK DIA-PAK TOOLS					
Up to 14"	5-4-5	7/16"	2"	DP20	66260195200
Up to 20"	7-6-7	7/16"	2"	DP30	66260195201
Any	7-6-7	7/16"	2"	DP35	66260195202

STANDARD PACKAGE = 1 TOOL

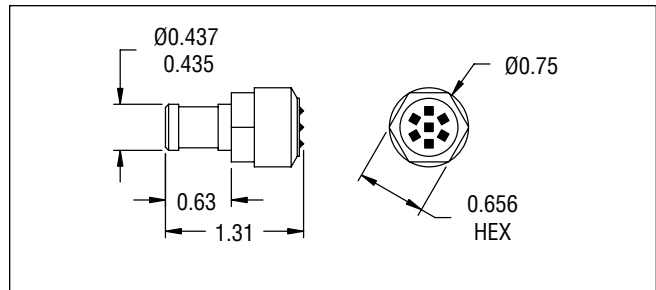

WHEEL FORMS DRESSED BY THESE TOOLS



STRAIGHT



TAPERED

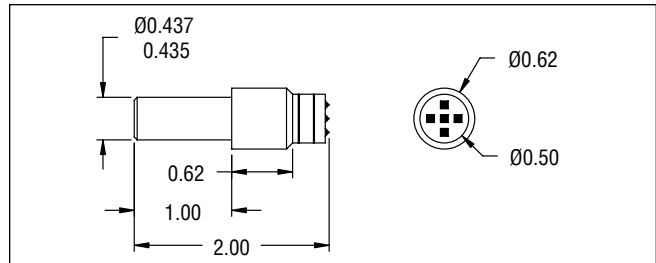

WHEEL FORMS DRESSED BY THESE TOOLS



STRAIGHT



TAPERED

TECHtip

CLUSTER AND DIA-PAK TOOLS – STRAIGHT FACE DRESSING OF HARD / COARSE WHEELS:

- Tool should approach the wheel at a 15° angle and be rotated periodically to keep three diamonds in contact with the wheel at all times.
- Tools can also be used at a 90° to the wheel face.
- Multi-Point Cluster Tools should be rotated at frequent intervals.
- Infeed per pass should not exceed .0015" (.001" with Norton SG/Ceramic, Norton Quantum and Targa TG wheels).
- Use coolant whenever possible.
- These tools permit a faster traverse rate providing a freer cutting wheel than when dressed by a conventional single-point tool.

ACCESSORIES

Tool holders typically used in toolroom applications.



TOOL HOLDER/HAND DRESSER

Designed for use when offhand truing and dressing on tool and cutter, or benchstand grinders. This stock hand dresser will not rust, and is 10-1/2" long, with a hollow shaft that accepts any tool shank length from 3/4" to 9". The 1-3/4" diameter plastic knob ensures a firm grip. The collet accepts a 7/16" diameter tool shank.

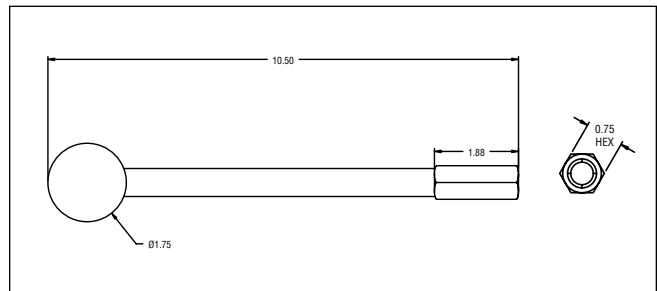

DESCRIPTION	UPC #
Hand Dresser	66260195020

MACHINE TOOL HOLDER

Designed to be mounted directly on the table of surface and tool grinders with a bolt or magnetic chuck, our stock machine dresser is positioned vertically with the tool positioned at a 15° drag angle.

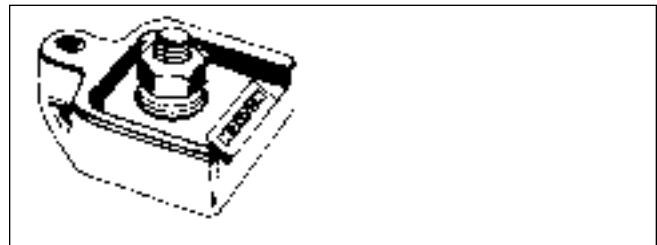

DESCRIPTION	UPC #
Machine Holder	66260195355

DIAMOND TOOL RECOMMENDATIONS BY MACHINE TYPE

MANUFACTURER AND MACHINE TYPE	TOOL DRAWING	ORDERING SPECIFICATION		MANUFACTURER AND MACHINE TYPE	TOOL DRAWING	ORDERING SPECIFICATION	
		SINGLE POINT TOOL	MULTI-POINT TOOL			SINGLE POINT TOOL	MULTI-POINT TOOL
AGATHON		CD8515		CHEVALIER		CD-2221-RR	
ALBERTSON & CO; SIOUX GRINDERS						CD-8346	
Valve Refacer 112 and 30013		CD402-1-5/8"	1R6 Special ME103738A	DANOBAT			ME162543
Valve Seat Grinder 1715-B and 30190		CD-1019	1R6 Special ME103743	ESTARTA		CD-2695-C	
Valve Seat Grinders		S-2621-C					
	Please specify overall Length "L" availability;			EXCELLO CORP.			
BROWN & SHARPE				Thread Grinder #31		NT-106 (48-4105)	3R806•
Plain Grinder #5		CD-1537R	2A6E7•	FORTUNA		CD-7512	
Surface Grinder		S-2639	1R6 Special ME103737	G&L WINSLOWMATIC		CD-1733-JJ	
BRYANT CHUCKING GRINDER COMPANY						CD-441K-9	
Internal Grinders #4, 4B, 5, 5A, & 5B		NI21R4•	N.A.	GLEASON WORKS		S416	
Internal Grinder #112		CD-225	N.A.	HEALD			
		CDP-10179		Internal Grinders		CD-260-8	N.A.
CEDAR RAPIDS "KWIKWAY"				Internal Thread		N121Q7•	N.A.
Valve Refacer		CD401-2-3/8"	N.A.	Internal Grinders #70, 72A, 73, 74, 78, 81 & 172		CD-193	1R6J7
Valve Seat Grinder		CD-1799	1R6 Special ME103740	Rotary Surface Grinders #22, 25A & 261			
Valve Seat Grinder		S-2622-A	1R6 Special ME103745A				



• INDICATES A STOCK ITEM.

DIAMOND TOOL RECOMMENDATIONS BY MACHINE TYPE

MANUFACTURER AND MACHINE TYPE	TOOL DRAWING	ORDERING SPECIFICATION		MANUFACTURER AND MACHINE TYPE	TOOL DRAWING	ORDERING SPECIFICATION	
		SINGLE POINT TOOL	MULTI-POINT TOOL			SINGLE POINT TOOL	MULTI-POINT TOOL
JONES & LAMSON				KOYO			
Thread Grinder		NT1L4 (NX-57475)	3R8L4 & 3R12L4•		CD-5827		
Model E Form Grinder		JONES & LAMSON FORM THREAD GRINDER Specify included angle and radius on diamond.			CD-8334		
					S-2104-4		
JONES & SHIPMAN		CD-7802-B			CD-6768		
KELLENBERGER		DI251138		LANDIS TOOL CO.		BCSG10M7•	
		CD-6200-V		MICRON		CD-5804	
				MITSUBISHI			
		CD-441F-12			CD-6475		
		CD-6783			CD-8514		
				MOORE PANTOGRAPH		MOORE CONTOUR DRESSER +Specify included angle and radius on diamond.	
K.O. LEE COMPANY		BCSG5M6•		Contour Dresser			
		CD-6996-A		NORMAC & HERTLIEN		CD-4895-12	
		S-2104-4					
		S-2623					

• INDICATES A STOCK ITEM.

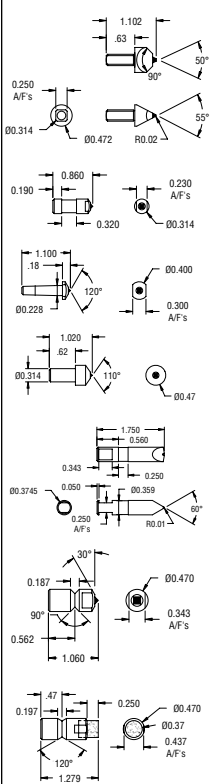
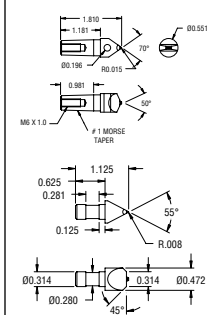
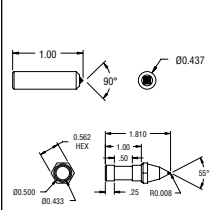
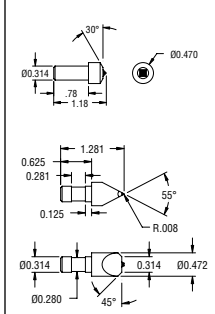
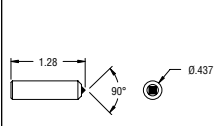
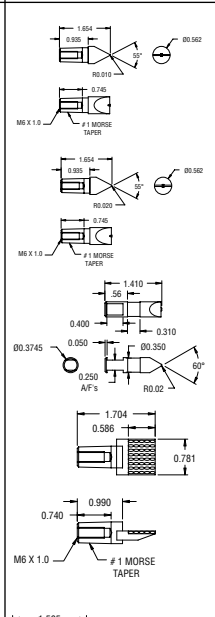
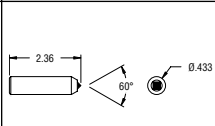
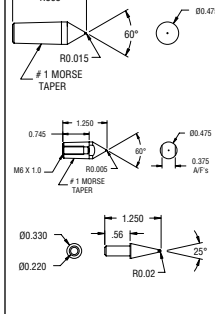
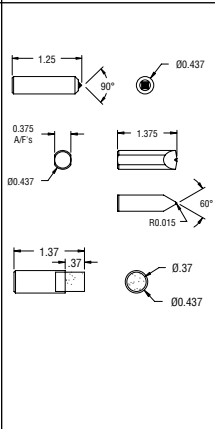
DIAMOND TOOL RECOMMENDATIONS BY MACHINE TYPE

MANUFACTURER AND MACHINE TYPE	TOOL DRAWING	ORDERING SPECIFICATION SINGLE POINT TOOL	ORDERING SPECIFICATION MULTI-POINT TOOL	MANUFACTURER AND MACHINE TYPE	TOOL DRAWING	ORDERING SPECIFICATION SINGLE POINT TOOL	ORDERING SPECIFICATION MULTI-POINT TOOL
OKAMOTO		<p>CD-8907</p> <p>CD-7994</p> <p>CD-5711-A</p> <p>CD-591-48</p> <p>CD-2221-U</p> <p>CD-3230</p> <p>ME124878-B</p>		SCHAUDT		<p>CD-7513</p> <p>CD-5357</p>	
OKUMA		<p>CD-361-AA</p> <p>CD-5147</p>		SHIGIYA		<p>CD-6222</p> <p>CD-6167</p>	
OLIVER INSTRUMENT		<p>CD-441G-25</p>		STUDER		<p>CD-6501</p> <p>CD-6501-A</p> <p>CD-7819</p> <p>CD-6426</p>	
OVERBECK		<p>CD-7541-A</p>		ROYALMASTER		<p>CD-5315</p> <p>CD-7503</p> <p>CD-6405</p>	
ROYALMASTER		<p>CD-441G-34</p> <p>CD-6653</p> <p>ME85710-F</p> <p>CD-8695</p>		CD-6797		<p>CD-6797</p>	

DIAMOND TOOL RECOMMENDATIONS BY MACHINE TYPE

MANUFACTURER AND MACHINE TYPE	TOOL DRAWING	ORDERING SPECIFICATION SINGLE POINT TOOL	MULTI-POINT TOOL
STUDER (CONTINUED)		CD-6852 CX-1421 CX-1421-A CX-1421-B	
TOYODA		CD-5963 CD-8033	
WASINO		D1101175 D1052175	
WELDON		CD-7147-1	
WILSON HARDNESS TESTER		CD-1552	



COMPETITIVE TOOL ANALYSIS

A competitive tool analysis is the best method of supplying you with a product that meets your quality needs at a competitive price. Our analysis of your present unused tool may include removal of the diamond for expert evaluation. Norton will review your application information to determine if a different dressing tool design could improve your process and/or provide a quote for comparable product.

CUSTOM MADE DRESSING TOOLS

The Norton Diamond Tool Team maintains a file of over 50,000 different diamond tool designs, cross-referenced by machine builder, tool type, and other manufacturers.

New applications create the need for new tools. Our experienced staff is unmatched in designing and building custom tools.

When ordering custom tools, it is important that the following be supplied:

Workpiece Considerations

- Part forms
- Tolerances of part
- Surface finish required

Machine Data

- Tool holder size and shape
- Length of tool
- Method of fastening tool
- Contact position of tool to wheel face
- Method of generating form (from bar or CNC)
- Whether tool is used wet or dry
- Dressing parameters

Wheel Specifics

- Size (diameter x width)
- Grit size
- Abrasive type
- Total wheel specification is desirable

WE OFFER A FULL LINE OF CUSTOM-MADE STATIONARY TOOLS



**FLIESEN STATIONARY
DIAMOND DRESSING TOOLS**



NORTON

SAINT-GOBAIN

OPEN OR CLOSED DRESSING... YOU CAN COUNT ON FLIESEN TOOLS

Whether dressing a wheel OPEN or CLOSED you can count on Fliesen tools. Open wheels (sharp, free-cutting abrasive grains are exposed) are created by increasing the speed a Fliesen tool moves across the wheel when dressing. Generally considered the most favorable wheel conditioning, open wheels avoid workpiece burn while maximizing a wheel's ability to remove metal quickly when grinding.

Slowing a Fliesen tool as it moves across the wheel creates a closed wheel condition (abrasive grains are smoother, less sharp), a very helpful condition when trying to lower part surface finish readings.

THE BENEFITS OF FLIESEN TOOLS

Spend More Time Grinding

Single point, chisel, and cone point tools require operator attention to ensure proper tool rotation at regular intervals. Fliesen tools require no adjustments. Simply install the tool, dress the wheel to break it in, and the tool will do the rest. Operators spend more time grinding – rather than making non-productive dressing adjustments.

Longer Tool Life

Expect long life when using a Fliesen tool. Other stationary tools, made with a single diamond stone, develop flat spots (“wear flats”) over time – which create chatter and burn. Fliesen tools use hand-set, fine diamond grit, eliminating the creation of wear flats.

Reliable and Cost-Effective









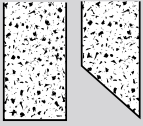
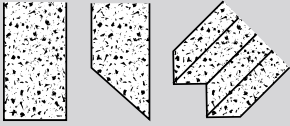

Harder, H-bond metal formulation Fliesen tools have been specifically engineered to efficiently dress durable silicon carbide and ceramic wheels. Our new Furioso Fliesen tools have a unique bond system developed for optimal performance when dressing Norton Quantum (NQ) ceramic wheels. W-bond Fliesen tools are designed for conventional aluminum oxide wheels.

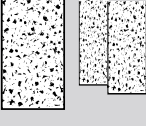
FLIESEN TOOL CONFIGURATIONS

Fliesen tools are available in two basic tool configurations. The most common is a plate configuration, which is somewhat rectangular-shaped with a mounting hole. Fliesen Shank Tool configurations are plates mounted in shanks of varying sizes and shapes. Most grinding machines accommodate one or the other tool configuration. To find the correct tool configuration for your machine, check the existing dressing tool, refer to the Tools by Machine Type Index in this catalog, or consult your grinding machine manual.

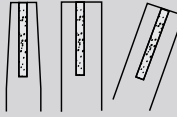
CHOOSING THE CORRECT FLIESEN TOOL

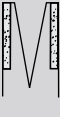
Using the chart below, find your desired wheel form – then locate the preferred diamond position. Next, find the correct tool configuration for your machine: plate or shank tool. Follow down that column to find the Fliesen page for your plate or standard shank tool configuration. Go to the appropriate page. Locate the corresponding zone for your wheel diameter and width on the graph. Find that zone number in the UPC chart. Next, moving to the right, find your wheel abrasive type and grit size. Locate the UPC number for your Fliesen tool.

DESIRED WHEEL FORM					
DIAMOND POSITIONS	 BLADE ONLY FR	 SIDE-MOUNTED FRS, FAS, FBS, FCS, FDS	 CENTER-MOUNTED FAS, FBS, FCS & FDS	 DOUBLE-SIDED FCSD & FDSD	 TWIN FDST, FSST, AND 1TFAS
TOOL CONFIGURATION					
PLATES	 CONSULT CUSTOMER SERVICE	PAGE 115 – 116	PAGE 116	PAGE 117	PAGE 115, 117
SHANK TOOLS	 PAGE 118	PAGE 115, 118 CONSULT CUSTOMER SERVICE	CONSULT CUSTOMER SERVICE	CONSULT CUSTOMER SERVICE	CONSULT CUSTOMER SERVICE

SPECcheck

MATCH THE CORRECT FLIESEN TOOL TO YOUR GRINDING WHEEL ABRASIVE

Use Fliesen tools with W-bond specifications for aluminum oxide wheels. W-bonded tools have the standard matrix of metal surrounding the diamonds. When dressing more durable abrasive wheels, such as silicon carbide and ceramic, use our H-bonded tools, or our new Furioso tools for Norton Quantum and other ceramic wheels, which are harder and more durable. Markings on the tool indicate the tool's bond matrix. Use the right bond matrix for your abrasive application, as each is specifically engineered to perform best on the abrasive it was designed for. The catalog product charts are categorized by abrasive and appropriate bond.

FLIESEN TOOL MOUNTING GUIDELINES

1. Be sure to mount the tool correctly. Tool contact surface should be perpendicular to wheel.

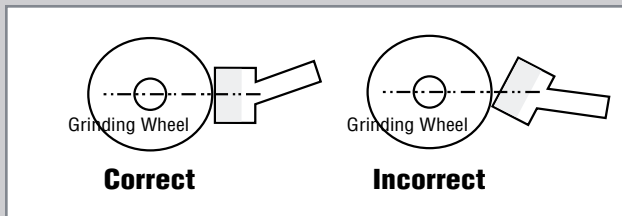
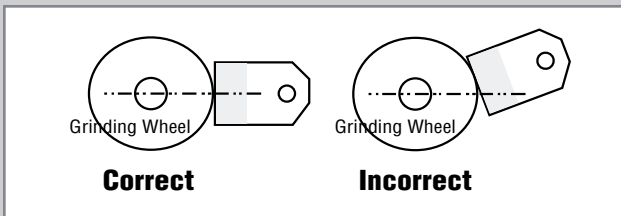

2. Mount tool with diamond on trailing edge whenever possible as shown below.

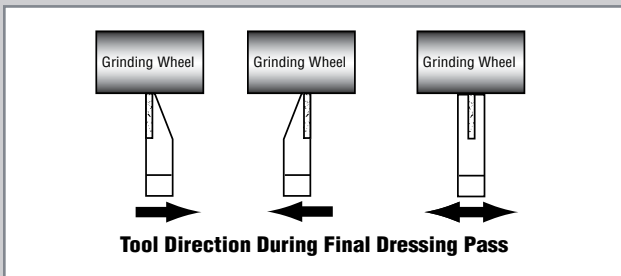

RECOMMENDED DRESSING PARAMETERS

There are three elements to proper dressing. Dresser Infeed is the amount of material the tool takes off per dress pass. Dress Traverse Rate is the speed at which the tool moves across the wheel. The third element is the Number of Passes across the wheel. We recommend the following:

1. Dresser Infeed

Dresser Infeed (amount tool moves into wheel) = .0005" to .0015" (.012mm – .038mm) for aluminum oxide wheels. Reduce by 25% when dressing silicon carbide or ceramic wheels.

2. Dress Traverse Rate

Select a Lead Value based on desired Surface Finish and run the formula below.

FINISH	LEAD VALUE (PER WHEEL REVOLUTIONS)
For Coarse Finish (approx. 64 rms)	.023" to .030" (.58mm – .76mm)
For Medium Finish (approx. 32 rms)	.013" to .022" (.33mm – .57mm)
For Fine Finish (approx 16 rms)	.006" to .012" (.15mm – .33mm)

DRESS TRAVERSE FORMULA:

$$\text{Lead Value} \times \text{Wheel Speed (RPM)} = \text{Inches/Minutes (mm/Min)}$$

3. Number of Passes

One is required. Take more as needed to restore form or finish. Dress passes should always remove material from the wheel. If your tool is not cutting the wheel, it is dulling the wheel. Avoid dry or dead dress passes which do not remove wheel material.

MAXIMIZING TOOL LIFE AND EFFECTIVENESS

The goal of dressing is to maximize the wheel's sharpness – for maximum metal removal when grinding. This is best accomplished through disciplined dressing speeds and feeds. Taking too much off per dress pass, and/or moving the tool too slowly across the wheel will cause the Fliesen tool to overheat, breakdown and wear prematurely. To maximize the tool's effectiveness, increase the dress traverse rate as high as possible while maintaining part print surface finish requirements.

SPECcheck

TOOL BREAK-IN

The diamonds in new Fliesen tools are often covered by the metal surrounding them and should undergo a break-in process before production dressing. This process ensures that the effective diamond layer is properly exposed. This is achieved by taking 3 – 5 dress passes at .005" depth of cut (on wheel radius) at normal dress traverse rates.

Because the diamonds are set at a slight angle, it is normal for some diamonds to remain buried in the metal after the break-in and during production dressing.

COOLANT SPECIFICATIONS

Fliesen tools should be used with coolant whenever possible, to avoid overheating and shortening tool life. We recommend at least a .50" (12.7mm) diameter stream of steady coolant be positioned so that the air barrier surrounding the wheel "pulls" the coolant (through the dressing action). A coolant velocity of 3% to 5% faster than the wheel's surface feet per minute works well, or enough pressure to penetrate the air barrier surrounding the wheel as it spins.

RADIUS DRESSING CAPABILITIES

For most angle-head truing and dressing applications, Fliesen tools can provide uniform and consistent radius-generation second only to chisel and cone point type tools. When dressing very intricate forms, tool selection should be driven by the smallest concave or fillet radius needed to generate the desired radii, rather than wheel grit size. Refer to the chart below for radius dressing capabilities by diamond size.

FLIESEN TOOL	DESCRIPTION	TYPICAL FILLET RADIUS (MIGHT VARY W/ APPLICATION AFTER BREAK-IN)		DRESSING WIDTH OF FLIESEN
FRS/FDS/FCS/FBS/FAS/1TFAS	75	.014	.008	.020
FRS/FDS/FCS/FBS/FAS/1TFAS	90	.014	.012	.028
FDS/FCS/FBS/FAS/1TFAS	115	.020	.018	.040
FDS/FCS/FBS/FAS/1TFAS	140	.022	.020	.044

STANDARD FLIESEN PLATE DRAWINGS

<p>Plate or Special Mounts FCS – W Bond Only</p>	<p>Plate- or Shank-Mounted FCS – H Bond</p>	<p>Plate or Special Mounts FDS – W Bond Only</p>	<p>Plate- or Shank-Mounted FDS – H Bond</p>
<p>Plate- or Shank-Mounted FRS – W Bond Only</p>	<p>Plate- or Shank-Mounted Twin FCS – W Bond Only</p>	<p>Plate Only, With Adapter Twin FCS – W Bond Only</p>	<p>Typical Shank-Mounted Design</p>

STANDARD HOLE SIZE FOR ALL TOOLS = 6.1MM.

SEE THE FURIOSO TOOL PLATE DRAWINGS AND AVAILABILITY, FOR DRESSING NEW CERAMICS, SUCH AS NORTON QUANTUM WHEELS, ON THE FOLLOWING PAGES.

PLEASE CONTACT YOUR NORTON REPRESENTATIVE FOR ALL YOUR NON-STOCK CUSTOM CONFIGURATION QUESTIONS, REQUEST FOR QUOTES, ETC.

The new generation of highly wear-resistant stationary diamond dressing tools for dressing modern ceramic abrasives.

Performance Advantage

Furioso vs. Standard Blade

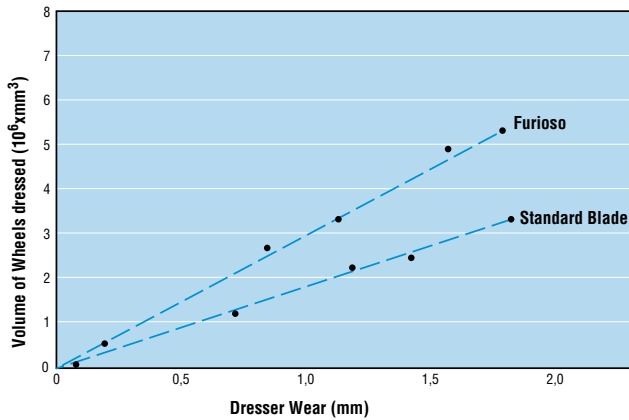

BEST

FURIOSO TOOLS – FOR OPTIMUM PERFORMANCE ON NORTON QUANTUM CERAMIC WHEELS

FEATURES

- The optimized combination of diamond quality, bond and setting pattern when dressing Norton Quantum (NQ) ceramic grinding wheels

BENEFITS

- Improved wear-resistance
- Excellent dressing behavior
- Constant surface roughness



Standard Furioso Plate Drawings

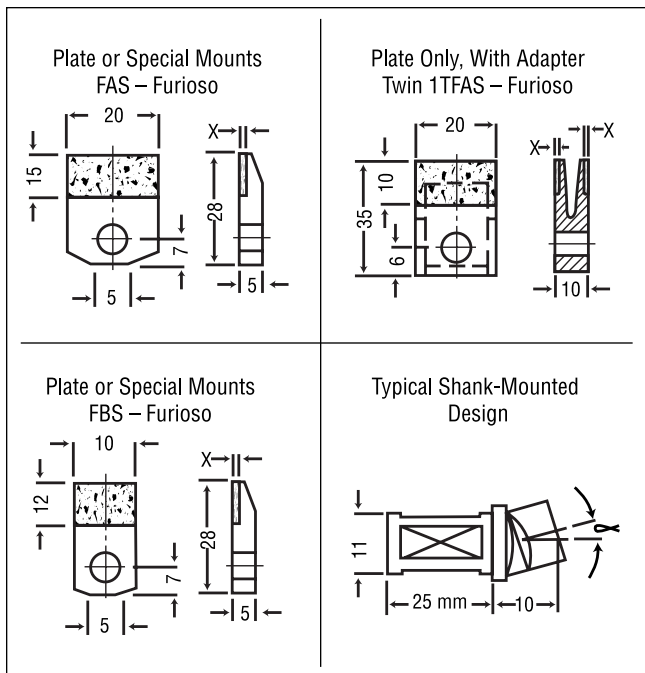

FURIOSO PLATES; SIDE-MOUNTED AND TWIN

Use the Wheel/Tool Graph to identify your grinding wheel's Zone number, and the chart below to find the Furioso tool for your application.

Wheel / Furioso Tool Graph

Select Zone based on wheel diameter and width

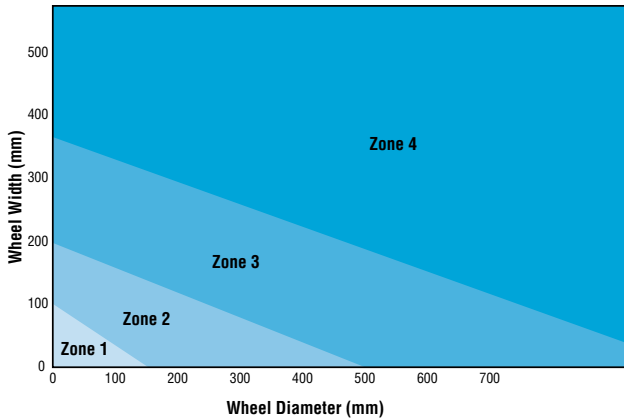

			BEST		
ZONE # / SERIES		WHEEL GRIT SIZE	NORTON QUANTUM NQ CERAMIC WHEELS		
			TOOL #	UPC #	DESCRIPTION
SIDE-MOUNTED					
	Zone 2	36 - 54	DT1463	69014122948	FBS 140 Furioso
		FBS Series			
		54 - 80	DT1462	69014122947	FBS 115 Furioso
		80 - 120	DT1461	69014122946	FBS 90 Furioso
		120 - 180	DT1460	69014122944	FBS 75 Furioso
	Zone 3	36 - 54	DT1467	69014122952	FAS 140 Furioso
		FAS Series			
		54 - 80	DT1466	60157690579	FAS 115 Furioso
		80 - 120	DT1465	60157693885	FAS 90 Furioso
		120 - 180	DT1464	69014122950	FAS 75 Furioso
TWIN					
	Zone 4	36 - 54	DT1471	69014122956	1TFAS 140 Furioso
		1TFAS Series			
		54 - 80	DT1470	69014122955	1TFAS 115 Furioso
		80 - 120	DT1469	69014122954	1TFAS 90 Furioso
		120 - 180	DT1468	69014122953	1TFAS 75 Furioso

• ALL FURIOSO PLATES SHOWN SHIP IN 10 BUSINESS DAYS FROM RECEIPT OF ORDER.

BLADE SIZE

DESCRIPTION	DIMENSION
1 FBS	10 mm thick, 15 mm usable length
2 FAS	20 mm thick, 15 mm usable length
3 TFAS	Twin blade with cooling duct

DIAMOND GRIT SIZE

DESCRIPTION	FEPA
140	D1181
115	D1001
90	D711
75	D501

FURIOSO SHANK TOOLS

Made-to-order Furioso shank tools are also available. Ask our Norton representative for ordering assistance.

Side-Mounted Diamond Sections

Tools are available in different offset positions and angles.



OFFSET LEFT, SPECIFY ANGLE AMOUNT



ZERO OFFSET



OFFSET RIGHT, SPECIFY ANGLE AMOUNT



DIAMOND TIPPED LEFT, SPECIFY ANGLE



DIAMOND TIPPED RIGHT, SPECIFY ANGLE



THERE ARE MANY DIFFERENT DIAMONDS MAKING UP A SINGLE PLATE AS THIS CUT-AWAY VIEW SHOWS.

FLIENEN PLATES: SIDE- AND CENTER-MOUNTED

Use the Wheel/Tool Graph to identify your grinding wheel's Zone number, and the chart below to find the Fliesen tool for your .

Wheel / Fliesen Tool Graph

Select Zone based on wheel diameter and width

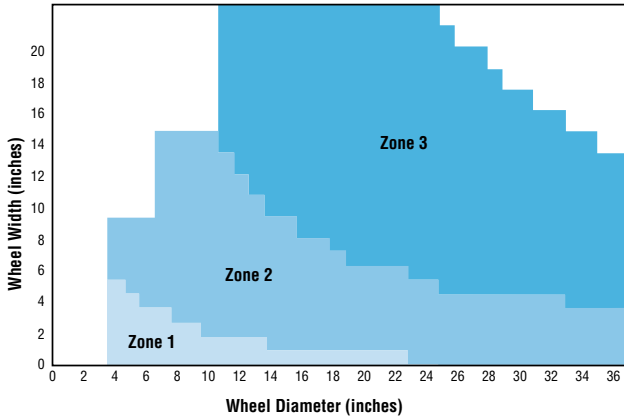

ZONE # / SERIES	WHEEL GRIT SIZE	BEST			BEST			
		ALUMINUM OXIDE WHEELS (W-BOND)			CERAMIC (SG & NQ), & S/C WHEELS (H-BOND)			
TOOL #	UPC #	DESCRIPTION	TOOL #	UPC #	DESCRIPTION			
SIDE-MOUNTED								
	Zone 1 FRS Series	60 and Finer	DT0691	66260388852#	FRS180W	H-bond Tools are not available in these configurations		
	Zone 2 FDS Series	36-46	DT0037	69014185737#	FDS140W			
		54-60	DT0035	69014185736#	FDS115W			
		80-100	DT0033	69014185735#	FDS90W			
		120 and Finer	DT0031	69014185747#	FDS75W			
	Zone 3 FCS Series	36-46	DT0027	69014185716*	FCS140W			
		54-60	DT0025	69014185718#	FCS115W			
		80-100	DT0023	69014185732#	FCS90W			
		120 and Finer	DT0021	69014185746#	FCS75W			
CENTER-MOUNTED								
	Zone 2 FDS Series	36-46	DT0246	66260114826*	FDS140W	DT0038	66260387481#	FDS140H
		54-60	DT0245	66260386661#	FDS115W	DT0036	66260387592#	FDS115H
		80-100	DT0244	66260389753#	FDS90W	DT0034	69014185738#	FDS90H
		120 and Finer	DT0243	66260114690#	FDS75W	DT0032	66260387692#	FDS75H
	Zone 3 FCS Series	36-46	DT0233	66260382018*	FCS140W	DT0028	66260387133#	FCS140H
		54-60	DT0232	66260386801#	FCS115W	DT0026	69014185734#	FCS115H
		80-100	DT0231	66260385394#	FCS90W	DT0024	66260384227#	FCS90H
		120 and Finer	DT0230	66260114271*	FCS75W	DT0022	66260385384#	FCS75H
FLIENEN PLATE MOUNTING MECHANISMS								
	Fliesen Plate Holder Tool No.: DT0085 UPC #: 66260100681		Fliesen Plate Holder Tool #: DT0069 UPC #: 66260389554 .437" diameter shank (tool not included).					

PLATES SHOWN SHIP 2-3 DAYS FROM RECEIPT OF ORDER.

* MADE-TO-ORDER; CONTACT YOUR NORTON REPRESENTATIVE FOR CURRENT LEAD-TIMES.

PLEASE CONTACT YOUR NORTON REPRESENTATIVE FOR ALL YOUR NON-STOCK CUSTOM CONFIGURATION QUESTIONS, REQUEST FOR QUOTES, ETC.

FLIENEN PLATES: DOUBLE-SIDED AND TWIN

Use the Wheel/Tool Graph to identify your grinding wheel's Zone number, and the chart below to find the Fliesen tool for your application.

Wheel / Fliesen Tool Graph

Select Zone based on wheel diameter and width

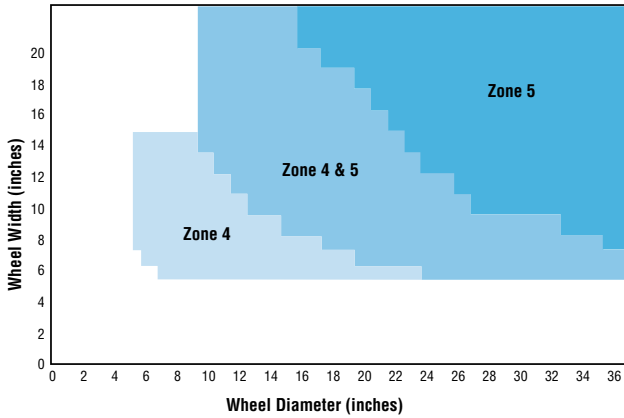

		BEST						
		ALUMINUM OXIDE WHEELS (W-BOND)			CERAMIC (SG & NQ), & S/C WHEELS (H-BOND)			
ZONE # / SERIES		WHEEL GRIT SIZE	TOOL #	UPC #	DESCRIPTION	TOOL #	UPC #	DESCRIPTION
DOUBLE-SIDED								
		Zone 4 FSDS Series	54-60	DT0741	69014123079*	FDSD115W	H-bond Tools are not available in these configurations	
		Zone 5 FCSD Series	54-60 80-100	DT0259 DT0411	66260112980* 66260111494*	FCSD115W FCSD90W		
TWIN								
		Zone 4 FDST Series	54-60	DT0969	66260391021*	FDST115W		
		Zone 5 FCST Series	54-60 80-100 120 and Finer	DT0442 DT0439 DT0733	66260112444# 66260114225# 69014123080*	FCST115W FCST90W FCST75W		

PLATES SHOWN SHIP 2-3 DAYS FROM RECEIPT OF ORDER.

* MADE-TO-ORDER; CONTACT YOUR NORTON REPRESENTATIVE FOR CURRENT LEAD-TIMES.

TECHtip

Because Double-sided and Twin Fliesen tools have twice the surface contact area on the wheel as single-sided Fliesen tools, they should traverse across the wheel nearly twice as fast. Also, with twice the diamond volume as single-sided Fliesen tools, they last twice as long.

FLIESEN SHANK TOOLS: BLADES AND SIDE-MOUNTED

Use the Wheel/Tool Graph to identify your grinding wheel's Zone number, and the chart below to find the Fliesen tool for your application.

Wheel / Fliesen Tool Graph

Select Zone based on wheel diameter and width

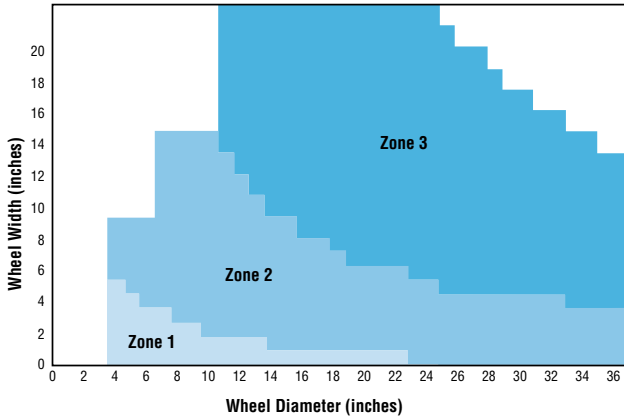

		BEST						
ZONE # / SERIES		WHEEL GRIT SIZE	ALUMINUM OXIDE WHEELS (W-BOND)			CERAMIC (SG & NQ), & S/C WHEELS (H-BOND)		
BLADES			TOOL #	UPC #	DESCRIPTION	TOOL #	UPC #	DESCRIPTION
		Zone 1 FR Series 0° Offset Angle 60 and Finer	DT1101-A	66260329400	FR180W	H-bond Tools are not available in these configurations		
		Zone 1 FR Series 15° Offset Angle 60 and Finer	DT1101	66260100826	FR180W			

• SHANK TOOLS SHOWN SHIP IN 10 BUSINESS DAYS FROM RECEIPT OF ORDER.

Side-Mounted Diamond Sections

Tools are available in different offset positions and angles. Contact your Norton representative for ordering assistance.



OFFSET LEFT,
SPECIFY ANGLE
AMOUNT

ZERO OFFSET

OFFSET RIGHT,
SPECIFY ANGLE
AMOUNT

Tipping the Diamond Plates on Shank Tools

Diamond sections can be tipped right or left. Contact your Norton representative for ordering assistance.



DIAMOND
TIPPED LEFT,
SPECIFY ANGLE

DIAMOND
TIPPED RIGHT,
SPECIFY ANGLE



THERE ARE
MANY DIFFERENT
DIAMONDS MAKING
UP A SINGLE PLATE
AS THIS CUT-AWAY
VIEW SHOWS.

SEE OUR FURIOSO SHANK TOOLS ON PAGE 114 FOR DRESSING MODERN CERAMIC WHEELS.

PLEASE CONTACT YOUR NORTON REPRESENTATIVE FOR ALL YOUR NON-STOCK CUSTOM CONFIGURATION QUESTIONS, REQUEST FOR QUOTES, ETC.

TRIANGLE INSERT DRESSING TOOLS

Designed for special machines requiring insert style tool configurations.

MACHINE TYPE	INNER CIRCLE (IC)	TIP RADIUS	BEST	
			ALL ABRASIVE TYPES TOOL #	UPC #
Studer	3.48mm	0.005"	P00590	66260166700 •
Tschudin		0.010"	P00585	66260102369 •
Vomard		0.020"	P00591	66260166174 •
Kellenberger	3.93mm	0.005"	P00830	60157625728*

• THESE TOOLS SHIP IN 10 BUSINESS DAYS FROM RECEIPT OF ORDER
* MADE-TO-ORDER; CONTACT YOUR NORTON REPRESENTATIVE FOR CURRENT LEAD-TIMES.



DIAMOND TRUING PAD

Designed for truing cBN grinding wheels on surface grinders. Use with coolant. Subsequent stick dressing is required to ensure proper wheel conditioning prior to grinding.

TOOL #	UPC #
DT0084	66260110959

THIS TRUING PAD IS A STOCK ITEM



TECHtip

ACCIDENTALLY DAMAGE YOUR FLIESEN TOOL?

Simply dress the wheel several times with your Fliesen Tool to wear away the damaged layer, and uncover a new layer of sharp diamonds. Unlike damaged chisel tools and cone point tools, which must be removed, inspected, and often replaced, Fliesen Tools can be quickly restored to optimum working order.

PLEASE CONTACT YOUR NORTON REPRESENTATIVE FOR ALL YOUR NON-STOCK CUSTOM CONFIGURATION QUESTIONS, REQUEST FOR QUOTES, ETC.





TOOLS BY MACHINE TYPE INDEX

Use the Wheel/Tool Graph to identify your grinding wheel's Zone number, and the chart below to find the Fliesen tool for your application.

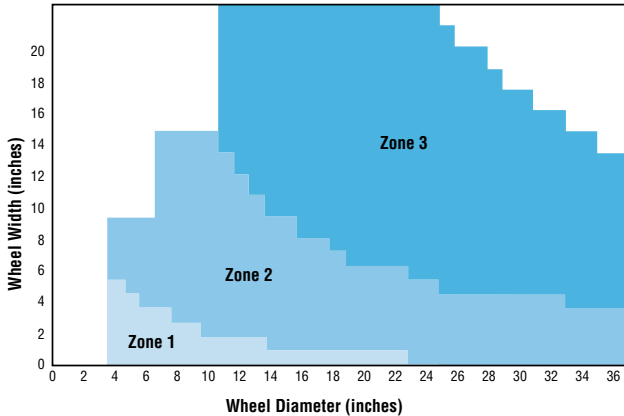
Wheel / Fliesen Tool Graph

Select Zone based on wheel diameter and width



ZONE # / ANGLE	WHEEL GRIT SIZE/RADIUS	BEST ALUMINUM OXIDE WHEELS (W-BOND)			BEST CERAMIC (SG & NQ), & S/C WHEELS (H-BOND)			
		TOOL #	UPC #	DESCRIPTION	TOOL #	UPC #	DESCRIPTION	
CINCINNATI CENTERLESS								
	Zone 2 0° Offset Angle	36-46	DT0246	66260114826	FDS140W	DT0038	66260387481	FDS140H
		54-60	DT0245	66260386661	FDS115W	DT0036	66260387592	FDS115H
		80-100	DT0244	66260389753	FDS90W	DT0034	69014185738	FDS90H
		120 and Finer	DT0243	66260114690	FDS75W	DT0032	66260387692	FDS75H
	Zone 3 0° Offset Angle	36-46	DT0233	66260382018	FCS140W	DT0028	66260387133	FCS140H
		54-60	DT0232	66260386801	FCS115W	DT0026	69014185734	FCS115H
		80-100	DT0231	66260385394	FCS90W	DT0024	66260384227	FCS90H
		120 and Finer	DT0230	66260114271	FCS75W	DT0022	66260385384	FCS75H
	Zone 2 15° Offset Angle	36-46	DT0434	66260100744	FDS140W	DT0218	60157603873	FDS140H
		54-60	DT0234	66260100716	FDS115W	DT0217	66260100708	FDS115H
		80-100	DT0183	66260100687	FDS90W	DT0216	66260100707	FDS90H
		120 and Finer	DT0433	66260100984	FDS75W	DT0215	66260102106	FDS75H
	Zone 3 15° Offset Angle	36-46	DT0437	66260100747	FCS140W	DT0210	66260100703	FCS140H
		54-60	DT0436	66260100746	FCS115W	DT0209	66260100702	FCS115H
		80-100	DT0251	66260100722	FCS90W	DT0208	66260100701	FCS90H
		120 and Finer	DT0435	66260100745	FCS75W	DT0207	66260100700	FCS75H
SCHAUDT								
	Chisel Tool 70° Included Angle .50ct	.016" Radius	TP1082	66260329714				

CONTACT YOUR NORTON REPRESENTATIVE FOR CURRENT LEAD-TIMES.

PLEASE CONTACT YOUR NORTON REPRESENTATIVE FOR ALL YOUR NON-STOCK CUSTOM CONFIGURATION QUESTIONS, REQUEST FOR QUOTES, ETC.







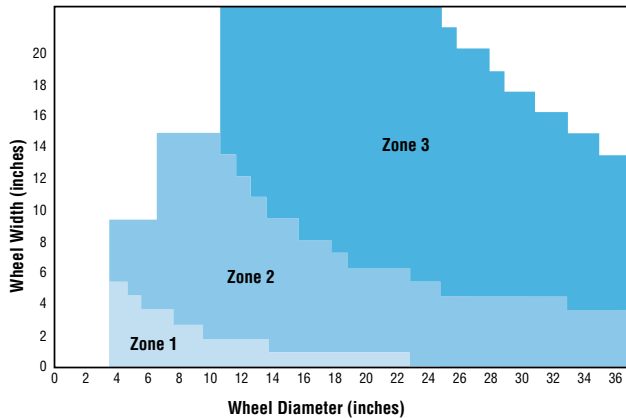

TOOLS BY MACHINE TYPE INDEX

Use the Wheel/Tool Graph to identify your grinding wheel's Zone number, and the chart below to find the Fliesen tool for your application.

Wheel / Fliesen Tool Graph

Select Zone based on wheel diameter and width



			BEST			BEST		
ZONE # / OFFSET ANGLE		WHEEL GRIT SIZE/RADIUS	ALUMINUM OXIDE WHEELS (W-BOND)			CERAMIC (SG & NQ), & S/C WHEELS (H-BOND)		
			TOOL #	UPC #	DESCRIPTION	TOOL #	UPC #	DESCRIPTION
OKUMA								
	Zone 2 5° Offset Angle	54-60	DT0489	66260101515	FDS115W			
		80-100	DT0511	66260101453	FDS90W			
		120 and Finer	DT1126	60157604435	FDS75W	DT0523	66260102408	FDS75H
	Zone 3 5° Offset Angle	54-60	DT0589	60157604098	FCS90W			
								
	Cone Point Tools							
	55° Included	.008" Radius	TP1077	66260329663				
	Angle	.015" Radius	TP1078	66260329670				
	70° Included	.008" Radius	TP1079	66260329675				
	Angle .50ct	.015" Radius	TP1080	66260329680				
TOYODA								
	Zone 2 10° Offset Angle	36-46	DT0690	60157604139	FDS140W	DT0557	66260100803	FDS140H
		54-60	DT0527	66260101271	FDS115W	DT0529	66260102768	FDS115H
		80-100	DT0488	66260101495	FDS90W	DT0528	66260101454	FDS90H
		120 and Finer	DT0526	66260100786	FDS75W	DT0513	66260100779	FDS75H
	Zone 3 10° Offset Angle	36-46	DT0428	66260100742	FCS140W	DT0432	60157604008	FCS140H
		54-60	DT0427	66260100741	FCS115W			
		80-100	DT0426	66260100740	FCS90W			
		120 and Finer	DT0425	60157604003	FCS75W	DT0429	66260100743	FCS75H

CONTACT YOUR NORTON REPRESENTATIVE FOR CURRENT LEAD-TIMES.

TOOLS BY MACHINE TYPE INDEX

Use the Wheel/Tool Graph to identify your grinding wheel's Zone number, and the chart below to find the Fliesen tool for your application.

Wheel / Fliesen Tool Graph

Select Zone based on wheel diameter and width

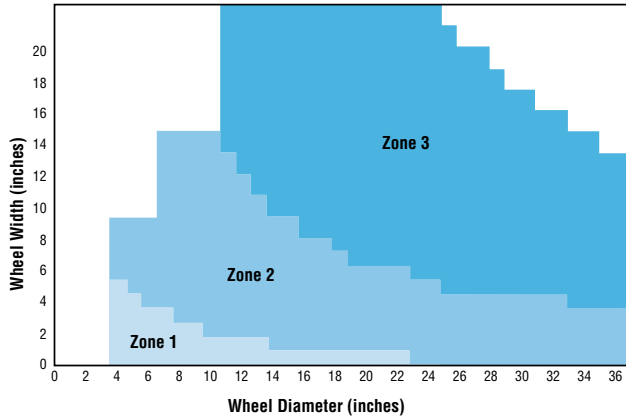

			BEST			BEST		
ZONE # / SHANK/ANGLE			ALUMINUM OXIDE WHEELS (W-BOND)			CERAMIC (SG & NQ), & S/C WHEELS (H-BOND)		
WHEEL GRIT SIZE/RADIUS			TOOL #	UPC #	DESCRIPTION	TOOL #	UPC #	DESCRIPTION
STUDER								
	Zone 2	54-60	DT0444	66260100751	FDS115W	DT1049	66260166122	FDS115H
	19mm Long	80-100	DT0474	66260100759	FDS90W	DT1047	66260101129	FDS90H
	MT1 Shank	120 and Finer	DT0443	66260100936	FDS75W			
	Zone 3	54-60	DT0558	66260100805	FCS115W	DT1005	60157604315	FCS115H
	19mm Long							
	MT1 Shank							
	Zone 2	54-60	DT0761	66260320977	FDS115W	DT0550	60157604072	FDS115H
	40mm Long	80-100	DT0595	66260100816	FDS90W			
	Shank	120 and Finer	DT0547	66260100798	FDS75W			
	Zone 3	54-60	DT0051	66260100670	FCS115W			
	40mm Long	80-100				DT0287	66260100731	FCS90H
	MT1 Shank							
STUDER & FORTUNA								
	Chisel Tool	.005" Radius	TP1083	66260329681				
	Zone 3	.008" Radius	TP1084	66260329688				
	55° Offset Angle	.010" Radius	TP1085	66260329696				
	.50 ct	.015" Radius	TP1086	66260329705				
		.020" Radius	TP1087	66260329709				
ROYAL MASTER								
	Zone 2	36-46	DT1114	60157604423	FDS140W			
	10° Offset Angle	54-60	DT1113	66260100820	FDS115W			
		80-100	DT1112	66260100821	FDS90W			
		120 and Finer	DT1111	60157604420	FDS75W			

CALL YOUR NORTON REPRESENTATIVE FOR CURRENT LEAD-TIMES.

FLIESEN TOOL COMPETITIVE CROSS REFERENCE

CINCINNATI TOOL #	NORTON TOOL #
CM300	DT233
CM300-7/16-1	DT424
CM300-7/16-1-0	DT424
CM300-7/16-1-10	DT428
CM300-7/16-1-15	DT437
CM301	DT232
CM301-7/16-1	DT423
CM301-7/16-1-0	DT423
CM301-7/16-1-10	DT276
CM301-7/16-1-15	DT436
CM301N	DT1385
CM302	DT231
CM302-7/16-1-10	DT426
CM302-7/16-1-15	DT251
CM303	DT230
CM303-7/16-1	DT421
CM303-7/16-1-0	DT421
CM303-7/16-1-10	DT425
CM303-7/16-1-15	DT435
CM304	DT411
CM304-7/16-1-15	DT441
CM306	DT85

CINCINNATI TOOL #	NORTON TOOL #
CM308	DT439
CM309	DT442
CM334	DT246
CM334-7/16-1	DT420
CM334-7/16-1-0	DT420
CM334-7/16-1-10	DT690
CM334-7/16-1-15	DT434
CM335	DT245
CM335-7/16-1	DT419
CM335-7/16-1-0	DT419
CM335-7/16-1-10	DT527
CM335-7/16-1-15	DT234
CM336	DT244
CM336-7/16-1	DT290
CM336-7/16-1-0	DT290
CM336-7/16-1-10	DT488
CM336-7/16-1-15	DT183
CM337	DT243
CM337-7/16-1	DT296
CM337-7/16-1-0	DT296
CM337-7/16-1-10	DT526
CM337-7/16-1-15	DT433

CINCINNATI TOOL #	NORTON TOOL #
CM338	DT28
CM338-7/16-1	DT206
CM338-7/16-1-0	DT206
CM338-7/16-1-10	DT432
CM338-7/16-1-15	DT210
CM339	DT26
CM339-7/16-1	DT205
CM339-7/16-1-0	DT205
CM339-7/16-1-15	DT209
CM340	DT24
CM340-7/16-1	DT204
CM340-7/16-1-0	DT204
CM340-7/16-1-15	DT208
CM341	DT22
CM341-7/16-1	DT203
CM341-7/16-1-0	DT203
CM341-7/16-1-10	DT429
CM341-7/16-1-15	DT207
CM358	DT38
CM358-7/16-1	DT214
CM358-7/16-1-0	DT214
CM358-7/16-1-10	DT557

CINCINNATI TOOL #	NORTON TOOL #
CM358-7/16-1-15	DT218
CM359	DT36
CM359-7/16-1	DT213
CM359-7/16-1-0	DT213
CM359-7/16-1-10	DT529
CM359-7/16-1-15	DT217
CM360	DT34
CM360-7/16-1	DT212
CM360-7/16-1-0	DT212
CM360-7/16-1-10	DT528
CM360-7/16-1-15	DT216
CM361	DT32
CM361-7/16-1	DT211
CM361-7/16-1-0	DT211
CM361-7/16-1-10	DT513
CM361-7/16-1-15	DT215
CM370	DT259
CM370-7/16-1	DT476
CM370-7/16-1-0	DT476
CM370-7/16-1-10	DT262
CM370-7/16-1-15	DT261

**NORTON ELECTROPLATED
DIAMOND AND CBN PRODUCTS**



ENGINEERING TO MEET DIVERSE DEMANDS

Our extensive offering of stock diamond and cBN electroplated products has been engineered to meet the diverse demands of traditional and emerging tool and die, ceramic, and composite applications.

Applications include small hole/ID grinding, deburring, cleaning, honing, precision drilling, forming dies and molds, routing, reaming, blending radii, notching and cutting-off with saw blades in ceramic, tool and die, and composite applications.

IDENTIFYING TARGET MARKETS:

An industry key is provided beside each product. This key identifies markets that typically use the product:

TARGET MARKET SYMBOLS:



PLACING AN ORDER

Our many products and services can be ordered through our network of quality industrial distributors. To ensure accurate and rapid order fulfillment, please provide your distributor with:

- **UPC Number:** the 11-digit number found in each product availability chart in the first left-hand column
- **Product Description:** such as a cBN mounted point or a diamond wheel
- **Dimensions and Wheel Shape:** such as 6 x 7/16 x 1-1/4 Type 6A2C diamond wheel
- **Product Specification:** such as 100 grit, diamond
- **Order quantity**

STRIP AND REPLATE SERVICES AND CUSTOM-MADE PRODUCTS

Ask Customer Service for information and quotations on our complete strip and replate services on many electroplated products.

And, when your application calls for a product design not available from our standard offering, Norton can provide a made-to order product engineered to your drawings.

CONTACT YOUR NORTON DISTRIBUTOR OR NORTON CUSTOMER SERVICE

US Customer Service
Phone Toll Free: (800) 551-4413
Fax Toll Free: (800) 551-4416
Local Phone: (254) 918-2313
Local Fax: (254) 918-2314

Canadian Customer Service
Telephone: (800) 263-6565
Fax: (800) 561-9490

TECHNICAL INFORMATION

To ensure correct usage and maximum performance of our products, refer to the following General Information and Tech Tip pages.

ABRASIVE APPLICATIONS

Although diamond and cBN (cubic Boron Nitride) are both superabrasives, the use of diamond and cBN varies, depending upon the materials to be ground.

Diamond Grinds:

- Cemented carbide
- Glass
- Ceramics
- Fiberglass
- Plastics
- Composites
- Abrasives
- Stone
- Electronic components and materials

cBN Grinds:

- High-speed tool steels
- Die steel
- Hardened carbon steels
- Hardened stainless steels
- Alloy steels
- Aerospace alloys
- Abrasion-resistant ferrous materials

In general, cBN is used to grind ferrous materials. Diamond is used to grind non-ferrous materials, because it reacts with iron.

SURFACE FINISH

Use this chart only as a guide. Surface finish is affected by a number of variables: machine type and condition, type of material, coolant, wheel speed, bond system, etc.

Expected RMS Finish

GRIT SIZE	ELECTROPLATED
80	90-125
100	64-90
120	48-64
150	32-48
180	24-32
220	20-24
240	16-20
320	16-20
400	14-20
500	12-13
600	12
800	12
1200	12
1500	12

MADE-TO-ORDER ELECTROPLATED PRODUCT GUIDE

The stock electroplated products offered on the following pages have been engineered to meet the diversity of demands typical in today's manufacturing environment.

When special forms, shapes and configurations are required, Norton electroplated diamond and cBN products can be fabricated in almost any geometry. In addition, strip and replate services are available.

Customers may prefer to manufacture their own preforms/blanks for custom products and in many cases this can reduce cost and lead times.

The instructions below detail the necessary allowances for each grit size. Please refer to these whenever manufacturing blanks.

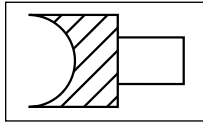

Area to be plated (female radius)

Female radius must be larger than the finished size required.

Example – If a .500 female radius is required with 60/80 grit, then the blank should be manufactured .011 larger = .511

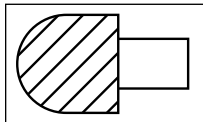

Area to be plated (male radius)

A male radius must be smaller than the finished size required.

Example – If a .500 male radius is required with 60/80 grit, then the blank should be manufactured .011 smaller = .489

**GRIT SIZE ALLOWANCE FOR
PLATED PRODUCTS**

GRIT SIZE	ALLOWANCE/ PARTICLE SIZE
20/30	.035
30/40	.025
40/50	.018
60/80	.011
80/100	.008
100/120	.007
120/140	.006
140/170	.005
170/200	.004
200/230	.0035
270/325	.003
4.5 Micron – 400	.0025
30 Micron – 600	.0016
15 Micron – 1200	.001

**THIS SHOULD BE USED AS A GUIDE WHEN
MANUFACTURING BLANKS TO BE PLATED WITH
DIAMOND OR CBN.**

TECHtip

COOLANTS

Although coolants may not be necessary, using a coolant produces superior surface finishes, a longer tool life, higher performance, and reduces tool loading.

FEEDS

Suggested feeds for jig or internal grinding are from .0002" – .0004" per pass.

SPEEDS

Maximum Operating Speeds (MOS)

Never exceed the maximum operating speed marked on the superabrasive product being used.

Electroplated Products: 25,000 SFPM

Maximum speeds of Mounted Point wheels are a function of the length of overhang and size of the product. Refer to "Safe Operating Speeds" in form #2872, provided with your product.

Recommended Operating Speeds

The preceding speed is the maximum safe speed and not necessarily the most efficient. Superabrasive products operate most effectively at speeds lower than the maximum. The following are general recommendations. cBN products, in many cases, are used effectively at higher speeds.

Electroplated Diamond Products: 5,000 to 10,000 SFPM

Electroplated cBN Products: 8,000 to 10,000 SFPM

Calculating Operating Speed

The following formula may be used to quickly calculate wheel speed:

RPM = Revolutions Per Minute
SPFM = Surface Feet Per Minute

To convert SFPM to RPM: (Multiply SFPM x 3.82) divided by wheel diameter in inches

ELECTROPLATED MOUNTED POINTS

DIAMOND AND cBN MOUNTED POINTS ● ▲

FEATURES	BENEFITS
■ Nickel alloy matrix	■ Tough, durable bond
■ Single layer of abrasive	■ Economical
■ Exposed particles	■ Aggressive cutting action
■ Variety of tools and grit sizes available as stock	■ Satisfies most tool and die and deburring requirements
■ Mandrels are made of high-speed tool steel	■ Withstand operating pressure

Use Norton diamond mounted points for precise, small hole, jig and internal grinding of carbide, ceramics, sapphire, glass, and a variety of tough, super alloys.

For grinding tough, high carbon, high chrome steel, use cBN mounted points.

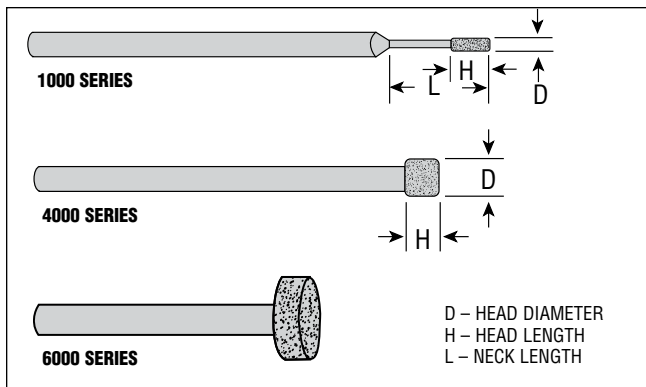

UPC #	PRODUCT #	HEAD DIAMETER INCHES	HEAD LENGTH	NECK LENGTH	GRIT SIZE
1000 SERIES - DIAMOND					
1/8" Shank x 2-1/4" Overall Length					
66260392429	1016FD	.016	.079	1/8	200
66260392432	1020MD	.020	.079	1/8	150
66260392431	1020FD	.020	.079	1/8	200
66260392436	1025MD	.025	.079	1/8	150
66260392435	1025FD	.025	.079	1/8	200
66260392440	1030MD	.030	.079	1/4	150
66260392439	1030FD	.030	.079	1/4	200
66260392445	1035CD	.035	.118	1/4	100
66260392444	1035MD	.035	.118	1/4	150
66260392443	1035FD	.035	.118	1/4	200
66260392451	1040CD	.040	.118	1/4	100
66260392450	1040MD	.040	.118	1/4	150
66260392449	1040FD	.040	.118	1/4	200
66260392457	1045CD	.045	.118	1/4	100
66260392456	1045MD	.045	.118	1/4	150
66260392455	1045FD	.045	.118	1/4	200
66260392463	1050CD	.050	.118	1/2	100
66260392462	1050MD	.050	.118	1/2	150
66260392461	1050FD	.050	.118	1/2	200
66260392469	1050LCD	.050	.118	1	100
66260392468	1050LMD	.050	.118	1	150
66260392467	1050LFD	.050	.118	1	200
66260392475	1055CD	.055	.118	1/2	100
66260392474	1055MD	.055	.118	1/2	150
66260392473	1055FD	.055	.118	1/2	200
66260392481	1060CD	.060	.157	1/2	100

+ AVAILABLE AS STOCK WHILE SUPPLIES LAST; THEN AVAILABLE AS NON-STOCK.
* NON-STOCK; CONTACT YOUR NORTON REPRESENTATIVE FOR CURRENT LEAD-TIMES.



UPC #	PRODUCT #	HEAD DIAMETER INCHES	HEAD LENGTH	NECK LENGTH	GRIT SIZE
1000 SERIES - DIAMOND (CONT'D)					
1/8" Shank x 2-1/4" Overall Length					
66260392480	1060MD	.060	.157	1/2	150
66260392479	1060FD	.060	.157	1/2	200
66260392487	1060LCD	.060	.157	1	100
66260392486 +	1060LMD	.060	.157	1	150
66260392485 *	1060LFD	.060	.157	1	200
66260392493 *	1065CD	.065	.157	1/2	100
66260392492	1065MD	.065	.157	1/2	150
66260392491	1065FD	.065	.157	1/2	200
66260392499	1070CD	.070	.157	1/2	100
66260392498	1070MD	.070	.157	1/2	150
66260392497	1070FD	.070	.157	1/2	200
66260392505 +	1070LCD	.070	.157	1	100
66260392504 *	1070LMD	.070	.157	1	150
66260392503 *	1070LFD	.070	.157	1	200
66260392511	1075CD	.075	.157	1/2	100
66260392510	1075MD	.075	.157	1/2	150
66260392509	1075FD	.075	.157	1/2	200
66260392517	1080CD	.080	.157	1/2	100
66260392516	1080MD	.080	.157	1/2	150
66260392515	1080FD	.080	.157	1/2	200
66260392523	1080LCD	.080	.157	1	100
66260392522 *	1080LMD	.080	.157	1	150
66260392521	1080LFD	.080	.157	1	200
66260392529	1085CD	.085	.157	1/2	100
66260392528	1085MD	.085	.157	1/2	150
66260392527 *	1085FD	.085	.157	1/2	200
66260392535	1090CD	.090	.157	1/2	100
66260392534	1090MD	.090	.157	1/2	150
66260392533	1090FD	.090	.157	1/2	200
66260392541	1090LCD	.090	.157	1	100
66260392540	1090LMD	.090	.157	1	150
66260392547	1095CD	.095	.157	1/2	100
66260392546	1095MD	.095	.157	1/2	150
66260392545 +	1095FD	.095	.157	1/2	200
66260392553	1100CD	.100	.157	1/2	100
66260392552	1100MD	.100	.157	1/2	150
66260392551	1100FD	.100	.157	1/2	200
66260392559 +	1100LCD	.100	.157	1	100
66260392565	1105CD	.105	.157	1/2	100
66260392564 *	1105MD	.105	.157	1/2	150
66260392563	1105FD	.105	.157	1/2	200
66260392571 *	1105LCD	.105	.157	1	100

CONTINUED

TARGET MARKET SYMBOLS:



ELECTROPLATED MOUNTED POINTS

DIAMOND AND cBN MOUNTED POINTS ● ▲

UPC #	PRODUCT #	HEAD DIAMETER INCHES	HEAD LENGTH	NECK LENGTH	GRIT SIZE
1000 SERIES – DIAMOND (CONT'D)					
1/8" Shank x 2-1/4" Overall Length					
66260392570 *	1105LMD	.105	.157	1	150
66260392569 *	1105LFD	.105	.157	1	200
66260392577	1110CD	.110	.157	1/2	100
66260392576	1110MD	.110	.157	1/2	150
66260392575 *	1110FD	.110	.157	1/2	200
66260392583	1110LCD	.110	.157	1	100
66260392581 *	1110LFD	.110	.157	1	200
66260392589	1115CD	.115	.157	1/2	100
66260392588	1115MD	.115	.157	1/2	150
66260392595	1120CD	.120	.157	1/2	100
66260392594	1120MD	.120	.157	1/2	150
66260392593	1120FD	.120	.157	1/2	200
66260392601	1125CD	.125	.157	1/2	100
66260392600	1125MD	.125	.157	1/2	150
66260392599	1125FD	.125	.157	1/2	200
66260392607	1130CD	.130	.197	1	100
66260392606	1130MD	.130	.197	1	150
66260392605 *	1130FD	.130	.197	1	200
66260392613	1135CD	.135	.236	N/A	100
66260392612	1135MD	.135	.236	N/A	150
66260392611	1135FD	.135	.236	N/A	200
66260392619	1140CD	.140	.236	N/A	100
66260392618 *	1140MD	.140	.236	N/A	150
66260392617 *	1140FD	.140	.236	N/A	200
66260392625	1156CD	.156	.236	N/A	100
66260392624	1156MD	.156	.236	N/A	150
66260392623	1156FD	.156	.236	N/A	200
66260392731 +	1171CD	.171	.236	N/A	100
66260392730	1171MD	.171	.236	N/A	150
66260392737	1187CD	.187	.312	N/A	100
66260392736 *	1187MD	.187	.312	N/A	150
66260392735	1187FD	.187	.312	N/A	200
66260392743 *	1203CD	.203	.312	N/A	100
66260392742	1203MD	.203	.312	N/A	150
66260392741	1203FD	.203	.312	N/A	200
66260392749 *	1218CD	.218	.312	N/A	100
66260392748	1218MD	.218	.312	N/A	150
66260392747	1218FD	.218	.312	N/A	200
66260392755	1250CD	.250	.312	N/A	100
66260392754	1250MD	.250	.312	N/A	150
66260392753	1250FD	.250	.312	N/A	200
66260363450	W10MD	.750	.035	N/A	150
1000 SERIES – cBN					
1/8" Shank x 2-1/4" Overall Length					
66260392430 *	1016FC	.016	.079	1/8	200
66260392434	1020MC	.020	.079	1/8	150
66260392433 *	1020FC	.020	.079	1/8	200
66260392438 *	1025MC	.025	.079	1/8	150
66260392437 *	1025FC	.025	.079	1/8	200
66260392442	1030MC	.030	.079	1/4	150
66260392441 +	1030FC	.030	.079	1/4	200
66260392448 *	1035CC	.035	.118	1/4	100
66260392446 *	1035FC	.035	.118	1/4	200
66260392454 *	1040CC	.040	.118	1/4	100
66260392453	1040MC	.040	.118	1/4	150

CONTINUED

UPC #	PRODUCT #	HEAD DIAMETER INCHES	HEAD LENGTH	NECK LENGTH	GRIT SIZE
1000 SERIES – cBN (CONT'D)					
1/8" Shank x 2-1/4" Overall Length					
66260392460	1045CC	.045	.118	1/4	100
66260392459 *	1045MC	.045	.118	1/4	150
66260392458 *	1045FC	.045	.118	1/4	200
66260392466	1050CC	.050	.118	1/2	100
66260392465	1050MC	.050	.118	1/2	150
66260392464	1050FC	.050	.118	1/2	200
66260392472 *	1050LCC	.050	.118	1	100
66260392471 *	1050LMC	.050	.118	1	150
66260392478 *	1055CC	.055	.118	1/2	100
66260392477 *	1055MC	.055	.118	1/2	150
66260392484	1060CC	.060	.157	1/2	100
66260392483	1060MC	.060	.157	1/2	150
66260392482	1060FC	.060	.157	1/2	200
66260392490 *	1060LCC	.060	.157	1	100
66260392489 *	1060LMC	.060	.157	1	150
66260392488 *	1060LFC	.060	.157	1	200
66260392496	1065CC	.065	.157	1/2	100
66260392494 *	1065FC	.065	.157	1/2	200
66260392502	1070CC	.070	.157	1/2	100
66260392501	1070MC	.070	.157	1/2	150
66260392500	1070FC	.070	.157	1/2	200
66260392508 *	1070LCC	.070	.157	1	100
66260392507 *	1070LMC	.070	.157	1	150
66260392506 *	1070LFC	.070	.157	1	200
66260392514	1075CC	.075	.157	1/2	100
66260392513 *	1075MC	.075	.157	1/2	150
66260392512	1075FC	.075	.157	1/2	200
66260392520	1080CC	.080	.157	1/2	100
66260392519 *	1080MC	.080	.157	1/2	150
66260392518 *	1080FC	.080	.157	1/2	200
66260392526 +	1080LCC	.080	.157	1	100
66260392525 *	1080LMC	.080	.157	1	150
66260392524 *	1080LFC	.080	.157	1	200
66260392532	1085CC	.085	.157	1/2	100
66260392531	1085MC	.085	.157	1/2	150
66260392538	1090CC	.090	.157	1/2	100
66260392537	1090MC	.090	.157	1/2	150
66260392536	1090FC	.090	.157	1/2	200
66260392544	1090LCC	.090	.157	1	100
66260392543	1090LMC	.090	.157	1	150
66260392542 *	1090LFC	.090	.157	1	200
66260392550 *	1095CC	.095	.157	1/2	100
66260392549 +	1095MC	.095	.157	1/2	150
66260392548 *	1095FC	.095	.157	1/2	200
66260392556	1100CC	.100	.157	1/2	100
66260392555 +	1100MC	.100	.157	1/2	150
66260392554	1100FC	.100	.157	1/2	200
66260392562 *	1100LCC	.100	.157	1	100
66260392561	1100LMC	.100	.157	1	150
66260392568	1105CC	.105	.157	1/2	100
66260392567	1105MC	.105	.157	1/2	150
66260392566 *	1105FC	.105	.157	1/2	200
66260392574 *	1105LCC	.105	.157	1	100
66260392573 *	1105LMC	.105	.157	1	150
66260392572 *	1105LFC	.105	.157	1	200

CONTINUED

+ AVAILABLE AS STOCK WHILE SUPPLIES LAST; THEN AVAILABLE AS NON-STOCK.
* NON-STOCK; CONTACT YOUR NORTON REPRESENTATIVE FOR CURRENT LEAD-TIMES.

TARGET MARKET SYMBOLS:



ELECTROPLATED MOUNTED POINTS

DIAMOND AND cBN MOUNTED POINTS ● ▲

UPC #	PRODUCT #	HEAD DIAMETER INCHES	HEAD LENGTH	NECK LENGTH	GRIT SIZE
1000 SERIES – cBN (CONT'D)					
1/8" Shank x 2-1/4" Overall Length					
66260392580	1110CC	.110	.157	1/2	100
66260392579 *	1110MC	.110	.157	1/2	150
66260392578	1110FC	.110	.157	1/2	200
66260392586 *	1110LCC	.110	.157	1	100
66260392584 *	1110LFC	.110	.157	1	200
66260392592 *	1115CC	.115	.157	1/2	100
66260392591 *	1115MC	.115	.157	1/2	150
66260392590 *	1115FC	.115	.157	1/2	200
66260392598	1120CC	.120	.157	1/2	100
66260392597 *	1120MC	.120	.157	1/2	150
66260392596 *	1120FC	.120	.157	1/2	200
66260392604	1125CC	.125	.157	1/2	100
66260392603	1125MC	.125	.157	1/2	150
66260392602	1125FC	.125	.157	1/2	200
66260392610	1130CC	.130	.197	1	100
66260392609 *	1130MC	.130	.197	1	150
66260392608	1130FC	.130	.197	1	200
66260392616	1135CC	.135	.236	N/A	100
66260392615	1135MC	.135	.236	N/A	150
66260392614 *	1135FC	.135	.236	N/A	200
66260392622	1140CC	.140	.236	N/A	100
66260392621 *	1140MC	.140	.236	N/A	150
66260392620 *	1140FC	.140	.236	N/A	200
66260392628	1156CC	.156	.236	N/A	100
66260392627	1156MC	.156	.236	N/A	150
66260392626	1156FC	.156	.236	N/A	200
66260392734	1171CC	.171	.236	N/A	100
66260392733	1171MC	.171	.236	N/A	150
66260392732 *	1171FC	.171	.236	N/A	200
66260392740	1187CC	.187	.312	N/A	100
66260392739	1187MC	.187	.312	N/A	150
66260392738	1187FC	.187	.312	N/A	200
66260392746 *	1203CC	.203	.312	N/A	100
66260392745	1203MC	.203	.312	N/A	150
66260392744 *	1203FC	.203	.312	N/A	200
66260392752	1218CC	.218	.312	N/A	100
66260392751	1218MC	.218	.312	N/A	150
66260392750 *	1218FC	.218	.312	N/A	200
66260392758	1250CC	.250	.312	N/A	100
66260392757	1250MC	.250	.312	N/A	150
66260392756 *	1250FC	.250	.312	N/A	200
4000 SERIES – DIAMOND					
1/4" Shank x 3" Overall Length					
66260392630	4156CD	.156	.250	1	100
66260392629	4156FD	.156	.250	1	200
66260392634	4187CD	.187	.250	1	100
66260392633	4187FD	.187	.250	1	200
66260392638	4203CD	.203	.250	1	100
66260392637+	4203FD	.203	.250	1	200
66260392642	4218CD	.218	.250	1	100
66260392641	4218FD	.218	.250	1	200
66260392646	4236CD	.236	.250	1	100
66260392645	4236FD	.236	.250	1	200
66260392650	4250CD	.250	.250	1	100
66260392649	4250FD	.250	.250	1	200
66260392654	4282CD	.282	.250	N/A	100
66260392653	4282FD	.282	.250	N/A	200
66260392658	4312CD	.312	.375	N/A	100

CONTINUED

UPC #	PRODUCT #	HEAD DIAMETER INCHES	HEAD LENGTH	NECK LENGTH	GRIT SIZE
4000 SERIES – DIAMOND (CONT'D)					
1/4" Shank x 3" Overall Length					
66260392657	4312FD	.312	.375	N/A	200
66260392662	4375CD	.375	.375	N/A	100
66260392661	4375FD	.375	.375	N/A	200
66260392666	4390CD	.390	.375	N/A	100
66260392665	4390FD	.390	.375	N/A	200
66260392670	4406CD	.406	.375	N/A	100
66260392669 *	4406FD	.406	.375	N/A	200
66260392674	4437CD	.437	.375	N/A	100
66260392673 *	4437FD	.437	.375	N/A	200
66260392678	4500CD	.500	.375	N/A	100
66260392677	4500FD	.500	.375	N/A	200
66260392682	4730CD	.730	.375	N/A	100
66260392681 *	4730FD	.730	.375	N/A	200
66260392685 *	4864FD	.864	.375	N/A	200
66260392690	41000CD	1.000	.375	N/A	100
66260392689	41000FD	1.000	.375	N/A	200
4000 SERIES – cBN					
1/4" Shank x 3" Overall Length					
66260392632	4156CC	.156	.250	1	100
66260392631	4156FC	.156	.250	1	200
66260392636	4187CC	.187	.250	1	100
66260392635	4187FC	.187	.250	1	200
66260392640	4203CC	.203	.250	1	100
66260392639	4203FC	.203	.250	1	200
66260392644	4218CC	.218	.250	1	100
66260392643	4218FC	.218	.250	1	200
66260392648	4236CC	.236	.250	1	100
66260392647	4236FC	.236	.250	1	200
66260392652	4250CC	.250	.250	1	100
66260392651	4250FC	.250	.250	1	200
66260392656	4282CC	.282	.250	N/A	100
66260392655	4282FC	.282	.250	N/A	200
66260392660	4312CC	.312	.375	N/A	100
66260392659	4312FC	.312	.375	N/A	200
66260392664	4375CC	.375	.375	N/A	100
66260392663	4375FC	.375	.375	N/A	200
66260392668	4390CC	.390	.375	N/A	100
66260392667+	4390FC	.390	.375	N/A	200
66260392672	4406CC	.406	.375	N/A	100
66260392671+	4406FC	.406	.375	N/A	200
66260392676	4437CC	.437	.375	N/A	100
66260392675	4437FC	.437	.375	N/A	200
66260392680	4500CC	.500	.375	N/A	100
66260392679	4500FC	.500	.375	N/A	200
66260392684	4730CC	.730	.375	N/A	100
66260392683	4730FC	.730	.375	N/A	200
66260392688 *	4864CC	.864	.375	N/A	100
66260392687 *	4864FC	.864	.375	N/A	200
66260392692	41000CC	1.000	.375	N/A	100
66260392691 *	41000FC	1.000	.375	N/A	200

**+ AVAILABLE AS STOCK WHILE SUPPLIES LAST; THEN AVAILABLE AS NON-STOCK.
* NON-STOCK; CONTACT YOUR NORTON REPRESENTATIVE FOR CURRENT LEAD-TIMES.**

TARGET MARKET SYMBOLS: ● ▲ ■

CERAMICS TOOL & DIE COMPOSITES

ELECTROPLATED MOUNTED POINTS, MANDRELS AND TAPERED HONES

DIAMOND AND cBN MOUNTED POINTS ● ▲

UPC #	PRODUCT #	HEAD DIAMETER INCHES	HEAD LENGTH	GRIT SIZE
6000 SERIES – DIAMOND				
3/8" Shank x 3-3/4" Overall Length				
66260392694	6406CD	.406	.375	80
66260392693	6406MD	.406	.375	150
66260392698	6437CD	.437	.375	80
66260392697	6437MD	.437	.375	150
66260392702	6500CD	.500	.375	80
66260392701	6500MD	.500	.375	150
66260392706	6562CD	.562	.375	80
66260392710	6625CD	.625	.375	80
66260392709	6625MD	.625	.375	150
66260392714 *	6687CD	.687	.375	80
66260392713 *	6687MD	.687	.375	150
66260392718	6750CD	.750	.375	80
66260392717	6750MD	.750	.375	150
66260392722 *	6875CD	.875	.400	80
66260392721	6875MD	.875	.400	150
66260392726	61000CD	1.000	.500	80
66260392725	61000MD	1.000	.500	150

UPC #	PRODUCT #	HEAD DIAMETER INCHES	HEAD LENGTH	GRIT SIZE
6000 SERIES – cBN				
3/8" Shank x 3-3/4" Overall Length				
66260392696	6406CC	.406	.375	80
66260392695	6406MC	.406	.375	150
66260392700	6437CC	.437	.375	80
66260392699	6437MC	.437	.375	150
66260392704	6500CC	.500	.375	80
66260392703	6500MC	.500	.375	150
66260392708	6562CC	.562	.375	80
66260392707 *	6562MC	.562	.375	150
66260392712	6625CC	.625	.375	80
66260392711	6625MC	.625	.375	150
66260392716	6687CC	.687	.375	80
66260392715	6687MC	.687	.375	150
66260392720	6750CC	.750	.375	80
66260392719	6750MC	.750	.375	150
66260392724	6875CC	.875	.400	80
66260392723 *	6875MC	.875	.400	150
66260392728	61000CC	1.000	.500	80
66260392727	61000MC	1.000	.500	150
9000 SERIES – DIAMOND				
3/4" Shank x 3-3/4" Overall Length				
66260308354	91000CD	1.000	.500	80

cBN HEAVY STOCK REMOVAL MANDRELS ▲

FEATURES	BENEFITS
■ Nickel alloy matrix	■ Tough, durable bond
■ Single layer of abrasive	■ Economical
■ Exposed particles	■ Aggressive cutting action
■ Super coarse abrasive grit	■ Long tool life

For heavy stock removal on jig, internal, and offhand operations on tool steels and hardened aerospace alloys.

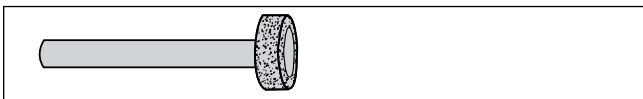

UPC #	PRODUCT #	HEAD DIAMETER	HEAD LENGTH	SHANK DIAMETER	OVERALL LENGTH	GRIT SIZE
HSR SERIES – cBN						
66260395426	HSR-1/4	1/4	1/4	3/8	3	60
66260395427+	HSR-5/16	5/16	5/16	3/8	3	60
66260395428	HSR-3/8	3/8	3/8	3/8	3	60
66260395429	HSR-1/2	1/2	3/8	3/8	3-1/2	60
66260395430 *	HSR-5/8	5/8	3/8	3/8	3-1/2	60
66260395431	HSR-3/4	3/4	3/8	3/8	3-1/2	60
66260395432	HSR-1	1	3/8	3/8	3-1/2	60

DIAMOND TAPERED HONES FOR DRAWING DIES ● ▲ ■

FEATURES	BENEFITS
■ Nickel alloy matrix	■ Tough, durable bond
■ Economical	■ Single layer of abrasive
■ Exposed particles	■ Aggressive cutting action

Used primarily for forming carbide drawing dies, but can be used for small hole honing in ceramics, fiberglass, plastics, and composite materials.

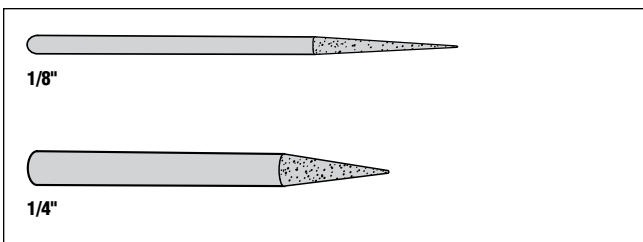

UPC #	PRODUCT #	INCLUDED ANGLE	SHANK DIAMETER	GRIT SIZE
TAPERED HONES FOR DRAWING DIES – DIAMOND				
3" Overall Length				
66260395540	TH12-6MD	6°	1/8	150
66260395541	TH12-8MD	8°	1/8	150
66260363371	TH25-12CD	12°	1/4	100
66260395542	TH12-12MD	12°	1/8	150
66260395543	TH25-12MD	12°	1/4	150
66260395544	TH25-14MD	14°	1/4	150
66260395545	TH25-16MD	16°	1/4	150

**+ AVAILABLE AS STOCK WHILE SUPPLIES LAST; THEN AVAILABLE AS NON-STOCK.
* NON-STOCK; CONTACT YOUR NORTON REPRESENTATIVE FOR CURRENT LEAD-TIMES.**

TARGET MARKET SYMBOLS:



ELECTROPLATED MICRO DRILLS AND ROUTERS

DIAMOND MICRO DRILLS ● ▲ ■

FEATURES	BENEFITS
■ Nickel alloy matrix	■ Tough, durable bond
■ Single layer of abrasive	■ Economical
■ Exposed particles	■ Aggressive cutting action

A modification of Norton mounted points, these tools are specifically designed for drilling holes in the .007" to .065" diameter range. Perfect for drilling sapphire and high density alumina ceramics for hybrid micro-circuit substrates.

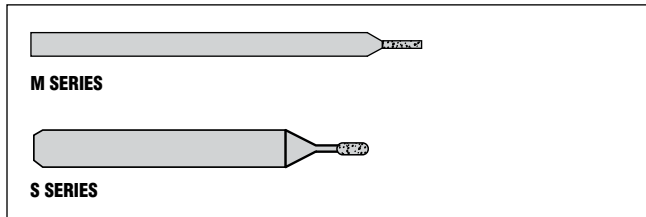

UPC #	PRODUCT #	DIAMETER INCHES	HEAD LENGTH	OVERALL LENGTH	GRIT SIZE
M-SERIES MICRO DRILLS – DIAMOND					
Shank Diameter .040" (1MM)					
66260395516	M7	.007	.028	11/16	600
66260395517	M10	.010	.049	11/16	400
66260395518	M12	.012	.056	13/16	325
66260395519	M15	.015	.077	13/16	325

CAREFULLY-SIZED, UNIFORMLY-SHAPED DIAMOND PARTICLES ARE USED ON ALL M-SERIES DRILLS.

UPC #	PRODUCT #	DIAMETER INCHES	HEAD LENGTH	OVERALL LENGTH	GRIT SIZE
S-SERIES MICRO DRILLS – DIAMOND					
1/8" Shank x 1" Overall Length					
66260395520	S16FD	.016	.062	.093	200
66260392841	S18FD	.018	.062	.125	200
66260395521	S20FD	.020	.062	.125	200
66260395522	S25FD	.025	.093	.156	200
66260395523	S30MD	.030	.093	.156	150
66260395524	S35MD	.035	.093	.187	150
66260395525	S40MD	.040	.125	.218	150
66260395526	S45CD	.045	.125	.218	100
66260395527	S50CD	.050	.125	.250	100
66260395528	S60CD	.060	.125	.312	100
66260395529	S65CD	.065	.125	.312	100

RECOMMENDED FOR ADAPTING TO ULTRASONIC DRILL HEADS.

DIAMOND ROUTERS ● ■

FEATURES	BENEFITS
■ Nickel alloy matrix	■ Tough, durable bond
■ Single layer of abrasive	■ Economical
■ Exposed particles	■ Aggressive cutting action

Used with hand operated tools, drill presses, and milling machines. Ideal for routing and reaming the highly-abrasive materials of alumina, fiberglass, plastics, and other nonmetallic composite materials.

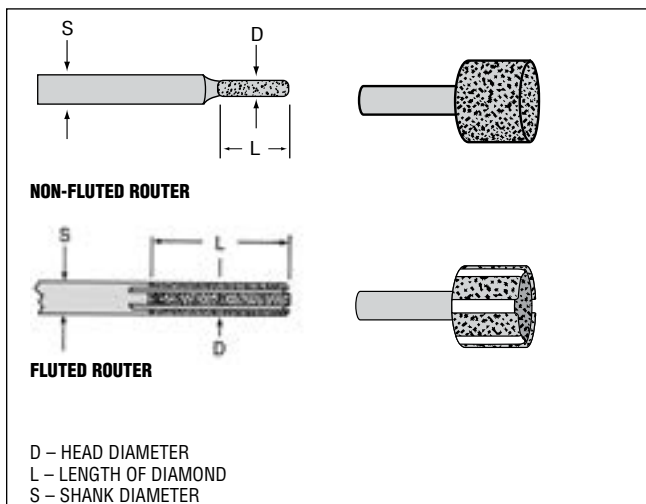

UPC #	PRODUCT #	HEAD DIAMETER	LENGTH OF DIAMOND	SHANK DIAMETER	OVERALL LENGTH	GRIT SIZE
NON-FLUTED ROUTERS – DIAMOND						
66260364305	* RNF1812CD	1/8	1/2	1/4	2-1/2	60
66260364304	+ RNF1810CD	1/8	1	1/4	2-1/2	60
66260364303	* RNF1412CD	1/4	1/2	1/4	2-1/2	40
66260364302	RNF1410CD	1/4	1	1/4	2-1/2	40
66260302707	* RNF3812CD	3/8	1/2	1/2	2-1/2	40
66260302709	* RNF3810CD	3/8	1	1/2	2-1/2	40
66260302711	* RNF1212CD	1/2	1/2	1/2	2-1/2	40
66260302712	* RNF1210CD	1/2	1	1/2	2-1/2	40
66260302714	* RNF3412CD	3/4	1/2	1/2	2-1/2	40
66260302717	* RNF3410CD	3/4	1	1/2	2-1/2	40
66260364301	* RNF1012CD	1	1/2	1/2	2-1/2	40
66260302720	* RNF1010CD	1	1	1/2	2-1/2	40
66260302721	* RNF11212CD	1-1/2	1/2	1/2	3	40
66260302725	* RNF2012CD	2	1/2	1/2	3	40
66260302728	* RNF2010CD	2	1	1/2	3	40
FLUTED ROUTERS – DIAMOND						
66260364310	RSF1812CD	1/8	1/2	1/4	2-1/2	60
66260364309	RSF1810CD	1/8	1	1/4	2-1/2	60
66260364308	RSF1412CD	1/4	1/2	1/4	2-1/2	40
66260364307	RSF1410CD	1/4	1	1/4	2-1/2	40
66260302710	* RSF3810CD	3/8	1	1/2	2-1/2	40
66260364306	* RSF1212CD	1/2	1/2	1/2	2-1/2	40
66260302713	* RSF1210CD	1/2	1	1/2	2-1/2	40
66260302715	RSF3412CD	3/4	1/2	1/2	2-1/2	40
66260302716	* RSF3410CD	3/4	1	1/2	2-1/2	40
66260302718	* RSF1012CD	1	1/2	1/2	2-1/2	40
66260302719	* RSF1010CD	1	1	1/2	2-1/2	40
66260302722	* RSF11212CD	1-1/2	1/2	1/2	3	40
66260302724	* RSF11210CD	1-1/2	1	1/2	3	40
66260302726	* RSF2012CD	2	1/2	1/2	3	40
66260302727	* RSF2010CD	2	1	1/2	3	40

**+ AVAILABLE AS STOCK WHILE SUPPLIES LAST; THEN AVAILABLE AS NON-STOCK.
* NON-STOCK; CONTACT YOUR NORTON REPRESENTATIVE FOR CURRENT LEAD-TIMES.**

TARGET MARKET SYMBOLS:



ELECTROPLATED MOUNTED CONTOUR TOOLS

DIAMOND AND cBN MOUNTED CONTOUR TOOLS ● ▲ ■

FEATURES	BENEFITS
■ Nickel alloy matrix	■ Tough, durable bond
■ Single layer of abrasive	■ Economical
■ Exposed particles	■ Aggressive cutting action
■ Variety of tool shapes available as stock	■ Satisfies most tool and die and deburring requirements

For contour grinding applications on carbide, ceramics, glass, ferrites, and many tough alloys and cements. Best suited for blending radii and deburring operations. Operating speeds: 15,000-20,000 RPM range.

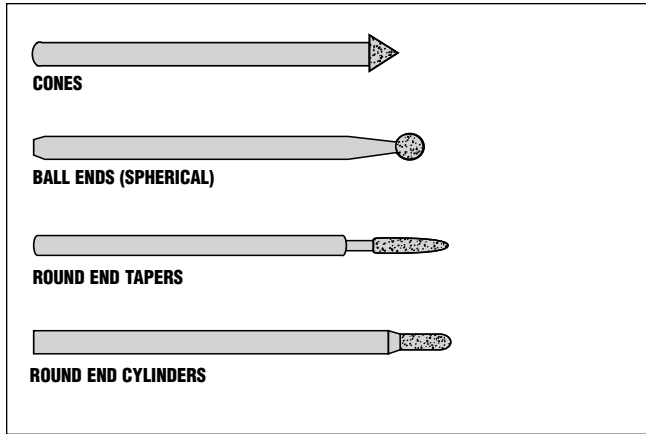

UPC #	PRODUCT #	CONE BASE DIAMETER	INCLUDED ANGLE	CONE LENGTH	GRIT SIZE
CONES – DIAMOND					
1/8" Shank x 2" Overall Length					
66260395484	C14CD	1/8	14°	1/2	100
66260395486 +	C26CD	3/16	26°	13/32	100
66260395488	C35CD	5/32	35°	1/4	100
66260395490	C60CD	11/64	60°	5/32	100
66260395492	C90CD	3/16	90°	3/32	100
CONES – cBN					
1/8" Shank x 2" Overall Length					
66260395483	C14CC	1/8	14°	1/2	100
66260395485	C26CC	3/16	26°	13/32	100
66260395487	C35CC	5/32	35°	1/4	100
66260395489	C60CC	11/64	60°	5/32	100
66260395491	C90CC	3/16	90°	3/32	100

TARGET MARKET SYMBOLS:



UPC #	PRODUCT #	BALL DIAMETER	GRIT SIZE
BALL ENDS (SPHERICAL) – DIAMOND			
1/8" Shank x 2" Overall Length			
66260395434	BE1CD	3/64	100
66260395436	BE2CD	1/16	100
66260395438	BE3CD	5/64	100
66260395440	BE4CD	3/32	100
66260395442	BE5CD	1/8	100
66260395444	BE6CD	3/16	100
66260395446 +	BE7CD	1/4	100
66260395448	BE8CD	3/8	100
66260395450	BE9CD	1/2	100
BALL ENDS (SPHERICAL) – cBN			
1/8" Shank x 2" Overall Length			
66260395433 *	BE1CC	3/64	100
66260395435 *	BE2CC	1/16	100
66260395437	BE3CC	5/64	100
66260395439	BE4CC	3/32	100
66260395441	BE5CC	1/8	100
66260395443	BE6CC	3/16	100
66260395445	BE7CC	1/4	100
66260395447 *	BE8CC	3/8	100
66260395449 *	BE9CC	1/2	100

UPC #	PRODUCT #	SMALL HEAD DIAMETER	LARGE HEAD DIAMETER	HEAD LENGTH	INC. ANGLE	GRIT SIZE
ROUND END TAPERS – DIAMOND						
1/8" Shank x 2" Overall Length						
66260395506	RT44CD	.044	.066	5/16	4°	100
66260395508 *	RT60CD	.060	.082	5/16	4°	100
66260395510	RT78CD	.078	.110	5/16	6°	100
ROUND END TAPERS – cBN						
1/8" Shank x 2" Overall Length						
66260395505 *	RT44CC	.044	.066	5/16	4°	100
66260395507 *	RT60CC	.060	.082	5/16	4°	100
66260395509	RT78CC	.078	.110	5/16	6°	100

UPC #	PRODUCT #	HEAD DIAMETER	HEAD LENGTH	GRIT SIZE
ROUND END CYLINDERS – DIAMOND				
1/8" Shank x 2" Overall Length				
66260395494	RE1CD	1/16	1/4	100
66260395496	RE2CD	5/64	1/4	100
66260395498	RE3CD	3/32	1/4	100
66260395500	RE4CD	1/8	1/4	100
66260395502	RE5CD	3/16	5/16	100
66260395504	RE6CD	1/4	5/16	100
ROUND END CYLINDERS – cBN				
1/8" Shank x 2" Overall Length				
66260395495	RE2CC	5/64	1/4	100
66260395497 *	RE3CC	3/32	1/4	100
66260395499 +	RE4CC	1/8	1/4	100
66260395501 *	RE5CC	3/16	5/16	100
66260395503 *	RE6CC	1/4	5/16	100

+ AVAILABLE AS STOCK WHILE SUPPLIES LAST; THEN AVAILABLE AS NON-STOCK.
* NON-STOCK; CONTACT YOUR NORTON REPRESENTATIVE FOR CURRENT LEAD-TIMES.

ELECTROPLATED GRINDING WHEELS AND FILES

DIAMOND TYPE 6A2C CUP WHEELS ● ▲

FEATURES	BENEFITS
■ Nickel alloy matrix	■ Tough, durable bond
■ Single layer of abrasive	■ Economical
■ Exposed particles	■ Aggressive cutting action

Extremely fast acting wheels for coarse work (100 grit) and fine finishing (200 grit) of carbide tool bits, etc.

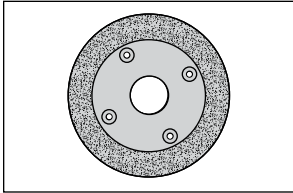

UPC #	PRODUCT #	DIMENSIONS D x T x H	DESCRIPTION	GRIT SIZE
TYPE 6A2C CUP WHEELS WITH MOUNTING HOLES				
Rim 1" – Diamond				
66260300203*	6A2CCD	6 x 7/16 x 1-1/4	6A2C Cup Wheel	100
66260300202*	6A2CFD	6 x 7/16 x 1-1/4	6A2C Cup Wheel	200
66260302135*		6 x 5/16 x 1-1/4	Back-up Plate 6"	

FOUR 9/32" HOLES ON A 3-1/4" BOLT CIRCLE.

DIAMOND TYPE 1A1 BENCH AND PEDESTAL WHEELS ● ▲

FEATURES	BENEFITS
■ Nickel alloy matrix	■ Tough, durable bond
■ Single layer of abrasive	■ Economical
■ Exposed particles	■ Aggressive cutting action
■ Bakelite core	■ Lightweight
	■ Adaptable to standard bench grinders
■ Maintains flat on O.D.	■ Eliminates down time for dressing

Ideal for off-hand grinding. These wheels stay flat without dressing for accurate tool edges. Grind carbide, ceramic and other materials more cost effectively than with conventional silicon carbide abrasive wheels. Available in two grit sizes; 100 grit for roughing and 200 grit for finishing.

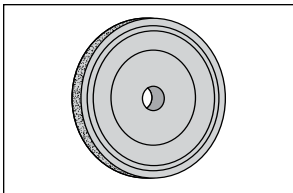

UPC #	PRODUCT #	DIMENSIONS D x T x H	MAX. RPM	GRIT SIZE
TYPE 1A1 BENCH AND PEDESTAL WHEELS – DIAMOND				
66260302087*	A1PG-CD	6 x 1 x 1	7,635	100
66260302086*	A1PG-FD	6 x 1 x 1	7,635	200

1/2", 5/8", 3/4" AND 7/8" CENTER HOLE REDUCING BUSHINGS ARE INCLUDED.

TARGET MARKET SYMBOLS:



DIAMOND MACHINE FILES ● ▲

FEATURES	BENEFITS
■ Nickel alloy matrix	■ Tough, durable bond
■ Single layer of abrasive	■ Economical
■ Exposed particles	■ Aggressive cutting action

For use in reciprocating hand profiling machines. Ideal for reworking and finishing carbide dies and molds, blending radii, and deburring and cleaning slots and grooves.

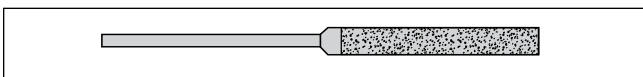

UPC #	PRODUCT #	DIMENSIONS	ABRASIVE LOCATION	GRIT SIZE
MACHINE FILES – DIAMOND (CONT'D)				
5/8" Diamond Length, 1/8" Shank, 2" Overall Length				
66260395589	3FCD	.120 x .040		100
66260395590	4FCD	.157 x .040		100
66260395591	5FCD	.203 x .078		100
66260395592	6FCD	.120 x .040		100
66260395593	1CCD	.098 x .196		100
66260395594	2CCD	.120 x .250		100
66260395596	3TCD	.127 side		100
66260395598	1RCD	.042 diam.		100
66260395599	2RCD	.080 diam.		100
66260395600	3RCD	.127 diam.		100
66260395601	4RCD	.157 diam.		100
66260395602 *	1HRCD	.040 radius		100

**+ AVAILABLE AS STOCK WHILE SUPPLIES LAST; THEN AVAILABLE AS NON-STOCK.
* NON-STOCK; CONTACT YOUR NORTON REPRESENTATIVE FOR CURRENT LEAD-TIMES.**

UPC #	PRODUCT #	DIMENSIONS	ABRASIVE LOCATION	GRIT SIZE
MACHINE FILES – DIAMOND				
5/8" Diamond Length, 1/8" Shank, 2" Overall Length				
66260395585	1ECD	.020 x .125		100
66260395586	2ECD	.030 x .125		100
66260395587	3ECD	.040 x .125		100
66260395588 *	2FCD	.079 x .040		100

CONTINUED

ELECTROPLATED FILES

DIAMOND HAND FILES ● ▲

FEATURES	BENEFITS
■ Nickel alloy matrix	■ Tough, durable bond
■ Single layer of abrasive	■ Economical
■ Exposed particles	■ Aggressive cutting action

Indispensable aid for the toolroom. All purpose hand-held tool useful for deburring, notching, dressing, and honing hard, brittle materials.



UPC #	PRODUCT #	DIMENSIONS	ABRASIVE LOCATION	GRIT SIZE
HAND FILES – DIAMOND				
6" Overall Length, 1-1/2" Diamond Length				
66260395605	DF1CD	1/8 x 1/8		100
66260392842 +	DF1FD	1/8 x 1/8		200
66260395606	DF2CD	1/8 x 1/4		100

CONTINUED

UPC #	PRODUCT #	DIMENSIONS	ABRASIVE LOCATION	GRIT SIZE
HAND FILES – DIAMOND (CONT'D)				
6" Overall Length, 1-1/2" Diamond Length				
66260392843	DF2FD	1/8 x 1/4		200
66260395607	DF2WCD	1/8 x 1/4		100
66260395608	DF3CD	1/8 x 3/8		100
66260392844	DF3FD	1/8 x 3/8		200
66260395609	DF3WCD	1/8 x 3/8		100
66260364241	DF3SCD	1/8 x 1/2		100
66260395611	DF4CD	1/8		100
66260392845 *	DF4FD	1/8		200
66260300134	DF4WCD	1/4		100
66260395613	DF5CD	1/8		100
66260392846	DF5FD	1/8		200
66260395614	DF5WCD	1/4		100
66260395615	DF6CD	1/8		100
66260392847 *	DF6FD	1/8		200

DIAMOND NEEDLE FILES ● ▲

FEATURES	BENEFITS
■ Nickel alloy matrix	■ Tough, durable bond
■ Single layer of abrasive	■ Economical
■ Exposed particles	■ Aggressive cutting action

Indispensable aid for the toolroom. An all purpose hand-held tool, useful for deburring, notching, dressing, and honing hard, brittle materials.

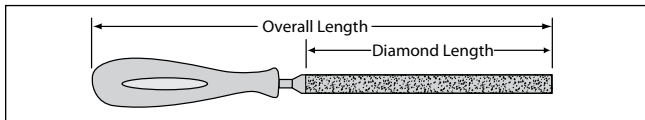

UPC #	PRODUCT #	DIMENSIONS	ABRASIVE LOCATION	SHAPE	GRIT SIZE
NEEDLE FILES – DIAMOND					
4-1/4" Diamond Length, 8-1/2" Overall Length					
66260302432	LNF2CD	.400 x .100		Equaling	100
66260305611	LNF2FD	.400 x .100		Equaling	200
66260302898	LNF3CD	.45 x .150		Half Round	100
66260305612	LNF3FD	.485 x .150		Half Round	200
2-3/4" Diamond Length, 5-3/4" Overall Length, With Handle					
66260391729	1571	.055 x .190		Flat	100
66260391730	1572	.075 x .210		Half Round	100
66260391731	1573	.145 x .145		Triangle	100
66260391732	1574	.100 x .100		Square	100
66260391733	1575	.120		Round	100
66260391734	1576	.055 x .190		Pointed Flat	100
3" Diamond Length, 5-1/2" Overall Length, With Handle					
66260395575	NF1FD	.150 x .105		Oval	200
66260395576	NF2FD	.218 x .072		Half Round	200
66260395577	NF3FD	.205 x .058		Equaling	200
66260395578	NF4FD	.096 x .096		Square	200

CONTINUED

UPC #	PRODUCT #	DIMENSIONS	ABRASIVE LOCATION	SHAPE	GRIT SIZE
NEEDLE FILES – DIAMOND (CONT'D)					
3" Diamond Length, 5-1/2" Overall Length, With Handle					
66260395579	NF5FD	.138 x .138		Triangle	200
66260395580	NF6FD	.118		Round	200
66260395581+	NF7FD	.197 x .088		Crossing	200
66260395582+	NF8FD	.205 x .067		Barrette	200

UPC #	PRODUCT #	GRIT SIZE
NFK-6 NEEDLE FILE KIT – DIAMOND		
66260364008	NFK-6	contains one each of the following:
	NF1FD	200
	NF2FD	200
	NF3FD	200
	NF4FD	200
	NF5FD	200
	NF6FD	200

UPC #	PRODUCT #	GRIT SIZE
DFS-6 DIE FILE KIT – DIAMOND		
66260391830	DFS-6	contains one each of the following:
	1571	100
	1572	100
	1573	100
	1574	100
	1575	100
	1576	100

NEEDLE FILE SHAPE AND APPLICATION KEY:

- Barrette:** A triangle with diamond on the bottom side only
- Crossing:** Elongated oval, with more pointed ends than an oval file; has diamonds all around
- Equaling:** A rectangle with diamond on all four sides; ideal for filing both sides of an ID simultaneously
- Pointed Flat:** A cone with a flat top with diamond on the sides of the cone

TARGET MARKET SYMBOLS:



+ AVAILABLE AS STOCK WHILE SUPPLIES LAST; THEN AVAILABLE AS NON-STOCK.
* NON-STOCK; CONTACT YOUR NORTON REPRESENTATIVE FOR CURRENT LEAD-TIMES.

ELECTROPLATED DRILLS

DIAMOND CORE DRILLS ● ■

FEATURES	BENEFITS
■ Nickel alloy matrix	■ Tough, durable bond
■ Single layer of abrasive	■ Economical
■ Exposed particles	■ Aggressive cutting action

High performance on glass and ceramic applications while providing fast, reliable cutting. Submersed drilling is highly recommended for optimum operating performance.



UPC #	PRODUCT #	OUTER DIAMETER	INNER DIAMETER	GRIT SIZE
CORE DRILLS – DIAMOND				
Straight Tube Type, 2" Overall Length				
66260395530	A1MD	1/16	.023	150
66260395531	A2MD	3/32	.048	150
66260395532	A3MD	1/8	.075	150
66260395533	A4MD	5/32	.110	150
66260395534	A5CD	3/16	.140	100
66260395535	A6CD	1/4	.195	100
66260395536	A7CD	5/16	.255	100
66260395537	A8CD	3/8	.325	100
66260395538 *	A9CD	7/16	.373	80
66260395539 +	A10CD	1/2	.398	80

DIAMOND MOUNTED CORE DRILLS ● ■

FEATURES	BENEFITS
■ Nickel alloy matrix	■ Tough, durable bond
■ Single layer of abrasive	■ Economical
■ Exposed particles	■ Aggressive cutting action
■ Removable pilot (bulb-like extension)	■ Provides added stability
	■ Ensures smooth drilling with less wobbling
■ 1/8" wrap: additional 1/8" of electroplated diamond on the blade core	■ Increases life of blade on deep cuts, reduces binding and grinding on the core

High performance results on glass and ceramic applications.

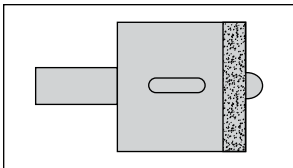

UPC #	PRODUCT #	OUTER DIAMETER	PILOT DIAMETER	GRIT SIZE
MOUNTED CORE DRILLS – DIAMOND				
1/8" Wrap, 3/8" Shank Diameter, 3.45" Overall Length				
66260392850	CD.750	3/4	1/4	40
66260392854 *	CD2.000	2	1/4	40

PILOTS ARE REMOVABLE.

DIAMOND TWIST DRILLS ● ■

FEATURES	BENEFITS
■ Nickel alloy matrix	■ Tough, durable bond
■ Single layer of abrasive	■ Economical
■ Exposed particles	■ Aggressive cutting action

Recommended for precision drilling on circuit boards containing fiberglass, nylon, and similar tough, abrasive materials. Diamond twist drills are also useful for drilling plastics and resin composites and have been successful in drilling soft ductile materials as well as "green" carbide. Operating procedures are similar to those of standard twist drills.

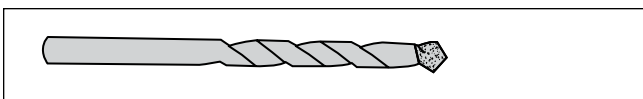

UPC #	PRODUCT #	DRILL DIAMETER	DRILL LENGTH	GRIT SIZE
TWIST DRILLS – DIAMOND				
66260395549	TW-1/16	1/16	1-3/4	100
66260395550	TW-1/8	1/8	2-3/4	100
66260395551	TW-1/4	1/4	4	100
66260395552	TW-3/8	3/8	5	100

DIAMETER TOLERANCE EQUALS + OR - 1/64.

**+ AVAILABLE AS STOCK WHILE SUPPLIES LAST; THEN AVAILABLE AS NON-STOCK.
* NON-STOCK; CONTACT YOUR NORTON REPRESENTATIVE FOR CURRENT LEAD-TIMES.**

TARGET MARKET SYMBOLS:



ELECTROPLATED SAW BLADES

DIAMOND CONTINUOUS RIM CUT-OFF SAW BLADES ■

FEATURES	BENEFITS
■ Nickel alloy matrix	■ Tough, durable bond
■ Single layer of abrasive	■ Economical
■ Exposed particles	■ Aggressive cutting action

Ideal for cutting-off highly-abrasive materials such as alumina, fiberglass, plastics, and other nonmetallic composite materials.

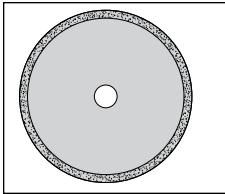

Additional Diamond Slotted and Continuous Rim Cut-off Saw Blades, with extended wraps to avoid binding, are available as made-to-order products. Please contact your Norton representative.

UPC #	PRODUCT #	DIAM.	OVERALL THICKNESS	HOLE SIZE	GRIT SIZE
CONTINUOUS RIM CUT-OFF SAW BLADES – DIAMOND					
66260301990	DS2062-250	2	1/16	1/4	40
66260391474	DS2094-250	2	3/32	1/4	40
66260391473	DS3094-250	3	3/32	1/4	40
66260363036	DS3094-375	3	3/32	3/8	40
66260395554	DS4094-500	4	3/32	1/2	40
66260300197	DS4094-750	4	3/32	3/4	40
66260312207 *	DS5094-500	5	3/32	1/2	40
66260395555 *	DS6094-500	6	3/32	1/2	40
66260395556 *	DS7062-500	7	1/16	1/2	40
66260395557	DS8094-625	8	3/32	5/8	40
66260391464 *	DS10125-625	10	1/8	5/8	40

DIAMOND SLOTTED CUT-OFF SAW BLADES ■

FEATURES	BENEFITS
■ Nickel alloy matrix	■ Tough, durable bond
■ Single layer of abrasive	■ Economical
■ Exposed particles	■ Aggressive cutting action
■ 3/4" wrap: additional 3/4" of electroplated diamond on the blade core	■ Increases life of blade on deep cuts, reduces binding and grinding on the core

Ideal for cutting-off highly abrasive materials such as alumina, fiberglass, plastics, and other nonmetallic composite materials.

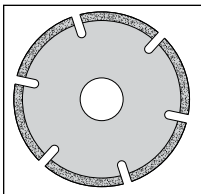

UPC #	PRODUCT #	DIAM.	OVERALL THICKNESS	HOLE SIZE	GRIT SIZE
SLOTTED CUT-OFF SAW BLADES – DIAMOND					
66260301989	DSS2062-250	2	1/16	1/4	40
66260364258	DSS3094-250	3	3/32	1/4	40
66260363015	DSS4094-375	4	3/32	3/8	40
66260395559	DSS4094-500	4	3/32	1/2	40
66260300360 +	DSS4094-750	4	3/32	3/4	40
66260395560	DSS6094-500	6	3/32	1/2	40
66260395561 *	DSS8094-500	8	3/32	1/2	40
66260362981	DSS10125-625	10	1/8	5/8	40
66260395563	DSS12125-500	12	1/8	1/2	40
66260362985 *	DSS12125-1	12	1/8	1	40
66260364253	DSS14156-500	14	5/32	1/2	40
66260362989	DSS14156-1	14	5/32	1	40
66260395565	DSS16156-1	16	5/32	1	40
66260395566	DSS18156-1	18	5/32	1	40
66260395567 *	DSS20156-1	20	5/32	1	40
SLOTTED CUT-OFF SAW BLADES WITH 3/4" WRAP – DIAMOND					
66260313422 *	DSSW4094-500	4	3/32	1/2	40
66260313423	DSSW4094-750	4	3/32	3/4	40
66260313433 *	DSSW5094-750	5	3/32	3/4	40

DIAMOND MOUNTED SAW BLADES ■

FEATURES	BENEFITS
■ Nickel alloy matrix	■ Tough, durable bond
■ Single layer of abrasive	■ Economical
■ Exposed particles	■ Aggressive cutting action

Ideal for cutting off highly abrasive materials such as alumina, fiberglass, plastics, and other nonmetallic composite materials.

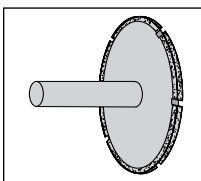

UPC #	PRODUCT #	DIAM.	OVERALL THICKNESS	HOLE SIZE	GRIT SIZE
MOUNTED SAW BLADES – DIAMOND					
2" Overall Length					
66260395422	MDS1CD	1	3/32	1/4	40
66260395423	MDS1-1/2CD	1-1/2	3/32	1/4	40
66260395424	MDS2CD	2	3/32	3/8	40

TARGET MARKET SYMBOLS: ● CERAMICS ▲ TOOL & DIE ■ COMPOSITES

+ AVAILABLE AS STOCK WHILE SUPPLIES LAST; THEN AVAILABLE AS NON-STOCK.
* NON-STOCK; CONTACT YOUR NORTON REPRESENTATIVE FOR CURRENT LEAD-TIMES.

NORTON DIAMOND LAPPING COMPOUND

DIAMOND LAPPING COMPOUND ● ▲

FEATURES	BENEFITS
■ Diamond powders uniformly distributed in a liquid vehicle	■ Aggressive polishing
■ Easy to use plastic syringe	■ Consistent part quality
	■ Quick clean-up

Performs on all materials – hard and soft. Excellent for mold, die and tool polishing, polishing to final tolerance of ceramic parts, initial charging of lapping plates and discs, and other processes that require mirror finish and close tolerance performance. Use oil soluble when solvent is used for clean-up, and water soluble when soap/water is used for clean-up.



PRODUCT #	MICRON GRADE	COLOR	UPC #
DIAMOND COMPOUND – WATER SOLUBLE			
5 Gram Syringes			
5PS1/4WSSTD	1/4 Ultra Fine	Gray	66260300362
5PS1/2WSSTD	1/2 Ultra Fine	Lt. Gray	66260300417
5PS1WSSTD	1 Ultra Fine	Ivory	66260300368
5PS3WSSTD	3 Super Fine	Yellow	66260300667
5PS6WSSTD	6 Super Fine	Orange	66260300372
5PS9WSSTD	9 Super Fine	Green	66260300375
5PS12WSSTD	12 Super Fine	Aqua	66260300376
5PS15WSSTD	15 Fine	Blue	66260300379
5PS20WSSTD	20 Fine	Auburn	66260300381 *
5PS30WSSTD	30 Fine	Red	66260300383
5PS45WSSTD	45 Fine	Brown	66260300384
5PS60WSSTD	60 Fine	Purple	66260300388
5PS90WSSTD	90 Fine	Black	66260300389
18 Gram Syringes			
18PS1/4WSSTD	1/4 Ultra Fine	Gray	66260300392
18PS1/2WSSTD	1/2 Ultra Fine	Lt. Gray	66260300394
18PS1WSSTD	1 Ultra Fine	Ivory	66260300396
18PS3WSSTD	3 Super Fine	Yellow	66260300398
18PS6WSSTD	6 Super Fine	Orange	66260300400
18PS9WSSTD	9 Super Fine	Green	66260300402
18PS12WSSTD	12 Super Fine	Aqua	66260300404 *
18PS15WSSTD	15 Fine	Blue	66260300406
18PS20WSSTD	20 Fine	Auburn	66260300408
18PS30WSSTD	30 Fine	Red	66260300410 *
18PS45WSSTD	45 Fine	Brown	66260300412 *
18PS60WSSTD	60 Fine	Purple	66260300414 *
18PS90WSSTD	90 Fine	Black	66260300416 *
Polishing Kit	Kit Includes: four 5 gram syringes of diamond paste: 3u, 6u, 15u, 30u; 4 pieces of substrate; 1 bottle of lubricant		07660702462 *

+ AVAILABLE AS STOCK WHILE SUPPLIES LAST; THEN AVAILABLE AS NON-STOCK.
* NON-STOCK; CONTACT YOUR NORTON REPRESENTATIVE FOR CURRENT LEAD-TIMES.

PRODUCT #	MICRON GRADE	COLOR	UPC #
DIAMOND COMPOUND – OIL SOLUBLE			
5 Gram Syringes			
5PS1/4OSSTD	1/4 UltraFine	Gray	61463691123 *
5PS1/2OSSTD	1/2 UltraFine	Lt. Gray	66260300363
5PS1OSSTD	1 UltraFine	Ivory	61463691133
5PS3OSSTD	3 Super Fine	Yellow	61463691138
5PS6OSSTD	6 Super Fine	Orange	61463691143
5PS9OSSTD	9 Super Fine	Green	61463691148
5PS12OSSTD	12 Super Fine	Aqua	66260300377 *
5PS15OSSTD	15 Fine	Blue	61463691153
5PS20OSSTD	20 Fine	Auburn	66260300380 *
5PS30OSSTD	30 Fine	Red	61463691158
5PS45OSSTD	45 Fine	Brown	61463691163
5PS60OSSTD	60 Fine	Purple	66260300386
5PS90OSSTD	90 Fine	Black	66260300390
18 Gram Syringes			
18PS1/4OSSTD	1/4 UltraFine	Gray	66260300391
18PS1/2OSSTD	1/2 UltraFine	Lt. Gray	66260300393 *
18PS1OSSTD	1 UltraFine	Ivory	61463691134 *
18PS3OSSTD	3 Super Fine	Yellow	61463691139
18PS6OSSTD	6 Super Fine	Orange	66260300399
18PS9OSSTD	9 Super Fine	Green	61463691149 *
18PS12OSSTD	12 Super Fine	Aqua	66260300403 *
18PS15OSSTD	15 Fine	Blue	61463691154
18PS20OSSTD	20 Fine	Auburn	66260300407
18PS30OSSTD	30 Fine	Red	66260300409
18PS45OSSTD	45 Fine	Brown	61463691164 *
18PS60OSSTD	60 Fine	Purple	66260300413
18PS90OSSTD	90 Fine	Black	66260300415

TARGET MARKET SYMBOLS: ● ▲ ■
CERAMICS TOOL & DIE COMPOSITES

SPECcheck

DIAMOND COMPOUND APPLICATION GUIDE

APPLICATION	MICRON GRADE	MICRON RANGE	MESH SIZE EQUIVALENT	COLOR	CONC.
ULTRA FINE	1/4	(0-1/2)	100,000	Gray	Std.
Applying finest finishes on metals and ceramics	1/2	(0-1)	60,000	Lt. Gray	Std.
	1	(0-2)	14,000	Ivory	Std.
SUPER FINE	3	(2-4)	8,000	Yellow	Std.
Final finishing for dies, molds, seals, most applications (RMS 4-12)	6	(4-8)	3,000	Orange	Std.
	9	(8-12)	1,800	Green	Std.
	12	(9-15)	1,500	Aqua	Std.
FINE FINISH	15	(12-22)	1,200	Blue	Std.
Preparatory lapping (RMS 12-20)	20	(15-25)	800	Auburn	Std.
	30	(22-36)	600	Red	Std.
	45	(36-45)	325	Brown	Std.
	60	(54-80)	230	Purple	Std.
	90	(80-100)	170	Black	Std.

MARKING SYSTEM

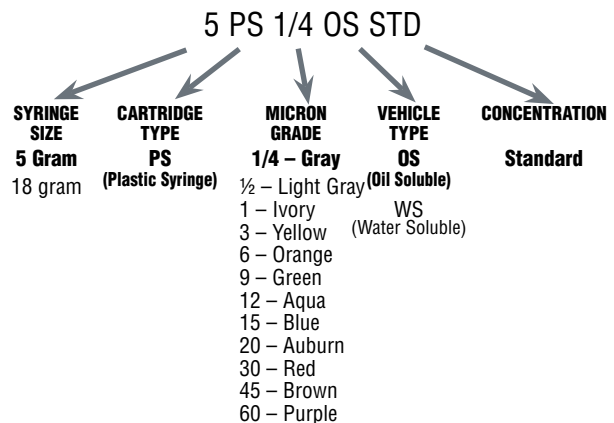

TECHtip

AVOID GRINDING STEEL

- Avoid steel when grinding with diamond wheels. Keep the amount of steel ground to an absolute minimum.
- On brazed tools, use aluminum oxide wheel to back off the steel shank.
- A high lubricity grinding fluid should be used.
- For some steels, an armored (AMD) diamond wheel may prove most economical.

USE RIGID WORK SUPPORT

- All workpieces should be supported firmly during the grinding process. Any amount of vibration will cause wheel wear and produce chatter or wave marks on the ground surface.
- On work ground between centers, centerholds should be properly prepared.
- Minimize work overhang.
- If the ground work is supported by a work finger, ensure the finger is strong enough to provide vibration-free support.

COOLANT – GRIND WET

- Diamond wheels should be used with a full flood coolant properly directed toward the grinding zone. Water with a rust inhibitor is recommended.
- Vitrified diamond wheels should be used only with a coolant.
- When flood application can't be used, try mist or spray application.
 - Use compressed air to "atomize" water or soluble oil.
 - Direct the spray at the grinding zone to help dissipate heat and prevent heat damage to the work.

AVOID EXCESSIVE FEEDS

- Excessive feeds will result in premature wheel wear. Excessive feed rates are characterized by:
 - A hard grinding sound
 - Chatter
 - Burn
 - High wheel wear rate
 - Vibration

SPECcheck

TROUBLESHOOTING GUIDE – DRY GRINDING

PROBLEM	POSSIBLE CAUSES	SUGGESTED CORRECTION
Burning (excessive heat)	Wheel loaded or glazed Excessive feed rate Wheel too durable	Dress wheel with a dressing stick Reduce infeed of wheel or workpiece Use freer cutting specification or slow down wheel speed
Poor finish	Grit size too coarse Excessive feed rate	Select a finer grit size Reduce infeed of wheel or workpiece
Chatter	Wheel out of truth	True wheel; ensure it is not slipping on mount (See "Mounting, Truing and Dressing Guide")

TROUBLESHOOTING GUIDE – WET GRINDING

PROBLEM	POSSIBLE CAUSES	SUGGESTED CORRECTION
Burning (excessive heat)	Wheel glazed or loaded Poor coolant placement Excessive material removal rate	Re-dress wheel Apply coolant directly to wheel/workpiece interface Reduce downfeed and/or crossfeed
Poor finish	Excessive dressing Grit size too coarse Poor coolant flow or location	Use lighter dressing pressure Stop dressing as soon as wheel starts to consume stick rapidly Select a finer grit size Apply heavy flood so it reaches wheel/work interface
Chatter	Wheel out of truth	True wheel; ensure it is not slipping on mount
Wheel will not cut	Glazed by truing Wheel loaded	Dress lightly until wheel opens up Dress lightly until wheel opens up Increase coolant flow to keep wheel surface clean Never run wheel with coolant turned off
Slow cutting	Low feeds and speeds	Increase feed rate; increase wheel speed (Do not exceed wheel MOS)
Short wheel life	Incorrect coolant flow Low wheel speed Excessive dressing Wheel too soft or too hard	Apply coolant to flood wheel/work surface Increase wheel speed (observe maximum operating speed) Use lighter dressing pressure Change grit or grade; use higher concentration

MATERIAL HARDNESS SCALE

Superabrasives is a term used to describe those abrasives of extreme hardness which produce outstanding results when properly used on specific applications. The following chart provides a hardness comparison (Knoop Hardness Scale) between diamond and cBN superabrasives, aluminum oxide and silicon carbide standard abrasives, and some common materials these abrasives are used to grind.

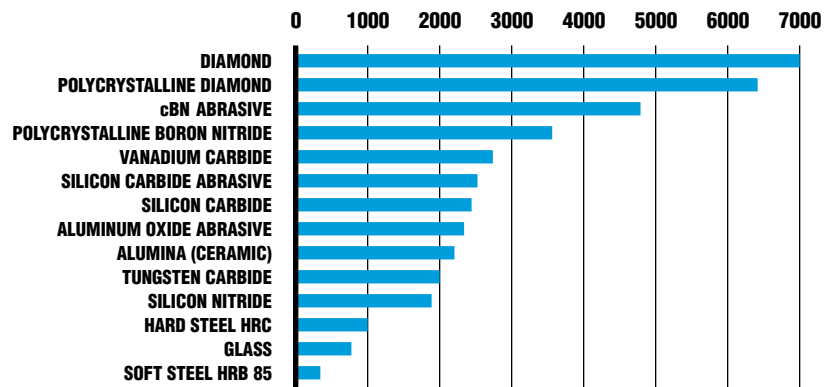

DECIMAL AND METRIC EQUIVALENTS OF COMMON FRACTIONS

FRACTIONS OF AN INCH	DECIMALS OF AN INCH	MILLIMETERS
1/64	.0156	0.397
1/32	.0313	0.794
3/64	.0469	1.191
1/16	.0625	1.588
5/64	.0781	1.985
3/32	.0938	2.381
7/64	.1094	2.778
1/8	.1250	3.175
9/64	.1406	3.572
5/32	.1563	3.969
11/64	.1719	4.366
3/16	.1875	4.762
13/64	.2031	5.159
7/32	.2188	5.556
15/64	.2344	5.953
1/4	.2500	6.350
17/64	.2656	6.747
9/32	.2813	7.144
19/64	.2969	7.541
5/16	.3135	7.937
21/64	.3281	8.334
11/32	.3438	8.731
23/64	.3594	9.128
3/8	.3750	9.525
25/64	.3906	9.922
13/32	.4063	10.319
27/64	.4219	10.716
7/16	.4375	11.112
29/64	.4531	11.509
15/32	.4688	11.906
31/64	.4844	12.303
1/2	.5000	12.700
33/64	.5156	13.097
17/32	.5313	13.494
35/64	.5469	13.891
9/16	.5625	14.287
37/64	.5781	14.684
19/32	.5938	15.081
39/64	.6094	15.478
5/8	.6250	15.875
41/64	.6406	16.272
21/32	.6563	16.688
43/64	.6719	17.085
11/16	.6875	17.462
45/64	.7031	17.859
23/32	.7188	18.256
47/64	.7344	18.653
3/4	.7500	19.050
49/64	.7645	19.447
25/32	.7813	19.843
51/64	.7969	20.240
13/16	.8125	20.637
53/64	.8281	21.034
27/32	.8438	21.430
55/64	.8594	21.827
7/8	.8750	22.224
57/64	.8906	22.621
29/32	.9063	23.018
59/64	.9219	23.415
15/16	.9375	23.812
61/64	.9531	24.209
31/32	.9688	24.606
63/64	.9844	25.003
1	1.0000	25.400

EXPECTED SURFACE FINISH BY GRIT SIZE FOR RESIN BOND

Use these charts as guides only. Surface finish is affected by several variables: machine type and condition, type of material ground, coolant, wheel speed, bond system, etc.

Diamond

GRIT SIZE	EXPECTED FINISH MICRO INCH AA	MAXIMUM DEPTH OF CUT PER PASS FOR GRIT SIZE
T00	24 to 32	0.001" to 0.002"
120	16 to 18	0.001" to 0.002"
150	14 to 16	0.001" to 0.002"
180	12 to 14	0.0007" to 0.001"
220	10 to 12	0.0007" to 0.001"
320	8	0.0004" to 0.0006"
400	7 to 8	0.0003" to 0.0005"

cBN

GRIT SIZE	EXPECTED FINISH WITH OSCILLATION	EXPECTED FINISH PLUNGE
T00	35 – 40	40 – 45
120	30 – 35	35 – 40
150	25 – 30	30 – 35
180	20 – 25	25 – 30
220	15 – 20	20 – 25
320	10 – 15	15 – 20
400	4 – 8	5 – 10

REFER TO ELECTROPLATED GENERAL INFORMATION FOR FINISHES BY GRIT SIZE FOR ELECTROPLATED WHEELS.

RECOMMENDED WHEEL SPEEDS FOR DIAMOND AND cBN WHEELS

WET GRINDING

	CUP WHEELS	PERIPHERAL WHEELS
DIAMOND GRINDING WHEELS		
	11V9, 12V9, 15V9, etc.	1A1, 1V1, 1A1R, etc.
Resin Bond Wheels	4921 to 7874 SFPM 25 to 40 m/s	4921 to 7874 SFPM 25 to 40 m/s
Metal Bond Wheels		3937 to 5906 SFPM 20 to 30 m/s
Vitrified Bond Wheels	2953 to 5906 SFPM 15 to 30 m/s	2953 to 5906 SFPM 15 to 30 m/s

cBN GRINDING WHEELS

Resin Bond Wheels	5906 to 9843 SFPM 30 to 50 m/s	5906 to 9843 SFPM 30 to 50 m/s
-------------------	-----------------------------------	-----------------------------------

DRY GRINDING

	CUP WHEELS	PERIPHERAL WHEELS
DIAMOND GRINDING WHEELS		
	11V9, 12V9, 15V9, etc.	1A1, 1V1, 1A1R, etc.
Resin Bond Wheels	2756 to 3543 SFPM 14 to 18 m/s	2756 to 3543 SFPM 14 to 18 m/s
cBN GRINDING WHEELS		
Resin Bond Wheels	2953 to 5906 SFPM 15 to 30 m/s	2953 to 5906 SFPM 15 to 30 m/s

NOTE: THESE ARE NOT THE MAXIMUM OPERATING SPEEDS (MOS). CONSULT ANSI B7.1 OR CONTACT YOUR NORTON REPRESENTATIVE FOR MOS.

WHEEL SPEED CALCULATION:

To convert m/s to SFPM:	Multiply M/S x 196.85 = SFPM
To convert SFPM to M/S:	Divide SFPM by 196.85 = M/S
To convert RPM to SFPM:	Multiply wheel diameter in inches x RPM x 0.262

M/S = METERS/SECOND RPM = REVOLUTIONS PER MINUTE SFPM = SURFACE FEET PER MINUTE

CONVERSION TABLE – WHEEL SPEEDS

Revolutions Per Minute for various diameters of grinding wheels – to give Surface Speed in Feet Per Minute as indicated

(for wheel marking purposes the calculated RPM figures listed below are rounded off to the next 5)

DIAMETER OF WHEEL IN INCHES	SURFACE SPEED IN FEET PER MINUTE (SFPFM)																				
	4,000	4,500	5,000	5,500	6,000	6,500	7,000	7,500	8,000	8,500	9,000	9,500	10,000	12,000	14,200	16,000	16,500	17,000	19,685	20,000	
1	15,279	17,189	19,098	21,008	22,918	24,828	26,737	28,647	30,558	32,467	34,377	36,287	38,196	45,836	47,745	54,240	61,116	63,025	64,935	75,190	76,395
2	7,639	8,594	9,549	10,504	11,459	12,414	13,368	14,328	15,278	16,238	17,188	18,143	19,098	22,918	23,875	27,120	30,558	31,510	32,465	37,595	38,195
3	5,093	5,729	6,366	7,003	7,639	8,276	8,913	9,549	10,186	10,822	11,459	12,096	12,732	15,278	15,915	18,080	20,372	21,010	21,645	25,065	25,465
4	3,820	4,297	4,775	5,252	5,729	6,207	6,685	7,162	7,640	8,116	8,595	9,072	9,549	11,459	11,940	13,560	15,278	15,755	16,235	18,800	19,100
5	3,056	3,438	3,820	4,202	4,584	4,966	5,348	5,730	6,112	6,494	6,876	7,258	7,640	9,168	9,550	10,850	12,224	12,605	12,985	15,040	15,280
6	2,546	2,865	3,183	3,501	3,820	4,138	4,456	4,775	5,092	5,411	5,729	6,048	6,366	7,639	7,960	9,040	10,186	10,505	10,820	12,530	12,730
7	2,183	2,455	2,728	3,001	3,274	3,547	3,820	4,092	4,366	4,638	4,911	5,183	5,456	6,548	6,820	7,750	8,732	9,005	9,275	10,740	10,915
8	1,910	2,148	2,387	2,626	2,865	3,103	3,342	3,580	3,820	4,058	4,297	4,535	4,775	5,729	5,970	6,780	7,640	7,880	8,115	9,400	9,550
9	1,698	1,910	2,122	2,334	2,546	2,758	2,970	3,182	3,396	3,606	3,820	4,032	4,244	5,092	5,305	6,030	6,792	7,000	7,215	8,355	8,490
10	1,528	1,719	1,910	2,101	2,292	2,483	2,674	2,865	3,056	3,247	3,438	3,629	3,820	4,584	4,775	5,425	6,112	6,300	6,495	7,520	7,640
12	1,273	1,432	1,591	1,751	1,910	2,069	2,228	2,386	2,546	2,705	2,864	3,023	3,183	3,820	3,980	4,520	5,092	5,250	5,410	6,265	6,365
14	1,091	1,228	1,364	1,500	1,637	1,773	1,910	2,046	2,182	2,319	2,455	2,592	2,728	3,274	3,410	3,875	4,366	4,500	4,640	5,370	5,455
16	955	1,074	1,194	1,313	1,432	1,552	1,672	1,791	1,910	2,029	2,149	2,268	2,387	2,865	2,985	3,390	3,820	3,940	4,060	4,700	4,775
18	849	955	1,061	1,167	1,273	1,379	1,485	1,591	1,698	1,803	1,910	2,016	2,122	2,546	2,655	3,015	3,396	3,500	3,605	4,175	4,245
20	764	859	955	1,050	1,146	1,241	1,337	1,432	1,528	1,623	1,719	1,814	1,910	2,292	2,390	2,715	3,056	3,150	3,245	3,760	3,820
22	694	781	868	955	1,042	1,128	1,215	1,302	1,388	1,476	1,562	1,649	1,736	2,084	2,170	2,465	2,776	2,865	2,950	3,420	3,470
24	637	716	796	875	955	1,034	1,115	1,194	1,274	1,353	1,433	1,512	1,591	1,910	1,990	2,260	2,546	2,625	2,705	3,135	3,185
26	588	661	734	808	881	955	1,028	1,101	1,176	1,248	1,322	1,395	1,468	1,762	1,840	2,090	2,352	2,425	2,495	2,890	2,940
28	546	614	682	750	818	887	955	1,023	1,092	1,159	1,228	1,296	1,364	1,637	1,705	1,940	2,182	2,250	2,320	2,685	2,730
30	509	573	637	700	764	828	891	955	1,018	1,082	1,146	1,210	1,274	1,528	1,595	1,810	2,056	2,100	2,165	2,505	2,545
32	477	537	597	656	716	776	836	895	954	1,014	1,074	1,134	1,194	1,432	1,495	1,695	1,910	1,970	2,030	2,350	2,385
34	449	505	562	618	674	730	786	843	898	955	1,011	1,067	1,124	1,348	1,405	1,595	1,796	1,855	1,910	2,210	2,245
36	424	477	530	583	637	690	742	795	848	902	954	1,007	1,061	1,273	1,330	1,510	1,698	1,750	1,805	2,090	2,120
38	402	452	503	553	603	653	704	754	804	854	904	955	1,006	1,206	1,260	1,430	1,608	1,660	1,710	1,980	2,010
40	382	430	478	525	573	620	669	716	764	812	860	908	956	1,146	1,195	1,355	1,528	1,575	1,625	1,880	1,910
42	366	409	454	500	545	591	636	682	732	775	818	863	908	1,090	1,140	1,295	1,464	1,500	1,545	1,790	1,820
44	347	390	434	478	521	564	608	651	694	737	780	824	868	1,042	1,085	1,235	1,388	1,432	1,475	1,710	1,735
46	333	375	416	458	500	541	582	624	666	708	750	791	832	1,000	1,040	1,180	1,332	1,370	1,410	1,635	1,660
48	318	358	398	438	478	517	558	597	636	676	716	756	796	956	995	1,130	1,272	1,315	1,350	1,565	1,590
53	288	324	360	395	432	468	503	539	576	612	648	683	720	864	900	1,025	1,152	1,189	1,225	1,420	1,440
60	255	287	319	350	387	414	446	478	510	542	574	606	638	774	795	905	1,020	1,050	1,080	1,255	1,275
72	212	239	265	291	318	345	371	398	424	451	477	504	530	637	665	755	849	875	905	1,045	1,060

FOR INTERMEDIATE DIAMETERS NOT LISTED USE THE FORMULA LISTED IN SECTION 1.2.10 OF ANSI B7.1 (SFPFM = 262 X WHEEL DIAMETER IN INCHES X RPM.)
TO CONVERT METERS PER SECOND (M/S) TO SFPFM: M/S X 196.85 = SFPFM. TO CONVERT SFPFM TO M/S: SFPFM/196.85 = M/S. TO CONVERT RPM TO SFPFM: WHEEL DIAMETER IN INCHES X RPM X 0.262 = SFPFM

FOR YOUR PROTECTION



Safety Gloves

Grinding applications are conducted in harsh environments. The use of proper fitting gloves is recommended.



Face and Eye Protection

Always wear government-approved face and eye protection when using abrasive products.



Speeds

Check machine spindle speed and speed listed on machine against safe maximum operating speed marked on the grinding wheel. Do not overspeed the wheel.



Hearing Protection

Use of abrasive products may create elevated sound levels. Hearing protection must be worn where required.

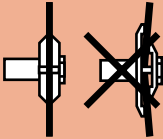

Flanges

When mounting most grinding wheels, use flanges of equal diameter and bearing surface. For exceptions, see ANSI B7.1.

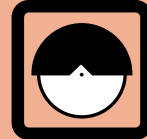

Wheel Guard

Always use the wheel guard as supplied by the machine manufacturer, in the proper position.

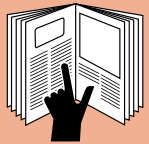

Safety Guides, MSDS and Wheel Warning Messages

Before using any abrasive materials, READ:

- The Safety Guides
- Wheel Warning Messages and
- Material Safety Data Sheets (MSDS)

Norton provides information pertaining to the safe use of all products. Please take the time to read it carefully. Contact suppliers of the workpiece and abrasive materials for copies of the MSDS if one is not readily available.



Dust Protection

Exposure to dust generated from workpiece and/or abrasive materials can result in lung damage and/or other physical injury.

Use dust capture or local exhaust as stated in the MSDS. Wear government-approved respiratory protection and eye and skin protection.

Failure to follow this warning can result in serious lung damage and/or physical injury.

This is a general dust warning and does not cover specific situations. For more information, refer to the MSDS dust warning provided with your products, and workpiece.



Blotter

Use paper or plastic blotters only when mounting superabrasive wheels with vitrified cores. Using paper or plastic blotters on any other core material may result in the wheel loosening during grinding.



Warning

This warning icon appears on our products and packaging. It is intended to draw your attention to the specific safety warning practices outlined after it.

SAFE OPERATING PRACTICES

Safe operating practices must be part of every grinding wheel user's operation. The greatest efficiency and lowest overall abrasive cost can be realized only if proven care and use techniques become standard practice.

- Be sure to read any safety material/guidelines provided with the abrasive product.
- Always check the wheel for cracks or damage before use.
- Before mounting the wheel, use a tachometer to measure the spindle speed.
- Ensure the mounting flanges, backplate or adapter supplied by the machine manufacturer are properly used and kept in good condition. ANSI Safety Requirement B7.1 provides wheel mounting requirements. Check mounting flanges for equal and correct diameter.
- Never use a grinding wheel with a rated speed less than the grinder.
- Always mount, true and dress the wheel in conformance with the guidelines published in the ANSI Safety Requirements B7.1.
- Ensure the correct wheel guard is in place before starting the wheel. Allow the wheel to come up to full operating speed before starting to grind for a minimum of one minute, and stand out of the plane of rotation.
- NEVER use a high speed air sander as a portable grinder.
- NEVER exceed the maximum operating speed marked on the wheel being used. The following formula may be used to calculate wheel speed:

$$\text{SFPM} = \text{Spindle Speed in RPM} \times \text{Wheel Diameter in inches} \times .262$$
- Avoid dropping or bumping the wheel.
- When not using the wheel, store the wheel in its original packing materials or according to ANSIB7.1. This protects the wheel and provides easy identification.

UPC # TO PAGE INDEX

UPC #	PAGE #	UPC #	PAGE #	UPC #	PAGE #	UPC #	PAGE #	UPC #	PAGE #	UPC #	PAGE #
07660702462	137	60157662240	55	66243529146	61	66260100670	122	66260114225	117	66260162669	79
07958747944	95	60157663486	55	66243529166	61	66260100681	116	66260114271	120	66260163376	100
07958747945	95	60157663501	55	66243529170	61	66260100687	120	66260114271	116	66260166122	122
07958747946	95	60157663909	55	66243529171	61	66260100700	120	66260114690	120	66260166174	119
07958747947	95	60157664141	55	66243529172	61	66260100701	120	66260114690	116	66260166700	119
07958747948	95	60157668409	55	66252939696	60	66260100702	120	66260114826	120	66260195000	78
07958747950	95	60157669935	57	66252939698	60	66260100703	120	66260114826	116	66260195001	78
07958773216	57	60157670869	57	66252939700	60	66260100707	120	66260118300	56	66260195002	78
07958773217	57	60157680042	57	66252939808	60	66260100708	120	66260119876	57	66260195003	78
07958783054	55	60157682133	55	66252939809	60	66260100716	120	66260127911	56	66260195004	78
07958783055	55	60157690579	115	66252939812	60	66260100722	120	66260127950	56	66260195005	78
07958783057	56	60157691380	57	66252939823	60	66260100731	122	66260135578	61	66260195006	78
07958783058	55	60157692199	56	66252939826	60	66260100740	121	66260135595	61	66260195007	78
07958783059	56	60157693885	115	66252939827	60	66260100741	121	66260141699	101	66260195008	78
07958783060	55	60157696315	56	66252940007	60	66260100742	121	66260141700	101	66260195009	78
07958783061	55	60157696562	56	66252940109	60	66260100743	121	66260141701	101	66260195010	91
07958783062	55	60157697699	57	66252940111	60	66260100744	120	66260142294	102	66260195011	91
07958783063	55	61463610103	63	66252941036	60	66260100745	120	66260142346	102	66260195012	91
07958783064	55	61463610205	63	66252941038	60	66260100746	120	66260142351	102	66260195013	91
07958783065	55	61463610214	63	66252941041	60	66260100747	120	66260142403	102	66260195014	91
07958783067	55	61463610280	63	66252941048	60	66260100751	122	66260142407	102	66260195015	91
07958783068	55	61463610290	63	66252941049	60	66260100759	122	66260142459	102	66260195016	83
07958783070	55	61463610291	63	66252941054	60	66260100779	121	66260142463	102	66260195016	83
07958783071	55	61463610303	63	66252941163	60	66260100786	121	66260142466	102	66260195016	83
07958783073	55	61463610368	63	66252941165	60	66260100798	122	66260142470	102	66260195017	82
07958783074	55	61463610375	63	66252941168	60	66260100803	121	66260142489	102	66260195018	82
07958783085	55	61463610390	63	66252941617	60	66260100805	122	66260142524	101	66260195019	82
07958784316	55	61463610393	63	66252941618	60	66260100816	122	66260142528	101	66260195020	104
60157602944	57	61463610398	63	66252941622	60	66260100820	122	66260142529	101	66260195021	78
60157603873	120	61463610405	63	66252941624	60	66260100821	122	66260145772	78	66260195022	78
60157604003	121	61463610406	63	66252941632	60	66260100826	118	66260145778	78	66260195023	80
60157604008	121	61463610438	63	66252942060	60	66260100936	122	66260148412	95	66260195024	80
60157604072	122	61463610453	63	66252942096	60	66260100984	120	66260148417	95	66260195025	80
60157604098	121	61463610455	63	66252942104	60	66260101129	122	66260148418	95	66260195030	89
60157604139	121	61463610555	63	66252942207	60	66260101271	121	66260151328	97	66260195031	89
60157604315	122	61463610597	63	66253010825	60	66260101453	121	66260151357	97	66260195032	89
60157604420	122	61463610599	63	66253013787	60	66260101454	121	66260151448	98	66260195034	89
60157604423	122	61463610605	63	66253014526	60	66260101495	121	66260151645	98	66260195035	89
60157604435	121	61463647865	63	66253043431	60	66260101515	121	66260151673	98	66260195036	89
60157612442	56	61463647867	63	66253043432	60	66260102106	120	66260155893	101	66260195038	89
60157612443	56	61463650324	63	66253043437	60	66260102369	119	66260156905	77	66260195039	89
60157613099	55	61463650450	63	66253043439	60	66260102408	121	66260156906	77	66260195040	89
60157613112	55	61463691123	137	66253043445	60	66260102768	121	66260156907	77	66260195041	91
60157623498	57	61463691133	137	66253043447	60	66260103303	95	66260156908	77	66260195045	89
60157623524	57	61463691134	137	66253043461	60	66260103305	95	66260157007	77	66260195046	89
60157623542	57	61463691138	137	66253043757	60	66260103306	95	66260157008	77	66260195047	89
60157623563	58	61463691139	137	66253043758	60	66260103307	95	66260157009	77	66260195048	89
60157623605	55	61463691143	137	66253043761	60	66260103532	95	66260157010	77	66260195049	89
60157623673	55	61463691148	137	66253043766	60	66260103534	95	66260158012	98	66260195050	89
60157623776	57	61463691149	137	66253043869	60	66260103535	95	66260158176	99	66260195055	89
60157623944	57	61463691153	137	66253043877	60	66260103545	95	66260158847	101	66260195056	89
60157623953	55	61463691154	137	66253044015	60	66260103555	95	66260158981	96	66260195058	89
60157624551	55	61463691158	137	66253044017	60	66260103741	99	66260158989	101	66260195060	89
60157624551	55	61463691163	137	66253044184	60	66260110959	119	66260159824	101	66260195080	90
60157625123	55	61463691164	137	66253044314	60	66260111494	117	66260159894	79	66260195081	90
60157625123	55	66243529070	61	66253296349	60	66260112444	117	66260160468	78	66260195083	90
60157625728	119	66243529145	61	66253350645	60	66260112980	117	66260162668	79	66260195085	89

UPC # TO PAGE INDEX

UPC #	PAGE #	UPC #	PAGE #	UPC #	PAGE #	UPC #	PAGE #	UPC #	PAGE #	UPC #	PAGE #
66260195086	89	66260195232	82	66260196007	78	66260196143	98	66260196213	100	66260273605	18
66260195088	89	66260195233	82	66260196011	78	66260196144	98	66260196215	100	66260273607	18
66260195089	89	66260195240	97	66260196014	78	66260196145	98	66260196216	100	66260273609	17
66260195090	91	66260195240	97	66260196015	78	66260196146	98	66260196217	100	66260273611	17
66260195095	89	66260195241	98	66260196018	78	66260196147	98	66260196218	100	66260273612	17
66260195096	89	66260195242	98	66260196019	78	66260196148	98	66260196219	100	66260273613	17
66260195097	89	66260195245	99	66260196022	78	66260196150	99	66260196266	95	66260273614	17
66260195098	91	66260195255	84	66260196023	78	66260196151	99	66260196276	101	66260273615	17
66260195098	91	66260195256	84	66260196026	78	66260196152	99	66260196277	101	66260273617	17
66260195098	91	66260195257	84	66260196027	78	66260196154	99	66260196278	101	66260300134	134
66260195100	81	66260195258	84	66260196034	78	66260196155	99	66260196282	101	66260300197	136
66260195116	78	66260195259	84	66260196035	78	66260196156	99	66260196283	101	66260300202	133
66260195117	78	66260195260	84	66260196098	97	66260196157	99	66260196286	101	66260300203	133
66260195121	78	66260195261	84	66260196099	97	66260196158	99	66260196287	101	66260300360	136
66260195122	78	66260195262	84	66260196100	97	66260196160	99	66260196310	102	66260300362	137
66260195126	78	66260195263	84	66260196101	97	66260196161	99	66260196311	102	66260300363	137
66260195127	78	66260195265	95	66260196102	97	66260196162	99	66260196312	102	66260300368	137
66260195130	78	66260195266	95	66260196103	97	66260196163	99	66260196313	102	66260300372	137
66260195132	78	66260195267	95	66260196104	97	66260196164	99	66260196314	102	66260300375	137
66260195135	78	66260195268	95	66260196105	97	66260196166	99	66260196315	102	66260300376	137
66260195136	78	66260195270	92	66260196106	97	66260196167	99	66260196316	102	66260300377	137
66260195137	78	66260195271	92	66260196107	97	66260196168	99	66260196446	95	66260300379	137
66260195162	80	66260195272	92	66260196108	97	66260196169	99	66260196447	95	66260300380	137
66260195163	80	66260195273	92	66260196109	97	66260196170	99	66260196448	95	66260300381	137
66260195164	80	66260195280	101	66260196110	97	66260196172	99	66260196449	95	66260300383	137
66260195171	80	66260195281	101	66260196111	97	66260196173	99	66260196450	95	66260300384	137
66260195172	80	66260195282	101	66260196112	97	66260196174	100	66260196451	95	66260300386	137
66260195173	80	66260195289	102	66260196113	97	66260196176	99	66260196452	95	66260300388	137
66260195176	97	66260195290	102	66260196114	97	66260196177	99	66260196453	95	66260300389	137
66260195180	80	66260195292	102	66260196115	98	66260196178	100	66260196492	99	66260300390	137
66260195185	81	66260195350	61	66260196116	98	66260196179	100	66260196493	100	66260300391	137
66260195187	81	66260195351	61	66260196117	98	66260196180	100	66260230236	19	66260300392	137
66260195188	81	66260195355	104	66260196118	98	66260196182	99	66260238686	19	66260300393	137
66260195190	81	66260195365	77	66260196119	98	66260196183	99	66260259011	19	66260300394	137
66260195200	103	66260195366	77	66260196120	98	66260196184	100	66260269172	20	66260300396	137
66260195201	103	66260195367	77	66260196121	98	66260196185	100	66260273557	18	66260300398	137
66260195202	103	66260195368	77	66260196122	98	66260196186	100	66260273560	18	66260300399	137
66260195205	103	66260195369	77	66260196123	98	66260196187	100	66260273561	18	66260300400	137
66260195206	103	66260195370	77	66260196124	98	66260196189	99	66260273562	18	66260300402	137
66260195210	83	66260195371	77	66260196125	98	66260196190	99	66260273565	20	66260300403	137
66260195211	83	66260195372	77	66260196126	98	66260196191	100	66260273566	18	66260300404	137
66260195212	83	66260195373	87	66260196127	98	66260196192	100	66260273567	18	66260300406	137
66260195213	83	66260195374	87	66260196128	98	66260196193	100	66260273574	18	66260300407	137
66260195214	83	66260195375	87	66260196129	98	66260196194	100	66260273583	17	66260300408	137
66260195215	83	66260195376	87	66260196130	98	66260196196	100	66260273584	17	66260300409	137
66260195216	83	66260195377	87	66260196131	98	66260196197	100	66260273586	17	66260300410	137
66260195217	83	66260195378	87	66260196132	98	66260196198	100	66260273587	17	66260300412	137
66260195218	83	66260195975	89	66260196133	98	66260196202	100	66260273588	17	66260300413	137
66260195219	83	66260195990	78	66260196134	98	66260196203	100	66260273589	17	66260300414	137
66260195220	83	66260195991	78	66260196135	98	66260196204	100	66260273590	17	66260300415	137
66260195221	83	66260195994	78	66260196136	98	66260196205	100	66260273592	17	66260300416	137
66260195225	82	66260195995	78	66260196137	98	66260196206	100	66260273594	17	66260300417	137
66260195226	82	66260195998	78	66260196138	98	66260196208	100	66260273596	17	66260300667	137
66260195227	82	66260195999	78	66260196139	98	66260196209	100	66260273597	17	66260301989	136
66260195228	82	66260196002	78	66260196140	98	66260196210	100	66260273598	17	66260301990	136
66260195230	82	66260196003	78	66260196141	98	66260196211	100	66260273599	17	66260302086	133
66260195231	82	66260196006	78	66260196142	98	66260196212	100	66260273601	18	66260302087	133

UPC # TO PAGE INDEX

UPC #	PAGE #	UPC #	PAGE #	UPC #	PAGE #	UPC #	PAGE #	UPC #	PAGE #	UPC #	PAGE #
66260302135	133	66260362989	136	66260392432	127	66260392491	127	66260392550	128	66260392609	129
66260302432	134	66260363015	136	66260392433	128	66260392492	127	66260392551	127	66260392610	129
66260302707	131	66260363036	136	66260392434	128	66260392493	127	66260392552	127	66260392611	128
66260302709	131	66260363371	130	66260392435	127	66260392494	128	66260392553	127	66260392612	128
66260302710	131	66260363450	128	66260392436	127	66260392496	128	66260392554	128	66260392613	128
66260302711	131	66260364008	134	66260392437	128	66260392497	127	66260392555	128	66260392614	129
66260302712	131	66260364241	134	66260392438	128	66260392498	127	66260392556	128	66260392615	129
66260302713	131	66260364253	136	66260392439	127	66260392499	127	66260392557	127	66260392616	129
66260302714	131	66260364258	136	66260392440	127	66260392500	128	66260392559	127	66260392617	128
66260302715	131	66260364301	131	66260392441	128	66260392501	128	66260392560	128	66260392618	128
66260302716	131	66260364302	131	66260392442	128	66260392502	128	66260392561	128	66260392619	128
66260302717	131	66260364303	131	66260392443	127	66260392503	127	66260392562	128	66260392620	129
66260302718	131	66260364304	131	66260392444	127	66260392504	127	66260392563	127	66260392621	129
66260302719	131	66260364305	131	66260392445	127	66260392505	127	66260392564	127	66260392622	129
66260302720	131	66260364306	131	66260392446	128	66260392506	128	66260392565	127	66260392623	128
66260302721	131	66260364307	131	66260392448	128	66260392507	128	66260392566	128	66260392624	128
66260302722	131	66260364308	131	66260392449	127	66260392508	128	66260392567	128	66260392625	128
66260302724	131	66260364309	131	66260392450	127	66260392509	127	66260392568	128	66260392626	129
66260302725	131	66260364310	131	66260392451	127	66260392510	127	66260392569	128	66260392627	129
66260302726	131	66260382018	120	66260392452	128	66260392511	127	66260392570	128	66260392628	129
66260302727	131	66260382018	116	66260392453	128	66260392512	128	66260392571	127	66260392629	129
66260302728	131	66260384227	120	66260392454	128	66260392513	128	66260392572	128	66260392630	129
66260302898	134	66260384227	116	66260392455	127	66260392514	128	66260392573	128	66260392631	129
66260305611	134	66260385384	120	66260392456	127	66260392515	127	66260392574	128	66260392632	129
66260305612	134	66260385384	116	66260392457	127	66260392516	127	66260392575	128	66260392633	129
66260308354	130	66260385394	120	66260392458	128	66260392517	127	66260392576	128	66260392634	129
66260312207	136	66260385394	116	66260392459	128	66260392518	128	66260392577	128	66260392635	129
66260313421	136	66260386661	120	66260392460	128	66260392519	128	66260392578	129	66260392636	129
66260313422	136	66260386661	116	66260392461	127	66260392520	128	66260392579	129	66260392637	129
66260313423	136	66260386801	120	66260392462	127	66260392521	127	66260392580	129	66260392638	129
66260313428	136	66260386801	116	66260392463	127	66260392522	127	66260392581	128	66260392639	129
66260313432	136	66260387133	120	66260392464	128	66260392523	127	66260392583	128	66260392640	129
66260313433	136	66260387133	116	66260392465	128	66260392524	128	66260392584	129	66260392641	129
66260313434	136	66260387481	120	66260392466	128	66260392525	128	66260392585	129	66260392642	129
66260320977	122	66260387481	116	66260392467	127	66260392526	128	66260392586	129	66260392643	129
66260322134	56	66260387592	120	66260392468	127	66260392527	127	66260392587	128	66260392644	129
66260322280	55	66260387592	116	66260392469	127	66260392528	127	66260392588	128	66260392645	129
66260329275	57	66260387692	120	66260392471	128	66260392529	127	66260392589	128	66260392646	129
66260329385	57	66260387692	116	66260392472	128	66260392530	128	66260392590	129	66260392647	129
66260329388	57	66260388852	116	66260392473	127	66260392531	128	66260392591	129	66260392648	129
66260329391	57	66260389554	116	66260392474	127	66260392532	128	66260392592	129	66260392649	129
66260329400	118	66260389753	120	66260392475	127	66260392533	127	66260392593	128	66260392650	129
66260329461	57	66260389753	116	66260392476	128	66260392534	127	66260392594	128	66260392651	129
66260329469	56	66260391021	117	66260392477	128	66260392535	127	66260392595	128	66260392652	129
66260329604	56	66260391464	136	66260392478	128	66260392536	128	66260392596	129	66260392653	129
66260329663	121	66260391473	136	66260392479	127	66260392537	128	66260392597	129	66260392654	129
66260329670	121	66260391474	136	66260392480	127	66260392538	128	66260392598	129	66260392655	129
66260329675	121	66260391729	134	66260392481	127	66260392540	127	66260392599	128	66260392656	129
66260329680	121	66260391730	134	66260392482	128	66260392541	127	66260392600	128	66260392657	129
66260329681	122	66260391731	134	66260392483	128	66260392542	128	66260392601	128	66260392658	129
66260329688	122	66260391732	134	66260392484	128	66260392543	128	66260392602	129	66260392659	129
66260329696	122	66260391733	134	66260392485	127	66260392544	128	66260392603	129	66260392660	129
66260329705	122	66260391734	134	66260392486	127	66260392545	127	66260392604	129	66260392661	129
66260329709	122	66260391830	134	66260392487	127	66260392546	127	66260392605	128	66260392662	129
66260329714	120	66260392429	127	66260392488	128	66260392547	127	66260392606	128	66260392663	129
66260362981	136	66260392430	128	66260392489	128	66260392548	128	66260392607	128	66260392664	129
66260362985	136	66260392431	127	66260392490	128	66260392549	128	66260392608	129	66260392665	129

UPC # TO PAGE INDEX

UPC #	PAGE #	UPC #	PAGE #	UPC #	PAGE #	UPC #	PAGE #	UPC #	PAGE #	UPC #	PAGE #
66260392666	129	66260392724	130	66260395431	130	66260395525	131	66260395597	133	69014118235	58
66260392667	129	66260392725	130	66260395432	130	66260395526	131	66260395598	133	69014118237	57
66260392668	129	66260392726	130	66260395433	132	66260395527	131	66260395599	133	69014118238	57
66260392669	129	66260392727	130	66260395434	132	66260395528	131	66260395600	133	69014118239	57
66260392670	129	66260392728	130	66260395435	132	66260395529	131	66260395601	133	69014118240	57
66260392671	129	66260392729	128	66260395436	132	66260395530	135	66260395602	133	69014118241	58
66260392672	129	66260392730	128	66260395437	132	66260395531	135	66260395603	133	69014118242	58
66260392673	129	66260392731	128	66260395438	132	66260395532	135	66260395604	133	69014118248	58
66260392674	129	66260392732	129	66260395439	132	66260395533	135	66260395605	134	69014118254	58
66260392675	129	66260392733	129	66260395440	132	66260395534	135	66260395606	134	69014118255	55
66260392676	129	66260392734	129	66260395441	132	66260395535	135	66260395607	134	69014118256	57
66260392677	129	66260392735	128	66260395442	132	66260395536	135	66260395608	134	69014118257	56
66260392678	129	66260392736	128	66260395443	132	66260395537	135	66260395609	134	69014118259	56
66260392679	129	66260392737	128	66260395444	132	66260395538	135	66260395611	134	69014118260	58
66260392680	129	66260392738	129	66260395445	132	66260395539	135	66260395613	134	69014118262	57
66260392681	129	66260392739	129	66260395446	132	66260395540	130	66260395614	134	69014118263	55
66260392682	129	66260392740	129	66260395447	132	66260395541	130	66260395615	134	69014118264	57
66260392683	129	66260392741	128	66260395448	132	66260395542	130	69014117679	57	69014118265	56
66260392684	129	66260392742	128	66260395449	132	66260395543	130	69014117684	55	69014118266	58
66260392685	129	66260392743	128	66260395450	132	66260395544	130	69014117812	56	69014118342	57
66260392686	129	66260392744	129	66260395483	132	66260395545	130	69014117820	58	69014118345	58
66260392687	129	66260392745	129	66260395484	132	66260395549	135	69014117833	58	69014118406	58
66260392688	129	66260392746	129	66260395485	132	66260395550	135	69014117838	56	69014118435	57
66260392689	129	66260392747	128	66260395486	132	66260395551	135	69014118029	58	69014118436	57
66260392690	129	66260392748	128	66260395487	132	66260395552	135	69014118043	58	69014118441	58
66260392691	129	66260392749	128	66260395488	132	66260395553	135	69014118200	55	69014118445	58
66260392692	129	66260392750	129	66260395489	132	66260395554	136	69014118201	55	69014118447	57
66260392693	130	66260392751	129	66260395490	132	66260395555	136	69014118202	55	69014118470	58
66260392694	130	66260392752	129	66260395491	132	66260395556	136	69014118203	55	69014118479	56
66260392695	130	66260392753	128	66260395492	132	66260395557	136	69014118204	55	69014118543	57
66260392696	130	66260392754	128	66260395493	132	66260395559	136	69014118205	55	69014118644	56
66260392697	130	66260392755	128	66260395494	132	66260395560	136	69014118206	55	69014122944	115
66260392698	130	66260392756	129	66260395495	132	66260395561	136	69014118207	55	69014122946	115
66260392699	130	66260392757	129	66260395496	132	66260395563	136	69014118208	55	69014122947	115
66260392700	130	66260392758	129	66260395497	132	66260395565	136	69014118209	56	69014122948	115
66260392701	130	66260392841	131	66260395498	132	66260395566	136	69014118210	56	69014122950	115
66260392702	130	66260392842	134	66260395499	132	66260395567	136	69014118211	56	69014122952	115
66260392703	130	66260392843	134	66260395500	132	66260395575	134	69014118212	56	69014122953	115
66260392704	130	66260392844	134	66260395501	132	66260395576	134	69014118213	56	69014122954	115
66260392706	130	66260392845	134	66260395502	132	66260395577	134	69014118215	56	69014122955	115
66260392707	130	66260392846	134	66260395503	132	66260395578	134	69014118216	55	69014122956	115
66260392708	130	66260392847	134	66260395504	132	66260395579	134	69014118217	55	69014123079	117
66260392709	130	66260392849	135	66260395505	132	66260395580	134	69014118219	56	69014123080	117
66260392710	130	66260392850	135	66260395506	132	66260395581	134	69014118221	56	69014141373	57
66260392711	130	66260392851	135	66260395507	132	66260395582	134	69014118222	56	69014185716	116
66260392712	130	66260392852	135	66260395508	132	66260395585	133	69014118223	57	69014185718	116
66260392713	130	66260392853	135	66260395509	132	66260395586	133	69014118224	57	69014185732	116
66260392714	130	66260392854	135	66260395510	132	66260395587	133	69014118225	57	69014185734	120
66260392715	130	66260395422	136	66260395516	131	66260395588	133	69014118226	57	69014185734	116
66260392716	130	66260395423	136	66260395517	131	66260395589	133	69014118227	57	69014185735	116
66260392717	130	66260395424	136	66260395518	131	66260395590	133	69014118228	57	69014185736	116
66260392718	130	66260395425	136	66260395519	131	66260395591	133	69014118229	57	69014185737	116
66260392719	130	66260395426	130	66260395520	131	66260395592	133	69014118230	57	69014185738	120
66260392720	130	66260395427	130	66260395521	131	66260395593	133	69014118231	57	69014185738	116
66260392721	130	66260395428	130	66260395522	131	66260395594	133	69014118232	57	69014185746	116
66260392722	130	66260395429	130	66260395523	131	66260395595	133	69014118233	58	69014185747	116
66260392723	130	66260395430	130	66260395524	131	66260395596	133	69014118234	58	69014190751	21

UPC # TO PAGE INDEX

UPC #	PAGE #	UPC #	PAGE #	UPC #	PAGE #	UPC #	PAGE #	UPC #	PAGE #	UPC #	PAGE #
69014191623	20	69014191693	17	69014191855	18	69014192140	17	69014192192	17	69014192311	18
69014191628	23	69014191695	17	69014191856	18	69014192141	17	69014192197	17	69014192312	18
69014191629	23	69014191696	17	69014191857	18	69014192142	17	69014192203	17	69014192313	18
69014191630	23	69014191698	18	69014191858	19	69014192143	17	69014192205	17	69014192314	18
69014191631	21	69014191700	18	69014191860	20	69014192144	17	69014192210	18	69014192316	18
69014191632	21	69014191701	18	69014191904	21	69014192149	17	69014192211	18	69014192325	18
69014191634	21	69014191703	18	69014191905	21	69014192150	17	69014192212	18	69014192363	21
69014191635	21	69014191704	18	69014191906	21	69014192151	19	69014192217	20	69014192427	21
69014191636	21	69014191705	18	69014191908	21	69014192152	19	69014192221	20	69014192428	17
69014191637	21	69014191706	19	69014191909	21	69014192155	19	69014192223	23	69014192761	19
69014191638	21	69014191707	19	69014191910	21	69014192156	19	69014192226	23	69014192764	17
69014191639	21	69014191715	22	69014191913	21	69014192157	19	69014192227	23	69014192769	17
69014191640	21	69014191716	22	69014191914	21	69014192158	19	69014192228	23	69014192770	17
69014191641	21	69014191719	22	69014191916	21	69014192159	19	69014192229	23	69014192771	17
69014191643	21	69014191720	22	69014191917	21	69014192160	19	69014192230	23	69014192772	17
69014191644	21	69014191721	22	69014191918	21	69014192161	19	69014192235	17	69014192773	17
69014191645	21	69014191722	22	69014192020	23	69014192162	19	69014192236	17	69014192777	18
69014191646	21	69014191723	22	69014192021	18	69014192163	19	69014192238	17	69014192779	18
69014191647	21	69014191724	22	69014192022	21	69014192164	19	69014192240	17	69014192780	18
69014191648	21	69014191725	21	69014192024	17	69014192165	19	69014192243	17	69014192784	23
69014191649	21	69014191832	22	69014192060	19	69014192166	19	69014192248	17	69014192786	20
69014191650	21	69014191833	22	69014192063	19	69014192167	19	69014192249	17	69014192799	20
69014191651	21	69014191834	22	69014192064	19	69014192168	19	69014192251	17	69014192810	21
69014191652	21	69014191835	22	69014192067	19	69014192169	19	69014192258	17	69014192814	21
69014191653	21	69014191837	22	69014192068	19	69014192170	19	69014192260	17	69014192815	19
69014191654	21	69014191838	22	69014192069	19	69014192172	19	69014192266	17	69014195679	22
69014191656	21	69014191839	22	69014192070	19	69014192173	19	69014192272	17	69014195680	22
69014191657	21	69014191840	22	69014192082	19	69014192174	17	69014192276	17	69014195682	22
69014191658	21	69014191841	22	69014192083	19	69014192175	17	69014192277	17	69014195683	22
69014191660	21	69014191842	22	69014192086	19	69014192176	17	69014192280	20	69014195685	22
69014191665	20	69014191843	22	69014192088	19	69014192177	17	69014192291	21	69014195686	22
69014191670	17	69014191844	22	69014192099	19	69014192178	17	69014192292	21	69936664144	60
69014191671	17	69014191848	18	69014192105	19	69014192179	17	69014192293	21		
69014191672	17	69014191849	18	69014192108	19	69014192180	17	69014192302	19		
69014191677	17	69014191852	18	69014192110	19	69014192182	17	69014192305	18		
69014191691	17	69014191853	18	69014192114	19	69014192184	17	69014192306	18		
69014191692	17	69014191854	18	69014192139	17	69014192187	17	69014192310	18		

NORTON HAS THE MOST COMPREHENSIVE LINE OF PREMIUM SUPERABRASIVE PRODUCTS

Also available:



Norton MSL (Metal Single Layer) Wheels and Tools

Get superior performance when grinding or cutting friction or composite materials. Norton MSL wheels and tools consist of a single, uniform layer of diamond or cBN in a metal bond, and always offer the advantages of long life and consistent cut rates.



Norton/Winter Made-To-Order Electroplated Products

Our Norton/Winter quality electroplated products are engineered to your exact requirements. We will manufacture them to your blueprints or design a product to produce the desired profile from your component blueprints.



Micro-Grinding with Planetary Kinematics (GPK) Products

Engineered for high-production grinding, targeted at applications with flatness value requirements of 0.1 – 1um. Available in diamond and cBN abrasives, vitrified and resin bonds.



Vitrified cBN Wheels Excel in High-Production Applications

Achieve complex geometries, tight tolerances, and burn-free finishes on hard-to-grind materials – along with high metal removal rates.



Norton Rotary Dressing Tools

The premier dressing solutions for high-speed grinding.



Wheel Dressing and Norton Dressing Infeed Systems and Spindles

With speeds ranging from 1,000 to 20,000+ RPMs, high torque, and their compact design, these systems are ideal for any truing and dressing requirements.

All Norton Superabrasive products are manufactured in state-of-the-art facilities, and are supported by a dedicated and knowledgeable team of Sales Representatives, CSRs, and Application Engineers. All these products can be ordered through our extensive network of authorized distributors.





DIAMOND AND cBN SUPERABRASIVE STANDARD PRODUCTS



Paradigm Diamond CNC Wheels for Round Tool and Insert Grinding

Lights out, on-line truable CNC wheels. Ground-breaking invention of an extreme porosity metal bond system. Maximize your productivity and lower your costs today with the Paradigm Shift in grinding.



G-Force/Univel CNC Wheels for Round Tool Grinding

The performance standard for carbide and steel round tool grinding with metal/hybrid technology: high form-holding capability, premium abrasives and a unique bond ensure lasting sharp cutting edges. Available in cBN and diamond abrasives.



Norton B99, B99E and Special Resin Stock Grinding Wheels

Largest diamond and cBN resin-bonded offering for wet and dry MRO and toolroom applications. Time-tested, consistent, and reliable. 250+ stock wheels and over 65,000 express lead time made-to-order wheels.



Single Layer Wheels and Tools

From mounted points to hand hones, files, and blades, a complete selection of single layer stock diamond and cBN tools for the ceramic, tool and die, composite, and MRO markets. Also available, made-to-order high-precision and production CNC single layer products for automotive, aerospace, bearing, and cutting tool applications.



Norton Stationary Dressing Tools

One of the most comprehensive stock offerings in the industry made with the highest quality diamonds for consistent performance and geometries. Our lean manufacturing facility can also make your made-to-order designs in short lead times.

BEST

Highest Productivity – Lowest Total Cost

BETTER

Excellent Blend of Performance and Price

GOOD

Consistent Performance – Low Initial Price

Reshaping
your
world.

NORTON

SAINT-GOBAIN

clipper®

DIAMOND, ABRASIVES, AND EQUIPMENT PRODUCTS FOR THE
CONSTRUCTION
DISTRIBUTION MARKET



REDEFINING
JOBSITE MUSCLE™

SAINT-GOBAIN

Reshaping
your
world.



Our Expertise

Norton Clipper is your one reliable source for all of your cutting, grinding, and drilling jobsite solutions for the construction market.

For over 135 years, the Norton brand has been a leader in product innovation in cutting and grinding applications. The Clipper brand has been a trusted equipment source on the jobsite since the first masonry saw was invented in 1937. We have taken the core strengths of both brands and merged them into an even stronger entity so that we deliver a unified product offering with the name that can be trusted for quality, durability, speed, life and value.

Norton Clipper boasts the widest range of diamond tools for cutting the most common surfaces: reinforced concrete, asphalt, granite, tile, stone, and steel. Norton Clipper is also well known for supplying high performance machines including: high-speed, walk-behind, masonry, tile and core drilling equipment. Whatever your job requires, we can offer you a leading product line of diamond, abrasives and light equipment for the concrete, construction and rental market with the relentless performance you've come to expect.

Our Mission

We offer powerful, precise, user-friendly solutions, which enable our customers to cut, grind, drill and finish all materials even in the most complex and challenging applications. By working closely with end-users and our construction expert partners, we design and provide customized solutions to secure the best option for performance, cost and safety.

Why Tiers Matter

At Norton Clipper we believe in delivering right choices that matter. Our diamond blades and abrasives are classified in GOOD, BETTER, and BEST performance/price tiers to help you choose the right product for your specific application every time.

If you need help determining the right tier for your specific needs, don't hesitate to contact us directly or reach out to your Norton Clipper sales representative.

GENERAL INFORMATION

About Norton Clipper **2**
 Quick-Reference **4**
 What's New **6**
 Product Selection Guide **8**
 Leadership **129**
 Trade Shows **130**
 Website **131**
 Trademarks **131**

ABRASIVES

Cut-off Wheels **11**
 Grinding Wheels **13**
 High-Speed Cut-off Wheels **14**
 Universal Arbor **15**
 Flap Discs **16**
 Non-Woven **17**
 Wheels and Wire Brushes **18**

HIGH-SPEED SAWS AND BLADES

Range Overview **19**
 CP500 Series Cut-off Saws **20**
 CE414 Cut-off Saw **22**
 Speedy Cart **24**
 High-Speed iHD Diamond Blades **25**
 High-Speed Diamond Blades **26**

WALK-BEHIND SAWS AND BLADES

Range Overview **31**
 35HP Gas Mid-Range Self-Propelled **32**
 20HP Gas Mid-Range Self-Propelled **34**
 C1320P Gas Small Push Saw **36**
 13HP Gas Mid-Range Self-Propelled **38**
 C1318P Gasoline Small Push Saw **40**
 C13PE Gasoline Small Push Saw **42**
 C914P Compact Push Saw **44**
 GC55 Early Entry/Green Small Push Saw **46**
 GC25E UP Early Entry/Green Small Push Saw **48**
 Walk-Behind Diamond Blades **50**

MASONRY SAWS AND BLADES

Range Overview **57**
 BBL Blockbuster Large - Electric **58**
 BBL Blockbuster Large - Gas **60**
 BBC Blockbuster Compact - Electric **62**
 BBC Blockbuster Compact - Gas **64**
 BBM307 Blockbuster Mini **66**
 BBM158 Blockbuster Mini **68**
 CST Series Masonry/Stone/Tile Saws **70**
 Masonry Diamond Blades **72**

TILE SAWS AND BLADES

Range Overview **79**
 CTC1020XL Tile Saw **80**
 CTC705 Tile Saw **82**
 CTC701 Tile Saw **84**
 TC405 Hand-Held Tile Saw **86**
 Tile Diamond Blades **88**

PORTABLE HAND-HELD BLADES

Diamond Blades For Cordless Tools **92**
 Abrasives For Cordless Tools **92**
 Diamond Blades **93**
 Diamond Cup Grinders **97**
 Vacuum Shroud Kit **99**

CORE DRILLS, CORE BITS, AND ACCESSORIES

Range Overview **101**
 DR520 and DR620 Core Drill Rigs **102**
 HDR600C Hand-Held **104**
 HHD3TOL Hand-Held **105**
 HHDETOL Hand-Held **106**
 HHDET1800 Hand-Held **107**
 Accessories and Extensions **108**
 Core Bits **110**

MERCHANDISING

Point-of-Purchase Displays **114**
 Point-of-Purchase Signage **119**
 Point-of-Purchase Packaging **120**

SAFETY

Breakages/Personal Injury **121**
 Safe Operating Practices **121**
 Safety Icons **121**
 Silica Dust **123**
 Technical Information **124**
 Cutting Depths / Operating Speeds **127**
 Extension Cord Recommendations **128**



Abrasive Products



Cut-Off Wheels

Page 11



Flap Discs

Page 16



Grinding Wheels

Page 13



High-Speed
Cut-Off Wheels

Page 14



Non-Woven Discs

Page 17



Wire Brushes

Page 18

Premium Diamond Products



4X4 MaxCut

Page 26



DUO Asphalt

Page 28



DUO EVO

Page 27



GMAX

Page 51



Silencio

Page 72



4X4

Page 26



Aero-Jet

Page 28



DUO

Page 27



DUO Abrasive

Page 28



DUO Masonry

Page 74



DUO Small
Diameter

Page 93



Paradigm

Page 55



Rescue Runner

Page 30



Paradigm

Page 110



iHD Cup Grinders

Page 97

High-Speed Saws



CP500 Gas
Cut-Off Saws

Page 20



CE414-350SS Electric
Cut-Off Saws

Page 22



Speedy Cart
High-Speed Saw Cart

Page 24

Walk-Behind Saws



35HP Gasoline
Mid-Range
Self-Propelled Saws
Page 32



20HP Gasoline
Mid-Range
Self-Propelled Saws
Page 34



C1320P Gasoline
Small Push Saws
Page 36



C13HP Gasoline
Small Push Saws
Page 38



C1318P Gasoline
Small Push Saws
Page 40



C13PE Gasoline
Small Push Saws
Page 42



C914P Gasoline
Small Push Saws
Page 44



GC55 Early Entry/Green
Small Push Saws
Page 46



GC25E UP Early Entry/
Green Small Push Saws
Page 48

Masonry Saws



BBL Blockbuster Large
Masonry Saws
Page 58



BBC Blockbuster
Compact Masonry Saws
Page 62



BBM Blockbuster Mini
Masonry Saws
Page 66



CST Series Masonry,
Stone, Tile Saws
Page 70

Tile Saws



CTC1020XL
Tile Saw
Page 80



CTC705
Tile Saw
Page 82



CTC701
Tile Saw
Page 84



TC405
Hand-Held Tile Saw
Page 86

Core Drills



DR520/620
Core Drill Rigs
Page 102



HDR600C
Hand-Held Core Drill
Page 104



HHD3TOL
Hand-Held Core Drill
Page 105



HHDETOL
Hand-Held Core Drill
Page 106



HHDET1800
Hand-Held Core Drill
Page 107

Whether you are looking to expand your rental fleet with rugged, reliable equipment, or grow your walk-in consumable sales, Norton Clipper can help. We have expanded our portfolio with new high-quality products to complement our existing offering you've come to know and trust. We will continue to deliver product innovation that makes Norton Clipper the single source supplier for all of your rental and construction needs.

We look forward to showing you how Norton Clipper is REDEFINING JOBSITE MUSCLE.

Equipment

SPEEDY CART

Convert your hand-held high-speed saw to a walk-behind saw. The last cart needed to get the job done.



CE414-350SS

The electric high-speed cut-off saw that redefines jobsite muscle with power, performance, durability and innovation.



C914P

Bridging the gap between the GC55 and reliable 13HP walk-behind saw range.



GC55VAC

The best early entry saw just got better with a vacuum attachment option.



CST SERIES

The missing link between long tiles saws and powerful masonry saws.



Diamond Blades

High-Speed - ValuPlus for Abrasive Materials

Ideal for residential contractors, priced competitively and designed to perform in abrasive materials either wet or dry.

Walk-Behind - Classic 18" & 20"

Designed to handle all of the material applications of the small walk-behind saw without breaking the bank.

Masonry - Silencio Charger

Easy on the ears and the wallet. A more economical quiet sandwich core is the perfect solution when cutting in sound sensitive work areas.

Portable - 9" blades for cordless power tools

Make your battery tool more versatile. This new product offering is designed to enhance the productivity of the 9" cordless portable saw.



Abrasives

Charger Chop Saw Wheel

New and improved with increased performance and STUD cutting option. Your better choice when performance counts.



Performance Quality Tiers

Within the Norton Clipper diamond and abrasive range, we offer a choice of performance levels, adapted to the requirements of our customers. For blades, a higher number of diamonds represent higher diamond concentration and longer product life. Each blade is clearly marked with these diamonds located underneath the product name. The color of the right half of the label also indicates the performance level as indicated below. Our abrasive products display a + symbol that represents the same tiering structure.

SUB BRAND	TIER	DIAMOND BLADES	ABRASIVE WHEELS	PERFORMANCE	LABEL COLOR
PREMIUM BLADES	Best	5		Best Performance	Blue
CHARGER	Better	4	4 ++++	High Performance	Gray
CLASSIC	Good	3	3 +++	Good Performance	Black
VALUPLUS	Value	2		Consistent Performance	White



Abrasive
Wheels

Diamond
Blades

Types of Diamond Blades



Segmented Rim

- Most aggressive cutting action for use on the widest variety of materials.
- Typically used on high-speed, walk-behind and masonry saw blades.
- Gullets (space between segments) are designed for specific applications.



Turbo Rim

- Aggressive cutting action with a smoother quality of cut.
- For use on harder materials such as granite, marble, and stone, to reduce chipping.



Continuous Rim

- Provides the smoothest of cuts.
- For use on porcelain, ceramic tile, marble, and other hard materials requiring a high quality cut.

In addition to the easily identifiable performance quality tiers, Norton Clipper packaging helps you select the correct product for your application by simply answering these 5 questions.

How to Choose the Right Diamond Blade

- 1 How deep is the cut? **BLADE DIAMETER**
(Refer to cutting depth charts beginning on page 127)
- 2 What are you cutting? **APPLICATION**
(Refer to application chart on catalog back cover)
- 3 Is the cutting application wet or dry? **WATER SYMBOL**
- 4 What type of saw (horsepower)? **MACHINE PICTURE**
- 5 How big is the job? **PERFORMANCE QUALITY TIER**
(Refer to chart on page 8)

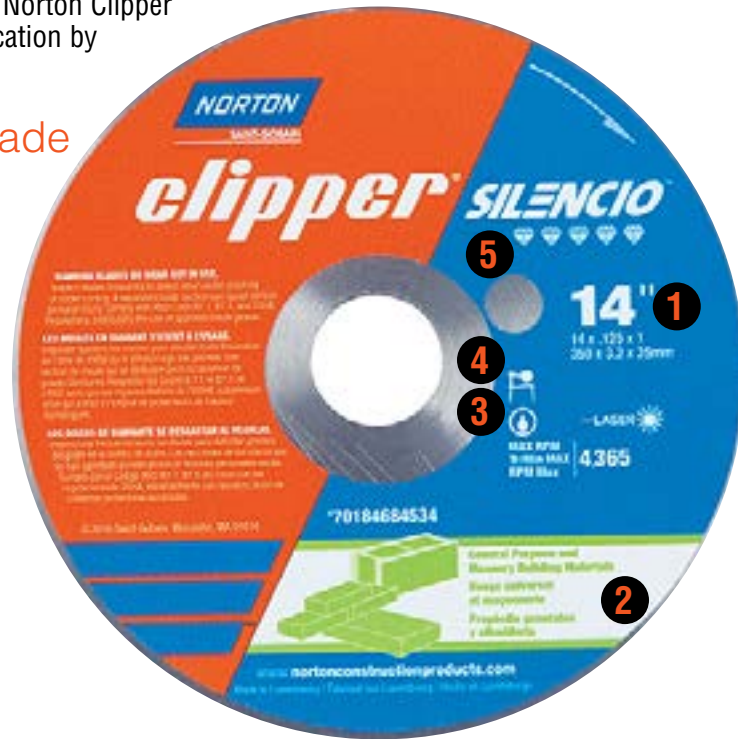

HOW DEEP IS THE CUT?
BLADE DIAMETER



WHAT ARE YOU CUTTING?
APPLICATION / COLOR CODE



IS APPLICATION WET OR DRY?
WET OR DRY SYMBOLS



HOW MUCH HORSEPOWER?
TYPE OF MACHINE



HOW BIG IS THE JOB?
PERFORMANCE QUALITY

How to Choose the Right Abrasive Product?

- 1 What tool are you using? **ABRASIVE SIZE**
(Refer to icon on label to match with your tool size and tool speed)
- 2 What are you cutting or grinding? **MATERIAL TYPE**
(Color-coded by material to be cut or ground)
- 3 What abrasive product do you need? **APPLICATION**
- 4 How big is the job? **PERFORMANCE QUALITY TIER**
- 5 How to keep safe? **IDENTIFY WARNING SYMBOLS**





clipper®

ABRASIVES LINE

Wheels, Discs, Non-Woven, Wire Brushes



CUTTING & GRINDING JOBSITE SOLUTIONS

RUGGED – Continually attuned to the market needs since our invention of the first masonry saw to today’s leadership in noise-dampening steel cores, universal arbors, and grain technologies delivers innovation to help you succeed.

RELIABLE – Combining the rich history of Clipper into the Norton family brings a single source supplier to the construction market with the high-quality and product performance you can trust to get you on and off the job quickly. Better tier = Charger. Good tier = Classic.

AFFORDABLE – Leveraging the deep knowledge base of our product and technical teams to offer right product solutions for price competitiveness that make a difference to your bottom line.

REDEFINING
JOBSITE MUSCLE™
Rugged. Reliable. Affordable.

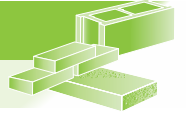

General Purpose and Masonry Building Materials

Blocks, medium-hard building bricks, paving slabs, concrete roof tiles and other medium-hard materials.

CIRCULAR SAW WHEELS – TYPE 01/41

CLASSIC

+++

Standard grade with good performance and life when cutting metal. Standard silicon carbide with good performance when cutting brick, block, concrete and other masonry materials.

UPC	SIZE	APPLICATION	MAX RPM	STD PKG
70184601484	7 x 3/32 x 5/8 Diamond	Metal / Stainless	8,730	25
70184601485	7 x 3/32 x 5/8 Diamond	Concrete	8,730	25

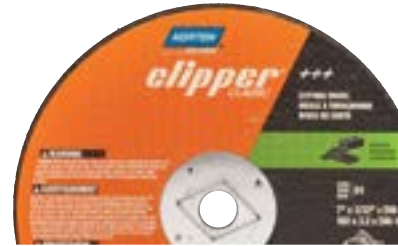

Steel & Stainless

General-purpose ferrous metals (steel, iron, welds), stainless steel and other high strength alloys.



CHOP SAW WHEELS – TYPE 01/41

CHARGER

++++

Industrial performance to be used in cutting pipe, angle iron, rebar and steel studs.

UPC	SIZE	APPLICATION	MAX RPM	STD PKG
70184601625	14 x 3/32 x 1 Side Reinforced	Metal / Stainless	4,365	10
70184601624	14 x 3/32 x 1 Side Reinforced	STUD	4,365	10



CLASSIC

+++

Industrial performance to be used in cutting conduit, tail pipes, structural and other solid shapes.

UPC	SIZE	APPLICATION	MAX RPM	STD PKG
70184601476	12 x 3/32 x 1 Center Reinforced	Metal / Stainless	5,095	10
70184601477	14 x 3/32 x 1 Center Reinforced	Metal / Stainless	4,365	10
70184601478	14 x 3/32 x 1 Side Reinforced	Metal / Stainless	4,365	10
70184601479	16 x 3/32 x 1 Side Reinforced	Metal / Stainless	3,800	10





Steel & Stainless

General-purpose ferrous metals (steel, iron, welds), stainless steel and other high strength alloys.

RIGHT ANGLE CUT-OFF WHEELS – TYPE 01/41

CHARGER ++++

Durable grain for maximum productivity of 3X the life and 2X the cut rate over conventional cut-off blades. High performance.

UPC	SIZE	APPLICATION	MAX RPM	STD PKG
70184601459	4 x .045 x 5/8	Metal / Stainless	15,280	25
70184601460	4-1/2 x .045 x 7/8	Metal / Stainless	13,580	25
70184601461	5 x .045 x 7/8	Metal / Stainless	12,225	25
70184601462	6 x .045 x 7/8	Metal / Stainless	10,185	25
70184601463	7 x .045 x 7/8	Metal / Stainless	8,600	25



CLASSIC +++

Industrial grade performance when cutting an array of steels and metal. Good Performance.

UPC	SIZE	APPLICATION	MAX RPM	STD PKG
70184601455	4-1/2 x .040 x 7/8	Metal / Stainless	13,580	25
70184601456	5 x .040 x 7/8	Metal / Stainless	12,225	25
70184601457	6 x .040 x 7/8	Metal / Stainless	10,185	25
70184601458	7 x .045 x 7/8	Metal / Stainless	8,600	25



RIGHT ANGLE CUT-OFF WHEELS – TYPE 27/42

CHARGER ++++

Durable grain for maximum productivity of 3X the life and 2X the cut rate over conventional cut-off blades. High performance.

UPC	SIZE	APPLICATION	MAX RPM	STD PKG
70184601469	4 x .045 x 5/8	Metal / Stainless	15,280	25
70184601470	4-1/2 x .045 x 7/8	Metal / Stainless	13,580	25
70184601473	5 x .045 x 7/8	Metal / Stainless	12,225	25
70184601474	6 x .045 x 7/8	Metal / Stainless	10,185	25
70184601475	7 x .045 x 7/8	Metal / Stainless	8,600	20

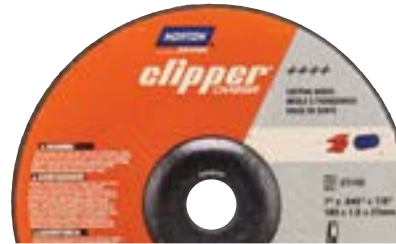

CLASSIC +++

Industrial grade performance when cutting an array of steels and metal. Good Performance.

UPC	SIZE	APPLICATION	MAX RPM	STD PKG
70184601464	4 x .045 x 5/8	Metal / Stainless	15,280	25
70184601465	4-1/2 x .045 x 7/8	Metal / Stainless	13,580	25
70184601466	5 x .045 x 7/8	Metal / Stainless	12,225	25
70184601467	6 x .045 x 7/8	Metal / Stainless	10,185	25
70184601468	7 x .045 x 7/8	Metal / Stainless	8,600	25





Steel & Stainless

General-purpose ferrous metals (steel, iron, welds), stainless steel and other high strength alloys.

GRINDING WHEELS – TYPE 27

CHARGER ++++

Ideal for grinding mild steel, stainless and alloy steels giving 3 times the life and 1 times the cut rate over conventional wheels. High Performance.

UPC	SIZE	APPLICATION	MAX RPM	STD PKG
70184601514	4-1/2 x 1/4 x 5/8-11	Metal / Stainless	13,580	10
70184601515	4-1/2 x 1/4 x 7/8	Metal / Stainless	13,580	25
70184601516	5 x 1/4 x 5/8-11	Metal / Stainless	12,225	10
70184601517	5 x 1/4 x 7/8	Metal / Stainless	12,225	25
70184601518	6 x 1/4 x 5/8-11	Metal / Stainless	10,185	10
70184601519	6 x 1/4 x 7/8	Metal / Stainless	10,185	20



CLASSIC +++

Industrial grade performance when grinding an array of metals and steels. Exceptional life and cut rate on carbon and stainless steel. Good performance.

UPC	SIZE	APPLICATION	MAX RPM	STD PKG
70184601501	4 x 1/4 x 5/8	Metal / Stainless	18,000	25
70184601502	4-1/2 x 1/4 x 5/8-11	Concrete	13,580	10
70184601503	4-1/2 x 1/4 x 5/8-11	Metal / Stainless	13,580	10
70184601504	4-1/2 x 1/4 x 7/8	Concrete	13,580	25
70184601505	4-1/2 x 1/4 x 7/8	Metal / Stainless	13,580	25
70184601506	5 x 1/4 x 5/8-11	Metal / Stainless	12,225	10
70184601507	5 x 1/4 x 7/8	Metal / Stainless	12,225	25
70184601508	6 x 1/4 x 5/8-11	Metal / Stainless	10,185	10
70184601509	6 x 1/4 x 7/8	Metal / Stainless	10,185	20

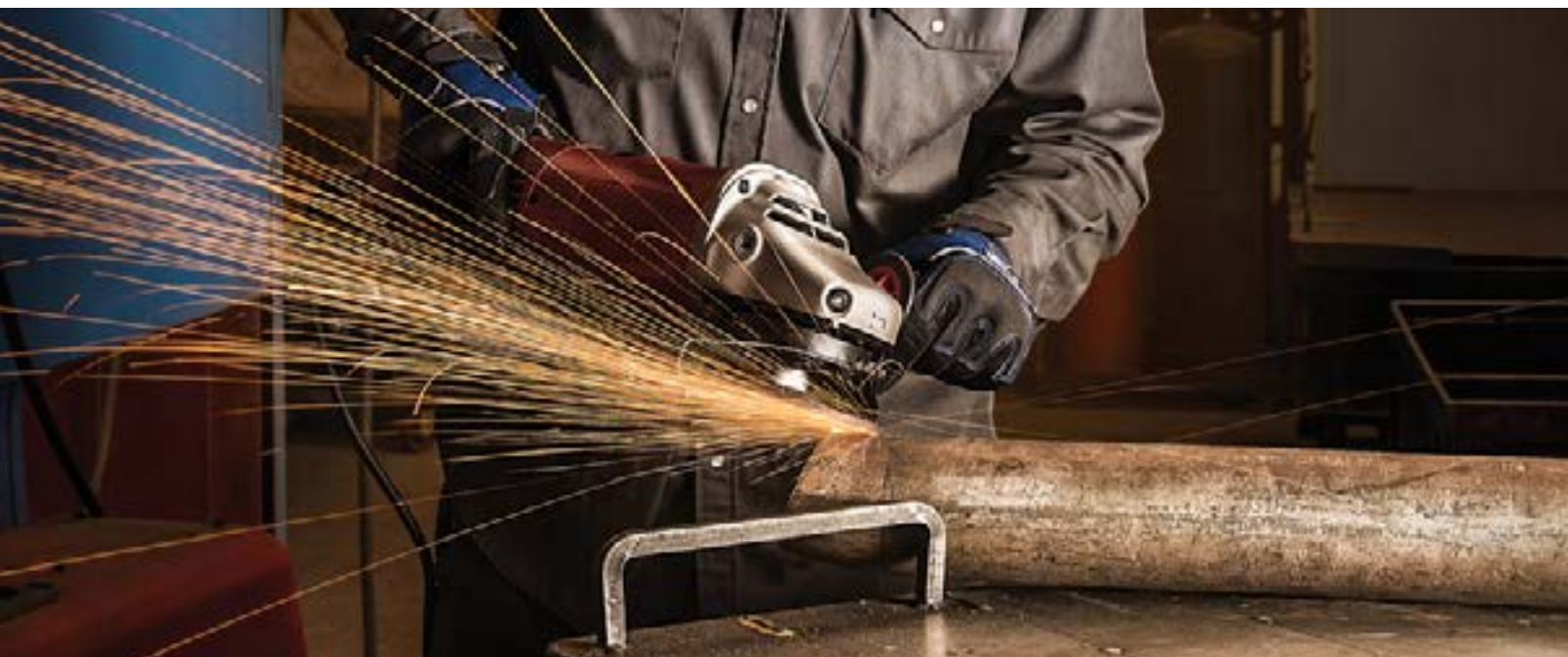
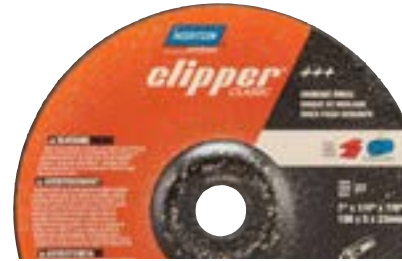



Multi-Purpose

Concrete, reinforced concrete, granite, building materials, thin steel sections, angle iron up to 1/2" material thickness, rebar up to no. 5.

REINFORCED CUT-OFF WHEELS

CHARGER

++++

High-performance aluminum oxide grain wheels designed for general purpose cutting of all steel and stainless applications. Triple reinforcement ensures longer life and smoother cutting.

UPC	SIZE	APPLICATION	MAX RPM	STD PKG
70184601620	12 x 1/8 x 20mm	Asphalt	6,300	10
70184601496	12 x 1/8 x 1/20mm	Concrete	6,300	10
70184601618	12 x 1/8 x 20mm	Concrete	6,300	10
70184601497	12 x 1/8 x 1/20mm	Metal/Stainless	6,300	10
70184601619	12 x 1/8 x 20mm	Metal/Stainless	6,300	10
70184601623	14 x 1/8 x 20mm	Asphalt	5,400	10
70184601498	14 x 1/8 x 1/20mm	Concrete	5,400	10
70184601621	14 x 1/8 x 20mm	Concrete	5,400	10
70184601499	14 x 1/8 x 1/20mm	Ductile	5,400	10
70184601500	14 x 1/8 x 1/20mm	Metal/Stainless	5,400	10
70184601622	14 x 1/8 x 20mm	Metal/Stainless	5,400	10



CLASSIC

+++

For metal and steel cutting application, including rebar, steel pipe, structural steel, sheet metal, cable and small to medium diameter solid pieces.

UPC	SIZE	APPLICATION	MAX RPM	STD PKG
70184601486	12 x 1/8 x 1/20mm	Asphalt	6,300	10
70184601487	12 x 1/8 x 1/20mm	Concrete	6,300	10
70184601488	12 x 1/8 x 1/20mm	Ductile	6,300	10
70184601489	12 x 1/8 x 1/20mm	Stainless/Metal	6,300	10
70184601490	14 x 1/8 x 1/20mm	Asphalt	5,400	10
70184601491	14 x 1/8 x 1/20mm	Concrete	5,400	10
70184601492	14 x 1/8 x 1/20mm	Ductile	5,400	10
70184601493	14 x 1/8 x 1/20mm	Stainless/Metal	5,400	10
70184601494	16 x 1/8 x 1/20mm	Concrete	4,700	10
70184601495	16 x 1/8 x 1/20mm	Metal/Stainless	4,700	10



you talked WE LISTENED



In an effort to help you and your customers more easily identify the right high-speed abrasive wheel for the specific application, we have improved our packaging labels for enhanced application visibility. A color-coded pictogram is prominently displayed on the packaging to ensure the right product is selected every time!

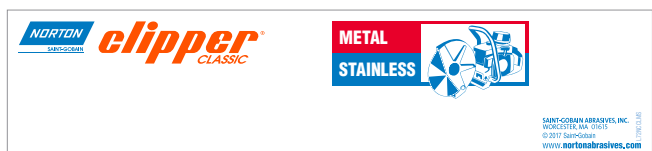
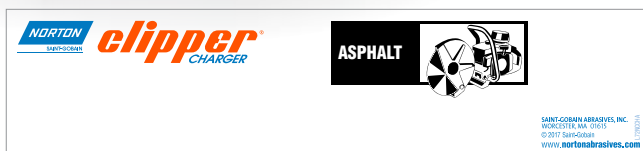



knock out **THE COMPETITION**

Our Norton patented 1"/20mm knock-out arbor fits all gas and electric high speed saws. A 20mm bushing is pre-mounted into the 1" molded arbor hole. The wheel, with the 20mm bushing, can be mounted directly on any 20mm arbor high speed saw. With the bushing removed, exposing the 1" arbor hole, the wheel can be mounted on any 1" arbor high speed saw. Combining this arbor, with heavy-duty triple reinforcing results in a higher performing, extra strong, longer lasting cutting wheel.

* Once the 20mm bushing is removed, it cannot be replaced.



Universal Arbor

The Norton universal arbor allows the abrasive blade to be used on either a 1" or 20mm high-speed gas or electric cut-off saw. Also reduces inventory.



Reinforcement Options

Metal, ductile, and concrete blades all have options with triple reinforcement adding to life and a smoother cut.



High-Performance Grain

Infused with grain technology, where necessary, to offer performance advantages where it counts.



Steel & Stainless

General-purpose ferrous metals (steel, iron, welds), stainless steel and other high strength alloys.

FIBERGLASS BACKING – TYPE 27

CHARGER

++++

Better choice for stainless steel, carbon steel, alloys and gray iron.

UPC	SIZE	GRIT / GRADE	STD PKG
70184601591	4-1/2 x 5/8-11	40	10
70184601592	4-1/2 x 5/8-11	60	10
70184601593	4-1/2 x 5/8-11	80	10



CLASSIC

+++

Good choice for steel/ferrous metal and masonry applications with low initial price.

UPC	SIZE	GRIT / GRADE	STD PKG
70184601578	4-1/2 x 5/8-11	36	10
70184601579	4-1/2 x 5/8-11	40	10
70184601580	4-1/2 x 5/8-11	60	10
70184601581	4-1/2 x 5/8-11	80	10
70184601582	4-1/2 x 5/8-11	120	10



Multi-Purpose, All Materials

Concrete, reinforced concrete, granite, building materials, thin steel sections, angle iron up to 1/2" material thickness, rebar up to no. 5.



RAPID STRIP DISCS - TYPE 27

CLASSIC

An open web of thick, strong, synthetic fibers and extra course, smear free abrasive. For cleaning and conditioning of multitude of materials, quickly and easily with very little loading. Perfect for removal of rust, residue and paint.

UPC	SIZE	GRIT / GRADE	STD PKG
70184601594	4-1/2 x 5/8-11	Ex. Coarse	10
70184601595	4-1/2 x 7/8	Ex. Coarse	10





Multi-Purpose, All Materials

Concrete, reinforced concrete, granite, building materials, thin steel sections, angle iron up to 1/2" material thickness, rebar up to no. 5.

CUP WHEELS - TYPE 11

CLASSIC +++

Type 11 shape for maximum surface grinding coverage. For heavy stock removal and beveling applications on all types of metal materials.

UPC	SIZE	GRIT	GRAIN	STD PKG
70184601607	4 / 3 x 2 x 5/8-11	16	A0	10
70184601608	5 / 3-3/4 x 2 x 5/8-11	16	A0	5
70184601609	6 / 4-3/4 x 2 x 5/8-11	16	A0	5



WIRE CUP BRUSHES

CLASSIC +++

High performance cable crimped cups provide up to 50% longer life and better flexibility on irregular surfaces.

UPC	DESCRIPTION	SIZE	APPLICATION	MAX RPM	STD PKG
70184601610	Crimped Cup	3 x .014 x 5/8-11	Carbon	15,000	6
70184601611	Knotted Cup	2-3/4 x .020 x 5/8-11	Carbon	15,000	6
70184601612	Knotted Cup	4 x .020 x 5/8-11	Carbon	9,000	1
70184601613	Knotted Cup	6 x .020 x 5/8-11	Carbon	6,000	1



WIRE BENCH WHEELS

CLASSIC +++

High performance cable crimped bench wheels provide up to 50% longer life and better flexibility on irregular surfaces.

UPC	SIZE	APPLICATION	MAX RPM	STD PKG
70184601614	6 x .014 x 1/2-2 AH	Carbon	6,000	1



KNOTTED WIRE WHEELS

CLASSIC +++

Narrow face stringer bead wire deliver high impact cutting and cleaning for the toughest applications. Specially suited for groove and weld bead, corners and t-connections. Large wire wheels clean concrete and asphalt joints and cracks quickly and efficiently before filling or scaling.

UPC	DESCRIPTION	SIZE	APPLICATION	MAX RPM	STD PKG
70184601615	Standard Twist Knot	4 x .020 x 5/8-11	Carbon	20,000	6
70184601616	Stringer Bead Knot	4 x .020 x 5/8-11	Carbon	20,000	6
70184601617	Joint/Crack Cleaning	12 x .035 x 1 - DP	Carbon	4,500	2





RANGE OVERVIEW



MODEL#

CP512-300

CP512-300i

CP514-350

CP514-350i

CE414-350SS

UPC#

70184647559

70184647561

70184647563

70184647565

70184694536

MAXIMUM DEPTH OF CUT

4"
(100mm)

5"
(125mm)

5"
(125mm)

MAXIMUM HORSEPOWER

5.4 HP (4.0 kW)

5.4 HP (4.0 kW)

4.2 HP (3.1 kW)

PRODUCT FEATURES



No More Pre-Mixing Oil and Fuel

The patented iLube® option automatically controls mixing of oil and fuel for maximum efficiency. An electronic sensor will indicate a low oil level and adjust the engine to idle to prevent engine damage.



Easy Start – Hot or Cold

The electronic carburetor's electromagnetic valve eliminates the standard choke and half throttle start. The 4-step easy start eliminates the hassle of a choke. Simply turn the switch on, prime the engine, and push the decompression button, then pull the cord to start.

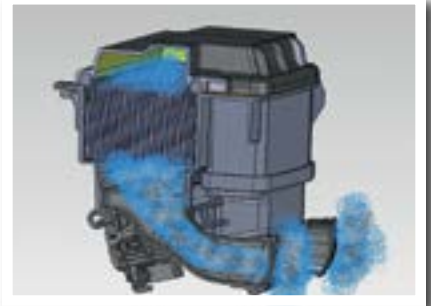

Multi-Stage Air Filtration

Patented twin-air inlets create an air pulsation that draws fresh air in while pushing dust away from the engine and releasing it out the back to keep the saw running clean and reduce debris being trapped in the filter. The external rocker wheel vibrates the filter to further help release debris. This system extends filter life for less cleaning/replacement.



The CP500 high-speed cut-off saw is destined to be an asset on any crew. It's fully designed with the user in mind to not only cut a smooth, fast track, but it's also fully equipped to handle the everyday performance of any jobsite with unrelenting durability and reliability. Select a standard model or upgrade to the world's first patented automatic lubrication system, iLube®.

TECHNICAL SPECIFICATIONS

PRODUCT #	CP512-300	CP512-300I	CP514-350	CP514-350I
UPC	701846 47559	701846 47561	701846 47563	701846 47565
Blade Guard Capacity - in (mm)	12" (305)	12" (305)	14" (356)	14" (356)
Maximum Depth of Cut - in (mm)	4" (100)	4" (100)	5" (125)	5" (125)
Arbor Size - in (mm)	.78 (20)	.78 (20)	.78 (20)	.78 (20)
Blade Flange Diameter - in (mm)	3.93 (100)	3.93 (100)	3.93 (100)	3.93 (100)
Blade Shaft RPM	4,500	4,500	4,500	4,500
Blade Shaft Bearings	Heavy Duty Sealed	Heavy Duty Sealed	Heavy Duty Sealed	Heavy Duty Sealed
Blade Shaft Drive	1 Belt	1 Belt	1 Belt	1 Belt
Control	Hand Held	Hand Held	Hand Held	Hand Held
Chassis	Norton Single-Cylinder Two Stroke Engine	Norton Single-Cylinder Two Stroke Engine	Norton Single-Cylinder Two Stroke Engine	Norton Single-Cylinder Two Stroke Engine
Power Source	Single Cylinder 2 Cycle	Single Cylinder 2 Cycle w/iLube	Single Cylinder 2 Cycle	Single Cylinder 2 Cycle w/iLube
Motor/Engine Type	Norton Clipper	Norton Clipper	Norton Clipper	Norton Clipper
Specifications	CP512-300	CP512-300i	CP514-350	CP514-350i
Maximum Horsepower ¹	5.4 hp (4.0 kW)	5.4 hp (4.0 kW)	5.4 hp (4.0 kW)	5.4 hp (4.0 kW)
Net Horsepower ¹	5.4 hp (4.0 kW)	5.4 hp (4.0 kW)	5.4 hp (4.0 kW)	5.4 hp (4.0 kW)
Max. Torque ft lbs (Nm)	3.54 (4.8)	3.54 (4.8)	3.54 (4.8)	3.54 (4.8)
Displacement - cu in (l)	4.94 (81)	4.94 (81)	4.94 (81)	4.94 (81)
Bore - in (mm)	2.04 (52)	2.04 (52)	2.04 (52)	2.04 (52)
Stroke - in (mm)	1.49 (38)	1.49 (38)	1.49 (38)	1.49 (38)
Cylinders/Cycle	Single Cylinder 2 Cycle	Single Cylinder 2 Cycle	Single Cylinder 2 Cycle	Single Cylinder 2 Cycle
Fuel Capacity - gal (l)	0.23 (0.9)	0.23 (0.9)	0.23 (0.9)	0.23 (0.9)
Oil Capacity - oz (l)	-NA-	10.08 (0.32)	-NA-	10.08 (0.32)
Electronically-Controlled Oil Lubrication	-NA-	YES	-NA-	YES
Air Filter	Heavy Duty 3 Stage	Heavy Duty 3 Stage	Heavy Duty 3 Stage	Heavy Duty 3 Stage
Starter	Manual	Manual	Manual	Manual
Engine Cooling	Forced Air	Forced Air	Forced Air	Forced Air
Electronically-Controlled Carburettor With Smart Choke	YES	YES	YES	YES
"Sound Level ^{2,3} L _{peg} (EN ISO 19432 Annex B) dB(A)"	98	98	98	98
Sound Power Level ^{2,3} L _{weg} (EN ISO 19432 Annex B) dB(A)	108	108	108	108
"Weighted Effective Acceleration ^{2,4} a _{h_v,eq} (EN ISO 19432 Annex C) Rear Handle / Top Handle m/s ² "	4.5 / 6.0	4.5 / 6.0	4.5 / 6.0	4.5 / 6.0

SAW DIMENSIONS

Height - in (mm)	16-15/16" (430)	16-15/16" (430)	16-15/16" (430)	16-15/16" (430)
Saw Width - in (mm)	10-1/2" (267)	10-1/2" (267)	10-1/2" (267)	10-1/2" (267)
Maximum Saw Length (Working) - in (mm)	29-17/32" (750)	29-17/32" (750)	30-1/2" (775)	30-1/2" (775)
Weight - Uncrated - lbs (kg)	22.26 (10.1)	22.92 (10.4)	22.49 (10.2)	23.15 (10.5)

ACCESSORIES

UPC	SMART PART #	DESCRIPTION
High-Speed Saw Wheel Kit	005101 09845	HSS Wheel Kit
High-Speed Saw Tool Kit	005101 09846	HSS Tool Kit
2.64 Gallon Pressure Water Tank – Metal	003104 64031	Manual Pump, 8ft (2.5m) with Quick Detach Fittings
9.24 Gallon Pressure Water Tank – Plastic	701846 02829	233936 Electric pump, automatic shut off, 34ft (10.4m) hose

1. DATA PROVIDED BY MOTOR/ENGINE MANUFACTURER
2. IN DETERMINING THE ABOVE VALUES REGARDING ACCELERATION OF VIBRATIONS AND SOUND, THE DIFFERENT OPERATING CONDITIONS WERE WEIGHED IN ACCORDANCE WITH THE CURRENT STANDARDS
3. INSECURITY K PURS. TO EC DIRECTIVE 2006/42/EC: 2.5 DB(A)
4. INSECURITY K PURS. TO EC DIRECTIVE 2006/42/EC: 2 M/S²

GENUINE NORTON CLIPPER DIAMOND BLADE INCLUDED WITH SAW.



High-Speed Saw Wheel Kit



High-Speed Saw Tool Kit



2.64 Gallon Pressure Water Tank

PRODUCT FEATURES



Thermal Protection

New ultra efficient air intake system keeps the motor cool while keeping out water and dust. Light indicators show low voltage or amperage overload while electronic clutch protects motor and gear set from damage during excessive conditions. The GFCI protects operators from electric shock.



StableStart

Smoother start provides better operator control. Motor slowly builds speed during start-up preventing unintentional circuit breaker trips.



Design

Strongest motor in class with better ergonomics for easier operation in wet and dry applications, delivering versatility.



The new Norton Clipper CE414-350SS electric high-speed hand-held saw is stronger than the competition. Its powerful 4.2HP motor delivers on the jobsite with a fast cut and ease of operator use. Add on unique design features that keep your saw from motor damage or stalling out and your maintenance needs become fewer and far between. Finish with an unprecedented warranty and you'll wonder why you'd choose anything but Norton Clipper.

TECHNICAL SPECIFICATIONS

PRODUCT #	CE414-350SS	NEW
UPC	701846	94536
Blade Guard Capacity - in (mm)	14" (356)	
Maximum Depth of Cut - in (mm)	5" (125)	
Arbor Size - in (mm)	1" (25.4) / 0.78 (20)	
Blade Flange Diameter - in (mm)	4" (100)	
Blade Shaft RPM	3,800	
Blade Shaft Bearings	Heavy-Duty Sealed	
Blade Shaft Drive	Gear Drive	
Control	Hand Held	
Chassis	Electric	
Power Source	115v/60/1 Electric	
Motor/Engine Type	Norton Clipper	
Specifications	CE414-350SS	
Maximum Horsepower ¹	4.2 hp (3.1 kW)	
Net Horse Power ¹	4.2 hp (3.1 kW)	
Starter	Electric	
Engine Cooling	Forced Air	
LED Overload Indicator	Yes	
IC Soft Start	Yes	
Thermal Overload Protection	Yes	
Cord Length - ft (m)	9.8 (3)	
Clutch	Yes	

SAW DIMENSIONS

Height - in (mm)	11-1/8" (283)
Saw Width - in (mm)	11-3/8" (288)
Maximum Saw Length (Working) - in (mm)	25-1/4" (11.45)
Weight - Uncrated - lbs (kg)	25.25 (11.6)

1. *1 DATA PROVIDED BY MOTOR/ENGINE MANUFACTURER
2. 2 IN DETERMINING THE ABOVE VALUES REGARDING ACCELERATION OF VIBRATIONS AND SOUND, THE DIFFERENT OPERATING
3. CONDITIONS WERE WEIGHED IN ACCORDANCE WITH THE CURRENT STANDARDS
4. 3 INSECURITY K PURS. TO EC DIRECTIVE 2006/42/EC: 2.5 DB(A)
5. 4 INSECURITY K PURS. TO EC DIRECTIVE 2006/42/EC: 2 M/S²

ACCESSORIES	UPC	SMART PART #
Vac Attachment System for CD414-350SS	701846	02863
		233935

GENUINE NORTON CLIPPER DIAMOND BLADE INCLUDED WITH SAW.



Vacuum Attachment System



Vacuum Attachment System Close-up

PRODUCT FEATURES



Advanced Design

Constructed with heavy-duty long life components and advanced design which creates a cart that allows for faster cuts, straighter cuts, less blade climb and the ultimate cutting experience.

Advanced Motor Adapter Plate

The SPEEDY CART is the world's first truly flexible high-speed saw cart with its optional advanced motor adapter plate system allowing the attachment of the Norton Clipper series and other popular high-speed saws to allow for the utmost utilization on the job site.

Steel Hub Wheels

The SPEEDY CART features steel hub wheels with real bearings for smoother rolling, straighter cuts, and easier operation than competitive models with plastic wheels and no bearings.



TECHNICAL SPECIFICATIONS

PRODUCT DESCRIPTION	UPC	SMART PART #
SPEEDY CART with Norton Clipper High-Speed Saw Adapter (Fits Norton Clipper CP500 Series Gas Saws)	701846 02411	SPEEDYCART
SPEEDY CART with Stihl High-Speed Saw Adapter (Fits Stihl TS420/TS400/TS500)	701846 07564	701846 07564
SPEEDY CART with Husqvarna High-Speed Saw Adapter (Fits Husqvarna K760/K760 Oil Guard/K770/K770 Oil Guard/ K770 VAC)	701846 07565	701846 07565
SAWS	UPC	SMART PART #
Norton Clipper 14" iLube High-Speed Cut-off Saw (SPEEDY CART not included.)	701846 47565	CP514-350i
Norton Clipper 14" Standard High-Speed Cut-off Saw (SPEEDY CART not included.)	701846 47563	CP514-350
ACCESSORIES	UPC	SMART PART #
Adapter for Norton Clipper CP500 Series Gas Saws (Cable & attachment hardware included. Saw not included.)	003105 01669	201409-138
Adapter for Stihl Series TS420 (Cable & attachment hardware included. Saw not included.)	003105 01671	310501671
Adapter for Husqvarna K760 and K770 Series Gas Saws (Cable & attachment hardware included. Saw not included.)	003105 01670	310501670
Rear mud flap kit	003105 01673	310501673
Front pointer assembly with attachment hardware	003105 01674	310501674



INFILTRATED HIGH-DENSITY DIAMOND BLADES

A new patented technology with longer blade life, faster cutting power, increased safety, and lower energy required for a high-quality result.



A STREAMLINED 2-STEP PROCESS

1

Form the segment core structure

2

Infiltrate the segment pores with exclusive bonding agent.

RESULT

A composite material with enhanced properties for limitless segment design.

UNIQUE PATENTED LASER WELDING WITH INFILTRATED SEGMENTS

Infiltration achieves high uniform density across each whole segment without applying high pressure (like the standard process). This allows Norton to manufacture very robust segments which wear evenly, remain intact and perform faster at higher cutting speeds.

The diamond grit is an integral part of the segment structure. During the patented process a special bond impregnates the core structure and binds the diamond grit into the segment. This ensures optimum use of the diamond grit, giving the diamond tools a longer life.

The simplified process also means increased segment design flexibility resulting in greater diversification of diamond blade shapes to best suit applications and materials being cut.





Multi-Purpose, All Materials

Concrete, reinforced concrete, granite, building materials, thin steel sections, angle iron up to 1/2" material thickness, rebar up to no. 5.

DRY – SEGMENTED RIM  

4X4 MAX CUT

Taking high-speed cutting versatility to an all new level. The same standard features as the 4X4 with its anti-crack gullets and patented depth indicators that not only cool the blade but also allow the operator to know how deep they are cutting. An all new bond and diamond specification improves blade life in a wide range of materials while excelling in steel. New segment wear indicators give the operator an idea of remaining blade life.

UPC	PART #	SIZE	MAX RPM	SEGMENT HEIGHT
701846 45927	4X4MC12118	12 x .118 x 1/20mm	6300	.472"
701846 45926	4X4MC14125	14 x .125 x 1/20mm	5460	.472"



4X4

Multi-purpose laser welded blade for dry cutting a range of construction materials without sacrificing performance or price. Depth of cut is easily controlled with the patented depth-of-cut indicators cut into the steel core. Anti-crack gullets for enhanced safety cutting steel and metal (up to 5mm thick).

UPC	PART #	SIZE	MAX RPM	SEGMENT HEIGHT
701846 84548	4X412110	12 x .110 x 1/20mm	6300	.393"
701846 84547	4X414118	14 x .118 x 1/20mm	5460	.393"
701846 45306	4X416125	16 x .125 x 1/20mm	4500	.393"



3X3

It's everything expected for high-speed cutting when both performance and price are a factor. The laser welded 3X3 cuts concrete, reinforced concrete, asphalt and abrasive building materials and more. High quality diamond increases the speed of cut on a variety of materials without changing blades. Premium blade characteristics and price point where it would take multiple sintered blades to achieve. Not recommended to cut metal.

UPC	PART #	SIZE	MAX RPM	SEGMENT HEIGHT
701846 47500	3X312110	12 x .110 x 1/20mm	6300	.315"
701846 47499	3X314118	14 x .118 x 1/20mm	5460	.315"



proven performance 4X4 MAX CUT



When I showed one of my concrete contractors the new **4X4 Max Cut**, he wondered how it was possible to improve on the standard **4X4** blade. He touts the benefits of the **4X4 Max Cut** to everyone, even his competitors: 'My customers love the crazy long life out of the **4X4 Max Cut** blade. The only problem I have is that the blade lasts too long so I don't sell as many blades! Great for my customers, not so great for my commission check!'

– Steve Wilkie, Applied Tool and Fastener





Reinforced Concrete and Harder Building Materials

Reinforced concrete, hard bricks, limestone, terrazzo, and other hard materials.

DRY – SEGMENTED RIM  + 

DUO EVO

The unique shape of the DUO EVO segments optimizes the angle of attack while enhancing the evacuation of the debris. With a new manufacturing process, the DUO EVO segments provide an exceptional cutting speed for optimum performance and increased life up to 20% over the original DUO EVO design.

UPC	PART #	SIZE	MAX RPM	SEGMENT HEIGHT
70184684217	DUOEVO12110	12 x .110 x 1/20mm	6300	.590"
70184684218	DUOEVO14118	14 x .118 x 1/20mm	5460	.590"
70184693356	DUOEVO16125	16 x .130 x 1/20mm	4500	.590"



DUO

Our exclusive design, introduced in 2002, has become a dominant name in the market. The unique dual segment per land technology provides excellent cutting speed with low vibration and high comfort of cut. The exclusive arrow shape gullets not only indicate blade direction, but also assist in fast removal of cutting debris. Maximum general purpose performance when cutting medium to low reinforcement, hard materials.

UPC	PART #	SIZE	MAX RPM	SEGMENT HEIGHT
70184683611	DUO12110	12 x .110 x 1/20mm	6300	.393"
70184683612	DUO14110	14 x .110 x 1/20mm	5460	.393"
70184684430	DUO14110 6PK	14 x .110 x 1/20mm	5460	.393"
70184683613	DUO14125	14 x .125 x 1/20mm	5460	.393"
70184684432	DUO14125 6PK	14 x .125 x 1/20mm	5460	.393"
70184683798	DUO16125	16 x .125 x 1/20mm	4500	.393"



proven performance DUO AND DUO EVO



Our firm has had terrific luck with the **DUO** family of blades. The only thing better than a DUO blade is the **DUO EVO**. The speed of cut and life of the DUO EVO blade is second to none.

– Aaron Graveen, Lincoln Contractors Supply



ESTIMATED NUMBER OF CUTS
HARD AGGREGATE STEEL REINFORCED



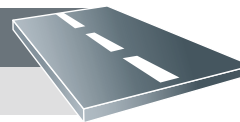

Asphalt and Abrasive Materials

Asphalt, green concrete, asphalt over concrete, abrasive blocks, mortar and other abrasive materials.

DRY – SEGMENTED RIM  

DUO ASPHALT

Dry cutting laser welded blade for asphalt and green concrete. Laser welded drop segment wear-retardant extends blade life. Scoop gullets for faster swarf removal increases cut speed. Stroboscopic indicators to control cut depth and show rotation direction.

UPC	PART #	SIZE	MAX RPM	SEGMENT HEIGHT
70184684543	DUOASP12110	12 x .110 x 1/20mm	6300	.590"
70184684315	DUOASP14125	14 x .125 x 1/20mm	5460	.590"
70184684544	DUOASP16125	16 x .125 x 1/20mm	4500	.590"



DUO ABRASIVE

Utilizes the basic characteristics of original DUO blade and adds a unique segment shape that optimizes the angle of attack while enhancing the evacuation of the particles. The result is an exceptional cutting speed allied with very good performance and life in abrasive materials and concrete block. The bond specification lends additional life when high-speed cutting.

UPC	PART #	SIZE	MAX RPM	SEGMENT HEIGHT
70184684291	DUOAB14110	14 x .110 x 1/20mm	5460	.327"
70184684292	DUOAB14125	14 x .125 x 1/20mm	5460	.327"



CLASSIC

Ideal blade for small to medium size high-speed cutting jobs. Economically priced with good productivity in asphalt, green concrete and other abrasive materials.

UPC	PART #	SIZE	MAX RPM	SEGMENT HEIGHT
07660701231	CHDASP1420	14 x .125 x 1/20mm	5460	.315"
70184684429	COHSABR1420	14 x .125 x 1/20mm	5460	.393"
07660701230	CHDASP1620	16 x .125 x 1/20mm	4500	.256"



VALUPLUS NEW

Dry cutting sintered segmented blade for abrasive materials. Drop-segment wear-retardant extends life of core. Economically priced with good performance in asphalt, green concrete and other abrasive materials.

UPC	PART #	SIZE	MAX RPM	SEGMENT HEIGHT
70184683333	VPHSABR14125	14 x .125 x 1/20mm	5460	.452"



Natural Stone and Tiles

Ceramic and stone tiles, granite, marble, very hard bricks and other very hard and dense materials.

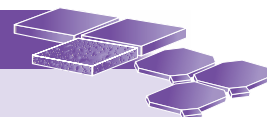

DRY – TURBO RIM  

AERO-JET

Very fast, smooth cutting. The .590" high diamond rim adds extremely long life whether cutting wet or dry in hard materials. Exclusive arrow shape protection inserts for precision straight cuts. A ventilated waved steel core for better cooling and intensive use. Exceptional cutting on a very wide range of materials with a high quality finished cut.

UPC	PART #	SIZE	MAX RPM	RIM HEIGHT
70184683785	AEROHS1420	14 x .125 x 1/20mm	5460	.590"



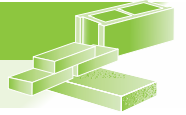

General Purpose and Masonry Building Materials

Blocks, medium-hard building bricks, paving slabs, concrete roof tiles and other medium-hard materials.

DRY – SEGMENTED RIM

CHARGER

A high performance, laser welded blade designed with quality segments for cutting concrete and medium hard materials with medium reinforcing.

UPC	PART #	SIZE	MAX RPM	SEGMENT HEIGHT
076607 56267	CGHSGP1420	14 x .125 x 1/20mm	5460	.315"
076607 01229	CGHSGP1620	16 x .125 x 1/20mm	4500	.256"



CLASSIC

The improved bond provides longer life at an economical price in medium hard materials such as concrete with light to medium reinforcement.

UPC	PART #	SIZE	MAX RPM	SEGMENT HEIGHT
701846 81383	COHSGP1220	12 x .110 x 1/20mm	6300	.256"
701846 81309	COHSGP1420	14 x .110 x 1/20mm	5460	.256"
701846 84268	COHSGP1420P	14 x .125 x 1/20mm	5460	.256"
701846 40356	COHSGP1620	16 x .125 x 1/20mm	4500	.256"



VALUPLUS SS

For value and performance on small to medium jobs. Provides fast cutting and the .472" taller sintered super segment (SS) increase blade life. Perfect blade for jobs that require fast dry cutting of abrasive materials.

UPC	PART #	SIZE	MAX RPM	SEGMENT HEIGHT
701846 84465	VPSSHSGP1420	14 x .125 x 1/20mm	5460	.472"



VALUPLUS

For value and performance on small to medium size jobs. The sintered blade cuts unreinforced soft to medium concrete fast on saws up to 13 HP.

UPC	PART #	SIZE	MAX RPM	SEGMENT HEIGHT
701846 84180	VPHSGP1220	12 x .110 x 1/20mm	6300	.393"
701846 84181	VPHSGP1420	14 x .110 x 1/20mm	5460	.393"
701846 84428	VPHSGP1420 20PK	14 x .110 x 1/20mm	5460	.393"



DRY – TURBO RIM

CHARGER

High performance dry cutting of a variety of materials. The segment specification allows extended life and fast cut for medium to large jobs.

UPC	PART #	SIZE	MAX RPM	SEGMENT HEIGHT
701846 84524	CGHSTS1220	12 x .125 x 1/20mm	6300	.472"
701846 84525	CGHSTS1420	14 x .125 x 1/20mm	5460	.472"



Rescue, Demolition

Ductile, steel, polyvinyl pipe, thin steel plate, acrylic sheet, fiberglass, rubber, standard glass, wood, concrete, brick, asphalt.



DRY – CONTINUOUS RIM



RESCUE RUNNER



When seconds count, reach for the Norton Rescue Runner. The specially tempered steel core provides maximum durability under the toughest conditions on many materials. A new diamond placement technology allows diamonds to cut in both directions for quick cutting.

UPC	PART #	SIZE	MAX RPM	SEGMENT HEIGHT
70184684426	NXHSRR1220	12 x .140 x 1/20mm	6300	.275"
70184684361	NXHSRR1420	14 x .140 x 1/20mm	5460	.275"



proven performance RESCUE RUNNER

“ The best thing about this blade is it always works. While operating at a strip mall fire, our tower was assigned vent work. The guys that operated that night stated that it out cut the other saws working that fire. They cut several different holes without having to change blades and were able to continue working without missing a beat. They cleaned the blade up, flipped it over and it was ready to meet its next challenge.

– FF/PM Chris Wilson, Bloomingdale Fire District

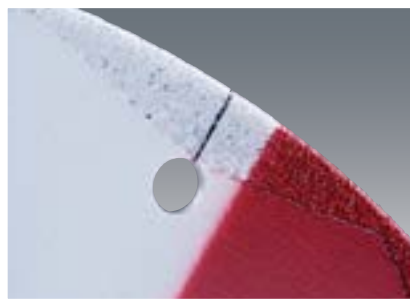

Bidirectional Blade Usage

The symmetrical diamond pattern placement allows the quick blade mounting without worry of proper direction.



Universal Arbor

The universal arbor allows the Rescue Runner to be used on both 1" and 20mm high-speed gas and electric saws.

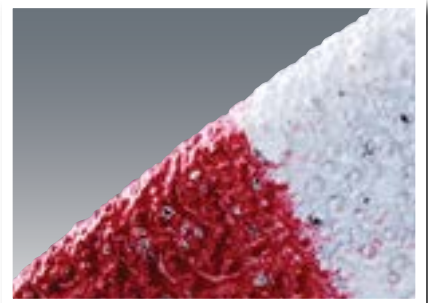

Faster Cutting and Longer Life

The bonding system allows the diamond to resist premature release providing longer diamond life and speed of cut.

DIALAST NEW



Vacuum brazed segments laser welded to steel core for maximum attachment strength for hand-held saw applications. Radially cut segments for less vibration. Advanced segment design with vent holes to provide enhanced cooling when cutting dry in hard and non-ferrous materials.

UPC	PART #	SIZE	MAX RPM	SEGMENT HEIGHT
70184602503	NDLAST14125	14 x .125 x 1/20mm	5400	.123"
70184602504	NDLAST16125	16 x .125 x 1/20mm	4725	.123"





RANGE OVERVIEW



MODEL#	C3530SS	C2024SS	C1320SS	C1318P	C13PE	C914P	GC55
UPC#	70184642467	70184627371	70184627368	70184642453	70184647524	70184608504	70184630005

MAX. DEPTH OF CUT	12 1/2" (318mm)	9 5/8" (244mm)	7 5/8" (193mm)	6 5/8" (168mm)	6 5/8" (168mm)	4.3" (100mm)	3 3/4" (95mm)
--------------------------	--------------------	-------------------	-------------------	-------------------	-------------------	-----------------	------------------

MAX. HP.	35 HP (26 kW)	20 HP (14.9 kW)	13 HP (9.5 kW)	13 HP (9.5 kW)	13 HP (9.5 kW)	9 HP (6.7 kW)	5.5 HP (4.1 kW)
-----------------	---------------	-----------------	----------------	----------------	----------------	---------------	-----------------

PRODUCT FEATURES



Oil Bath Blade Shaft

Sealed oil bath blade shaft eliminates the daily greasing and provides long hours of operation.



Powerful 35HP Gasoline Engine

The Vanguard, Big Block, V-Twin 35HP commercial gasoline engine is smooth and powerful, with proven performance.



Easy Operating Console

Simple, user-friendly layout increases operator productivity.



The 35HP engine has never been better since the introduction of the V-Twin air-cooled Vanguard engine. The strong gasoline engine mounted on a clean, uncomplicated frame makes the C35 series the best choice for small to mid-size applications. Packed with features for maximum performance, our operator-friendly design makes handling and preventative maintenance easier. The C35 series is an ideal saw for contractor work.

TECHNICAL SPECIFICATIONS

PRODUCT #	C3526SS	C3530SS
UPC	701846 42466	701846 42467
Blade Guard Capacity – in (mm)	26" (660)	30" (762)
Maximum Depth of Cut – in (mm)	9-1/2" (241)	12-1/2" (318)
Arbor Size – in (mm)	1" (25.4)	1" (25.4)
Blade Flange Diameter – in (mm)	5" (127)	5" (127)
Blade Shaft RPM	1,900	1,900
Blade Shaft Diameter – in (mm)	1-7/16" (37)	
Blade Shaft Bearings	Heavy Duty Pillow Block	
Blade Shaft Drive	7 Belts	
Blade Guard Attachment	Quick Detach Bayonet	
Blade Control	Electric	
Axle – Front – in (mm)	1" (25.4)	
Axle – Rear – in (mm)	1" (25.4)	
Wheels – Front D x W x B – in (mm)	6" x 2-1/2" x 1" (152 x 64 x 25)	
Wheels – Rear D x W x B – in (mm)	8" x 2-1/2" x 1" (203 x 64 x 25)	
Handle Bars/Adjustment Length – in (mm)	32-1/2" (826)	
Transmission	Eaton Hydrostatic	
Rear End/Differential	Enclosed Gears	
Control	Forward/Reverse Control, Engage/Disengaged Controls	
Speed	0-220 FPM (Forward) 0-100 FPM (Reverse)	
Chassis	Heavy Duty jig-welded box frame	
Power Source	Gasoline, 2 Cylinders 4 Cycle	
Engine Type	Briggs Vanguard	
Specifications	61347701710	
Maximum Horsepower*	35 HP (26kw)	
Displacement – cu In (l)	60.6 cu in (0.993 l)	
Bore – in (mm)	3.366" (85.5)	
Stroke – in (mm)	3.406" (86.5)	
Cylinders/Cycle	2 Cylinders 4 Cycle	
Fuel Capacity – gal (l)	5 gal (18.9 l)	
Oil Capacity – qt (l)	2.5 qt. (2.4 l)	
Air Filter	Three Stage	
Starter	Electric	
Engine Cooling	Air	

SAW DIMENSIONS

Height – in (mm)	42" (1,069)	42" (1,069)
Minimum Saw Length (Transport) – in (mm)	49-1/2" (1,257)	49-1/2" (1,257)
Maximum Saw Length (Working) – in (mm)	109-3/4" (2,788)	109-3/4" (2,788)
Maximum Pointer Length – in (mm)	33-3/4" (857)	33-3/4" (857)
Frame Width – in (mm)	22-1/2" (572)	22-1/2" (572)
Saw Width – in (mm)	29" (737)	29" (737)
Front (Outside to Outside Wheel Width) – in (mm)	19" (483)	19" (483)
Rear (Outside to Outside Wheel Width) – in (mm)	22-3/4" (578)	22-3/4" (578)
Blade to Wall – in (mm)	1-13/16" (46)	1-13/16" (46)
Wheel Base Length – in (mm)	20-1/4" (514)	20-1/4" (514)
Weight Crated – lbs (kg)	750 (341)	750 (341)
Weight Uncrated – lbs (kg)	650 (295)	650 (295)

ACCESSORIES

	UPC	SMART PART #
20" Blade Guard	701846 43382	246006
26" Blade Guard	701846 44384	246218
30" Blade Guard	701846 44385	246219
Light Kit w/magnetic base	701846 47436	170304
Water Pump Kit	701846 45877	246292

*= DATA PROVIDED BY MOTOR/ENGINE MANUFACTURER



Blade Guard



Water Pump Kit

PRODUCT FEATURES



Simple Maintenance Design

Easy to get to belt tensioning for quick replacements.



Spindle-Saver Blade Flanges

Allows blade to sit on inner flange instead of shaft for replacement of flange only instead of complete shaft.



Raised Axle

Heavy-duty boxed-in design resists bending and flexing during transport.



Manufactured with an uncomplicated, reinforced frame design to withstand the harshness of job cutting requirements on mid-sized jobs. Blade capabilities of 16", 20" or 24". The self-propelled hydrostatic transmission and the 4-V belt drive transfers maximum power to the blade shaft for ease of operation with dependable performance.

TECHNICAL SPECIFICATIONS

PRODUCT #	C2020SS	C2024SS
UPC	701846 27370	701846 27371
Blade Guard Capacity – in. (mm)	20" (356)	24" (406)
Maximum Depth of Cut – in. (mm)	7-5/8" (193)	9-5/8" (244)
Arbor Size – in. (mm)	1" (25)	1" (25)
Blade Flange Diameter – in. (mm)	4-1/2" (114)	4-1/2" (114)
Blade Shaft RPM	2520 RPM	2120 RPM
Blade Shaft Diameter – in. (mm)	1-1/4" (32)	
Blade Shaft Bearings	Heavy Duty Pillow Block	
Blade Shaft Drive	4 Belts	
Blade Guard Attachment	Pivoting, All Steel	
Blade Control	Hand Wheel/Screw Feed	
Axle – Front – in. (mm)	3/4" (19)	
Axle – Rear – in. (mm)	3/4" (19)	
Wheels – Front D x W x B – in. (mm)	5" x 2" x 3/4" (127 x 50 x 19)	
Wheels – Rear D x W x B – in. (mm)	6" x 2" x 3/4" (152 x 50 x 19)	
Handle Bars/Adjustment Length	20-5/8" (530)	
Transmission	Eaton Hydrostatic	
Control	Roller Gear	
Speed	0-220 FPM	
Chassis	Heavy duty jig-welded box frame	
Power Source	Gasoline, 2 Cylinders 4 Cycle	
Engine Type	Honda GX630	
Specifications	GX630RHTXF2	
Maximum Horsepower	20.8 HP (15.5 kW)	
Net Horsepower	18.1 HP (13.5 kW) – *	
Displacement – cu. In. (l)	41.9 cu in (0.688 l)	
Bore – in. (mm)	3.1" (78)	
Stroke – in. (mm)	2.8" (72)	
Cylinders/Cycle	Two Cylinder 4 Cycle	
Fuel Capacity – gal (l)	2.12 gal. (8.03 l)	
Oil Capacity – qt (l)	2.1 qt. (2.0 l)	
Air Filter	Three Stage Honda	
Starter	Electric	
Engine Cooling	Forced Air	
SAW DIMENSIONS		
Height	40" (1,016)	40" (1,016)
Minimum Saw Length (Transport) – in. (mm)	56" (1,142)	56" (1,142)
Maximum Saw Length (Working) – in. (mm)	114" (2,896)	114" (2,896)
Maximum Pointer Length – in. (mm)	40" (1,016)	40" (1,016)
Frame Width – in. (mm)	17" (432)	17" (432)
Saw Width – in. (mm)	26" (660)	26" (660)
Front (Outside to Outside Wheel Width) – in. (mm)	14-3/16" (360)	14-3/16" (360)
Rear (Outside to Outside Wheel Width) – in. (mm)	15-1/4" (388)	15-1/4" (388)
Blade to Wall – in. (mm)	2-9/16" (65)	2-9/16" (65)
Wheel Base Length – in. (mm)	16-1/6" (407)	16-1/6" (407)
Weight Crated – lbs (kg)	468 (212)	468 (212)
Weight Uncrated – lbs (kg)	428 (195)	428 (195)
ACCESSORIES	UPC	SMART PART #
Water Tank Kit for 13HP & 20HP	701846 28014	238001

*= DATA PROVIDED BY MOTOR/ENGINE MANUFACTURER
GENUINE NORTON CLIPPER DIAMOND BLADE INCLUDED WITH SAW.



Water Tank Kit

PRODUCT FEATURES



Spindle-Saver Blade Flanges

Allows blade to sit on inner flange instead of shaft for replacement of flange only instead of complete shaft.



Four V-Belts

Transferring maximum power to the blade shaft.



Reinforced Frame and Axle

Strongest in its class.

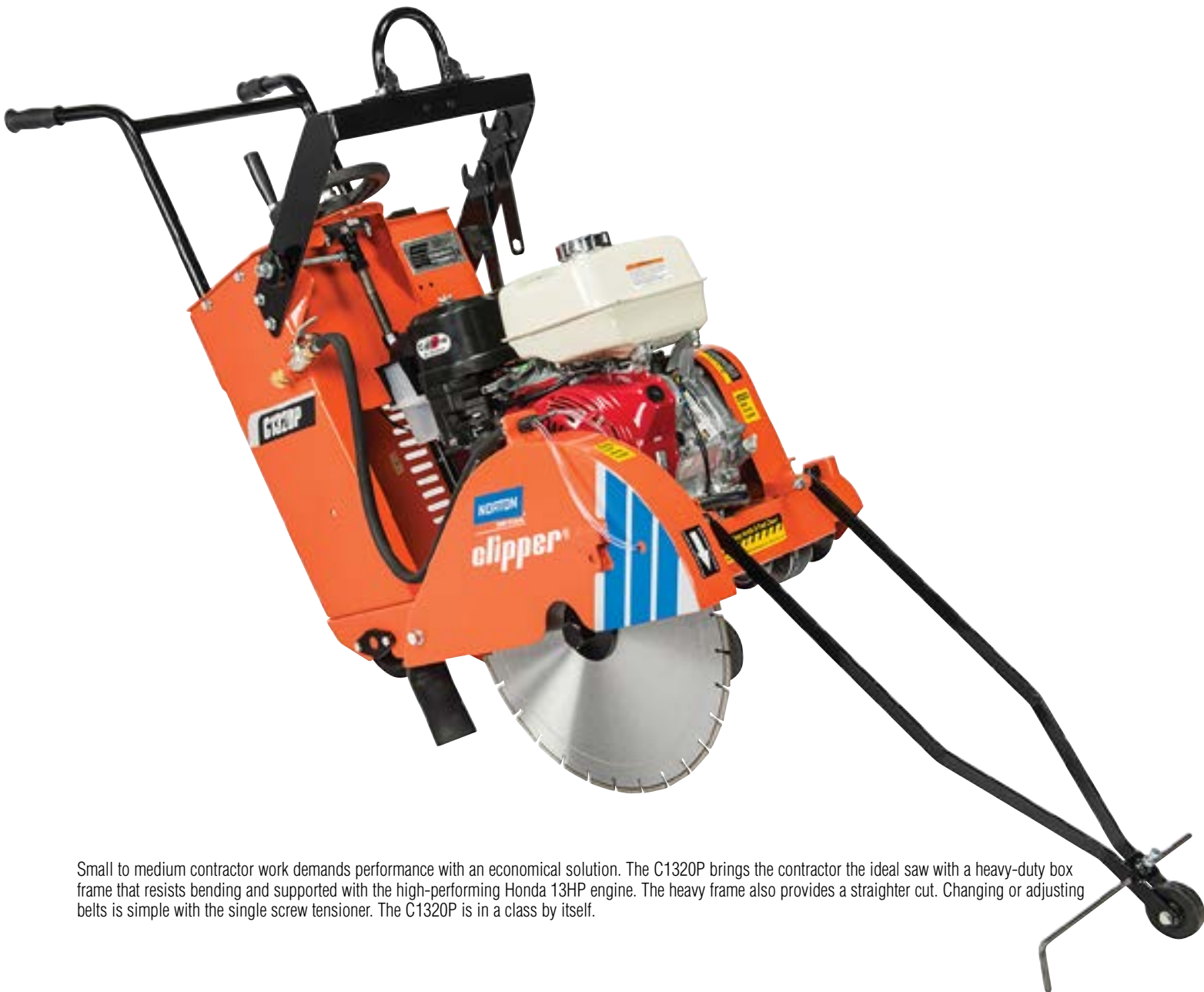

Small to medium contractor work demands performance with an economical solution. The C1320P brings the contractor the ideal saw with a heavy-duty box frame that resists bending and supported with the high-performing Honda 13HP engine. The heavy frame also provides a straighter cut. Changing or adjusting belts is simple with the single screw tensioner. The C1320P is in a class by itself.

TECHNICAL SPECIFICATIONS

PRODUCT #	C1320P	
UPC	701846 42456	
Blade Guard Capacity – in (mm)	20" (356)	
Maximum Depth of Cut – in (mm)	7-5/8" (193)	
Arbor Size – in (mm)	1" (25)	
Blade Flange Diameter – in (mm)	4-1/2" (114)	
Blade Shaft RPM	2,520 RPM	
Blade Shaft Diameter – in (mm)	1-1/4" (32)	
Blade Shaft Bearings	Heavy Duty Pillow Block	
Blade Shaft Drive	4 Belts	
Blade Guard Attachment	Pivoting, All Steel	
Blade Control	Hand Wheel/Screw Feed	
Axle – Front – in (mm)	3/4" (19)	
Axle – Rear – in (mm)	3/4" (19)	
Wheels – Front D x W x B – in (mm)	5" x 2" x 3/4" (127 x 50 x 19)	
Wheels – Rear D x W x B – in (mm)	6" x 2" x 3/4" (152 x 50 x 19)	
Handle Bars/Adjustment Length	20-5/8" (530)	
Control	Roller Gear	
Speed	0-220 FPM	
Chassis	Heavy duty jig welded box frame	
Power Source	Gasoline, Single Cylinder 4 Cycle	
Engine Type	Honda GX390	
Specifications	GX390K1QXC9	
Maximum Horsepower*	13 HP (9.5kW)	
Net Horsepower*	11 HP (8.2 kW)	
Displacement – cu In (l)	23.7 cu in (0.39)	
Bore – in (mm)	3.5" (88)	
Stroke – in (mm)	2.5" (64)	
Cylinders/Cycle	Single Cylinder 4 Cycle	
Fuel Capacity – gal (l)	1.79 gal. (6.5 l)	
Oil Capacity – qt (l)	1.16 qt. (1.1 l)	
Air Filter	Four Stage Honda	
Starter	Manual	
Engine Cooling	Air	
SAW DIMENSIONS		
Height	40" (1,016)	
Minimum Saw Length (Transport) – in (mm)	56" (1,142)	
Maximum Saw Length (Working) – in (mm)	114" (2,896)	
Maximum Pointer Length – in (mm)	40" (1,016)	
Frame Width – in (mm)	17" (432)	
Saw Width – in (mm)	26" (660)	
Front (Outside to Outside Wheel Width) – in (mm)	14-3/16" (360)	
Rear (Outside to Outside Wheel Width) – in (mm)	15-1/4" (388)	
Blade to Wall – in (mm)	2-9/16" (65)	
Wheel Base Length – in (mm)	16-1/6" (407)	
Weight Crated – lbs. (kg)	345 (157)	
Weight Uncrated – lbs (kg)	310 (141)	
ACCESSORIES	UPC	SMART PART #
Water Tank Kit for 13HP & 20HP	701846 28014	238001

*= DATA PROVIDED BY MOTOR/ENGINE MANUFACTURER

GENUINE NORTON CLIPPER DIAMOND BLADE INCLUDED WITH SAW.



Water Tank Kit

PRODUCT FEATURES



Pivoting Blade Guard

All steel construction, with no springs or hinges, eliminates possible breakage.



Heavy-Duty Box Frame

Resists bending and flexing for a solid design.



Eaton Transmission

Hydro-static for infinitely variable forward and reverse speeds.



Combining all the features of the larger self-propelled Norton Clipper saw, this saw features a strong 13HP Honda engine in either manual or electric start. Constructed with a well-balanced and narrow box frame with right or left cutting capability, these flat saws are very versatile on any size job site.

TECHNICAL SPECIFICATIONS

PRODUCT #	C1320SM	C1320SS
UPC	701846 27366	701846 27368
Blade Guard Capacity – in. (mm)	20" (356)	20" (356)
Maximum Depth of Cut – in. (mm)	7-5/8" (193)	7-5/8" (193)
Arbor Size – in. (mm)	1" (25)	1" (25)
Blade Flange Diameter – in. (mm)	4-1/2" (114)	4-1/2" (114)
Blade Shaft RPM	2520 RPM	2520 RPM
Blade Shaft Diameter – in. (mm)	1-1/4" (32)	
Blade Shaft Bearings	Heavy Duty Pillow Block	
Blade Shaft Drive	4 Belts	
Blade Guard Attachment	Pivoting, All Steel	
Blade Control	Hand Wheel/Screw Feed	
Axle – Front – in. (mm)	3/4" (19)	
Axle – Rear – in. (mm)	3/4" (19)	
Wheels – Front D x W x B – in. (mm)	5" x 2" x 3/4" (127 x 50 x 19)	
Wheels – Rear D x W x B – in. (mm)	6" x 2" x 3/4" (152 x 50 x 19)	
Handle Bars/Adjustment Length	20-5/8" (530)	
Transmission	Eaton Hydrostatic	
Control	Roller Gear	
Speed	0-220 FPM	
Chassis	Heavy duty jig-welded box frame	
Power Source	Gasoline, Single Cylinder 4 Cycle	
Engine Type	Honda GX390	
Specifications	GX390K1QXC9	GX390K1QAE2
Maximum Horsepower	13 HP (9.5 kW) – *	
Net Horsepower	11 HP (8.2 kW) – *	
Displacement – cu. In. (l)	23.7 cu in (0.39)	
Bore – in. (mm)	3.5" (88)	
Stroke – in. (mm)	2.5" (64)	
Cylinders/Cycle	Single Cylinder 4 Cycle	
Fuel Capacity – gal. (l)	1.79 gal. (6.5 l)	
Oil Capacity – qt. (l)	1.16 qt. (1.1 l)	
Air Filter	Four Stage Honda	Two Stage Honda
Starter	Manual	Electric
Engine Cooling	Air	
SAW DIMENSIONS		
Height	40" (1,016)	40" (1,016)
Minimum Saw Length (Transport) – in. (mm)	56" (1,142)	56" (1,142)
Maximum Saw Length (Working) – in. (mm)	114" (2,896)	114" (2,896)
Maximum Pointer Length – in. (mm)	40" (1,016)	40" (1,016)
Frame Width – in. (mm)	17" (432)	17" (432)
Saw Width – in. (mm)	26" (660)	26" (660)
Front (Outside to Outside Wheel Width) – in. (mm)	14-3/16" (360)	14-3/16" (360)
Rear (Outside to Outside Wheel Width) – in. (mm)	15-1/4" (388)	15-1/4" (388)
Blade to Wall – in. (mm)	2-9/16" (65)	2-9/16" (65)
Wheel Base Length – in. (mm)	16-1/6" (407)	16-1/6" (407)
Weight Crated – lbs (kg)	425 (193)	445 (202)
Weight Uncrated – lbs (kg)	385 (175)	405 (175)
ACCESSORIES	UPC	SMART PART #
Water Tank Kit for 13HP & 20HP	701846 28014	238001

*= DATA PROVIDED BY MOTOR/ENGINE MANUFACTURER
GENUINE NORTON CLIPPER DIAMOND BLADE INCLUDED WITH SAW.



Water Tank Kit

PRODUCT FEATURES



Vibration Reducing Handle Bars

Shock-absorbing handle bars reduce vibrations up to 40%.



Quick Belt Tensioning

Provides fast and accurate belt tensioning.



Fast Blade Guard Lock

No hassle, blade guard securing lock.



The next generation of 13HP saws. The C1318P features shock-absorbing handle bars. The new sleek design of the water tank, with increased capacity and improved securing, adds an additional 6.5 gallons of water over the cut. And, a newly-designed belt tensioning system helps keep the saw cutting true and true. All these features, coupled with the Honda 13HP engine, makes the C1318P the premiere choice for rental and service work.

TECHNICAL SPECIFICATIONS

PRODUCT #	C1318P
UPC	701846 42453
Blade Guard Capacity – in (mm)	18" (457)
Maximum Depth of Cut – in (mm)	6-5/8" (168)
Arbor Size – in (mm)	1" (25)
Blade Flange Diameter – in (mm)	4-1/2" (114)
Blade Shaft RPM	2,573
Blade Shaft Diameter – in (mm)	1.18" (30)
Blade Shaft Bearings	Heavy Duty Pillow Block
Blade Shaft Drive	Single 10 Groove Belt
Blade Guard Attachment	Hinged, All Steel
Blade Control	Hand Wheel/Screw Feed
Axle – Front – in (mm)	25/32" (20)
Axle – Rear – in (mm)	25/32" (20)
Wheels – Front D x W x B – in (mm)	4-59/64" x 1-31/32" x 25/32" (125 x 50 x 20)
Wheels – Rear D x W x B – in (mm)	8" x 1-1/4" x 25/32" (203 x 32 x 20)
Handle Bars/Adjustment Length	6-1/4" (160)
Control	5.28 gal. (20 l)
Speed	Push
Chassis	Heavy Duty Steel Box with Longitudinal and Horizontal Reinforcements
Power Source	Gasoline, Single Cylinder 4 Cycle
Engine Type	Honda GX390
Specifications	GX390K1QXC9
Maximum Horsepower*	13 HP (9.5kW)
Net Horsepower*	11 HP (8.2 kW)
Displacement – cu In (l)	23.7 cu in (0.39 l)
Bore – in (mm)	3.5" (88)
Stroke – in (mm)	2.5" (64)
Cylinders/Cycle	Single Cylinder 4 Cycle
Fuel Capacity – gal (l)	1.79 gal. (6.5 l)
Oil Capacity – qt (l)	1.16 qt. (1.1 l)
Air Filter	Four Stage Cyclone
Starter	Manual
Engine Cooling	Forced Air
SAW DIMENSIONS	
Height	39" (990)
Minimum Saw Length (Transport) – in (mm)	33-1/2" (850)
Maximum Saw Length (Working) – in (mm)	61-1/2" (1,561)
Maximum Pointer Length – in (mm)	20-7/8" (528)
Frame Width – in (mm)	16-1/2" (421)
Saw Width – in (mm)	22" (609)
Front (Outside to Outside Wheel Width) – in (mm)	10-7/16" (265)
Rear (Outside to Outside Wheel Width) – in (mm)	16-57/64" (429)
Blade to Wall – in (mm)	4-1/2" (114)
Wheel Base Length – in (mm)	13" (332)
Weight Crated – lbs. (kg)	240 (109)
Weight Uncrated – lbs (kg)	220 (100)

*= DATA PROVIDED BY MOTOR/ENGINE MANUFACTURER

GENUINE NORTON CLIPPER DIAMOND BLADE INCLUDED WITH SAW.

PRODUCT FEATURES



Fast Release Guard

The quick release pull pin keeps the blade guard locked down for safety during operation. No more jam nuts or tools needed - just pull and lift.



Tough Frame and Raised Axle

Thick, heavy-duty gauge metal frame endures the hardest of users and job sites. Resists twisting for a tried and true straight cut.

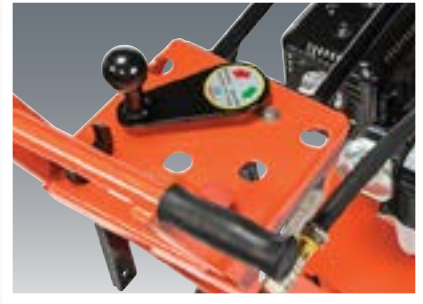

Uncomplicated Control Panel

Everything at your fingertips to manage the saw with ease: depth locking mechanism, emergency shut off and water valve within easy reach.



Rental equipment has to withstand any and all conditions by user and application. For that reason, the Norton Clipper C13PE suits any rental fleet that both the novice and expert will appreciate to hold-up through tough situations. The 18" blade guard, ride-on water system and quick-release blade guard lock all keep safety in mind while the rugged frame, powerful engine and easy-to-use console makes cutting a breeze.

TECHNICAL SPECIFICATIONS

PRODUCT #	C13PE
UPC	701846 47524
Blade Guard Capacity - in (mm)	18" (457)
Maximum Depth of Cut - in (mm)	6-5/8" (168)
Arbor Size - in (mm)	1" (25)
Blade Flange Diameter - in (mm)	4-1/2" (114)
Blade Shaft RPM	2,700
Blade Shaft Diameter - in (mm)	1.00" (25.4)
Blade Shaft Bearings	Heavy Duty Pillow Block
Blade Shaft Drive	3 Belts
Blade Guard Attachment	Hinged, All Steel
Blade Control	Hand Wheel/Screw Feed
Axle - Front - in (mm)	3/4" (19)
Axle - Rear - in (mm)	3/4" (19)
Wheels - Front - in (mm) D x W x B	4" x 1.5" x 3/4" (102 x 38 x 19)
Wheels - Rear - in (mm) D x W x B	8" x 2.50" x 3/4" (203 x 64 x 19)
Handle Bars/Adjustment Length - in (mm)	-NA-
Water Tank Capacity - gal (l)	-NA-
Control	Push
Chassis	Heavy Duty Box Design
Power Source	Gasoline, Single Cylinder 4 Cycle
Motor/Engine Type	Honda GX390
Specifications	GX390K1QXC9
Maximum Horsepower*	13 HP (9.5 kW)
Net Horse Power*	11 HP (8.2 kW)
Displacement - cu In (l)	23.7 cu in (0.39 l)
Bore - in (mm)	3-1/2" (88)
Stroke - in (mm)	2-1/2" (64)
Cylinders/Cycle	Single Cylinder 4 Cycle
Fuel Capacity - gal (l)	1.79 gal. (6.5 l)
Oil Capacity - qt (l)	1.16 qt. (1.1 l)
Air Filter	Four Stage Cyclone
Starter	Manual
Engine Cooling	Forced Air

SAW DIMENSIONS

Height - in (mm)	38-13/16" (986)
Minimum Saw Length (Transport) - in (mm)	42-3/4" (1086)
Maximum Saw Length (Working) - in (mm)	63" (1600)
Maximum Pointer Length - in (mm)	20" (508)
Frame Width - in (mm)	16-1/2" (419)
Saw Width - in (mm)	21-27/64" (544)
Front (Outside to Outside Wheel Width) - in (mm)	14-17/32" (369)
Rear (Outside to Outside Wheel Width) - in (mm)	19-9/32" (490)
Blade to Wall - in (mm)	1-23/32" (44)
Wheel Base Length - in (mm)	15-3/4" (400)
Weight Crated - lbs. (kg)	240 (109)
Weight - Uncrated - lbs (kg)	220 (100)

*= DATA PROVIDED BY MOTOR/ENGINE MANUFACTURER

GENUINE NORTON CLIPPER DIAMOND BLADE INCLUDED WITH SAW.

PRODUCT FEATURES



Adjustable Height Handle Bars
Stay-level handle bar system adjusts to four different positions for the utmost in operator comfort.



Quick Belt Tensioning
Easy to change V belts for fast and accurate belt tensioning.



Water Supply
Includes a water tank with garden hose fitting.



With extreme reliability, portability, and strong performance, the new full featured Norton Clipper C914P walk-behind saw is redefining the compact concrete saw class. The powerful Honda 9HP engine, 14" maximum blade capacity, and the strongest chassis in class make for the fastest and straightest cuts every time. Designed for easy transportation, simple operation, and low maintenance, the C914P is the right choice for contractors and rental. The C914P is equally at home cutting concrete, sidewalks, asphalt, or decorative concrete making it the perfect saw for any job.

TECHNICAL SPECIFICATIONS

PRODUCT #	C914P	NEW
UPC	70184608504	
Blade Guard Capacity - in. (mm)	14" (350)	
Maximum Depth of Cut - in. (mm)	4-1/2" (114)	
Arbor Size - in. (mm)	1" (25.4)	
Blade Flange Diameter - in. (mm)	4" (107)	
Blade Shaft RPM	2,840	
Blade Shaft Diameter - in. (mm)	7/8" (22)	
Blade Shaft Bearings	Heavy Duty Pillow Block	
Blade Shaft Drive	3 Belts	
Blade Guard Attachment	Hinged, All Steel	
Blade Control	Hand Wheel/Screw Feed	
Axle - Front - in (mm)	19/32" (15)	
Axle - Rear - in (mm)	25/32" (20)	
Wheels - Front - in (mm) D x W x B	3-15/16" x 1-3/8" x 0.59" (100 x 35 x 15)	
Wheels - Rear - in (mm) D x W x B	7-7/8" x 1-49/64" x 0.79" (200 x 45 x 20)	
Handle Bars/Adjustment Length	9-29/64" (245)	
Control	Push	
Chassis	Heavy Duty Box Design	
Water Tank Capacity - gal (l)	6.6 (25)	
Power Source	Gasoline, Single Cylinder 4 Cycle	
Motor/Engine Type	Honda	
Maximum Horsepower* (kW)	9 (6.7)	
Net Horse Power* (kW)	6.5 (4.8)	
Displacement - cu In (l)	16.5 (0.27)	
Bore - in (mm)	3.0 (77)	
Stroke - in (mm)	2-5/16" (58)	
Cylinders/Cycle	Single Cylinder 4 Cycle	
Fuel Capacity - gal (l)	1.4 (5.3)	
Oil Capacity - qt (l)	0.29 (1.1)	
Airfilter	Four Stage Cyclone	
Starter	Manual	
Engine Cooling	Forced Air	
SAW DIMENSIONS		
Height - in (mm)	37-59/64" (963)	
Minimum Saw Length (Transport) - in (mm)	35-37/64" (929)	
Maximum Saw Length (Working) - in (mm)	57-55/64" (1,469)	
Maximum Pointer Length - in (mm)	21-9/32" (541)	
Frame Width - in (mm)	12-47/64" (323)	
Saw Width - in (mm)	19" (483)	
Front (Outside to Outside Wheel Width) - in (mm)	12-47/64" (323)	
Rear (Outside to Outside Wheel Width) - in (mm)	13-45/64" (348)	
Blade to Wall - in (mm)	1-3/8" (35)	
Wheel Base Length - in (mm)	17-21/64" (440)	
Weight Crated - lbs. (kg)	198.4 lbs (90.6 kg)	
Weight - Uncrated - lbs (kg)	169.4 lbs (77 kg)	

*= DATA PROVIDED BY MOTOR/ENGINE MANUFACTURER

GENUINE NORTON CLIPPER DIAMOND BLADE INCLUDED WITH SAW.

PRODUCT FEATURES



Gasoline Engine

Mounted with the dependable Honda 5.5HP engine for best performance.



Front Blade Mount

10" blade guard capacity. Additional weight helps keep the blade in the cut.



Fold-Down Design

Easy storage and transport.



Having a powerful Honda 5HP engine, the GC55 saw cuts faster than any other saw we have. The roller system allows you to roll on a concrete slab and cut a straight line without any difficulty. The weight of the saw is fantastic, making it an extremely portable machine.

– Tony Psencik, Suncoast Post-Tension, Ltd.



With a compact, light-weight design backed by the reliable Honda 5HP gasoline engine, the GC55 early entry saw is intended for a variety of applications. From green, cured or decorative concrete cutting to expansion joints, the features of this small push saw are hard to beat in a single saw. The low, wide profile of the frame, along with the front mount blade, contribute to producing a more disciplined cut. Now available in two models; our standard GC55 or our new GC55 VAC with Vacuum Attachment System. The GC55 and GC55 VAC include a wet kit for additional dust control.

TECHNICAL SPECIFICATIONS

PRODUCT #	GC55	GC55VAC	NEW
UPC	701846 30005	701846 02860	
Blade Guard Capacity – in. (mm)	10" (254)		
Maximum Depth of Cut – in. (mm)	3-3/4" (95)		
Arbor Size – in. (mm)	5/8" (15.9)		
Blade Flange Diameter – in. (mm)	3-5/64" (78)		
Blade Shaft RPM	3,000		
Blade Shaft Diameter – in. (mm)	7/8" (20)		
Blade Shaft Bearings	Sealed Radial Bearings		
Blade Shaft Drive	1 Cogged		
Blade Guard Attachment	All Steel		
Blade Control	Screw Feed		
Axle – Front – in. (mm)	55/64" (22)		
Axle – Rear – in. (mm)	55/64" (22)		
Wheels – Front – in. (mm) D x W x B	3-3/8" x 2-3/4" x 25/32" (85 x 70 x 20)		
Wheels – Rear – in. (mm) D x W x B	3-3/8" x 2-3/4" x 25/32" (85 x 70 x 20)		
Handle Bars/Adjustment Length – in. (mm)	6" (152.4)		
Control	Push		
Chassis	Heavy Duty Stamped Steel with Reinforcements		
Power Source	Single Cylinder 4 Cycle		
Motor/Engine Type	Honda GX160		
Specifications	GX160K1QXC9		
Maximum Horsepower	5.5 HP (4.1 kW) – *		
Net Horse Power	4.8 HP (3.6 kW) – *		
Voltage	NA		
Cycle/Current/Phase	NA		
Full Load Amps	NA		
Starting Amps	NA		
Displacement – cu. In (l)	9.9 cu in (0.16 l)		
Bore – in. (mm)	2.7" (68)		
Stroke – in. (mm)	1.8" (45)		
Cylinders/Cycle	Single Cylinder 4 Cycle		
Fuel Capacity – gal. (l)	.95 (3.6 l)		
Oil Capacity – qt. (l)	.63 (.6 l)		
Air Filter	Four Stage Cyclone		
Starter	Manual		
Engine Cooling	Forced Air		

SAW DIMENSIONS

Height – in (mm)	24-7/32" (615)	
Minimum Saw Length (Transport) – in. (mm)	32" (813)	34-1/2" (876)
Maximum Saw Length (Working) – in. (mm)	42-29/32" (1,090)	51-29/32" (1,318)
Maximum Pointer Length – in. (mm)	8-7/32" (209)	
Frame Width – in. (mm)	13-11/16" (348)	17-13/32" (442)
Saw Width – in. (mm)	18-1/8" (460)	
Front (Outside to Outside Wheel Width) – in. (mm)	8-21/32" (220)	
Rear (Outside to Outside Wheel Width) – in. (mm)	13" (330)	
Blade to Wall – in. (mm)	7-1/2" (190)	
Wheel Base Length – in. (mm)	19" (483)	
Weight Crated – lbs (kg)	135 (61)	145 (66)
Weight Uncrated – lbs (kg)	115 (52)	125 (57)

ACCESSORIES

	UPC	SMART PART #
GC55 Vacuum Attachment Accessory Kit	701846 02861	233933

(Includes: Fully assembled cutting arm with belt guard, belt, and blade shaft. Blade guard with vacuum port and skirt, stay level arm, and all hardware. Does not include GC55 saw, vacuum or wet kit.

*= DATA PROVIDED BY MOTOR/ENGINE MANUFACTURER

GENUINE NORTON CLIPPER DIAMOND BLADE INCLUDED WITH SAW.



PRODUCT FEATURES



Compact Frame Design

Easy transport and even weight distribution with 3HP up-cut electric motor.



Vacuum Port

Attaches to standard vacuum for efficient debris removal.



Fold-Down Design

Ideal for decorative application where space is limited getting in and out.



The ideal saw for indoor cutting, expansion joint cleaning, crack control and other concrete surface preparation work. The GC25E UP carries a smooth running 3HP up-cut electric motor. Its vacuum port on the blade guard ensure debris is pulled out of the cut and into a collection system. Light-weight and compact, the GC25E UP is the perfect saw for any concrete surface or decorative contractor need.

TECHNICAL SPECIFICATIONS

PRODUCT #	GC25E UP
UPC	701846 42445
Blade Guard Capacity – in (mm)	10" (254)
Maximum Depth of Cut – in (mm)	3-3/4" (95)
Arbor Size – in (mm)	5/8" (15.9)
Blade Flange Diameter – in (mm)	3-5/64" (78)
Blade Shaft RPM	3,000
Blade Shaft Diameter – in (mm)	7/8" (20)
Blade Shaft Bearings	Sealed Radial Bearings
Blade Shaft Drive	1 Cogged
Blade Guard Attachment	All Steel
Blade Control	Screw Feed
Axle – Front – in (mm)	55/64" (22)
Axle – Rear – in (mm)	55/64" (22)
Wheels – Front – in (mm) D x W x B	3-3/8" x 2-3/4" x 25/32" (85 x 70 x 20)
Wheels – Rear – in (mm) D x W x B	3-3/8" x 2-3/4" x 25/32" (85 x 70 x 20)
Handle Bars/Adjustment Length – in (mm)	6" (152.4)
Control	Push
Chassis	Heavy Duty Stamped Steel with Reinforcements
Power Source	115/330 volt
Motor/Engine Type	Electric
Specifications	T.E.F.C. Thermal Protection
Maximum Horsepower*	3 HP
Net Horse Power*	3 HP
Voltage	115-230 Volts
Cycle*/Current/Phase	60Hz/AC/1
Full Load Amps*	19.5/9.73 Amps
Starting Amps*	91/46 Amps
Displacement – cu In (l)	-NA-
Bore – in (mm)	-NA-
Stroke – in (mm)	-NA-
Cylinders/Cycle	-NA-
Fuel Capacity – gal (l)	-NA-
Oil Capacity – qt (l)	-NA-
Air Filter	-NA-
Starter	Capacitor
Engine Cooling	Forced Air

SAW DIMENSIONS

Height – in (mm)	24-7/32" (615)
Minimum Saw Length (Transport) – in (mm)	32" (813)
Maximum Saw Length (Working) – in (mm)	42-29/32" (1,090)
Maximum Pointer Length – in (mm)	8-7/32" (209)
Frame Width – in (mm)	13-11/16" (348)
Saw Width – in (mm)	18-1/8" (460)
Front (Outside to Outside Wheel Width) – in (mm)	8-21/32" (220)
Rear (Outside to Outside Wheel Width) – in (mm)	13" (330)
Blade to Wall – in (mm)	7-1/2" (190)
Wheel Base Length – in (mm)	19" (483)
Weight Crated – lbs (kg)	155 (70.3)
Weight Uncrated – lbs (kg)	135 (61.2)

*= DATA PROVIDED BY MOTOR/ENGINE MANUFACTURER

GENUINE NORTON CLIPPER DIAMOND BLADE INCLUDED WITH SAW.

GMAX DIAMOND BLADES

Designed with a thicker core that resists flexing and provides a straighter cut with less spalling, GMAX makes quick work of early entry/green concrete cutting. The anchor slot gullets reduce vibration for less chipping. And, the exclusive universal arbor adapts to all models.



Anchor Slot Gullet Technology

Increases productivity by reducing vibration, for a smoother cut, while keeping the blade cool and extending life.



Thicker Core

Resists flexing and provides a straighter and faster cut for less spalling.

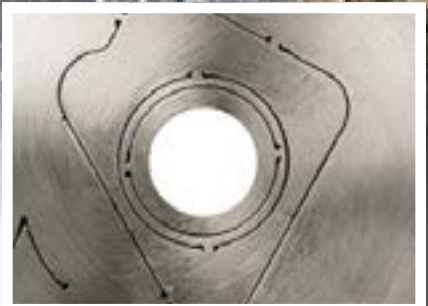

Exclusive Universal Arbor

Allows the GMAX blade to be used on most early entry/green concrete saws.

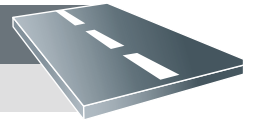

Asphalt and Abrasive Materials

Asphalt, green concrete, asphalt over concrete, abrasive blocks, mortar and other abrasive materials.

DRY – EARLY ENTRY

Having the right blade for green concrete cutting is essential to getting the smoothest cut without spalling. The GMAX diamond blade series with its anchor slot gullet technology reduces vibration that results in chipping and irregular cut patterns. A thick core, special bond and diamond combination allows the blade to cut faster on most all saws, with perfection. Available in three different matrixes to reduce your time on the job in any aggregate type.

GMAX – HARD AGGREGATE (PURPLE)

Offers the best friability of diamond to ensure the operator maintains a smooth cut in the hardest materials, like flint and chert.

UPC	SIZE	MAX RPM	SEGMENT HEIGHT	MAX POWER
70184641868	6 x .110 x 1-5/8 SC	10185	.413"	4.3hp
70184641863	8 x .110" x 1-7/8-5/8 SC	7640	.413"	6hp
70184641860	10 x .110 x 1-7/8-5/8 SC	6115	.413"	13hp



GMAX – MEDIUM/HARD AGGREGATE (RED)

For non-to-medium abrasive sand, granite and quartz type materials. The high-quality bond and diamond configuration, along with the core features of the red specification's anchor slot gullet design to reduce spalling, ensures a smooth, flawless cut.

UPC	SIZE	MAX RPM	SEGMENT HEIGHT	MAX POWER
70184641867	6 x .110 x 1-5/8 SC	10185	.413"	4.3hp
70184641864	8 x .110" x 1-7/8-5/8 SC	7640	.413"	6hp
70184641862	10 x .110 x 1-7/8-5/8 SC	6115	.413"	13hp



GMAX – MEDIUM/SOFT AGGREGATE (YELLOW)

The yellow segment specification makes early entry cutting easy in limestone, granite and other softer aggregate mixtures.

UPC	SIZE	MAX RPM	SEGMENT HEIGHT	MAX POWER
70184641866	6 x .110 x 1-5/8 SC	10185	.413"	4.3hp
70184641865	8 x .110" x 1-7/8-5/8 SC	7640	.413"	6hp
70184641861	10 x .110 x 1-7/8-5/8 SC	6115	.413"	13hp



DRY – GREEN/CURED CONCRETE

GMAX – MULTI-PURPOSE

Designed specifically for our GC55 down-cut green concrete push saw, the GMAX Multi-Purpose blade is excellent in both green and cured concrete. The unique segment specification and anchor slot gullet allows this blade to be used in a variety of applications with outstanding results.

UPC	PART #	SIZE	MAX RPM	SEGMENT HEIGHT	MAX POWER
70184683758	NXDGRN0895	8 x .095 x 7/8-5/8	7640	.393"	6hp
70184675125	EE9110	9 x .110 x 7/8-5/8	6790	.275"	6hp
70184684508	EE10110	10 x .110 x 1-7/8-5/8	6115	.275"	6hp



For precision green cutting, use the GMAX line of early entry blades, up to 10", on the **Norton Clipper GC55** push saw.

See page 46 for details.



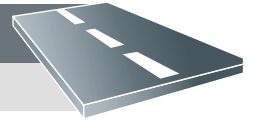

Asphalt and Abrasive Materials

Asphalt, green concrete, asphalt over concrete, abrasive blocks, mortar and other abrasive materials.

DRY – GREEN CONCRETE +

CHARGER

A high performance, laser welded blade designed for green concrete cutting. High quality segments produce a clean cut with reduced spalling on larger saws up to 20 HP in early entry applications.

UPC	PART #	SIZE	MAX RPM	SEGMENT HEIGHT	MAX POWER
70184681419	CGDGRN1201	12 x .125 x 1	5095	.263"	20hp
70184681420	CGDGRN1401	14 x .125 x 1	4365	.263"	20hp



DRY – ASPHALT +

CHARGER

High performance dry cutting all kinds of soft and abrasive materials. Excellent blade life and cut speed when dry cutting with 20 HP flat saws.

UPC	PART #	SIZE	MAX RPM	SEGMENT HEIGHT	MAX POWER
70184681412	CGDASP1420	14 x .125 x 1/20mm	5460	.288"	20hp



DRY – ASPHALT AND CONCRETE +

CLASSIC

Ideal blade for small-to-medium size jobs on low horsepower machines. Drop segment undercut protection reduces core wear when wet cutting in abrasive materials. Economically priced with good productivity in abrasive materials.

UPC	PART #	SIZE	MAX RPM	SEGMENT HEIGHT	MAX POWER
70184603329	CHDAOC1812	18 x .125 x 1	3395	.472"	20hp
70184603330	CHDAOC2015	20 x .150 x 1	3055	.472"	20hp

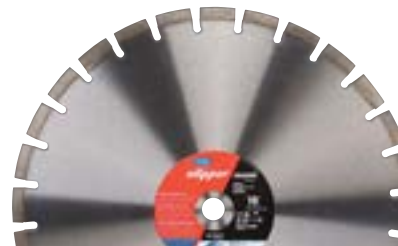

DRY – CRACK CHASING +

CHARGER

A heavy V-shaped segment designed with a special bond and diamond content for maximum removal of grout, mortar jointing, crack chasing and crack widening. Fast cutting and long life in abrasive materials using portable tools. Highly competitive to others of its kind in the market.

UPC	PART #	SIZE	MAX RPM	SEGMENT HEIGHT
70184683856 6	CGCC0400	4 x .375 x 7/8-5/8-20mm	15000	.550"
70184683859 7	CGCC0700	7 x .375 x 7/8-5/8-20mm	8730	.550"



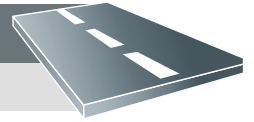

Asphalt and Abrasive Materials

Asphalt, green concrete, asphalt over concrete, abrasive blocks, mortar and other abrasive materials.

WET – GREEN CONCRETE



CLASSIC



Ideal blade for yielding a high return on performance to cost ratio. Segments are designed for faster cutting and longer life on smaller flat saws in green concrete.

UPC	PART #	SIZE	MAX RPM	SEGMENT HEIGHT	MAX POWER
70184681474	CHWGGP1412	14 x .125 x 1	4365	.295"	35hp
70184681475	CHWGGP1812	18 x .125 x 1	3395	.393"	35hp



WET – ASPHALT



CHARGER



For large road and construction jobs with saws up to 35 HP. Higher diamond content increases productivity and offers faster cutting and longer life in asphalt and green concrete applications.

UPC	PART #	SIZE	MAX RPM	SEGMENT HEIGHT	MAX POWER
70184681478	CGWASP1412	14 x .125 x 1	4365	.327"	35hp
70184683912	CGWASP1612	16 x .125 x 1	3820	.307"	35hp
70184681479	CGWASP1812	18 x .125 x 1	3395	.307"	35hp
70184683927	CGWASP2417	24 x .175 x 1	2550	.307"	35hp
70184683928	CGWASP2615	26 x .155 x 1	2350	.307"	35hp
70184683929	CGWASP3017	30 x .175 x 1	2040	.307"	35hp
70184684024	CGWASP3618	36 x .187 x 1	1700	.307"	35hp



CLASSIC



An economical choice for fast cutting and good life when performing jobs in a variety of abrasive materials such as green concrete and asphalt on saws up to 35 HP.

UPC	PART #	SIZE	MAX RPM	SEGMENT HEIGHT	MAX POWER
70184681374	CHWASP1411	14 x .110 x 1	5400	.326"	35hp
70184681375	CHWASP1412	14 x .125 x 1	4365	.326"	35hp
70184683895	CHWASP1612	16 x .125 x 1	3820	.326"	35hp
70184681376	CHWASP1812	18 x .125 x 1	3395	.326"	35hp
70184683897	CHWASP2012	20 x .125 x 1	3055	.326"	35hp
70184681476	CHWASP2415	24 x .155 x 1	2550	.326"	35hp
70184683900	CHWASP2418	24 x .187 x 1	2550	.326"	35hp
70184683899	CHWASP2615	26 x .155 x 1	2350	.326"	35hp
70184683903	CHWASP3018	30 x .187 x 1	2040	.326"	35hp



WET – ASPHALT OVER CONCRETE



CHARGER



Manufactured for asphalt over concrete and other abrasive materials cutting. Designed to run efficiently on flat saws up to 35 HP while producing an even clean cut.

UPC	PART #	SIZE	MAX RPM	SEGMENT HEIGHT	MAX POWER
70184681485	CGWAOAC1412	14 x .125 x 1	4365	.326"	35hp
70184681486	CGWAOAC1812	18 x .125 x 1	3395	.307"	35hp
70184681487	CGWAOAC2415	24 x .155 x 1	2550	.307"	35hp
70184683395	CGWAOAC2617	26 x .175 x 1	2350	.307"	35hp
70184683396	CGWAOAC3018	30 x .187 x 1	2040	.307"	35hp
70184683397	CGWAOAC3618	36 x .187 x 1	1700	.307"	35hp



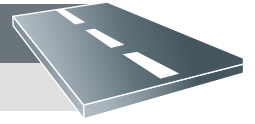

Asphalt and Abrasive Materials

Asphalt, green concrete, asphalt over concrete, abrasive blocks, mortar and other abrasive materials.

WET – ASPHALT OVER CONCRETE

CLASSIC

Lower cost but high performance blade ideal for general purpose cutting in asphalt over concrete applications on low horse power saws. Tailored with undercut protection to retard segment wear for maximum debris removal.

UPC	PART #	SIZE	MAX RPM	SEGMENT HEIGHT	MAX POWER
70184681482	CHWAOC1412	14 x .125 x 1	4365	.326"	35hp
70184681483	CHWAOC1812	18 x .125 x 1	8725	.326"	35hp



Reinforced Concrete and Harder Building Materials

Reinforced concrete, hard bricks, limestone, terrazzo, and other hard materials.

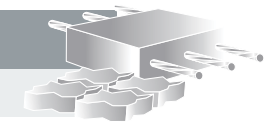

WET – MEDIUM AGGREGATES

CHARGER

The steel core is designed to keep the cut straight while the .410" segment height prolongs cutting wear. Suitable for cutting medium aggregates with 35 HP up to 72 HP flat saws.

UPC	PART #	SIZE	MAX RPM	SEGMENT HEIGHT	MAX POWER
70184681366	CGWCMD1412	14 x .125 x 1	4365	.327"	35hp
70184681368	CGWCMD1812	18 x .125 x 1	3395	.327"	35hp
70184683965	CGWCMD2012	20 x .125 x 1	3055	.413"	35hp
70184681468	CGWCMD2415	24 x .155 x 1	2550	.413"	35hp
70184681472	CGWCMD2615	26 x .155 x 1	2350	.413"	35hp
70184683969	CGWCMD3618	36 x .187 x 1	1700	.413"	35hp



CLASSIC

Laser welded blade at an economical price for general purpose cutting of cured concrete, medium hard aggregate and no steel reinforcement. The bond and diamond combination allow fast cutting action on limited horse powered flat saws.

UPC	PART #	SIZE	MAX RPM	SEGMENT HEIGHT	MAX POWER
70184681358	CHWCGP1411	14 x .110 x 1	4365	.326"	35hp
70184681359	CHWCGP1412	14 x .125 x 1	4365	.327"	35hp
70184681360	CHWCGP1612	16 x .125 x 1	3820	.327"	35hp
70184681361	CHWCGP1812	18 x .125 x 1	3395	.327"	35hp
70184681362	CHWCGP2012	20 x .125 x 1	3055	.327"	35hp
70184681465	CHWCGP2415	24 x .155 x 1	2550	.327"	35hp
70184683833	CHWCGP2615	26 x .155 x 1	2350	.307"	35hp
70184683386	CHWCGP3017	30 x .175 x 1	2040	.307"	35hp





Reinforced Concrete and Harder Building Materials

Reinforced concrete, hard bricks, limestone, terrazzo, and other hard materials.

WET – HARD AGGREGATES

PARADIGM

Paradigm technology combines a unique specification blend that increases blade speed and product life to optimize performance in multiple flat saw horsepower ranges and aggregate types.



UPC	PART #	SIZE	AGGREGATE	SEGMENT HEIGHT	MAX POWER
701846 46319 RDS	C1170	18 x .125 x 1	Soft	.460"	35 - 48hp
701846 46410	C2570	18 x .155 x 1	Hard	.460"	66hp
701846 46376	C2170	20 x .155 x 1	Soft	.457"	66hp
701846 46394	C2370	20 x .155 x 1	Medium	.460"	66hp
701846 46395 RDS	C2370R	24 x .155 x 1	Medium	.421"	66hp
701846 46325 RDS	C1170R	26 x .155 x 1	Soft	.460"	35 - 48hp
701846 46397 RDS	C2370R	26 x .155 x 1	Medium	.460"	35 - 48hp
701846 46326 RDS	C1170R	26 x .165 x 1	Soft	.460"	35 - 48hp
701846 46398 RDS	C2370R	26 x .165 x 1	Medium	.500"	66hp
701846 46384 RDS	C2160R	36 x .187 x 1	Soft	.539"	66hp
701846 46388	C2370	14 x .125 x 1	Medium	.460"	66hp
701846 46424	C2680	14 x .125 x 1	Hard	.510"	66hp
701846 46337	C1370	18 x .125 x 1	Medium	.460"	35 - 48hp
701846 46374	C2170	18 x .155 x 1	Soft	.460"	66hp
701846 46392	C2370	18 x .155 x 1	Medium	.460"	66hp
701846 46430	C2680HRAS	20 x .155 x 1	Hard	.510"	66hp
701846 46323 RDS	C1170R	24 x .155 x 1	Soft	.457"	35 - 48hp
701846 47288	C1370	24 x .175 x 1	Medium	.460"	35 - 48hp
701846 46361 RDS	C1570R	26 x .155 x 1	Hard	.457"	35 - 48hp
701846 46382 RDS	C2170R	30 x .165 x 1	Soft	.421"	66hp
701846 46400 RDS	C2370R	30 x .165 x 1	Medium	.540"	66hp
701846 46912 RDS	C3580	30 x .165 x 1	Hard	.540"	66hp
701846 47390 RDS	C2770R	30 x .175 x 1	Medium	.460"	66hp
701846 46402 RDS	C2360R	36 x .187 x 1	Medium	.413"	66hp
701846 46420 RDS	C2560R	36 x .187 x 1	Hard	.410"	66hp
701846 46475 RDS	C3360R	42 x .190 x 1	Medium	.540"	66hp
701846 46386 RDS	C2160R	48 x .190 x 1	Soft	.410"	66hp

CHARGER

High performance wet cutting hard aggregates with medium reinforcement. The increased diamond depth in the segment specification allows extended life and fast cut for medium to large jobs. Deep sawing is easily achieved on saws up to 35 HP.



UPC	PART #	SIZE	MAX RPM	SEGMENT HEIGHT	MAX POWER
701846 81363	CGWCHD1411	14 x .110 x 1	4365	.410"	35hp
701846 81365	CGWCHD1412	14 x .125 x 1	4365	.327"	35hp
701846 81367	CGWCHD1812	18 x .125 x 1	3395	.327"	35hp
701846 83918	CGWCHD2012	20 x .125 x 1	3055	.413"	35hp
701846 81467	CGWCHD2415	24 x .155 x 1	2550	.413"	35hp
701846 83919	CGWCHD2417	24 x .175 x 1	2550	.413"	35hp
701846 81471	CGWCHD2615	26 x .155 x 1	2350	.413"	35hp
701846 83920	CGWCHD3017	30 x .175 x 1	2040	.413"	35hp
701846 83921	CGWCHD3618	36 x .187 x 1	1700	.413"	35hp





RANGE OVERVIEW



MODEL#	BBL527	BBC207	BBM307	CST120 ALU
UPC#	70184683150	70184682501	70184600684	70184608390

MAX. BLADE CAPACITY	20" (508mm)	14" (177mm)	14" (355mm)	14" (350mm)
MAX. HP.	5 HP (3.7 kW)	2 HP (2.2 kW)	3 HP (1.5 kW)	2.45 HP (1.8 kW)

PRODUCT FEATURES



All Steel Frame

Super strong fillet welds deliver maximum strength and durability.



Sloped Front Water Pan

Allows complete control of the foot pedal and allows more control of depth of cut while reducing operator fatigue



Position of Cutting Head Blade Offset

Operator has a better view of material being cut and more stabilization of material on conveyor.



Having introduced the first masonry saw over 80 years ago, the Norton Clipper BBL heavy-duty block saws have become the industry standard for masons worldwide. Equipped in either electric or gas, these saws are available with single or three-phase electric motor as well as a more powerful 13HP gasoline engine. Having a rugged all-steel frame design with forklift brackets, these saws resist twisting and damage during transport around a job site. A blade capacity up to 24" and features of extended water pans and open back frame allows cutting of larger materials. The balanced cutting head makes for effortless cutting depth positioning.

TECHNICAL SPECIFICATIONS

PRODUCT #	BBL547	BBL527	BBL727	BBL5247	BBL7247
UPC – Single	701846 83211	701846 83150	NA	701846 30007	NA
UPC – 3 Phase	701846 83334	701846 83385	701846 83485	701846 30008	701846 30009
Blade Guard Capacity – in. (mm)	14" (355)	20" (508)	20" (508)	24" (609)	24" (609)
Maximum Depth of Cut – in. (mm)	5" (127)	8" (203)	8" (203)	10" (254)	10" (254)
Arbor Size – in. (mm)	1" (25)	1" (25)	1" (25)	1" (25)	1" (25)
Blade Flange Diameter – in. (mm)	4" (107)	4" (107)	4" (107)	4" (107)	4" (107)
Blade Shaft RPM	2,900	2,400	2,400	1,800	1,800
Blade Shaft Bearings	1" Heavy Duty Flange				
Blade Shaft Drive	2 Belt				
Blade Guard Attachment	All Steel, Stay Level				
Conveyor Cart	All steel cart, tilt-lock cart wheels, anti-skid surface, measuring rule; 45°/90° cutting guide				
Frame	Heavy-duty, jig-welded steel frame. Open construction for larger materials. Adjustable foot pedal and head height control.				
Water Pump	Electric – all electric saws have an electrical water pump				
Power Source	Electric				
Motor/Engine Type	Baldor				
Specifications	T.E.F.C. Thermal Protection				
Net Horsepower*	5 HP (3.7 kW)	5 HP (3.7 kW)	7-1/2 HP (5.6 kW)	5 HP (3.7 kW)	7-1/2 HP (5.6 kW)
Voltage	208-230 volts	208-230 volts	NA	208-230 volts	NA
3 PH – Voltage	230/460 volts	230/460 volts	230/460 volts	230/460 volts	230/460 volts
Cycle*/Current/Phase	60Hz/AC/1	60Hz/AC/1	NA	60Hz/AC/1	NA
3 PH – Cycle/Current/Phase	60Hz/AC/3	60Hz/AC/3	60Hz/AC/3	60Hz/AC/3	60Hz/AC/3
Full Load Amps*	20.6 Amp	20.6 Amp	16.8/8.4 Amps	20.6 Amp	16.8/8.4 Amp
Starter	Capacitor				
Motor/Engine Cooling	Air				
SAW DIMENSIONS					
Saw Length – in. (mm)	60" (1,524)	60" (1,524)	60" (1,524)	60" (1,524)	60" (1,524)
Saw Width – in. (mm)	26" (660)	26" (660)	26" (660)	26" (660)	26" (660)
Saw Height – in. (mm)	54" (1,372)	54" (1,372)	54" (1,372)	54" (1,372)	54" (1,372)
Maximum Arbor Height Over Table – in. (mm)	30" (762)	30" (762)	30" (762)	30" (762)	30" (762)
Cart Length – in. (mm)	16-1/2" (418.5)	16-1/2" (418.5)	16-1/2" (418.5)	16-1/2" (418.5)	16-1/2" (418.5)
Cart Width – in. (mm)	23" (584)	23" (584)	23" (584)	23" (584)	23" (584)
Pan Length – in. (mm)	43-1/8" (1,095)	43-1/8" (1,095)	43-1/8" (1,095)	43-1/8" (1,095)	43-1/8" (1,095)
Pan Width – in. (mm)	22-7/16" (569)	22-7/16" (569)	22-7/16" (569)	22-7/16" (569)	22-7/16" (569)
Weight Crated – lbs (kg)	475 (216)	475 (216)	475 (216)	475 (216)	475 (216)
Weight Uncrated – lbs (kg)	440 (199.5)	440 (199.5)	440 (199.5)	440 (199.5)	440 (199.5)
575 VOLT AND 600 VOLT, 3-PHASE OPTIONS AVAILABLE. ASK CUSTOMER SERVICE FOR MORE DETAILS					
ACCESSORIES	UPC	SMART PART #			
Electric Water Pump - PE-1	701846 68392	214169			
Conveyor Cart Replacement	003100 07390	083777			

*= DATA PROVIDED BY MOTOR/ENGINE MANUFACTURER

GENUINE NORTON CLIPPER DIAMOND BLADE INCLUDED WITH SAW.



Electric Water Pump



Conveyor Cart Replacement

PRODUCT FEATURES



Powerful Engine

Honda 13 HP engine with cyclone air filtration and power-enhancing jackshaft.



Accurate Adjustments

Ultra-strong foot pedal and hand wheel for exact depth adjustments make the BBL suitable for any cutting needs.



All-Steel Conveyor Cart

Long-lasting all-steel conveyor cart with tilt-lock wheels ensures smooth and precise cutting every time.



The Norton Clipper BBL series gasoline masonry saw features the powerful Honda GX390 engine with cyclone air filtration to meet any cutting needs. The BBL gas masonry saws feature a power-enhancing jack shaft that transmits more torque to the blade for faster cutting, and provides mechanical advantages to make for the easiest starting in colder weather. The BBL gas saw features the same rugged best-in-the-industry frame as the electric models. BBL series saws are designed with masons in mind and are available with 14", 20", and 24" blade capacities to meet your every need.

TECHNICAL SPECIFICATIONS

PRODUCT #	BBL1347	BBL1327	BBL13247
UPC – Single	701846 83214	701846 83212	701846 30010
UPC – 3 Phase	NA	NA	NA
Blade Guard Capacity – in. (mm)	14" (355)	20" (508)	24" (609)
Maximum Depth of Cut – in. (mm)	5" (127)	8" (203)	10" (254)
Arbor Size – in. (mm)	1" (25)	1" (25)	1" (25)
Blade Flange Diameter – in. (mm)	4" (107)	4" (107)	4" (107)
Blade Shaft RPM	2,900	2,400	1,800
Blade Shaft Bearings	1" Heavy Duty Flange		
Blade Shaft Drive	2 Belt		
Blade Guard Attachment	All Steel, Stay Level		
Conveyor Cart	All steel cart, tilt-lock cart wheels, anti-skid surface, measuring rule; 45°/90° cutting guide		
Frame	Heavy-duty, jig-welded steel frame. Open construction for larger materials. Adjustable foot pedal and head height control.		
Water Pump	Mechanically Belt Driven		
Power Source	Gasoline, Single Cylinder 4 Cycle		
Motor/Engine Type	Honda, GX390		
Specifications	GX390K1QXC9		
Net Horsepower*	11 HP (8.2 kW)	11 HP (8.2 kW)	11 HP (8.2 kW)
Voltage	NA	NA	NA
3 PH – Voltage	NA	NA	NA
Cycle*/Current/Phase	NA	NA	NA
3 PH – Cycle/Current/Phase	NA	NA	NA
Full Load Amps*	NA	NA	NA
Starter	Recoil	Recoil	Recoil
Motor/Engine Cooling	Air	Air	Air
SAW DIMENSIONS			
Saw Length – in. (mm)	60" (1,524)	60" (1,524)	60" (1,524)
Saw Width – in. (mm)	26" (660)	26" (660)	26" (660)
Saw Height – in. (mm)	57" (1,448)	57" (1,448)	57" (1,448)
Maximum Arbor Height Over Table – in. (mm)	30" (762)	30" (762)	30" (762)
Cart Length – in. (mm)	16-1/2" (418.5)	16-1/2" (418.5)	16-1/2" (418.5)
Cart Width – in. (mm)	23" (584)	23" (584)	23" (584)
Pan Length – in. (mm)	43-1/8" (1,095)	43-1/8" (1,095)	43-1/8" (1,095)
Pan Width – in. (mm)	22-7/16" (569)	22-7/16" (569)	22-7/16" (569)
Weight Crated – lbs (kg)	475 (216)	475 (216)	475 (216)
Weight Uncrated – lbs (kg)	440 (199.5)	440 (199.5)	440 (199.5)
575 VOLT AND 600 VOLT, 3-PHASE OPTIONS AVAILABLE. ASK CUSTOMER SERVICE FOR MORE DETAILS			
ACCESSORIES	UPC	SMART PART #	
BBL Mechanical Water Pump Assembly (pulley not included)	003100 04436	073279	
BBL Water Pump Pulley	003100 04883	076552	
Conveyor Cart Replacement	003100 07390	083777	

*= DATA PROVIDED BY MOTOR/ENGINE MANUFACTURER

GENUINE NORTON CLIPPER DIAMOND BLADE INCLUDED WITH SAW.



Mechanical Water Pump Assembly



Conveyor Cart Replacement

PRODUCT FEATURES



Water Pan Design

The extended length and open back make it easier for rip cutting of larger masonry materials.



Tilt-Locking Cart Wheels

Unique design that keeps conveyor in place with less shifting and smoother push/pull.



Stay Level Blade Guard

Full depth of cut.



Combines the performance of a full size masonry saw with the convenience of portability. Also available in gas or electric versions, the BBC saws have a rugged jig-welded frame, durable enough for even the heaviest work load. Available with 14" and 20" blade guard capacities making the BBC suitable for just about any job. Standard rear-wheel dolly design and removable legs make transport and set-up easy.

TECHNICAL SPECIFICATIONS

PRODUCT #	BBC157	BBC207	BBC307	BBC347
UPC	701846 82488	701846 82501	701846 30011	701846 08527
Blade Guard Capacity – in. (mm)	14" (177)	14" (177)	20" (508)	14" (177)
Maximum Depth of Cut – in. (mm)	5" (127)	5" (127)	8" (203)	5" (127)
Arbor Size – in. (mm)	1" (25)	1" (25)	1" (25)	1" (25)
Blade Flange Diameter – in. (mm)	4" (107)	4" (107)	4" (107)	4" (107)
Blade Shaft RPM	2,900	2,900	2,400	2,400
Blade Shaft Bearings	1" Heavy Duty Flange			
Blade Shaft Drive	1 Belt			
Blade Guard Attachment	All Steel, Stay Level			
Conveyor Cart	All steel cart, tilt-lock cart wheels, anti-skid surface, measuring rule; 45°/90° cutting guide			
Frame	Heavy-duty, jig-welded steel frame. Open construction for larger materials.			
Water Pump	Electric			
Power Source	Electric			
Motor/Engine Type	Baldor			
Specifications	T.E.F.C., Thermal Protection			
Net Horsepower*	1-1/2 HP (1.1 kW)	2 HP (1.5 kW)	3 HP (2.2 kW)	3 HP (2.2 kW)
Voltage	115/230 volts	115/230 volts	208-230 volts	208-230 volts
Cycle*/Current/Phase	60 Hz/AC/1	60 Hz/AC/1	60 Hz/AC/1	NA
Full Load Amps	13.4/6.7 Amps	16.8/8.4 Amps	13 Amps	13 Amps
Starter	Capacitor	Capacitor	Capacitor	Capacitor
Engine Cooling	Air	Air	Air	Air
Displacement – cu. In (l)	NA	NA	NA	NA
Bore – in. (mm)	NA	NA	NA	NA
Stroke – in. (mm)	NA	NA	NA	NA
Cylinders/Stroke	NA	NA	NA	NA
Fuel Capacity – gal. (l)	NA	NA	NA	NA
Oil Capacity – qt. (l)	NA	NA	NA	NA
Air Filter	NA	NA	NA	NA
SAW DIMENSIONS				
Saw Length – in. (mm)	60" (1,524)	60" (1,524)	60" (1,524)	60" (1,524)
Saw Width – in. (mm)	24" (609)	24" (609)	24" (609)	24" (609)
Saw Height – in. (mm)	34" (864)	34" (864)	34" (864)	34" (864)
Maximum Arbor Height Over Table – in. (mm)	24-1/2" (623)	24-1/2" (623)	24-1/2" (623)	24-1/2" (623)
Cart Length – in. (mm)	16" (404)	16" (404)	16" (404)	16" (404)
Cart Width – in. (mm)	19-3/8" (492)	19-3/8" (492)	19-3/8" (492)	19-3/8" (492)
Pan Length – in. (mm)	39-3/8" (1,000)	39-3/8" (1,000)	39-3/8" (1,000)	39-3/8" (1,000)
Pan Width – in. (mm)	18-1/8" (460)	18-1/8" (460)	18-1/8" (460)	18-1/8" (460)
Weight Crated – lbs (kg)	280 (127)	280 (127)	280 (127)	280 (127)
Weight Uncrated – lbs (kg)	250 (113)	250 (113)	250 (113)	250 (113)
ACCESSORIES				
	UPC	SMART PART #		
Electric Water Pump - PE-1	701846 68392	214169		
Conveyor Cart Replacement	003100 07367	083754		

*= DATA PROVIDED BY ENGINE MANUFACTURER
GENUINE NORTON CLIPPER DIAMOND BLADE INCLUDED WITH SAW.



Electric Water Pump

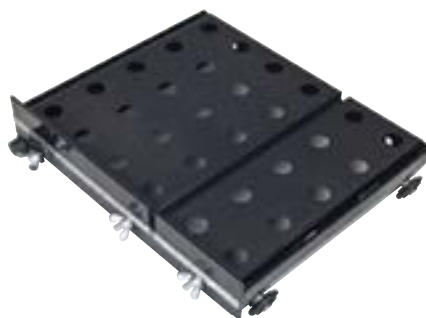

Conveyor Cart Replacement

PRODUCT FEATURES



Powerful Engine

Honda 5.5 HP engine with cyclone air filtration and power-enhancing jackshaft.



Tilt-Locking Cart Wheels

Built-in transport wheels and fork lift brackets make for easy moving of the BBC Gas Masonry saws.



Stay Level Blade Guard

Large, extreme-duty cart which can handle the largest and heaviest of materials with ease.



The Norton Clipper BBC series gasoline masonry saws are designed to make easy work of any masonry job. Featuring a jack-shaft system, which enhances the power to the blade, for the fastest cutting and most powerful portable gasoline saw available. All-steel reinforced extended-length frames allow rip cutting of blocks. With forklift brackets, front and rear carry handles, wheel dolly, heavy-duty sealed bearings, stay-level blade guard system, and the choice of 14" or 20" blade guard sizes, the BBC gasoline masonry saw has all the features needed to handle any job. The BBC gasoline masonry saws are designed to handle all of your cutting needs from block, brick, and stone, to pavers; the BBC is the professional's choice.

TECHNICAL SPECIFICATIONS

PRODUCT #	BBC547	BBC507
UPC	701846 82175	701846 30012
Blade Guard Capacity – in. (mm)	14" (177)	20" (508)
Maximum Depth of Cut – in. (mm)	5" (127)	8" (203)
Arbor Size – in. (mm)	1" (25)	1" (25)
Blade Flange Diameter – in. (mm)	4" (107)	4" (107)
Blade Shaft RPM	2,900	2,400
Blade Shaft Bearings	1" Heavy Duty Flange	1" Heavy Duty Flange
Blade Shaft Drive	1 Belt	1 Belt
Blade Guard Attachment	All Steel, Stay Level	All Steel, Stay Level
Conveyor Cart	All steel cart, tilt-lock cart wheels, anti-skid surface, measuring rule; 45°/90° cutting guide	
Frame	Heavy-duty, jig-welded steel frame. Open construction for larger materials. Adjustable foot pedal and head height control.	
Water Pump	Mechanically Belt Driven	Mechanically Belt Driven
Power Source	Gasoline	Gasoline
Motor/Engine Type	Honda GX200	Honda GX200
Specifications	GX200K1QXC9	GX200K1QXC9
Net Horsepower*	5.5 HP (4.1 kW)	5.5 HP (4.1 kW)
Voltage	NA	NA
Cycle*/Current/Phase	NA	NA
Full Load Amps	NA	NA
Starter	Recoil	Recoil
Engine Cooling	Forced Air	Forced Air
Displacement – cu. In (l)	11.96 cu. In (0.196 l)	11.96 cu. In (0.196 l)
Bore – in. (mm)	2.7" (68)	2.7" (68)
Stroke – in. (mm)	2.12" (54)	2.12" (54)
Cylinders/Stroke	Single Cylinder 4 Cycle	Single Cylinder 4 Cycle
Fuel Capacity – gal. (l)	.95 gal. (3.6 l)	.95 gal. (3.6 l)
Oil Capacity – qt. (l)	.63 at. (.6 l)	.63 at. (.6 l)
Air Filter	Four Stage Cyclone	Four Stage Cyclone
SAW DIMENSIONS		
Saw Length – in. (mm)	50" (1,270)	53" (1,346)
Saw Width – in. (mm)	24" (609)	24" (609)
Saw Height – in. (mm)	38" (965)	38" (965)
Maximum Arbor Height Over Table – in. (mm)	24-1/2" (623)	24-1/2" (623)
Cart Length – in. (mm)	16" (404)	16" (404)
Cart Width – in. (mm)	19-3/8" (492)	19-3/8" (492)
Pan Length – in. (mm)	39-3/8" (1,000)	39-3/8" (1,000)
Pan Width – in. (mm)	18-1/8" (460)	18-1/8" (460)
Weight Crated – lbs (kg)	305 (138)	305 (138)
Weight Uncrated – lbs (kg)	275 (125)	275 (125)
ACCESSORIES	UPC	SMART PART #
BBC Mechanical Water Pump Assembly (pump not included)	003100 04237	072305
BBC Water Pump Pulley	003100 04669	075270
Conveyor Cart Replacement	003100 07367	083754

*= DATA PROVIDED BY ENGINE MANUFACTURER

GENUINE NORTON CLIPPER DIAMOND BLADE INCLUDED WITH SAW.



Mechanical Water Pump Assembly

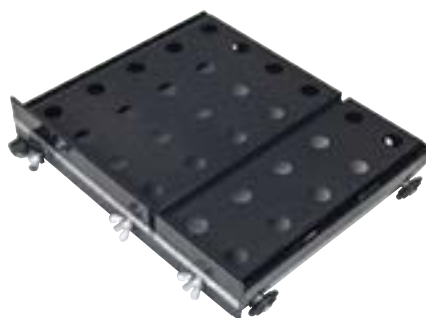

Conveyor Cart Replacement

PRODUCT FEATURES



All Steel Construction

All welded strong honeycomb reinforcement design.



Clear View Cutting System

Offset of motor and blade allows operator to see the complete cutting surface.



Wet or Dry Cutting

Quick attach garden hose water system. Using the included wet cutting system meets OSHA Silica dust control requirements.



The innovative design of the BBM307 small masonry saws has been copied many times due to its compact, all-steel unibody construction, giving the best weight-to-strength distribution. A 14" blade capacity and ergonomically-designed, three-position locking, cutting head provides a safe, clear view of the work area. The BBM307 features a powerful 3HP brush motor, overload protection, garden hose connection, and a channeled-flow water pan to direct dust and slurry away from the operator.

TECHNICAL SPECIFICATIONS

PRODUCT #	BBM307
UPC	701846 00684
Blade Guard Capacity – in. (mm)	14" (355)
Maximum Depth of Cut – in. (mm)	5" (127)
Arbor Size – in. (mm)	1" (25)
Blade Flange Diameter – in. (mm)	4" (100)
Blade Shaft RPM	3,600
Blade Shaft Bearings	Sealed Radial Bearings
Blade Shaft Drive	Gear Drive
Blade Guard Attachment	All Steel, Pivoting Posi-Loc Cutting Head
Conveyor Cart	Aluminum With Steel Wheels and Seale Bearings
Water Pump	Optional
Frame	Steel Reinforced Frame
Power Source	Electrical
Motor/Engine Type	AC Universal Motor
Specifications	Carbon Brush, Thermal Protection
Net Horsepower*	3 HP
Voltage	115 volts
Cycle*/Current/Phase	60Hz/AC/1
Full Load Amps	10 Amps
Starter	NA
Engine Cooling	Forced Air
Air Filter	Yes

SAW DIMENSIONS

Saw Length – in. (mm)	31-1/2" (800)
Saw Width – in. (mm)	18" (470)
Saw Height – in. (mm)	30" (762)
Maximum Arbor Height Over Table – in. (mm)	15-1/16" (383)
Cart Length – in. (mm)	10-7/16" (265)
Cart Width – in. (mm)	16-17/32" (420)
Pan Length – in. (mm)	30-1/8" (765)
Pan Width – in. (mm)	16" (405)
Weight Crated – lbs (kg)	90 (40.8)
Weight Uncrated – lbs (kg)	75 (34)

ACCESSORIES

	UPC	SMART PART #
Wet Kit	701846 00704	235003
Stand	701846 00691	235001
Conveyor Cart with Vacuum Attachment	701846 02862	233934

*= DATA PROVIDED BY ENGINE MANUFACTURER

GENUINE NORTON CLIPPER DIAMOND BLADE INCLUDED WITH SAW.



Wet Kit



Stand



Conveyor Cart with Vacuum Attachment

PRODUCT FEATURES



Powerful Induction Motor

Powerful long life dual voltage 115/230v commercial grade 1.5 HP induction motor.



Quiet Operation

Belt-driven blade shaft for smooth and quiet operation.



Less Mess

Channeled-flow water pan and conveyer cart direct dust and slurry away from the operator.



An evolutionary extension of the BBM307, the extremely portable BBM158 features a powerful, long-life commercial 1.5 HP induction motor which is designed for continuous cutting of bricks, block, pavers, stones, wall stones, and a variety of other masonry materials. The BBM158 motor has the ability to run on both 115v or 230v with a flick of a switch, allowing it to be used on most any job site. This machine is fully loaded with an all-steel honeycomb frame, heavy-duty conveyor cart with precision rollers for the straightest cuts, pivoting head for exact depth adjustments, belt-drive blade shaft for smoother and quieter operation, and includes a Norton Clipper 14" diamond blade for the fastest cutting; the BBM158 has all the features that professionals demand. If you want the most portable induction motor saw available, the BBM158 is the only choice.

TECHNICAL SPECIFICATIONS

PRODUCT #	BBM158
UPC	701846 26327
Blade Guard Capacity – in. (mm)	14" (355)
Maximum Depth of Cut – in. (mm)	5" (127)
Arbor Size – in. (mm)	1" (25)
Blade Flange Diameter – in. (mm)	4" (100)
Blade Shaft RPM	2,800
Blade Shaft Bearings	Sealed Radial Bearings
Blade Shaft Drive	Belt Drive
Blade Guard Attachment	All Steel, Pivoting Cutting Head
Conveyor Cart	Aluminum With Steel Wheels and Seale Bearings
Water Pump	Optional
Frame	Steel Reinforced Frame
Power Source	Electrical
Motor/Engine Type	Induction
Specifications	T.E.F.C., Thermal Protection
Net Horsepower*	1-1/2 HP
Voltage	115/230 volts
Cycle*/Current/Phase	60Hz/AC/1
Full Load Amps	15 Amps
Starter	NA
Engine Cooling	Forced Air
Air Filter	NA

SAW DIMENSIONS

Saw Length – in. (mm)	31-1/2" (800)
Saw Width – in. (mm)	18" (470)
Saw Height – in. (mm)	27-3/4" (695)
Maximum Arbor Height Over Table – in. (mm)	16-17/32" (420)
Cart Length – in. (mm)	10-7/16" (265)
Cart Width – in. (mm)	16-17/32" (420)
Pan Length – in. (mm)	30-1/8" (765)
Pan Width – in. (mm)	16" (405)
Weight Crated – lbs (kg)	150 (68)
Weight Uncrated – lbs (kg)	123.2 (56)

ACCESSORIES

	UPC	SMART PART #
Wet Kit	701846 00704	235003
Stand	701846 00691	235001
Conveyor Cart with Vacuum Attachment	701846 02862	233934

*= DATA PROVIDED BY ENGINE MANUFACTURER

GENUINE NORTON CLIPPER DIAMOND BLADE INCLUDED WITH SAW.



Wet Kit



Stand



Conveyor Cart with Vacuum Attachment

PRODUCT FEATURES

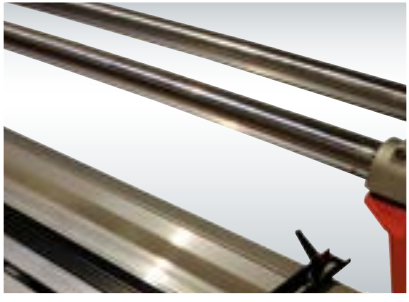

Guiding Bars

Strong chrome-plated guiding bars for high precision cutting.



Tilting Head

Allows cuts up to 45°.



Side Extension Table

Lets you easily adapt to different width materials.



As materials became longer, heavier, thicker and harder, an alternative solution was needed. With its long cutting lengths and powerful motor, coupled with a strong and robust frame to support heavy materials, this is the solution for the future of tile cutting.

The CST Series is designed to handle heavier and larger materials than a traditional masonry or tile saw for precision cutting of masonry, stone, flooring, and tile products. It allows miter cutting of material up to 45° and designed to cut materials up to 47-1/4" (1.2 m) in length. The CST120 ALUMINUM is a lightweight solution when mobility is the priority. It is a powerful machine offering long cutting lengths, folding legs, and transport wheels making it easy to transport.

TECHNICAL SPECIFICATIONS

PRODUCT #	CST120	CST120 ALU
UPC	701846 08389	701846 08390
Blade Guard Capacity – in. (mm)	14" (350)	14" (350)
Maximum Depth of Cut 90°– in. (mm)	4-5/16" (110)	4-5/16" (110)
Maximum Depth of Cut 45°– in. (mm)	3-15/64" (82.5mm)	3-15/64" (82.5mm)
Maximum Length of Cut – in. (mm)	47-1/4" (1,200)	47-1/4" (1,200)
Maximum Material Height - in. (mm)	5-7/64" (130)	5-7/64" (130)
Arbor Size – in. (mm)	1" (25.4)	1" (25.4)
Blade Flange Diameter – in. (mm)	4" (107)	4" (107)
Blade Shaft RPM	2,800	2,800
Blade Shaft Bearings	Sealed	Sealed
Blade Shaft Drive	Direct	Direct
Blade Guard Attachment	All Steel, with Intergrated Water System	All Steel, with Intergrated Water System
Conveyor Cart	Fixed Table	Fixed Table
Water Pump	Electric	Electric
Frame	Steel	Aluminum
Power Source	Electric	Electric
Motor/Engine Type	CEP	CEP
Specifications	T.E.F.C. Thermal Protection	T.E.F.C. Thermal Protection
Net Horsepower*	2.4 HP (1.80 kW)	2.4 HP (1.80 kW)
Voltage	115v	115v
Cycle*/Current/Phase	60Hz/AC/1	60Hz/AC/1
Full Load Amps	16 A	16 A
Starter	Capacitor	Capacitor
SAW DIMENSIONS	UPC	SMART PART #
Saw Length – in. (mm)	63" (1,600)	64-13/64" (1,630)
Saw Width – in. (mm)	26" (660)	26" (660)
Saw Height – in. (mm)	30-45/64" (1,350)	30-45/64" (1,350)
Maximum Arbor Height Over Table – in. (mm)	12-7/64" (307.5)	12-7/64" (307.5)
Table Length – in. (mm)	51-45/64" (1,315)	51-45/64" (1,315)
Table Width – in. (mm)	21-1/2" (545)	21-1/2" (545)
Pan Length – in. (mm)	61" (1,550)	61" (1,550)
Pan Width – in. (mm)	25-39/64" (650)	25-39/64" (650)
Weight Crated – lbs (kg)	392 (178 kg)	238 (108 kg)
Weight Uncrated – lbs (kg)	352 (160 kg)	198 (90 kg)
ACCESSORIES	UPC	SMART PART #
Slide Stop	003104 78996	310478 996
Side Extension Flat (0.55 x 0.45 M)	003104 79000	310479 000
Side Extension with Rolls (1 x 0.50 M)	003104 78999	310478 999
Wheel Transport with Handles	701846 08424	701846 08424
Laser Cutting Guide with Hardware	701846 08425	701846 08425
Angle Guide	003104 79001	310479 001
Water Pump 115v/60Hz/1	701846 08427	701846 08427

*= DATA PROVIDED BY ENGINE MANUFACTURER

GENUINE NORTON CLIPPER DIAMOND BLADE INCLUDED WITH SAW.



Slide Stop



Side Extension Flat (0.55 x 0.45 M)



Side Extension with Rolls (1 x 0.50 M)

get the silent treatment **AND ENJOY EVERY MINUTE**

Defying everything you've heard before, the Norton Clipper Silencio is more than just a sandwiched silent blade. We take sound dampening to another level by reducing noise up to 15 dB(A). Masons enjoy the patented technology performance benefits while nearby workers and onlookers enjoy quieter times.

If cost is a factor, try the new Silencio Charger that cuts noise with a unique more economical sandwich core design.

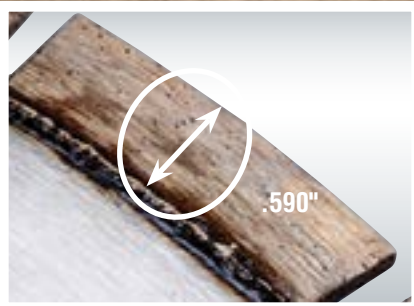

.590" Segment Height
New specification provides premium life and performance.



New Gullet Design
Reduces cutting noise by as much as 15 db(A).



Patent-Pending Steel Center
Design absorbs noise and vibration.

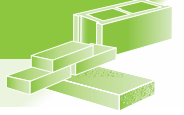

General Purpose and Masonry Building Materials

Blocks, medium-hard building bricks, paving slabs, concrete roof tiles and other medium-hard materials.

WET – SEGMENTED RIM



SILENCIO



With a laser-welded segment height up to .590" and newly developed specification, this blade maximizes cutting performance and product life when wet cutting hard natural stone materials. And, it's quieter – reducing cutting noise by up to 15 dB(A), thanks to the use of high-technology materials and a patent-pending steel-center design. Safer for high traffic environments and less disruptive to work locations.

UPC	PART #	SIZE	MAX RPM	SEGMENT HEIGHT
70184684534	SILMBR14125	14 x .125 x 1	4365	.590"
70184684535	SILMBR20125	20 x .125 x 1	3055	.590"



SILENCIO CHARGER **NEW**



A more economical silent core design, serrated segment shape, and longer life formula increase the material cutting range and blade life while reducing noise. A perfect solution when cutting in sound sensitive work areas.

UPC	PART #	SIZE	MAX RPM	SEGMENT HEIGHT
70184603318	SILCG14122	14 x .122 x 1	4365	.472"



CHARGER



High performance wet cutting with an extra wide .263" segment specification that allows thorough cleaning and extended life in a variety of materials.

UPC	PART #	SIZE	MAX RPM	SEGMENT HEIGHT
70184681338	CGWMGP1401	14 x .100 x 1	4365	.275"
70184681339	CGWMGP2001	20 x .125 x 1	3055	.263"



CLASSIC



The softer bond provides longer life at an economical price for small to medium size jobs on compact masonry saws.

UPC	PART #	SIZE	MAX RPM	SEGMENT HEIGHT
70184681331	CHWMGP1401	14 x .100 x 1	4365	.275"
70184681332	CHWMGP2001	20 x .125 x 1	3055	.263"





General Purpose and Masonry Building Materials

Blocks, medium-hard building bricks, paving slabs, concrete roof tiles and other medium-hard materials.

DRY – SEGMENTED RIM +

DUO MASONRY

The innovative, exclusive DUO design introduced in 2002 has become a dominant name in the market. The unique dual segment per land technology provides excellent cutting speed with low vibration and high comfort of cut. A special sound dampened laser cut core reduces noise when cutting. The exclusive arrow shape gullets not only indicate blade direction but they also assist in fast removal of cutting debris. Maximum performance when cutting a variety of materials.

UPC	PART #	SIZE	MAX RPM	SEGMENT HEIGHT
70184683982	DUODMGP1401	14 x .110 x 1	4365	.472"



CHARGER

High performance dry cutting of a variety of materials. The segment specification allows extended life and fast cut for medium to large jobs.

UPC	PART #	SIZE	MAX RPM	SEGMENT HEIGHT
70184681428	CGDMGP1401	14 x .100 x 1	4365	.263"
70184681429	CGDMGP2001	20 x .125 x 1	3055	.263"



CLASSIC

The bond provides longer life at an economical price for small to medium size jobs on smaller compact masonry saws cutting a combination of brick and soft block.

UPC	PART #	SIZE	MAX RPM	SEGMENT HEIGHT
70184684248	CODMGP7H2001	20 x .140 x 1	4365	.275"
70184684251	CODMGP10H2001	20 x .165 x 1	3055	.393"



VALUPLUS

For value and performance on small to medium size jobs. The sintered blade cuts unreinforced soft to medium concrete fast on saws up to 13 HP.

UPC	PART #	SIZE	MAX RPM	SEGMENT HEIGHT
70184684181	VPHSGP1420	14 x .110 x 1/20mm	5460	.393"
70184684428	VPHSGP1420 20PK	14 x .110 x 1/20mm	5460	.393"



DRY – TURBO RIM +

CHARGER

Combines the characteristics of standard Charger blade with a turbo rim configuration for cutting hard, dense materials with minimal effort. A better bond and diamond concentration for maximum cutting speed, life and quality of cut.

UPC	PART #	SIZE	MAX RPM	SEGMENT HEIGHT
70184684525	CGHSTS1420	14 x .125 x 1/20mm	5460	.472"





Reinforced Concrete and Harder Building Materials

Reinforced concrete, hard bricks, limestone, terrazzo, and other hard materials.

DRY – SEGMENTED RIM



DUO EVO



The unique shape of the DUO EVO and DUO segments optimizes the angle of attack while enhancing the evacuation of the particles. The result is an exceptional cutting speed allied with optimum performance life up to 50% over other blades in critically hard materials.

UPC	PART #	SIZE	MAX RPM	SEGMENT HEIGHT
70184684218	DUOEVO14118	14 x .118 x 1/20mm	5460	.590"
70184693356	DUOEVO16125	16 x .130 x 1/20mm	4500	.472"



DUO



The original DUO. The innovative, exclusive design introduced in 2002 has become a dominant name in the market. The unique dual segment per land technology provides excellent cutting speed with low vibration and high comfort of cut. The exclusive arrow shape gullets not only indicate blade direction but they also assist in fast removal of cutting debris. Maximum performance when cutting medium to hard materials – general purpose.

UPC	PART #	SIZE	MAX RPM	SEGMENT HEIGHT
70184683612	DUO14110	14 x .110 x 1/20mm	5460	.393"
70184684430	DUO14110 6PK	14 x .110 x 1/20mm	5460	.393"
70184683613	DUO14125	14 x .125 x 1/20mm	5460	.393"
70184684432	DUO14125 6PK	14 x .125 x 1/20mm	5460	.393"
70184683798	DUO16125	16 x .125 x 1/20mm	4500	.393"



CHARGER



High performance when on all kinds of hard materials. Smooth, fast and accurate cuts when dry cutting on larger masonry saws.

UPC	PART #	SIZE	MAX RPM	SEGMENT HEIGHT
70184681426	CGDMBR1401	14 x .100 x 1	4365	.263"
70184681427	CGDMBR2001	20 x .125 x 1	3055	.263"
70184684509	CGDMBR2101	21 x .125 x 1	2905	.350"
70184684556	CODMBR2401	24 x .150 x 1	2550	.275"



CLASSIC



Laser welded blades for hard or dense materials. Softer bond with premium diamond for fast cutting of hard material on low horsepower compact masonry saws. The perfect blade for compact masonry saws cutting hard or dense materials with limited power supply.

UPC	PART #	SIZE	MAX RPM	SEGMENT HEIGHT
70184684511	CHDMBR2001	20 x .125 x 1	3055	.263"
70184684557	CODMBL2401	24 x .165 x 1	2550	.275"



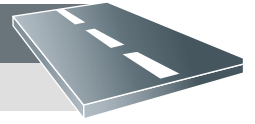

Asphalt and Abrasive Materials

Asphalt, green concrete, asphalt over concrete, abrasive blocks, mortar and other abrasive materials.

DRY – SEGMENTED RIM

CHARGER

High performance wear-resistant bond for dry cutting all kinds of soft and abrasive materials. Excellent blade life and cut speed when cutting on large upright masonry saws for commercial production.

UPC	PART #	SIZE	MAX RPM	SEGMENT HEIGHT
70184681330	CGDMBL1401	14 x .100 x 1	4365	.326"
70184681424	CGDMBL2001	20 x .125 x 1	3055	.326"
70184684510	CGDMBL2101	21 x .125 x 1	2905	.326"



CLASSIC

Ideal blade for small to medium size jobs with masonry saws. Economically priced with good productivity in abrasive materials.

UPC	PART #	SIZE	MAX RPM	SEGMENT HEIGHT
70184681325	CHDMBL1401	14 x .100 x 1	4365	.326"
70184603329	CHDAOC1812	18 x .125 x 1	3395	.472"
70184684511	CHDMBR2001	20 x .125 x 1	3055	.326"
70184603330	CHDAOC2015	20 x .150 x 1	3055	.472"



VALUPLUS

Dry cutting sintered segment blade for abrasive materials. Drop-segment wear-retardant extends life of core. Economically priced with good performance in asphalt, green concrete and other abrasive materials.

UPC	PART #	SIZE	MAX RPM	SEGMENT HEIGHT
70184603333	VPHSABR14125	14 x .125 x 1/20mm	5460	.452"



Norton Clipper Classic and ValuPlus

These Classic blades are an exceptional choice for general purpose wet or dry cutting on low horsepower saws. Soft enough to handle concrete but with drop segments on the core to maximize segment life when cutting abrasive materials like asphalt and block.

When a more economical solution is what you're after, try the new ValuPlus sintered segment blade for abrasive materials.



Natural Stone and Tiles

Ceramic and stone tiles, granite, marble, very hard bricks and other very hard and dense materials.

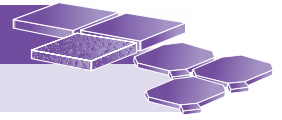

WET – SEGMENTED RIM – HARD REFRACTORIES, TILES



CHARGER



High performance wet cutting of a variety of materials. Industrial grade segment specification allows extended life and fast cut on refractory materials with 80% plus alumina.

UPC	PART #	SIZE	MAX RPM	SEGMENT HEIGHT
70184681348	NXWRHD1401	14 x .095 x 1	4365	.326"
70184681456	NXWRHD1801	18 x .125 x 1	3395	.326"
70184681457	NXWRHD2001	20 x .125 x 1	3055	.326"



NORTON CLIPPER CLASSIC



An economical solution for small to medium size jobs. Efficient cutting of thick granite, marble and refractory materials with 50% or less alumina.

UPC	PART #	SIZE	MAX RPM	SEGMENT HEIGHT
70184681453	CGWRGP1401	14 x .100 x 1	4365	.250"
70184681454	CGWRGP1801	18 x .125 x 1	3395	.250"
70184681455	CGWRGP2001	20 x .125 x 1	3055	.250"



WET – CONTINUOUS RIM – HARD REFRACTORIES, TILES



SLICER



Razor like cut, but with high tensile strength steel core for greater accuracy and less wobbling. The bond and diamond specification enhance cutting speed and improve blade life, particularly in hard materials for premium performance.

UPC	PART #	SIZE	MAX RPM	RIM HEIGHT
70184684186	NXSLC1201	12 x .080 x 1	5095	.393"
70184684187	NXSLC1401	14 x .080 x 1	4365	.393"



DRY – TURBO RIM – GRANITE, MARBLE, TILES



AERO-JET



Very fast, smooth cutting. The .590" high diamond rim adds extremely long life whether cutting dry in hard materials. Exclusive arrow shape protection inserts for precision straight cuts. A ventilated waved steel core for better cooling and intensive use. Exceptional cutting on a very wide range of materials with a high quality finished cut.

UPC	PART #	SIZE	MAX RPM	RIM HEIGHT
70184683785	AEROHS1420	14 x .125 x 1/20mm	5460	.590"



Multi-Purpose, All Materials

Concrete, reinforced concrete, granite, building materials, thin steel sections, angle iron up to 1/2" material thickness, rebar up to no. 5.



DRY – SEGMENTED RIM – SOFT TO HARD AGGREGATES



4X4



Multi-purpose laser welded blade for dry cutting a range of construction materials without sacrificing performance or price. Depth of cut is easily controlled with the patented depth-of-cut indicators cut into the steel core. Anti-crack gullets for enhanced safety cutting steel and metal (up to 5mm thick).

UPC	PART #	SIZE	MAX RPM	SEGMENT HEIGHT
70184684547	4X414125	14 x .125 x 1/20mm	5460	.393"
70184645306	4X416125	16 x .125 x 1/20mm	4500	.393"





RANGE OVERVIEW



MODEL#

CTC1020XL

CTC705

CTC701

TC405

UPC#

70184630013

70184681496

70184630029

70184682709

**BLADE GUARD
SIZE**

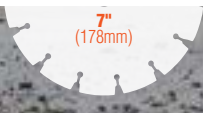

**MAX.
HP.**

2 HP (1.5 kW)

1 HP (0.7 kW)

1.5 HP (1.1 kW)

0.5 HP (0.4 kW)

PRODUCT FEATURES



2HP Motor

More powerful than using conventional 1.5HP and can make a rip cut of 24" tile.



Light-Weight

60 lbs vs. standard 100-125 lbs for easier transportation.



Aluminum Rails with Stainless Insert

Provides long life and easy portability due to low coefficient of friction, creating smoother slide.



Built with the professional in mind, the CTC1020XL is the newest to the tile industry. The powerful 2HP motor makes ripping materials, up to 24", trouble-free. The combination of having a light-weight, sturdy frame and a newly designed polypropylene pan, to help reduce area contamination, gives an operator all the essentials to get the job done quickly and efficiently.

TECHNICAL SPECIFICATIONS

PRODUCT #	CTC1020XL	
UPC	701846 30013	
Blade Guard Capacity – in. (mm)	10" (254)	
Maximum Depth of Cut – in. (mm)	3-3/4" (88)	
Arbor Size – in. (mm)	5/8"	
Blade Flange Diameter – in. (mm)	3 (78)	
Blade Shaft RPM	3,000	
Maximum Material Size – in. (mm)	24" x 24"	
Rip Cut Size – in. (mm)	24" (610)	
Diagonal Size – in. (mm)	18" (457)	
Cut Depth – in. (mm)	3-3/4" (95)	
Cutting Head	Cast Aluminum	
Built-In 45° Miter Cut	NO, Includes Miter Block	
Cutting Table	Aluminum With Rubber Coating	
Water Pump	YES	
Power Source	Electric	
Motor/Engine Type	Brush Motor with Thermal Protection	
Maximum Horsepower*	2 HP	
Voltage	115 volt	
Cycle*/Current/Phase	60 Hz/AC/1	
Full Load Amps	8 Amp	
SAW DIMENSIONS		
Saw Length – in. (mm)	51-7/8" (1,318)	
Saw Width – in. (mm)	25-3/16" (640)	
Saw Height – in. (mm)	20-7/8" (530)	
Saw Height With Stand – in. (mm)	41-13/16" (1,240)	
Arbor to Top of Cart – in. (mm)	4-3/4" (120)	
Cart (Table) Length – in. (mm)	16" (406)	
Cart (Table) Width – in. (mm)	16-9/64" (410)	
Cart Travel – in. (mm)	22-5/8" (575)	
Pan Length – in. (mm)	51-7/8" (1,318)	
Pan Width – in. (mm)	25-3/16" (640)	
Weight Crated – lbs (kg)	75 (34)	
Weight Uncrated – lbs. (kg)	65 (29.5)	
ACCESSORIES		
Electric Water Pump - PE-1	UPC 701846 68392	SMART PART # 214169
Premium Stand w/Work Table	701846 43045	242098
Adjustable Angle Guide	701846 80907	233043

*= DATA PROVIDED BY ENGINE MANUFACTURER
GENUINE NORTON CLIPPER DIAMOND BLADE INCLUDED WITH SAW.



Electric Water Pump



Premium Stand with Work Table



Adjustable Angle Guide

PRODUCT FEATURES



Motor Upgrade

Strong belt-driven 1 HP motor provides powerful and precise cutting.

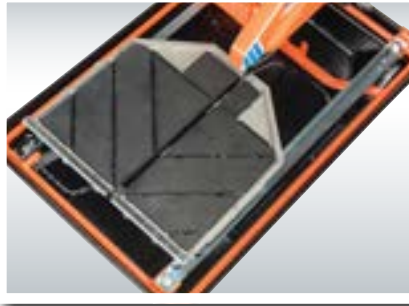

Light-Weight Conveyor

Smooth slide creates straight cuts and has a locking mechanism for easier transportation.



Water Pump

High intake and output to keep fresh water in pan with a durable filter to keep debris out.



A great value for a 7" tile saw that can handle the small to medium size jobs. This saw has many features of more expensive tile saws, like a belt-driven 1 HP motor for maximum motor-to-blade power. A sturdy aluminum cutting table with anti-skid top for keeping material in place while cutting and a light-weight water pan for easy cleaning and/or single operator use getting on and off the site.

TECHNICAL SPECIFICATIONS

PRODUCT #	CTC705	
UPC	701846 81496	
Blade Guard Capacity – in. (mm)	7" (177)	
Maximum Depth of Cut – in. (mm)	2-1/4" (57)	
Arbor Size – in. (mm)	5/8"	
Blade Flange Diameter – in. (mm)	2-1/2" (66)	
Blade Shaft RPM	6,000	
Maximum Material Size – in. (mm)	17" (431)	
Rip Cut Size – in. (mm)	17" (431)	
Diagonal Size – in. (mm)	12" (305)	
Cut Depth – in. (mm)	1-3/4" (44.5)	
Cutting Head	Cast Aluminum	
Built-In 45° Miter Cut	No	
Cutting Table	Aluminum	
Water Pump	Yes	
Power Source	Electric	
Motor/Engine Type	Carbon Brush	
Maximum Horsepower*	1 HP (075kW)	
Voltage	115 volt	
Cycle*/Current/Phase	60 Hz/AC/1	
Full Load Amps	10 Amps	
SAW DIMENSIONS		
Saw Length – in. (mm)	30" (762)	
Saw Width – in. (mm)	19-3/4" (502)	
Saw Height – in. (mm)	17-1/2" (445)	
Saw Height With Stand – in. (mm)	47-3/4" (1,213)	
Arbor to Top of Cart – in. (mm)	Adjustable	
Cart (Table) Length – in. (mm)	14-1/4" (362)	
Cart (Table) Width – in. (mm)	15" (381)	
Cart Travel – in. (mm)	18-3/4" (477)	
Pan Length – in. (mm)	30" (762)	
Weight Crated – lbs. (kg)	50 (22.7)	
Weight Uncrated – lbs. (kg)	43 (19.5)	
ACCESSORIES		
Electric Water Pump - PE-1	UPC 701846 68392	SMART PART # 214169
Premium Stand w/Work Table	701846 43045	242098
Adjustable Angle Guide	701846 80907	233043

*= DATA PROVIDED BY ENGINE MANUFACTURER
GENUINE NORTON CLIPPER DIAMOND BLADE INCLUDED WITH SAW.



Electric Water Pump



Premium Stand with Work Table



Adjustable Angle Guide

PRODUCT FEATURES



Built-In Water Pan

Single unit design with optimized water recycling.



Chrome Steel Tilting Table

Convenient for miter cutting of 0-45° cuts with a tilt design to allow for quicker blade changes.



Quick Locking Rip Guide

Secures guide position for precise cuts.



Recommended Blade Upgrade

ValuPlus Continuous Rim
See page 89

The simple design of the tabletop tile saw features a powerful professional motor that veterans and novices alike will enjoy operating. Its solid construction incorporates a self-contained water pan with plug release, tilting table for miter cuts and a fast, precise lockable cutting guide. The robust carrying case allows for easy transportation or storage while protecting the unit.

TECHNICAL SPECIFICATIONS

PRODUCT #	CTC701
UPC	70184630029
Blade Guard Capacity – in. (mm)	7" (177)
Maximum Depth of Cut – in. (mm)	2-1/4" (57)
Arbor Size – in. (mm)	5/8"
Blade Flange Diameter – in. (mm)	3" (78)
Blade Shaft RPM	2,990
Cut Depth – in. (mm)	1-9/16" (40)
Cutting Head	Steel
Built-In 45° Miter Cut	YES
Cutting Table	Chrome Steel
Water Pump	Blade Rotates In Water Pan
Power Source	Electric
Motor/Engine Type	T.E.F.C.
Maximum Horsepower*	1.5 HP
Voltage	115 volt
Cycle*/Current/Phase	60 Hz/AC/1
Full Load Amps	7 Amps
SAW DIMENSIONS	
Saw Length – in. (mm)	18.11" (460)
Saw Width – in. (mm)	14.17" (360)
Saw Height – in. (mm)	11-7/16" (290)
Weight Crated – lbs (kg)	40 (18)
Weight Uncrated – lbs (kg)	35 (15.9)

*= DATA PROVIDED BY MOTOR MANUFACTURER



PRODUCT FEATURES



Wet Cut Kit (included)
Easy attaching water control.



1/2 HP for Ample Cutting
Powerful clean cuts in hard materials.



Built-in Miter Cut Capability
Simple tilting miter table for cutting up to 45°.



Recommended Blade Upgrade
Classic Continuous Rim
See page 89

This is the portable solution for dry or wet cutting on smaller jobs. The 115 volt, single phase motor provides all the power you need combined with a built-in miter and depth adjustment to produce clean, accurate cuts every time.

TECHNICAL SPECIFICATIONS

PRODUCT #	TC405
UPC	70184682709
Blade Guard Capacity – in. (mm)	5" (127)
Maximum Depth of Cut – in. (mm)	1-1/4" (31)
Arbor Size – in. (mm)	20mm
Blade Flange Diameter – in. (mm)	1.41 (36)
Blade Shaft RPM	12,000
Cut Depth – in. (mm)	1-3/16" (30)
Built-In 45° Miter Cut	YES
Power Source	Electric
Motor/Engine Type	Universal Brush
Maximum Horsepower*	1/2 HP
Voltage	115 volt
Cycle*/Current/Phase	60 Hz/AC/1
Full Load Amps	5 Amp
SAW DIMENSIONS	
Saw Length – in. (mm)	9-3/8" (238)
Saw Width – in. (mm)	7-7/8" (200)
Saw Height – in. (mm)	6-1/2" (165)
Weight Crated – lbs (kg)	8 (3.6)
Weight Uncrated – lbs (kg)	6.4 (2.9)

*= DATA PROVIDED BY MOTOR MANUFACTURER
GENUINE NORTON CLIPPER DIAMOND BLADE (3 QTY) INCLUDED WITH SAW.



Tile Saw Blades

Maximum Blade Cutting Depths and Recommended Operating Speeds

BLADE DIAMETER	CUTTING DEPTH	IDEAL SPEED (RPM)	MAXI. SPEED (RPM)
4"	3/4"	9,072	15,000
4-1/2"	1"	8,063	13,300
5"	1-1/4"	7,257	12,000
6"	1-3/4"	6,048	10,185
7"	2-1/4"	5,184	8,730
8"	2-3/4"	4,536	7,640
9"	3-1/4"	4,032	6,790
10"	3-3/4"	3,629	6,115

razor sharp FOR THE EDGE YOU NEED

To produce razor-like cuts in porcelain or ceramic, marble and granite, the Slicer diamond blade is unbeatable. The high tensile, strengthened steel core blade extends life and speed to provide a clean, crisp, accurate cut. Don't settle, when Slicer can help you achieve exceptional results.

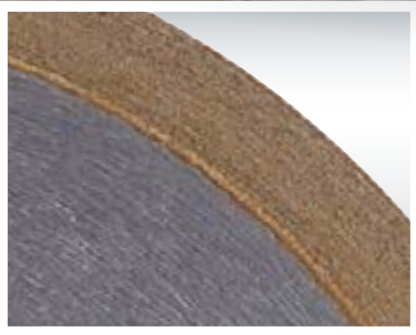

Premium Segment Specification

Special bond for the smoothest cut and finish, ideal for porcelain.

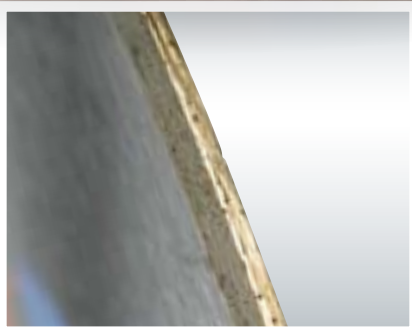

Precision Cuts, Every Time

Razor-thin design reduces loss of material



Thinnest Cuts, Longest Life

Thin, high tensile strength steel core for better accuracy and less wobbling.

Natural Stone and Tiles

Ceramic and stone tiles, granite, marble, very hard bricks and other very hard and dense materials.

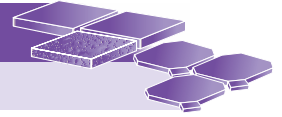

WET – CONTINUOUS RIM

SLICER

Razor-like cut, but with high tensile strength steel core for greater accuracy and less wobbling. The bond and diamond specification enhance cutting speed and improve blade life for premium performance, particularly in porcelain tile and other hard materials.

UPC	PART #	SIZE	MAX RPM	RIM HEIGHT
70184684183	NXSLC0700	7 x .060 x 5/8	8730	.393"
70184684184	NXSLC0800	8 x .060 x 5/8	7640	.393"
70184684185	NXSLC1000	10 x .060 x 5/8	6115	.393"



CLASSIC

Excellent quality with good performance in general purpose materials. The right bond and diamond content allows clean cutting with long use. Well suited for softer tile or stone materials on low horsepower tile saws.

UPC	PART #	SIZE	MAX RPM	RIM HEIGHT
07660701196	CON6WT	6 x .065 x 5/8	10185	.393"
70184684017	CON7WT	7 x .065 x 5/8	8730	.393"
07660702785	CON8WT	8 x .070 x 5/8	7640	.393"
07660702784	CON10WT	10 x .070 x 5/8	6115	.393"



DRY – CONTINUOUS RIM +

CLASSIC

An economical solution for small to medium size jobs cutting softer ceramic tile and stone materials with efficient cutting ability.

UPC	PART #	SIZE	MAX RPM	RIM HEIGHT
07660702793	CON4DT	4 x .080 x 7/8-5/8-20mm	15000	.275"
07660701194	CON45DT	4-1/2 x .080 x 7/8-5/8-20mm	13300	.275"
07660702783	CON7DT	7 x .090 x DM-7/8-5/8	8730	.275"



VALUPLUS

A value price point for small to medium size jobs cutting standard ceramic tile with efficient cutting on low horsepower tile saws.

UPC	PART #	SIZE	MAX RPM	SEGMENT HEIGHT
70184684087	VPDT0400	4 x .080 x 7/8-5/8-20mm	15000	.197"
70184684088	VPDT0450	4-1/2 x .080 x 7/8-5/8-20mm	13300	.197"
70184684089	VPDT0700	7 x .090 x DM-7/8-5/8	8730	.197"



DRY – TURBO RIM +

AERO-JET

Very fast, smooth cutting. The high diamond rim adds extremely long life whether cutting wet or dry in hard materials. Exclusive arrow shape protection inserts for precision straight cuts. A ventilated waved steel core for better cooling and intensive use. Exceptional cutting on a very wide range of materials with a high quality finished cut.

UPC	PART #	SIZE	MAX RPM	RIM HEIGHT
70184683778	AERO0400	4 x .070 x 7/8-5/8-20mm	15000	.472"
70184683779	AERO0450	4-1/2 x .070 x 7/8-5/8-20mm	13300	.472"
70184683780	AERO0500	5 x .070 x 7/8-5/8-20mm	12000	.472"
70184683781	AERO0700	7 x .090 x DM-7/8-5/8	8730	.472"
70184683782	AERO0800	8 x .090 x DM-7/8-5/8	7640	.472"
70184683783	AERO1000	10 x .110 x 1-7/8-5/8	6115	.472"



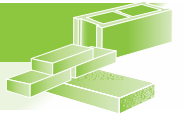

General Purpose and Masonry Building Materials

Blocks, medium-hard building bricks, paving slabs, concrete roof tiles and other medium-hard materials.

DRY – SEGMENTED RIM +

CHARGER

High performance dry cutting of a variety of materials. The segment specification allows extended life and fast cut for medium to large jobs.

UPC	PART #	SIZE	MAX RPM	SEGMENT HEIGHT
07660704019	CGDSEG1000	10 x .090 x 1-7/8-5/8	6115	.393"



CLASSIC

The improved bond provides longer life at an economical price for small to medium size jobs on smaller tile and rail saws.

UPC	PART #	SIZE	MAX RPM	SEGMENT HEIGHT
07660701201	CODSEG1000	10 x .100 x 1-7/8-5/8	6115	.275"



DRY – TURBO RIM +

CHARGER

Combines the characteristics of standard Charger blade with a turbo rim configuration for cutting hard, dense materials with minimal effort. A better bond and diamond concentration for maximum cutting speed, life and quality of cut.

UPC	PART #	SIZE	MAX RPM	RIM HEIGHT
07660704022	CGTURB0700	7 x .090 x DM-7/8-5/8	8725	.393"
70184681512	CGTURB0800	8 x .090 x DM-7/8-5/8	7640	.393"



CLASSIC

Great blade for cutting softer tile, brick and pavers with hand held tools or smaller tile saws. Offers chip-free cutting and good blade life.

UPC	PART #	SIZE	MAX RPM	RIM HEIGHT
07660702787	COTURB0700	7 x .090 x DM-7/8-5/8	8725	.315"
07660704016	0700TURBO5PK	7 x .090 x DM-7/8-5/8	8725	.315"
07660702780	COTURB1000	10 x .100 x 1-7/8-5/8"	6115	.275"



VALUPLUS

For value and performance on small to medium size jobs cutting soft brick and tile. The sintered turbo continuous rim cuts fast with a smoother quality of cut.

UPC	PART #	SIZE	MAX RPM	RIM HEIGHT
70184684107	VPTURB0700	7 x .090 x DM-7/8-5/8	8730	.315"





General Purpose and Masonry Building Materials

Blocks, medium-hard building bricks, paving slabs, concrete roof tiles and other medium-hard materials.

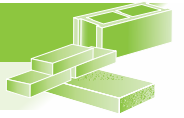

FOR USE ON CORDLESS POWER TOOLS ONLY



SILENCIO **NEW**



Laser-welded segments for maximum attachment security in all materials. Sound-dampening sandwich core reduces sound while cutting. Premium segment for faster cutting in difficult materials.



UPC	PART #	SIZE	MAX RPM	SEGMENT HEIGHT
701846 08514	SILENCIO0900	9 x .102 x 7/8	6650	.393"

SILENCIO CLASSIC **NEW**



With the same features as the original Silencio, the Silencio Classic has longer life segments on a sound-dampened core for softer, more abrasive materials.



UPC	PART #	SIZE	MAX RPM	SEGMENT HEIGHT
701846 08591	SILCLB0900	9 x .102 x 7/8"	6650	.393"

Multi-Purpose, All Materials

Concrete, reinforced concrete, granite, building materials, thin steel sections, angle iron up to 1/2" material thickness, rebar up to no. 5.



FOR USE ON CORDLESS POWER TOOLS ONLY



DIALAST **NEW**



Vacuum brazed diamond for uni-directional cutting. Cooling holes in core for added cooling to cut harder materials. Solid core gullet design for smooth continuous cutting.



UPC	PART #	SIZE	MAX RPM	SEGMENT HEIGHT
701846 08590	DIABAT0900	9 x .118 x 7/8	6,650	.125"

Abrasive Cut-off Wheel for Cordless Tools

Steel & Stainless

General-purpose ferrous metals (steel, iron, welds), stainless steel and other high strength alloys.



ABRASIVE CUT-OFF WHEEL FOR USE ON CORDLESS POWER TOOLS ONLY



CHARGER **NEW**



This Norton Clipper abrasive cut-off wheel completes the 9" offering for use on cordless tools in metal applications. Thinner abrasive wheel for less drag and power draw on cordless tools. Reinforced metal arbor to enhance push and cutting speed. Cordless abrasive blend to maximize cutting speed and tool battery life.



UPC	SIZE	APPLICATION	MAX RPM	STD PKG
662533 71513	9 x 5/64 x 7/8	Metal / Stainless	6,600	10



MAKE YOUR
BATTERY TOOL
MORE VERSATILE!





General Purpose and Masonry Building Materials

Blocks, medium-hard building bricks, paving slabs, concrete roof tiles and other medium-hard materials.

DRY – SEGMENTED RIM

DUO

The original DUO. The innovative, exclusive design introduced in 2002 has become a dominant name in the market. The unique dual segment per land technology provides excellent cutting speed with low vibration and high comfort of cut. The exclusive arrow shape gullets not only indicate blade direction but they also assist in fast removal of cutting debris. Maximum performance when cutting hard materials and fiber cement board.

UPC	PART #	SIZE	MAX RPM	SEGMENT HEIGHT
70184684526	DUO0450	4-1/2 x .086 x 7/8-5/8-20mm	13300	.393"
70184684527	DUO0500	5 x .086 x 7/8-5/8-20mm	12000	.393"
70184684129	DUO0700	7 x .098 x DM-7/8-5/8	8730	.393"



CHARGER

High performance dry cutting of a variety of materials. The segment specification allows extended life and fast cut for medium to large jobs.

UPC	PART #	SIZE	MAX RPM	SEGMENT HEIGHT
70184681505	CGDSEG0400	4 x .080 x 7/8-5/8-20mm	15000	.393"
07660704021	CGDSEG0450	4-1/2 x .080 x 7/8-5/8-20mm	13300	.393"
70184682851	CGDSEG0500	5 x .080 x 7/8-5/8-20mm	12000	.393"
70184683820	CGDSEG0600	6 x .080 x 7/8-5/8-20mm	10185	.393"
07660704020	CGDSEG0700	7 x .090 x DM-7/8-5/8	8725	.393"
70184681513	CGDSEG0800	8 x .090 x DM-7/8-5/8	7640	.393"
70184669483	CGDSEG0900	9 x .090 x 7/8-5/8"	6600	.393"



CLASSIC

The improved bond provides longer life at an economical price for small to medium size jobs on smaller tile and rail saws.

UPC	PART #	SIZE	MAX RPM	SEGMENT HEIGHT
07660702791	CODSEG0400	4 x .080 x 7/8-5/8-20mm	15000	.393"
07660702789	CODSEG0450	4-1/2 x .080 x 7/8-5/8-20mm	13300	.393"
70184684463	0450SEG5PK	4-1/2 x .080 x 7/8-5/8-20mm	13300	.393"
70184684006	CODSEG0600	6 x .080 x 7/8-5/8-20mm	10185	.393"
07660702786	CODSEG0700	7 x .090 x DM-7/8-5/8	8725	.315"
70184684464	0700SEG5PK	7 x .090 x DM-7/8-5/8	8725	.393"



VALUPLUS

For value and performance on small to medium size jobs cutting soft abrasive materials like brick and tile. The sintered rim delivers a quality cut and good life.

UPC	PART #	SIZE	MAX RPM	SEGMENT HEIGHT
70184684098	VPSEG0400	4 x .080 x 7/8-5/8-20mm	15000	.315"
70184684099	VPSEG0450	4-1/2 x .080 x 7/8-5/8-20mm	13300	.315"
70184684100	VPSEG0700	7 x .090 x DM-7/8-5/8	8725	.315"





General Purpose and Masonry Building Materials

Blocks, medium-hard building bricks, paving slabs, concrete roof tiles and other medium-hard materials.

DRY – TURBO RIM

CHARGER

Combines the characteristics of standard Charger blade with a turbo rim configuration for cutting hard, dense materials with minimal effort. A better bond and diamond concentration for maximum cutting speed, life and quality of cut.

UPC	PART #	SIZE	MAX RPM	SEGMENT HEIGHT
07660705475	CGTURB0400	4 x .080 x 7/8-5/8-20mm	15000	.393"
07660704023	CGTURB0450	4-1/2 x .080 x 7/8-5/8-20mm	13300	.393"
70184682853	CGTURB0500	5 x .080 x 7/8-5/8-20mm	12000	.393"
70184683821	CGTURB0600	6 x .080 x 7/8-5/8-20mm	10185	.393"
07660704022	CGTURB0700	7 x .090 x DM-7/8-5/8	8730	.393"
70184681512	CGTURB0800	8 x .090 x DM-7/8-5/8	7640	.393"



CLASSIC

Great blade for cutting softer tile, brick and pavers with hand held tools or smaller tile saws. Offers chip-free cutting and good blade life.

UPC	PART #	SIZE	MAX RPM	SEGMENT HEIGHT
07660702792	COTURB0400	4 x .080 x 7/8-5/8-20mm	15000	.315"
07660704018	0400TURB05PK	4 x .080 x 7/8-5/8-20mm	15000	.315"
07660702790	COTURB0450	4-1/2 x .080 x 7/8-5/8-20mm	13300	.315"
07660704017	0450TURB05PK	4-1/2 x .080 x 7/8-5/8-20mm	13300	.315"
07660705344	COMBO Pack	4-1/2 x .080 x 7/8-5/8-20mm	13300	.315"
70184684011	COTURB0600	6 x .080 x 7/8-5/8-20mm	10185	.315"
07660702787	COTURB0700	7 x .090 x DM-7/8-5/8	8730	.315"
07660704016	0700TURB05PK	7 x .090 x DM-7/8-5/8	8730	.315"



VALUPLUS

For value and performance on small to medium size jobs cutting soft brick and tile. The turbo continuous rim cuts fast with a smoother quality of cut.

UPC	PART #	SIZE	MAX RPM	SEGMENT HEIGHT
70184684105	VPTURB0400	4 x .080 x 7/8-5/8-20mm	15000	.315"
70184684106	VPTURB0450	4-1/2 x .080 x 7/8-5/8-20mm	13300	.315"
70184684107	VPTURB0700	7 x .090 x DM-7/8-5/8	8730	.315"



Natural Stone and Tiles

Ceramic and stone tiles, granite, marble, very hard bricks and other very hard and dense materials.

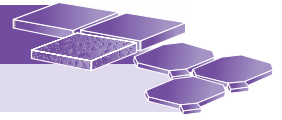

DRY – TURBO RIM



AERO-JET



Very fast, smooth cutting. The high diamond rim adds extremely long life whether cutting wet or dry in hard materials. Exclusive arrow shape protection inserts for precision straight cuts. A ventilated waved steel core for better cooling and intensive use. Exceptional cutting on a very wide range of materials with a high quality finished cut.

UPC	PART #	SIZE	MAX RPM	RIM HEIGHT
70184683778	AERO0400	4 x .070 x 7/8-5/8-20mm	15000	.472"
70184683779	AERO0450	4-1/2 x .070 x 7/8-5/8-20mm	13300	.472"
70184683780	AERO0500	5 x .070 x 7/8-5/8-20mm	12000	.472"
70184683781	AERO0700	7 x .090 x DM-7/8-5/8	8730	.472"
70184683782	AERO0800	8 x .090 x DM-7/8-5/8	7640	.472"



DRY – CONTINUOUS RIM



CLASSIC



An economical solution for small to medium size jobs cutting softer ceramic tile and stone materials with efficient cutting ability.

UPC	PART #	SIZE	MAX RPM	RIM HEIGHT
07660702793	CON4DT	4 x .080 x 7/8-5/8-20mm	15000	.275"
07660701194	CON45DT	4-1/2 x .080 x 7/8-5/8-20mm	13300	.275"
07660702788	CON7DT	7 x .090 x DM-7/8-5/8	8730	.275"



VALUPLUS



A value price point for small to medium size jobs cutting standard ceramic tile with efficient cutting on low horsepower tile saws.

UPC	PART #	SIZE	MAX RPM	RIM HEIGHT
70184684087	VPDT0400	4 x .080 x 7/8-5/8-20mm	15000	.275"
70184684088	VPDT0450	4-1/2 x .080 x 7/8-5/8-20mm	13300	.275"
70184684089	VPDT0700	7 x .090 x DM-7/8-5/8	8730	.275"



Asphalt and Abrasive Materials

Asphalt, green concrete, asphalt over concrete, abrasive blocks, mortar and other abrasive materials.

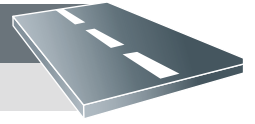

DRY – TUCK POINTING +

CHARGER

High performance dry cutting with an extra wide .250 segment specification that allows thorough cleaning and extended life for mortar or expansion joint repair.

UPC	PART #	SIZE	MAX RPM	SEGMENT HEIGHT
70184681506	CGTUCK0400	4 x .250 x 7/8-5/8-20mm	15000	.275"
70184681781	CGTUCK0450	4-1/2 x .250 x 7/8-5/8-20mm	13300	.393"



CLASSIC

An economical solution for small to medium tuck pointing jobs. High quality performance for heavy grout removal or mortar jointing. The heavy duty wide segment reduces wear in abrasive materials.

UPC	PART #	SIZE	MAX RPM	SEGMENT HEIGHT
70184681776	CHTUCK0400	4 x .250 x 7/8-5/8-20mm	15000	.275"
70184681777	CHTUCK0450	4-1/2 x .250 x 7/8-5/8-20mm	13300	.275"
70184681778	CHTUCK0500	5 x .250 x 7/8-5/8-20mm	12000	.275"
70184681779	CHTUCK0700	7 x .250 x 7/8-5/8-20mm	8730	.275"
70184681780	CHTUCK0800	8 x .250 x 7/8-5/8-20mm	7640	.275"



VALUPLUS

A value price point for small-to-medium size jobs. Cleans grout and mortar joints quickly and efficiently with hand-held tools.

UPC	PART #	SIZE	MAX RPM	SEGMENT HEIGHT
70184684020	CON4TP	4 x .250 x 7/8-5/8-20mm	15000	.393"
70184663862	CON45TP	4-1/2 x .250 x 7/8-5/8-20mm	13300	.393"



Reinforced Concrete and Harder Building Materials

Reinforced concrete, hard bricks, limestone, terrazzo, and other hard materials.



DRY – CRACK CHASING +

CHARGER

A heavy V-shaped segment designed with a special bond and diamond content for maximum removal of grout, mortar jointing, crack chasing and crack widening. Fast cutting and long life in abrasive materials using portable tools. Highly competitive to others of its kind in the market.

UPC	PART #	SIZE	MAX RPM	SEGMENT HEIGHT
70184683856	CGCC0400	4 x .375 x 7/8-5/8-20mm	15000	.550"
70184683859	CGCC0700	7 x .375 x 7/8-5/8-20mm	8730	.550"



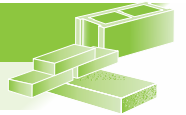

General Purpose and Masonry Building Materials

Blocks, medium-hard building bricks, paving slabs, concrete roof tiles and other medium-hard materials.

DRY – CUP GRINDER

IHD 3X3

Ensures very high material removal rate, extreme comfort while working without vibrations and a self-sharpening feature. These new cups offer the best finishing and longest life even on softer, more abrasive materials.

UPC	PART #	SIZE	MAX RPM	SEGMENT HEIGHT
Single Row for Fast Stock Removal				
70184601763	3X3CG0400	4 x 5/8"-11	15000	.177"
70184601766	3X3CG0500	5 x 5/8"-11	12000	.177"
70184601769	3X3CG0700	7 x 5/8"-11	8730	.177"



IHD CHARGER CG

Increased segment to surface for more material removal than the Norton Classic cup grinder. The diamond and bond configuration provide a more comfortable feel while extending life and better finish on a wide range of materials.

UPC	PART #	SIZE	MAX RPM	SEGMENT HEIGHT
Single Row for Fast Stock Removal				
70184601762	CGCG0400	4 x 5/8"-11	15000	.177"
70184601765	CGCG0500	5 x 5/8"-11	12000	.177"
70184601768	CGCG0700	7 x 5/8"-11	8730	.177"



IHD CLASSIC

Provides efficient material removal rate thanks to the small contact surfaces of the segments. The cups also have flat sides to avoid damaging walls or ceilings during flush grinding.

UPC	PART #	SIZE	MAX RPM	SEGMENT HEIGHT
Single Row for Fast Stock Removal				
70184601761	CCCG0400	4 x 5/8"-11	15000	.177"
70184601764	CCCG0500	5 x 5/8"-11	12000	.177"
70184601767	CCCG0700	7 x 5/8"-11	8730	.177"

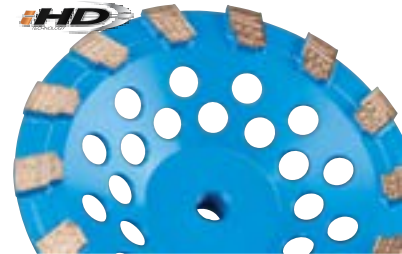

Infiltrated High-Density (iHD)

Segments made with patented technology for longer life and faster grinding are available in three types. Designated by their unique segment designs, the Norton Clipper Classic, with a single building shaped segment provides a good removal rate. Two building in the Norton Clipper Charger cups for a better finished, faster cut. And, the Norton Clipper 3X3, with three buildings ensures the highest stock removal, best comfort, longest life and overall best finish.

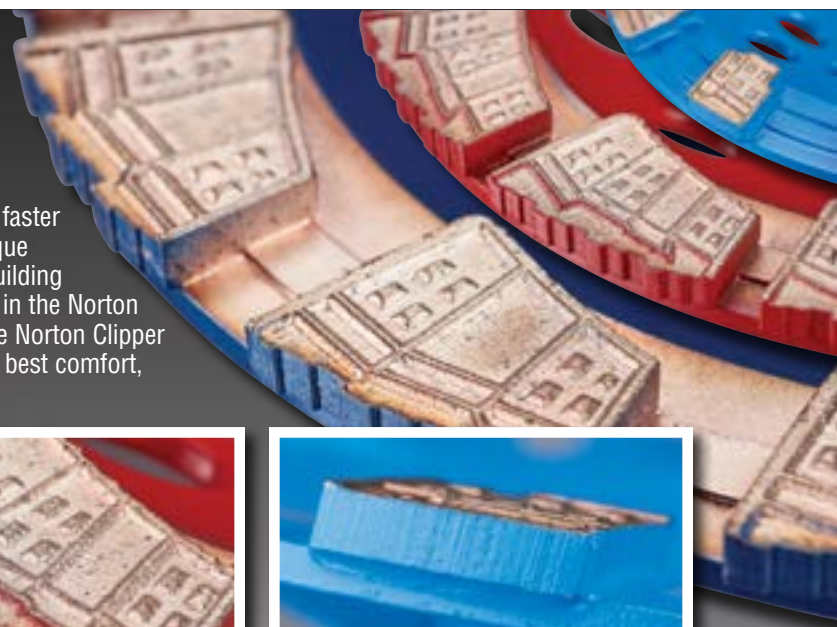

Large Grinding Surface

For better comfort with minimal vibration.

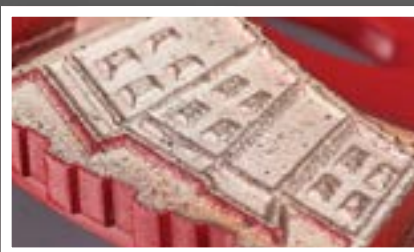

iHD Segments

Made with patented technology for longer life and faster grinding.



Thick Body

For more safety, allowing more pressure when needed, resisting flexing causing breakage.

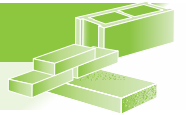

General Purpose and Masonry Building Materials

Blocks, medium-hard building bricks, paving slabs, concrete roof tiles and other medium-hard materials.

DRY – CUP GRINDER 

CLASSIC 

Available in a range of sizes and segment designs for optimum performance by life or by speed. Ideal for leveling all types of masonry materials, brick, block, concrete and stone. Strategically placed hole designs help ventilate dust from the surface extending life of the cups.

UPC	PART #	SIZE	MAX RPM	SEGMENT HEIGHT
Single Row for fast stock removal				
70184682585	CHSCPH0400	4 x 7/8-5/8-20mm	15000	.210"
70184684035	CHSCPH0500	5 x 7/8-5/8-20mm	12000	.210"
70184682594	CHSCPH0700	7 x 7/8-5/8-20mm	8730	.210"
70184682555	CHSCPT0400	4 x 5/8"-11	15000	.210"
70184684036	CHSCPT0500	5 x 5/8"-11	12000	.210"
70184682593	CHSCPT0700	7 x 5/8"-11	8730	.210"



UPC	PART #	SIZE	MAX RPM	SEGMENT HEIGHT
Double Row for Long Life, Smooth Finish				
70184682588	CHDCPH0400	4 x 7/8-5/8-20mm	15000	.210"
70184684037	CHDCPH0500	5 x 7/8-5/8-20mm	12000	.210"
70184682596	CHDCPH0700	7 x 7/8-5/8-20mm	8730	.210"
70184682586	CHDCPT0400	4 x 5/8"-11	15000	.210"
70184684038	CHDCPT0500	5 x 5/8"-11	12000	.210"
70184682595	CHDCPT0700	7 x 5/8"-11	8730	.210"



UPC	PART #	SIZE	MAX RPM	SEGMENT HEIGHT
Swirl for Most Aggressive Cut, Smooth Finish				
70184684039	CHSWCPH0500	5 x 7/8-5/8-20mm	12000	.180"
70184683825	CHSWCPH0700	7 x 7/8-5/8-20mm	8730	.180"
70184683826	CHSWCPT0400	4 x 5/8"-11	15000	.180"
70184684040	CHSWCPT0500	5 x 5/8"-11	12000	.180"
70184683827	CHSWCPT0700	7 x 5/8"-11	8730	.180"



UPC	PART #	SIZE	MAX RPM	SEGMENT HEIGHT
Turbo for Long Life, Very Smooth Finish				
70184683830	CHTURCPT0400	4 x 5/8"-11	15000	.210"
70184683831	CHTURCPT0700	7 x 5/8"-11	8730	.210"



you won't get left in the dust **WITH THE NORTON VACUUM SHROUD**

Hand grinding of concrete and masonry surfaces and mortar is a tough, dirty task. It doesn't have to be with the new Norton Vacuum Shroud. The Vacuum Shroud's design creates a cyclonic effect, extracting dust and debris from the work surface into the support vacuum. This prolongs the life of the grinding cup and grinder and provides a smoother surface while decreasing the chance of dust particle inhalation. A durable, heavy-duty, scratch-resistant plastic design can withstand the constant abuse of hand grinding applications. The hinged front can be used to work closely to the corner of the walls or improve visibility of the surface while reducing airborne dust.

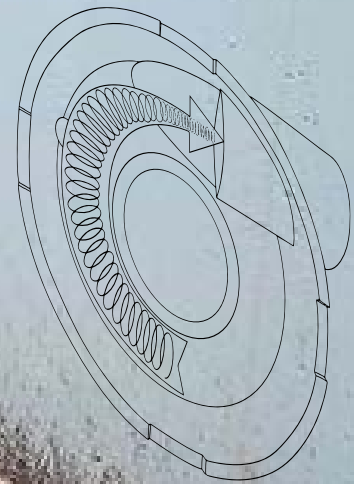

UPC

701846**94059**

DESCRIPTION

5" vacuum shroud kit – includes one shroud, five different adapter rings to fit most popular right angle grinders, and one 5" x 5/8-11 Norton Clipper cup wheel.

701846**41039**

7" vacuum shroud kit – includes one shroud, five different adapter rings to fit most popular right angle grinders, and one 7" x 5/8-11 Norton Clipper cup wheel.



Simple and Easy Design

Durable, scratch-resistant body with steel reinforcement ring to provide strong support when grinding. Provides smoother and longer shroud life.



Additional Adapters

Five extra adaptor rings enabling the shroud to be mounted on various industry grinders. Every kit comes with a single row diamond cup.



Hinged Window

Provides additional visibility of the surface with closer grinding performance along walls and corners.





RANGE OVERVIEW



MODEL#
UPC#

DR620
70184600925

HHD3TOL HAND-HELD
70184621725

HHDETOL
70184600917

HHDET1800
70184684243

MAX. DRILLING CAPACITY

10"
(254mm)

6"
(127mm)

6"
(178mm)

4"
(178mm)

MAX. HP.

25 Amps

15 Amps

15 Amps

15 Amps

PRODUCT FEATURES



Vacuum Pump
Superior stabilization.



Wheel Attachment
Ease of transporting around job site.



Ceiling Jack
Extending ceiling jack for indoor drilling.



DR520



DR620

The Norton Clipper DR series of core drills offer a versatile drill rig with exceptional utility to meet the tough demands of today's rental and contractor industry. The basic design of the carriage and pinion assembly provides a simple trouble-free system to extend service life in the rental fleet. The DR620 drill rig stand offers the additional utility of a pivoting column for drilling vertically on a sloping surface.

TECHNICAL SPECIFICATIONS

PRODUCT #	DR520	DR620
UPC	701846 00924	701846 00925
Gears	2	2
Motor Type	Milwaukee	Milwaukee
Motor Specification	4096	4096
Voltage	115 volts	115 volts
Cycle*/Current/Phase	60 Hz/AC/1	60 Hz/AC/1
Amperage	20 Amp	20 Amp
RPM	450/900	450/900
Spindle Thread Size	1-1/4"-7 UNC	1-1/4"-7 UNC
Base – Combo – in. (mm) LxW	18-7/8" x 13-3/4" (450x350)	18-7/8" x 13-3/4" (450x350)
Column Length – in. (mm)	42" (1,067)	40" (1,016)
Slide Carriage	One Piece Aluminum Carriage, Rack and Pinion, Carriage Lock, and Quick Detach Motor Mount Dove Tail	
Wheel Base (outside to outside) in. (mm)	15-1/2" (394)	15-1/2" (394)
Wheels (D x W x B) in. (mm)	6"x1-3/8"x3/4" (152x35x19)	6"x1-3/8"x3/4" (152x35x19)
Vacuum Pump	YES	YES
Control Panel	YES	YES
Weight Crated – lbs (kg)	140 (63.5)	140 (63.5)
Weight Uncrated – lbs (kg)	125 (56.7)	125 (56.7)
RECOMMENDED BIT SIZES		
Low in. (mm)	6" to 10" (152 to 254)	6" to 10" (152 to 254)
High in. (mm)	2" to 6" (50 to 152)	2" to 6" (50 to 152)
DRILL RIG STANDS		
	UPC	SMART PART #
DS5/DS6 Drill Rig Stand – Standard Base	701846 00922	D55
DS5/DS6 Drill Rig Stand – Pivoting Base	701846 00923	D56
DM5/DM6 DRILL MOTORS		
	UPC	SMART PART #
15 amp Milwaukee	701846 57976	403061
20 amp Milwaukee	701846 57985	403064
20 amp Cardi	701846 22228	T3-250-EL
ACCESSORIES		
	UPC	SMART PART #
Spacer Block	701846 00927	408002
4 Gallon Water Pressure Tank	701846 75539	403126
Water Collector Ring	701846 58498	402034
Core Bit Quick Release Attachment	701846 00938	408003
Vacuum Pump for DR520/620	701846 45802	408299

*= DATA PROVIDED BY ENGINE MANUFACTURER



CORE BITS

Minimum and Maximum Recommended Operating Speeds

BIT DIAMETER	MIN. (RPM)	IDEAL SPEED (RPM)	MAX. (RPM)
1"	2,400	3,200	4,000
2"	1,200	1,600	2,000
3"	800	1,050	1,300
4"	600	800	1,000
5"	475	640	800
6"	400	530	665
7"	340	450	600
8"	300	400	500
10"	240	320	400
12"	200	265	330
14"	170	225	285
16"	150	200	250
18"	130	175	220
20"	120	160	200
24"	100	130	165
26"	90	125	150
30"	80	105	130
32"	75	100	125
34"	70	95	120
36"	65	85	110
40"	60	80	100
42"	55	75	95

PRODUCT FEATURES



Single-Speed, 15 Amp

Smart Electronics allow bits to spin with ease.



Sturdy All-Metal Carriage

Equipped with a side level and hand-held rig adaptor ensures smooth operation.

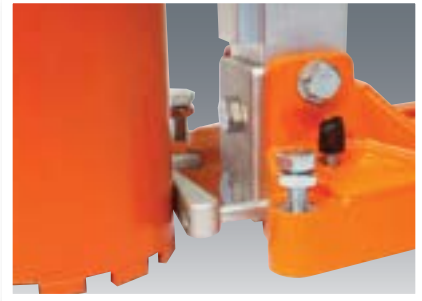

Wide Base Platform

A bit guide allows straighter drilling.



Recommended Core Bit

Norton Clipper Charger
See page 111

This rig package provides the rental market with a strong, stable-performing hand-held core drill and sturdy rig stand. The single-speed drill features "Smart Electronics" motor protection and safety clutch for safe operation, which means no overheating of electrical parts. Geared at 940 RPMs, there is plenty of power to easily spin a 4" bit by hand and a 6" with the stand. When you need a core drill that can cover the basics but also maximize your return on investment, the HDR600C is a great solution.

TECHNICAL SPECIFICATIONS

PRODUCT #	HDR600C	
UPC	701846 44020	
Gears	1	
Motor Type	Electric	
Voltage	115 volts	
Cycle*/Current/Phase	60Hz/AC/1	
Amperage*	15 Amps	
RPM (No Load)	940	
Smart Electronics	YES	
Weight Crated – lbs. (kg)	18 (8.1)	
Weight Uncrated – lbs. (kg)	12 (5.4)	
RECOMMENDED BIT SIZES		
Low – in. (mm)	2" to 4" (50 to 102)	
High – in. (mm)	n/a	
ACCESSORIES	UPC	SMART PART #
Core Bit Quick Release Attachment	701846 00938	408003
Centering Aid	701846 23517	409122

*= DATA PROVIDED BY MOTOR MANUFACTURER

PRODUCT FEATURES



Water Attachment and Accessories

1-1/4-7 Male with 5/8-11 adapter and quick attach water accessories for wet drilling.



Storage Space Saver

Provides room for side handle, manual, and extra tools in a compact and convenient case.



Heavy-Duty Carrying Case

Light-weight, high-impact plastic protects drill during transportation.



The HHD3TOL hand-held core drill is perfect for professional or heavy rental user, providing all the power needed for most any drilling job. Having speeds from 770 to 2,580 rpm allows the use of 1" up to 6" diamond core bits. The Cardi "Smart Electronics" adds protection by not overheating electrical parts. With the comfortable rear handle, and three-speed variability, operator comfort is improved, and productivity enhanced.

TECHNICAL SPECIFICATIONS

PRODUCT #	HHD3TOL	
UPC	701846 21725	
Gears	3	
Motor Type	Electric	
Voltage	115 volts	
Cycle*/Current/Phase	60Hz/AC/1	
Amperage*	15 (18) Amps	
RPM	770/1,860/2,580	
Smart Electronics	YES	
Weight Crated	27 (12.2)	
Weight Uncrated	17 (7.3)	
RECOMMENDED BIT SIZES		
Low - in. (mm)	2" to 4" (50 to 102)	4" to 6" (100 to 150)
Medium - in. (mm)	2" to 3" (50 to 75)	
High - in. (mm)	1/2" to 2" (12 to 50)	1" to 2" (25 to 50)
ACCESSORIES	UPC	SMART PART #
Portable Stand CDR163	003104 68577	CDR163
Core Bit Quick Release Attachment	701846 00938	408003
Centering Aid	701846 23517	409122

*= DATA PROVIDED BY MOTOR MANUFACTURER

Recommended Core Bit

Norton Clipper Paradigm
See page 111

PRODUCT FEATURES



1-1/4" – 7 Spindle with 5/8-11 Threaded Adaptor

Allows additional bit types to be used.



Heavy-Duty Carrying Case

Light-weight, high-impact plastic that protects drill during transportation.



Optional Stand

Provides additional drilling flexibility with its sturdy drill column and carriage for smooth drilling.



Weighing only 13 pounds, the HHDETOL is a Norton Clipper hand-held core drill with a 15 amp motor. The "Smart Electronic" system protects it from system overload. This unit comes with a durable plastic carrying case, safety clutch, 5/8-11 threaded adaptor and 1-1/4-7 threaded spindle. Ideal for electricians, plumbers and the professional contractor.

TECHNICAL SPECIFICATIONS

PRODUCT #	HHDETOL	
UPC	701846 00917	
Gears	2	
Motor Type	Electric	
Voltage	115 volts	
Cycle*/Current/Phase	60Hz/AC/1	
Amperage*	15 Amps	
RPM (No Load)	1,180/2,150	
Smart Electronics	YES	
Weight Crated – lbs. (kg)	19 (8.6)	
Weight Uncrated – lbs. (kg)	13 (5.9)	
RECOMMENDED BIT SIZES		
Low – in. (mm)	2" to 4" (50 to 102)	
High – in. (mm)	1/2" to 2" (12 to 50)	
ACCESSORIES	UPC	SMART PART #
Portable Stand L160	003100 07829	L160
Core Bit Quick Release Attachment	701846 00938	408003
Centering Aid	701846 23517	409122

*= DATA PROVIDED BY MOTOR MANUFACTURER

Recommended Core Bit

Norton Clipper Charger
See page 113

PRODUCT FEATURES



Smart Electronics Protection

No over-heating of electrical components.



Water Attachment and Accessories

1-1/4-7 Male with 5/8-11 adapter and quick attach water accessories for wet drilling.



Rugged Carrying Case

Protects unit and accessories from damage.



A light-weight and user-friendly core drill. With its "Smart Electronics" motor protection from Cardi means no overheating of electrical parts. The powerful 15 amp motor drives core bits up to 4" with ease. The HHDET1800 hand-held core drill has a single-speed gear box and mechanical safety clutch. Packaged in a rugged carrying case to protect the drill during transport.

TECHNICAL SPECIFICATIONS

PRODUCT #	HHDET1800	
UPC	701846 84243	
Gears	1	
Motor Type	Electric	
Voltage	115 volts	
Cycle*/Current/Phase	60Hz/AC/1	
Amperage*	15 Amps	
RPM (No Load)	940	
Smart Electronics	YES	
Weight Crated – lbs. (kg)	18 (8.1)	
Weight Uncrated – lbs. (kg)	12 (5.4)	
RECOMMENDED BIT SIZES		
Low – in. (mm)	2" to 4" (50 to 102)	
High – in. (mm)	n/a	
ACCESSORIES	UPC	SMART PART #
Portable Stand CDR163	003104 68577	CDR163
Core Bit Quick Release Attachment	701846 00938	408003
Centering Aid	701846 23517	409122

*= DATA PROVIDED BY MOTOR MANUFACTURER

Recommended Core Bit

Norton Clipper Classic
See page 112

ACCESSORIES FOR CORE DRILLING

UPC	SMART PART #	DESCRIPTION
701846 69858	Y1017	Nylon Washer



UPC	SMART PART #	DESCRIPTION	SIZE
701846 65995	402760	Extension	6" x 1-1/4" 7 Thread



UPC	SMART PART #	DESCRIPTION	SIZE
701846 48793	402758	Extension	6" x 5/8" 11 Thread



UPC	SMART PART #	DESCRIPTION	SIZE
701846 48791	402756	Extension	12" x 1-1/4" 7 Thread



UPC	SMART PART #	DESCRIPTION	SIZE
701846 48792	402757	Extension	12" x 5/8" 11 Thread



UPC	SMART PART #	DESCRIPTION	SIZE
701846 49430	400148	Coupling	1-1/4" – 7(F) – 5/8" – 11(M)



UPC	SMART PART #	DESCRIPTION	SIZE
701846 49797	400147	Coupling	5/8" – 11(F) – 1 1/4" – 7(M)



UPC	SMART PART #	DESCRIPTION	SIZE
701846 83078	4913	Drill Chuck Adapter	5/8"-11 thread to straight 1/2" shank



NOTE:

- WET BITS FROM 1" TO 1-1/2" DIAMETER HAVE 5/8"-11 THREADED ADAPTERS.
- WET BITS 1-3/4" DIAMETER AND LARGER HAVE 1-1/4"-7 THREADED ADAPTERS.
- CLASSIC, CHARGER, PARADIGM WET BITS HAVE 16" TUBE LENGTH AND PRODUCE 13" CORING DEPTH.
- DRY CUTTING BITS COME WITH 5/8"-11 THREADED ADAPTERS AND 11 INCH TUBE LENGTH.



ACCESSORIES FOR CORE DRILLING (CONTINUED)

UPC	SMART PART #	DESCRIPTION
003104 68577	CDR163	Portable Stand CDR163



UPC	SMART PART #	DESCRIPTION
701846 23517	409122	Centering Aid for Cardi



UPC	SMART PART #	DESCRIPTION
701846 45802	408299	Vacuum Pump for CD100



UPC	SMART PART #	DESCRIPTION
701846 00938	408003	Core Bit Quick Release Attachment



UPC	SMART PART #	DESCRIPTION
701846 00927	408002	Spacer Block



UPC	SMART PART #	DESCRIPTION
701846 58498	402034	Water Collector Ring



UPC	SMART PART #	DESCRIPTION
701846 00983	408012	Vacuum Base Gasket - DS5/DS6



UPC	SMART PART #	DESCRIPTION
003104 94440	310494440	Dust Collector 3/8" to 3" (10-85mm)
003104 94441	310494441	Dust Collector 3-1/2" to 6"



UPC	SMART PART #	DESCRIPTION
003104 70303	310470303	Water Collector 5" (130mm) Max Bit
003104 70304	310470304	Water Collector 10" (300) Max Bit



hard to the core A NEW PARADIGM FOR DRILLING

You get a little “bit” more perfection with this innovative design of Norton Clipper Paradigm. A tapered top permits the core bit to penetrate quick and efficiently into the toughest aggregates and steel-reinforced concrete while strategic fluting accelerates cut and debris extraction. Remember, not all holes are created equally.

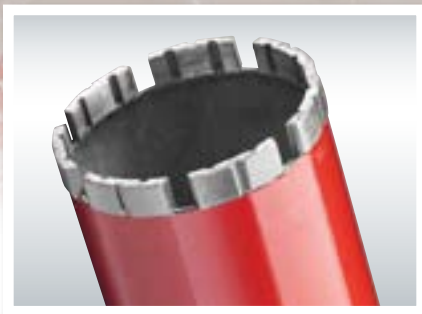

Strong Cores

Each tube is laser-welded to withstand demanding applications.



Tapered Segment

Turbo type design allows faster penetration.



Large Segment Height

Extends product life.





Reinforced Concrete and Harder Building Materials

Reinforced concrete, hard bricks, limestone, terrazzo, and other hard materials.

WET

PARADIGM

A turbo segment permits the core to penetrate quick and efficiently into the toughest cured concrete. With significantly increased performance over existing products in the market today, these provide the best tier solution without the premium price tag.

UPC	PART #	SIZE IN INCHES	SIZE IN MM	MAX RPM	SEGMENT HEIGHT
70184601410	PDBIT0200	2"	51mm	2000	.490"
70184601411	PDBIT0250	2-1/2"	64mm	1300	.490"
70184601412	PDBIT0300	3"	76mm	1300	.490"
70184601413	PDBIT0350	3-1/2"	89mm	1300	.490"
70184601414	PDBIT0400	4"	102mm	1000	.490"
70184601415	PDBIT0450	4-1/2"	114mm	800	.490"
70184601416	PDBIT0500	5"	127mm	800	.490"
70184601417	PDBIT0600	6"	152mm	665	.490"
70184601418	PDBIT0700	7"	178mm	600	.490"
70184601419	PDBIT0800	8"	203mm	500	.490"
70184601706	PDBIT1000	10"	254mm	400	.490"
70184601707	PDBIT1200	12"	305mm	330	.490"
70184601708	PDBIT1400	14"	356mm	285	.490"



Wet Bits from 1" to 1-1/2" diameter have 5/8"-11 threaded adapters.

CHARGER

Laser welded segments for faster penetration in medium aggregate with reinforcement and maximum utilization of segment life.

UPC	PART #	SIZE IN INCHES	SIZE IN MM	MAX RPM	SEGMENT HEIGHT
70184682778	CGBIT0100	1"	25mm	4,000	.375"
70184682779	CGBIT0125	1-1/4"	32mm	3,000	.375"
70184682780	CGBIT0150	1-1/2"	38mm	3,000	.375"
70184682781	CGBIT0175	1-3/4"	44mm	2,000	.375"
70184682782	CGBIT0200	2"	51mm	2,000	.475"
70184682783	CGBIT0225	2-1/4"	57mm	1,300	.475"
70184682784	CGBIT0250	2-1/2"	64mm	1,300	.475"
70184682785	CGBIT0300	3"	76mm	1,300	.475"
70184682786	CGBIT0350	3-1/2"	89mm	1,000	.475"
70184682787	CGBIT0400	4"	102mm	1,000	.475"
70184682788	CGBIT0425	4-1/4"	108mm	800	.475"
70184682789	CGBIT0450	4-1/2"	114mm	800	.475"
70184682790	CGBIT0500	5"	127mm	800	.475"
70184682791	CGBIT0600	6"	152mm	665	.475"
70184682792	CGBIT0700	7"	178mm	600	.475"
70184682793	CGBIT0800	8"	203mm	500	.475"
70184682794	CGBIT1000	10"	254mm	400	.475"
70184682795	CGBIT1200	12"	305mm	330	.475"
70184682796	CGBIT1400	14"	356mm	285	.475"



Wet Bits 1-3/4" diameter and larger have 1-1/4"-7 threaded adapters.

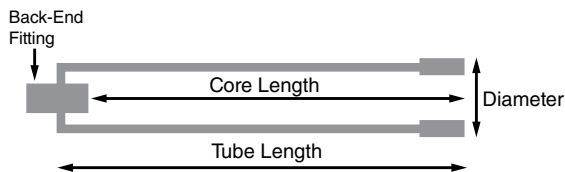

Classic, Charger, and Paradigm Wet Bits have a 16" Tube Length and produce a 13" Core Length





Reinforced Concrete and Harder Building Materials

Reinforced concrete, hard bricks, limestone, terrazzo, and other hard materials.

WET 

CLASSIC 

Economical choice for use in harder concrete with heavy reinforcement and masonry materials with good performance.

UPC	PART #	SIZE IN INCHES	SIZE IN MM	MAX RPM	SEGMENT HEIGHT
70184684447	CHBIT0100	1"	25mm	4,000	.375"
70184684448	CHBIT0150	1-1/2"	38mm	3,000	.350"
70184682762	CHBIT0200	2"	51mm	2,000	.350"
70184682763	CHBIT0225	2-1/4"	57mm	2,000	.350"
70184682764	CHBIT0250	2-1/2"	64mm	1,300	.350"
70184682765	CHBIT0300	3"	76mm	1,300	.350"
70184682766	CHBIT0350	3-1/2"	89mm	1,300	.350"
70184682767	CHBIT0400	4"	102mm	1,000	.350"
70184682768	CHBIT0425	4-1/4"	108mm	1,000	.350"
70184682769	CHBIT0450	4-1/2"	114mm	800	.350"
70184682770	CHBIT0500	5"	127mm	800	.350"
70184682771	CHBIT0600	6"	152mm	665	.350"
70184682772	CHBIT0700	7"	178mm	600	.350"
70184682773	CHBIT0800	8"	203mm	500	.350"
70184682774	CHBIT1000	10"	254mm	400	.350"
70184682775	CHBIT1200	12"	305mm	330	.350"
70184682776	CHBIT1400	14"	356mm	285	.350"



Wet Bits from 1" to 1-1/2" diameter have 5/8"-11 threaded adapters.

Wet Bits 1-3/4" diameter and larger have 1-1/4"-7 threaded adapters.

WET - PRESTRESSED CONCRETE 

CHARGER 

Fast drilling segments spaced to prevent segment loss when penetrating tensioned steel cable.

UPC	PART #	SIZE IN INCHES	SIZE IN MM	MAX RPM	SEGMENT HEIGHT
70184683983	CGPBIT0100	1"	25mm	4,000	.375"
70184683984	CGPBIT0125	1-1/4"	32mm	3,000	.375"
70184683985	CGPBIT0150	1-1/2"	38mm	3,000	.375"
70184683986	CGPBIT0175	1-3/4"	44mm	2,000	.375"
70184683987	CGPBIT0200	2"	51mm	2,000	.350"
70184683988	CGPBIT0225	2-1/4"	57mm	1,300	.350"
70184683989	CGPBIT0250	2-1/2"	64mm	1,300	.350"
70184683990	CGPBIT0300	3"	76mm	1,300	.350"
70184683991	CGPBIT0350	3-1/2"	89mm	1,000	.350"
70184683992	CGPBIT0400	4"	102mm	1,000	.350"
70184683993	CGPBIT0425	4-1/4"	108mm	800	.350"
70184683994	CGPBIT0450	4-1/2"	114mm	800	.350"
70184683995	CGPBIT0500	5"	127mm	800	.350"
70184683996	CGPBIT0600	6"	152mm	665	.350"
70184683997	CGPBIT0700	7"	178mm	600	.350"
70184683998	CGPBIT0800	8"	203mm	500	.350"
70184683999	CGPBIT1000	10"	254mm	400	.350"
70184684000	CGPBIT1200	12"	305mm	330	.350"
70184684001	CGPBIT1400	14"	356mm	285	.350"



Wet Bits from 1" to 1-1/2" diameter have 5/8"-11 threaded adapters.

Wet Bits 1-3/4" diameter and larger have 1-1/4"-7 threaded adapters.

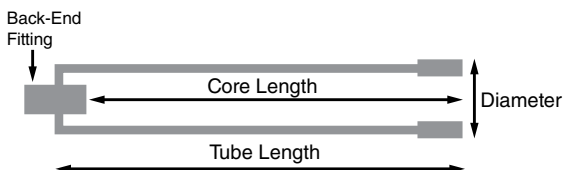

Classic, Charger, and Paradigm Wet Bits have a 16" Tube Length and produce a 13" Core Length



Asphalt and Abrasive Materials

Asphalt, green concrete, asphalt over concrete, abrasive blocks, mortar and other abrasive materials.

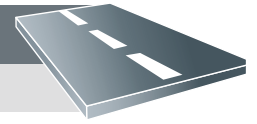

WET 

CHARGER

Long life bit segments for drilling abrasive materials. Excellent drilling speed and life in asphalt and other abrasive materials

UPC	PART #	SIZE IN INCHES	SIZE IN MM	MAX RPM	SEGMENT HEIGHT
70184684149	CGABIT0200	2"	51mm	2,000	.350"
70184684150	CGABIT0300	3"	76mm	1,300	.350"
70184684151	CGABIT0400	4"	102mm	1,000	.350"
70184684152	CGABIT0500	5"	127mm	800	.350"
70184684153	CGABIT0600	6"	152mm	665	.350"



Wet Bits from 1" to 1-1/2" diameter have 5/8"-11 threaded adapters.

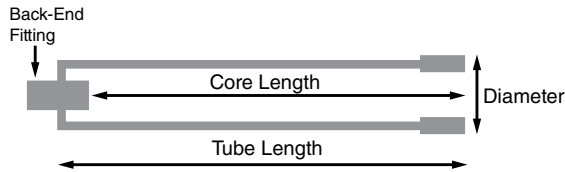

Classic, Charger, and Paradigm Wet Bits have a 16" Tube Length and produce a 13" Core Length

General Purpose and Masonry Building Materials

Blocks, medium-hard building bricks, paving slabs, concrete roof tiles and other medium-hard materials.



DRY 

CHARGER

Dry drilling core bits for use on portable drilling equipment. Best suited for applications in soft, non-reinforced cured concrete and concrete block.

UPC	PART #	SIZE IN INCHES	SIZE IN MM	MAX RPM	SEGMENT HEIGHT
70184683300	CGDBIT0100	1"	25mm	6,000	.275"
70184683301	CGDBIT0125	1-1/4"	32mm	6,000	.275"
70184683302	CGDBIT0150	1-1/2"	38mm	6,000	.275"
70184683303	CGDBIT0175	1-3/4"	44mm	5,000	.276"
70184683304	CGDBIT0200	2"	51mm	5,000	.275"
70184683305	CGDBIT0250	2-1/2"	64mm	5,000	.275"
70184683306	CGDBIT0300	3"	76mm	5,000	.275"
70184683307	CGDBIT0350	3-1/2"	89mm	5,000	.275"
70184683308	CGDBIT0400	4"	102mm	5,000	.275"
70184683309	CGDBIT0450	4-1/2"	114mm	5,000	.275"
70184683310	CGDBIT0500	5"	127mm	3,500	.275"
70184683311	CGDBIT0600	6"	152mm	2,500	.275"



Dry Core Bits have 5/8"-11 threaded adapters.



MERCHANDISING SOLUTIONS

OUR SELF-SELLING GOAL

Over two thirds of final consumer purchase decisions are made at the point-of-sale. The interaction between the product, the distributor and the consumer is key to the success of selling product.

New Norton Clipper branded display kits have been designed with a selection of components to help tailor the display for different products and merchandising requirements. In addition, a range of point-of-sale materials are available to further support sales growth for masonry, rental and construction supply distributors.



NORTON CLIPPER GONDOLA (BACKWALL) MERCHANDISER DISPLAY KIT

The complete kit comes with all components needed to create a full display for all Norton Clipper products. Wall merchandiser as shown is 40" wide x 90" high. This kit can be configured to fit 40" wide x 48" high aisle gondola set.



Backwall Merchandiser Display
Kit #: 0410048416

Kit Contains:



Norton Clipper header
(Qty 1)



Shelf (Qty 1)



Pegboards (Qty 4)



Display legs (Qty 4)



Double peg hooks for
diamond clamshell packages
(Qty 15)



Single peg hooks for
abrasive products (Qty 20)



Base (Qty 1)

Additional merchandising elements available and can be ordered separately:



Light Kit / UPC # 70184601803 – 36" long light tucks up behind sign, GE, 36" (91.4cm) warm white bulb 1"



Core Bit Hangers / UPC # 00510120422 – Effectively display your range of core bits with these simple hangers that can fit a wide range of Norton Clipper core bits

STARTING RECOMMENDATIONS FOR BEST WALL SETS

Contractor Supply Starter Abrasives Set

PART #	DESCRIPTION	QTY
Grinding Wheels		
70184601502	Norton Clipper Classic 4-1/2" x 1/4" x 5/8"-11 Concrete	10
70184601503	Norton Clipper Classic 4-1/2" x 1/4" x 5/8"-11 Metal / Stainless	10
70184601504	Norton Clipper Classic 4-1/2" x 1/4" x 7/8" Concrete	25
70184601514	Norton Clipper Charger 4-1/2" x 1/4" x 5/8"-11 Metal / Stainless	10
70184601515	Norton Clipper Charger 4-1/2" x 1/4" x 7/8" Metal / Stainless	25
70184601510	Norton Clipper Classic 7" x 1/4" x 5/8"-11 Metal / Stainless	10
70184601520	Norton Clipper Charger 7" x 1/4" x 5/8"-11 Metal / Stainless	10
Cut-off Wheels		
70184601455	Norton Clipper Classic Type 01 4-1/2" x .040" x 7/8" Metal / Stainless	25
70184601465	Norton Clipper Classic Type 27 4-1/2" x .045" x 7/8" Metal / Stainless	25
70184601457	Norton Clipper Classic Type 01 6" x .040" x 7/8" Metal / Stainless	25
70184601460	Norton Clipper Charger Type 01 4-1/2" x .045" x 7/8" Metal / Stainless	25
70184601470	Norton Clipper Charger Type 27 4-1/2" x .045" x 7/8" Metal / Stainless	25
70184601462	Norton Clipper Charger Type 01 6" x .045" x 7/8" Metal / Stainless	25
Circular Saw Wheels		
70184601484	Norton Clipper Classic 7" x 3/32" x DM-5/8" Metal	25
70184601485	Norton Clipper Classic 7" x 3/32" x DM-5/8" Concrete	25
Flap Discs		
70184601579	Norton Clipper Classic 4-1/2" x 5/8"-11 Type 27 Flat 40 Grit	10
70184601580	Norton Clipper Classic 4-1/2" x 5/8"-11 Type 27 Flat 60 Grit	10
70184601581	Norton Clipper Classic 4-1/2" x 5/8"-11 Type 27 Flat 80 Grit	10
70184601591	Norton Clipper Charger 4-1/2" x 5/8"-11 Type 27 Heavy Duty 40 Grit	10
70184601592	Norton Clipper Charger 4-1/2" x 5/8"-11 Type 27 Heavy Duty 60 Grit	10
70184601593	Norton Clipper Charger 4-1/2" x 5/8"-11 Type 27 Heavy Duty 80 Grit	10
Norton Clipper DiaLast		
70184694056	Norton Clipper DiaLast 7"	2
70184694053	Norton Clipper DiaLast 14"	2
Chop Saw Wheel		
70184601477	Norton Clipper Classic 14" x 3/32" x 1" Metal Side Reinforced	10
High-Speed Wheels – Universal Arbor		
70184601493	Norton Clipper Classic 14" x 1/8" x 1" 20mm High-Speed Metal	10
70184601491	Norton Clipper Classic 14" x 1/8" x 1" 20mm High-Speed Concrete	10
Wire Brushes		
70184601615	Norton Clipper Classic 4" x .020" x 5/8"-11 Std CS Twist Knot Wheel	5
70184601617	Norton Clipper Classic 12" x .035" x 1" CS Joint/Crack Cleaning Brush	2
Miscellaneous Abrasives		
70184601609	Norton Clipper Classic 6/4-3/4" x 2" x 5/8"-11 Concrete Cup	5
61463687800	Rubbing Brick	5

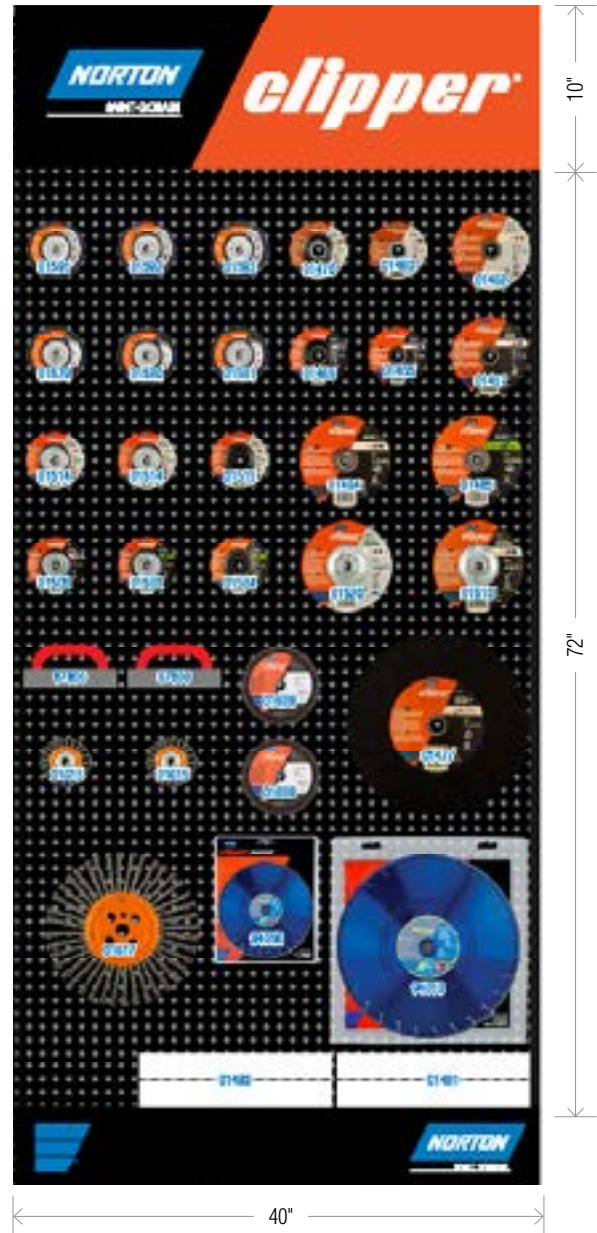

STARTING RECOMMENDATIONS FOR BEST WALL SETS

Contractor Supply Starter Diamond and Abrasive Set

PART #	DESCRIPTION	QTY
Core Bits		
70184682782	Norton Clipper Charger 2" Bit	1
70184682785	Norton Clipper Charger 3" Bit	1
70184682787	Norton Clipper Charger 4" Bit	1
70184682791	Norton Clipper Charger 6" Bit	1
Diamond Blades		
07660702790	Norton Clipper Classic 4-1/2" x .080" x 7/8"-5/8"-20mm Turbo	2
07660701194	Norton Clipper Classic 4-1/2" x .080" x 7/8"-5/8"-20mm Continuous	2
07660702789	Norton Clipper Classic 4-1/2" x .080" x 7/8"-5/8"-20mm Segmented	2
70184684547	Norton Clipper 4x4 14" x .118" x 1"-20mm Segmented	2
70184645926	Norton Clipper 4x4 MaxCut iHD 14" x .125" x 1"-20mm Segmented	2
70184684181	Norton Clipper ValuPlus 14" x .110" x 1"-20mm Segmented	5
07660702786	Norton Clipper Classic 7" x .080" x DM-7/8"-5/8" Segmented	2
07660702787	Norton Clipper Classic 7" x .090" x DM-7/8"-5/8" Turbo	2
Diamond Cups		
70184682595	Norton Clipper Classic 7" x 5/8"-11 Double Row	2
70184682593	Norton Clipper Classic 7" x 5/8"-11 Single Row	2
70184682555	Norton Clipper Classic 4" x 5/8"-11 Single Row	2
70184682586	Norton Clipper Classic 4" x 5/8"-11 Double Row	2
Diamond Tuck Point		
70184681777	Norton Clipper Classic 4-1/2" x .250" x 7/8"-5/8"-20mm Tuck Point	2
Abrasives		
70184601493	Norton Clipper Classic 14" x 1/8" x 1"-20mm UA High Speed Metal	10
70184601491	Norton Clipper Classic 14" x 1/8" x 1"-20mm UA High Speed Concrete	10
70184601609	Norton Clipper Classic 6/4-3/4" x 2" x 5/8-11 Concrete Cup	5
61463687800	Rubbing Brick	5

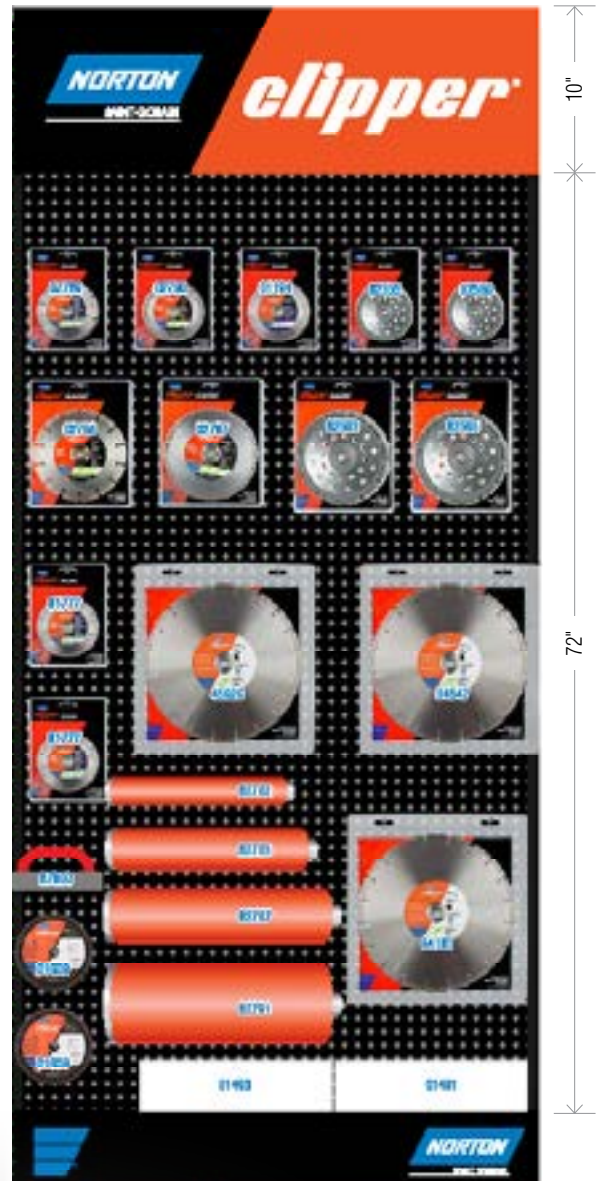

NORTON CLIPPER FREE-STANDING MERCHANDISER DISPLAY KIT

Free-standing displays for most popular High-Speed Saw/Diamond/Abrasives displays where customers can view in open area of a showroom. High-quality construction. Consistent branding and graphics. This free standing unit as shown is 40" wide at base x 90" high.



Free-standing Merchandiser Display
Kit #: 510116151

Kit Contains:



Norton Clipper header (Qty 1)



Clipper header (Qty 2)



Shelves (Qty 3)



Pegboards (Qty 3)



Double peg hooks for diamond clamshell packages (Qty 15)



Single peg hooks for abrasive products (Qty 20)

Additional merchandising elements available and can be ordered separately:



Core Bit Hanger / UPC # 00510120422 – Effectively display your range of core bits with these simple hangers that can fit a wide range of Norton Clipper core bits

STARTING RECOMMENDATIONS FOR BEST FREE-STANDING SETS

Saw Side

PART #	DESCRIPTION	QTY
High Speed Gas Saw		
70184647565	Norton Clipper 14" iLube High-Speed Gas Saw	1
Diamond Blades		
70184684547	Norton Clipper 4x4 14" x .118" x 1" 20mm – Segmented	5
Abrasives – Universal Arbor		
70184601493	Norton Clipper Classic 14" x 1/8" x 1"-20mm High Speed Metal	10
70184601491	Norton Clipper Classic 14" x 1/8" x 1"-20mm High Speed Concrete	10



STARTING RECOMMENDATIONS FOR BEST FREE-STANDING SETS

Diamond Side

PART #	DESCRIPTION	QTY
Core Bits		
70184682782	Norton Clipper Charger 2" Bit	1
70184682785	Norton Clipper Charger 3" Bit	1
70184682787	Norton Clipper Charger 4" Bit	1
70184682791	Norton Clipper Charger 6" Bit	1
Diamond Blades		
07660702790	Norton Clipper Classic 4-1/2" x .080" x 7/8"-5/8"-20mm Turbo	2
07660701194	Norton Clipper Classic 4-1/2" x .080" x 7/8"-5/8"-20mm Continuous	2
07660702789	Norton Clipper Classic 4-1/2" x .080" x 7/8"-5/8"-20mm Segmented	2
70184684547	Norton Clipper 4x4 14" x .118" x 1"-20mm- Segmented	2
70184645926	Norton Clipper 4x4 MaxCut iHD 14" x .125" x 1"-20mm- Segmented	2
70184684181	Norton Clipper ValuPlus 14" x .110" x 1"-20mm- Segmented	5
07660702786	Norton Clipper Classic 7" x .080" x DM-7/8"-5/8" Segmented	2
07660702787	Norton Clipper Classic 7" x .090" x DM-7/8"-5/8" Turbo	2
Diamond Cups		
70184682595	Norton Clipper Classic 7" x 5/8"-11 Double Row	2
70184682593	Norton Clipper Classic 7" x 5/8"-11 Single Row	2
70184682555	Norton Clipper Classic 4" x 5/8"-11 Single Row	2
70184682586	Norton Clipper Classic 4" x 5/8"-11 Double Row	2
Diamond Tuck Point		
70184681777	Norton Clipper Classic 4-1/2" x .250" x 7/8"-5/8"-20mm Tuck Point	2

Abrasive Side

PART #	DESCRIPTION	QTY
Grinding Wheels		
70184601502	Norton Clipper Classic 4-1/2" x 1/4" x 5/8"-11 Concrete	10
70184601503	Norton Clipper Classic 4-1/2" x 1/4" x 5/8"-11 Metal / Stainless	10
70184601504	Norton Clipper Classic 4-1/2" x 1/4" x 7/8" Concrete	25
70184601514	Norton Clipper Charger 4-1/2" x 1/4" x 5/8"-11 Metal / Stainless	10
70184601515	Norton Clipper Charger 4-1/2" x 1/4" x 7/8" Metal / Stainless	25
70184601510	Norton Clipper Classic 7" x 1/4" x 5/8"-11 Metal / Stainless	10
70184601520	Norton Clipper Charger 7" x 1/4" x 5/8"-11 Metal / Stainless	10
Cut-off Wheels		
70184601455	Norton Clipper Classic Type 01 4-1/2" x .040" x 7/8" Metal / Stainless	25
70184601465	Norton Clipper Classic Type 27 4-1/2" x .045" x 7/8" Metal / Stainless	25
70184601457	Norton Clipper Classic Type 01 6" x .040" x 7/8" Metal / Stainless	25
70184601460	Norton Clipper Charger Type 01 4-1/2" x .045" x 7/8" Metal / Stainless	25
70184601470	Norton Clipper Charger Type 27 4-1/2" x .045" x 7/8" Metal / Stainless	25
70184601462	Norton Clipper Charger Type 01 6" x .045" x 7/8" Metal / Stainless	25
Circular Saw Wheels		
70184601484*	Norton Clipper Classic 7" x 3/32" x DM-5/8" Metal	25
70184601485*	Norton Clipper Classic 7" x 3/32" x DM-5/8" Concrete	25
Flap Discs		
70184601579	Norton Clipper Classic 4-1/2" X 5/8"-11 Type 27 Flat 40 Grit	10
70184601580	Norton Clipper Classic 4-1/2" X 5/8"-11 Type 27 Flat 60 Grit	10
70184601581	Norton Clipper Classic 4-1/2" X 5/8"-11 Type 27 Flat 80 Grit	10
70184601591	Norton Clipper Charger 4-1/2" X 5/8"-11 Type 27 Heavy Duty 40 Grit	10
70184601592	Norton Clipper Charger 4-1/2" X 5/8"-11 Type 27 Heavy Duty 60 Grit	10
70184601593	Norton Clipper Charger 4-1/2" X 5/8"-11 Type 27 Heavy Duty 80 Grit	10
Chop Saw Wheel		
70184601477	Norton Clipper Classic 14" x 3/32" x 1" Metal Side Reinforced	10
Wire Brushes		
70184601615	Norton Clipper Classic 4" x .020" x 5/8"-11 Std CS Twist Knot Wheel	5
70184601617	Norton Clipper Classic 12" x .035" x 1" CS Joint/Crack Cleaning Brush	2
Miscellaneous Abrasives		
70184601609	Norton Clipper Classic 6/4-3/4" x 2" x 5/8"-11 Concrete Cup	5
61463687800	Rubbing Brick	5

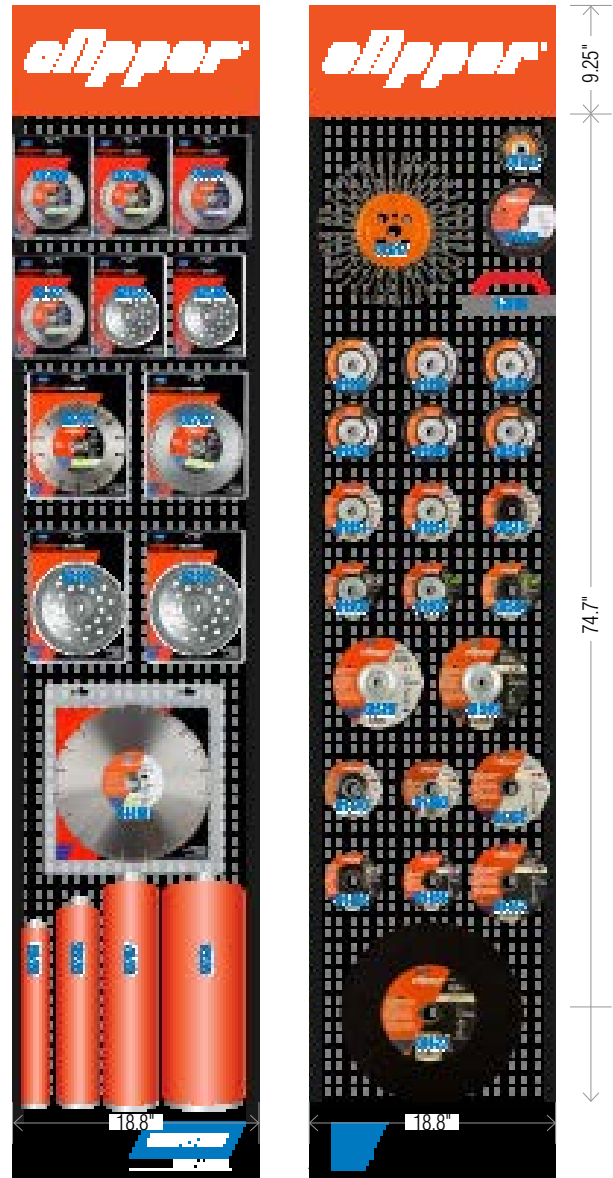



Abrasive Aisle Talker
UPC # 70184695555

Quickly and easily understand and sell the range of coated and bonded abrasive products in a way that keeps things aligned and easily accessible by the consumer. Size 36" high x 12" wide. Spanish on reverse.

Mounting hooks included



Diamond Aisle Talker
UPC # 70184695555

The diamond blade talkers describe which diamond products work best of each application. Our 5 step specification method makes it simple to recommend the right diamond product for each job. Size 36" high x 12" wide. Spanish on reverse.

Mounting hooks included



Diamond Blade Selection Guide
11" x 17" / Form # 8678
25" x 38" / Form # 8679

A quick reference guide to help easily identify the proper blade to select for your application. Available in a double sided 11x17 sheet, or a full size wall poster.

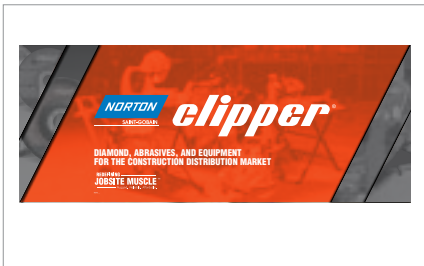

Norton Clipper Banner
Form # 8650

Bring more brand awareness to your showroom by displaying our 60" x 24" vinyl banner highlighting our diamond blades, abrasives and construction equipment.

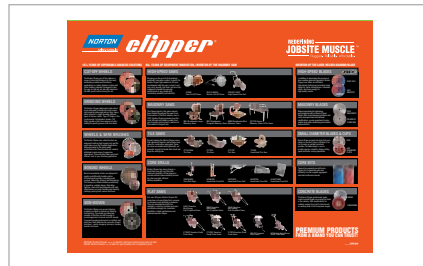

Norton Clipper Counter Mat
Form # 8649

Advertise premium Norton Clipper products and reputable history at checkout with this 21" x 16" counter mat. This showcases all of the reasons why Norton Clipper is your most reliable source for all your cutting and grinding construction jobsite solutions.

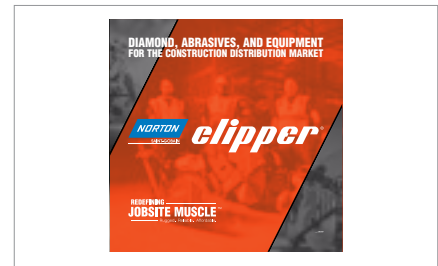

Norton Clipper Floor Decal
Form # 8648

Take a step in the right direction and give your showroom a more professional look by installing our custom vinyl floor decal. A nice visual to help promote the Norton Clipper brand.

Simplified Packaging

taking less talk
TO CUT MORE ROCK!



In addition to our self-selling packaging, we have a new look for our premium iHD diamond blades. Using a brand new technology industrialized for the first time by Norton Clipper, the blade information is printed directly on the entire surface of the diamond blade. This creates an IMPROVED VISUAL IMPACT FOR YOUR SHOWROOM!



“ We have a very large showroom with many vendors, the Norton Clipper point-of-purchase display is the center of attention. It's bright, well organized and features all our fastest moving items. We call it our silent sales person – as customers browse the store they are attracted to the large display and pick the right products to do the job and are out quick and back on the job site. Our silent sales person is so effective that our biggest challenge is keeping the display full as the Norton Clipper products fly off the hooks. Our sales from the point-of-purchase display are incredibly strong; this maximizes our turns and earns. If we didn't have such a great point-of-purchase display our sales of Norton Clipper products wouldn't be as great as they are today.”

– **Unicon Concrete Specialties,**
Edmonton, Alberta Canada

Breakages/Personal Injury

In the event of on-machine breakage of Norton Clipper abrasive products, call your local Norton Clipper Distributor immediately. Whether involving personal injury or not, the user should leave the equipment and other evidence undisturbed until a Norton Clipper Sales Representative has been notified and conducts an investigation. Prompt action on the part of product user, Distributor and Norton Clipper sales personnel is important to ensure swift determination of the breakage cause and to guard against recurrence.

Safe Operating Practices

Safe operating practices must be part of every grinding wheel user's operation. The greatest efficiency and lowest overall abrasive/diamond cost can be realized only if proven care and use techniques become standard practice.





- Be sure to read any safety material/ guidelines provided with the abrasive product.
- Always check the wheel for cracks or damage before use.
- Before mounting the wheel, use a tachometer to measure the spindle speed.
- Ensure the mounting flanges, backplate or adapter supplied by the machine manufacturer are used and kept in good condition. ANSI Safety Requirement B7.1 provides wheel mounting requirements. Check mounting flanges for equal and correct diameter and use blotters when supplied.
- Always mount, true and dress the wheel in conformance with the guidelines published in the ANSI Safety Requirements B7.1.
- Ensure the correct wheel guard is in place before starting the wheel. Allow the wheel to come up to full operating speed before starting to grind for a minimum of one minute, and stand out of the plane of rotation.
- NEVER use a high-speed air sander as a portable grinder.
- NEVER use a high-speed air sander as a portable grinder.
- NEVER exceed the maximum operating speed marked on the wheel being used. The following formula may be used to calculate wheel speed:
SFPM = Spindle Speed in RPM x Wheel Dia. in inches x .262
- Avoid dropping or bumping the wheel.
- When not using the wheel, store the wheel in its original packing materials. This protects the wheel from chips and cracking, as well as provides easy identification of the wheel.

For more information on product safety, ask your Norton Distributor for these publications:

- "Primer on Grinding Wheel Safety" (form 474)
- Portable Grinding Safety (form 1406)
- ANSI B7.1 "Safety Requirements for the Use, Care and Protection of Abrasive Wheels"
- Material Safety Data Sheets
- Other applicable regulations

UAMA Approved Safety Icons

The UAMA has approved a new set of standardized icons to be used throughout the Abrasive industry to convey safety information to the users. Below are the approved icon types and their definitions.

ICON TYPES	EXAMPLE
<p>Safety Icon: A pictorial whose purpose is to relay safety related information to the user.</p>	
<p>Hazard Alert Icon: This type of safety icon conveys information primarily related to the nature of a hazard. It contains a graphical depiction of the hazard drawn within a yellow equilateral triangle.</p>	
<p>Prohibition Icon: This type of safety icon conveys actions that should not be taken. It consists of a red circular band with a 45° diagonal red band from upper left to lower right. The icon contains a black depiction of what should not be done within the red band on a white background.</p>	
<p>Mandatory Action Icon: This type of safety icon conveys actions that should be taken to avoid hazards. It consists of a white image within a solid blue or black circular surround shape.</p>	
<p>Proper Machine Use Icon: This type of icon is designed to show the use of the wheel on a proper machine. The icon can be a bit more realistic to show components such as a safety guard and an auxiliary handle. The recommended angle of use may also be depicted.</p>	

ICON	MEANING	ICON	MEANING
	Improper use may break wheel and cause serious injury or death.		Always use wheel guard for angle grinder.
	No side grinding. Cutting only.		Always use wheel guard for non-portable machine.
	No side grinding. Cutting only		Protect your eyes.
	No cutting. Side grinding only.		Protect your face.
	No cutting. Side grinding only, grouped icon.		Protect your lungs against dust.
	Do not use a damaged wheel.		Protect your hearing.
	Do not use on High Speed Gas Saws.		Protect your eyes and face.
	Do not use on Angle Grinders.		Protect your eyes and hearing. Combined icon.
	Do not use on die grinders		Protect your eyes, ears and lungs.
	Warning alert symbol.		Protect your hands.
	Read OSHA and ANSI B7.1.		Use matched diameter, relieved flanges.
	Read OSHA and ANSI B7.1.		

Silica and What You Need to Know

Background and Health impacts

Silica (SiO₂) is one of the most common minerals in the earth's crust. Glass, beach sand, silicone and granite are all "silica" materials. Products containing silica have been used for thousands of years in building and is a key ingredient in many products we use every day. There are two forms of silica; crystalline and non-crystalline. Crystalline silica is a mineral that occurs in several forms. Quartz, the most common form, is a component of sand, stone, rock concrete, brick, block and mortar. Non-crystalline silica is found in glass, silicon carbide and silicone.

When rocks containing crystalline silica are cut, crushed, ground, drill or used in similar industrial processes, dust particles are produced. These particles are very fine, at least 100 times smaller than ordinary beach sand – known as respirable crystalline silica or RCS. Inhaling very small or respirable crystalline silica particles is most hazardous and may cause multiple diseases such as silicosis, followed in severe cases by lung cancer.

Who is at risk from exposure to crystalline silica?

It is estimated that 2.3 million workers are exposed to crystalline silica on the job. The majority of the workers, about 2 million, are in the construction industry. The hazard exists when specific activities create respirable dust that is released into the air.

The New OSHA Standard

OSHA's recently implemented silica standards for Construction "29 CFR 1926.1153" and General Industry "29 CFR 1910.1053" suggests procedures applicable for work in these environments. This new standard affects all activities that generate silica dust on a jobsite. Trades involving brick, stone, concrete and other materials that are difficult to replace must comply with the standard.

This is a change around "process", not specific products.

Impacts on Industry

Industries affected by this regulation include Construction, Glass manufacturing, Pottery products, Structural clay products, Concrete products, Foundries, Cut stone and Stone products, Railroads, Refractory products and Asphalt products manufacturing to name a few. Always read the Safety Data Sheet for the workpiece and abrasive before use.

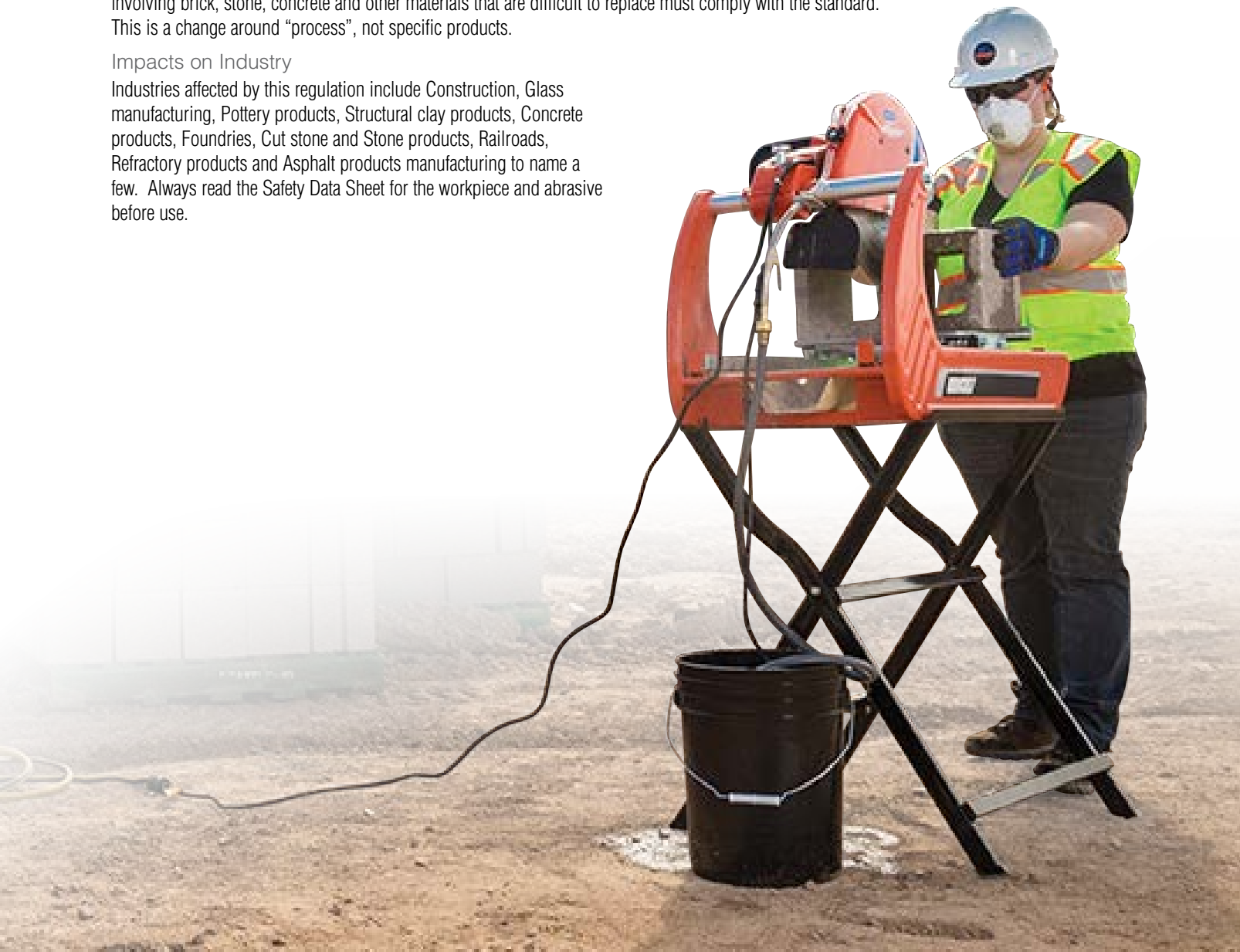

How Diamond Blades Work

Since they do wear down in use, diamond blades are actually “grinding wheels” with diamond particles as the abrasive agent. Individual diamond particles remove material by “scratching out” particles of hard, dense substances, or by “knocking out” larger particles of loosely bonded, abrasive material during the cutting operation.

Although diamonds are the hardest substance in the world, these diamond particles do wear out or break down after cutting for a period of time. New, untouched diamonds are, however, exposed by the wearing down of the metal “bond.”

Large particles of soft, abrasive materials wear down this metal bond faster than the small particles removed from hard, dense materials. Because of this, a diamond blade for cutting a soft, abrasive material must have a hard metal bond to resist this erosion long enough for the exposed diamonds to be properly utilized. Conversely, a soft bond is needed to ensure that it will erode and expose new diamonds, allowing the blade to continue cutting efficiently.

Years of experience and development have given us a vast number of bonds of different hardness levels for different levels of “Controlled Bond Erosion” for all masonry and concrete materials.

How to Mount Diamond or Abrasive Blades

- Using the blade shaft wrench supplied with the saw, loosen and remove the blade shaft bolt and remove collar. Be sure blade shaft collars and arbor are free of dirt and all foreign materials before mounting blade on the shaft. **TIGHTENING AN ABRASIVE BLADE AGAINST AN UNEVEN SURFACE COULD FRACTURE THE BLADE** or cause blade to run out of alignment, causing excessive blade wear, and/or unsafe sawing conditions.
- Place the blade on the arbor. Attach loose collar and tighten the blade shaft bolt securely. When tightening bolt against outside blade shaft collar, be sure to tighten enough to hold the blade firmly without slipping, but do not over tighten. **EXCESSIVE TIGHTENING CAN CAUSE AN ABRASIVE BLADE TO FRACTURE.**

How to Use Your Masonry Saw for Dry Cutting

- Use a proper blade which is clearly marked for dry cutting.
- Remove water curtain.
- Disconnect the electric water pump.
- Use “Step Cutting” as explained previously when using wet or dry cutting diamond blades or abrasive blades.
- Dry cut only in large open areas with adequate ventilation.

How to Use Your Masonry Saw for Wet Cutting

Water may be supplied either by filling the water pan to within 1/2” of top, or for a continuous flow of clean water use a barrel. When using water from barrel, remove water pump from pan and submerge it in water barrel. Remove the drain plug so the used water and sludge will drain from pan.

- Prepare water supply.
- Install water curtain on cutting head pivot bar.
- Be sure the water pump is plugged into the connection on the masonry saw motor. (It will start when the main switch is turned on.)
- Handle on petcock should be turned in line with the water flow. Start motor and be certain that both sides of the blade are getting an adequate flow of water.
- At all times make sure that the water level covers the screen on the bottom of the pump. Do not let sludge and dirt get deep enough in the pan to block the pump inlet.
- Use “Step Cutting” with abrasive blades as previously described.
- Use “Jam Cutting” or “Step Cutting” with diamond blades as previously described.

How to Use “Jam Cutting” (Fixed Cutting) and “Step Cutting” With Diamond Blades

In “Jam Cutting,” the cutting head is locked in a fixed position and the material is pushed into the blade as shown in Figure 1. “Jam Cutting” with the cutting head locked in position usually provides greater efficiency than merely holding the head down.

“Jam Cutting” works well with wet diamond blades cutting some soft materials. It is less efficient overall than the “Step Cutting” method for most material, especially when using dry diamond or abrasive blades.

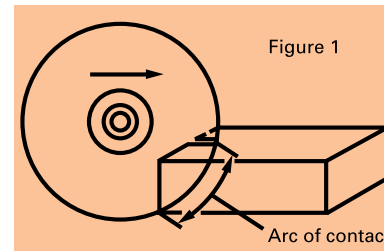

- To lock the head into position, tighten lever nut at back of saw or lower the cutting head to desired cutting depth, depending on the model saw you are using.
“Step Cutting” with diamond blades is done by applying more pressure to blade and making a deeper cut. Unlike “Step Cutting” with abrasive blades, “Step Cutting” with diamond blades requires only a few passes through the material.
- In cutting, clamp the material securely or hold it firmly against the conveyor cart backstop. **IF THE MATERIAL IS ALLOWED TO SLIP, RESULTING SEIZURE OF THE BLADE MAY BEND THE DIAMOND BLADE CENTER OR CAUSE A RIM SECTION TO BE TWISTED OFF.**
- Do not force the material or bump into the blade. **WHEN NEARING COMPLETION OF THE CUT, RETARD AND SLIGHTLY HOLD BACK THE CONVEYOR CART.** If this is not done, the material may be pulled into the blade so fast that excessive pressure on the rim may cause warping or twisting of the rim section.
- When a new diamond blade is broken in, make the first few cuts slowly until the blade cuts freely and easily.
- When the blade is cutting freely and easily, **USE IT!** As long as it cuts satisfactorily, do not dress the diamond blade or remove it from the blade shaft.
- After continuous cutting of extremely hard and dense materials, the blade may slow down and it may be necessary to “dress” the cutting edge. To do this, make a few rapid, shallow cuts using the “Step Cutting” method. If this is not sufficient, then make one or two cuts in a soft abrasive light weight block.

Concrete and Asphalt Sawing Methods

In concrete and asphalt cutting operations, the usual equipment used are 8 to 65HP flat saws.

Asphalt cutting and the cutting of asphalt overlaid concrete should not be considered the same type operation from a blade recommendation standpoint. In the case of asphalt overlay, the application involves cutting both asphalt and cured concrete which gives a different abrasive level than the cutting of asphalt alone.

Generally, the cutting of asphalt overlaid concrete is done at full depth with blades less than 18" in diameter as long as the asphalt is more than 1/3 the total depth of cut. Standard recommended specifications for asphalt overlaid concrete should be employed until the depth of the asphalt reaches 50% of the total cut. At this point, harder blades should be used which would increase the blade life.

The larger diameter blades, 18" and above, are used in a step cutting method at cutting depths of 2" and 3" in short travel distances of 15' to 20'. This allows the blade to remain in a free cutting condition and does not slow down the cutting operation. Asphalt cutting is primarily performed at full depth. However, if the aggregate used in asphalt is larger than .750 in diameter and/or is quartz or chert aggregate, the cutting operation may have to be modified to a step cutting operation.

Green Concrete Sawing Methods

Green concrete is cut to control cracking in large concrete pours. Usually saws from 5 HP to 65 HP are used for this purpose, depending on the size of the job. The initial sawing of the concrete is done within a 24 hour period at a depth of 1/3 to 1/4 of the total concrete thickness. Generally 6" to 14" blades are used with .110" through .150" widths.

After the initial cut has been made, the joint may require additional widening for the backing rod and/or sealant. This requires a blade diameter of 12" or 14" in widths up to .500".

Concrete Deep Sawing Methods

Generally, deep sawing of cured concrete is done using high horsepower concrete saws and blades above 20" in diameter. 65 HP concrete saws are used in conjunction with 24", 30", and 36" diameter blades to obtain the desired depth of 8" to 14" (this is usually the standard thickness of concrete highways in North America). The blades are usually used at approximately 12,000 surface feet per minute (outside rim speed of the blade).

The use of these blades is usually dictated by the hardness of the aggregates contained in the concrete. A cutting rate of 4' to 6' per minute is the speed of cut most operators prefer. This cut rate is usually directly related to the depth of cut. In areas with hard aggregate, it is common to make multiple passes of 2" to 3" deep until desired full depth of cut is reached. Softer aggregates can be cut using deeper passes without sacrificing cutting speed.

Core Drilling Methods

The performance of any diamond core bit depends heavily on the use of proper drilling techniques. Although drilling conditions and materials may vary, following specific guidelines ensures faster drilling speed and longer bit life.

1. Secure the core drill to the work surface so that there is no movement in the drill that would allow the bit to bind in the hole.
2. Use a sufficient supply of water to ensure that hole is constantly being flushed of abrasive cuttings.
3. Slowly lower the bit into the cut so that there is no skidding or lateral movement of the drill bit. The entire circumference of the core bit should penetrate the drilling surface before additional pressure is applied to the handle.
4. Exert steady downward pressure on the bit while drilling. Do not force the bit into the material.
5. Do not stop the flow of water or the rotation of the bit as long as the bit is in the hole.
6. If the drilling rate decreases noticeably, check the core bit. The slower penetration rate generally means that the bit is dull and needs to be reconditioned.

Concrete Saw Safety Precautions

IMPORTANT: FOR COMPLETE SAFETY INFORMATION, REFER TO ANSI SAFETY CODE B7.1 AVAILABLE THROUGH THE AMERICAN NATIONAL STANDARDS INSTITUTE.

IMPORTANT: CONSULT THE MANUFACTURER OF THE HIGH-SPEED HAND-HELD SAW FOR APPROPRIATE SAFETY INFORMATION, AS WELL AS ANSI B7.5.

THE FOLLOWING SAFETY PRECAUTIONS MUST BE OBSERVED.

1. Before mounting any blade on the saw, the blade should be inspected= for any damage that might have occurred during shipment, handling or previous use.
2. The blade shaft collars must be of proper diameter for the size blade being used. The drive pin must be located in the tight collar or the loose pin, and arbor should be cleaned and examined for damage before mounting the blade.
3. The blade must be properly fitted over arbor and drive pin. Drive pin must project through hole in blade and into collar. Do not force the blade onto arbor.
4. Disconnect spark plugs and use the blade shaft lock pin when tightening the blade shaft nut. Tighten the blade shaft nut securely against the outside blade shaft collar. The blade shaft has left hand threads on the right side of the saw and right hand threads on the left side of the saw.
5. The blade guard must always be in place when the saw is running. Always use a proper size blade guard for the size blade being used.
6. The operator should wear safety glasses and appropriate safety equipment at all times.
7. Never leave saw unattended while engine is running.
8. Always secure saw from rolling when not in use.
9. Do not stop the engine on a self-propelled saw while on a grade.
10. When stopping any saw on a grade, the wheels must be chocked.
11. When starting the saw, the operator should stand away from and to the side of the blade.
12. If for any reason the blade stalls in the cut, raise the blade out of the cut and check the outside blade shaft collar and nut for tightness before restarting the engine. Inspect the blade for damage. Use care when resuming a cut. Make certain that the blade is in alignment with the previous cut.
13. During cutting, do not exert excessive side pressure on the handles as a method of steering. Do not force the blade into material by lowering the blade too quickly or by increasing the speed of the saw.
14. Adequate coolant must be used when sawing with wet cutting abrasive or diamond blades. Gravity feed does not supply a sufficient water flow. The water pumps on concrete saws are "booster" pumps only and are not adequate as primary pressure source. An adequate coolant supply is required for wet cutting blades to maintain blade life and cutting efficiency.
15. The blade shaft must be operated within the specified maximum operating speed.
16. Operate engine at proper RPM. Never alter RPM or governor setting.
17. In case of an EMERGENCY "SHUT OFF ENGINE."

Core Drill Safety Precautions

1. In most cases, core drilling requires the use of water. Properly ground the core drill, as the use of any electrical tools in wet areas can be hazardous.
2. The three-pronged plug on the power cord of the motor or the extension cord must be plugged into a grounded electrical outlet of the appropriate voltage.
3. The core drill must be securely fastened to the intended work surface (wall, deck, etc.), using anchor bolts, vacuum pad or jack screw.
4. Use extreme caution when drilling through floors. Check for electrical conduit.
5. Provide protection for all personnel and materials below the areas being drilled.

Masonry Saw Safety Precautions

The following is a list of safety practices which must be observed when sawing with masonry saws:

1. Keep the area around the saw free from debris which could cause falls.
2. Prohibit the use of the saw by unauthorized or untrained personnel.
3. Keep the conveyor cart free of grit and debris which could allow the material to slip or twist during cutting operations.
4. Hold the material firmly against the backstop of the conveyor cart or guide-a-cut, keeping fingers out of the path of the blade.
5. Position the saw on a firm, flat area and be sure that the saw will not move in use.
6. Replace blade collars if they become worn to less than 4" diameter for 18" and 20" blades, or less than 3 1/2" diameter on 14" blades.

Diamond Blade Safety – Do's & Don'ts

All manufacturers of diamond blades are very concerned that their products are used in a safe manner. **The following is a list of Do's and Don'ts for concrete and masonry sawing.** This is provided with the intention of eliminating hazardous conditions or practices. Please take time to read and understand its principles.

Wet Cutting Do's & Don'ts

1. **Do** follow manufacturer's recommended blade specifications for material to be cut.
Don't use a diamond saw blade without checking manufacturer's recommendations for the material to be cut. Improper selection can cause excessive blade wear and possible damage to the diamond saw blade and/or machine, and create an unsafe operating condition.
2. **Do** inspect the diamond blade for damage that may have occurred during shipment or damage due to previous use.
Don't use a new diamond saw blade or remount a used blade which has a core that is not flat or is cracked, which shows segment damage or loss, or which has a damaged arbor hole.
3. **Do** check mounting flanges for equal diameter, excess wear and flatness. Mounting flanges must have adequate relief around arbor hole.
Don't use mounting flanges on which the bearing surfaces are not clean and flat.
4. **Do** be sure that the diamond saw blade is mounted on a correct diameter blade shaft between proper blade flanges and is securely hand-tightened with a wrench.
Don't force blade onto machine blade shaft or mount blade on undersized blade shaft. Either condition can result in unsafe operating conditions and excessive blade wear.
5. **Do** check the saw for proper operating conditions:
 - A. All fluids are at proper levels.
 - B. Blade shaft bearings should be free of end and radial play.
 - C. V-belts should be properly tensioned and pulleys checked for excessive wear.
 - D. Lead off adjustment is set correctly, to allow the blade to travel straight.
 - E. Do operate with blade guard in place and properly secured.**Don't** mount blade on machine that does not meet the minimum requirements set forth in the manufacturer's machine operating manual.
6. **Do** be sure there is a continuous water flow to each side of the blade. Gravity feed does not supply a sufficient water flow. The water pumps on concrete saws are "booster" pumps only and are not adequate as a primary pressure source. An adequate coolant supply is required for wet cutting blades to maintain blade life and cutting efficiency.
7. **DO FOLLOW THE MANUFACTURER'S RECOMMENDED PULLEY SIZES AND OPERATING SPEEDS. FOR SPECIFIC BLADE DIAMETERS, REFER TO MANUFACTURER'S OPERATING MANUAL.**
8. **Do** operate the saw with proper safety attire, i.e., safety glasses, safety helmet, safety shoes and hearing protection.
9. **Do** examine blade periodically for cracks in the steel center or segments, or excessive wear under the segments.

Dry Cutting Do's & Don'ts

1. **Do** follow manufacturer's recommendation regarding specification for material to be cut and suitability for dry cutting applications.
Don't cut dry except with a blade specifically designated for dry cutting by the manufacturer.
2. **Do** inspect the diamond saw blade for damage that may have occurred during shipment or damage due to previous use.
Don't force blade onto machine blade shaft, alter the size of the mounting hole, or tighten mounting nut excessively. The use of bushings to reduce the arbor hole size is not recommended for diamond blades used on high-speed saws.
3. **Do** inspect the diamond blade periodically during use for core flatness, fatigue cracks, segment damage, undercutting and damage to the arbor hole.
Don't exceed the maximum operating speed established for the diamond blade.
4. **Do** check the mounting flanges to be sure that they are of equal or correct diameter, that they do not show excessive wear, and that they are flat.
Don't operate a saw without proper safety guards in place. NEVER OPERATE ANY SAW, WET OR DRY, WITHOUT A BLADE GUARD!
5. **Do** be sure that the diamond blade is mounted on a correct diameter blade shaft between proper blade flanges and is securely hand tightened with the wrench provided or an adjustable wrench no longer than 8".
Don't stand in direct line with dry diamond or abrasive blades during start-up or operation.
6. **Do** check for proper saw machine conditions. Spindle bearings should be free of end and radial play. Consult the operating manual from the saw manufacturer for proper machine maintenance conditions.
Don't cut or grind with the sides of a diamond blade.
7. **Do** follow the manufacturer's recommendation for operating speeds for specific blade diameters.
Don't force the blade into the material; allow the blade to cut at its own speed. Forcing the blade may cause overheating or blade damage.
8. **Do** maintain a firm grip on hand-held saws during cutting operation.
Don't make long continuous cuts with a dry diamond blade. Allow the blade to cool by turning in air every few minutes. The harder the material being cut, the more often the blade should be allowed to cool.
9. **Do** wear proper safety equipment at all times. Always wear safety glasses, safety footwear, snug fitting clothing, hearing and head protection, and respiratory equipment where required.
Don't use the blade to cut material other than that recommended by the manufacturer for that specific blade type.
10. **Don't** use the blade on a type of saw other than that specified by the manufacturer.
11. **Don't** allow the blade to deflect in the cut.
12. **Don't** attempt to cut curves or radii.



**HIGH-SPEED
HAND SAW BLADES**

Maximum Blade
Cutting Depths and
Recommended
Operating Speeds

BLADE DIAMETER	CUTTING DEPTH	MAX. SPEED (RPM)
12"	4"	6,300
14"	5"	5,460
16"	6"	4,500



MASONRY BLADES

Maximum Blade
Cutting Depths and
Recommended
Operating Speeds

BLADE DIAMETER	CUTTING DEPTH	IDEAL SPEED (RPM)	MAX. SPEED (RPM)
14"	5"	2,592	4,365
18"	7"	2,016	3,395
20"	8"	1,814	3,055
24"	10"	1,512	2,550



CONCRETE SAW BLADES

Maximum Blade
Cutting Depths and
Recommended
Operating Speeds

BLADE DIAMETER	CUTTING DEPTH	IDEAL SPEED (RPM)	MAX. SPEED (RPM)
7"	1-1/2"	5,184	8,730
8"	2"	4,536	7,640
12"	3-5/8"	3,024	5,095
14"	4-5/8"	2,592	4,365
16"	5-5/8"	2,268	3,820
18"	6-5/8"	2,016	3,395
20"	7-5/8"	1,814	3,055
24"	9-5/8"	1,512	2,550
26"	10-5/8"	1,396	2,350
30"	11-3/4"	1,120	2,040
36"	14-3/4"	1,008	1,700
42"	17-1/2"	864	1,455
48"	19-3/4"	756	1,275

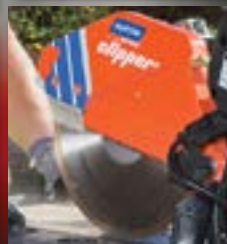

TILE SAW BLADES

Maximum Blade
Cutting Depths and
Recommended
Operating Speeds

BLADE DIAMETER	CUTTING DEPTH	IDEAL SPEED (RPM)	MAXI. SPEED (RPM)
4"	3/4"	9,072	15,000
4-1/2"	1"	8,063	13,300
5"	1-1/4"	7,257	12,000
6"	1-3/4"	6,048	10,185
7"	2-1/4"	5,184	8,730
8"	2-3/4"	4,536	7,640
9"	3-1/4"	4,032	6,790
10"	3-3/4"	3,629	6,115

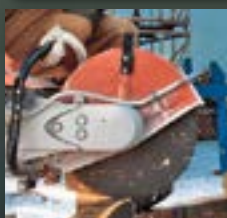

**ABRASIVE BLADES
AND WHEELS**

Maximum Recommended
Operating Speeds

BLADE DIAMETER	TYPE 1 CUT-OFF WHEELS	HIGH-SPEED BLADES	TYPE 27 AND 28 WHEELS	TYPE 11 CUP WHEELS
4"	19,000		15,000	9,050
4-1/2"	13,300		13,300	
5"	12,000		12,000	7,255
6"	10,000		10,000	6,050
7"	8,600		8,600	
8"	7,500			
9"	6,800	6,800	6,800	
10"	6,110			
12"	5,095	6,300		
14"	4,365	5,400		
16"	3,820	4,500		
18"	3,395			

NOTE: Diamond blade cutting depths listed are approximate. Actual cutting depth will vary with the exact blade diameter or saw type, or the exact diameter of the blade flanges. Cutting depth will also be reduced if saw components extend below the blade flanges.



CORE BITS

Minimum and Maximum
Recommended Operating
Speeds

BIT DIAMETER	MIN. (RPM)	IDEAL SPEED (RPM)	MAX. (RPM)
1"	2,400	3,200	4,000
2"	1,200	1,600	2,000
3"	800	1,050	1,300
4"	600	800	1,000
5"	475	640	800
6"	400	530	665
7"	340	450	600
8"	300	400	500
10"	240	320	400
12"	200	265	330
14"	170	225	285
16"	150	200	250
18"	130	175	220
20"	120	160	200
24"	100	130	165
26"	90	125	150
30"	80	105	130
32"	75	100	125
34"	70	95	120
36"	65	85	110
40"	60	80	100
42"	55	75	95



Extension Cord Size Recommendations

3 Phase Motor

TOOL HP	AMPS	VOLTAGE	>50'	50' - 100'	100' - 150'	150' - 200'
5	12	230v	#14	#12	#10	#8
5	6	460v	#14	#14	#12	#10
10	24	230v	#10	#8	#6	#4
10	12	460v	#14	#12	#10	#8
20	52	230v	#6	#6	#4	#2
20	26	460v	#10	#8	#6	#4
25	58	230v	#6	#6	#4	#2
25	29	460v	#10	#8	#6	#4
30	37	460v	#8	#6	#4	#2
40	48	460v	#8	#6	#4	#2
50	62	460v	#4	#4	#2	#0



Extension Cord Size Recommendations

1 Phase Motor

TOOL HP	AMPS	VOLTAGE	>50'	50' - 100'	100' - 150'	150' - 200'
1/3 - 1/4	7	125v	#18	#18	#16	#14
1/2	10	125v	#18	#16	#14	#12
3/4	13	125v	#16	#14	#12	#10
1	15	125v	#14	#12	#10	#8
1-1/2	20	125v	#12	#10	#8	#6
1-1/2	13	115v	#12	#10	#8	#6
1-1/2	6	230v	#14	#14	#12	#10
2	30	125v	#8	#6	#4	#2
2-1/2	21	115v	#10	#8	#6	#4
2-1/2	11	230v	#14	#12	#10	#8
5	23	230v	#10	#8	#6	#4
7-1/2	33	230v	#8	#8	#6	#4

technical expertise WITH BREAKTHROUGH TECHNOLOGIES



Infiltrated High-Density (iHD) technology achieves high uniform density across each whole segment without applying high pressure like the standard segment process. It processes a robust segments that wear evenly, remain intact, and perform faster at higher cutting speeds.



The Norton Clipper CP500 High-Speed Cut-Off Saw. The patented **iLube**® option automatically controls mixing of oil and fuel for maximum efficiency. An electronic sensor will indicate a low oil level and adjust the engine to idle to prevent engine damage.



Norton Universal Arbor design allows a blade to be adaptable to two different arbor mounts. A knock-out bushing design creates flexibility to use one blade on two machines.



The steel core design of **Norton Clipper Silencio** provides an unprecedented noise-dampening effect on the job site of up to 15dB for 30 times less noise. The revolutionary design drastically reduces the high-pitched whistling effect on masonry and floor saws which is ideal for areas with local regulations sensitive to noise.



In the early 80's, Norton revolutionized the diamond blade market by developing the process of **laser welding** diamond segments to the steel center. This allowed, for the first time, laser-welded diamond products to cut dry on a very wide range of masonry and construction materials while returning exceptional speed of cut and long life when compared with conventional abrasive blades.



The unique laser-welded gullets, split segment design of the **Norton Clipper DUO**, and ellipsoidal shaped gullets of the **Norton Clipper 4X4, 4X4 MaxCut and 3X3** substantially increase product safety, provide smooth cuts, and help remove debris from the cutting area. Both patented gullets increase cutting speed and life of the blade.



Norton Clipper C1318P Small Push Saw has been redesigned with the operator in mind while maintaining robustness and functionality synonymous with the Clipper name. **Anti-Vibe Handlebars** reduce hand/arm vibration up to 40%.

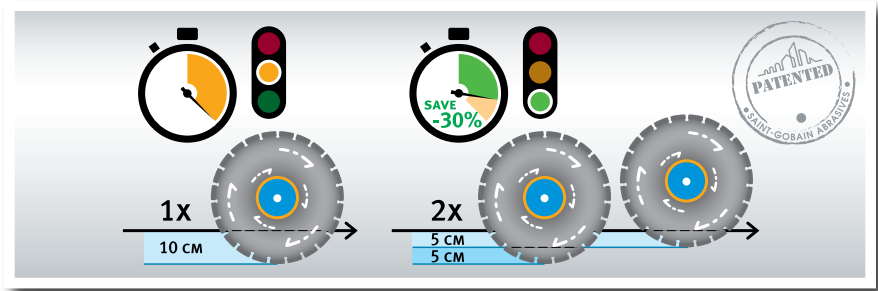

Norton depth cut indicators easily controls the operator's depth of cut for elimination of over-cutting, resulting in improved job performance. The steel center is permanently marked with patented slots that combine the direction of rotation and depth indicators. As the blade revolves, the depth of cut can be seen through the stroboscopic effect.

Come see Norton Clipper products up close and in person by visiting our booths at our annual trade shows. This experience cannot be replaced by a phone call, website, brochure or catalog.



WORLD OF CONCRETE

World of Concrete is the commercial construction industry's largest annual international event for concrete and masonry professionals. The trade show attracts approximately 1,500 exhibiting companies of original equipment manufacturers from around the world and exclusive U.S. distributors of equipment, tools, products and services for the commercial construction, concrete and masonry industries. WOC occupies more than 700,000 square feet of indoor and outdoor exhibit space.



The ARA Show is the American Rental Association's annual convention and trade show for the equipment and event rental industry. It features equipment for construction/industrial, general tool/light construction and party/special event rental segments. More than 700 exhibitors attend each year to network with peers and offer exclusive show-only specials.



STAFDA (Specialty Tools and Fasteners Distributors Association) represents over 2,500 members from the construction/industrial supply chain industries who make STAFDA their number one source for business networking, education, and strength to advance the industry.



The Canadian Concrete Expo is the only national trade show in Canada dedicated to the Concrete Construction and Aggregate industries. The show hosts over 350 exhibitors and over 6000 attendees, filling 300,000 sq.ft. of space.



NORTON
SAINT-GOBAIN

clipper®

REDEFINING
JOBSITE MUSCLE™

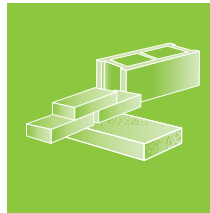

General Purpose and Masonry Building Materials

Blocks, medium-hard building bricks, paving slabs, concrete roof tiles and other medium hard materials.

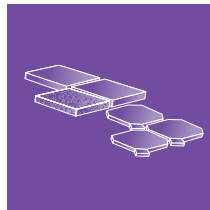

Natural Stone and Tiles

Ceramic and stone tiles, granite, marble, very hard bricks and other very hard and dense materials.



Rescue, Demolition

Ductile, steel, polyvinyl pipe, thin steel plate, acrylic sheet, fiberglass, rubber, standard glass, wood, concrete, brick, asphalt.

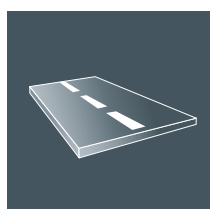

Asphalt and Abrasive Materials

Asphalt, green concrete, asphalt over concrete, abrasive blocks, mortar and other abrasive materials.

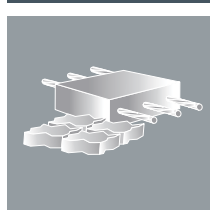

Reinforced Concrete and Harder Building Materials

Reinforced concrete, hard bricks, limestone, terrazzo and other hard materials.



All Materials
Ductile Iron Pipe

Concrete, reinforced concrete, asphalt over concrete, granite, building materials, thin steel sections, ductile iron pipes, angle iron up to 1/2" material thickness, rebar up to no. 5.



Steel & Stainless

General-purpose ferrous metals (steel, iron, welds), stainless steel and other high-strength alloys.



Reshaping
your
world.



























CATALOG #330

REFINISHING PRODUCTS FOR THE
AUTOMOTIVE
AFTERMARKET



QUALITY THAT PAYS™



	SANDING BLAZE A995	4		SURFACE CONDITIONING	24		MASKING PRODUCTS	49
	SANDING DRY ICE A975	5		GRINDING DISCS	25		ACCESSORIES	53
	SANDING A275 ORIGINAL PERFORMANCE	7		FILE BELTS	29		REVIVE BY RSG	61
	SANDING GOLD RESERVE	10		CUT-OFF WHEELS	30		AMERICAN TAPE	65
	SANDING BLUEFIRE	12		RETAIL PACKAGED	31		FUSOR	67
	SANDING BLACK ICE	14		TOOLS	33		MOTHERS	80
	SANDING PB273	15		SPEEDGRIP	36		SOLARGARD	83
	DEFECT REMOVAL	16		ADHESIVES, SEALERS, AND COATINGS	45		TIM – TOTAL INVENTORY MANAGEMENT	84
	SCUFFING SOLUTIONS	20						



RSGTM

Refinish Solutions Group



Your Productivity Partner

A select group of industry leaders has come together to leverage their core expertise into one powerful network to assist you in improving your refinishing process and increasing your profitability.



Ultimate strength | Continually sharper edges | Maximum dust extraction





FEATURES & BENEFITS

- Ultra-premium ceramic grain boosts performance with extremely sharp edges
- All-new exclusive backing provides extraordinary strength with tear resistance
- Norton No-Fil water-based stearate coating ensures you get a superior finish
- Norton A995 Blaze removes over 30% more material with considerably less dust



NORGRIP DISCS - BLANK AND MULTI-AIR CYCLONIC

Norton A995 Blaze starts with the finest design essentials of ultra-premium ceramic grain, proprietary high-strength backing and prevailing anti-clog coating. Then, we add some serious muscle with our most-advanced vacuum science to deliver the ultimate powerhouse of paper discs.



			
	6"	5" MULTI-AIR CYCLONIC	6" MULTI-AIR CYCLONIC
GRIT	PART #	PART #	PART #
P220-D	636425 97514	636425 97504	636425 97509
P180-D	636425 97513	636425 97503	636425 97508
P150-D	636425 97512	636425 97502	636425 97507
P120-D	636425 97511	636425 97501	636425 97506
P80-D	636425 97510	636425 97500	636425 97505
P40-D*			636425 97515*
Pkg/Case	50/4	50/4	50/4

**P40-D is packaged 25/4 (25 discs on a roll, 4 rolls per case)*



NORGRIP SHEET ROLLS

The innovative laser-converted rolls feature the same Cyclonic spiral hole-design found on the Multi-Air Cyclonic disc range which optimizes dust extraction while reducing surface imperfections. Another benefit of the new hole-design is that it does not need to be lined up with the holes on the vacuum file boards or vacuum hand blocks to achieve optimal performance so changeover is fast and easy. In addition the rolls are perforated every 2-3/4" to allow it to be torn easily to fit multiple file board lengths.

		
	2-3/4" x 13 YD PERFORATED ROLL	2-3/4" x 9 YD PERFORATED ROLL
GRIT	PART #	PART #
P220D	699573 08903	
P180D	699573 08902	
P150D	699573 08901	
P120D	699573 08900	
P80D	699573 08899	
P40D		699573 65500
Pkg/Case	1/4	1/4



SG ceramic grain

Unique fiber reinforced latex/paper backing

Superior cut on scratch-resistant clears and hard-to-sand primers

FEATURES & BENEFITS

- Norton SG ceramic grain has a quicker/cooler cut with better longevity and superior cut on scratch-resistant clears and hard-to-sand primers
- Unique fibre-reinforced latex/paper backing is flexible with increase durability for easy removal with maximum tear resistance
- Water-based stearate (No-Fil) improves load resistance and extends life



NORGRIP DISCS - BLANK AND MULTI-AIR CYCLONIC

Norton Dry Ice A975 NorGrip hook and loop discs with Norton SG ceramic grain are ideal for hard-to-sand and self-healing clears. Norton Multi-Air Cyclonic discs provide maximum dust extraction. Norton Dry Ice A975 also works well on composite material, aluminum, and other difficult-to-sand surfaces.



GRIT	DISCS			MULTI-AIR CYCLONIC		
	3"	5"	6"	3" MULTI-AIR CYCLONIC	5" MULTI-AIR CYCLONIC	6" MULTI-AIR CYCLONIC
	PART #	PART #	PART #	PART #	PART #	PART #
P1500B	636425 06002	666233 73555*	636425 06377	—	—	—
P1200B	—	666233 73554*	636425 06376	—	—	—
P1000B	—	666233 73553*	636425 06375	776960 95016	776960 07795	776960 07788
P800B	—	662544 80232	636425 06204	776960 95015	776960 07793	776960 07787
P600B	—	666233 05616	636425 06203	776960 95014	776960 07791	776960 07786
P500B	—	662544 80233	636425 06202	776960 95013	776960 07768	776960 07785
P400B	—	662611 49537	662611 49542	776960 95012	776960 07765	776960 07784
P320B	—	662611 49538	662611 49543	776960 95011	776960 07763	776960 07781
P280B	—	—	662611 49544	—	776960 07762	776960 07778
P240B	—	662611 49540	662611 49545	776960 95010	776960 07760	776960 07777
P220B	—	662611 49541	662611 49546	776960 95009	776960 07757	776960 07776
P180B	—	662611 40518	662611 40528	776960 95008	776960 07756	776960 07775
P150B	—	662611 40519	662611 40529	776960 95007	776960 07755	776960 07774
P120C	—	662611 40520	662611 40530	776960 95006	776960 07753	776960 07773
P100C	—	662611 40521	662611 40531	—	—	—
P80C	—	662611 40522	662611 40532	776960 95005	776960 07745	776960 07770
Pkg/Case	50/4	50/4	50/4	50/4	50/4	50/4

* Non-Stock Item



NORTON DRY ICE A975 CERAMIC



PSA DISC ROLLS

Norton Dry Ice A975 PSA (pressure sensitive adhesive) link disc rolls with patented Norton SG ceramic grain are the perfect solution for hard-to-sand and self-healing clears. Norton Dry Ice A975 also works well on composite material, aluminum, and other difficult-to-sand surfaces.

GRIT	5"		6"	
	PART #	PART #	PART #	PART #
P800B	662544 80230	636425 06200		
P600B	666233 05608	636425 06199		
P500B	662544 80231	636425 06198		
P400B	662611 55377	662611 55373		
P320B	662611 55378	662611 55374		
P280B	662611 55379	-		
P240B	662611 55380	662611 55376		
P220B	662611 42474	662611 48340		
P180B	662611 40498	662611 40508		
P150B	662611 40499	662611 40509		
P120C	662611 40500	662611 40510		
P100C	662611 40501	662611 40511		
P80C	662611 40502	662611 40512		
Pkg/Case	100/4	100/4		



NORGRIP SHEET ROLLS

Perforated every 2-3/4", the Norton Dry Ice A975 NorGrip continuous rolls minimize excess waste for board file papers while offering the benefits of a hook and loop system that can be re-used multiple times.

GRIT	2-3/4" x 13 YDS		2-3/4" x 13 YDS MULTI-AIR	
	PART #	PART #	PART #	PART #
P600B	666233 29548	636425 06124		
P500B	666233 29547	636425 06123		
P400B	666233 29518	636425 06122		
P320B	636425 06255	636425 06121		
P240B	-	636425 06120		
P220B	636425 06256	636425 06119		
P180B	636425 06257	636425 06118		
P150B	636425 06258	636425 06117		
P120C	636425 06259	636425 06114		
P80C	636425 06261	636425 06113		
Pkg/Case	1/4			



PSA SHEET ROLLS

Stick and Sand Sheet Rolls are PSA backed, so you can peel them off easily and stick them on at any length, quickly.

GRIT	2-3/4" x 45 YDS		2-3/4" x 30 YDS		2-3/4" x 25 YDS	
	PART #	PART #	PART #	PART #	PART #	PART #
P400B	662611 49557	-	-	-	-	-
P320B	662611 49558	-	-	-	-	-
P220B	662611 49561	-	-	-	-	-
P180B	662611 49562	-	-	-	-	-
P150B	662611 49563	-	-	-	-	-
P120C	-	662611 49564	-	-	-	-
P80C	-	-	662611 49566	-	-	-
Pkg/Case	1/5	1/5	1/5			

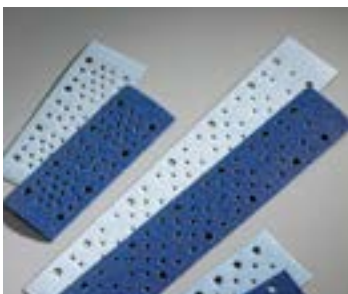

BODY FILE SHEETS

A975 ceramic grain on a reinforced backing with hook and loop attachment to reduce heat so that the paper lasts extra long. Ideal for sanding body filler. Revolutionary design for maximum vacuum assist virtually eliminates clogging.

GRIT	SPEC	2-3/4" x 16-1/2"		2-3/4" x 8"		2-3/4" x 5"	
		PART #	PART #	PART #	PART #	PART #	PART #
P180B	A975	699573 94466	699573 94474	699573 94459			
P120C	A975	699573 94464	699573 94472	699573 94457			
P80C	A975	699573 94463	699573 94470	699573 94456			
Pkg/Case		50/4	50/4	50/4			



NORTON MULTI-AIR HAND BLOCKS

The ergonomic dust free hand blocks are easy to hold and move in any position. Each block comes with a regulator adapter to control air flow and a reducer to connect to a standard vacuum hose line.

GRIT	2-3/4" x 16-1/2"		2-3/4" x 8"		2-3/4" x 5"	
	PART #	PART #	PART #	PART #	PART #	PART #
	699573 96648	699573 96646	699573 96645			
Case	1	1	1			



Premium heat-treated grain

B-weight fiber reinforced latex/paper backing

Anti-loading



FEATURES & BENEFITS

- Premium heat-treated grain has a 30% – 50% faster cut rate and extends life
- Premium B-weight latex fiber reinforced paper backing is more flexible, tear resistant and allows for easy disc removal
- Superior bond system optimizes grain adhesion and extends cut life
- Water-based stearate No-Fil improves load resistance



NORGRIP VACUUM AND MULTI-AIR CYCLONIC DISCS

NorGrip hook and loop fastening system provides cooler cutting action and a finer finish.

	 5" VACUUM	 6" VACUUM	 6" MULTI-AIR CYCLONIC
GRIT	PART #	PART #	PART #
P1500B	–	662611 31584	–
P1200B	–	662611 31585	–
P1000B	–	–	666233 90514
P800B	–	–	666233 90513
P600B	662611 31571	–	666233 90512
P500B	–	–	666233 90511
P400B	662611 31573	–	666233 90510
P320B	662611 31575	–	666233 90509
P240B	662611 31577	–	666233 90508
P220B	662611 31578	–	666233 90507
P180B	662611 31579	–	666233 90506
P150B	662611 31580	–	666233 90505
P120B	662611 31581	–	666233 90504
P100B	662611 31582	662611 31599	–
P80B	662611 31583	–	666233 90503
<i>Pkg/Case</i>	<i>50/4</i>	<i>100/4</i>	<i>100/4</i>



NORGRIP SHEET ROLLS

The innovative laser-converted rolls feature the same Cyclonic spiral hole-design found on the Multi-Air Cyclonic disc range which optimizes dust extraction while reducing surface imperfections. Another benefit of the new hole-design is that it does not need to be lined up with the holes on the vacuum file boards or vacuum hand blocks to achieve optimal performance so changeover is fast and easy. In addition the rolls are perforated every 2-3/4" to allow it to be torn easily to fit multiple file board lengths.





	 2-3/4" x 13YDS PERFORATED ROLL
GRIT	PART #
P400B	666233 90517
P320B	666233 90518
P220B	666233 90519
P180B	666233 90520
P150B	666233 90521
P120B	666233 90522
P80B	666233 90523
<i>Pkg/Case</i>	<i>1/4</i>

NORTON A275 OP ALUMINUM OXIDE

NORGRIP BLANK DISCS

NorGrip hook and loop fastening system provides cooler cutting action and a finer finish.









				
	3"	5"	6"	8"
GRIT	PART #	PART #	PART #	PART #
P1500B	662611 47434	662611 31533	662611 31550	—
P1200B	—	662611 31534	662611 31551	—
P1000B	662611 35900	662611 31535	662611 31552	—
P800B	662611 31519	662611 31536	662611 31553	—
P600B	662611 36996	662611 31537	662611 31554	—
P500B	662611 31521	662611 31538	662611 31555	—
P400B	662611 36995	662611 31539	662611 31556	—
P320B	662611 31524	662611 31541	662611 31558	—
P280B	—	—	662611 31559	—
P240B	662611 31526	662611 31543	662611 31560	—
P220B	662611 31527	662611 31544	662611 31561	—
P180B	662611 31528	662611 31545	662611 31562	662611 31661
P150B	662611 40385	662611 31546	662611 31563	—
P120B	662611 28688	662611 31547	662611 31564	662611 31662
P100B	662611 44926	662611 31548	662611 31565	662611 31663
P80B	662611 31532	662611 31549	662611 31566	662611 31664
Pkg/Case	50/4	100/4	100/4	100/4

PSA DISCS

Can be used dry on all automotive finishes to save time and money and increase productivity.



							
	5" TAB DISC	6" TAB DISC	5" DISC ROLL	6" DISC ROLL	8" DISC ROLL	5" VAC DISC ROLL	6" VAC DISC ROLL
GRIT	PART #	PART #	PART #	PART #	PART #	PART #	PART #
P1500B	662611 31448*	662611 31465	—	—	—	—	—
P1200B	662611 31449	662611 31466	—	—	—	—	—
P1000B	662611 31450	662611 31467	—	—	—	—	—
P800B	—	—	662611 31451	662611 31468	—	—	—
P600B	—	—	662611 31452	662611 31469	—	—	662611 31503
P500B	—	—	662611 31453	662611 31470	—	662611 31487	—
P400B	—	—	662611 31454	662611 31471	—	662611 31488	662611 31505
P320B	—	—	662611 31456	662611 31473	662611 31609	662611 31490	662611 31507
P280B	—	—	662611 31457	662611 31474	—	—	662611 31508
P240B	—	—	662611 31458	662611 31475	—	662611 31492	662611 31509
P220B	—	—	662611 31459	662611 31476	662611 31612	662611 31493	662611 31510
P180B	—	—	662611 31460	662611 31477	662611 31613	662611 31494	662611 31511
P150B	—	—	662611 31461	662611 31478	662611 31614	662611 31495	662611 31512
P120B	—	—	662611 31462	662611 31479	662611 31615	662611 31496	662611 31513
P100B	—	—	662611 31463	662611 31480	—	662611 31497	662611 31514
P80B	—	—	662611 31464	662611 31481	662611 31617	662611 31498	662611 31515
Pkg/Case	100/4	100/4	100/6	100/6	100/4	100/6	100/6

* Non-Stock Item



NORTON A275 OP ALUMINUM OXIDE

PSA SHEET ROLLS

Stick and Sand Sheet Rolls are PSA backed, so you can peel them off easily and stick them on at any length, quickly. Use on hand sanding blocks, file shoes, or file boards. Fits sheet roll dispenser #63642542773.

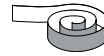

2-3/4" x 45 YDS

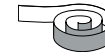

2-3/4" x 30 YDS

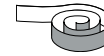

2-3/4" x 25 YDS

GRIT	PART #	PART #	PART #
P600B	66261 131679	—	—
P400B	66261 131681	—	—
P320B	66261 131683	—	—
P240B	66261 131685	—	—
P220B	66261 131686	—	—
P180B	66261 131687	—	—
P150B	66261 131688	—	—
P120B	—	66261 131689	—
P100B	—	66261 131690	—
P80B	—	—	66261 131691
<i>Pkg/Case</i>	<i>1/5</i>	<i>1/5</i>	<i>1/5</i>

BODY FILE SHEETS

These body file sheets are a popular choice for dry sanding paint, primer, and primer surfacer; also for deburring, removing sand scratches, shaping and finishing plastic filler, and feather-edging repaired areas.



CLIP-ON
2-3/4" x 17-1/2"

PSA
2-3/4" x 16-1/2"

NORGRIP
2-3/4" x 16-1/2"

NORGRIP
2-3/4" x 16" VAC

GRIT	PART #	PART #	PART #	PART #
P400B	—	—	66261 133296	—
P320B	—	—	66261 152692	—
P220B	66261 131647	66261 131635	66261 131641	—
P180B	66261 131648	66261 131636	66261 131642	66261 131654
P150B	66261 131649	66261 131637	66261 131643	—
P120B	66261 131650	66261 131638	66261 131644	66261 131656
P100B	66261 131651	66261 131639	66261 131645	66261 131657
P80B	66261 131652	66261 131640	66261 131646	—
<i>Pkg/Case</i>	<i>50/10</i>	<i>50/10</i>	<i>50/10</i>	<i>50/10</i>

9" x 11" SHEETS

For dry sanding old paint, primer, primer surfacer, and between-color coats; also for deburring, removing sand scratches, shaping and finishing plastic filler, and feather-edging repaired areas. Special No-Fil coating prevents premature loading.



9" x 11"

GRIT	PART #
P1500B	66261 131618
P1200B	66261 131619
P1000B	66261 131620
P800B	66261 131621
P600B	66261 131622
P500B	66261 131623
P400B	66261 131624
P320B	66261 131626
P280B	66261 131627
P240B	66261 131628
P220B	66261 131629
P180B	66261 131630
P150B	66261 131631
P120B	66261 131632
P100B	66261 131633
P80B	66261 131634
<i>Pkg/Case</i>	<i>100/5</i>
<i>+Pkg/Case</i>	<i>50/5</i>

NORTON GOLD RESERVE ALO

Aluminum oxide grain | Strong paper backing | Anti-loading



FEATURES & BENEFITS

- "P" graded premium A/O grain produces a quick, cool cut with a more consistent scratch pattern
- Strong paper backing is conformable and flexible and resists tearing and loading
- Water-based, non-loading stearate increases productivity

PSA DISCS, DISC ROLLS AND NORGRIP DISCS

Norton Gold Reserve is a versatile abrasive product that cuts fast, lasts long, and resists loading.



GRIT	6" PSA TAB DISC		5" PSA DISC ROLL		6" PSA DISC ROLL		6" NORGRIP		6" VAC NORGRIP	
	PART #	PART #	PART #	PART #	PART #	PART #	PART #	PART #	PART #	PART #
P800B	—	—	636425 06164	—	636425 06226	666233 34797	—	—	—	—
P600B	—	—	662610 40261	—	636425 06227	666233 34796	—	—	—	—
P500B	—	—	636425 06165	—	636425 06228	666233 34795	—	—	—	—
P400B	662611 83832	662611 83814	662611 83823	636425 06176	636425 06229	666233 34794	—	—	—	—
P320B	662611 83831	662611 83813	662611 83822	636425 06177	636425 06230	666233 34793	—	—	—	—
P240B	662611 83830	662611 83812	662611 83821	—	636425 06225	—	—	—	—	—
P220B	662611 83829	662611 83811	662611 83820	636425 06178	636425 06231	666233 34791	—	—	—	—
P180B	662611 83828	662611 83810	662611 83819	636425 06179	636425 06232	666233 34790	—	—	—	—
P150B	662611 83827	662611 83809	662611 83818	—	636425 06233	—	—	—	—	—
P120B	662611 83826	662611 83808	662611 83817	—	636425 06234	666233 34788	—	—	—	—
P100B	662611 83825	662611 83807	662611 83816	—	636425 06235	666233 34787	—	—	—	—
P80B	662611 83824	662611 83806	662611 83815	636425 06182	636425 06236	666233 34786	—	—	—	—
Pkg/Case	100/4	100/4	100/4	25/6	50/4	50/4	—	—	—	—

PSA SHEET ROLLS

Stick and Sand Sheet Rolls are PSA backed, so you can peel them off easily and stick them on at any length, quickly.







GRIT	2-3/4" x 25 YDS		2-3/4" x 20 YDS	
	PART #	PART #	PART #	PART #
P400B	636425 06147	—	—	—
P320B	636425 06148	—	—	—
P220B	636425 06149	—	—	—
P180B	636425 06150	—	—	—
P150B	636425 06151	—	—	—
P120B	636425 06152	—	—	—
P80B	636425 06153	—	—	—
P80C	—	662611 60325	—	—
Pkg/Case	1/5	1/5	—	—

NORTON GOLD RESERVE ALO



PSA AND NORGRIP DISCS

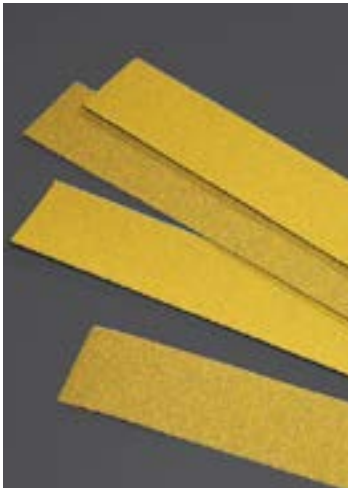

Norton Gold Reserve tough E-weight backing resists tearing and extends disc life. Ideal for sanding body filler.

					
	6" PSA	8" PSA	6" NORGRIP	8" NORGRIP	6" VAC NORGRIP
GRIT	PART #	PART #	PART #	PART #	PART #
P80E	636425 06217	636425 06220	666233 34800	666233 34802	—
P40E	636425 06216	636425 06219	666233 34801	666233 34803	666233 34785
P36E	636425 06215	636425 06218	—	—	—
Pkg/Case	25/5	25/5	25/4	25/4	25/5



BODY FILE SHEETS

Norton Gold Reserve body file sheets are perfect for sanding body filler without loading.

			
	PSA 2-3/4" x 16-1/2"	NORGRIP 2-3/4" x 16-1/2"	NORGRIP 2-3/4" x 16-1/2"
GRIT	PART #	PART #	PART #
P220B	—	636425 06242	—
P180B	—	636425 06241	—
P150B	—	636425 06240	—
P120B	—	636425 06239	—
P100B	—	636425 06238	—
P80B	—	636425 06237	—
P80E	636425 06196	—	666233 34804
P40E	636425 06195	—	666233 34805
P36E	636425 06194	—	—
Pkg/Case	25/5	25/5	25/5



Premium heat-treated grain

E-weight fiber reinforced latex/paper backing

Anti-loading

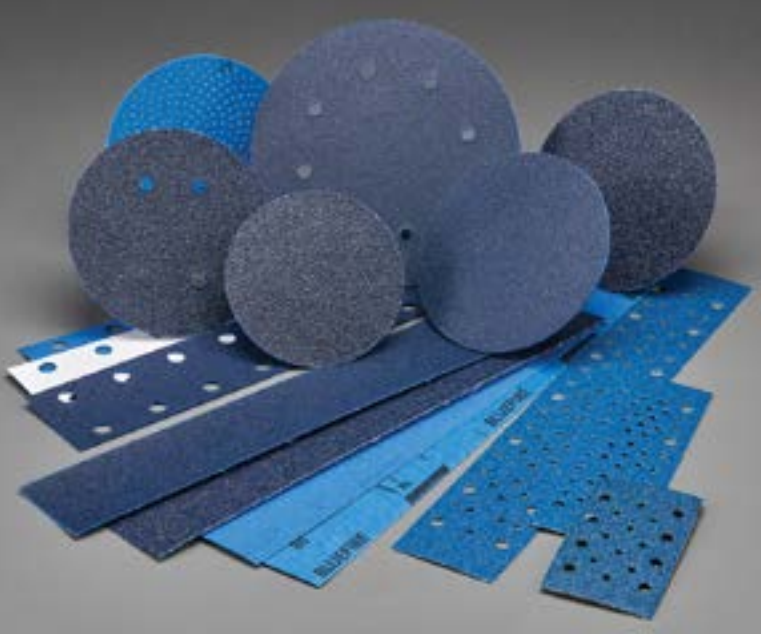

FEATURES & BENEFITS

- High-strength blue latex/paper backing improves performance and flexibility and reduces curling and edge chipping.
- NorZon zirconia alumina grain is self-sharpening, minimizes heat and improves cut rate.
- Superior bond system optimizes grain adhesion for extended product life.

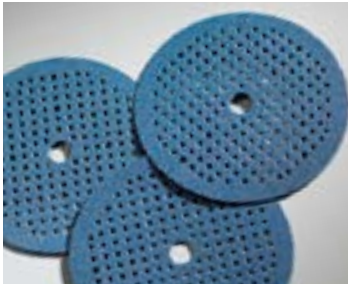

NORGRIP DISCS - NORTON MULTI-AIR

Norton BlueFire hook and loop NorGrip discs last long and cut quickly, using premium zirconia grain which microfractures to remain sharp and fast cutting. Revolutionary design for maximum vacuum assist virtually eliminates clogging for a cleaner work environment with less dust and contamination



GRIT

P80E

Pkg/Case



6" MULTI-AIR

PART #

662611**181412**

50/4



NORGRIP DISCS

Norton BlueFire hook and loop NorGrip discs last long and cut quickly, using premium zirconia grain which microfractures to remain sharp and fast cutting.



5"



6"



8"



8" VAC

GRIT

80E

40E

36E

Pkg/Case

PART #

662611**125444**

662611**125684**

–

25/4

PART #

662611**123588**

662611**123589**

662611**123590**

25/4

PART #

662611**123591**

662611**123592**

662611**123593**

25/4

PART #

662611**123596**

–

662611**123598**

25/4



PSA DISCS

Norton BlueFire PSA discs are ideal for sanding body filler. NorZon grain micro-fractures to improve cut rate, minimize loading, and reduce heat.



5"



6"



8"



6" VAC



8" VAC

GRIT

80E

40E

36E

Pkg/Case

PART #

662611**125244**

662611**125307**

662611**125436**

50/4

PART #

662611**123573**

662611**123574**

662611**123575**

50/4

PART #

662611**123576**

662611**123577**

662611**123578**

25/4

PART #

–

662611**123580**

–

50/4

PART #

662611**123582**

–

662611**123584**

25/4

NORTON BLUEFIRE ZIRCONIA

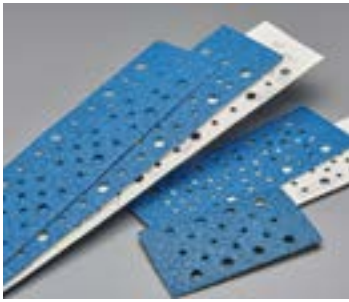

NORTON MULTI-AIR BODY FILE SHEETS

Norton BlueFire H835 Zirconia grain on a reinforced backing with hook and loop attachment which reduces heat so that the paper lasts extra long. Ideal for sanding body filler. Revolutionary design for maximum vacuum assist virtually eliminates clogging for a cleaner work environment with less dust and contamination. Cutting surface remains clean offering a consistent cut throughout the life of the body file sheet with no clogging or loading

	2-3/4" x 16-1/2"	2-3/4" x 8"	2-3/4" x 5"
GRIT	PART #	PART #	PART #
P40E	699573 94450	699573 94363	699573 94449
Pkg/Case	50/4	50/4	50/4



NORTON MULTI-AIR HAND BLOCKS

The ergonomic dust free hand blocks are easy to hold and move in any position. Each block comes with a regulator adapter to control air flow and a reducer to connect to a standard vacuum hose line.

	2-3/4" x 16-1/2"	2-3/4" x 8"	2-3/4" x 5"
	PART #	PART #	PART #
Case	1	1	1



NORGRIP, PSA, AND CLIP-ON BODY FILE SHEETS

Norton BlueFire Body File Sheets come in three different types: Clip-On, PSA, and NorGrip. Self-sharpening NorZon grain improves cut rate, minimizes loading, and reduces heat. Tough E-weight latex reinforced paper backing resists tearing.

Norton BlueFire is ideal for sanding body filler.

	CLIP-ON 2-3/4" x 17-1/2"	PSA 2-3/4" x 16-1/2"	PSA 2-3/4" x 16" VAC	NORGRIP 2-3/4" x 16-1/2"	NORGRIP 2-3/4" x 16" VAC
GRIT	PART #	PART #	PART #	PART #	PART #
180E	662611 26511	—	—	—	—
100E	662611 26512	662611 25595*	—	—	—
80E	662611 23620	662611 23608	662611 23611	662611 23614	662611 23617
40E	662611 23621	662611 23609	662611 23612*	662611 23615	662611 23618
36E	662611 23622	662611 23610	662611 23613*	662611 23616	662611 23619*
Pkg/Case	50/5	50/5	50/5	25/5	25/5
*Pkg/Case		50/10			

* Non-Stock Item





Premium abrasive grain

Flexible, specially-treated backing

Consistent finish is easy to buff

FEATURES & BENEFITS

- Specially treated waterproof paper does not require soaking, is curl resistant and will not deteriorate
- Premium abrasive grain last long and cuts fast.
- Ultra flexible backing resists cracking, tearing and wrinkles
- Advanced coating process for a consistent scratch pattern that buffs out faster



SHEETS AND DISCS

Norton Black Ice works great wet or dry and gives the same cut no matter how you use it. If you prefer the paper to be wet, just a spritz of water is all that's needed. Or, if you like to soak your paper, go ahead because Norton Black Ice has curl resistance built right in so it stays flat and Norton Black Ice will not deteriorate, no matter how long you leave it in water.

GRIT	3" NORGRIP DISC PART #	5-1/2" x 9" PART #	9" x 11" PART #
2500B	662611 47432	662611 39369	662611 39377
2000B	662611 47433	662611 39370	662611 39378
1500B	—	662611 39371	662611 39379
1200B	—	662611 39372	662611 39380
1000B	—	662611 39373	662611 39381
P800B	—	662611 39374	662611 39382
P600B	—	662611 39375	662611 39383
P500B	—	—	662611 39384
P400B	—	—	662611 39385
P320B	—	—	662611 39386
P240B	—	—	662611 39388
P220B	—	—	662611 39389
Pkg/Case	50/4	50/5	50/5



Aluminum oxide grain | Paper backing | Anti-loading



FEATURES & BENEFITS

- "P" graded A/O grain produces a quick cut with a consistent scratch pattern
- Paper backing is conformable and flexible
- Water-based, non-loading stearate resists loading



9" x 11" SHEETS MERIT PB273

For dry sanding old paint, primer, primer surfacer, and between-color coats; also for deburring, removing sand scratches, shaping and finishing plastic filler, and featheredging repaired areas. Special coating prevents premature loading.

GRIT	9" x 11" PART #
P400B	666233 11870
P320B	666233 11871
P240B	666233 11879
P220B	666233 11873
P180B	666233 11874
P150B	666233 11875
P120B	666233 11876
P100B	666233 11877
P80B	666233 11878
<i>Pkg/Case</i>	<i>100/5</i>
<i>*Pkg/Case</i>	<i>50/5</i>



Defect removal

Premium aluminum
oxide grain



Smooth film backing

FEATURES & BENEFITS

- Smooth film backing for a consistent finish that buffs out easily and quickly
- Premium aluminum oxide grain cuts fast and lasts longer
- Anti-loading agent produces a uniform finish that buffs out faster and eliminates pigtails and costly re-work





NORTON PURE ICE Q175 NORGRIP FINE GRIT FILM FINISHING DISCS

GRIT	COLOR	 	
		3"	6"
P1500	Blue	776960 88704	776960 88716
P1200	Green	776960 88703	776960 88715
P1000	Red	776960 88702	776960 88714
P800	Black	776960 88701	776960 88713
<i>Pkg/Case</i>		<i>50/4</i>	<i>50/4</i>



NORTON Q275 NORGRIP FINE GRIT FILM FINISHING DISCS

GRIT	 	
	3"	6"
P1500	662611 01600	662611 01615
P1200	662611 01601	662611 01616
P1000	662611 01602	662611 01617
P800	662611 01603	662611 01618
<i>Pkg/Case</i>	<i>50/4</i>	<i>50/4</i>



Scratch refinement

Foam backing

Bufs out easily

FEATURES & BENEFITS

- Integrated foam backing is conformable to contours and eliminate pigtails and costly re-work
- Open mesh design for a uniform scratch pattern and allowing equal pressure distribution for quicker sanding
- Produces a semi-polished finish that is quick and easy to buff out



NORTON ICE NORGRIP FINISHING FOAM DISCS

Norton Ice Finishing Foam discs, used moist, will produce a semi-polished surface which greatly reduces buffing time.

GRIT	COLOR	3"		6"	
		PART #	PART #	PART #	PART #
3000	Green	636425 06020	636425 06013	—	—
2000	Magenta	636425 06021	636425 06014	—	—
1500	Blue	636425 06022	636425 06015	—	—
Back-Up Pad	—	—	—	636425 06128	636425 06130
Pkg/Case		6/4	15/4	10/1	5/1



Water soluble

Easy clean up

No cross contamination

FEATURES & BENEFITS

- Water soluble formula is VOC compliant and very easy to clean up
- 1 polish, 3 pads is a simple system in which the polish matches the cut of the pad for optimal performance that reduces inventory
- Premium micro-fine abrasives remove swirl marks, haze, and sand scratches quickly



NORTON LIQUID ICE EXTRA-CUT

Water soluble Norton Liquid Ice Extra-Cut is easy to use and easy to clean up. Norton Liquid Ice Extra-Cut is engineered to be used with a selection of 3 pads, depending on the finish required.

DESCRIPTION	PART #	PKG/CASE
Quart	636425 97116	1/4
Gallon	636425 06078	1/2



NORTON LIQUID ICE ULTRA-FINE MACHINE GLAZE

Use on its own for fine scratch removal or as Step 3 in place of Norton Liquid Ice Extra-Cut to eliminate swirl marks and produce a high gloss finish. Ideal for dark colored vehicles.

DESCRIPTION	PART #	PKG/CASE
Quart	636425 06092	1/4



CLEAN-UP/ DETAILER SPRAY

The spray detailer easily cleans up excess buffing residue and provides paint protection. Just spray it on and wipe it off with a Blue Magnet microfiber cloth.

DESCRIPTION	PART #	PKG/CASE
32 oz. Spray Bottle	636425 42082	1/4
Blue Magnet Microfiber Cloth	636425 04402	5/4



8" BUFFING/POLISHING WAFFLE PADS

These pads can be used with Norton Liquid Ice Extra-Cut following the step numbers or they can also be used with Mothers® compounds and polish.

DESCRIPTION	PART #	PKG/CASE
NorGrip Back-Up Pad (5/8"-11)	636425 42080	1/3
Orange Waffle – Step 1	636425 06379	1/6
Blue Waffle – Step 2	636425 06380	1/6
White Waffle – Step 3	636425 06381	1/6



BUFFING/POLISHING PADS

These pads can be used with Norton Liquid Ice Extra-Cut following the step numbers or they can also be used with Mothers® compounds and polish.

DESCRIPTION	PART #	PKG/CASE
NorGrip Back-Up Pad (5/8"-11)	636425 42080	1/3
Super Cut Wool Pad – Step 1	636425 42077	1/6
Blue Cutting Foam Pad – Step 2	636425 42078	1/6
White Finishing Foam Pad – Step 3	636425 42079	1/6



3" BUFFING/POLISHING PADS

For small spot repair areas, the 3" pads work just the same as the larger pads.

DESCRIPTION	PART #	PKG/CASE
3" NorGrip Back-Up Pad (5/16"-24")	636425 06128	10/1
3" Super Cut Wool Pad – Step 1	636425 43832	10/4
3" Blue Cutting Foam Pad – Step 2	636425 05459	10/4
3" White Finishing Foam Pad – Step 3	636425 05460	10/4



Consistent cut and no wild scratches

Perforated

Strong, yet flexible

FEATURES & BENEFITS

- Advanced resin formulation evenly coats the fibers allowing for a more consistent cut and added strength and resists tearing
- Consistent grain sizing produces a uniform scratch pattern with no wild scratches
- Consistent grain distribution throughout thickness for a consistent cut for full use of scuff pad and longer life
- Perforated for quick, easy pad re-sizing without jagged edge

Maroon (320/400)

- Quick and aggressive cut
- Tear-resistant

Gray (800/1000)

- Works with or without Scuff Gel
- Quick cut, uniform finish
- Incredibly flexible yet tear-resistant

Gold (1000/1200)

- Ideal for pearls and metallics
- Works with or without Scuff Gel



NORTON BEAR-TEX SCUFF PADS AND PERFORATED ROLLS

Bear-Tex pads offer a consistently graded grain in an advanced resin system which provides a super fast cut without wild scratches. Rolls are perforated every 3" and are packaged in a protective plastic wrap for easy dispensing.

DESCRIPTION	COLOR	6" x 9" PAD	6" x 9" PAD	4" x 30" ROLL
		PART #	PART #	PART #
Primer Prep	Maroon	662610 58000	—	636425 03009
Color Prep	Gray	662610 58002	—	636425 02999
Clear Blend Prep	Gold	—	662610 58005	—
Non-Abrasive	White	662610 58001	—	—
Pkg/Case		20/3	10/3	1/1



THIN-FLEX NORTON BEAR-TEX PADS, ROLLS, AND DISCS

Thin-Flex is a very flexible, yet strong product for use on contoured surfaces and for getting into tight spaces. It can be used for fine finishing and surface preparation. Rolls are perforated every 3". The recommended back-up pad for the discs is #06145.

DESCRIPTION	COLOR	4-1/2" x 9" PAD	6" DISC	4" x 30' ROLL PLASTIC WRAP	4" x 30' ROLL BOXED
		PART #	PART #	PART #	PART #
Primer Prep	Maroon	636425 06166	666233 34770	636425 03023	776960 75500
Color Prep	Gray	636425 06167	666233 34771	636425 03021	776960 75502
Clear Blend Prep	Gold	662611 13519 *	662611 13517 *	—	—
Pkg/Case		25/4	25/4	1/1	1/3
*Pkg/Case		(10/10)	(10/4)		



SCUFF GEL

Formulated for consistent abrasion for paint adhesion. Use with Norton Bear-Tex gray or gold pads. Cleans, de-greases and abrades in one step. Rinses off easily and completely. Water-based formula, very low in VOC

DESCRIPTION	SIZE	PART #
Scuff Gel	24.7 oz. - 700 grams	076607 05376
Pkg/Case		1/6



Uniform finish

Can be used moist or dry

Conformable
foam backing

FEATURES & BENEFITS

- Norton A275 on foam back backing cuts fast and is long-lasting without leaving finger marks when hand sanding primer
- Water resistant allows for the foam pads to be used moist
- Creates a uniform finish minimizing "difficult to cover" sand scratches that prove challenging for water-based paints

GRIT	APPLICATION
P320, P400	Feather-edge, scuff primer, scuff new parts before painting
P500, P600	Prepare panel for base coat
P800, P1000	Sand clear coat, remove minor defects



ROTOLO FOAM

Rotofoam pre-cut sheets, conveniently packaged in a roll form, are ideal for fine sanding on round edges, contours, and curves, providing an outstanding finish on primers and top coats. Perforated every 5-1/2".

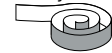

4-1/2" x 82'

GRIT	PART #
P320	636425 57606
P400	636425 57608
P500	636425 57611
P600	636425 57612
P800	636425 57613
P1000	636425 57616
<i>Pkg/Case</i>	<i>1/2</i>



FEATURES & BENEFITS

- Abrasive grain coated on a sponge backing allows for wet or dry sanding without leaving finger marks
- Grit is printed on the sponge for easy identification of the right product to use
- Highly conformable allowing for sanding on bumpers, jambs, and small parts as well as a perfect solution for contours and edges

GRIT DESIGNATION	FINISH GENERATED	APPLICATION
Medium	P180/P120	Scuff, shaping filler
Fine	P400/P320	Feather-edge, scuffing primer, scuffing new parts before painting
Super Fine	P600/P500	Preparing panel for base coat
Ultra Fine	P1000/P800	Sanding base coat, removing clear coat defects
Micro Fine	P1500/P1200	Clear coat sanding, removing minor defects

NORTON SOFTTOUCH SPONGES

The finishing action of sponges generates a finer finish than conventional coated abrasive products. The coarser grit is the finish achieved when sanding dry and the finer grit is the finish achieved when sanding wet.



4-1/2" x 5-1/2" x 3/16"

DESCRIPTION	PART #
Medium	076607 03074
Fine	076607 03075
Super Fine	076607 03076
Ultra Fine	076607 03077
Micro Fine	076607 03078
<i>Pkg/Case</i>	<i>20/4</i>

Extra-coarse ceramic
alumina grain

Tough synthetic fibers

Aggressive cut



FEATURES & BENEFITS

- Open web construction resists loading is effective on sharp, jagged surfaces and a great alternative to wire brushes
- Synthetic web impregnated with abrasive will not rust
- Thick and durable extending the product life



NORTON BLAZE RAPID STRIP TR+ DISC

Removes rust and paint from door jambs, seams, and difficult to reach areas. Rust free alternative to a wire brush. Rugged design provides long life and continuous cutting action.



	RPM	BACK-UP PAD	4" TR+
DESCRIPTION		PART #	PART #
Norton Blaze	8,000	—	666233 31054
Back-Up Pad	—	636425 55106	—
<i>Pkg/Case</i>		<i>1/1</i>	<i>5/1</i>



NORTON BLAZE RAPID STRIP DISC WITH MANDREL

Removes rust and paint from door jambs, seams and difficult to reach areas. Rust free alternative to a wire brush. Mandrel assembly will adapt discs for use on portable tools. The assembly consists of a mandrel, nut and two washers.



	RPM	MANDREL	4" x 1/4" HOLE
DESCRIPTION		PART #	PART #
Norton Blaze	6,000	—	662610 09324
Mandrel with 3-1/16 x 1/4" shank	—	662610 09502	—
<i>Pkg/Case</i>		<i>1/1</i>	<i>5/4</i>



NORTON BLAZE SPEED-LOK TR RAPID STRIP DISC

Great for removing rust, undercoating, seam-sealers, and stone guards. Use in truck beds, door jambs, and hard-to-reach areas like wheel wells and undercarriage. Use to remove oxidation from tire rims and to remove rust from brake assemblies.



	RPM	2" TR	3" TR
DESCRIPTION		PART #	PART #
Norton Blaze	15,000	666233 31051	—
Norton Blaze	12,000	—	666233 31053
Back-Up Pad	—	666233 55103	666233 55105
<i>Pkg/Case</i>		<i>10/1</i>	<i>10/1</i>

2" AND 3" RAPID BLEND GRINDING DISCS

Engineered abrasives

Grind in 3D

8X Life



FEATURES & BENEFITS

- Seeded Gel (SG) ceramic – Norton Blaze has a quicker cut rate and longer life compared to conventional abrasives
- Proprietary Norton Vortex aluminum oxide aggregate grain (Blue) performs the medium to fine grit steps of traditional discs in an easy one-step operation
- New construction: abrasive is distributed throughout the entire disc (top, bottom and side) so all three faces can be used and providing 3 - 8 times the life of competitive surface blending discs
- Special resin chemistry resists shedding when used on sharp edges, making it ideal for deburring and creates no smearing

NORTON BLAZE AND NORTON VORTEX RAPID BLEND DISCS

Ideal for removing surface rust, blending out grind marks, and removing coatings from automotive surfaces. Norton Blaze (orange) can also be used to remove seam sealer and undercoating without loading. Norton Vortex (blue) is great for removing gaskets and works very well on aluminum without loading or smearing. The discs are thin enough to get into tight spots but durable enough to last. Norton Blaze ceramic grain ensures a fast cut with long life. Norton Vortex grain cuts faster and finishes finer than conventional aluminum oxide abrasives. Both can be used on the face, side, and back. Use with a 1" back-up pad to allow use of the top surface of the disc and allow the disc to conform to contours.

DESCRIPTION

Blaze (Orange)
Vortex (Blue)
Case

2" TR

PART

666233**38632**
666233**34782**
10

3" TR

PART

666233**38633**
666233**34783**
10



TOP



BOTTOM



SIDE

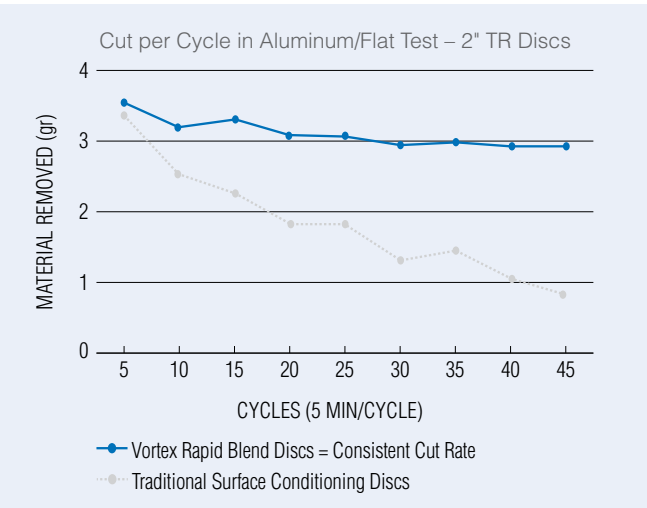

2" AND 3" RAPID PREP GRINDING DISCS

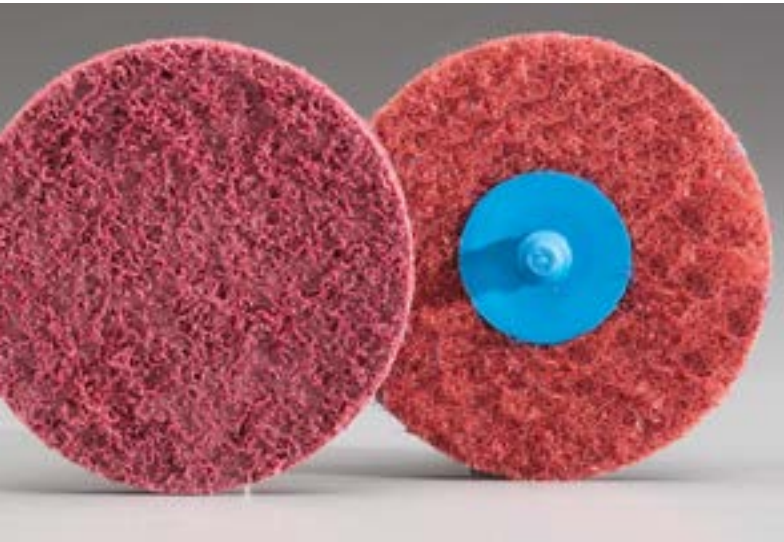

Cuts coarse/finishes fine | Lasts Longer | No smearing

FEATURES & BENEFITS

- Proprietary Norton Vortex aluminum oxide aggregate grain has a consistent cut and finish in addition to a fast cutting speed and finish of finer grits
- New grain coating method is more resistant to edge wear and lasts up to 4X longer than competitive products
- New resin system does not smear and will not load on aluminum and soft metals



NORTON BEAR-TEX VORTEX RAPID PREP DISCS

Norton Bear-Tex Vortex surface blending discs deliver superior, consistent finishes whenever you need to clean, de burr, blend, or finish. Ideal for removing rust and oxides, blending out disc marks, and removing coatings and gasket residues. Product color coding (by grit) makes work fast and easy.



2" TR VORTEX

PART #



3" TR VORTEX

PART #

GRIT	COLOR	2" TR VORTEX PART #	3" TR VORTEX PART #
Very Fine (320)	Blue	666233 90502	666233 35437
Medium (120)	Maroon	666233 90501	666233 35430
Coarse (80)	Brown	666233 90500	666233 35417
Case		25	25



NORTON BEAR-TEX SPEED-LOK TR RAPID PREP SURFACE BLENDING DISCS

Ideal for removing rust and oxides, blending out disc marks, and removing coatings and gasket residues from automotive surfaces. Thick, reinforced non-woven backing is impregnated with tough aluminum oxide abrasive. New resin formulation will not smear.



2" TR BEAR-TEX

PART #



3" TR BEAR-TEX

PART #

GRIT	COLOR	2" TR BEAR-TEX PART #	3" TR BEAR-TEX PART #
Very Fine (320)	Blue	662610 09189	662610 09192
Medium (120)	Maroon	662610 09190	—
Coarse (80)	Brown	662610 09191	662610 09194
Case		25	25



2" AND 3" SPEED-LOK TR GRINDING DISCS



Premium performance abrasives

Easy twist-on / twist-off system

Rugged backing for extended life

FEATURES & BENEFITS

- Premium SG ceramic and zirconia alumina grain self-sharpening for an aggressive, consistent cut and long life
- Grinding aid coating produces minimal loading and burn-free grinding of heat-sensitive materials for a longer life
- Heavy duty backing allows for reduced edge wear extending the life of the disc



NORTON BLAZE SPEED-LOK TR DISCS

Norton Blaze self-sharpening design is ideal for high-pressure, heavy metal removal applications.

GRIT	2" TR	3" TR
	PART #	PART #
80	662611 62324	662611 62334
60	662611 62322	662611 62332
50	662611 62320	662611 62330
36	662611 62318	662611 62328
Case	25	25



NORTON BLUEFIRE SPEED-LOK TR DISCS

NorZon zirconia alumina self-sharpening abrasive cuts fast and cool to minimize heat build-up.

GRIT	2" TR	3" TR
	PART #	PART #
80	662611 121049	662611 121054
60	662611 121048	662611 121053
50	662611 138670	662611 138673
36	662611 138671	662611 138674
24	662611 138672	662611 138675
Case	25	25



SPEED-LOK BACK-UP PADS

Speed-Lok TR are compatible with similar competitive attachment systems.

DESCRIPTION	1" BACK-UP PAD	2" BACK-UP PAD	3" BACK-UP PAD
	PART #	PART #	PART #
Speed-Lok TR	088341 64037	662610 55103	662610 55105
Case	1	10	10



Long lasting

Consistent finish

Ergonomic

FEATURES & BENEFITS

- Durable polyester flaps improve life, grain retention, and wear evenly creating a more consistent, better finish with a cooler cut increasing the bottom line
- High strength plastic back design is lightweight and absorbs vibration allowing for greater control and technician comfort improving productivity
- 2" and 3" diameter discs get into hard to reach areas and allow for easy storage while maintaining required cut and life
- Can be used on high speed die grinders responding to the demand for smaller, ergonomically-friendly tools that require less effort, while delivering better results

NORTON BLAZE MINI FLAP DISCS

Blaze Mini Flap discs eliminate the conventional 2-step process in grinding edges and removing welds and rust. Featuring the latest-generation ceramic alumina abrasive these mini flap discs have 50-200% longer life versus the competition on stainless, titanium, and super alloys.



GRIT	2"	3"
	PART #	PART #
P120	776960 90149	776960 90154
P80	776960 90148	776960 90153
P60	776960 90147	776960 90152
P40	776960 90146	776960 90151
P36	776960 90145	776960 90150
PKG.	10	10

NORTON BLUEFIRE MINI FLAP DISCS

The abrasive technology used in the Norton BlueFire mini flap discs combined with the layered flap design wears away evenly, producing a high-quality and consistent finish. Strong zirconia alumina plus abrasive delivers aggressive cut rate and up to 30% longer life on mild carbon steel and welds and the semi-open coat impedes loading on aluminum.



GRIT	2"	3"
	PART #	PART #
P120	776960 90169	776960 90174
P80	776960 90168	776960 90173
P60	776960 90167	776960 90172
P40	776960 90166	776960 90171
P36	776960 90165	776960 90170
PKG.	10	10



2" – 5" NORKUT/BEAR-TEX AVOS GRINDING DISCS



NORTON NORKUT GRINDING DISCS

NorZon grain is resin bonded to a unique backing which resists cracking and breaking and can be cut down up to the 1" core. Use the cores to grind "pinch" welds and other hard to reach areas. Two quick-change mandrels are used on most popular tools: 7/16"-20 thread for use with hand held pneumatic grinders and 1/4" mandrel for use on automotive drills.



3" DISC		MANDREL
GRIT	PART #	PART #
50	636425 03658	–
36	636425 03657	–
24	636425 03656	–
7/16"-20 Mandrel	–	636425 03659
1/4" Mandrel	–	636425 03660
Pkg/Case	20/4	5/10



NORTON BEAR-TEX AVOS SPEED-LOK DISCS

Very Fine: removes 180-320 grit grind lines and is excellent for paint preparation.

Medium: removes 120-180 grit grind lines and is excellent for cleaning and rust removal.

Coarse: removes 60-120 grit grind lines and is excellent for deburring.



5"		
GRIT	COLOR	PART #
Very Fine	Blue	666233 74824
Medium	Maroon	666233 74819
Coarse	Brown	666233 74818
Pkg/Case		10/4



5" – 9" FIBER GRINDING DISCS



Premium performance abrasives

Grinding aid for heat reduction

Rugged backing for extended life

FEATURES & BENEFITS





- Premium SG ceramic and zirconia alumina grain is self-sharpening for an aggressive, consistent cut and extended disc life
- Grinding aid coating for minimal loading, reduced heat and a longer life
- Heavy Fiber backing has maximum strength and tear resistance for a long life



NORTON BLAZE GRINDING DISCS

The Norton SG Blaze grain, self-lubricating super size treatment and heavier fiber backing, create better finishes and longer life on stainless and other tough applications.





The 5" discs are available in a convenient, re-sealable foil pack to help control humidity and prevent curling.

	 5" x 7/8" FOIL PACK	 5" x 7/8"	 7" x 7/8"	 9-1/8" x 7/8"
GRIT	PART #	PART #	PART #	PART #
80	–	699573 98009	699573 98014	–
50	662544 64820	699573 98007	699573 98012	699573 98017
36	662544 64821	699573 98006	699573 98011	699573 98016
24	662544 64822	699573 98005	699573 98010	699573 98015
Case	10/50	25	25	25



NORTON RED HEAT GRINDING DISCS





The ceramic grain is ideal for high pressure, heavy metal removal applications such as weld grinding.

	 5" AVOS	 5" x 7/8"	 7" x 7/8"	 9-1/8" x 7/8"
GRIT	PART #	PART #	PART #	PART #
80	–	776960 08422	776960 08432	–
60	–	776960 08414	776960 08431	–
50	776960 08475	776960 08413	776960 08430	–
36	776960 08474	776960 08412	776960 08429	776960 08440
24	776960 08471	776960 08407	776960 10018	–
Case	10	25	25	25



NORTON BLUEFIRE GRINDING DISCS

Zirconia alumina grain provides a quick initial cut and a self-sharpening action continuously expose sharp, new cutting points. Ideal for lighter grinding or applications requiring a cool cut to minimize heat build up.

	 5" AVOS	 5" x 7/8"	 7" x 7/8"	 9-1/8" x 7/8"
GRIT	PART #	PART #	PART #	PART #
80	–	662611 38600	662611 38590	–
60	–	662611 38601	662611 38591	–
50	662611 26558	662611 38561	662611 38592	662611 38582
36	662611 26557	662611 38562	662611 38593	662611 38583
24	662611 26556	662611 38563	662611 38594	662611 38584
Case	10/4	25	25	25

Remove spot welds faster than bits

Cool cut

Gets into tight spots



FEATURES & BENEFITS

Norton Blaze

- Norton SG ceramic alumina grain is self-sharpening for consistent, aggressive cut and longer life
- Y-wt. polyester cloth backing provides edge-fray resistance for improved grinding throughout belt life
- Improved resin bond system significantly improved belt life due to exceptional grain adhesion
- Advanced "super size" grinding lubricant allows for a cooler cutting during the life of the belt

Norton BlueFire

- Self-sharpening zirconia alumina for fast cut and long life
- High performance resin bond has a strong grain adhesion and longer life
- Flexible X-wt. polyester backing for moderate to light pressure applications



PORTABLE FILE BELTS

Portable file belts are designed to be used for spot weld and hem flange removal as well as grinding in other tight areas. The 40 and 60 grit belts are ideal for spot weld removal on steel followed by the 80 and 120 grit belts for weld dressing and refinement.

	NORTON BLAZE	NORTON BLAZE	NORTON BLUEFIRE	NORTON BLUEFIRE
SIZE	PART #	PART #	PART #	PART #
1/2" x 18"				
40	699573 98021	776960 69243	662544 44193	666233 98278
60	699573 98022	776960 69244	780727 28569	666233 73756
80	699573 98023	776960 69245	780727 28568	666233 73757
120	662610 41384	776960 69246	780727 28567	666233 73758
3/8" x 13"				
60	699573 45359	—	780727 40295	—
80	699573 92150	—	780727 36062	—
<i>Pkg/Case</i>	<i>1/50</i>	<i>5/25</i>	<i>1/50</i>	<i>5/25</i>



NON-WOVEN PORTABLE FILE BELTS

SIZE	COLOR	NORTON BEAR-TEX PART #
1/2" x 18"		
Coarse	Brown	662610 55309
Medium	Maroon	662610 55310
Very Fine	Blue	662610 55311
<i>Pkg/Case</i>		<i>1/24</i>



Premium abrasive grain | Durable resin bond | Fiberglass reinforced



FEATURES & BENEFITS

- 100% high performance ceramic alumina grain for a faster, cooler cut and longer wheel life
- High performance resin bond for a long wheel life
- Fiberglass reinforcement maintains structural integrity



NORTON MEDALLION CUT-OFF BLADES

Norton Medallion cut-off blades deliver unmatched performance on the job. They are the ultimate choice for cool, easy, free-cutting of sheet metal, or heavy duty cutting of muffler clamps, bolts, and steel rods up to 3/4" thick, as well as spot weld grinding.

SIZE D x T x H	3" PART #	RPM
3" x 1/32" x 3/8"	076607 89032	25,465
3" x 1/16" x 3/8"	076607 89030	25,465
3" x 3/16" x 3/8"	076607 89034	25,465
Pkg/Case	5/10	

Do not use on tool without a guard.



SMALL DIAMETER REINFORCED CUT-OFF WHEELS

Excellent for sheet metal work, cutting clamps and rusted bolts. Follow all safety precautions.

SIZE D x T x H	NORZON PLUS PART #	GEMINI PART #	PERFORMANCE PART #	VALUE PART #	RPM
3" x 1/32" x 3/8"	—	—	—	076607 89011	21,260
	—	—	076607 89018	—	26,570
3" x 1/16" x 3/8"	—	—	—	076607 89012	21,260
	—	—	076607 89014	—	26,570
4" x .035" x 3/8"	662435 10675	662435 10630 FC	—	—	19,100
4" x 1/16" x 3/8"	662435 10677 FC	662435 10655 FC	—	—	19,100
Pkg/Case	25/1	25/1	5/20	100/4	

FC = Free Cut

Do not use on a tool without a guard.

SAFETY TIP

Always wear protective safety equipment and never exceed the RPM shown on the wheel.

Color-coded

Premium abrasives

Full line of
abrasive products



FEATURES & BENEFITS

- Consumer-friendly packaging features attractive, color-coded packaging to appeal to the DIY end user
- Features same high-quality, performance abrasive as professional products
- Full line of hand and power sanding abrasives designed to take the guesswork out of making the simpler, right choice



STICK & SAND SANDING DISCS

For orbital sanding various autobody applications with the swiftness of a power tool and the maximum productivity of an abrasive product that cuts fast, lasts long, resists loading and produces a consistent scratch pattern.

GRIT	6" NO-FIL DISCS		6" PSA DISCS		8" PSA DISCS	
	PART #	PART #	PART #	PART #	PKG/CASE	PKG/CASE
P400B	076607 00345	—	—	—	5/10	5/10
P320B	076607 00346	—	—	—	5/10	5/10
P220B	076607 00347	—	—	—	5/10	5/10
P180B	076607 00348	—	—	—	5/10	5/10
P80B	076607 00350	—	—	—	5/10	5/10
80E	—	076607 00351	076607 00762	076607 00762	5/5	5/5
40E	—	076607 00352	076607 00763	076607 00763	5/5	5/5



DRY SAND SHEETS

Superior versatility of a full sheet product for sanding old paint, primer and between color coats to repair surfaces; the premium aluminum oxide abrasive with anti-clog coating (No-Fil) on a strong paper backing makes quick work of the project.

GRIT	9" x 11"	
	PART #	PKG/CASE
P320B	076607 00629	5/10
P220B	076607 00630	5/10
P180B	076607 00631	5/10
P80E	076607 00633	5/10
P40E	076607 00634	3/10

WET SAND SHEETS

Get the same versatility of a premium full sheet product with the flexibility of a using it for wet, oil, or dry sanding. The specially-coated waterproof paper will not deteriorate or curl when wet - which means you can take the time needed to finish the job at hand.

GRIT	9" x 11"	
	PART #	PKG/CASE
2000B	076607 00491	5/10
1500B	076607 00492	5/10
1200B	076607 00493	5/10
1000B	076607 00494	5/10
P800B	076607 00495	5/10
P600B	076607 00496	5/10
P400B	076607 00497	5/10
P320B	076607 00498	5/10
P220B	076607 00499	5/10



STICK & SAND BODY FILE SHEETS

Specifically-designed for use on a body file board/sander with a premium abrasive and reinforced backing to sand body filler with controlled ease.

2-3/4" x 16-1/2"

GRIT	PART #	PKG/CASE
80E	076607 00322	3/10
40E	076607 00323	3/10



SCUFF PADS

Bear-TEX pads are ideal for contoured and tight areas. The consistently-graded grain in an advanced resin formulation increases strength to avoid tearing and shredding. Use maroon pads before primer and on primed surfaces. Use gray pads for final scuffing of blend panels.

6" x 9"

GRIT		PART #	PKG/CASE
Maroon	Primer/Prep	076607 00256	3/10
Gray	Color Prep	076607 00257	3/10



SPEED-LOK TR GRINDING DISCS

The zirconia alumina grain provides aggressive cutting action ideal for pinch welds and hard-to-reach areas. The quick-change Speed-Lok attachment makes allows for faster product changes for increased productivity.

3"

GRIT	PART #	PKG/CASE
36	076607 00518	3/10
24	076607 00517	3/10



GRINDING DISCS (FIBER)

The zirconia alumina grain provides a quick initial cut to strip away coatings. The self-sharpening grain continuously exposes new cutting points for extended disc life while running cool and minimizing heat buildup.

5"

GRIT	PART #	PKG/CASE
36	076607 00363	2/10
24	076607 00362	2/10



Powerful,
quiet technology

Lightweight
and mobile

Organization
and proficiency

FEATURES & BENEFITS

- Energy efficient and extremely quiet design
- Compact, smooth-edged design to maneuver tight spaces effortlessly.
- Extremely lightweight 16.5' coaxial anti-static hose is easy to store and delivers improved ergonomics
- Versatile design and enclosed storage area allows for customization improving cycle times and reducing waste
- An automatic filter cleaning system guarantees the greatest amount of dust removal preventing the vacuum from loading without interrupting work or reducing extraction

Low Maintenance – An automatic filter cleaning system guarantees the greatest amount of dust removal preventing the vacuum from loading without interrupting work or reducing extraction



Air cycle during normal operation



Air cycle during filter cleaning



NORTON VAC RACK BUNDLE

A customizable mobile work station that keeps technicians clean and organized, increases efficiency and the bottom line. The Norton VAC RACK bundle has the essentials needed for paint and body applications, allowing easy access for technicians to choose Norton abrasives, tools and accessories required to complete the job.

PART #	DESCRIPTION	QTY
699573 12400	VAC RACK Cart	1
	Vacuum System	1
	16.5' Pneumatic anti-static hose	1
	2-way Terminal	1
	Tool Hooks	2
	3" Hooks	6
	Shelves	2



FILTERS

The filter bags have a cap to keep dust in during disposal.

PART #	DESCRIPTION	QTY/CS
699573 12643	Filter bags	5
699573 12646	Polyester filter	1



CONNECTORS

The 2-way terminal allows for two hoses and tools to connect to the vacuum and run simultaneously. The rubber connection is a threaded hose fitting without a flow gauge.

PART #	Description	QTY/cs
699573 12640	2-way terminal	1
699573 12641	Threaded rubber connection for hose	1

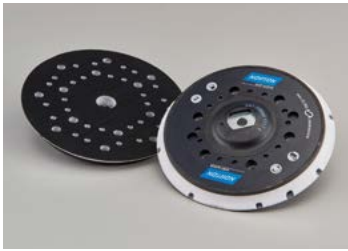

MULTI-HOLE BACK-UP PAD

The multi-hole pattern combined with the 10 channels on the side of the back-up pad provide an air flow that increases dust extraction on both horizontal and vertical surfaces for a cleaner work area. The back-up pad is designed to obtain a low center of gravity to ensure better control and precision during all phases of the sanding process.

PART #	DESCRIPTION	QTY/CS
699573 12647	Multi-hole back-up pad	5
699573 45337	Multi-hole interface pad	4



ANTI-STATIC HOSES

The 16.5' lightweight, anti-static hoses are treated to prevent the buildup of static electricity caused by dust as it moves through them. The hose for a pneumatic tool includes an integrated air line.

PART #	DESCRIPTION	QTY/CS
699573 12637	16.5' (5m) hose for pneumatic tool	1
699573 12638	16.5' (5m) suction hose	1
699573 45325	26.2' (8m) hose for pneumatic tool	1
699573 45336	26.2' (8m) suction hose	1



NORTON MULTI-AIR ORBITAL SANDERS

These sanders are engineered for extremely smooth and quiet operation with a lightweight and ergonomically design for maximum comfort. Use the 6mm throw orbital sander for preparing body filler or sanding of clear coat paints and the 3mm throw for fine sanding and edging.

PART #	DESCRIPTION	QTY/CS
699573 66126	6" 9mm throw orbital sander	1
699573 12633	6" 6mm throw orbital sander	1
699573 12636	6" 3mm throw orbital sander	1



NORTON MULTI-AIR HAND BLOCKS

Designed for use with Multi-Air Cyclonic NorGrip perforated rolls. The ergonomic dust free hand blocks are easy to hold and move in any position. Each block comes with a regulator adapter to control air flow and a reducer to connect to a standard vacuum hose line.

PART #	SIZE	QTY/CS
699573 96648	2-3/4" x 16-1/2"	1
699573 96646	2-3/4" x 8"	1
699573 96645	2-3/4" x 5"	1

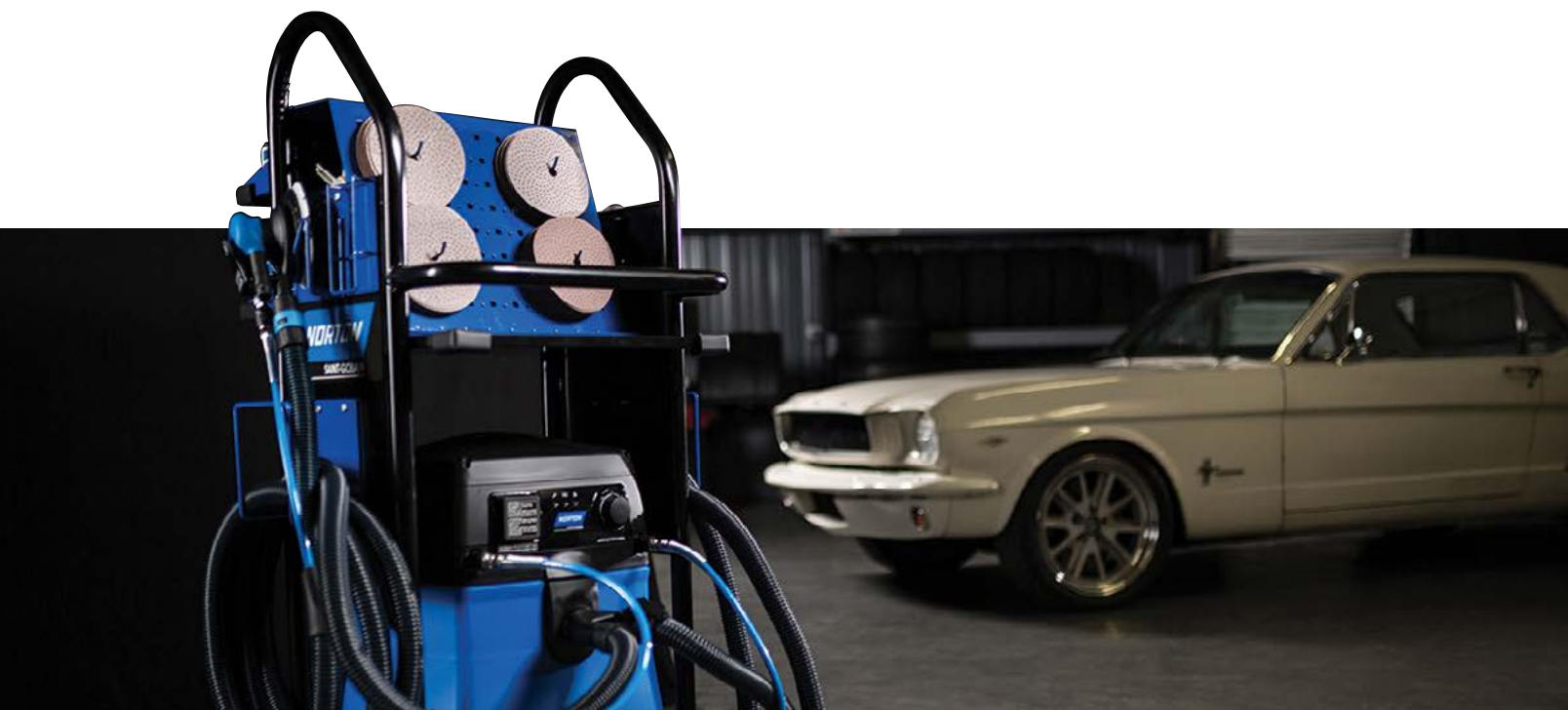

Compact

Powerful

Portable

FEATURES & BENEFITS

- A double-bearing spindle generates superb concentricity reducing vibrations allowing for longer use and finer finishes
- Finesse your projects by having the ultimate control in both precision and power with the speed regulator
- Get better tool handling along with reducing additional fatigue with the ergonomic and streamlined non-slip grip



NORTON MINI ANGLE SANDER

Put the world right in the palm of your hand with our 2" and 3" Norton Mini Angle Sanders. Small, compact enough in getting to those hard-to-reach areas, and powerful enough to finish the job fast and efficiently.

SIZE D x T x H	2"	3"	QTY/CS
2" Single Sander	662611 50076		1
2" Kit	662611 50077		1
Includes: 1 – Norton 2" Sander, 25 – 2" 36 Grit Norton Blaze R980P 3-Ply TR Discs (662611 62318), 50 – 2" Medium Grit Norton Rapid Prep Non-Woven TR Discs (662610 09190), 1 – 2" Medium Density Back-Up Pad (662610 55103)			
3" Single Sander		699573 82154	1
3" Kit		699573 82155	1
Includes: 1 – Norton 3" Sander, 25 – 3" 36 Grit Norton Blaze R980P 3-Ply TR discs (662611 62328), 25 – 3" Medium Grit Norton Rapid Prep Non-Woven TR discs (662610 17522), 1 – 3" Medium Density Back-Up Pad (662610 55105)			





Most advanced technology available

Minimal inventory handles multiple applications

Full range of products

FEATURES & BENEFITS

- Acrylic Adhesives are the best choice for metal-to-metal bonding, require no welding, and have a lifetime corrosion and performance warranty
- Urethane Adhesives are the best choice for plastic repairs, easy to sand and will no lift or roll up or shrinkage
- Epoxy Adhesives are ideal for undetectable SMC Repairs because they are easy to sand and will not lift or roll up

METAL BONDING	COMPOSITE PLASTIC REPAIR – BONDING	COMPOSITE PLASTIC REPAIR – STRUCTURAL	COMPOSITE PLASTIC REPAIR – COSMETIC	FLEXIBLE PLASTIC REPAIR – STRUCTURAL	FLEXIBLE PLASTIC REPAIR – COSMETIC	636425-	DESCRIPTION	COLOR	WORK TIME	HANDLING/ CLAMP TIME	SANDING TIME	PAINT TIME
ACRYLIC ADHESIVES												
■						06419	Metal Door Skin Bonding	Green	45 min	1-1/2 hrs		
■						06420	Metal Panel/Weld Bonding	Gray	75 min	2-1/2 hrs		
EPOXY ADHESIVES												
■	■	■		■		06418	Panel Bonder – 30 minute	Black	30 min	2 hours	3 hours	
■	■	■		■		06421	Panel Bonder – 90 minute	Black	90 min	4 hours	8 hours	
			■		■	06400	Plastic Repair Skim-Plus	Blue	1 – 2 min		15 – 20 min*	60 min
■						06427	Impact Toughened	Purple	90 min	120 min		
			■		■	06412	Repair and Filler	Purple	5 min		15-30 min*	15-30 min*
		■	■			06417	SMC/Fiberglass Repair	Beige	40 min		10 min @180°F	60 min @180°F
URETHANE ADHESIVES												
	■	■		■		97122	45 second (50 ml)	Opaque	45 sec	2-1/2 min	5 – 7 min*	
	■	■		■		04647	45 second	Opaque	45 sec	2-1/2 min	5 – 7 min*	
	■	■		■		04615	1 minute	Black	1-1/2 min	7 min	12 – 20 min*	1 hour
	■	■		■		04616	5 minute	Black	7 min	15 min	45 min	2 hours
■	■	■		■		04617	15 minute	Black	20 min	45 min	90 min	3 hours

*Sanding time depends on film thickness | Times are @ 70°F/21°C except #06421 @ 77°F / 25°C | All are 220 ml except #97122

ACRYLIC FOR METAL BONDING



45 MINUTE METAL PANEL/WELD BONDING ADHESIVE

Two-part acrylic (2:1) for panel bonding of door panels, other body sheet metal, steel and aluminum. Clamp time: 1-1/2 hours. Cure time: 8 hours.

DESCRIPTION	SIZE	PART #
Panel Bonding Adhesive 2:1	220ml	636425 06419
<i>Case</i>		6



75 MINUTE METAL PANEL/WELD BONDING ADHESIVE

Two-part acrylic (2:1) for panel bonding of quarter panels, rear body panels, roof panels, door panels, van side panels and outer truck bed panels on bare metals, including aluminum. Clamp time: 2-1/2 hours. Cure time: 8 hours.

DESCRIPTION	SIZE	PART #
Panel Bonding Adhesive 2:1	220ml	636425 06420
<i>Case</i>		6



IMPACT TOUGHENED STRUCTURAL ADHESIVE

Two-component epoxy for use in metal bonding applications. It exhibits excellent adhesion to a wide number of automotive substrates. The Impact Toughened Adhesive has an extended work time for use in large applications but work time can be accelerated with applied heat for applications that do not require longer open time.

DESCRIPTION	SIZE	PART #
Panel Bonding Adhesive 2:1	220ml	636425 06427
<i>Case</i>		

TECH TIP

Norton SpeedGrip adhesives SHOULD NOT be used for bonding structural components such as rails, pillars, rocker panels, core supports, etc. If in doubt as to what is a structural component, contact the vehicle manufacturer.

RESISTANCE SPOT WELDING: Norton recommends resistance welding through Metal Bonding Adhesives in a wet or cured state with little to no burn back.

WELDING: Norton Adhesive CANNOT be in the weld area or burn back will occur. Norton recommends at least one inch clearance from the weld site. A one inch clearance will keep the adhesive from contaminating the weld site while positioning the panel on the vehicle. If using weld through primer, make sure to cover weld area on vehicle and replacement panel, but do not contaminate bond line areas.

After clamping, wipe any excess adhesive off the panel while wet.



URETHANE FOR PLASTIC REPAIR



NORTON SPEEDGRIP 45 SECONDS

Two-part urethane (1:1) used for structural and cosmetic repairs of all plastic bumpers including TPE, TPO, TEO, PP, and ABS.

DESCRIPTION	SIZE	PART #
45 seconds	50ml	636425 97122
45 seconds	220ml	636425 04647
<i>Case</i>		6
<i>+Case</i>		12



NORTON SPEEDGRIP 1 MINUTE

Two-part urethane (1:1) used for structural and cosmetic repairs of all plastic bumpers including TPE, TPO, TEO, PP, and ABS.

DESCRIPTION	SIZE	PART #
1 minute	220ml	636425 04615
<i>Case</i>		6



NORTON SPEEDGRIP 5 MINUTES

Two-part urethane (1:1) adhesive used for structural and cosmetic repairs of all plastic bumpers, bumper tabs, emblems, door trims, interior and exterior plastic repairs, and cosmetic repairs including TPE, TPO, TEO, PP, and ABS and can also be used to bond SMC or fiberglass panels.

DESCRIPTION	SIZE	PART #
5 minutes	220ml	636425 04616
<i>Case</i>		6



NORTON SPEEDGRIP 15 MINUTES

Two-part urethane (1:1) adhesive used for installation of hood panels, roof panels, fenders, fender liners, fairings, spoilers, wind deflectors, cab extenders, ground effects, headlamp buckets, and other body panels. For bonding fiberglass, SMC, carbon fiber, and other plastics to itself and to primed metal.

DESCRIPTION	SIZE	PART #
15 minutes	220ml	636425 04617
<i>Case</i>		6



ADHESION PROMOTER

No need to identify plastic type – just simply apply Norton SpeedGrip Adhesion Promoter to all plastics once, no need to re-apply. Allow for a 10 minute flash time.

No plastic identification required.

DESCRIPTION	SIZE	PART #
Aerosol Adhesion Promoter	333 grams	636425 04625
<i>Case</i>		12

EPOXY FOR SMC/PLASTIC REPAIR



PLASTIC REPAIR SKIM-PLUS

Two-part epoxy (1:1) used to repair most plastic parts, including bumper covers and other plastic body panels including PP, fiberglass, Metton®, Telene®, SMC, TEO, and urethane. Formulated to finish the front side of flexible repairs used over the top of urethane adhesives.

DESCRIPTION	SIZE	PART #
Plastic Repair Skim-Plus	220 ml	636425 06400
<i>Case</i>		<i>6</i>



REPAIR AND FILLER

Two-part epoxy (1:1) used for cosmetic repairs on both flexible and rigid parts. Adhesion promoter must be used on plastic parts. Work time is 5 minutes and it can be sanded in 15-30 minutes. It sands easily and feathers well.

DESCRIPTION	SIZE	PART #
Repair and Filler	220 ml	636425 06412
<i>Case</i>		<i>6</i>



SMC/FIBERGLASS REPAIR ADHESIVE

Two-part epoxy (1:1) used for structural and cosmetic repair of all types of rigid body plastics such as SMC, GTX, fiberglass, Metton®, and carbon fiber.

DESCRIPTION	SIZE	PART #
SMC/FIBERGLASS REPAIR ADHESIVE	220 ML	636425 06417
<i>Case</i>		<i>6</i>



PANEL BONDING ADHESIVE

Superior two-part epoxy (2:1) adhesive designed to bond SMC, FRP, fiberglass, steel, and aluminum auto parts and body panels to each other and to metal frames (no primer required). It seals and bonds in one application.

DESCRIPTION	SIZE	PART #
Panel Bonding Adhesive – 30 minute	220 ml	636425 06418
Panel Bonding Adhesive – 90 minute	220 ml	636425 06421
<i>Case</i>		<i>6</i>





SEAM SEALER – CONTROLLED FLOW

Two-part epoxy (1:1). Permanently flexible sealer that features a controlled levelling characteristic, as opposed to the excessive flow found in a self-levelling seam sealer. For use on horizontal or sloped areas. Can be painted after 30 minutes.

DESCRIPTION	SIZE	PART #
Seam Sealer - Controlled Flow	220 ml	636425 06402
<i>Case</i>		6



SEAM SEALER

Two-part epoxy (1:1) used to seal interior and exterior seams, joints, and voids. It will not shrink, harden, or crack and retains its flexibility. For use on vertical or horizontal seams.

DESCRIPTION	SIZE	PART #
Seam Sealer	220 ml	636425 97120
<i>Case</i>		6



SEAM SEALER – SELF-LEVELLING

Two-part epoxy (1:1) is formulated for use on drip rails, trunk seams, and roof channels. It will not shrink, harden, or crack and retains its flexibility. For use on horizontal seams.

DESCRIPTION	SIZE	PART #
Seam Sealer – Self-Levelling	220 ml	636425 97121
<i>Case</i>		6



BARE METAL EPOXY SEAM SEALER

Two-part epoxy (1:1), non-sag, high solid epoxy designed where a fast setting and fast paint time sealer is desired. Provides the latest in technology for sealing seams and faster paint time than the traditional sealers. Norton Bare Metal Epoxy Seam Sealer extrudes easily with excellent tooling characteristics with no shrinkage, and can be painted after 45 minutes at 70° F/21°C.

DESCRIPTION	SIZE	PART #
Bare Metal Seam Sealer	220 ml	636425 06398
<i>Case</i>		6





FLEXIBLE URETHANE FOAM

Two-part dark gray, flexible urethane foam formulated to expand 10 times its original volume. Used to stop wind, noise, and water leaks in pillar posts. Adds reinforcement to panels. Matches OEM flexible foams.

DESCRIPTION	SIZE	PART #
Flexible Urethane Foam	220 ml	636425 04622
Case		6



RIGID URETHANE FOAM

Two-part yellow, non-structural rigid foam used for sound deadening, vibration dampening, reinforcement, sealing and filling of: pillars, rocker panels, fender rails, quarter panels, and floors. Matches OEM sound deadening foams commonly found in front rails, pillars, rear supports, and rockers.

DESCRIPTION	SIZE	PART #
Rigid Urethane Foam	220 ml	636425 06399
Case		4





OEM approved

Urethane formula bonds all materials

Minimal inventory for multiple applications

FEATURES & BENEFITS

- High strength structural bonding with OEM quality and performance and outstanding corrosion protection
- Various work times result in faster unclamp time to increase productivity



SMC/FRP FIBERGLASS REPAIR AND PANEL BONDING – URETHANE

Norton SpeedGrip/PLIOGRIP® two-part urethane adhesives are a quick and versatile system for bonding and repairing steel, aluminum, flexible, semi-rigid and rigid plastic and SMC, FRP, and fiberglass. All products provide the same outstanding performance on these materials. Just select the working time that best fits your needs.

400ML		
DESCRIPTION	PART #	PLIOGRIP® CROSSOVER
3 minutes	636425 04671	7773
10 minutes	636425 04672	7779
35 minutes	636425 04673	7770
Case	6	

400ml Use applicator gun #41398-manual or #41396-pneumatic

Working Times

OPEN TIME	WORK TIME	CLAMPING/FIXTURE TIME	SANDING/PAINTING TIME
3 minutes	3-1/2 minutes	10 minutes	30 minutes
10 minutes	17 minutes	30 minutes	1 hour
35 minutes	50 minutes	90 minutes	3 hours

Times will increase as temperatures decrease.

Times shown above are at 77°F/25°C.

Full cure time is 24 hours but this may be accelerated with heat.

Do not apply polyester based putty/fillers on urethane products.

If polyester putty/filler must be used, skim coat over the Norton Speed-Grip repair area using Norton Speed-Grip rigid repair adhesive or Norton Speed-Grip flexible repair adhesive.



SMC/FRP FIBERGLASS PANEL BONDING – EPOXY

Superior two-part epoxy Norton SpeedGrip/PLIOGRIP® adhesive designed to bond steel, aluminum, SMC, FRP, and fiberglass truck parts and panels. It seals and bonds in one application. The longer work time allows for adequate adjusting and handling. The glass beads mixed in this formulation provide the adequate spacing between parts for optimal bond strength.

DESCRIPTION	SIZE	PART #
Epoxy Panel Bonding Adhesive	400 ml	636425 04674
Case		6

Use applicator gun #41398-manual or #41396-pneumatic 2:1 Cartridge

Working Times

WORK TIME	CLAMPING/FIXTURE TIME	SANDING/PAINTING TIME
90 minutes	4 hours	8 hours

PLIOGRIP® ADHESIVE Manufactured by Ashland Inc., Columbus, OH
© PLIOGRIP, Registered Trademark, Ashland Inc.



Manual Applicator Gun –
1:1 and 2:1



Pneumatic Applicator Gun –
1:1 and 2:1



Manual Applicator Gun –
50 ml 1:1
Manual gun used with the
50 ml cartridge.



Mixing Tips
24-element tips ensure automatic
mixing for 220ml to 400ml. 16-element
tips are used with the 50 ml.

ACCESSORIES

DESCRIPTION	50ML PART #	200ML/220ML PART #	400ML PART #	50ML TIPS PART #	220ML TO 400ML TIPS PART #
Manual Applicator Gun 1:1 & 2:1	–	636425 41400	636425 41398	–	–
Pneumatic Applicator Gun 1:1 & 2:1	–	636425 41399	636425 41396	–	–
Manual Applicator Gun 1:1	636425 97117	–	–	–	–
Mixing Tips - 16 Element (white)	–	–	–	636425 97118	–
Mixing Tips - 24 Element (green)	–	–	–	–	636425 04628
<i>Pkg/Case</i>	<i>1</i>	<i>1</i>	<i>1</i>	<i>6/60</i>	<i>6/60</i>



NYLON REINFORCING TAPE

Self-adhesive backing tape for repairing and filling holes and plastic gouges. It can be used for both urethane and epoxy adhesives.

DESCRIPTION	SIZE	PART #
Nylon Reinforcing Tape	2" x 65"	636425 04632
<i>Case</i>		<i>6</i>



MIXING SPREADER WITH TAPERED EDGES

For use with #63642506400 Plastic Repair Skim-Plus.

DESCRIPTION	SIZE	PART #
Mixing Spreader	3" x 4"	636425 06396
<i>Pkg/Case</i>		<i>25/100</i>



SPRAYABLE SEAM SEALER S-4 KIT AND MIXING TIPS

The S-4 (Sprayable Seam Sealer System) Starter Kit includes one S-4 Atomization Unit with a standard M style air fitting (which can be changed out), a bag of six S-4 Mixing Tips and instructions for use.

The S-4 Atomization Unit attaches to the bottom of the Pneumatic Gun (#41399) and can easily adjust the air pressure as needed. Either Seam Sealer #97120 or Bare Metal Seam Sealer #06398 can be used to replicate textured OEM seals. The S-4 Mixing Tip (#06404) screws onto the cartridge, and the opposite end of the tip attaches to the hose on the S-4 Unit.

DESCRIPTION	PART #	PIECES/PACK	PACKS/CASE
S-4 Starter Kit	636425 06403	1	1
S-4 Mixing Tips	636425 06404	6	10



NORTON SPEEDGRIP RACK

Heavy-duty steel rack that can be hung up in the shop and will help you organize your inventory of Norton SpeedGrip Structural Adhesives.

DESCRIPTION	SIZE	PART #
Norton SpeedGrip Rack	25-1/2" x 11" x 9-1/2" deep	636425 06168
Case		1



Ultra fast, high-strength
bond adhesives

Full line of joint and
seam sealers

Brush and spray
protective coatings



FEATURES & BENEFITS

- High quality components match OEM color or texture with ultra-fast application and dry time and high-strength bond
- Complete line with multiple applications with minimal inventory



SUPER BOND WEATHERSTRIP ADHESIVE

Super Bond Weatherstrip Adhesive is a fast setting, high-bond strength adhesive. Used to bond rubber or vinyl weatherstrips to doors, trunks, windows, etc. Nasal tip or controlled bead. Instant tack. Strong bond. Fast drying. Waterproof. Resists oil, grease, and silicone.

DESCRIPTION	COLOR	SIZE	PART #
Super Bond Weatherstrip Adhesive	Black	5 oz Tube	076607 82705
	Amber	5 oz Tube	076607 82706
<i>Case</i>			12



HEAVY DUTY SPRAY TRIM ADHESIVE

A fast drying, super strength adhesive in an aerosol can. Used to bond carpeting, urethane foam, insulation, supported vinyl, wood, paper, hood pads, and headliners to most substrates. Convenient adjustable spray nozzle for varied applications.

DESCRIPTION	SIZE	PART #
Heavy Duty Spray Trim Adhesive	24 oz Can / 15.75 oz Net Wt.	076607 82725
<i>Case</i>		12



JOINT AND SEAM SEALERS & GUIDE COAT



URETHANE WINDSHIELD SEALER

A one part urethane adhesive sealant for windshield and backlite installations. Easy handling, fast-set properties, excellent shelf life. Passes Motor Vehicle Safety Standard #212 windshield barrier test and #216 crush test.

DESCRIPTION	SIZE	PART #
Urethane Windshield Sealer	1/10 gal. Cartridge	076607 82735
Case		12



BRUSHABLE SEAM SEALER

A brush grade sealant used to seal any body seam against moisture or dust. Skins in 5 minutes; paintable in 30. Use on flat seams in trunk areas or to finish skin panels. Can hold brush marks for OEM appearance. Excellent toolability.

DESCRIPTION	SIZE	PART #
Brushable Seam Sealer	1 Quart Can	076607 82746
Case		6



URETHANE SEAM SEALER

A one-component, polyurethane seam sealer that cures quickly to a permanent, flexible sealant designed for sealing interior and exterior body joints and seams and duplicates OEM appearance. Paintable in 1 hour. Flexible foil package eliminates product waste. Use with Application Gun #82786.

DESCRIPTION	COLOR	PART #
Urethane Seam Sealer Sausage Pack	White	076607 82751
Case		6



APPLICATION GUN

Designed for use with Norton Urethane Seam Sealer (#82751). This item is a fully enclosed metal unit, which provides fast and efficient application of seam sealer material. Low ratio mechanism allows for easy pumping and precise application of sealant.

DESCRIPTION	PART #
Application Gun	076607 82786
Case	1



QUICK-SET SEAM SEALER

Quick-Set Seam Sealer can be used to seal any body seam against moisture or dust and to finish skin panels. Applies easily, skins in 2 minutes, paintable in 30. Outstanding toolability. Remains flexible when dry. Excellent adhesion to numerous substrates.

DESCRIPTION	COLOR	SIZE	PART #
Quick-Set Seam Sealer	Beige	1/10 Gal Cartridge	076607 82750
Case			12



BLACK POWDER GUIDE COAT AND CARBON BLACK GUIDE COAT

Provides the technician with a visual aid to ensure primed surfaces are totally smooth and even. A quick and efficient method to find uneven and low spots on body filler, primer, glazing putties and other repair components. Apply guide coat over the area to be sanded, and continue sanding until the coating is no longer visible on the surface. It can be sanded using either wet or dry sanding methods.

DESCRIPTION	SIZE	PART #
Black Powder Coat with applicator	100 grams	666233 34772
Carbon Guide Coat	16 oz Can/10.5 oz Net Weight	076607 21938
Case		6



ROCKER-PANEL TEXTURE COAT

A rapid drying, flexible, abrasion-resistant protective coating that can be varied to match OEM textures found on rocker panels and valances. Paintable in 60 minutes. Highly chip resistant.

DESCRIPTION	COLOR	SIZE	PART #
Rocker-Panel Texture Coat	White	16 oz Can/13 oz Net Weight	076607 82770
	Black	16 oz Can/13 oz Net Weight	076607 82772
<i>Case</i>			6



PREMIUM RUBBERIZED UNDERCOAT – PAINTABLE

Fast-drying rubberized undercoat for rust-prevention, sound deadening and chip resistance to fenders, undercarriages, quarter panels, wheel wells, decks, and hoods. Excellent adhesion to painted and unpainted surfaces. Resists rust and abrasion as it seals out dust and moisture. Paintable in one hour.

DESCRIPTION	SIZE	PART #
Premium Rubberized Undercoat	24 oz Can/17.75 oz Net Weight	076607 82775
<i>Case</i>		6



RUBBERIZED UNDERCOAT

Seals out rust, fumes, heat and cold while protecting underbody areas. Excellent adhesion that won't crack or chip under normal conditions. Engineered to protect underbody areas from moisture and abrasion while deadening sound. Fast drying and economical.

DESCRIPTION	SIZE	PART #
Rubberized Undercoat	20 oz Can/16 oz Net Weight	076607 82776
<i>Case</i>		6



AMBER RUSTPROOFING

Amber Rustproofing matches OEM appearance while providing superior rust protection. This abrasion resistant coating will flow into hard to reach seams. It is designed for replacement panels or new car rustproofing and restores the repair of existing corrosion protection to original specifications found on the interior of fender and panel replacements.

DESCRIPTION	SIZE	PART #	PART #
Amber Rustproofing	24 oz. Aerosol, Net Wt. 17.75 fl. oz.	636425 06425	
Corrosion Protection Wand Kit			636425 06426
<i>Case</i>		6	1



PANEL AND ADHESIVE CLEANER

Removes adhesives, tar, grease, wax, body sealers, undercoating sprays, and silicone from most surfaces. Aggressive cleaner is safe to use on most paint applications. Packaged with squirt dispenser. Use as directed.

DESCRIPTION	SIZE	PART #
Panel and Adhesive Cleaner	Quart/32 oz	076607 82780
<i>Case</i>		12



AUTOMOTIVE PANEL WATERBORNE CLEANER/DEGREASER

A non-hazardous, solvent free cleaner and degreaser for cleaning automotive surfaces prior to applying primer, sealer, base coat, clear coat, or other coatings. Intended for use as a final wash for metal, plastics, and coatings. It cleans sanding dust and grime from these substrates. Works well removing road grime, salt dust, insects, bird droppings, silicone oils, waxes, and masking tape residue. When used as directed, it leaves no harmful residue and assists in proper coating adhesion.

DESCRIPTION	SIZE	PART #
Waterborne Cleaner	Quart/32 oz	076607 21937
<i>Case</i>		6



PREMIUM AUTOMOTIVE ATTACHMENT TAPE

High-density gray foam tape coated with high strength acrylic adhesive on both sides with red polyethylene release liner is designed for bonding medium to large moldings and accessories. High-strength acrylic adhesive provides superior adhesion to plastics, metal, glass, and painted vehicle surfaces.

- Used for attaching body side moldings, cladding, door edges, emblems, interior trim, rocker panel moldings and pillar covers
- Remains flexible at low temperatures

DESCRIPTION	1/4" x 20 YDS PART #	1/2" x 20 YDS PART #	7/8" x 20 YDS PART #
Attachment Tape .045" Thick	636425 05620	636425 05621	636425 05622
<i>Case</i>	12	12	12



AUTOMOTIVE ATTACHMENT TAPE

High-density black foam tape with green polyethylene release liner bonds small to medium moldings and accessories. High strength acrylic adhesive provides superior adhesion to plastics, metal, glass, and painted vehicle surfaces. The black color of the tape hides well from detection.

DESCRIPTION	1/2" x 20 YDS PART #	7/8" x 20 YDS PART #
Attachment Tape .030" Thick	636425 76377	636425 76378
<i>Case</i>	12	12



ATTACHMENT TAPE ADHESION PROMOTER

Norton Attachment Tape Adhesion Promoter is a liquid primer to improve the adhesion of Norton automotive attachment tapes to exterior and interior trims involving injection molded and/or plastics (TPO, PPO, PP, PC, etc.). The convenient dauber style container neatly dispenses the ideal amount of product for optimal adhesion.

DESCRIPTION	SIZE	PART #
Attachment Tape Adhesion Promoter	4 oz. dauber	636425 04670
<i>Case</i>		6



Paintable

Corona-treated so paint will not flake off

Excellent cling

FEATURES & BENEFITS

- Tri-layer paintable sheeting is easy and fast to apply, and clings to the vehicle's body even after being repositioned
- Corona-treated so the overspray paint won't flake off and create rework
- 3-ply resin formula is .4 mil thick and provides excellent tear resistance, prevents bleed through, and is solvent resistant
- Conveniently packaged on a standard core to fit all current masking dispensers, making it simple for one person to apply



NORTON BLUE SHEETING

Paint will adhere to the outside layer of plastic, eliminating flake-off. The cling ensures material adheres to the area that is to be protected. Norton Blue Sheeting can be cut and painted along the critical edge. Tri-layer plastic is .4 mil thick.

	12' x 400'	16' x 350'	20' x 350'
DESCRIPTION	PART #	PART #	PART #
Norton Blue Sheeting	636425 03344	636425 03345	636425 03723
Case	1	1	1



NORTON OVERSPRAY SHEETING

"Value" paintable overspray sheeting. Medium-density, corona-treated plastic.

	12' x 400'	16' x 400'
DESCRIPTION	PART #	PART #
Overspray Sheeting	636425 06727	636425 06728
Case	1	1



ANCHOR® BRAND HAND MASK

IPG's Anchor® brand Hand Mask is a pre-folded, high density polyethylene masking film designed for multiple transportation applications. The thick and durable 12 micron film is corona treated to resist overspray flaking during paint applications. This special film is designed with a reinforced top edge formulated to prevent the underlying film from sticking. Solvent resistant; no bleed-through and clings to surface. Designed to work with multiple hand dispensers and the 1" core fits most masking machines.

	54.8M (60YD) ROLL	90' ROLL	180' ROLL
WIDTH	ROLL HEIGHT	PART #	PART #
24"	5.35"	—	087143 00214
48"	8.78"	—	087143 00216
72"	9.57"	087143 00217	—
99"	13.0"	087143 00218	—
Case		12	12

NORTON BLUE WRAP PROTECTIVE PLASTIC



Self-Adhesive Weather Barrier

- Clear film with built in UV inhibitors for interior protection
- Don't leave on more than 30 days
- Do not expose above 170° F
- Do not install on wet or damp surfaces

DESCRIPTION	PART #
Weather Barrier 36" x 100' (9 lbs.) 3 mil thick	636425 05920
Case	1



Wheel Maskers

- Tri-layer plastic
- Paintable – NO Flaking
- Fully covers both sides of the wheel
- Covers wheels up to 17"

DESCRIPTION	PART #
Wheel Maskers (50/roll) Paintable	636425 05922
Case	1



Bucket Seat Covers

- Full coverage from headrest to floor
- Will not slip or bunch up
- Protects seats from grease, dust and chemicals
- Perforated roll

DESCRIPTION	PART #
Bucket Seat Covers (125/roll) Non-Slip	636425 05921
Case	1



Floor Mats

- Will not slip or tear
- Protects floor from dirt, grease and chemicals
- Perforated roll
- Generous size: 16-1/2" x 21"

DESCRIPTION	PART #
Floor Mats (125/roll)	636425 05923
Case	1





WHITE NORTON PAINT CHECK MASKING PAPER

Premium white masking paper is corona-treated so paint won't flake off, poly coated to protect against bleed-through and has a built-in Norton Paint Check for convenience. Masking tape can be repositioned without tearing the paper. White paper will not distort lighting during the painting process. This paper is stronger than blue paper, but is thinner to better conform to tight curves without tearing.

- Corona-treated so paint won't flake off and poly-coated to protect against bleed-through
- Features built in "Paint Check" design for use confirming proper paint flow and coverage
- Tear-resistant paper makes it easy to reposition tape without ripping
- White paper does not distort the lighting during the painting process
- Resistant to waterborne and solvent-based products

SIZE	6"	12"	18"	24"	36"
DESCRIPTION	PART #	PART #	PART #	PART #	PART #
Masking Paper (750' boxed)	636425 00402	636425 00403	636425 00404	636425 06224**	636425 00407
Case	1	1	1	1	1

Each 750' boxed case is a 36" log. Length is approximate
** 24" is single log.



MOBILE MASKER

The premium white paper, while incredibly strong, is thinner than standard blue paper and fits perfectly on the masker. The top two tiers can hold up to 12" and the bottom two tiers can hold up to 18".

DESCRIPTION	PART #
Stand	662610 89208
Case	1





PREMIUM TRIM PERFORATED MASKING TAPE

This premium automotive trim masking tape is designed to lift the molding from the surface to be painted to allow paint coverage under the molding.

50MM x 10M
(2" x 10.94 YARDS)

DESCRIPTION	PART #
American® brand TrimFast™	077922 00268
Norton Trim Tape	636425 06169
Case	6



FOAM MASKING TAPE

Easy-to-use, time-saving products to mask door jambs and other apertures like hood and deck lid openings that need to be sealed during the painting process. The Premium Foam Masking Tape features a semi-split design and offset adhesive to ensure a soft paint edge.

13MM
(1/2" x 54.5 YDS)

20MM
(3/4" x 54.6 YDS)

DESCRIPTION	PART #	PART #
Foam Masking Tape	662544 70735	—
Premium Foam Masking Tape	—	662544 70746
Case	1	1



CLOTH DUCT TAPE

Silver polyester cloth tape is highly conformable and moisture resistant. Ideal for general purpose repair applications.

2" x 60 YDS

DESCRIPTION	PART #
Norton Duct Tape	636425 78000
IPG Duct Tape AC20	077922 74977
Case	24



FINE LINE TAPE

Fine line Tape adheres and conforms easily to contours and irregular surfaces. This tape's unique thinness allows for minimum edge build-up and leaves no residue when removed. Resistant to temperatures up to 180°F. It features "pucker-free" cornering, and has straight edges on long runs, plus stays in places and doesn't roll back or have curling edges.

	1/8"	1/4"	1/2"	3/4"
DESCRIPTION	PART #	PART #	PART #	PART #
36 Yard Roll	636425 72018	636425 72014	636425 72012	636425 06174
Case	12	12	12	12





Full range of sizes | Superior safety protection | Style for every job

FEATURES & BENEFITS

- Provide options for safety and comfort while tackling the toughest repair jobs
- Available in a full range of styles and sizes



GENERAL PURPOSE 4 MIL NITRILE (BLUE)

Economical all-purpose 4 mil Nitrile gloves are ideal for quick jobs or when changing gloves frequently is necessary.

DESCRIPTION	MEDIUM	LARGE	X-LARGE	XX-LARGE
	PART #	PART #	PART #	PART #
General Purpose 4 Mil Nitrile (Blue)	666233 90700	666233 90701	666233 90702	666233 90703
Qty/Case	100	100	100	100



HEAVY DUTY 6 MIL NITRILE GLOVES (BLACK)

Heavy duty 6 mil Nitrile gloves are designed for longer use in more demanding repair applications. Provides superior protection.

DESCRIPTION	MEDIUM	LARGE	X-LARGE	XX-LARGE
	PART #	PART #	PART #	PART #
Heavy Duty 6 Mil Nitrile Gloves (Black)	666233 90704	666233 90705	666233 90706	666233 90707
Qty/Case	100	100	100	100



HEAVY DUTY 7 MIL LATEX GLOVES (WHITE)

Heavy duty latex gloves for those who prefer/need the tighter fit of the latex design. Elastic, resilient and comfortable. Gloves do contain natural rubber latex which may cause allergic reactions.

DESCRIPTION	MEDIUM	LARGE	X-LARGE	XX-LARGE
	PART #	PART #	PART #	PART #
Heavy Duty 7 Mil Latex Gloves (White)	666233 90712	666233 90713	666233 90714	666233 90715
Qty/Case	100	100	100	100



TEXTURED 7 MIL NITRILE GLOVES (ORANGE)

Designed for maximum protection, the 7 mil Nitrile gloves also offer a "diamond" pattern texture to allow for excellent gripping properties. Perfect for jobs where you need extra grip to hold onto tools, parts or containers.

DESCRIPTION	MEDIUM	LARGE	X-LARGE	XX-LARGE
	PART #	PART #	PART #	PART #
Textured 7 Mil Nitrile Gloves (Orange)	666233 90708	666233 90709	666233 90710	666233 90711
Qty/Case	50	50	50	50



Comfortable fit | Superior safety protection | Style for every job

Whether you're sanding body filler or completing a plastic repair, safety is critical and should be in the forefront of your mind. Norton now carries a full range of safety products that adhere to the same standards of quality as our premium abrasive products and are designed with the automotive technicians needs in mind.



FOAM EAR PLUGS

Norton foam ear plugs are comprised of soft foam formed in a tapered shape that allows them to fit easily in the ear. The smooth surface allows the plugs to fit tight and comfortable in the ear with no irritation. Their NRR rating of 32 decibels makes them ideal for most noisy environments. The corded plugs are ideal for keeping track of the ear plugs when not in use.

- NRR rating of 32 decibels
- Offer both loose and corded versions
- Soft foam for comfortable fit.
- Individually packaged

DESCRIPTION	PART #	PART #
Foam Ear Plugs Loose	076607 68367	
Foam Ear Plugs Corded		076607 68368
Qty/Case	200/1	100/1



SAFETY GLASSES

Norton Safety Glasses features a full range of eyewear options to ensure you always have the right protection for your eyes. Glasses meet all of the pertinent ANSI specifications for safety eye wear.

- Norton standard safety glasses – Economical wrap-around single lens provides full panoramic view. Polycarbonate lenses are coated for superior scratch resistance.
- Norton premium safety glasses – Rubber temple tips and built-in rubber nosepiece keep eye wear secure for the active worker. Scratch resistant anti-fog polycarbonate lens provide 99% UVA/B/C rays protection.
- Norton over prescription glasses – Designed to fit over today's prescription eye wear, scratch-resistant glasses are 100% polycarbonate and deliver 99% UVA/B rays protection.

	STANDARD	PREMIUM	OVER PRESCRIPTION
DESCRIPTION	PART #	PART #	PART #
Standard Safety Glasses	076607 68280		
Premium Safety Glasses		076607 68281	
Over Prescription Safety Glasses			076607 68282
Qty/Case	12/25	12/25	12/25

CABINETS AND DISPENSERS



Ergonomic design for comfort

Constructed of durable materials

Designed for automotive applications

FEATURES & BENEFITS

- High-quality, durable components are long lasting and cost effective
- Ergonomic design reduces fatigue



NORTON AUTOBODY UTILITY CABINET

Rugged, heavy gauge steel with two adjustable shelves and a security latch for locking doors. Store abrasives, tapes and chemicals, while keeping them clean, dry and secure. Sidewalls are pre-punched to mount six Norton disc roll/sheet roll dispensers. Weight: 54 pounds.

DESCRIPTION	SIZE	PART #
Automotive Utility Cabinet	32" x 13" x 25"	636425 42770
Case		1



ADHESIVES AND SEALERS CABINET

Heavy gauge steel – will hold all of the Norton Adhesive and Sealers keeping them dry, clean and secure.

DESCRIPTION	SIZE	PART #
Adhesives and Sealers Cabinet	30" x 10" x 26"	636425 02532
Case		1



NORTON DISC ROLL AND SHEET ROLL DISPENSERS

Norton Automotive Disc and Sheet Roll Dispensers feature heavy duty construction and a rubberized finish, designed to protect your product, as well as the finish on your workpiece. They are versatile, for use with any 5" or 6" disc roll or sheet roll.

DESCRIPTION	PART #
Single Disc Roll Dispenser	636425 42772
Double Disc Roll Dispenser	636425 02981
Sheet Roll Dispenser	636425 42773
Case	1

* Each rack can be attached to a wall, mounted on a Norton Utility Cabinet, or stacked upon other Norton dispensers.



ERGONOMIC SANDING BLOCKS

DESCRIPTION	2-3/4" x 5"	2-3/4" x 7-3/4"
	PART #	PART #
Soft – PSA	636425 42090	–
Firm – PSA	636425 42091	–
Soft – NorGrip	636425 42092	–
Firm – NorGrip	636425 42093	–
Firm – PSA	–	636425 42094
Firm – NorGrip	–	636425 42095
Case	5	5

PSA – Soft

Constructed of flexible, yet tough, foam and shaped to fit comfortably in your hand. The design is good for both flat surfaces as well as contours. The embossed rubber face allows for good adhesion of PSA sheet rolls.

PSA – Firm

Constructed of durable material and shaped to fit comfortably in your hand. The firm design produces a true, flat surface. The embossed rubber face allows for good adhesion of PSA sheet rolls.

NorGrip – Soft

Constructed of flexible, yet tough, foam and shaped to fit comfortably in your hand. The design is good for both flat surfaces as well as contours. Works with standard hook and loop sheets.

NorGrip – Firm

Constructed of durable material and shaped to fit comfortably in your hand. The firm design produces a true, flat surface. Works with standard hook and loop sheets.



RUBBER HAND SANDING BLOCK

Ideal for uniform sanding. Can be used for dry or wet sanding. Uses a 2-3/4" x 9" sheet which is 1/4 of a standard 9" x 11" sheet. Slotted jaws securely hold sheets in place.

DESCRIPTION	PART #
Rubber Hand Sanding Block	076607 01889
Case	5



ERGONOMIC HAND SANDING BLOCK FOR 6" DISCS

The unique design quickly converts a 6" diameter PSA or NorGrip disc into a hand sander. The ergonomic design of the pad fits the user's fingers for added comfort and reduced fatigue.

DESCRIPTION	PART #
For 6" PSA Discs	636425 03727
For 6" NorGrip Discs	636425 03726
Case	5



DISC HAND PADS

The 3/8" thick pad is composed of neoprene and foam, for excellent conformability. Each pad has an elastic hand strap to hold it firmly in place when used with a 6" NorGrip disc for scuff sanding flat or contoured surfaces.

The half moon pad uses a 6" NorGrip disc which adheres to the hooks on the pad face. The straight edge of the pad allows the technician to sand contours and narrow crevices.

DESCRIPTION	PART #
6" x 1/2" Thick Soft Foam NorGrip	636425 00906
6" Half Moon NorGrip	636425 00904
Case	10

SANDING BLOCKS AND BOARDS

DUAL DENSITY WET SANDING BLOCK

Because of the "grabbing" power of these blocks, no adhesive is required, simply wrap the paper around the block. The dense side is for more aggressive blocking, while the soft side is for color sanding. These blocks come in a "point of purchase" display pack.



DESCRIPTION	PART #
Wet Sanding Block	636425 03728
Case	12

HOLEY BLOCK

A rugged, semi-rigid, multi-purpose sanding block engineered for flat to medium curved surfaces. A tactical hole pattern side provides numerous cutting edges to create a 30% faster cut rate. The plain side provides firmness and a comfortable, easy-to-hold surface. These blocks come in a "point of purchase" display pack.



DESCRIPTION	PART #
Holey Block	636425 03729
Case	8

PSA SANDING BOARD

The PSA Sanding Board has a cushioned surface. Slots at each end securely hold 2-3/4" x 17-1/2" abrasive sheets or may be used with 2-3/4" x 16-1/2" PSA sheets.



DESCRIPTION	PART #
PSA Body File Sanding Board	636425 42724
Case	6

NORTON NORGRIP SANDING BOARD

The NorGrip Sanding Board has a lightweight, rugged design. This Sanding Board is designed be used with 2-3/4" x 16-1/2" hook and loop sheets.



DESCRIPTION	PART #
NorGrip Body File Sanding Board	636425 52836
Case	5

NORTON NORGRIP AIR FILE SHOE

The NorGrip Air File Shoe eliminates the need for clips. The quick-change backing positively locks and unlocks every time, for fast, easy-to-manage use of hook and loop file sheets.



DESCRIPTION	PART #
NorGrip Air File Shoe	636425 52835
Case	5

DEFINE THE JOB, THEN PICK THE PAD

Two profiles and two densities give you all the options you need for any sanding job.

Durable polyurethane foam on a fiberglass backing plate provides a consistent surface for a consistent finish. All pads are individually spin-balanced for better control and performance on all tools.

Each pad is protected by a sturdy, clam shell package ready for pegboard display.

A cap protects the threaded spindle and two washers are included for proper fit and spacing on any D/A tool.



Low Profile, Soft Density
For Medium To Fine Grit Sanding
(Soft, thicker foam for contours)
12,000 rpm



Low Profile, Medium Density
For Coarse to Medium Grit Sanding
(Hard edge)
15,000 rpm



Tapered Edge, Medium Density
For Coarse to Medium Grit Sanding (Flexible edge, easy to reach small contours)
15,000 rpm

SOFT / 320 AND FINER

MEDIUM / 320 AND COARSER

TAPERED / 320 AND COARSER

	SOFT / 320 AND FINER		MEDIUM / 320 AND COARSER		TAPERED / 320 AND COARSER	
	PSA	NORGRIP	PSA	NORGRIP	PSA	NORGRIP
	PART #	PART #	PART #	PART #	PART #	PART #
5" Plain Face	636425 06126	636425 06129	636425 06131	636425 06135	636425 06139	636425 06143
6" Plain Face	636425 06127	63642506130	63642506133	63642506137	63642506141	63642506145
5" Vacuum	—	—	636425 06132	636425 06136	636425 06140	636425 06144
6" Vacuum	—	—	636425 06134	636425 06138	636425 06142	636425 06146
Case	5	5	5	5	5	5

BOLD PART NUMBERS denote most popular sku's.

Pads have a riveted 5/16"-24 threaded spindle and are made with polyurethane foam with a fiberglass back plate.

All pads are packed 5 per case.

NORTON MULTI-AIR/MULTI-AIR CYCLONIC BACK-UP PADS

Innovative design for optimal air flow and powerful dust extraction. Medium pad 06160 has been engineered with a durable, heat-resistant plastic, a molded-in 5/16"-24 spindle, and longer hooks. Soft pad 60505 is packed with Festo adapter, two threaded bolts: M8 and 5/16"-24 and three fiber ring spacers. The soft pad is only for use on extreme contours using NorGrip 320 grit and finer.

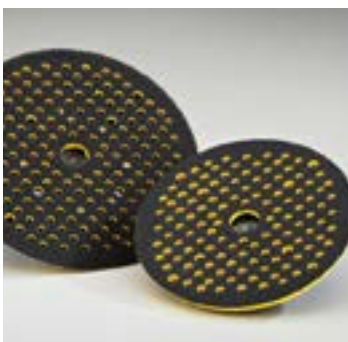

		5"	6"	6"	
		PART #	PART #	PART #	RPM
Norton Multi-Air Back-Up pad	Medium	666233 76000	636425 06160	—	15,000
	Soft	—	—	636425 60605	7,700
Pkg/Case		1/5	1/5	1	

Do not use the Soft Density pad with SoftTouch discs.

DESCRIPTION	PART #	PART #
Interface Pad	636425 85864	076607 19359
Pkg/Case	8/1	12/1



BACK-UP PADS

Designed for use with PSA and NorGrip discs.

DESCRIPTION	RPM	PART #
3" NorGrip	20,000	636425 06128
8" PSA	6,000	636425 43112
8" x 5/8"-11 NorGrip	4,800	636425 43704
8" VAC/Non-VAC NorGrip 5 Screw	1,500	636425 43712
8" VAC/Non-VAC NorGrip 6 Screw	1,500	636425 43714
Case		5
+Case		7



FOAM INTERFACE PADS

Designed for use with fine grit NorGrip sanding discs. Improves both surface finish and cut rate. Use with NorGrip Disc Back-Up Pads.

DESCRIPTION	THICKNESS	PART #	PART #	PART #
3" Thin NorGrip Pad	1/2"	636425 05457	—	—
6" Thin NorGrip Pad	1/2"	—	636425 42089	—
5" Foam Interface Pad	3/4"	—	—	636425 02161
6" Foam Interface Pad	3/4"	—	—	636425 02162
Pkg/Case		10/1	5/1	2/10



NORTON AVOS SPEED-LOK BACK-UP PADS

Durable back-up pads designed for rugged use. Always follow safety procedures and never exceed the rpm.



5" SPEED-LOK BACK-UP PAD

DESCRIPTION	SIZE	RPM	PART #
For Pistol Grips	3/8" -24	20,000	636425 03029
	7/16" -20	20,000	636425 03030
Standard	5/8" -11	13,000	636425 02517
Case			5



BACK-UP PADS FOR GRINDING DISCS

Discs are held in place by Retainer Nut # 63642543463.



	5" x 7/8"	7" x 7/8"	9-1/8" x 7/8"
GRIT	PART #	PART #	PART #
Medium	636425 43421	636425 43422	636425 43423
Firm	—	636425 43425	—
Case	1	1	1



PIN STRIPE REMOVAL WHEEL

This wheel is designed to remove pinstripes, decals and molding adhesive without damage to the underlying surface. Tan colored, it is 4" diameter, 5/8" thick with a 1/16" step and has a 5/16-24 attached threaded mandrel.

DESCRIPTION	RPM	PART #
4" x 5/8" x 5/16-24 Mandrel	4,000	636425 05624
3/8" Drill Adapter for #05624	—	636425 36135
Pkg/Case		1/5



NORTON TACK CLOTHS

A specially formulated soft cloth that effectively removes dust, dirt, and sanding residue. It contains no waxes or silicones, and is compatible with all paints. This cloth will not dry out and is always soft and tacky. It is spontaneous combustion proof, non-toxic and anti-static.

DESCRIPTION	PART #
Tack Cloth	076607 49008
Pkg/Case	12/12

POWER IN PARTNERSHIP

The Refinish Solutions Group delivers an integrated products and services network represented by Saint-Gobain while maintaining the product and technical expertise of the network partners. This unique alliance of industry leaders is committed to helping collision shops optimize their refinish processes and outcomes to improve shop profitability.

The ICAR training and operational best practices provided by the solutions group partners ensures your technicians are up-to-date with the latest technologies and process advancements. Refinishing operations that utilize our training and best practices can lower costs and boost critical CSI scores while improving procedural consistency of all technicians.

CORE COMPETENCIES

The Refinish Solutions Group manufacturers bring focused expertise and know-how to deliver a single, comprehensive refinishing solutions system to increase productivity, reduce cycle time, and improve quality.



METAL PANEL BONDING



PAINT PREPARATION



PAINT DEFECT REMOVAL



PLASTIC/COMPOSITE STRUCTURAL AND COSMETIC REPAIR



CONTAMINANT-FREE REFINISHING



CLEAN AND DETAIL



BODY PANEL SURFACE REPAIR



PAINT HANDLING AND ATOMIZATION



REVvive by RSG is a line of non-abrasive products designed to complement the brands featured under the Refinish Solutions Group umbrella.

REVvive by RSG Aerosols

REVvive by RSG Aerosols bring performance and quality together for the ideal spot repair solution.

Coatings

REVvive by RSG Coatings are ideal for restoring the original appearance in a cleaner, durable, corrosion-free solution that can be used on almost any surface.



E-COAT

- Super-durable coating provides outstanding corrosion protection
- Used as DTM primer or as a single coating to match the original OEM appearance
- Compatible with most basecoats
- Excellent adhesion over bare metal and paints and primers

DESCRIPTION	COLOR	PART #	SIZE	CASE
e-Coat	Black	666233 91015	12.6 oz	6
e-Coat	Grey	666233 91016	12.7 oz	6
e-Coat	Olive Green	666233 91017	12.8 oz	6
e-Coat	Light Green	666233 91018	12.7 oz	6
e-Coat	Tan	666233 91019	12.9 oz	6



SUBSTRATES:

Can be applied to prepared OEM-painted surfaces, aluminum, bare steel, galvanized, SMC, fiberglass, and polyester body filler.



DRY GUIDE COAT

- Identify surface defects when sanding fillers or primers
- Convenient aerosol application provides no waste and clean-up
- Dries instantly
- Does not clog abrasives
- Use when dry or wet sanding

DESCRIPTION	COLOR	PART #	SIZE	CASE
Dry Guide Coat	Black	666233 91008	10.9 oz	6



SUBSTRATES:

Can be applied to prepared OEM-painted surfaces, fiberglass, and polyester body filler.



TRIM BLACK

- Restores trim back to original condition
- No adhesion promoter required
- Excellent coverage
- Maintains flexibility

DESCRIPTION	PART #	SIZE	CASE
Satin Trim Black	666233 91013	10.9 oz	6
Matte Trim Black	666233 91014	11 oz	6



SUBSTRATES:

Can be applied to prepared OEM-painted surfaces, lightly abraded E-Coat, TPO, EDPM, and polypropylene.

Primers

REVvive by RSG present a full line of Primers with exceptional adhesion and corrosion protection in an easy-to-sand, fast drying solution for all repairs.



WELD-THRU PRIMER

- Excellent adhesion
- High concentration of zinc or copper for greater corrosion protection
- Superior conductivity while Resistance Spot, MIG and TIG welding
- Fast drying for maximum efficiency

DESCRIPTION	PART #	SIZE	CASE
Zinc Weld-Thru Primer	666233 91000	12.5 oz	6
Copper Weld Thru Primer	666233 91001	12.5 oz	6



SUBSTRATES:

Can be applied direct to metal, galvanized steel and aluminum.



HIGH BUILD PRIMER

- Fills uneven surfaces prior to top coating
- Ideal for spot repairs
- Includes 2 nozzles - flat fan and round for versatility in film build
- Easy to sand

DESCRIPTION	COLOR	PART #	SIZE	CASE
High Build Primer	Gray	666233 91007	12 oz	6



SUBSTRATES:

Can be applied directly to metal, prepared OEM painted surfaces, aluminum, galvanized steel, SMC, fiberglass, lightly abraded e-Coat, polyester body fillers, GRP.



UNIVERSAL PRIMER

- Direct adhesion to both metal and flexible plastics
- Fast drying and easy to sand- ideal for small rub through areas and localized repairs
- No adhesion promoter or etch primer required
- Can be top-coated with most water or solvent based paints

DESCRIPTION	COLOR	PART #	SIZE	CASE
Universal Primer	Gray	666233 91003	11.2 oz	6



SUBSTRATES:

Can be applied to prepared OEM-painted surfaces, Aluminum, galvanized steel, directly on to metal, SMC, Fiberglass, lightly abraded E-Coat, TPO, EDPM, polypropylene.



ACID ETCH PRIMER

- One-step etch and prime formula prevents corrosion and promotes paint adhesion
- For use priming bare metal surfaces
- Ideal for rub-throughs
- No sanding required- can be directly top-coated

DESCRIPTION	COLOR	PART #	SIZE	CASE
Acid Etch Primer	Gray	66623391010	12.9 oz	6



SUBSTRATES:

Can be applied to fully cured paint, Aluminum, galvanized & zinc-coated steel, bare steel, polyester body fillers, GRP.

Cleaners

Cleaners from REVvive by RSG eliminate contaminants on all surfaces for a completely clean finish.



SURFACE DEGREASER

- Anti-silicone degreaser
- Wipes clean without leaving surface residue
- Fast evaporating and ideal for spot repairs
- Use on bare metal and painted surfaces

DESCRIPTION	PART #	SIZE	CASE
Surface Degreaser	666233 91009	9.9 oz	6



SUBSTRATES:

Direct to metal, prepared OEM paint surfaces, aluminum, galvanized, SMC, fiberglass, lightly abraded E-Coat.

CCS FOAM WAFFLE PADS

REVvive by RSG pads have a unique CCS waffle design that resolves the common problems of the traditional waffle.

Benefits of CCS Design

- Slower rate of absorption enhancing polish performance
- Gradually releases compound as needed by the operator enhancing pad and compound performance
- Reduces surface contact resulting in less friction generated heat
- Diminishes surface friction allowing operator to run pad flat preventing skipping

Three Proven Professional Foam Formulations:

- White Cutting Foam— for removing sanding scratches, deep scratches, oxidation, and weathered paint
- Black Polishing Foam— to remove light swirl marks
- Blue Finishing Foam— for use with a final polish or glaze to create exceptional shine



SINGLE-SIDED PADS

REVvive BY RSG Single-Sided Pad has a beveled edge design to allow access under trim and improve user control. The recessed back provides accurate alignment for balance and protects against backing plate contact.

Back-Up Plate

The REVvive BY RSG back-up plate is intended for use with the REVvive BY RSG single-sided foam pads.

DESCRIPTION	PART #	CASE
8" Single-Sided CCS Waffle Foam Pad - White	666233 91306	6
8" Single-Sided CCS Waffle Foam Pad - Black	666233 91307	6
8" Single-Sided CCS Waffle Foam Pad - Blue	666233 91308	6
Back-up Plate	666233 91314	6



DOUBLE-SIDED PADS

REVvive BY RSG Double-Sided Pad has a highly engineered center plate designed to minimize pad hop or chatter with the perfect amount of flexibility when buffing contours.

Wool Pad

The REVvive BY RSG Double-Sided Wool Pad is a 100% steamed and twisted white wool designed to eliminate severe swirls, scratches or heavy oxidation from sanded or wet sanded refinished paint surfaces.

DESCRIPTION	PART #	CASE
8" Double-Sided CCS Waffle Foam Pad - White	666233 91310	6
8" Double-Sided CCS Waffle Foam Pad - Black	666233 91311	6
8" Double-Sided CCS Waffle Foam Pad - Blue	666233 91312	6
Double-Sided Pad Adapter	666233 91313	6
8" Double-Sided Cutting Wool Pad	666233 91309	6



For the best finish, get the best start.

For more than 50 years, the American name has been recognized for innovative and high-quality tape. Proudly made in the USA by Intertape Polymer Group, American brand tapes are engineered from quality materials designed to withstand heat, solvents and waterborne materials typical of refinishing operations.

TECH TIP

American Brand Masking Tape has a 12 month shelf life from date of manufacture.



AMERICAN® BRAND ORANGE MASK®

American® brand Orange Mask® (OM) is a high performance masking tape developed to provide superior adhesion, UV resistance for up to 3 days. OM fine crepe paper backing unwinds and applies smoothly and removes cleanly to deliver clean crisp paint lines. Resistant to temperatures up to 250°F (121°C) for 30 minutes. Excellent adhesion to backing when layered. Stain resistant; resists bleed-through. Superior for wet sanding applications and resists paint flaking.

54.8M (60YD) ROLL

DESCRIPTION	PART #	CASE
6mm (.25in)	08714300579	38
12mm (.50in)	08714300577	72
18mm (.70in)	08714300306	48
24mm (.94in)	08714300307	36
36mm (1.41in)	08714300308	24
48mm (1.88in)	08714300309	24
72mm (2.83in)	08714300690	16



AMERICAN® BRAND PG

American® brand PG is a high quality masking tape with good quick stick and holding properties and excellent cornering. PG is designed for clean and easy removal from a variety of hot or cold surfaces. UV resistance for 3 days. PG fine crepe paper backing unwinds and applies smoothly and removes cleanly to deliver crisp paint lines. Resistant to temperatures up to 250°F (121°C) for 30 minutes. Excellent adhesion to backing when layered. Stain resistant; resists bleed-through. Superior for wet sanding applications and resists paint flaking.

54.8M (60YD) ROLL

DESCRIPTION	PART #	CASE
6mm (.25in)	08714300587	36
12mm (.50in)	08714300586	72
18mm (.70in)	08714300310	48
24mm (.94in)	08714300311	36
36mm (1.41in)	08714300312	24
48mm (1.88in)	08714300313	24
72mm (2.83in)	08714300581	16



AMERICAN® BRAND AM

American® brand AM is the cost-effective solution designed for clean and easy removal. UV resistance for 3 days. AM tape has a controlled unwind, is good for cornering and is resistant to temperatures up to 225°F (107°C) for 30 minutes. Excellent adhesion to backing when layered. Stain resistant; resists bleed-through and resists paint flaking. Superior for wet sanding applications.

54.8M (60YD) ROLL

DESCRIPTION	PART #	CASE
18mm (.70in)	08714300314	48
24mm (.94in)	08714300315	36
36mm (1.41in)	08714300316	24
48mm (1.88in)	08714300317	24
72mm (2.83in)	08714300580	16



AMERICAN® BRAND MP

Capable of withstanding oven temperatures up to 250°F (121°C) for one hour, MP provides higher temperature resistance versus most general purpose masking tapes. MP provides controlled unwind, good cornering, excellent adhesion to backing when layered, and is superior for wet sanding and resists paint flaking. MP is also UV resistant for up to 3 days with clean removal. Moisture and stain resistant, its specially designed adhesive sticks firmly and securely to most surfaces and removes cleanly.

54.8M (60YD) ROLL

DESCRIPTION	PART #	CASE
18mm (.70in)	087143 00499	48
24mm (.94in)	087143 00500	36
36mm (1.41in)	087143 00501	24
48mm (1.88in)	087143 00502	24



AMERICAN® BRAND UG

An economical, yet very reliable masking tape to meet the needs of most collision repair and refinish shops. UG offers an excellent balance of quick stick, panel adhesion and holding properties. Under normal temperature conditions, UG is the tape of choice for fast, basic service, including wet-stripping. UG provides good cornering, temperature resistance up to 175°F (80°C) for 30 minutes, UV resistance for up to 3 days, excellent adhesion to backing when layered, controlled unwind, clean removal; stain resistant; resists bleed-through and resists paint flaking.

50M ROLL

DESCRIPTION	PART #	CASE
18mm (.70in)	077922 88400	48
24mm (.94in)	077922 88401	36
36mm (1.41in)	077922 88402	24
48mm (1.88in)	077922 88403	24



AMERICAN® BRAND GT

American® Brand GT masking tape is the newest, most cost effective masking tape specifically designed to perform in the automotive refinishing market. American brand GT is capable of withstanding oven temperatures up to 225°F (107°C) for one hour with clean removal. GT provides excellent adhesion to a multitude of surfaces and is formulated to ensure a secure bond to the surface and to prevent lifting or overspray. The flexible backing ensures that you will be able to conform around any surface!

54.8M ROLL

DESCRIPTION	PART #	CASE
18mm (.70in)	077922 00552	48
24mm (.94in)	077922 00553	36
36mm (1.41in)	077922 00554	24
48mm (1.88in)	077922 00555	24



AMERICAN® BRAND FM35 BLUE FINE LINE

The American® brand FM35 fine line tape offers superior conformability, secure laydown and consistently straight lines. The fine line FM35 tape is ideal for detailed design work, striping, two-tone paint schemes and masking around critical areas such as headlights. The FM35 is preferred for medium to high temperature applications, where a sharp fine line is required including composite and fiberglass (gelcoat) fabrication. It's designed to offer a high degree of conformability, solvent-resistance, and is waterproof with an operating temperature range of 40°F to 280°F (4.4°C to 138°C). From basic paint jobs to detailed designs, American® brand FM35 fine line masking tape is your solution!

32.9M (36YD) ROLL

DESCRIPTION	PART #	CASE
3.17mm (1/8in)	66261 182688	15
6.35mm (1/4in)	66261 182686	14
12.7mm (1/2in)	66261 182685	13



AMERICAN® BRAND PREMIUM MASKING FILM FEATURING PG21 MASKING TAPE

Stain resistant, temperature resistant, PG21 paper masking tape combined with strong, corona-treated HDPE film for industrial, marine and automotive painting. The solvent and moisture resistant film permits worry-free wet sanding preparation and allows for easy cornering and masking of curved surfaces. Repositionable, heat resistant rubber based pressure-sensitive adhesive provides a secure hold to and clean removal from most surfaces in both warm and cold environments. Film is pre-taped and pre-folded for easy use. One person can apply then extend the film to desired length to protect surfaces, reducing masking time and waste.

35M (115FT) ROLL

DESCRIPTION	PART #	CASE
533mm (21in)	699573 18100	40
1093mm (43in)	699573 18101	20
1830mm (72in)	699573 18102	20
3050mm (120in)	699573 18103	12



Crash Tested. OEM Approved.

Fusor's product line is known for its innovative OEM approved products and expertise in providing collision repair adhesive solutions. Fusor's leading adhesives, sealers and plastic repair solutions combined with the product portfolio and strong sales team of the Refinish Solutions Group provide you with a one-stop, comprehensive refinishing solutions system to increase productivity, reduce cycle time, and improve quality.

PART #	DESCRIPTION	WORK TIME	HANDLING / CLAMP TIME	PAINT TIME	FULL CURE	SUBSTRATES	CHEMISTRY	COLOR
80849810035 80849810007	Fusor 110B/111B Metal Bonding Adhesive (Fast)	5 min	Immediately when mechanically fastened / 20 min	–	2 hours	Steel and aluminum	Acrylic 2K	Green
80849810005 80849810006	Fusor 108B/109B Metal Bonding Adhesive (Med.)	40 min	Immediately when mechanically fastened / 2 hours	–	4 hours	Steel and aluminum	Acrylic 2K	Green
80849810036 80849810008	Fusor 112B/113B Metal Bonding Adhesive (Slow)	70 min	Immediately when mechanically fastened / 3 hours	–	8 hours	Steel and aluminum	Acrylic 2K	Gray
80849810175	Fusor 208B Panel Bonding Adhesive (Slow)	90 min	Immediately when mechanically fastened / 4 hours / 30 min @ 140°F (60°C)	Immediately	24 hours / 1 hour @ 140°F (60°C)	Steel, aluminum and SMC/FRP	Epoxy 2K	Gray
80849810172	Fusor 2098 Crash Durable Structural Adhesive (Slow)	90 min	Immediately when mechanically fastened / 6 hours / 30 min @ 140°F (60°C)	24 hours / 30 min @ 140°F (60°C)	24 hours / 2 hours @ 140°F (60°C)	Steel, aluminum, FRP	Epoxy 2K	Blue

Technical data reported @ 70°F (21°C) unless noted.



METAL BONDING ADHESIVE (FAST) | BARE METAL

Applications: Patch panel bonding and weld bonding of properly prepared dissimilar metals, cab corners, panel sections and aluminum trailer repair patches

Features & Benefits:

- Fast cure
- No welding required
- Guaranteed corrosion protection

OEM Approvals:

GM: Panel bonding per GM aftermarket spec GM6449G
Nissan: Patch panel and corrosion repair
Mazda: Corrosion repair
Ford: Weld and rivet bonding
Honda: In-plant repair

SIZE	COLOR	FUSOR #	PART #	CASE
7.6 oz (225 mL)	Green	110B	80849810035	6
1.7 oz (50 mL)	Green	111B	80849810007	12





METAL BONDING ADHESIVE (MEDIUM) | BARE METAL

Applications: Panel bonding, weld and rivet bonding of quarter panels, rear body panels, roof panels, door skins, van side panels and outer truck bed panels

Features & Benefits:

- 6 to 8times faster than epoxy or urethane panel bonders
- No welding required
- Guaranteed corrosion protection
- Can be riveted and resistance welded

OEM Approvals:

GM: Panel bonding per GM aftermarket spec GM6449G
Mazda, Nissan: Corrosion repair
Ford: Weld and rivet bonding
Honda: Collision repair

SIZE	COLOR	FUSOR #	PART #	CASE
7.6 oz (225 mL)	Green	108B	808498 10005	6
1.7 oz (50 mL)	Green	109B	808498 10006	12



METAL BONDING ADHESIVE (SLOW) | BARE METAL

Applications: Panel bonding, weld and rivet bonding of quarter panels, rear body panels, roof panels, door skins, van side panels and outer truck bed panels

Features & Benefits:

- Long open time for large panel replacement
- Ideal for hot temperature conditions
- Guaranteed corrosion protection
- Can be riveted and resistance welded

OEM Approvals:

Chrysler: Weld bonding. Meets aftermarket metal bonding spec MSCD507
Honda: Collision repair

SIZE	COLOR	FUSOR #	PART #	CASE
7.6 oz (225 mL)	Gray	112B	808498 10036	6
1.7 oz (50 mL)	Gray	113B	808498 10008	12



PANEL BONDING ADHESIVE (SLOW) | BARE METAL

Applications: Metal and plastic panel bonding, weld and rivet bonding of quarter panels, rear body panels, roof panels, door skins, van side panels and outer truck bed panels

Features & Benefits:

- Paint and sand with no need to remove adhesive squeeze out
- No odor
- Bonds plastic, e-coat and bare metals
- Excellent corrosion protection

OEM Approvals:

Honda: Collision repair

SIZE	COLOR	FUSOR #	PART #	CASE
10.1 oz (300 mL)	Gray	208B	808498 10175	6



CRASH DURABLE STRUCTURAL ADHESIVE (SLOW) | BARE METAL

Applications: Metal and plastic panel bonding, weld and rivet bonding of replacement structural and non-structural auto body panels

Features & Benefits:

- Higher impact strength performance
- Lifetime corrosion protection
- Versatile and easy to use
- Bonds plastic, e-coat and bare metals
- Weld immediately

OEM Approvals:

Fiat, GM, PSA Peugeot, Tesla,
Honda: Collision Repair

SIZE	COLOR	FUSOR #	PART #	CASE
6.59 oz (195 mL)	Blue	2098	808498 10172	6

Use Fusor 420 Mixing Tip.

PART #	DESCRIPTION	WORK TIME	CLAMP TIME	SAND TIME	PAINT TIME	SUBSTRATES	CHEMISTRY	COLOR
808498 10168 808498 10169	Fusor 132/133 Plastic Repair Adhesive (Super Fast)	1 min	10 min	10 min	10 min	All types of plastic, SMC or fiberglass, ecoat, primed, painted metals	Urethane 2K	Black
808498 10029 808498 10030	Fusor 142/143 Plastic Repair Adhesive (Fast)	1 min	10 min	20 min	30 min	All plastic bumpers, SMC or fiberglass panels, ecoat, primed and painted metals	Urethane 2K	Black
808498 10106 808498 10107	Fusor 152/153 Plastic Repair Adhesive (Medium)	3 min	30 min / 5 min at 140°F (60°C)	90 min / 3 min at 140°F (60°C)	2 hours / 60 min with heat cure	All plastic bumpers, SMC or fiberglass panels, ecoat, primed, painted metals	Urethane 2K	Black
808498 10167 808498 10166	Fusor 114LG/114SM Plastic Finishing Adhesive (Fast)	2 min	–	20 min	60 min	Finishing adhesive for all plastics including PP, fiberglass, Metton®, Telene®, SMC, TEO, urethane and carbon fiber	Epoxy 2K	Red
808498 10049	Fusor 102 Plastic Cosmetic Repair Adhesive (Fast)	2 min	–	20 min	60 min	Repair scratches and gouges on rigid plastics, SMC, fiberglass and GTX	Epoxy 2K	Beige
808498 10043 808498 10001	100EZ/101EZ Plastic Repair Adhesive (Heat Set)	40 min		10 min @ 180°F (82°C)	60 min @ 180°F (82°C)	All types of rigid body plastics such as SMC, GTX, fiberglass, Metton® and carbon fiber	Epoxy 2K	Beige
808498 10034 808498 10015	Fusor 141/140 Clear Plastic Bonding Adhesive (Fast)	1 min	5 min	30 min	30 min	Plastics, primed and painted metals, glass, wood and other surfaces	Urethane 2K	Clear
808498 10042 808498 10016	Fusor 147/148 Plastic Bonding Adhesive (Medium)	5 min	90 min / 15 min @ 140°F (60°C)	–	90 min / 15 min @ 140°F (60°C)	SMC, fiberglass, carbon fiber and other plastics to itself and primed metal	Urethane 2K	Brown
808498 10039	Fusor 127EZ Plastic Bonding Adhesive (Slow)	50 min	4 hours / 30 min @ 140°F (60°C)	–	4 hours / 30 min @ 140°F (60°C)	SMC, fiberglass, carbon fiber and other plastics to itself and primed metal	Urethane 2K	Off White
808498 10165	Fusor 120/T20 Composite Adhesive (Slow)	45 min	4 hours / 20 min @ 180°F (82°C)	60 min @ 180°F (82°C)	60 min @ 180°F (82°C)	Plastics, SMC and fiberglass to itself and primed metals	Epoxy 2K	Gray
808498 10038	Fusor T21 Composite Adhesive (Slow)	45 min	4 hours / 15 to 20 min @ 180°F (82°C)	60 min @ 180°F (82°C)	60 min @ 180°F (82°C)	Plastics, SMC and fiberglass to itself and primed metals	Epoxy 2K	Gray
808498 10060	Fusor T19 Truck Plastic Bonding Adhesive (Super Fast)	3 min	30 min / 10 min @ 140°F (60°C)	–	–	SMC, fiberglass, carbon fiber and other plastics to itself and to primed metal	Urethane 2K	Beige
808498 10050	Fusor T22 Truck Plastic Bonding Adhesive (Fast)	5 min	60 min / 15 min @ 140°F (60°C)	–	–	SMC, fiberglass, carbon fiber and other plastics to itself and to primed metal	Urethane 2K	Beige
808498 10033	Fusor T23 Truck Plastic Bonding Adhesive (Medium)	20 min	3 hours / 22 min @ 140°F (60°C)	–	–	SMC, fiberglass, carbon fiber and other plastics to itself and to primed metal	Urethane 2K	Beige

Technical data reported @ 70°F (21°C) unless noted.



PLASTIC REPAIR ADHESIVE (SUPER FAST) | SANDABLE

Applications: Structural and cosmetic repair of bumpers, bumper tabs, emblems and door trims, interior and exterior plastic repairs, cosmetic repairs

Features & Benefits:

- No need for plastic identification with use of Fusor 602EZ
- Sand and paint in 10 minutes
- Faster than plastic welding
- Stronger than stapling
- One product for all plastic repairs
- Undetectable feather edge

OEM Approvals:

GM, Ford, Chrysler: Collision/warranty repair
Honda: Collision repair

SIZE	COLOR	FUSOR #	PART #	CASE
10.1 oz (300 mL)	Black	132	808498 10168	6
1.7 oz (50 mL)	Black	133	808498 10169	12



PLASTIC REPAIR ADHESIVE (FAST) | SANDABLE

Applications: Structural and cosmetic repair of bumpers, bumper tabs, emblems and door trims, interior and exterior plastic repairs, cosmetic repairs

Features & Benefits:

- Urethane chemistry for all structural and cosmetic repairs on bumpers
- Undetectable feather edge
- Sandable in minutes
- No need for plastic identification with use of Fusor 602EZ

OEM Approvals:

GM, Ford: Collision/warranty repair
Honda: Collision repair

SIZE	COLOR	FUSOR #	PART #	CASE
10.1 oz (300 mL)	Black	142	808498 10029	6
1.7 oz (50 mL)	Black	143	808498 10030	12



PLASTIC REPAIR ADHESIVE (MEDIUM) | SANDABLE

Applications: Structural and cosmetic repair of bumpers, bumper tabs, emblems and door trims, interior and exterior plastic repairs, cosmetic repairs

Features & Benefits:

- Enough work time for larger repairs; ideal for hot temperature conditions
- Urethane chemistry for all structural and cosmetic repairs on bumpers
- Undetectable feather edge
- Sandable in minutes
- No need for plastic identification with use of Fusor 602EZ
- On demand cure with heat

OEM Approvals:

GM: Meets plastic bonding/sealing specs
Ford: In-plant repair
Honda: Collision repair

SIZE	COLOR	FUSOR #	PART #	CASE
10.1 oz (300 mL)	Black	152	808498 10106	6
1.7 oz (50 mL)	Black	153	808498 10107	12



PLASTIC FINISHING ADHESIVE (FAST) | SANDABLE

Applications: Finishing adhesive for cosmetic repair of all plastic bumpers and body panels

Features & Benefits:

- No plastic identification is required
- No adhesion promoters needed
- Epoxy formula sands to a perfect feather edge in 20 minutes or less
- Use with or without mixing tip

OEM Approvals:

GM, Chrysler: Collision repair including carbon fiber
Honda: Collision repair

SIZE	COLOR	FUSOR #	PART #	CASE
10.1 oz (300 mL)	Red	114LG	808498 10167	6
1.7 oz (50 mL)	Red	114SM	808498 10166	12



PLASTIC COSMETIC REPAIR ADHESIVE (FAST) | SANDABLE

Applications: Cosmetic repair of scratches and gouges on body panels, hoods, decks and doors

Features & Benefits:

- Sands easily without loading sandpaper
- No bull's-eyes, read-throughs or halos

OEM Approvals:

Volvo: Composite repair

SIZE	COLOR	FUSOR #	PART #	CASE
10.1 oz (300 mL)	Beige	102	808498 10049	6



PLASTIC REPAIR ADHESIVE (HEAT SET) | SANDABLE

Applications: Structural and cosmetic repair of auto and heavy duty truck composite, fiberglass, SMC and carbon fiber panels

Features & Benefits:

- One product for all body panels
- Easily sands to a feather edge to provide undetectable repairs
- No bull's-eyes, read-throughs or halos

OEM Approvals:

Ford: Collision/warranty repair
GM, Chrysler: Collision/ warranty repair including carbon fiber
Nissan: Warranty repair
Volvo: Composite repair

SIZE	COLOR	FUSOR #	PART #	CASE
10.1 oz (300 mL)	Beige	100EZ	808498 10043	6
1.7 oz (50 mL)	Beige	101EZ	808498 10001	12

Use Fusor 702 Fiberglass Cloth.



CLEAR PLASTIC BONDING ADHESIVE (FAST) | SANDABLE

Applications: Rebuild bumper and headlight tabs, bond emblems, body side moldings, plastic backer panels, decorative vents, wheel opening moldings, rear wind deflectors and ground effects

Features & Benefits:

- Clear urethane, non-yellowing structural adhesive
- Fast cure
- High-strength, flexible bond

OEM Approvals:

Honda: Collision repair

SIZE	COLOR	FUSOR #	PART #	CASE
10.1 oz (300 mL)	Clear	141	808498 10034	6
1.7 oz (50 mL)	Clear	140	808498 10015	12



PLASTIC BONDING ADHESIVE (MEDIUM) | SANDABLE

Applications: Installation and bonding of small body panels, spoilers, ground effects and headlight buckets

Features & Benefits:

- High-strength structural adhesive
- Easy to gun, urethane non-sag formula
- Provides faster cure time for smaller interior and exterior parts

OEM Approvals:

Chrysler: SMC bonding TSBS; Windnoise sealing TSBS
Ford, GM, Honda: Meets SMC bonding specs; SMC bonding TSBS
Honda: Collision repair

SIZE	COLOR	FUSOR #	PART #	CASE
10.1 oz (300 mL)	Brown	147	808498 10042	6
1.7 oz (50 mL)	Brown	148	808498 10016	12



PLASTIC BONDING ADHESIVE (SLOW) | SANDABLE

Applications: Plastic body panels, spoilers and ground effects; excellent for cab extenders, wood and other surfaces

Features & Benefits:

- High-strength urethane structural adhesive
- Provides enough work time for bonding large primed metal or plastic parts
- Easy to gun, non-sag formula

OEM Approvals:

GM: Plastic bonding per GM6448G aftermarket spec

SIZE	COLOR	FUSOR #	PART #	CASE
10.1 oz (300 mL)	Off White	127EZ	808498 10039	6



COMPOSITE ADHESIVE (SLOW) | STRUCTURAL/SANDABLE

Applications: Bonding of fairings, body panels, spoilers, ground effects, wind deflectors, roofs and fender liners; repairs cracks, punctures and tears

Features & Benefits:

- One product bonds and finishes all plastic panels
- OEM epoxy formula
- Great for heavy-duty truck repair
- High strength
- Excellent gap-filling properties

OEM Approvals:

GM: Plastic bonding and warranty repair per GM6448G aftermarket spec
Ford, Paccar, Navistar, Peterbilt, Kenworth, Mack, Volvo: Warranty and collision repair

SIZE	COLOR	FUSOR #	PART #	CASE
12.8 oz (380 mL)	Gray	120/T20	808498 10165	6

Use Fusor 420 Mixing Tip.



COMPOSITE ADHESIVE (SLOW) | SANDABLE

Applications: Bonding of fairings, body panels, spoilers, ground effects, wind deflectors, roofs and fender liners; repairs cracks, punctures and tears

Features & Benefits:

- One product bonds and finishes all plastic panels
- OEM epoxy formula
- Great for heavy-duty truck repair
- High strength
- Excellent gap-filling properties

OEM Approvals:

GM: Plastic bonding and warranty repair per GM6448G aftermarket spec
Ford, Paccar, Navistar, Peterbilt, Kenworth, Mack, Volvo: Warranty and collision repair

SIZE	COLOR	FUSOR #	PART #	CASE
10.1 oz (300 mL)	Gray	T21	808498 10038	6

Use Fusor 420 Mixing Tip.



TRUCK PLASTIC BONDING ADHESIVE (SUPER FAST) | STRUCTURAL

Applications: Installation of hood panels, roof panels, fenders, fender liners, fairings, spoilers, wind deflectors, cab extenders, ground effects, headlamp buckets and other body panels

Features & Benefits:

- Easy to gun, non-sag formula
- Substantially stronger than conventional adhesives

SIZE	COLOR	FUSOR #	PART #	CASE
10.1 oz (300 mL)	Beige	T19	808498 10060	6



TRUCK PLASTIC BONDING ADHESIVE (FAST) | STRUCTURAL

Applications: Installation of hood panels, roof panels, fenders, fender liners, fairings, spoilers, wind deflectors, cab extenders, ground effects, headlamp buckets and other body panels

Features & Benefits:

- Easy to gun, non-sag formula
- Substantially stronger than conventional adhesives

SIZE	COLOR	FUSOR #	PART #	CASE
10.1 oz (300 mL)	Beige	T22	808498 10050	6



TRUCK PLASTIC BONDING ADHESIVE (MEDIUM) | STRUCTURAL

Applications: Installation of hood panels, roof panels, fenders, fender liners, fairings, spoilers, wind deflectors, cab extenders, ground effects, headlamp buckets and other body panels

Features & Benefits:

- Easy to gun, non-sag formula
- Substantially stronger than conventional adhesives

OEM Approvals:

Peterbilt, Kenworth: Warranty and collision repair

SIZE	COLOR	FUSOR #	PART #	CASE
10.1 oz (300 mL)	Beige	T23	808498 10033	6

PART #	DESCRIPTION	WORK TIME	SKIN TIME	FULL EXPANSION	SAND TIME	PAINT TIME	SUBSTRATES	CHEMISTRY	COLOR
808498 10041 808498 10037	Fusor 123/126 Non-Sag Seam Sealer (Fast)	3 min	–	–	–	10 minutes or within 24 hours without a scuff	Bare or coated metal, SMC and fiberglass, and over 2K primer	Urethane 2K	White
808498 10045 808498 10013	Fusor 123EZ/126EZ Non-Sag Seam Sealer (Medium)	10 min	–	–	30 min	30 min	Apply over 2K primer	Epoxy 2K	Blue
808498 10179 808498 10180	Fusor 123SL/126SL Non-Sag Seam Sealer (Slow)	45 min	–	–	–	10 min or within 24 hours without a scuff	Bare or coated metal, SMC and fiberglass, and over 2K primer	Urethane 2K	White
808498 10149	Fusor 019 Bare Metal Brushable Seam Sealer (Medium)	6 min	–	–	10 min	10 min (Paint within 24 hours)	Bare metal	Acrylic 2K	Green
808498 10075	Fusor 129 Controlled Flow Seam Sealer (Fast)	5 min	–	–	30 min	30 min	Bare or coated metal, SMC and fiberglass, and over 2K primer	Epoxy 2K	Beige
808498 10010	Fusor 122EZ Self-Leveling Seam Sealer (Medium)	8 min	–	–	30 min	30 min	Apply over 2K primer	Epoxy 2K	Blue
808498 10170 808498 10171	Fusor 800DTM/803DTM Direct-To-Metal Adhesive/Sealant	–	25 min, 50% RH	–	–	Immediately or up to 30 days without a scuff	Bare or coated metal, SMC and fiberglass, and over 2K primer	Silane Terminated Polymer 1K	Neutral/ Black
808498 10158 808498 10159 808498 10160 808498 10161	Fusor 802HD/804HD/ 805HD/806HD High Definition Sprayable Sealer	–	20 min, 50% RH	–	–	Immediately or up to 30 days without a scuff	Bare or coated metal, SMC and fiberglass, and over 2K primer	Silane Terminated Polymer 1K	White/Gray/ Black/Beige
808498 10058 808498 10011	Fusor 121/124 Flexible Foam (Super Fast)	10 seconds	–	3 min	–	10 min	Apply over 2K primer	Urethane 2K	Black
808498 10129	Fusor 130 Rigid Foam (Super Fast)	25 seconds	–	4 min	–	10 min	Apply over 2K primer	Urethane 2K	Beige
666233 90998 666233 90999	FUSOR 231/234 Sound Dampening Material (Slow)	60 min	–	24 hours	–	–	Bare or coated metal, SMC and fiberglass, and over 2K primer	Urethane 2K	Black

Technical data reported @ 70°F (21°C) unless noted.



NON-SAG SEAM SEALER (FAST) | FULL BODIED

Applications: Duplicates factory look on the following seams: truck beds, tooled door skin, floor pan, core support and any other application in which a non-sag cosmetic seam sealer is required and where fast work time is desired

Features & Benefits:

- Duplicates factory appearance
- Gets the job done in 10 minutes
- Bright white color
- Can be used without primer

OEM Approvals:

Honda: Collision repair

SIZE	COLOR	FUSOR #	PART #	CASE
10.1 oz (300 mL)	White	123	808498 10041	6
1.7 oz (50 mL)	White	126	808498 10037	12



NON-SAG SEAM SEALER (MEDIUM) | FULL BODIED

Applications: Duplicates factory look on the following seams: truck beds, tooled door skin, floor pan, core support and any other application in which a non-sag cosmetic seam sealer is required and where longer work time is desired

Features & Benefits:

- Duplicates factory appearance
- Longer work time
- Sandable

OEM Approvals:

GM, Ford: Collision/warranty repair
Honda: Collision repair

SIZE	COLOR	FUSOR #	PART #	CASE
10.1 oz (300 mL)	Blue	123EZ	808498 10045	6
1.7 oz (50 mL)	Blue	126EZ	808498 10013	12



NON-SAG SEAM SEALER (SLOW) | FULL BODIED

Applications: Duplicates factory look on the following seams: truck beds, tooled door skin, floor pan, core support and any other application requiring a longer work time, non-sag cosmetic seam sealer, or where high ambient temperatures are encountered

Features & Benefits:

- Duplicates factory appearance
- Longer work time
- Bright white color

OEM Approvals:

Honda: Collision repair

SIZE	COLOR	FUSOR #	PART #	CASE
10.1 oz (300 mL)	White	123SL	808498 10179	6
1.7 oz (50 mL)	White	126SL	808498 10180	12



BARE METAL BRUSHABLE SEAM SEALER (MEDIUM) | BARE METAL SEALER

Applications: Truck bed seams, tooled door skin seams, floor pan seams, core support seams and other applications where bare metal, brushable cosmetic seam sealer is required

Features & Benefits:

- Reduces cycle time
- Acrylic formula provides corrosion protection
- Perfect match to OEM brushed appearance

OEM Approvals:

Chrysler: Collision/warranty repair
Honda: Collision repair

SIZE	COLOR	FUSOR #	PART #	CASE
7.6 oz (225 mL)	Green	019	808498 10149	6



CONTROLLED FLOW SEAM SEALER (FAST) | CONTROLLED FLOW

Applications: Excellent for roof channels, door seams, drip rails and truck bed floor seams and trunk seams

Features & Benefits:

- Epoxy formula provides smooth continuous beads with no gun lines
- No tooling required for factory look
- Sandable
- Can be used with or without primer

OEM Approvals:

Chrysler: Collision/warranty repair
GM: Used for in-plant repair
Honda: Collision repair

SIZE	COLOR	FUSOR #	PART #	CASE
10.1 oz (300 mL)	Beige	129	808498 10075	6



SELF-LEVELING SEAM SEALER (MEDIUM) | FLOWABLE

Applications: Drip rails, trunks, core support to aprons, roof seams and quarter panel to rear deck

Features & Benefits:

- Perfectly matches factory flow-grade seams
- No tooling required
- Permanently flexible
- Sandable
- Color changes to indicate cure

OEM Approvals:

Ford: Collision/warranty repair per roof ditch sealing requirements
Honda: Collision repair

SIZE	COLOR	FUSOR #	PART #	CASE
10.1 oz (300 mL)	Blue	122EZ	808498 10010	6



SOUND DAMPENING MATERIAL (SLOW)

Applications: Sound dampening and sealing of: roof bows and roof skin, door skin and intrusion beam, quarter panel and inner structure, hoods and deck lids to inner structure. Ideal for overhead and vertical applications where a non-sag material is required.

Features & Benefits:

- Matches OEM performance
- Flexible seal with no shrinkage or read-through; non-expanding
- Extended work time for large applications
- Non-sag formula remains in position on vertical and overhead surfaces
- Excellent adhesion to metal, e-coat and existing NVH materials

OEM Approvals:

Honda: Collision repair

SIZE	COLOR	FUSOR #	PART #	CASE
300ML	Black	231	666233 90998	6
50ML	Black	234	666233 90999	12



DIRECT-TO-METAL ADHESIVE/SEALANT | BARE METAL

Applications: Duplicates factory look on standing seams, cosmetic seams, truck bed seams, tooled door skin seams, floor pan seams, core support seams and brushed seams and any other application in which a non-sag cosmetic seam sealer is required

Features & Benefits:

- Single component direct-to-metal; no substrate primer required
- Non-sag
- Holds brush marks without die back
- Weld-thru with no burn back

OEM Approvals:

Nissan, Ford: Collision/warranty repair
Honda: Collision repair

SIZE	COLOR	FUSOR #	PART #	CASE
9.5 oz (281 mL)	Black	800DTM	808498 10170	12
9.5 oz (281 mL)	Neutral	803DTM	808498 10171	12



HIGH DEFINITION SPRAYABLE SEALER | BARE METAL

Applications: Creates flexible textured seams on floor pans, trunk pans, strut towers, exterior and truck bed seams; restore rocker panel chip guard texture and trunk area texture. Duplicates weld-thru sealing

Features & Benefits:

- Extremely flexible – won't crack or peel
- Perfectly matches all OEM seams and textures with use of Fusor 312 Dispensing Gun

OEM Approvals:

Chrysler, GM: Collision repair
Ford: Collision/warranty repair
Honda: Collision repair

SIZE	COLOR	FUSOR #	PART #	CASE
9.5 oz (281 mL)	White	802HD	808498 10158	12
9.5 oz (281 mL)	Gray	804HD	808498 10159	12
9.5 oz (281 mL)	Black	805HD	808498 10160	12
9.5 oz (281 mL)	Beige	806HD	808498 10161	12



FLEXIBLE FOAM (SUPER FAST) | FLEXIBLE

Applications: Sound deadening, sealing and filling of: door skins to crash bar, hood panel to supports, trunk panel to supports and gas tank filler area

Features & Benefits:

- Matches OEM sound deadening foams
- Retains its memory with no shrinkage
- Expands to 10 times its size
- Will not oil can
- Will not absorb moisture or cause corrosion

OEM Approvals:

Ford, GM, Tesla, Volvo: Collision/warranty repair
Honda: Collision repair

SIZE	COLOR	FUSOR #	PART #	CASE
10.1 oz (300 mL)	Black	121	808498 10058	6
1.7 oz (50 mL)	Black	124	808498 10011	12



RIGID FOAM (SUPER FAST) | RIGID

Applications: Sound deadening, vibration dampening, reinforcement, sealing and filling of: fender rails, pillars, rocker panels, quarter panels and floors

Features & Benefits:

- Matches OEM sound deadening foams commonly found in pillars, front rails, rockers and rear supports
- Expands to 10 times its size
- Provides NVH properties for a quieter ride
- Tough compressive strength for maximum energy absorption
- Super fast application, providing full foam expansion in 3 minutes

OEM Approvals:

Ford, Chrysler: Collision/ warranty repair
Honda: Collision repair

SIZE	COLOR	FUSOR #	PART #	CASE
10.1 oz (300 mL)	Beige	130	808498 10129	6

SPECIALTY PRODUCTS/ACCESSORIES



CLEAR DOUBLE-SIDED TAPE

Applications: Excellent adhesion of exterior/interior trim including emblems, side molding and bumper cover trim

Features & Benefits:

- Longer-sized roll for multiple jobs
- 33% stronger than competitive tapes
- UV, water and solvent resistant
- Clear, non-detectable
- Repositionable
- Increased strength when used over Fusor 602EZ

Substrates:

Bonds metal, glass and plastic

OEM Approvals:

Chrysler: MS-CH59
Ford: WSB-M3G138-B
GM: GM 3802M

SIZE	FUSOR #	PART #	CASE
7/8" x 60' x 0.045" (22.2 mm x 18.3 m x 1.14 mm)	180	808498 10132	6
1/2" x 60' x 0.045" (12.7 mm x 18.3 m x 1.14 mm)	181	808498 10133	6
1/4" x 60' x 0.045" (6.4 mm x 18.3 m x 1.14 mm)	182	808498 10134	6



SURFACE MODIFIER

Applications: Increases adhesion for plastic bumper repair and painting plastic parts. Also improves adhesion for double-sided tapes and seam sealing tapes

Features & Benefits:

- Open time from 10 minutes to 24 hours
- California compliant
- No need for plastic identification when used with Fusor 132/133, 142/143, 152/153 or 141/140 adhesives
- Increases adhesion when used with Fusor 180/181/182

Substrates:

All plastic bumper covers, emblems, moldings and primed or painted metals

OEM Recommended

SIZE	FUSOR #	PART #	CASE
9 oz (255 mL)	602EZ	808498 10121	6



REINFORCING MESH

Applications: Use for backing patches, bumper tabs and other reinforcements on plastic bumper covers.

Features & Benefits:

- Use with Fusor 132/133, 142/143, 152/153, 141/140 adhesives
- Use with Fusor 602EZ
- Use with Fusor 704 roller
- Finish with Fusor 114LG/114SM adhesive

Substrates:

Plastic bumpers, bumper tabs

SIZE	FUSOR #	PART #	CASE
4" x 12' (101.6 mm x 3.7 m)	700	808498 10023	12



FIBERGLASS CLOTH

Applications: Use for structural backing support, pyramid patches and other reinforcements on SMC and fiberglass panels.

Features & Benefits:

- Helps eliminate bull's-eyes in SMC repair
- Use with Fusor 100EZ/101EZ, 120/T20 and T21 adhesives
- Use with Fusor 704 roller

SIZE	FUSOR #	PART #	CASE
4" x 12' (101.6 mm x 3.7 m)	702	808498 10025	12



ADHESION PREP/CLEANER

Applications: Removes silicones and contaminants. Use prior to applying adhesives, sealers and coatings. Removes brake dust from wheels

SIZE	FUSOR #	PART #	CASE
32 oz (946.3 mL)	703	808498 10026	12



SATURATION ROLLER

Applications: Use with Fusor 700 and 702 for maximum adhesive saturation.

Features & Benefits:

- 3" (76.2 mm) anodized aluminum
- Ideal for building SMC patch panel repairs
- Helps compact the surface for strong repairs

SIZE	FUSOR #	PART #	CASE
3" (76.2 mm) Roller	704	808498 10027	6



MANUAL 50 ML DISPENSING GUN

Applications: Use with 1.7 oz (50 mL) cartridges, which go with Fusor 400 mix tip

Features & Benefits:

- Dispenses both 1:1 and 2:1 cartridges with no conversion necessary
- Sturdy, high-quality, compact
- Fusor 517 replacement plungers available for Fusor 300 gun

SIZE	FUSOR #	PART #	CASE
50 mL Dispensing Gun	300	808498 10019	1
Replacement Plunger	517	808498 10120	6



MANUAL 300/225 ML DISPENSING GUN

Applications: For use with 10.1/7.6 oz (300/225 mL) cartridges

Features & Benefits:

- Dispenses 1:1 and 2:1 cartridges with easy conversion
- Features tempered, built-in nozzle cutter for easy controlled custom bead sizing
- 10:1 thrust ratio

SIZE	FUSOR #	PART #	CASE
300/225 mL	301	808498 10020	1



HIGH PERFORMANCE MANUAL 300/225 ML DISPENSING GUN

Applications: For use with 10.1/7.6 oz (300/225 mL) cartridges

Features & Benefits:

- Dispenses 1:1 and 2:1 cartridges with easy conversion
- Features tempered, built-in nozzle cutter for easy controlled custom bead sizing
- Sturdy, high-quality, compact
- 26:1 thrust ratio allows for easy dispensing of high viscosity adhesive
- Improved cartridge stabilization

SIZE	FUSOR #	PART #	CASE
300/225 mL	302	808498 10177	1

SPECIALTY PRODUCTS/ACCESSORIES



PNEUMATIC 380 ML DISPENSING GUN

Applications: For use with GM-approved Fusor 120/T20 12.8 oz (380 mL) coaxial cartridges

Features & Benefits:

- Convertible from 1:1 to 2:1
- Includes air hose, regulator, 2 retaining nuts and 2 valve handles
- Rates for 100 psi (0.69 MPa) of dispensing pressure
- Super high-performance tool

SIZE	FUSOR #	PART #	CASE
380 mL	303	808498 10078	1



PNEUMATIC 300/225 ML DISPENSING GUN

Applications: For use 7.6/ 10.1 oz (225/300 mL) cartridges

Features & Benefits:

- For use with 1:1 and 2:1 cartridges
- For fast and easy application of long beads

SIZE	FUSOR #	PART #	CASE
300/225 mL	304	808498 10079	1



SPRAYABLE SEAM SEALER GUN

Applications: For use with Fusor HD sealers

Features & Benefits:

- When used with Fusor HD sealers, matches all OEM seam sealers, textured coatings and sound deadening applications
- Material and air flow adjustment controls allow for factory match seams

SIZE	FUSOR #	PART #	CASE
	312	808498 10111	1



ONE-COMPONENT MANUAL SEAM SEALER GUN

Applications: For use with Fusor HD and DTM sealers and Fusor 2098

Features & Benefits:

- B-Line 1/10th gallon cartridge gun with smooth high-powered 26:1 thrust ratio
- Excellent for all sealants - especially handy for thicker materials and in cold weather

SIZE	FUSOR #	PART #	CASE
	313	808498 10146	1



PNEUMATIC ONE-COMPONENT CAULKING GUN

Applications: For use with Fusor HD and DTM sealers and Fusor 2098

Features & Benefits:

- Rod driven pneumatic dispenser
- True air regulator controls flow, allowing for continuous bead application
- Includes quick change aluminum barrel, safety valve in handle, and air dump valve to instantly stop flow
- Rates for 0-100 psi (0.69 MPa) of dispensing pressure

SIZE	FUSOR #	PART #	CASE
	314	808498 10178	1

SPECIALTY PRODUCTS/ACCESSORIES

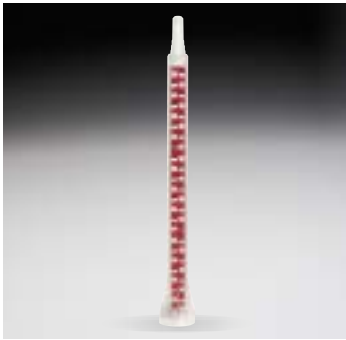

RED POWER 50 ML CARTRIDGES MIXING TIPS

Applications: For use with all 1:1 and 2:1, 1.7 oz (50 mL) cartridges, which go with Fusor 300 dispensing gun

Features & Benefits:

- Size: 0.21" x 4.5" x 24-element (5.3 mm x 114.3 mm x 24-element)
- Bayonet mount
- 12 per package, or economy pack of 144

SIZE	FUSOR #	PART #	CASE
Standard Pack	400	808498 10076	12
Economy Pack	416	808498 10066	144



RED POWER 300/225 ML CARTRIDGES MIXING TIPS

Applications: For use with all 1:1 and 2:1, 7.6/10.1 oz (225/300 mL) cartridges (except for Fusor 120/T20, T21, T23, and 2098 which use the #420 Red Power Mixing Tip)

Features & Benefits:

- Size: 0.34" x 5.8" x 24-element (8.6 mm x 147.3 mm x 24-element)
- 12 per package, or economy pack of 144

SIZE	FUSOR #	PART #	CASE
Standard Pack	401	808498 10145	12
Economy Pack	417	808498 10067	144



NOZZLE FOR 800 SERIES SEALER

Applications: For use with Fusor HD and DTM sealers

Features & Benefits:

- Threaded replacement nozzles for caulking tubes

SIZE	FUSOR #	PART #	CASE
	412	808498 10130	12



RED POWER MIXING TIPS

Applications: For use with Fusor 120/T20, T21, T23 and 2098

Features & Benefits:

- Size: 0.42" x 6.8" x 24-element (10.7 mm x 172.7 mm x 24-element)

SIZE	FUSOR #	PART #	CASE
	420	808498 10073	12



CABINET

Applications: Allows easy accessibility, stocking and storage of Fusor adhesives and accessories

Features & Benefits:

- Keeps Fusor products dust free
- Makes evaluating inventory easier
- Size: 20"w x 35"h x 12"d (0.51 m x 0.89 m x 0.3 m)
- Complete with shelf, mixer container and hanging racks for opened and unopened cartridges
- Black

SIZE	FUSOR #	PART #	CASE
20"w x 35"h x 12"d (0.51 m x 0.89 m x 0.3 m)	907	808498 10105	1

Available in black

There's no shine like Mothers®.

Mothers® started in 1971 when tire dealer, Al Holloway, and a chemist friend invented a polish to remove oxidation from that era's then-new "mag" wheels. It was an instant hit with car enthusiasts. And the business blossomed from that single item to a comprehensive line of more than 40 new-appearance care products on the market today. Still owned and operated by the Holloway family, the company has pioneered new appearance car technologies based on its passion for painstaking research and superior quality.



HEAVY DUTY RUBBING COMPOUND

Quickly removes 1200 grit and finer sand scratches from all types of refinish and factory-applied automotive paints. May also be used to remove heavy oxidation, car wash scratches, and other defects from paints that do not require sanding. Can be used with a wool or a foam pad.

DESCRIPTION	PART #	QTY/CASE
32 oz./946mL	078175 81232	6
1 gallon/3.785L	078175 81238	4



RUBBING COMPOUND

Quickly removes 1500 grit and finer sand scratches from all types of refinish and factory-applied automotive paints. May also be used to remove light oxidation, car wash scratches, and other defects from paints that do not require sanding. Can be used with a wool or a foam pad.

DESCRIPTION	PART #	QTY/CASE
12 oz./355mL	078175 08612	6
32 oz./946mL	078175 81132	6
1 gallon/3.785L	078175 81138	4



FINISHING POLISH/FOAM PAD POLISH

Recommended for removal of compounding swirl marks from all types of refinish or factory-applied automotive paints. Also recommended to enhance color and add depth. Use with a foam pad.

DESCRIPTION	PART #	QTY/CASE
12 oz./355mL	078175 08712	6
32 oz./946mL	078175 83432	6
1 gallon/3.785L	078175 83438	4



PROFESSIONAL DISPENSER BOTTLE

Dispense polishes and compounds with ease with Mothers® Professional Refillable Dispenser Bottle. It features a self-cleaning pop top to prevent clogging, keeping you focused on the task at hand, all while distributing the perfect amount of product every time. Buy in bulk, and dispense with ease with this high-quality dispenser bottle.

DESCRIPTION	PART #	QTY/CASE
12 oz./355mL	078175 80000	12



INSTANT DETAILER

Instant Detailer is a silicone-free, body shop safe, paintable product that provides unparalleled depth and clarity. This unique formula is easy-to-use and completely safe on all types of paints, including clear coats. Simply the fastest way to prep and shine any vehicle's paint in any body shop environment.

Tech Tip – Use Instant Detailer with a clean microfiber towel during and after compounding and polishing, for a quick and easy cleanup.

DESCRIPTION	PART #	QTY/CASE
24 oz./710mL	078175 85624	6
1 gallon/3.785L	078175 85638	4
5 gallon/18.925L	078175 85645	1
32 oz. Chemical Resistant Sprayer	078175 85632	12





MACHINE GLAZE

This high-quality polishing glaze quickly removes compound haze, fine scratches, and swirl marks from all types of refinish or factory-applied automotive paints. Can be used with a wool or a foam pad.

DESCRIPTION	PART #	QTY/CASE
32 oz./946mL	078175 82332	6



HAND GLAZE

Recommended for added shine and protection, Professional Hand Glaze may be used after Professional Finishing Polish / Foam Pad Polish to achieve unparalleled depth and clarity. Hand Glaze is easy-to-use and completely safe on all types of paints.

DESCRIPTION	PART #	QTY/CASE
32 oz./946mL	078175 84532	6



PROFESSIONAL METERING UNIT

The Mothers® Professional Metering Unit is the most efficient and precise way to ensure that Mothers® product concentrates are being diluted correctly for their specified use; at the push of a button. The unit is easy-to-install, easy-to-use, and it dilutes up to six different Mothers® product concentrates.

DESCRIPTION	PART #	QTY/CASE
Metering Unit	636425 05986	1



AUTO WASH (CONCENTRATE)

Carefully crafted concentration of soaps and detergents that cleans away grease and grime with ease. This pH balanced, non-toxic, environmentally friendly, and biodegradable formula will not streak paint or remove existing wax. Can be used as a wet sanding solution when diluted 1/2 oz. Per gallon of water.

DESCRIPTION	PART #	QTY/CASE
1 gallon/3.785L	078175 80138	4
5 gallon/18.925L	078175 80145	1
55 gallon/208.18L	078175 80155	1



ALL-PURPOSE CLEANER (CONCENTRATE)

A highly concentrated, biodegradable multi-purpose cleaning solution for a wide variety of surfaces. Combining highly effective cleaners with a combination of water miscible solvents and surfactants, this All-Purpose Cleaner breaks down dirt and grease with ease. Perfect for cleaning carpets, fabrics, vinyl upholstery, engine compartments, fender wells, door jambs, and more. At higher concentrations, All-Purpose Cleaner is great for cleaning wheels, tires, whitewalls and pre-spotting carpets before shampooing.

DESCRIPTION	PART #	QTY/CASE
1 gallon/3.785L	078175 87138	4
5 gallon/18.925L	078175 87145	1
55 gallon/208.18L	078175 87155	1
32 oz. Chemical Resistant Sprayer	078175 87132	12



WATER-BASED DEGREASER (CONCENTRATE)

Features a safe but effective blend of grease cutting surfactants and biodegradable solvents which lift away carbon and baked-on grime from a variety of surfaces. This non-toxic, super-concentrate is tough on tenacious filth, but will not stain paint or harm aluminum engine components.

DESCRIPTION	PART #	QTY/CASE
1 gallon/3.785L	078175 87538	4
5 gallon/18.925L	078175 87545	1
55 gallon/208.18L	078175 87555	1
32 oz. Chemical Resistant Sprayer	078175 87532	12



GLASS CLEANER (CONCENTRATE)

Mothers® Professional Glass Cleaner is a cost-effective and versatile cleaning concentrate formulated for all glass and virtually any surface. Ideal for use in high volume detail shops and car washes to remove tough grime, dirt, oily film, and fingerprints. Also great around the house, car, boat or motor home, even on tinted window surfaces. It dries quickly and leaves behind a sparkling clean, streak-free shine, even in cold weather.

DESCRIPTION	PART #	QTY/CASE
1 gallon/3.785L	078175 87638	4
5 gallon/18.925L	078175 87645	1
32 oz. Chemical Resistant Sprayer	078175 87632	12



WHEEL CLEANER (CONCENTRATE)

Mothers® Professional Wheel Cleaner is a biodegradable cleaning concentrate for factory/OEM wheels and hubcaps, including painted, clear coated, color coated and chrome. Professional Wheel Cleaner does not contain hydrofluoric, sulphuric or phosphoric acids, making it safer than conventional acid cleaners.

DESCRIPTION	PART #	QTY/CASE
1 gallon/3.785L	078175 87938	4
5 gallon/18.925L	078175 87945	1
55 gallon/208.18L	078175 87955	1
32 oz. Chemical Resistant Sprayer	078175 87932	12



SILICONE-FREE DRESSING CONCENTRATE

Mothers® Silicone-Free Dressing Concentrate is a pre-delivery prep product designed specifically for body shops. This silicone-free and water-based formula can safely be used on any rubber and trim.

DESCRIPTION	PART #	QTY/CASE
1 gallon/3.785L	078175 88638	4
5 gallon/18.925L	078175 88645	1
32 oz. Chemical Resistant Sprayer	078175 88632	12



SILICONE-FREE DRESSING

Silicone-Free Dressing is a pre-delivery prep product designed specifically for body shops. This silicone-free and water-based formula can safely be used on any rubber and trim.

DESCRIPTION	PART #	QTY/CASE
1 gallon/3.785L	078175 88538	4
5 gallon/18.925L	078175 88545	1
32 oz. Chemical Resistant Sprayer	078175 88532	12



VINYL & RUBBER DRESSING

This product is extremely versatile, and can be used on all vinyl, rubber, and plastic surfaces, even engine compartments. Protects all these surfaces from the elements, and leaves a non-greasy, "like-new" finish that will not attract dust. This white silicone emulsion features a thick, creamy consistency that is easily sprayed or wiped onto any surface, and dries to a medium-high shine. Does not contain soaps, glycerin or other extenders.

DESCRIPTION	PART #	QTY/CASE
1 gallon/3.785L	078175 88138	4
5 gallon/18.925L	078175 88145	1
32 oz. Chemical Resistant Sprayer	078175 88132	12



SPIGOT FOR 5 GALLON CONTAINER

Dispensing liquids from our Professional 5 gallon containers has never been easier. With a simple twist, our spigot allows for a quick and easy fill, ideal for our 32 ounce OSHA compliant secondary spray bottles. Made from chemical resistant High Density Polyethylene (HDPE), our 3/4" spigot will thread right into our 5 gallon container's lid.

DESCRIPTION	PART #	QTY/CASE
Spigot	078175 80005	6

PAINT PROTECTION AND WINDOW FILM



Protect. Save. Renew.

Solar Gard window and body film act as body armor helping to guard the vehicle from damaging elements. The advanced design of tough, clear polymer creates an invisible layer of protection to the covered surface keeping the vehicle in like-new condition and eliminating 95% of ultraviolet rays for many years.



WINDOW FILM

Solar Gard® NR Supreme is a non-reflective, color-stable window film made from manufacturing technology that produces optimum heat- and glare-rejection from a non-metal film. NR Supreme provides superior optical clarity and complements factory glass with its protective qualities.

	20"	40"	60"
DESCRIPTION	PART #	PART #	PART #
NR Supreme™ 8	776960 90285	776960 90286	776960 90287
NR Supreme™ 15	776960 90288	776960 90289	776960 90290
NR Supreme™ 28	776960 90291	776960 90292	776960 90293
NR Supreme™ 40	776960 90294	776960 90295	776960 90296
NR Supreme™ 50	776960 90297	776960 90298	776960 90299
Roll/Case	1	1	1



PAINT PROTECTION FILM

Clearshield Pro is a tough, clear barrier that acts like body armor for paint. It's an invisible layer that helps protect paint against chips, scratches and stains caused by road debris, insects and more.

	12"	18"	24"	30"	36"	60"
DESCRIPTION	PART #	PART #	PART #	PART #	PART #	PART #
Clearshield Pro	776960 90300	776960 90301	776960 90302	776960 90303	776960 90304	776960 90305
Roll/Case	1	1	1	1	1	1



DOOR EDGE GUARD

The Clearshield Pro Door Edge Guard protects the door edges of a vehicle from potential scratches and chips, is as easy as a pinstripe to install. It is an invisible 8 mil door edge protector that is removable if needed warranted against yellowing, cracking or peeling. (1) 1/2" x 100' roll yields up to (10) 4-door cars.

	1/2" x 100'
DESCRIPTION	PART #
Clearshield Pro Door Edge Guard	776960 90306
Qty/Pack	1



Total Inventory Management

OPTIMIZE YOUR REPAIR MATERIALS. IMPROVE YOUR BOTTOM LINE.

Exclusively offered by Refinish Solutions Group, the TIM information technology application enables collision repair shops to optimize management of repair materials, helping the shop to lower costs, streamline repair processes and improve profitability.

TIM utilizes technician barcode scanning of repair materials and simple-to-use software. The intuitive design of the TIM platform empowers shop managers to minimize inventory, ensure that the right repair materials are always available, identify recoverable materials used by RO# and track material usage trends.

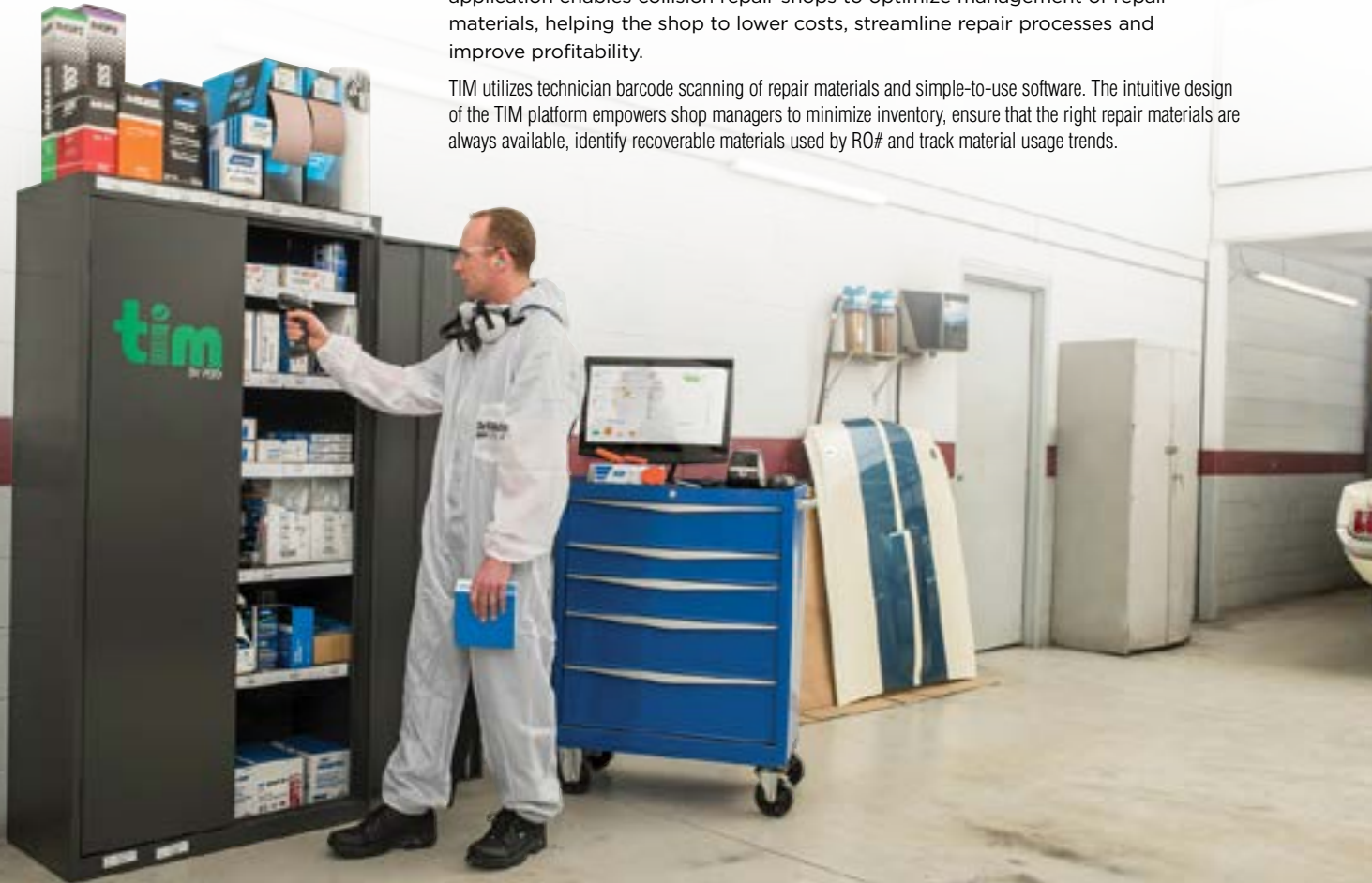

TRADEMARKS

AVOS, Bear-Tex, Black Ice, Blaze, BlueFire, Charger, Dry Ice, Gemini, Liquid Ice, Merit, Metalite, Multi-Air, NorGrip, No-Fil, Norton design, Norton mark, NorZon, Red Heat, SoftTouch, SolarGard, Speed-Lok, Stick & Sand, Vortex are registered trademarks of Saint-Gobain.

A275 Original Performance, Blue Magnet, Blue Sheeting, Blue Wrap, Gold Reserve, Job Pack, Let's Talk Shop, Liquid Ice Extra-Cut, Medallion, Multi-Air Cyclonic, Nor-Kut, Norton Ice, NorZon Plus, Paint Check, Rapid Blend, Rapid Prep, Rapid Strip, Rotolo Foam, Speed-Grip, Thin-Flex, Quality that Pays are trademarks of Saint-Gobain.

The American logo, Orange Mask, and Anchor are registered trademarks and TrimFast is a trademark of Intertape Polymer Group®, Inc.

The Mothers logo is a registered trademark of Mothers® Polishes • Waxes • Cleaners, Inc.

The Pliogrip logo is a registered trademark of Ashland® Inc.

DeVilbiss® is a registered trademark of DeVilbiss Automotive Refinishing.

Fusor is a registered trademark of LORD Corporation.

Vehicle images provided courtesy of Ford® Motor Company.

All trademarks and logos are property of their respective holders and used by consent.

* Always wear protective gear. Photos in this brochure are for illustrative purposes only.

PART #	PAGE
07660700256	32
07660700257	32
07660700322	32
07660700323	32
07660700345	31
07660700346	31
07660700347	31
07660700348	31
07660700350	31
07660700351	31
07660700352	31
07660700362	32
07660700363	32
07660700491	31
07660700492	31
07660700493	31
07660700494	31
07660700495	31
07660700496	31
07660700497	31
07660700498	31
07660700499	31
07660700517	32
07660700518	32
07660700629	31
07660700630	31
07660700631	31
07660700633	31
07660700634	31
07660700762	31
07660700763	31
07660701889	56
07660703074	21
07660703075	21
07660703076	21
07660703077	21
07660703078	21
07660705376	20
07660719359	58
07660721937	48
07660721938	46
07660749008	59
07660768280	54
07660768281	54
07660768282	54
07660768367	54
07660768368	54
07660782705	45
07660782706	45
07660782725	45
07660782735	46
07660782746	46
07660782750	46
07660782751	46
07660782770	47
07660782772	47
07660782775	47
07660782776	47
07660782780	48
07660782786	46
07660789011	30
07660789012	30
07660789014	30
07660789018	30
07660789030	30
07660789032	30

PART #	PAGE
07660789034	30
07792200268	52
07792200552	66
07792200553	66
07792200554	66
07792200555	66
07792274977	52
07792288400	66
07792288401	66
07792288402	66
07792288403	66
07817508612	80
07817508712	80
07817580000	80
07817580005	82
07817580138	81
07817580145	81
07817580155	81
07817581132	80
07817581138	80
07817581232	80
07817581238	80
07817582332	81
07817583432	80
07817583438	80
07817584532	81
07817585624	80
07817585632	80
07817585638	80
07817585645	80
07817587132	81
07817587138	81
07817587145	81
07817587155	81
07817587532	81
07817587538	81
07817587545	81
07817587555	81
07817587632	82
07817587638	82
07817587645	82
07817587932	82
07817587938	82
07817587945	82
07817587955	82
07817588132	82
07817588138	82
07817588145	82
07817588532	82
07817588538	82
07817588545	82
07817588632	82
07817588638	82
07817588645	82
08714300214	49
08714300217	49
08714300218	49
08714300306	65
08714300307	65
08714300308	65
08714300309	65
08714300310	65
08714300311	65
08714300312	65
08714300313	65

PART #	PAGE
08714300314	65
08714300315	65
08714300316	65
08714300317	65
08714300499	66
08714300500	66
08714300501	66
08714300502	66
08714300577	65
08714300579	65
08714300580	65
08714300581	65
08714300586	65
08714300587	65
08714300690	65
08834164037	25
63642500402	51
63642500403	51
63642500404	51
63642500407	51
63642500904	56
63642500906	56
63642502161	59
63642502162	59
63642502517	59
63642502532	55
63642502981	55
63642502999	20
63642503009	20
63642503021	20
63642503023	20
63642503029	59
63642503030	59
63642503344	49
63642503345	49
63642503656	27
63642503657	27
63642503658	27
63642503659	27
63642503660	27
63642503723	49
63642503726	56
63642503727	56
63642503728	57
63642503729	57
63642504402	18
63642504615	38
63642504616	38
63642504617	38
63642504622	41
63642504625	38
63642504628	43
63642504632	43
63642504647	38
63642504670	48
63642504671	42
63642504672	42
63642504673	42
63642504674	42
63642505457	59
63642505459	19
63642505460	19
63642505620	48
63642505621	48
63642505622	48
63642505624	59

PART #	PAGE
63642505920	50
63642505921	50
63642505922	50
63642505923	50
63642505986	81
63642506002	5
63642506013	17
63642506014	17
63642506015	17
63642506020	17
63642506021	17
63642506022	17
63642506078	18
63642506092	18
63642506113	6
63642506114	6
63642506117	6
63642506118	6
63642506119	6
63642506120	6
63642506121	6
63642506122	6
63642506123	6
63642506124	6
63642506126	58
63642506127	58
63642506128	17, 19, 59
63642506129	58
63642506130	17, 58
63642506131	58
63642506132	58
63642506133	58
63642506134	58
63642506135	58
63642506136	58
63642506137	58
63642506138	58
63642506139	58
63642506140	58
63642506141	58
63642506142	58
63642506143	58
63642506144	58
63642506145	58
63642506146	58
63642506147	10
63642506148	10
63642506149	10
63642506150	10
63642506151	10
63642506152	10
63642506153	10
63642506160	58
63642506164	10
63642506165	10
63642506166	20
63642506167	20
63642506168	44
63642506169	52
63642506174	52
63642506176	10
63642506177	10
63642506178	10
63642506179	10
63642506182	10
63642506194	11

PART #	PAGE
63642506195	11
63642506196	11
63642506198	6
63642506199	6
63642506200	6
63642506202	5
63642506203	5
63642506204	5
63642506215	11
63642506216	11
63642506217	11
63642506218	11
63642506219	11
63642506220	11
63642506224	51
63642506225	10
63642506226	10
63642506227	10
63642506228	10
63642506229	10
63642506230	10
63642506231	10
63642506232	10
63642506233	10
63642506234	10
63642506235	10
63642506236	10
63642506237	11
63642506238	11
63642506239	11
63642506240	11
63642506241	11
63642506242	11
63642506255	6
63642506256	6
63642506257	6
63642506258	6
63642506259	6
63642506261	6
63642506375	5
63642506376	5
63642506377	5
63642506379	19
63642506380	19
63642506381	19
63642506396	43
63642506398	40
63642506399	41
63642506400	39, 43
63642506402	40
63642506403	44
63642506404	44
63642506412	39
63642506417	39
63642506418	39
63642506419	37
63642506420	37
63642506421	39
63642506425	47
63642506426	47
63642506427	37
63642506727	49
63642506728	49
63642536135	59
63642541396	43
63642541398	43

PART #	PAGE
63642541399	43
63642541400	43
63642542077	19
63642542078	19
63642542079	19
63642542080	19
63642542082	18
63642542089	59
63642542090	56
63642542091	56
63642542092	56
63642542093	56
63642542094	56
63642542095	56
63642542724	57
63642542770	55
63642542772	55
63642542773	9, 55
63642543112	59
63642543421	59
63642543422	59
63642543423	59
63642543425	59
63642543463	59
63642543704	59
63642543712	59
63642543714	59
63642543832	19
63642552835	57
63642552836	57
63642555106	22
63642557606	21
63642557608	21
63642557611	21
63642557612	21
63642557613	21
63642557616	21
63642560605	58
63642572012	52
63642572014	52
63642572018	52
63642576377	48
63642576378	48
63642578000	52
63642585864	58
63642597116	18
63642597117	43
63642597118	43
63642597120	40
63642597121	40
63642597122	38
63642597500	4
63642597501	4
63642597502	4
63642597503	4
63642597504	4
63642597505	4
63642597506	4
63642597507	4
63642597508	4
63642597509	4
63642597510	4
63642597511	4
63642597512	4
63642597513	4
63642597514	4

PART #	PAGE
63642597515	4
66243510630	30
66243510655	30
66243510675	30
66243510677	30
66254444193	29
66254464820	28
66254464821	28
66254464822	28
66254470735	52
66254470746	52
66254480230	6
66254480231	6
66254480232	5
66254480233	5
66261009189	24
66261009190	24, 35
66261009191	24
66261009192	24
66261009194	24
66261009324	22
66261009502	22
66261017522	35
66261040261	10
66261041384	29
66261055103	25, 35
66261055105	25, 35
66261055309	29
66261055310	29
66261055311	29
66261058000	20
66261058001	20
66261058002	20
66261058005	20
66261089208	51
66261101600	16
66261101601	16
66261101602	16
66261101603	16
66261101615	16
66261101616	16
66261101617	16
66261101618	16
66261113517	20
66261113519	20
66261121048	25
66261121049	25
66261121053	25
66261121054	25
66261123573	12
66261123574	12
66261123575	12
66261123576	12
66261123577	12
66261123578	12
66261123580	12
66261123582	12
66261123584	12
66261123588	12
66261123589	12
66261123590	12
66261123591	12
66261123592	12
66261123593	12
66261123596	12
66261123598	12

PART #	PAGE
66261123608	13
66261123609	13
66261123610	13
66261123611	13
66261123612	13
66261123613	13
66261123614	13
66261123615	13
66261123616	13
66261123617	13
66261123618	13
66261123619	13
66261123620	13
66261123621	13
66261123622	13
66261125244	12
66261125307	12
66261125436	12
66261125444	12
66261125595	13
66261125684	12
66261126511	13
66261126512	13
66261126556	28
66261126557	28
66261126558	28
66261128688	8
66261131448	8
66261131449	8
66261131450	8
66261131451	8
66261131452	8
66261131453	8
66261131454	8
66261131456	8
66261131457	8
66261131458	8
66261131459	8
66261131460	8
66261131461	8
66261131462	8
66261131463	8
66261131464	8
66261131465	8
66261131466	8
66261131467	8
66261131468	8
66261131469	8
66261131470	8
66261131471	8
66261131473	8
66261131474	8
66261131475	8
66261131476	8
66261131477	8
66261131478	8
66261131479	8
66261131480	8
66261131481	8
66261131487	8
66261131488	8
66261131490	8
66261131492	8
66261131493	8
66261131494	8
66261131495	8

PART #	PAGE
66261131496	8
66261131497	8
66261131498	8
66261131503	8
66261131505	8
66261131507	8
66261131508	8
66261131509	8
66261131510	8
66261131511	8
66261131512	8
66261131513	8
66261131514	8
66261131515	8
66261131519	8
66261131521	8
66261131524	8
66261131526	8
66261131527	8
66261131528	8
66261131532	8
66261131533	8
66261131534	8
66261131535	8
66261131536	8
66261131537	8
66261131538	8
66261131539	8
66261131541	8
66261131543	8
66261131544	8
66261131545	8
66261131546	8
66261131547	8
66261131548	8
66261131549	8
66261131550	8
66261131551	8
66261131552	8
66261131553	8
66261131554	8
66261131555	8
66261131556	8
66261131558	8
66261131559	8
66261131560	8
66261131561	8
66261131562	8
66261131563	8
66261131564	8
66261131565	8
66261131566	8
66261131571	7
66261131573	7
66261131575	7
66261131577	7
66261131578	7
66261131579	7
66261131580	7
66261131581	7
66261131582	7
66261131583	7
66261131584	7
66261131585	7
66261131599	7
66261131609	8

PART #	PAGE
66261131612	8
66261131613	8
66261131614	8
66261131615	8
66261131617	8
66261131618	9
66261131619	9
66261131620	9
66261131621	9
66261131622	9
66261131623	9
66261131624	9
66261131626	9
66261131627	9
66261131628	9
66261131629	9
66261131630	9
66261131631	9
66261131632	9
66261131633	9
66261131634	9
66261131635	9
66261131636	9
66261131637	9
66261131638	9
66261131639	9
66261131640	9
66261131641	9
66261131642	9
66261131643	9
66261131644	9
66261131645	9
66261131646	9
66261131647	9
66261131648	9
66261131649	9
66261131650	9
66261131651	9
66261131652	9
66261131654	9
66261131656	9
66261131657	9
66261131661	8
66261131662	8
66261131663	8
66261131664	8
66261131679	9
66261131681	9
66261131683	9
66261131685	9
66261131686	9
66261131687	9
66261131688	9
66261131689	9
66261131691	9
66261133296	9
66261135900	8
66261136995	8
66261136996	8
66261138561	28
66261138562	28
66261138563	28
66261138582	28
66261138583	28
66261138584	28

PART #	PAGE
66261138590	28
66261138591	28
66261138592	28
66261138593	28
66261138594	28
66261138600	28
66261138601	28
66261138670	25
66261138671	25
66261138672	25
66261138673	25
66261138674	25
66261138675	25
66261139369	14
66261139370	14
66261139371	14
66261139372	14
66261139373	14
66261139374	14
66261139375	14
66261139377	14
66261139378	14
66261139379	14
66261139380	14
66261139381	14
66261139382	14
66261139383	14
66261139384	14
66261139385	14
66261139386	14
66261139388	14
66261139389	14
66261140385	8
66261140498	6
66261140499	6
66261140500	6
66261140501	6
66261140502	6
66261140508	6
66261140509	6
66261140510	6
66261140511	6
66261140512	6
66261140518	5
66261140519	5
66261140520	5
66261140521	5
66261140522	5
66261140528	5
66261140529	5
66261140530	5
66261140531	5
66261140532	5
66261142474	6
66261144926	8
66261147432	14
66261147433	14
66261147434	8
66261148340	6
66261149537	5
66261149538	5
66261149540	5
66261149541	5
66261149542	5
66261149543	5
66261149544	5

PART #	PAGE
66261149545	5
66261149546	5
66261149557	6
66261149558	6
66261149561	6
66261149562	6
66261149563	6
66261149564	6
66261149566	6
66261150076	35
66261150077	35
66261152692	9
66261155373	6
66261155374	6
66261155376	6
66261155377	6
66261155378	6
66261155379	6
66261155380	6
66261160325	10
66261162318	25, 35
66261162320	25
66261162322	25
66261162324	25
66261162328	25, 35
66261162330	25
66261162332	25
66261162334	25
66261181412	12
66261182685	66
66261182686	66
66261182688	66
66261183806	10
66261183807	10
66261183808	10
66261183809	10
66261183810	10
66261183811	10
66261183812	10
66261183813	10
66261183814	10
66261183815	10
66261183816	10
66261183817	10
66261183818	10
66261183819	10
66261183820	10
66261183821	10
66261183822	10
66261183823	10
66261183824	10
66261183825	10
66261183826	10
66261183827	10
66261183828	10
66261183829	10
66261183830	10
66261183831	10
66261183832	10
66623305608	6
66623305616	5
66623311870	15
66623311871	15
66623311873	15
66623311874	15
66623311875	15

PART #	PAGE
66623311876	15
66623311877	15
66623311878	15
66623311879	15
66623329518	6
66623329547	6
66623329548	6
66623331051	22
66623331053	22
66623331054	22
66623334770	20
66623334771	20
66623334772	46
66623334782	23
66623334783	23
66623334785	11
66623334786	10
66623334787	10
66623334788	10
66623334790	10
66623334791	10
66623334793	10
66623334794	10
66623334795	10
66623334796	10
66623334797	10
66623334800	11
66623334801	11
66623334802	11
66623334803	11
66623334804	11
66623334805	11
66623335417	24
66623335430	24
66623335437	24
66623338632	23
66623338633	23
66623355103	22
66623355105	22
66623373553	5
66623373554	5
66623373555	5
66623373756	29
66623373757	29
66623373758	29
66623374818	27
66623374819	27
66623374824	27
66623376000	58
66623390500	24
66623390501	24
66623390502	24
66623390503	7
66623390504	7
66623390505	7
66623390506	7
66623390507	7
66623390508	7
66623390509	7
66623390510	7
66623390511	7
66623390512	7
66623390513	7
66623390514	7
66623390517	7
66623390518	7

PART #	PAGE
66623390519	7
66623390520	7
66623390521	7
66623390522	7
66623390523	7
66623390700	53
66623390701	53
66623390702	53
66623390703	53
66623390704	53
66623390705	53
66623390706	53
66623390707	53
66623390708	53
66623390709	53
66623390710	53
66623390711	53
66623390712	53
66623390713	53
66623390714	53
66623390715	53
66623390998	73-74
66623390999	73-74
66623391000	62
66623391001	62
66623391003	62
66623391007	62
66623391008	61
66623391009	63
66623391010	62
66623391013	61
66623391014	61
66623391015	61
66623391016	61
66623391017	61
66623391018	61
66623391019	61
66623391306	64
66623391307	64
66623391308	64
66623391309	64
66623391310	64
66623391311	64
66623391312	64
66623391313	64
66623391314	64
66623398278	29
69957308899	4
69957308900	4
69957308901	4
69957308902	4
69957308903	4
69957312400	33
69957312633	34
69957312636	34
69957312637	34
69957312638	34
69957312640	33
69957312641	33
69957312643	33
69957312646	33
69957312647	34
69957318100	66
69957318101	66
69957318102	66
69957318103	66

PART #	PAGE
69957345359	29
69957365500	4
69957382154	35
69957382155	35
69957392150	29
69957394363	13
69957394449	13
69957394450	13
69957394456	6
69957394457	6
69957394459	6
69957394463	6
69957394464	6
69957394466	6
69957394470	6
69957394472	6
69957394474	6
69957396645	6, 13, 34
69957396646	6, 13, 34
69957396648	6, 13, 34
69957398005	28
69957398006	28
69957398007	28
69957398009	28
69957398010	28
69957398011	28
69957398012	28
69957398014	28
69957398015	28
69957398016	28
69957398017	28
69957398021	29
69957398022	29
69957398023	29
77696007745	5
77696007753	5
77696007755	5
77696007756	5
77696007757	5
77696007760	5
77696007762	5
77696007763	5
77696007765	5
77696007768	5
77696007770	5
77696007773	5
77696007774	5
77696007775	5
77696007776	5
77696007777	5
77696007778	5
77696007781	5
77696007784	5
77696007785	5
77696007786	5
77696007787	5
77696007788	5
77696007791	5
77696007793	5
77696007795	5
77696008407	28
77696008412	28
77696008413	28
77696008414	28
77696008422	28
77696008429	28

PART #	PAGE
77696008430	28
77696008431	28
77696008432	28
77696008440	28
77696008471	28
77696008474	28
77696008475	28
77696010018	28
77696069243	29
77696069244	29
77696069245	29
77696069246	29
77696075500	20
77696075502	20
77696088701	16
77696088702	16
77696088703	16
77696088704	16
77696088713	16
77696088714	16
77696088715	16
77696088716	16
77696090145	26
77696090146	26
77696090147	26
77696090148	26
77696090149	26
77696090150	26
77696090151	26
77696090152	26
77696090153	26
77696090154	26
77696090165	26
77696090166	26
77696090167	26
77696090168	26
77696090169	26
77696090170	26
77696090171	26
77696090172	26
77696090173	26
77696090174	26
77696090285	83
77696090286	83
77696090287	83
77696090288	83
77696090289	83
77696090290	83
77696090291	83
77696090292	83
77696090293	83
77696090294	83
77696090295	83
77696090296	83
77696090297	83
77696090298	83
77696090299	83
77696090300	83
77696090301	83
77696090302	83
77696090303	83
77696090304	83
77696090305	83
77696090306	83
77696095005	5
77696095006	5

PART #	PAGE	PART #	PAGE	PART #	PAGE	PART #	PAGE
77696095007	5	80849810019	77	80849810073	79	80849810167	69-70
77696095008	5	80849810020	77	80849810075	73-74	80849810168	69
77696095009	5	80849810023	76	80849810076	79	80849810169	69
77696095010	5	80849810025	76	80849810078	78	80849810170	73, 75
77696095011	5	80849810026	77	80849810079	78	80849810171	73, 75
77696095012	5	80849810027	77	80849810105	79	80849810172	67-68
77696095013	5	80849810029	69-70	80849810106	69-70	80849810175	67-68
77696095014	5	80849810030	69-70	80849810107	69-70	80849810177	77
77696095015	5	80849810033	69, 72	80849810111	78	80849810178	78
77696095016	5	80849810034	69, 71	80849810120	77	80849810179	73-74
78072728567	29	80849810035	67	80849810121	76	80849810180	73-74
78072728568	29	80849810036	67-68	80849810129	73, 75		
78072728569	29	80849810037	73	80849810130	79		
78072736062	29	80849810038	69, 72	80849810132	76		
78072740295	29	80849810039	69, 71	80849810133	76		
80849810001	69, 71	80849810041	73	80849810134	76		
80849810005	67-68	80849810042	69, 71	80849810145	79		
80849810006	67-68	80849810043	69, 71	80849810146	78		
80849810007	67	80849810045	73	80849810149	73-74		
80849810008	67-68	80849810049	69-70	80849810158	73, 75		
80849810010	73-74	80849810050	69, 72	80849810159	73, 75		
80849810011	73, 75	80849810058	73, 75	80849810160	73, 75		
80849810013	73	80849810060	69, 72	80849810161	73, 75		
80849810015	69, 71	80849810066	79	80849810165	69, 71		
80849810016	69, 71	80849810067	79	80849810166	69-70		



NORTON AUTOMOTIVE AFTERMARKET REFINISHING PRODUCTS



YOUR PRODUCTIVITY PARTNER

A select group of industry leaders has come together to leverage their core expertise into one powerful network to assist you in improving your refinishing process and increasing your profitability.

NORTON

SAINT-GOBAIN

QUALITY ABRASIVES

New and different solutions for body shops that demand increased productivity, consistent quality and enhanced cost control



ULTIMATE PAINT PROTECTION AND WINDOW FILMS

Window and body films that act as body armor helping to guard the vehicle from damaging elements



SUPERIOR MASKING TAPE

Innovative and high quality automotive surface protection and masking tape products for the unique needs of the collision repair market



FIRST-CLASS SPRAY GUNS AND PAINT CUPS

Pioneering product portfolio of paint guns and cups that deliver glass-like finishes to the collision repair market



PARAMOUNT REPAIR ADHESIVES

Known for cutting-edge OEM approved products and expertise in providing collision repair adhesive solutions.



SUPREME DETAILING PRODUCTS

High performance polishes, waxes, and cleaners designed to help the professional detailer attack any imperfection and deliver a flawless finish



TAKE NORTON FOR A TEST DRIVE

Norton is 100% committed to bringing the best performing products to body shops at a fair price.

You can test drive Norton products in your shop when it's convenient for you. Simply let your Norton salesperson know when you'd like to test Norton in your shop. Our test drive program allows the technicians to do their regular work, without interruption, using Norton products at no cost in "real world" conditions. You're the final judge of performance.

At the end of the day, the Norton salesperson will review the results, provide you with potential cost savings and convert the shop to Norton products if you like what you see.

There has never been a better time to look at ways to increase productivity and to reduce costs at absolutely no risk to you.





CATALOG #340

STOCK ABRASIVE PRODUCTS
**DO-IT-YOURSELF
& CONTRACTOR
MARKET**



SANDING MADE **EASIER**™



Hand Sanding

Abrasive Sheets 4
Abrasive Sponges 11
Abrasive Rolls 14



Drywall Sanding

Abrasives 15
Tools 18



Power Sanding

Discs 20
Detail 28
Belts 29



Cutting & Grinding

Diamond Products 33
Grinding Wheels / Blades 34
Wire Products 41



Surface Prep & Clean

Plastic Coverings 44
Masking Tape 45
Pads & Rolls 46
Cloths 48
Safety Accessories 49



Woodworking

Discs 50
Belts 61
Sharpening Stones 64



Merchandising

Racking 65
Signage 67

Norton Trademarks

All trademarks used in these pages are trademarks of Saint-Gobain Abrasives, unless otherwise indicated.

- | | | | |
|--------------------|---------------------|--------------|---------------|
| Adalox® | Clamp & Sand™ | No-Fil® | Slicer™ |
| Black Ice™ | Handy Pack™ | Norax® | Soft Touch® |
| BlueFire® | Hook & Sand™ | Norton® | Speed-Lok® |
| Charger™ | Job Pack™ | Norton SG® | Spiraband® |
| Classic™ | 4x4 MaxCut™ | NorZon® | Stick & Sand® |
| DrillSand™ | Merit® | NorZon® Plus | TufBak® |
| DryIce® | Metalite® | PowerFlex™ | ValuPlus™ |
| DUO® | MetalSand™ | ProSand® | WallSand™ |
| Durite® | MultiSand™ | Rapid Strip™ | WoodSand™ |
| Gemini® | Multi-Air® | Red Heat® | |
| Get It. Finished.™ | Multi-Air Cyclonic® | SandWet™ | |

NORTON

SAINT-GOBAIN

ProSand®

OUR PRODUCT EVOLUTION IS YOUR CUSTOMER'S **EASIEST SANDING SOLUTION**

NORTON
SAINT-GOBAIN

ProSand®

WORLD'S BEST SANDPAPER®

Next Generation **3X** Technology.

For All Surfaces and Coatings
Pour toutes les surfaces
Para todas las superficies y capas

Sanding made easier!
Ponçage facilité!
¡El lijado hecho más fácil!

9" x 11" | 229 x 279 mm
SHEETS | FEUILLES | HOJAS

3 9" x 11" | 229 x 279 mm
SHEETS | FEUILLES | HOJAS

SMOOTHING
PRÉPARATION
PREPARADO

100 MEDIUM Grit
MOYEN Grain
MEDIO Grano

Moderate to light removal
Dégrossissage modéré à léger
Remoción entre moderada y liviana

GRIT GUIDE | GUIDE DE GRAIN | GUIA DEL GRANO

STRIPPING
60 80
DÉCAPAGE | REMOCIÓN

SMOOTHING
100 120 150
PRÉPARATION | PREPARADO

FINISHING
180 220 320 400
FINITION | ACABADO

#02620

GET IT. **FINISHED.**™

With Norton ProSand, we've packaged the best sanding sheets and sponges into a new look while raising the performance and durability level in order to deliver a new industry standard for sanding made easier.



What material are you hand sanding?

GENERAL WOOD, PAINT, PLASTIC, ETC.	DRYWALL & PLASTER	METAL & RUST	PRIMER, SEALER, TOP COATS
---	------------------------------	-------------------------	----------------------------------

What level of smoothness do you need?

GRIT	APPLICATION	GRIT	APPLICATION	GRIT	APPLICATION	GRIT	APPLICATION
Coarse	Stripping	Coarse	First Coat	Coarse	Stripping	Fine	Initial Coats
Medium	Smoothing	Medium	Second Coat	Medium	Smoothing	Super Fine	Between Coats
Fine	Finishing	Fine	Final Coat	Fine	Polishing	Ultra Fine	Final Finish

How large is the project?

Small to Medium Jobs with One Sanding Step: Sanding Sponge	Small Touch-Up Jobs: Sanding Sponge	Small to General Purpose Jobs: Sanding Sponge	Small to General Purpose Jobs: Sanding Sponge
Medium to Larger Jobs with Multiple Sanding Steps: Sandpaper	Small to Medium DIY Jobs: Sanding Screen	Light Deburring and Cleaning: Non-Woven Pad	Large Jobs With Focus on High-End Finish: (i.e. Automotive Refinishing) Sandpaper

Do you want high performance and productivity or lowest initial cost?

Performance: Norton ProSand Sheets & Sponges	Performance: WallSand Screen	Performance: MetalSand Cloth Sheets, Metal Finishing Non-Woven	Performance: SandWet Sheets
Opening Price Point: MultiSand Sheets & Sponges	Opening Price Point: WallSand Paper, WallSand Sponges	Opening Price Point: MultiSand Sponges	Opening Price Point: SandWet Sponges

ProSand

Premium abrasive provides superior cut on all surfaces, lasts substantially longer and cuts faster than conventional abrasives and has been open abrasive grain coated to resist clogging and loading during sanding. Available in a wide range of grits to tackle any job, ProSand Sheets are perfect for sanding paint, drywall, and wood.



Application/Grit Recommendation Guide

Finer									Coarser
400 Final Finish	320 Between Coats Sanding	220 Sanding Initial Coats	180 Final Surface Smoothing	150 Fine Surface Preparation	120 Surface Leveling	100 Moderate To Light Removal	80 Moderate Removal	60 Heavy Removal	

FEATURES & BENEFITS

- Premium heat-treated abrasive offers faster cut and longer sanding life than 3X technology. Heat treating toughens the grain allowing it to stay sharp and last longer under extreme pressure, making it the most durable abrasive on the market. Super sharp edges allow grain to remove material faster.
- Increased backing weight. Fiber reinforcement and latex saturation offer better grain retention with higher flexibility for easy folding and unfolding without tearing.
- Non-pigmented, waterbased stearate, anti-clog (No-Fil) open coat design. Anti-clog provides best resistance to premature loading during sanding.
- No color dye in coating process so there is no chance of color transfer to work piece.

Testimonial

I shall continue to only have Norton abrasives in my shop. I've only come across one other brand that could compete in the past, but your ProSand is like a quantum leap above the rest.

- Jim Attwooll

PERCENTAGE STOCK REMOVAL 80, 150, & 200 GRIT SEQUENCE

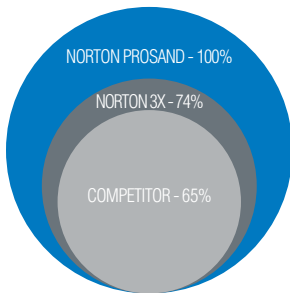

* PERCENTAGE BASED ON TOTAL GRAMS CUT OVER 12 MINUTES OF SANDING ON RED OAK WITH VIBRATING SHEET SANDER

* Results based on internal testing performed using a vibrating sheet sander. Performance data reflects cumulative stock removal of red oak panels over the course of an 80, 150, 220 grit sanding sequence.

PART #	UPC-A	GRIT	GRADING	QTY/ PACK	PACKS/ CASE
Handy Packs					
9" x 11"					
07660768156	076607 02612 5	400	Super Fine	3	25**
07660768157	076607 02613 2	320	Extra Fine	3	25**
07660768158	076607 02616 3	220	Very Fine	3	25**
07660768159	076607 02617 0	180	Fine	3	25**
07660768160	076607 02618 7	150	Medium	3	25**
07660768161	076607 02619 4	120	Medium	3	25**
07660768162	076607 02620 0	100	Medium	3	25**
07660768163	076607 02621 7	80	Coarse	3	25**
07660768164	076607 02622 4	60	Coarse	3	25**
07660768182	076607 05386 2	Asst.	1 each of 60, 100, 150 & 220	4	25**
4-1/2" x 4-1/2" - Stick & Sand					
07660768177	076607 05311 4	220	Very Fine	4	20**
07660768183	076607 05312 1	150	Medium	4	10**
07660768184	076607 05313 8	100	Medium	4	10**
07660768185	076607 05314 5	60	Coarse	4	10**
3-2/3" x 9" - Clamp & Sand					
07660768178	076607 05315 2	P220	Very Fine	4	20**
07660768179	076607 05316 9	P150	Medium	4	20**
07660768180	076607 05317 6	P100	Medium	4	20**
07660768181	076607 05318 3	P60	Coarse	4	20**
Job Packs					
9" x 11"					
07660768165	076607 02632 3	400	Super Fine	20	10**
07660768166	076607 02633 0	320	Extra Fine	20	10**
07660768167	076607 02636 1	220	Very Fine	20	10**
07660768168	076607 02637 8	180	Fine	20	10**
07660768171	076607 02638 5	150	Medium	20	10**
07660768172	076607 02639 2	120	Medium	20	10**
07660768173	076607 02640 8	100	Medium	20	10**
07660768174	076607 02641 5	80	Coarse	20	10**
07660768175	076607 02642 2	60	Coarse	20	10**

MultiSand

For general purpose hand or machine sanding wood, metal, plastic and fiberglass, as well as removing old paint.

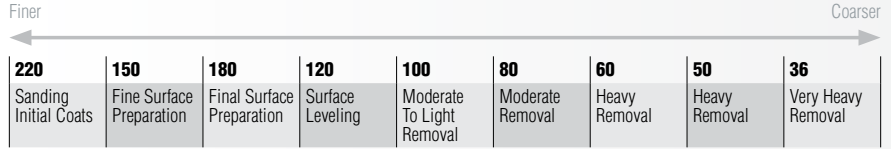

PART #	UPC-A	GRIT	GRADING	QTY/ PACK	PACKS/ CASE
Handy Packs					
9" x 11" (A215, A213, A211)					
07660747710	07660747710	1	220	Very Fine	5 10
07660702769	07660747710	1	220	Very Fine	5 25**
07660747720	07660747720	0	150	Fine	5 10
07660702770	07660747720	0	150	Fine	5 25**
07660704154	07660747725	5	120	Medium	5 25**
07660747735	07660747735	4	100	Medium	5 10
07660702771	07660747735	4	100	Medium	5 25**
07660704153	07660747740	8	80	Coarse	5 25**
07660747750	07660747750	7	60	Coarse	3 10
07660702772	07660747750	7	60	Coarse	3 25**
07660747765	07660747765	1	Asst.	2 VF, 2F, 1M	5 10
07660704155	07660747765	1	Asst.	2 VF, 2F, 1M	5 25**
4-1/2" x 11" (A215, A213, A211)					
07660702050	07660748353	9	150	Fine	6 10**
07660702051	07660748354	6	100	Medium	6 10**
07660702052	07660748355	3	60	Coarse	4 10**
4-1/2" x 5-1/2" (A215, A213, A211)					
07660705441	07660748132	0	220	Very Fine	6 10**
07660705442	07660748300	3	150	Fine	6 10**
07660705444	07660748301	0	100	Medium	6 10**
07660705445	07660748302	7	60	Coarse	6 10**
07660702057	07660748130	6	Asst.	2VF, 2F, 2M	6 10**
4-1/2" x 4-1/2" (A413, A213)					
07660705447	07660749126	8	220	Very Fine	5 10**
07660705446	07660749127	5	150	Fine	5 10**
07660705452	07660749128	2	100	Medium	5 10**
07660705453	07660749129	9	60	Coarse	5 10**
3-2/3" x 9" (A215, A213, A211)					
07660748295	07660748295	2	150	Fine	6 20**
07660748310	07660748310	2	100	Medium	6 20**
07660748325	07660748325	6	60	Coarse	6 20**
07660748335	07660748335	5	Asst.	3F, 2M, 1C	6 20**
07660702061	07660748335	5	Asst.	3F, 2M, 1C	6 10
3-2/3" x 25' Sheet Roll (A213)					
07660784250	07660784250	3	150	Fine	1 9**
07660784251	07660784251	0	100	Medium	1 9**
07660784252	07660784252	7	60	Coarse	1 9**

PART #	UPC-A	GRIT	GRADING	QTY/ PACK	PACKS/ CASE
Job Packs					
9" x 11" (A215, A213, A211)					
07660700354	07660700354	6	220A	Very Fine	25 10**
07660700355	07660700355	3	180A	Fine	25 10**
07660700356	07660700356	0	150C	Fine	25 10**
07660700357	07660700357	7	120C	Medium	25 10**
07660700358	07660700358	4	100C	Medium	25 10**
07660768109	07660768109	6	80D	Coarse	25 5
07660768108	07660768108	9	60D	Coarse	25 5
07660768111	07660768111	9	50D	Coarse	25 5
07660768110	07660768110	2	36D	Ex. Coarse	25 5
07660700365	07660700365	2	Asst.	Asst.	25 10**
Rolls					
2-3/4" x 30/45 yds. Stick & Sand Sheet Roll (A275)					
66261131681	66261131681	1	P400B	Very Fine	1 -
66261131683	66261131683	5	P320B	Very Fine	1 -
66261131685	66261131685	9	P240B	Very Fine	1 -
66261131686	66261131686	6	P220B	Very Fine	1 -
66261131687	66261131687	3	P180B	Fine	1 -
66261131688	66261131688	0	P150B	Fine	1 -
66261131689	66261131689	7	P120B	Medium	1 -
66261131690	66261131690	1	P100B	Medium	1 -
4-1/2" x 10 yds. (30') Stick & Sand Sheet Roll (A290)					
07660749247	07660749247	0	P320C	Very Fine	1 10**
07660749248	07660749248	7	P220C	Very Fine	1 10**
07660749249	07660749249	4	P180C	Fine	1 10**
07660749250	07660749250	0	P150C	Fine	1 10**
07660749251	07660749251	7	P120C	Fine	1 10**
07660749252	07660749252	4	P100C	Medium	1 10**
07660749254	07660749254	8	P80C	Coarse	1 10**
3-1/2" x 25 yds. (A211, A213)					
07660704148	07660704148	7	150	Fine	1 5
07660704147	07660704147	0	120	Medium	1 5
07660704146	07660704146	3	100	Medium	1 5
07660704145	07660704145	6	80	Coarse	1 5
3-1/2" x 50 yds. (A213, A211)					
07660784042	07660784042	4	150	Fine	1 5
07660784024	07660784024	0	120	Medium	1 5
07660784025	07660784025	7	100	Medium	1 5
07660784002	07660784002	8	80	Coarse	1 5

Accessories

	Rubber Hand Sanding Block	07660701889	07660743140	1	5
	Hook and Loop Finishing Sander - Handy Packs	07660768239	07660768239	1	5

	Hook and Loop Detail Sander - Handy Packs	07660768240	07660768240	1	5
	Hook and Loop Detail Sander - Handy Packs	07660768275	07660768275	1	10



WoodSand

For preparation of bare wood surfaces where stain or finishes are to be applied. The natural garnet abrasive imparts a fine, smooth finish on wood.

Finer

Coarser

220	180	150	120	100	80	60
Sanding Initial Coats	Final Surface Smoothing	Fine Surface Preparation	Surface Leveling	Moderate To Light Removal	Moderate Removal	Heavy Removal

PART #	UPC-A	GRIT	GRADING	QTY/ PACK	PACKS/ CASE
Handy Packs					
9" x 11"					
07660747965	076607 47965 5	220	Very Fine	5	10
07660747980	076607 47980 8	150	Fine	5	10
07660747990	076607 47990 7	100	Medium	5	10
07660748010	076607 48010 1	60	Coarse	3	10
07660748025	076607 48025 5	Asst.	2VF, 2F, 1M	5	10
Job Packs					
9" x 11"					
07660701579	076607 01579 2	220A	Very Fine	25	10**
07660701580	076607 01580 8	180A	Fine	25	10**
07660705507	076607 05507 1	150A	Fine	25	10**
07660705506	076607 05506 4	120A	Medium	25	10**
07660705505	076607 05505 7	100A	Medium	25	10**
07660705504	076607 05504 0	80A	Coarse	25	10**

PART #	UPC-A	GRIT	GRADING	QTY/ PACK	PACKS/ CASE
Job Packs - UPC Bar Coded					
9" x 11"					
07660701581	076607 01581 5	150C	Fine	25	10**
07660701582	076607 01582 2	120C	Medium	25	10**
07660701583	076607 01583 9	100C	Medium	25	10**
07660701584	076607 01584 6	80C	Coarse	25	10**



MetalSand

For removing rust, paint and scale from metal surfaces. Also used for light deburring and cleaning. The natural emery abrasive is coated onto a flexible cloth backing for increased durability.

Finer

Coarser

Fine	Medium	Coarse
Polishing	Moderate Removal	Heavy Removal

PART #	UPC-A	GRIT	GRADING	QTY/PACK	PACKS/CASE
Handy Packs					
9" x 11"					
07660747805	076607 47805 4	Fine	Fine	3	25**
07660747820	076607 47820 7	Medium	Medium	3	25**
07660747835	076607 47835 1	Coarse	Coarse	3	25**
07660747855	076607 47855 9	Asst.	1F, 1M, 1C	3	25**

SandWet

For wet, oil or dry sanding primer, sealer, varnish, lacquer, enamel and other top coats.

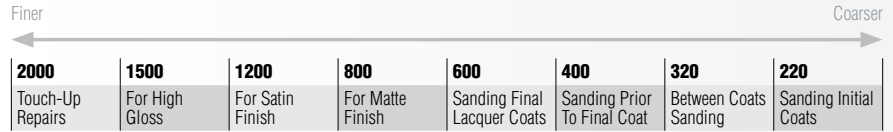

PART #	UPC-A	GRIT	GRADING	QTY/ PACK	PACKS/ CASE
Handy Packs					
9" x 11"					
07660748052	076607 48052 1	2000		5	10
07660748053	076607 48053 8	1500		5	10
07660748054	076607 48054 5	1200		5	10
07660748055	076607 48055 2	800		5	10
07660748058	076607 48058 3	600	Ultra Fine	5	10
07660702343	076607 48058 3	600	Ultra Fine	5	25**
07660748060	076607 48060 6	400	Super Fine	5	10
07660702344	076607 48060 6	400	Super Fine	5	25**
07660748080	076607 48080 4	320	Extra Fine	5	10
07660702345	076607 48080 4	320	Extra Fine	5	25**
07660748090	076607 48090 3	220	Very Fine	5	10
07660748110	076607 48110 8	Asst.	2 SF, 2EF, 1VF	5	10

PART #	UPC-A	GRIT	GRADING	QTY/ PACK	PACKS/ CASE
Job Packs					
9" x 11"					
07660701223	076607 01223 4	600A		25	10**
07660701224	076607 01224 1	400A		25	10**
07660701225	076607 01225 8	320A		25	10**
07660701226	076607 01226 5	220A		25	10**



TIP

How to Cut a 9" x 11" Full Sheet to Fit Your Sander

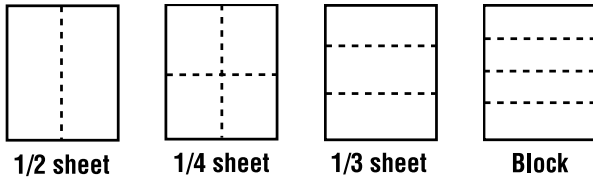

Bulk Full Sheets

ProSand No-Fil Adalox A259PS

Premium, P-graded aluminum oxide abrasive with fiber-reinforced backing. Specially coated to resist loading and tearing for three times the life over conventional aluminum oxide products. First choice when performance counts on sanding tough finishes or looking for exceptional finish. High flexibility.

Premium No-Fil Adalox A275 (B-wt)

Premium, P-graded aluminum oxide abrasive resin bonded to a B-weight backing. Specially coated to resist loading and tearing over conventional aluminum oxide products.

No-Fil Merit PB273 (B-wt)

P-graded aluminum oxide abrasive for fast cutting action and extended life with consistent finish. Flexible latex B-wt backing with a full resin bond and open coat allows for improved resistance to delamination. The water-based steared, non-pigmented No-Fil coating provides improved load resistance and no color transfer to the work piece.

Adalox A211 (D-wt), A212 (A-wt), A213 (C-wt)

For dry sanding hardwood, metal and composites by hand or machine. Long lasting, aluminum oxide abrasive is open coated on high tensile paper. A, C, D weight paper.

E-Z Flex Metalite K225 (J-wt)

For deburring, cleaning and polishing of metal. Rugged aluminum oxide abrasive is electro-coated onto a flexible cloth backing. Outperforms natural grains, like emery.

Garnet A511 (A-wt), A513 (C-wt), A514 (D-wt)

For rough through finish hand sanding of softer woods and cabinet work. Use dry on bare wood prior to coating. Natural garnet abrasive is electro-coated on high tensile paper. A, C, D weight paper.

Tufbak Durite Waterproof T461 (C-wt)

For sanding between coats of primers and other finishes on wood or metal with water or other lubricants. Diamond-like silicon carbide abrasive is electro-coated to a tough, waterproof paper backing.

Tufbak Durite Waterproof T401 (A-wt), T414 (A-wt)

For generating the ultimate finish in wet sanding applications. The premium ultra fine silicon carbide abrasive combined with a unique A-weight paper and strong resin bond system provides ultimate flexibility, long life and wet curl resistance.

Tufbak Waterproof T280 (A-wt)

For wet or dry sanding between coats as well as final sanding. The premium ultra fine P-graded aluminum oxide abrasive is coated on a durable waterproof paper providing an ultra fine finish with improved tear resistance.

No-Fil Durite A475 (B-wt)

For sanding between coats of primers and other finishes. The combination of sharp silicon carbide abrasive, a strong resin bond and special anti-clog coating gives it increased sanding life in dry applications.

Emery K622

For scouring and polishing non-rated metals and utensils. Emery abrasive is durabonded onto a flexible cloth backing.

PART #	UPC-A	GRIT	GRADING	QTY/ PACK	QTY/ CASE
9" x 11" Bulk - UPC Bar Coded					
ProSand A259PS (Aluminum Oxide) Paper - Open Coat					
07660702623	07660702623	1	P400B	100	500
07660702624	07660702624	8	P320B	100	500
07660702625	07660702625	5	P220B	100	500
07660702626	07660702626	2	P180B	100	500
07660702627	07660702627	9	P150B	100	500
07660702628	07660702628	6	P120B	100	500
07660702629	07660702629	3	P100B	50	250
07660702630	07660702630	9	P80C	50	250
07660702631	07660702631	6	P60C	50	250
Adalox (A212, A213) (Aluminum Oxide) Paper - Open Coat					
07660700156	07660700156	6	P220A	100	500
07660700157	07660700157	3	P180A	100	500
07660700158	07660700158	0	P150C	100	500
07660700159	07660700159	7	P120C	100	500
07660700160	07660700160	3	P100C	100	500
07660700151	07660700151	1	P80C	50	250
07660700152	07660700152	8	P60D	50	250
07660700153	07660700153	5	P50D	50	250
07660700154	07660700154	2	P40D	25	125
07660700155	07660700155	9	P36D	25	125
Garnet (A511, A513, A514) Paper - Open Coat					
07660701511	07660701511	2	220A	100	500
07660701512	07660701512	9	180A	100	500
07660701513	07660701513	6	150C	100	500
07660701514	07660701514	3	120C	100	500
07660701515	07660701515	0	100C	100	500
07660701516	07660701516	7	80C	50	250
07660701517	07660701517	4	60C	50	250
07660701518	07660701518	1	50D	50	250
Tufbak Waterproof T280 Paper - Close Coat					
07660701293	07660701293	7	600C	50	250
07660701294	07660701294	4	400C	50	250
07660701295	07660701295	1	320C	50	250
07660701296	07660701296	8	220C	50	250

Bulk Full Sheets

PART #	UPC-A	GRIT	GRADING	QTY/ PACK	QTY/ CASE
9" x 11" - UPC Bar Coded (continued)					
Emery K622 Cloth Close Coat					
07660701308	076607 01308 8	Fine		50	250
07660701309	076607 01309 5	Medium		50	250
07660701307	076607 01307 1	Coarse		25	125
66261101255	662611 01255 3	Ex. Coarse		25	125
9" x 11" Bulk - NON UPC					
Premium No-Fil Adalox A275 (Aluminum Oxide) Paper - Open Coat					
66261131618	662611 31618 7	P1500B		100	500
66261131619	662611 31619 3	P1200B		100	500
66261131620	662611 31620 0	P1000B		100	500
66261131621	662611 31621 7	P800B		100	500
66261131622	662611 31622 4	P600B		100	500
66261131624	662611 31624 8	P400B		100	500
66261131626	662611 31626 2	P320B		100	500
66261131627	662611 31627 9	P280B		100	500
66261131628	662611 31628 6	P240B		100	500
66261131629	662611 31629 3	P220B		100	500
66261131630	662611 31630 9	P180B		100	500
66261131631	662611 31631 6	P150B		100	500
66261131632	662611 31632 3	P120B		100	500
66261131633	662611 31633 0	P100B		100	500
66261131634	662611 31634 7	P80B		50	250
No-Fil Merit PB273 (Aluminum Oxide) Paper - Open Coat					
66623311870	6662331 1870 2	P400B		100	500
66623311871	6662331 1871 9	P320B		100	500
66623311879	6662331 1879 5	P240B		100	500
66623311873	6662331 1873 6	P220B		100	500
66623311874	6662331 1874 0	P180B		100	500
66623311875	6662331 1875 7	P150B		100	500
66623311876	6662331 1876 4	P120B		100	500
66623311877	6662331 1877 1	P100B		100	500
66623311878	6662331 1878 8	P80B		50	250
Adalox A211, A212, A213 (Aluminum Oxide) Paper - Open Coat					
66261100245	662611 00245 5	P180A		100	500
66261100285	662611 00285 1	P150C		100	500
66261100290	662611 00290 5	P120C		100	500
66261100295	662611 00295 0	P100C		100	500
66261100315	662611 00315 5	P80C		50	250
66261100320	662611 00320 9	P60D		50	250
66261100325	662611 00325 4	P50D		50	250
66261100330	662611 00330 8	P40D		25	125
66261100335	662611 00335 3	P36D		25	125
Garnet A511, A513, A514 Paper - Open Coat					
66261101488	662611 01488 5	220A		100	500
66261101489	662611 01489 2	180A		100	500
66261101490	662611 01490 8	150A		100	500
66261101495	662611 01495 3	120A		100	500
66261101500	662611 01500 4	100A		100	500
66261101505	662611 01505 9	80A		50	250
66261101525	662611 01525 7	150C		100	500
66261101530	662611 01530 1	120C		100	500
66261101535	662611 01535 6	100C		100	500
66261101555	662611 01555 4	80C		50	250
66261101560	662611 01560 8	60C		50	250
66261101570	662611 01570 7	40D		25	125
No-Fil Durite A475 (Silicon Carbide) Paper - Open Coat					
66254487400	662544 87400 6	P320B		100	500
66254487399	662544 87399 3	P240B		100	500
66254487398	662544 87398 6	P220B		100	500
66254487397	662544 87397 9	P180B		100	500
66254487396	662544 87396 2	P150B		100	500
66254487395	662544 87395 5	P120B		100	500
66254487394	662544 87394 8	P100B		100	500
66254487393	662544 87393 1	P80B		50	250

PART #	UPC-A	GRIT	GRADING	QTY/ PACK	QTY/ CASE
9" x 11" Bulk - NON UPC (continued)					
Tufbak Durite T401/T414 (Silicon Carbide) Waterproof Paper - Close Coat					
66261139377	662611 39377 5	P2500A		50	250
66261139378	662611 39378 2	P2000A		50	250
66261139379	662611 39379 9	P1500A		50	250
66261139380	662611 39380 5	P1200A		50	250
66261139381	662611 39381 2	P1000A		50	250
66261139382	662611 39382 9	800A		50	250
66261139360	662611 39360 7	600A		50	250
66261139361	662611 39361 4	500A		50	250
66261139362	662611 39362 1	400A		50	250
66261139363	662611 39363 8	360A		50	250
66261139364	662611 39364 5	320A		50	250
66261139365	662611 39365 2	280A		50	250
66261139366	662611 39366 9	240A		50	250
66261139367	662611 39367 6	220A		50	250
Tufbak Durite T461 (Silicon Carbide) Waterproof Paper - Close Coat					
66261130334	662611 30334 7	600C		50	250
66261130333	662611 30333 0	400C		50	250
66261130332	662611 30332 3	320C		50	250
66261130331	662611 30331 6	240C		50	250
66261101150	662611 01150 1	180C		50	250
66261101155	662611 01155 6	150C		50	250
66261101160	662611 01160 0	120C		50	250
66261101165	662611 01165 5	100C		50	250
66261101170	662611 01170 9	80C		50	250
66261101175	662611 01175 4	60C		50	250
Metalite K225 (Aluminum Oxide) Cloth - Close Coat					
66261126330	662611 26330 6	P600J		50	250
66261126331	662611 26331 3	P400J		50	250
66261126332	662611 26332 0	P320J		50	250
66261126333	662611 26333 7	P280J		50	250
66261126334	662611 26334 4	P240J		50	250
66261126335	662611 26335 1	P220J		50	250
66261126336	662611 26336 8	P180J		50	250
66261126337	662611 26337 5	P150J		50	250
66261126338	662611 26338 2	P120J		50	250
66261126339	662611 26339 9	P100J		50	250
66261126340	662611 26340 5	P80J		25	125
66261101861	662611 01861 6	60X		25	125
66261101862	662611 01862 3	50X		25	125
9" x 10" Bulk - Non UPC					
Adalox A215 (Aluminum Oxide)					
66261101380	662611 01380 2	150	Fine	50	250
66261101385	662611 01385 7	100	Medium	50	250
66261101390	662611 01390 1	60	Coarse	50	250



ProSand

Our super-sharp abrasive and new coating method make these sponges resist clogging, cut faster and last longer than general sanding sponges and up to 5X longer than conventional sandpaper. The various sizes and grit combinations offer maximum versatility and flexibility for sanding curved, contoured or flat surfaces of wood, metal, paint, plastic, and drywall.



Testimonial

The corner sponge rides with the irregularities and leaves no marks, while also making a great looking sharp inside corner.

- Jack Faville

FEATURES & BENEFITS

- Durable, abrasive-coated foam lasts up to 5X longer than sandpaper with resistance to tearing
- High-performance, open-coat aluminum oxide grain cuts faster, lasts longer and resists clogging
- Flexible and conformable to shapes and contours making sanding of various surfaces and hard-to-reach areas easier
- Washable for extended life; rinse and reuse

PART #	UPC-A	GRIT	GRADING	QTY/ PACK	PACKS/ CASE
ProSand 5X Small Area - 2PK					
Ideal for small area paint and drywall repair. Firm sponge material and new ultra sharp grain offers faster cut and longer life.					
4-1/2" x 2-11/16" x 1"					
07660782063	07660782063	60	Coarse	2	8**
07660782064	07660782064	120	Medium	2	8**
07660782065	07660782065	180	Fine	2	8**
ProSand 5X Small Area - 1PK					
07660782070	07660782070	9 36	Ex. Coarse	1	16**
07660782071	07660782071	6 60	Coarse	1	16**
07660782072	07660782072	3 120	Medium	1	16**
07660782073	07660782073	0 180	Fine	1	16**
07660782074	07660782074	7 220	Very Fine	1	16**
07660782088	07660782088	4	Kit & Handle 120/Medium	1	4**
ProSand 5X Small Area - Job Packs					
07660782086	07660782086	0 60	Coarse	6	4**
07660782084	07660782084	6 120	Medium	6	4**
07660782085	07660782085	3 180	Fine	6	4**
ProSand 5X Single Angle					
Excellent for sanding into tight areas and corners when doing paint and drywall repair.					
4-1/2" x 3-1/2" x 1"					
07660782066	07660782066	2 80	Coarse	1	16**
07660782067	07660782067	9 120	Medium	1	16**
ProSand 5X Multi Angle					
Allows you to sand detailed surfaces such as crown molding and millwork that have unique profiles.					
4-1/2" x 3-11/16" x 1"					
07660782068	07660782068	6 80	Coarse	1	16**
07660782069	07660782069	3 120	Medium	1	16**
ProSand 5X Dual Angle					
Dual angle sponge gives you the versatility to reach difficult areas easily. Perfect for drywall applications where inside corners meet the ceiling.					
4-1/2" x 2-7/8" x 1"					
07660782075	07660782075	4 80	Coarse	1	16**
07660782076	07660782076	1 120	Medium	1	16**

PART #	UPC-A	GRIT	GRADING	QTY/ PACK	PACKS/ CASE
ProSand 5X Contour Sanding Pads					
Thin flexible pads allow you to sand areas that are rounded or contoured such as spindles, railings, casing and baseboards.					
4-1/2" x 5-1/2" x 3/16"					
07660782079	07660782079	2 36	Ex. Coarse	2	12**
07660782080	07660782080	8 60	Coarse	2	12**
07660782081	07660782081	5 120	Medium	2	12**
07660782082	07660782082	2 180	Fine	2	12**
07660782083	07660782083	9 220	Very Fine	2	12**
07660768221	07660768221	5 320	Extra fine	2	12**
ProSand 5X Extra Large Single Angle					
Designed for sanding larger areas specifically drywall joints. The easy to grip sponge delivers faster sanding and smoother finish over large areas.					
9" x 3-5/16" x 1"					
07660782077	07660782077	8 120	Medium	1	8**
ProSand 5X Sanding Sticks					
Unique design, this sponge allows you to sand areas where other products cannot. Ideal for sanding between stair spindles or other areas that are tight and close together.					
9" x 1" x 1"					
07660768140	07660782078	5 36/60/100	Asst.	1	8**
07660768139	07660768139	3 120/180/220	Asst.	1	8**
ProSand 5X Corner Sanding Sponge					
4-1/2" x 2-3/4" x 2-3/4"					
07660768141	07660768141	6 120	Medium	1	5**
ProSand 5X Extra Large Drywall Sponge - Handy Packs					
3-5/16" x 9" x 1" Coated 4 Sides					
07660768276	07660768276	5 120	Medium	1	8**
ProSand 5X Extra Large Drywall Sponge - Job Pack					
3-5/16" x 9" x 1" Coated 4 Sides					
07660768277	07660768277	2 120	Medium	3	5**



MultiSand

Offered in various styles and grits for general purpose sanding on a variety of materials.

PART #	UPC-A	GRIT	GRADING	QTY/ PACK	PACKS/ CASE
MultiSand Small Area					
Small, flexible sponge for general purpose sanding of a variety of materials. Coated 4 sides.					
4" x 2-3/4" x 1"					
07660702081	07660702081	9	F/M	F/M Bonus Pack 6	6 10**
07660702670	07660702081	9	F/M	F/M	1 75 OS*
07660721775	07660721741	7	F/VF	F/VF	1 16**
07660749502	07660749502	0	F/M	F/M	1 20**
07660749503	07660749503	7	M/C	M/C	1 20**
Bulk				Sponges/Case	
07660749504	07660749504	4	F/M	F/M Bar Coded	- 24
07660749505	07660749505	1	M/C	M/C Bar Coded	- 24
07660749506	07660749506	8	F/F	F/F Bar Coded	- 24
07660749507	07660749507	5	M/M	M/M Bar Coded	- 24
07660704735	07660704735	9	M/C	M/C	- 250
07660701875	07660701875	2	M/M	M/M	- 250
07660702600	07660702600	2	F/M	F/M	- 250
OS* = Off Shelf Pre-Loaded Display and contains 75 each of 02081					

PART #	UPC-A	GRIT	GRADING	QTY/ PACK	PACKS/ CASE
MultiSand Dual Angle					
Firm sponge with angled sides for sanding inside corners and crevices of hard to reach areas on a variety of materials. Coated 4 sides.					
4-7/8" x 2-7/8" x 1"					
07660702082	07660702082	6	F/M	F/M Bonus Pack 6	6 10**
07660700935	07660700935	7	F/M	F/M	1 24**
07660700936	07660700936	4	M/C	M/C	1 24**
MultiSand Contour Sanding Pads					
Thin, flexible, single-sided sponge for sanding small diameters and contours such as ceramics, spindles, turnings and railings. Coated 1 side.					
4-1/2" x 5-1/2" x 3/16"					
07660700937	07660700937	1	Ex. Fine	Ex. Fine	2 12**
07660700938	07660700938	8	Fine	Fine	2 12**
07660700939	07660700939	5	Medium	Medium	2 12**
Bulk				Sponges/Case	
07660702255	07660702255	4	Ex. Fine	Ex. Fine	100
07660702256	07660702256	1	Fine	Fine	100
07660702257	07660702257	8	Medium	Medium	100



SandWet Sponges

Premium Norton SandWet Waterproof Sponges deliver two-sided sanding that combines the performance of our premium Norton SandWet abrasive sheets with the convenience of a sanding sponge. Ideal for dust control, our sponges offer maximum versatility and flexibility for wet sanding of curved and flat surfaces of wood, metal, fiberglass and painted surfaces.

PART #	UPC-A	GRIT	GRADING	QTY/ PACK	PACKS/ CASE
4-3/4" x 2-7/8" x 1"					
07660768288	07660768288	8	2000	Ultra Fine	1 20
07660768289	07660768289	5	1500	Very Fine	1 20
07660768290	07660768290	1	1000	Fine	1 20

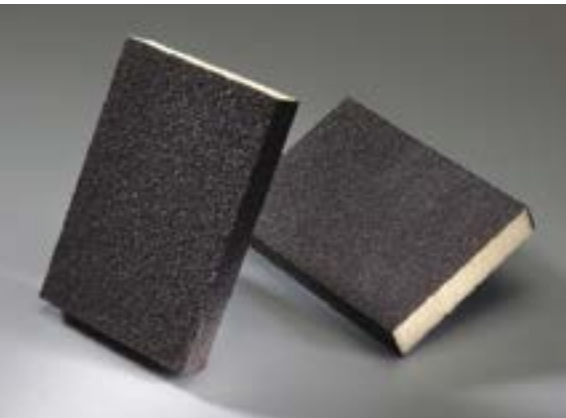



Specialty

Specialty sponges are a cost-effective solution for sanding hard to reach surfaces on a variety of materials.

PART #	UPC-A	GRIT	GRADING	QTY/ PACK	PACKS/ CASE
	Molding and Millwork				
Angled, flexible sanding abrasive for those hard to reach surfaces. Coated 4 sides.					
4-7/8" x 3-1/2" x 1"					
07660702286	076607 02286	8	Medium	1	12**

PART #	UPC-A	GRIT	GRADING	QTY/ PACK	PACKS/ CASE
	SoftTouch				
Coated on one side, these thin flexible sanding sponges are coated on closed cell foam to generate extremely consistent and uniformly fine scratch patterns necessary for applications such as sealer sanding and sanding between coats of primer or top coats.					
4-1/2" x 5-1/2" x 3/16"					
07660703078	076607 03078	8	Micro Fine	20	80**
07660703077	076607 03077	1	Ultra Fine	20	80**
07660703076	076607 03076	4	Super Fine	20	80**
07660703075	076607 03075	7	Fine	20	80**
07660703074	076607 03074	0	Medium	20	80**

PART #	UPC-A	GRIT	GRADING	QTY/ PACK	PACKS/ CASE
	Profile - Bulk				
Small, firm edge sponge for general purpose sanding of profiles and radiuses. Coated 3 sides.					
4" x 2-3/4" x 1/2"					
Sponges/Case					
63642536313	636425 36313	2	Medium	Medium	500
63642536314	636425 36314	9	Coarse	Coarse	500

PART #	UPC-A	GRIT	GRADING	QTY/ PACK	PACKS/ CASE
	Economy - Sander Sealer - Bulk				
Very flexible sponge coated with premium, silicon carbide abrasive for sanding primers, sealers, and between coats. Coated 2 sides.					
4-3/4" x 3-3/4" x 1/2"					
Sponges/Case					
63642552868	636425 52868	5	Very Fine	Very Fine	250
63642552869	636425 52869	2	Medium	Medium	250
63642552870	636425 52870	8	Coarse	Coarse	250
63642502538	636425 02538	2	Extra Coarse	Extra Coarse	250

PART #	UPC-A	GRIT	GRADING	QTY/ PACK	PACKS/ CASE
	Economy - Flexible - Handy Packs				
Economical, fabric-backed foam for sanding a variety of materials. Coated 1 side.					
3" x 4" x 1/2"					
07660700946	076607 00946	3	150	Fine	3
07660704030	076607 04030	5	150	Medium	3
07660700947	076607 00947	0	100	Medium	3
07660704031	076607 04031	2	100	Medium	3
07660700948	076607 00948	7	60	Coarse	3
07660704032	076607 04032	9	60	Coarse	3
07660701885	076607 01885	4	Asst.	1F, 1M, 1C	3
Economy - Flexible - Bulk					
3" x 4" x 1/2"					
Sponges/Case					
07660704069	076607 04069	5	220	Very Fine	108
07660700949	076607 00949	4	150	Medium	108
07660700950	076607 00950	0	100	Medium	108
07660704070	076607 04070	1	80	Coarse	108
07660701110	076607 01110	7	60	Coarse	108
07660704065	076607 04065	7	150	Fine	48
07660704066	076607 04066	4	100	Medium	48
07660704067	076607 04067	1	80	Coarse	48
07660704068	076607 04068	8	60	Coarse	48



Screen

For sanding where life and load resistance are most important. Coated on both sides with silicon carbide abrasive, the open mesh design also allows you to rinse and reuse.

- sanding plastic pipe prior to gluing
- preparing copper pipe and fittings prior to soldering
- sanding softer materials where loading is a major problem such as plaster, wood, drywall, brass, etc.

PART #	UPC-A	GRIT	GRADING	QTY/ PACK	PACKS/ CASE
Plumbers Waterproof Screen - Bulk					
1-1/2" x 25 yds. (Durite Q421)					
66261107265	66261107265	6	180	10	10
66261107270	66261107270	0	120	10	10
66261107275	66261107275	5	80	10	10

Paper

For fast, easy sanding when long life and consistent finish are most important. High strength latex backing offers superior strength and reduced edge wear. PSA backing for easy on/off.

- preparing primed and painted surfaces
- bare wood sanding

PART #	UPC-A	GRIT	GRADING	QTY/ PACK	PACKS/ CASE
Aluminum Oxide PSA Paper Rolls - Bulk					
4-1/2" x 10 yds. (30 ft.) Stick & Sand Sheet Roll (A275)					
66261131692	66261131692	7	P220B	1	5
66261131693	66261131693	4	P180B	1	5
66261131694	66261131694	1	P150B	1	5
66261131695	66261131695	8	P120B	1	5
66261131696	66261131696	5	P100B	1	5
66261131697	66261131697	2	P80B	1	5

MultiSand Stick & Sand Sheet Rolls also available - See page 6

Cloth

For general purpose sanding where flexibility and tear resistance are most important. Cloth backing provides increased strength and durability.

- hand strapping and light deburring
- blending machine tool marks
- cleaning pipe and tubing

PART #	UPC-A	GRIT	GRADING	QTY/ PACK	PACKS/ CASE
Cloth Handy Rolls - Handy Packs					
1" x 10 ft. (K225)					
07660748143	07660748143	6	320J	Extra Fine	1 20**
07660748144	07660748144	3	180J	Fine	1 20**
07660748145	07660748145	0	80J	Medium	1 20**

PART #	UPC-A	GRIT	GRADING	QTY/ PACK	PACKS/ CASE
Resin Cloth Rolls For Drum Sanders - Handy Packs					
3" x 35 ft. (R228)					
07660705292	07660705292	6	220X	Extra Fine	1 4
07660706048	07660706048	8	150X	Fine	1 4
07660705291	07660705291	9	120X	Fine	1 4
07660706049	07660706049	5	100X	Medium	1 4
07660705289	07660705289	6	80X	Medium	1 4

PART #	UPC-A	GRIT	GRADING	QTY/ PACK	PACKS/ CASE
Aluminum Oxide Cloth Rolls - Bulk					
1" x 50 yds. (Metalite K225, K224)					
66261126266	66261126266	8	P600J	1	5
66261126267	66261126267	5	P400J	1	5
66261126268	66261126268	2	P320J	1	5
66261126269	66261126269	9	P280J	1	5
66261126270	66261126270	5	P240J	1	5
66261126271	66261126271	2	P220J	1	5
66261126272	66261126272	9	P180J	1	5
66261126273	66261126273	6	P150J	1	5
66261126274	66261126274	3	P120J	1	5
66261126275	66261126275	0	P100J	1	5
66261126276	66261126276	7	P80J	1	5
66261127729	66261127729	7	P60X	1	5
66261127728	66261127728	0	P50X	1	5

PART #	UPC-A	GRIT	GRADING	QTY/ PACK	PACKS/ CASE
1-1/2" x 50 yds. (Metalite K225, K224)					
66261126278	66261126278	1	P600J	1	5
66261126279	66261126279	8	P400J	1	5
66261126280	66261126280	4	P320J	1	5
66261126281	66261126281	1	P280J	1	5
66261126282	66261126282	8	P240J	1	5
66261126283	66261126283	5	P220J	1	5
66261126284	66261126284	2	P180J	1	5
66261126285	66261126285	9	P150J	1	5
66261126286	66261126286	6	P120J	1	5
66261126287	66261126287	3	P100J	1	5
66261126288	66261126288	0	P80J	1	5
66261127731	66261127731	0	P60X	1	5
66261127730	66261127730	3	P50X	1	5

PART #	UPC-A	GRIT	GRADING	QTY/ PACK	PACKS/ CASE
2" x 50 yds. (Metalite K225, K224)					
66261126289	66261126289	7	P600J	1	5
66261126290	66261126290	3	P400J	1	5
66261126291	66261126291	0	P320J	1	5
66261126292	66261126292	7	P280J	1	5
66261126293	66261126293	4	P240J	1	5
66261126294	66261126294	1	P220J	1	5
66261126295	66261126295	8	P180J	1	5
66261126296	66261126296	5	P150J	1	5
66261126297	66261126297	2	P120J	1	5
66261126298	66261126298	9	P100J	1	5
66261126299	66261126299	6	P80J	1	5
66261127733	66261127733	4	P60X	1	5
66261127732	66261127732	7	P50X	1	5

WallSand Sheet - Paper & Screen

For sanding drywall compound and patching plaster prior to priming. Waterproof screen resists clogging because of its open mesh design. Just rinse and reuse. Paper sheets are the standard economical choice.



Application/Grit Recommendation Guide

Finer				Coarser			
400	320	220	180	150	120	100	80
Final Sanding	Final Sanding	Final Sanding	Final Sanding	Light Removal	Light Removal	Moderate Removal	Moderate Removal

Paper

PART #	UPC-A	GRIT	GRADING	QTY/ PACK	PACKS/ CASE
WallSand - Handy Packs					
4-3/16" x 11-1/4" Die-Cut (A412)					
07660702299	07660703251	5 120D	Final Coat	5	10
07660702533	07660703251	5 120D	Final Coat	5	20**
07660701888	07660703252	2 100D	Second Coat	5	10
07660702534	07660703252	2 100D	Second Coat	5	20**
07660701887	07660703253	9 80D	First Coat	5	10
07660702535	07660703253	9 80D	First Coat	5	20**
3-5/16" x 11" Die-Cut (A479)					
07660768243	07660768243	7 150	Fine	5	10**
07660768242	07660768242	0 120	Medium	5	10**
8" x 7" Hook & Loop (A290)					
07660768102	07660768102	7 150	Fine	3	10
07660768103	07660768103	4 100	Medium	3	10
3-2/3" x 9" Hook & Loop (A290)					
07660768100	07660768100	3 150	Fine	3	10
07660768101	07660768101	0 100	Medium	3	10
WallSand Job Packs					
4-3/16" x 11-1/4" Die-Cut (A412)					
07660701209	07660701209	8 150D	Very Fine	25	10**
07660701208	07660701208	1 120D	Fine	25	10**
07660704746	07660704746	5 100D	Medium	25	10**
07660704747	07660704747	2 80D	Coarse	25	10**
4-3/16" x 11-1/4" Die-Cut (A479)					
07660701864	07660701864	9 120	Medium	25	10
07660701863	07660701863	2 100	Medium	25	10
3-5/16" x 11" Die-Cut (A479)					
07660701862	07660701862	5 150	Fine	25	10
07660701861	07660701861	8 120	Medium	25	10
07660701860	07660701860	1 100	Medium	25	10

PART #	UPC-A	GRIT	GRADING	QTY/ PACK	PACKS/ CASE
WallSand - Bulk					
3-5/16" x 11" Die-Cut (UPC Bar Coded) (A412)					
07660701302	07660701302	6 150D	Medium	50	5
07660701303	07660701303	3 120D	Medium	50	5
07660701304	07660701304	0 100D	Medium	50	5
07660701305	07660701305	7 80D	Coarse	50	5
4-3/16" x 11-1/4" Die-Cut (Non UPC) (A412)					
66261104716	66261104716	6 150D	Medium	50	10
66261104717	66261104717	3 120D	Medium	50	10
66261104718	66261104718	0 100D	Medium	50	10
66261104719	66261104719	7 80D	Coarse	50	10
3-5/16" x 12" (Non UPC) (A412)					
66261104714	66261104714	2 100D	Medium	50	10
4-3/16" x 11-1/4" Die-Cut (UPC Bar Coded) (A479)					
07660701919	07660701919	6 150	Medium	100	-
07660701920	07660701920	2 120	Medium	100	-
07660701921	07660701921	9 100	Medium	100	-
4-3/16" x 11-1/4" Die-Cut (Non UPC) (C08110B)					
07660768286	07660768286	4 150	Medium	100	
07660768285	07660768285	7 120	Medium	100	
07660768284	07660768284	0 100	Medium	100	
07660768283	07660768283	3 80	Coarse	100	

Screen

PART #	UPC-A	GRIT	GRADING	QTY/ PACK	PACKS/ CASE
WallSand Handy Packs					
4-3/16" x 11-1/4" (Q421)					
07660721766	07660704173	9	220	Final Coat	2 20**
07660768320	07660704171	5	150	Second Coat	2 20**
07660721767	07660704169	2	120	First Coat	2 20**
WallSand Job Packs					
4-3/16" x 11-1/4" (Q421)					
07660721763	07660702049	9	220	Very Fine	10 10**
07660768321	07660768321	2	180	Fine	10 10**
07660721764	07660704748	9	150	Fine	10 10**
07660721765	07660704749	6	120	Medium	10 10**
07660768318	07660768318	2	100	Medium	10 10**
07660768319	07660768319	9	80	Coarse	10 10**

PART #	UPC-A	GRIT	GRADING	QTY/ PACK	PACKS/ CASE
WallSand Bulk					
3-5/16" x 11" Die-Cut (UPC Bar Coded) (Q421)					
07660701312	07660701312	5	220		25 -
07660701311	07660701311	8	180		25 -
07660701222	07660701222	7	150		25 -
07660701300	07660701300	2	120		25 -
07660701301	07660701301	9	100		25 -
9" x 11" (Non UPC) (Q421)					
66261100915	66261100915	7	400		25 -
66261100920	66261100920	1	320		25 -
66261100935	66261100935	5	220		25 -
66261100940	66261100940	9	180		25 -
66261100945	66261100945	4	150		25 -
66261100950	66261100950	8	120		25 -
66261100955	66261100955	3	100		25 -
66261100960	66261100960	7	80		25 -



WallSand Sponges

Offered in various styles and grits for sanding of paint and drywall.

PART #	UPC-A	GRIT	GRADING	QTY/ PACK	PACKS/ CASE
WallSand - Small Area					
Small area sanding abrasive for professional paint and drywall surface preparation. Coated 4 sides.					
4" x 2-3/4" x 1" (Bulk) Sponges/Case					
07660702263	07660702263	9	F/M	F/M	- 24
WallSand - Single Angle					
Single angle flexible sanding abrasive is designed for easy gripping to sand hard to reach areas of drywall. Coated 4 sides.					
4-7/8" x 2-7/8" x 1"					
07660702284	07660702284	4	Fine	Fine	1 24**
07660702285	07660702285	1	Medium	Medium	1 24**
WallSand - Dual Angle					
Extra firm sponge with angled sides for sanding inside corners of drywall compound. Coated 4 sides.					
4-7/8" x 2-7/8" x 1"					
07660700941	07660700941	8	F/M	F/M	1 24**
07660701886	07660700941	8	F/M	F/M	1 10**

PART #	UPC-A	GRIT	GRADING	QTY/ PACK	PACKS/ CASE
WallSand - Corner Sanding Sponge					
Extra firm sponge with wider faces for dual sanding capabilities. Create near perfect corners of an inside drywall corner. Coated 2 sides.					
3-3/4" x 7" x 4-1/2"					
07660701715	07660701715	4	Medium	Medium	1 8**
WallSand - Extra Large Area					
Oversized extra firm sponge for easier sanding of the entire drywall joint surface. Large size is easy to hold. Coated 4 sides.					
3-5/16" x 9" x 1"					
07660700944	07660700944	9	F/M	F/M	1 24**
07660701845	07660700944	9	F/M	F/M	1 5**
07660702487	07660702487	9	Hand Sander w/Clips, 1 Ex. Lg. Sponge Kit		1 5**



Discs & Rolls

Disc Application

Aluminum Oxide abrasive for ultra smooth finish of drywall compound. Anti-clog coating on disc decreases loading and promotes optimal dust collection. The rugged hook & loop fastening system assures quick and easy disc change.

Roll Application

Paper rolls offer an economical choice over precut sheets and screens. Generally preferred for larger jobs. Cut to desired length.

Paper Discs

PART #	UPC-A	GRIT	GRADING	QTY/ PACK	PACKS/ CASE
WallSand - Handy Pack					
9" Hook and Loop Discs (A290)					
07660768421	076607 68421 9	P220	Very Fine	3	5**
07660768420	076607 68420 2	P180	Very Fine	3	5**
07660768237	076607 68237 6	P150	Fine	3	5**
07660768419	076607 68419 6	P120	Fine	3	5**
07660768238	076607 68238 3	P100	Medium	3	5**
07660768418	076607 68418 9	P80	Coarse	3	5**
WallSand - Bulk - UPC Coded					
9" Hook & Loop Discs (Porter Cable 7800) (A290)					
66261156659	662611 56659 9	P220	Very Fine	15	15
66261158171	662611 58171 4	P180	Very Fine	15	15
07660702463	076607 02463 3	P150	Fine	15	15
07660702464	076607 02464 0	P120	Fine	15	15
07660702465	076607 02465 7	P100	Medium	15	15
07660702466	076607 02466 4	P80	Coarse	15	15
07660703292	076607 03292 8	Back-up Pad		1	10**

Paper Rolls

PART #	UPC-A	GRIT	QTY/ PACK	PACKS/ CASE
WallSand - Bulk - Non UPC				
3-1/2" x 50 yds. Rolls (A412, G215, A213)				
66261134425	662611 34425 8	150	1	5
07660701654	076607 01654 6	120	1	5
07660701655	076607 01655 3	100	1	5
07660701656	076607 01656 0	80	1	5
Foam Roll - Bulk - Non UPC				
3-5/16" x 12 yds. Perforated Foam Drywall Roll				
07660768300	076607 68300 7	180	1	5



WallSand Accessories

Norton WallSand Drywall Tools help deliver flawless results when sanding drywall. The lightweight, durable designs reduce fatigue and extend the life of the tool. The easy change handle allows you to convert from a hand sander to a pole sander for extra versatility. These premium products are guaranteed to help you achieve a fast and superior finish every time.





Testimonial

I am in the remodeling business, and I end up doing a lot of drywall finishing and wall repair. I really like the 9" round disc sander for big open areas and valley and butt joints on drywall.

- Jack Faville

	PART #	UPC-A	QTY/ PACK	PACKS/ CASE
	Easy snug clips tighten for secure fit. Firm handle provides solid grip. For use with die-cut drywall and plaster sanding sheets or screens on pages 15-16.			
Hand Sander	07660702411	07660702411 4	1	6**
	Use with threaded handle for sanding high walls and ceilings. For use with die cut drywall and plaster sanding sheets and screens on pages 15-16.			
Pole Sander	07660702412	07660702412 1	1	8**
	Ideal for sanding larger surface areas. The light-weight, circular design virtually eliminates flipping and allows change of direction up/down and left/right without lifting off the wall. Works with a 9" hook and loop sanding disc.			
9" 360 Disc Sander	07660768104	07660768104 1	1	6**
	9" 360 Disc Sander conveniently comes with a pole adaptor making this product ideal for sanding larger surface areas and increases the versatility to reach taller walls and ceilings. Works with 9" a hook and loop sanding disc.			
9" 360 Disc Sander with Pole Adaptor	07660768241	07660768241 3	1	6**

	PART #	UPC-A	QTY/ PACK	PACKS/ CASE
	Simultaneously sands both inside seams of a drywall corner. The light-weight, 90° design provides a smooth edge with less risk of wall damage commonly caused by sanding each side separately. Works with 8" x 7" hook and loop sanding sheet.			
Inside Corner Sander	07660768105	07660768105 8	1	6**
	Ideal for sanding hard to reach areas. The light-weight, 1/3 sheet hook and loop design eliminates fumbling with wing nuts and clamps. Works with 3-2/3" x 9" hook and loop sanding sheet.			
1/3 Sheet Sander	07660768106	07660768106 5	1	6**
	Easily converts Norton hand sanders to pole sanders for extra flexibility in stairwells, on ceilings and hard-to-reach areas.			
Pole Handle Adaptor	07660768107	07660768107 2	1	6**



What material are you power sanding?

GENERAL
WOOD, PAINT, PLASTIC,
FIBERGLASS, ETC.

Are you looking for speed or quality?

Fast Material Removal

Quality of Finish

What power tool are you using?

Belt Sander:
Portable Belts, Benchstand Belts

Random Orbital Sander:
Hook & Sand Discs, Stick & Sand Discs

Right Angle Grinder:
Rapid Strip Discs, Flap Discs, Fiber Discs

Palm Sander:
Hook & Sand Sheets, Stick & Sand Sheets

Detail Sander:
Model Specific Sheets

Drill:
Drill Sand Discs, Rapid Strip Wheels, Spirabands

How large is your project?

Small DIY/Weekend Job:
Handy Packs

Large Hobbyist Job:
Bulk

Multiple Day/Week Project:
Job Packs

Do you want high performance and productivity or low initial cost?

Performance:
Norton ProSand

Opening Price Point:
MultiSand

What material are you cutting or grinding?

METAL
STEEL, STAINLESS,
IRON, SHEETMETAL

MASONRY
CONCRETE BRICK, CINDER BLOCK,
CEMENT, PATIO STONE

Are you looking for speed or quality?

Right Angle Grinder:
Cut-off Blades - Depressed Center
Wheels - Cup Wheels - Wire Brushes

What power tool are you using?

Hand Held

Fixed Base

Circular Saws:
Cut-off Blades

Chop Saws:
Chop Saw Blades

High Speed Saws:
Cut-off Blades

Stationary Saws:
Cut-off Blades

How large is your project?

Small DIY/Weekend Job:
Handy Packs

Large Hobbyist Job:
Bulk

Multiple Day/Week Project:
Job Packs

Do you want high performance and productivity or low initial cost?

Performance:
Diamond Blades

Opening Price Point:
Abrasive Blades



ProSand Multi-Air Cyclonic

Revolutionary Norton ProSand Multi-Air Cyclonic hook and loop vacuum discs raise the bar in power sanding with a precision laser-cut, spiral-hole design that provides maximum dust extraction for a cleaner work environment with fewer disc changes and greater productivity.



Application/Grit Recommendation Guide

Finer									Coarser	
320	220	180	150	120	100	80	60	40		
Between Coats Sanding	Between Coats Sanding	Fine Surface Preparation	Moderate To Light Removal	Moderate To Light Removal	Moderate To Light Removal	Moderate Removal	Moderate Removal	Heavy Removal		

Testimonial

The paper is solid and lasts a long time.
- Eric Clevinger, The Poplar Shop

FEATURES & BENEFITS

- Precision laser-cut, spiral-hole hook & loop vacuum design removes material consistently throughout the life of the disc while maximizing dust extraction for a cleaner work environment
- Specialized multi-hole pattern allows for use on any random orbital sander regardless of hole pattern - including unique Festool®* sander models
- Premium ceramic abrasive provides a superior cut on all surfaces, lasts substantially longer and removes material faster than conventional abrasives and uses a No-Fil coating to resist clogging/loading during sanding
- Unique fiber-reinforced latex/paper backing is flexible, strong, and tear-resistant

PART #	UPC-A	GRIT	GRADING	QTY/ PACK	PACKS/ CASE
ProSand Hook & Sand - Handy Packs					
5" Multi-Air Cyclonic Discs					
07660703226	076607 03226 3	P320B	Extra Fine	3	15
07660703227	076607 03227 0	P220B	Very Fine	3	15
07660703228	076607 03228 8	P180B	Fine	3	15
07660703229	076607 03229 4	P150B	Medium	3	15
07660703230	076607 03230 0	P120C	Medium	3	15
07660703231	076607 03231 7	P100C	Medium	3	15
07660703232	076607 03232 4	P80C	Coarse	3	15
07660703233	076607 03233 1	P60	Coarse	2	15
07660703234	076607 03234 8	P40	Extra Coarse	2	15
ProSand Hook & Sand - Job Packs					
5" Multi-Air Cyclonic Discs					
07660703217	076607 03217 1	P320B	Extra Fine	10	10**
07660703218	076607 03218 8	P220B	Very Fine	10	10**
07660703219	076607 03219 5	P180B	Fine	10	10**
07660703220	076607 03220 1	P150B	Medium	10	10**
07660703221	076607 03221 8	P120C	Medium	10	10**
07660703222	076607 03222 5	P100C	Medium	10	10**
07660703223	076607 03223 2	P80C	Coarse	10	10**
07660703224	076607 03224 9	P60	Coarse	10	10**
07660703225	076607 03225 -6	P40	Extra Coarse	10	10**
6" Multi-Air Cyclonic Discs					
07660705320	076607 05320 6	P220B	Very Fine	10	10
07660705322	076607 05322 0	P150B	Medium	10	10
07660705324	076607 05324 4	P100C	Medium	10	10
07660705326	076607 05326 8	60	Coarse	10	10

PART #	UPC-A	GRIT	GRADING	QTY/ PACK	PACKS/ CASE
ProSand Hook & Sand - Job Packs					
5" Multi-Air Cyclonic Discs					
07660704041	076607 04041 1	P320B	Extra Fine	50	4
07660704038	076607 04038 1	P220B	Very Fine	50	4
07660704037	076607 04037 4	P180B	Fine	50	4
07660704036	076607 04036 7	P150B	Medium	50	4
07660704035	076607 04035 0	P120C	Medium	50	4
07660704034	076607 04034 3	P100C	Medium	50	4
07660704033	076607 04033 6	P80C	Coarse	50	4
66623374368	666233 74368 0	60	Coarse	50	4
07660768279	076607 68279 6	40	Extra Coarse	50	4
6" Multi-Air Cyclonic Discs					
07660705484	076607 05484 5	P220B	Very Fine	50	4
07660705486	076607 05486 9	P150B	Medium	50	4
07660705487	076607 05487 6	P120C	Medium	50	4
07660705488	076607 05488 3	P100C	Medium	50	4
07660705489	076607 05489 9	P80C	Coarse	50	4
07660705490	076607 05490 6	60	Coarse	50	4

Festool® is a registered trademark of TTS TOOLTECHNIC SYSTEMS AG & CO. KG



Hook & Sand

Norton Hook & Sand Discs offer a superior cut rate and consistent finish. The unique fiber-reinforced backing is edge tear-resistant and features a hook and loop backing that makes for quick and easy disc changes. Water-based zinc stearate coating reduces loading and prevents finish contamination.

Application/Grit Recommendation Guide

Finer ←									→ Coarser
320 Between Coats Sanding	220 Between Coats Sanding	180 Fine Surface Preparation	150 Moderate To Light Removal	120 Moderate To Light Removal	100 Moderate To Light Removal	80 Moderate Removal	60 Moderate Removal	40 Heavy Removal	

PART #	UPC-A	GRIT	GRADING	QTY/ PACK	PACKS/ CASE
Hook & Sand - Handy Packs					
5" x 5 Hole (A290)					
07660749165	07660749165	7 P220	Very Fine	4	15**
07660749166	07660749166	4 P150	Medium	4	15**
07660702206	07660702206	6 P120	Medium	4	15**
07660702207	07660702207	3 P80	Coarse	4	15**
5" x 8 Hole (A290)					
07660749155	07660749155	8 P220	Very Fine	4	15**
07660749156	07660749156	5 P150	Medium	4	15**
07660702208	07660702208	0 P120	Medium	4	15**
07660749157	07660749157	2 P100	Medium	4	15**
07660702209	07660702209	7 P80	Coarse	4	15**
07660749158	07660749158	9 P60	Coarse	4	15**
07660749159	07660749159	6 Asst.	2F, 1M, 1C	4	15**
5" x 5 and 8 Hole - Universal Vac Hole (A290)					
07660702001	07660702001	7 P220	Very Fine	4	15**
07660702003	07660702003	1 P150	Medium	4	15**
07660702005	07660702005	5 P100	Medium	4	15**
07660702007	07660702007	9 P60	Coarse	4	15**
07660702320	07660702320	9	Conversion Pad	1	15**
Kit					
5" Ergonomic Hook & Sand Hand Sander Disc Kit					
07660703968	07660703968	2 Kit	Pad with 5" Hook & Loop Discs	1	10

PART #	UPC-A	GRIT	GRADING	QTY/ PACK	PACKS/ CASE
Hook & Sand - Job Packs					
5" x 5 Hole (A290)					
07660749209	07660749209	8 P320	Extra Fine	25	10**
07660749210	07660749210	4 P220	Very Fine	25	10**
07660749211	07660749211	1 P180	Fine	25	10**
07660749212	07660749212	8 P150	Medium	25	10**
07660749213	07660749213	5 P120	Medium	25	10**
07660749214	07660749214	2 P100	Medium	25	10**
07660749215	07660749215	9 P80	Coarse	25	10**
07660749216	07660749216	6 P60	Coarse	25	10**
07660749217	07660749217	3 P40	Extra Coarse	20	10**
5" x 8 Hole (A290)					
07660749218	07660749218	0 P220	Very Fine	25	10**
07660749219	07660749219	7 P180	Fine	25	10**
07660749220	07660749220	3 P150	Medium	25	10**
07660749221	07660749221	0 P120	Medium	25	10**
07660749222	07660749222	7 P100	Medium	25	10**
07660749223	07660749223	4 P80	Coarse	25	10**
07660749224	07660749224	1 P60	Coarse	25	10**
07660749225	07660749225	8 P40	Extra Coarse	20	10**
5" x 5 and 8 Hole - Universal Vac Hole (A290)					
07660704056	07660704056	5 P320	Extra Fine	25	10**
07660704057	07660704057	2 P220	Very Fine	25	10**
07660704058	07660704058	9 P180	Fine	25	10**
07660704059	07660704059	6 P150	Medium	25	10**
07660704060	07660704060	2 P120	Medium	25	10**
07660704061	07660704061	9 P100	Medium	25	10**
07660704062	07660704062	6 P80	Coarse	25	10**
07660704063	07660704063	3 P60	Coarse	25	10**
07660704064	07660704064	0 P40	Extra Coarse	20	10**
6" x 6 Hole (A290)					
07660701635	07660701635	5 P220	Very Fine	25	10**
07660701634	07660701634	8 P150	Medium	25	10**
07660701637	07660701637	9 P120	Medium	25	10**
07660701633	07660701633	1 P100	Medium	25	10**
07660701636	07660701636	2 P80	Coarse	25	10**
07660701632	07660701632	4 P60	Coarse	25	10**



Stick & Sand

Norton Stick & Sand PSA Discs and Rolls feature a durable, sharp aluminum oxide grain for aggressive and cool cutting. The non-pigmented, water-based anti-clog coating resists loading and won't contaminate the finish. Pressure sensitive adhesive allows for quick and easy disc changes.

Application/Grit Recommendation Guide

Finer ←									→ Coarser	
320	220	180	150	120	100	80	60	40		
Between Coats Sanding	Between Coats Sanding	Fine Surface Preparation	Moderate To Light Removal	Moderate To Light Removal	Moderate To Light Removal	Moderate Removal	Moderate Removal	Heavy Removal		

PART #	UPC-A	GRIT	GRADING	QTY/ PACK	PACKS/ CASE
Stick & Sand (PSA) - Handy Packs					
5" x No Hole Disc (A290)					
07660705454	076607 48906	7 120	Medium	5	10**
07660705455	076607 48907	4 80	Coarse	5	10**
07660705456	076607 48908	1 40	Extra Coarse	4	10**
5" x 8 Hole Disc (A290)					
07660701809	076607 01809	0 220	Very Fine	5	15**
07660701811	076607 01811	3 150	Fine	5	15**
07660701812	076607 01812	0 100	Medium	4	15**
07660701815	076607 01815	1 60	Coarse	4	15**
6" x No Hole Disc (A290)					
07660702498	076607 48909	8 120	Fine	5	10
07660702499	076607 48910	4 80	Coarse	5	10
07660702500	076607 48911	1 40	Extra Coarse	4	10
Stick & Sand (PSA) - Job Packs					
5" x No Hole Disc Roll (A290)					
07660749231	076607 49231	9 P320	Extra Fine	50	10**
07660749232	076607 49232	6 P220	Very Fine	50	10**
07660749239	076607 49239	5 P150	Fine	50	10**
07660749236	076607 49236	4 P100	Medium	50	10**
07660749238	076607 49238	8 P80	Coarse	50	10**
07660749237	076607 49237	1 P60	Coarse	50	10**

PART #	UPC-A	GRIT	GRADING	QTY/ PACK	PACKS/ CASE
Stick & Sand (PSA) - Job Packs					
5" x 5 Hole Disc Roll (A290)					
07660701647	076607 01647	8 P220	Very Fine	50	10**
07660701646	076607 01646	1 P180	Fine	50	10**
07660701645	076607 01645	4 P150	Fine	50	10**
07660701644	076607 01644	7 P120	Medium	50	10**
07660701643	076607 01643	0 P100	Medium	50	10**
07660701642	076607 01642	3 P80	Coarse	50	10**
07660701641	076607 01641	6 P60	Coarse	50	10**
6" x No Hole Disc Roll (A290)					
07660749240	076607 49240	1 P220	Very Fine	50	10**
07660749242	076607 49242	5 P150	Fine	50	10**
07660749244	076607 49244	9 P100	Medium	50	10**
07660749246	076607 49246	3 P80	Coarse	50	10**
6" x 6 Hole Disc Roll (A290)					
07660701649	076607 01649	2 P220	Very Fine	50	10**
07660701650	076607 01650	8 P150	Fine	50	10**
07660701651	076607 01651	5 P100	Medium	50	10**
07660701652	076607 01652	2 P80	Coarse	50	10**



Cloth - Stick & Sand

Norton Cloth Stick & Sand PSA Discs are used for a variety of applications including rough sanding of primed and painted surfaces, stripping paint and primers, and heavy stock removal of wood, metal, plastic, and fiberglass.

Applications:

Electric Random Orbital Sanders

For use on contours or flat surfaces for light- to medium-pressure grinding, blending, leveling, and finishing applications.

Stationary Disc Sanders

Used in woodworking and metalworking for stock removal, sanding/grinding flat surfaces, dimensioning and finishing.

Application/Grit Recommendation Guide

Finer ←											→ Coarser										
320	220	180	150	120	100	80	60	50	40	36	320	220	180	150	120	100	80	60	50	40	36
Between Coats Sanding	Between Coats Sanding	Fine Surface Preparation	Moderate To Light Removal	Moderate To Light Removal	Moderate To Light Removal	Moderate Removal	Moderate Removal	Heavy Removal	Heavy Removal	Very Heavy Removal	Between Coats Sanding	Between Coats Sanding	Fine Surface Preparation	Moderate To Light Removal	Moderate To Light Removal	Moderate To Light Removal	Moderate Removal	Moderate Removal	Heavy Removal	Heavy Removal	Very Heavy Removal

PART #	UPC-A	GRIT	GRADING	QTY/ PACK	PACKS/ CASE
Cloth Stick & Sand Orbital/Bench Discs - Handy Packs					
5" Adhesive Backed Aluminum Oxide Cloth (R228)					
07660701994	07660701994	120X	Medium	2	15**
07660701996	07660701996	80X	Coarse	2	15**
07660701998	07660701998	50X	Coarse	2	15**
6" Adhesive Backed Aluminum Oxide Cloth (R228)					
07660701986	07660701986	220X	Very Fine	2	15**
07660701987	07660701987	120X	Medium	2	15**
07660701989	07660701989	80X	Coarse	2	15**
07660701991	07660701991	50X	Coarse	2	15**
8" Adhesive Backed Aluminum Oxide Cloth (R228)					
07660701981	07660701981	100X	Medium	3	15**
9" Adhesive Backed Aluminum Oxide Cloth (R228)					
07660705278	07660705278	180X	Fine	2	15**
07660701973	07660701973	120X	Medium	2	15**
07660701975	07660701975	80X	Coarse	2	15**
Cloth Adhesive Backed Aluminum Oxide (R228) - Bulk - Non UPC					
5"					
66261136581	66261136581	9	180X	Fine	50 250
66261136582	66261136582	6	150X	Medium	50 250
66261136583	66261136583	3	120X	Medium	50 250
66261136584	66261136584	0	100X	Medium	50 250
66261136585	66261136585	7	80X	Coarse	50 250
66261136586	66261136586	4	60X	Coarse	50 250
66261136587	66261136587	1	50X	Coarse	50 250
66261136588	66261136588	8	40X	Extra Coarse	50 250
66261136589	66261136589	5	36X	Extra Coarse	50 250

PART #	UPC-A	GRIT	GRADING	QTY/ PACK	PACKS/ CASE
Cloth Adhesive Backed Aluminum Oxide (R228) - Bulk - Non UPC					
6"					
66261136592	66261136592	5	180X	Fine	50 250
66261136593	66261136593	2	120X	Medium	50 250
66261136594	66261136594	9	100X	Medium	50 250
66261136595	66261136595	6	80X	Coarse	50 250
66261136596	66261136596	3	60X	Coarse	50 250
8"					
66261136355	66261136355	6	120X	Medium	50 250
66261136354	66261136354	9	80X	Coarse	50 250
66261136376	66261136376	5	60X	Coarse	50 250
66261136352	66261136352	5	50X	Coarse	50 250
66261136351	66261136351	8	40X	Extra Coarse	50 250
66261136350	66261136350	1	36X	Extra Coarse	50 250
9"					
66261125615	66261125615	5	120X	Medium	25 50
66261125616	66261125616	2	80X	Coarse	25 50 <i>NS</i>
10"					
66261136600	66261136600	7	100X	Medium	25 50
66261136601	66261136601	4	80X	Coarse	25 50
66261136602	66261136602	1	60X	Coarse	25 50
66261136607	66261136607	6	50X	Coarse	25 50
66261136604	66261136604	5	40X	Extra Coarse	25 50
66261136606	66261136606	9	36X	Extra Coarse	25 50
12"					
66261136613	66261136613	7	120X	Medium	25 50
66261136614	66261136614	4	100X	Medium	25 50
66261136615	66261136615	1	80X	Coarse	25 50
66261136620	66261136620	5	60X	Coarse	25 50
66261136625	66261136625	0	50X	Coarse	25 50
66261136630	66261136630	4	40X	Extra Coarse	25 50
66261136635	66261136635	9	36X	Extra Coarse	25 50

NS Non-Stock Item



Flap Disc

Our Norton flap disc portfolio offers right angle grinding versatility with a product that can grind and finish in a single operation. The abrasive flaps are adhered to a rigid backing plate. It is the back plate that provides stability during operation with cooler cut, less vibration and smoother finish without gouging.

Applications: Grinding, stock removal, edge chamfering/beveling, weld blending, deburring/deflashing, rust removal, blending, cleaning and finishing

NOTE: Use at 15°-25° angle. More severe angles will weaken edges.



Application/Grit Recommendation Guide

Finer					Coarser	
80	60	40	36	24		
Final Surface Smoothing	Moderate Removal	Moderate Removal	Heavy Removal	Heavy Removal		

PART #	UPC-A	GRIT	TYPE	QTY/ PACK	PACKS/ CASE
Norton BlueFire Flap Discs - Handy Packs					
4" x M-10 Hub (R884P)					
07660703216	07660703216	P80	Type 27	1	5**
07660703215	07660703215	P60	Type 27	1	5**
07660703214	07660703214	P40	Type 27	1	5**
4-1/2" x 5/8"-11 Hub (R884P)					
07660703213	07660703213	P80	Type 29	1	5**
07660703212	07660703212	P60	Type 29	1	5**
07660703211	07660703211	P40	Type 29	1	5**
7" x 5/8"-11 Hub (R884P)					
07660703207	07660703207	P80	Type 27	1	5**
07660703206	07660703206	P60	Type 27	1	5**
07660703205	07660703205	P40	Type 27	1	5**

Flap Disc Shapes

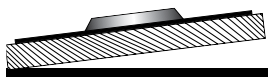

GRIND AT FLATTER ANGLES: 0° - 15°

Type 27 Flat - The Best Choice for Finishing

- Used primarily on flat surfaces
- The best choice for blending and smooth finishing

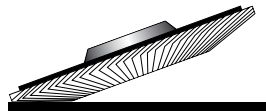

GRIND AT STEEPER ANGLES: 15° - 25°

Type 29 Conical - The Best Choice for Aggressive Stock Removal

- Conical flap discs have angled flaps and may be used on both contoured and edge work
- The angle provides greater surface contact for stock removal on flat surfaces
- The best choice when speed and stock removal are primary considerations

Abrasive Flap Densities



Standard Density

- Excellent for heavy-duty applications and rapid stock removal



High Density

- Ideal when working on uneven or curved surfaces, as well as finer grit blending

PART #	UPC-A	GRIT	TYPE	QTY/ PACK	PACKS/ CASE
Flap Discs - Bulk - Non UPC					
4-1/2" x 5/8"-11 Hub (KY672Z)					
66254419997	66254419997	P80	Type 29	10	10
66254419996	66254419996	P60	Type 29	10	10
66254419994	66254419994	P40	Type 29	10	10
4-1/2" x 7/8" (KY672Z)					
08834194360	08834194360	P80HD	Type 27	10	10
66254419987	66254419987	80	Type 29	10	10
08834190767	08834190767	60HD	Type 27	10	10
66254419984	66254419984	60	Type 29	10	10
08834190172	08834190172	P40HD	Type 27	10	10
66254419978	66254419978	40	Type 29	10	10
66254419963	66254419963	36	Type 29	10	10
5" x 7/8" (KY672Z)					
08834193652	08834193652	P80	Type 29	10	10
08834193651	08834193651	P60	Type 29	10	10
08834193650	08834193650	P40	Type 29	10	10
08834193649	08834193649	P36	Type 29	10	10
7" x 5/8"-11 (KY672Z)					
66254420013	66254420013	P80	Type 29	10	10
66254420012	66254420012	P60	Type 29	10	10
66254420010	66254420010	P40	Type 29	10	10
7" x 7/8"-11 (KY672Z)					
08834194362	08834194362	P80HD	Type 27	10	10
66254420008	66254420008	80	Type 29	10	10
08834194514	08834194514	P60HD	Type 27	10	10
66254420007	66254420007	60	Type 29	10	10
08834190933	08834190933	P40HD	Type 27	10	10
66254420006	66254420006	40	Type 29	10	10
66254420004	66254420004	36	Type 29	10	10
08834193725	08834193725	24	Type 29	10	10

HD = High Density



Fiber Disc

The most heavy-duty coated abrasive, Norton Fiber Discs feature resin-over-resin construction on heavy-duty vulcanized fiber backing. Designed for applications ranging from paint stripping and weld grinding to heavy metal removal. For use with back-up pads on portable angle grinders.

Application/Grit Recommendation Guide

Finer ←							→ Coarser	
120	100	80	50	36	24	16		
Final Surface Smoothing	Final Surface Smoothing	Final Surface Smoothing	Moderate To Light Removal	Heavy Removal	Heavy Removal	Heavy Removal		

PART #	UPC-A	DESCRIPTION	QTY/ PACK	PACKS/ CASE
Conversion Kits - Handy Packs				
4-1/2" x 7/8"				
07660701693	07660701693	5 1 Pad, 2-50 Medium A/O Fiber	1	5**
7" x 7/8"				
07660701703	07660701703	1 1 Pad, 2-50 Medium A/O Fiber	1	5**

PART #	UPC-A	GRIT	GRADING	STD/ PACK	
Air-Cooled Rubber Back-Up Pads - Bulk - Non UPC					
63642502122	63642502122	3	4-1/2"	Medium	5
63642543421	63642543421	4	5"	Medium	5
63642543425	63642543425	2	7"	Hard	5
63642543422	63642543422	1	7"	Medium	5
63642543426	63642543426	9	9"	Hard	5
63642543423	63642543423	8	9"	Medium	5

PART #	UPC-A	GRIT	QTY/ PACK	PACKS/ CASE
Norton BlueFire Zirconia Alumina Fiber - Bulk - Non UPC				
4-1/2" x 7/8" (Norton BlueFire F826)				
66261138452	66261138452	0	80	25 25
66261138453	66261138453	7	60	25 25
66261138454	66261138454	4	50	25 25
66261138456	66261138456	8	36	25 25
66261138457	66261138457	5	24	25 25
5" x 7/8" (Norton BlueFire F826)				
66261138600	66261138600	5	80	25 25
66261138601	66261138601	2	60	25 25
66261138561	66261138561	9	50	25 25
66261138562	66261138562	6	36	25 25
66261138563	66261138563	3	24	25 25
7" x 7/8" (Norton BlueFire F826)				
66261138590	66261138590	9	80	25 25
66261138591	66261138591	6	60	25 25
66261138592	66261138592	3	50	25 25
66261138593	66261138593	0	36	25 25
66261138594	66261138594	7	24	25 25
Ceramic Alumina Fiber - Bulk - Non UPC				
4-1/2" x 7/8" (Merit FX965)				
66623365598	66623365598	3	80	25 25
66623355604	66623355604	4	60	25 25
66623355603	66623355603	7	50	25 25
66623355602	66623355602	0	36	25 25
66623355601	66623355601	3	24	25 25
5" x 7/8" (Merit FX965)				
66623366015	66623366015	4	80	25 25
66623355600	66623355600	6	60	25 25
66623355599	66623355599	3	50	25 25
66623355598	66623355598	6	36	25 25
66623355597	66623355597	9	24	25 25
7" x 7/8" (Merit FX965)				
66623365600	66623365600	3	80	25 25
66623355596	66623355596	2	60	25 25
66623355595	66623355595	5	50	25 25
66623355594	66623355594	8	36	25 25
66623355578	66623355578	8	24	25 25

Fiber Discs

PART #	UPC-A	GRIT	QTY/ PACK	QTY/ CASE
Aluminum Oxide Fiber - Bulk - Non UPC				
4-1/2" x 7/8" (F240)				
66623353314	66623353314	4 120	25	25
66623353313	66623353313	7 100	25	25
66623353312	66623353312	0 80	25	25
66623353311	66623353311	3 60	25	25
66623353310	66623353310	6 50	25	25
66623353306	66623353306	9 36	25	25
66623353309	66623353309	0 24	25	25
5" x 7/8" (F240)				
66623357282	66623357282	2 120	25	25
66623357281	66623357281	5 100	25	25
66623357280	66623357280	8 80	25	25
66623357279	66623357279	2 60	25	25
66623357278	66623357278	5 50	25	25
66623357277	66623357277	8 36	25	25
66623357276	66623357276	1 24	25	25
05539510684	05539510684	4 16	25	25
7" x 7/8" (F240)				
66623357289	66623357289	1 120	25	25
66623357288	66623357288	4 100	25	25
66623357287	66623357287	7 80	25	25
66623357286	66623357286	0 60	25	25
66623357285	66623357285	3 50	25	25
66623357284	66623357284	6 36	25	25
66623357283	66623357283	9 24	25	25
05539510693	05539510693	6 16	25	25

PART #	UPC-A	GRIT	QTY/ PACK	QTY/ CASE
Aluminum Oxide Fiber - Bulk - UPC Bar Coded				
4-1/2" x 7/8" (F240)				
07660702045	07660702045	1 80	25	25
07660768186	07660768186	7 60	25	25
07660702046	07660702046	8 50	25	25
07660702047	07660702047	5 36	25	25
07660702048	07660702048	2 24	25	25
07660768187	07660768187	4 16	25	25
5" x 7/8" (F240)				
07660768188	07660768188	1 80	25	25
07660768189	07660768189	8 60	25	25
07660701909	07660701909	7 50	25	25
07660701910	07660701910	3 36	25	25
07660701911	07660701911	0 24	25	25
07660701915	07660701915	8 16	25	25
7" x 7/8" (F240)				
07660768190	07660768190	4 80	25	25
07660701912	07660701912	7 50	25	25
07660701913	07660701913	4 36	25	25
07660701914	07660701914	1 24	25	25
07660701916	07660701916	5 16	25	25



Rapid Strip

Norton Rapid Strip Non-Woven Discs and Wire Brushes are used for a variety of applications including: removing rust, light edge burrs, paint and parting lines.

PART #	UPC-A	GRADING	QTY/ PACK	PACKS/ CASE
Non-Woven - Drill Mount - Handy Packs				
4" x 1/2"				
07660701217	07660701217	3 Coarse	1	10**
4" x 1"				
07660705466	07660701220	3 Coarse	1	5**

PART #	UPC-A	GRADING	QTY/ PACK	PACKS/ CASE
Non-Woven - Depressed Center - Handy Packs				
4-1/2" x 5/8-11 Hub				
07660704015	07660704015	2 Extra Coarse	1	5**
7" x 5/8"-11 Hub				
07660704013	07660704013	8 Extra Coarse	1	5**



Spirabands

PART #	UPC-A	GRIT	GRADING	QTY/ PACK	PACKS/ CASE
BlueFire Spirabands - Handy Packs					
3/4" x 3/4" (H831, H875)					
07660703888	07660703888	3 120	Fine	4	10
07660703887	07660703887	6 100	Medium	4	10
07660703886	07660703886	9 60	Coarse	4	10
07660703889	07660703889	0 Mandrel		1	10
1" x 1" (H831, H875)					
07660703892	07660703892	0 120	Fine	3	10
07660703891	07660703891	3 100	Medium	3	10
07660703890	07660703890	6 60	Coarse	3	10
07660703893	07660703893	7 Mandrel		1	10
2" x 2" (H831, H875)					
07660703896	07660703896	8 120	Fine	2	5
07660703895	07660703895	1 100	Medium	2	5
07660703894	07660703894	4 60	Coarse	2	5
07660703897	07660703897	5 Mandrel		1	5



Quick-Change Disc

The tool-free, twist-on and off fastening systems of Norton quick-change discs make fast work of disc changes and maximize productivity by minimizing downtime.

Fiber

- Weld grinding
- Metal removal

Non-Woven

- Removing surface defects
- Blending mill marks, tool marks and uneven finishes

Type TR (Type III)

- Features a roll-on/roll-off style plastic fastener
- Equivalent to 3M™ Roloc™ fastening system

PART #	UPC-A	GRIT	GRADING	QTY/ PACK	PACKS/ CASE
Fiber - Handy Packs					
2" Speed-Lok TR (F244)					
07660702399	07660702399	5 120	Fine	5	10**
07660702400	07660702400	8 50	Medium	5	10**
07660702401	07660702401	5 24	Coarse	5	10**

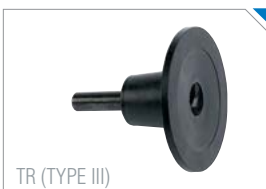

PART #	UPC-A	GRIT	GRADING	QTY/ PACK	PACKS/ CASE
Backup Pads - Handy Packs					
2" Drill Mount Back-up Pad					
07660702395	07660702395	7		1	10**
Non-Woven - Handy Packs					
2" Speed-Lok TR					
07660702396	07660702396	4 320		5	10**
07660702397	07660702397	1 120		5	10**
07660702398	07660702398	8 80		5	10**
3" Drill Mount Back-up Pad - Quick Change					
07660702388	07660702388	9		1	10**
3" Speed-Lok TR					
07660702389	07660702389	6 320		5	10**
07660702390	07660702390	2 120		5	10**
07660702391	07660702391	9 80		5	10**



Detail / Profile

A wide variety of products for small, hard-to-reach areas that cannot be sanded with conventional power tools, such as random orbital sanders and belt sanders. Designed for profiles, moldings, and contoured surfaces.

Application/Grit Recommendation Guide

Finer ←							→ Coarser
220	180	150	120	100	80	60	
Between Coats Sanding	Fine Surface Preparation	Moderate To Light Removal	Moderate To Light Removal	Moderate To Light Removal	Moderate Removal	Moderate Removal	



PART #	UPC-A	GRIT	GRADING	QTY/ PACK	PACKS/ CASE
	For Black & Decker Sandstorm / Mega Mouse / Multi-Sander				
3" x 1-1/8" Detail Sanding Replaceable Fingertips					
07660721602	076607 21602 1		Asst. 5C, 5M, 5F	15	6**
4-3/16" x 6-3/4" Iron Shape Sheets, Hook & Loop, 8 Vac Holes					
07660701149	076607 01149 7	P220	Very Fine	5	6**
07660701148	076607 01148 0	P180	Fine	5	6**
07660701147	076607 01147 3	P120	Medium	5	6**
07660701146	076607 01146 6	P80	Coarse	5	6**
	For Corner Cat/Mouse				
3-7/8" x 5-1/2" Iron Shape Sheets, Hook & Loop					
07660702704	076607 02704 7	P220	Very Fine	5	6**
07660702705	076607 02705 4	P180	Fine	5	6**
07660702706	076607 02706 1	P120	Medium	5	6**
07660702707	076607 02707 8	P80	Coarse	5	6**

PART #	UPC-A	GRIT	GRADING	QTY/ PACK	PACKS/ CASE
	For Black & Decker / Craftsman Mouse Sander				
3" x 1-1/8" Detail Sanding Replaceable Fingertips					
07660721602	076607 21602 1		Asst. 5C, 5M, 5F	15	6**
3" x 7" Iron Shape Sheets Hook & Loop					
07660702314	076607 02314 8	P220	Very Fine	5	6**
07660702315	076607 02315 5	P180	Fine	5	6**
07660702316	076607 02316 2	P120	Medium	5	6**
07660702317	076607 02317 9	P80	Coarse	5	6**
07660702318	076607 02318 6		2VF, 2F, 1M	5	6**
	For Ryobi				
Triangle Sheets, Adhesive Back					
07660749282	076607 49282 1	P150	Fine	10	6**
07660749283	076607 49283 8	P100	Medium	10	6**
07660749284	076607 49284 5	P60	Coarse	10	6**



Red Heat

Norton Red Heat belts utilize a premium ceramic alumina grain delivering a superior cut rate to anything on the market. This ceramic grain “micro-fractures” during the sanding process, leaving a razor sharp edge throughout the life of the belt. It’s symmetrically-shaped design leaves a much finer scratch pattern compared to other abrasives, allowing for an aggressive cut without deep scratches that might be seen after staining or finishing. Combine all of this with a heavy cotton backing and you have ultimate durability and longevity.



Application/Grit Recommendation Guide

Finer ←		→ Coarser	
120 Light Removal	80 Moderate Removal	50 Heavy Removal	36 Heavy Removal

FEATURES & BENEFITS

- Utilizes ceramic alumina abrasive for five times the product life over conventional abrasives on the hardest woods and finishes
- Symmetrical shape of the ceramic alumina grain allows the belt to cut aggressively while leaving a finer scratch on the surface which results in a superior finish and less time sanding
- The super-sharp micro-fracturing ceramic grain cuts cooler and resists loading which minimizes belt changes
- Heavy cotton backing is durable and tear resistant

PART #	UPC-A	GRIT	GRADING	QTY/ PACK	PACKS/ CASE
Red Heat Benchstand Belts - Bulk - Non UPC Barcoded					
4" x 36" (Red Heat R955P)					
07660768122	076607 68122 5	120	Fine	1	5
07660768123	076607 68123 2	80	Medium	1	5
07660768124	076607 68124 9	50	Coarse	1	5
07660768125	076607 68125 6	36	Extra Coarse	1	5
6" x 48" (Red Heat R955P)					
07660768126	076607 68126 3	120	Fine	1	10
07660768127	076607 68127 0	80	Medium	1	10
07660768128	076607 68128 7	50	Coarse	1	10
07660768129	076607 68129 4	36	Extra Coarse	1	10



ProSand

Next generation Norton ProSand BlueFire Zirconia Alumina Portable Belts feature a self-sharpening abrasive design with an anti-static technology to remove material faster with less dust generated to deliver an attractive surface finish.

Application/Grit Recommendation Guide

Finer ←		→ Coarser	
120	80	50	36
Light Removal	Moderate Removal	Heavy Removal	Heavy Removal

PART #	UPC-A	GRIT	GRADING	QTY/ PACK	PACKS/ CASE
ProSand BlueFire Portable Belts - Handy Packs					
3" x 18"					
07660702229	07660749600	3 P120	Fine	2	5**
07660702230	07660749602	7 P80	Medium	2	5**
07660702231	07660749604	1 P50	Coarse	2	5**
07660768230	07660768230	7 P36	Extra Coarse	2	5**
3" x 21"					
07660702225	07660749610	2 P120	Fine	2	5**
07660702226	07660749611	9 P80	Medium	2	5**
07660702227	07660749612	6 P50	Coarse	2	5**
07660702228	07660749613	3 P36	Extra Coarse	2	5**
3" x 24"					
07660768231	07660768231	4 P120	Fine	2	5**
07660768232	07660768232	1 P80	Medium	2	5**
07660768233	07660768233	8 P50	Coarse	2	5**
07660768234	07660768234	5 P36	Extra Coarse	2	5**
4" x 24"					
07660768235	07660768235	2 P120	Fine	2	5**
07660705472	07660705472	2 P80	Medium	2	5**
07660705473	07660705473	9 P50	Coarse	2	5**
07660705474	07660705474	6 P36	Extra Coarse	2	5**

STOCK REMOVAL IN GRAMS OVER 6 MINUTES OF SANDING
ON HARD MAPLE ON BELT SANDER

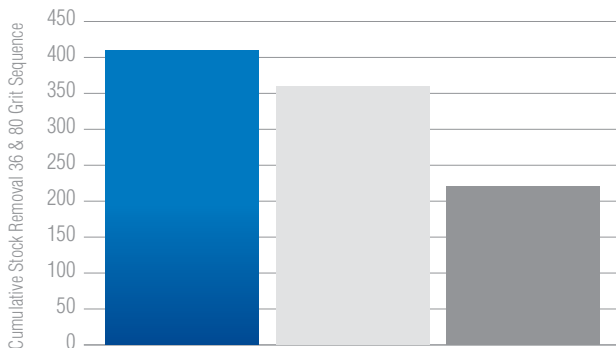

■ Norton ProSand Belt ■ Premium Competitive Belt ■ Norton A/O Belt

PART #	UPC-A	GRIT	GRADING	QTY/ PACK	PACKS/ CASE
ProSand BlueFire Portable Belts - Job Packs					
3" x 18"					
07660749256	07660749256	2 P120	Fine	5	5**
07660749258	07660749258	6 P80	Medium	5	5**
07660749259	07660749259	3 P50	Coarse	5	5**
07660768236	07660768236	9 P36	Extra Coarse	5	5**
3" x 21"					
07660749262	07660749262	3 P120	Very Fine	5	5**
07660749264	07660749264	7 P80	Medium	5	5**
07660749265	07660749265	4 P50	Coarse	5	5**
07660749266	07660749266	1 P36	Extra Coarse	5	5**
3" x 24"					
07660749268	07660749268	5 P120	Very Fine	5	5**
07660749270	07660749270	8 P80	Medium	5	5**
07660749271	07660749271	5 P50	Coarse	5	5**
07660749272	07660749272	2 P36	Extra Coarse	5	5**
4" x 24"					
07660749274	07660749274	6 P120	Very Fine	5	5**
07660749276	07660749276	0 P80	Medium	5	5**
07660749277	07660749277	7 P50	Coarse	5	5**
07660749278	07660749278	4 P36	Extra Coarse	5	5**
ProSand BlueFire Portable Belts - Bulk - UPC Bar Coded					
3" x 18"					
07660703993	07660703993	4 P120	Very Fine	10	50
07660703992	07660703992	7 P80	Medium	10	50
07660703991	07660703991	0 P50	Coarse	10	50
3" x 21"					
07660703997	07660703997	2 P120	Very Fine	10	50
07660703996	07660703996	5 P80	Medium	10	50
07660703995	07660703995	8 P50	Coarse	10	50
3" x 24"					
07660704001	07660704001	5 P120	Very Fine	10	50
07660704000	07660704000	8 P80	Medium	10	50
07660703999	07660703999	6 P50	Coarse	10	50
4" x 24"					
07660704005	07660704005	3 P120	Very Fine	10	50
07660704004	07660704004	6 P80	Medium	10	50
07660704003	07660704003	9 P50	Coarse	10	50
Belt Cleaning Stick - Handy Packs					
6" x 1-3/8" x 1-3/8"					
07660701717	07660701717	8 Stick		1	10**



Aluminum Oxide Portable / Benchstand Belts

Aluminum Oxide Portable and Benchstand Belts are ideal for all your metal and woodworking applications. Found in a wide variety of grits and sizes they can be used for tackling the following projects:

- Heavy stock removal
- Finish sanding
- Deburring of steel
- Polishing
- Dimensioning and shaping
- Removing saw marks

Application/Grit Recommendation Guide

Finer ←									→ Coarser
220	180	120	100	80	60	50	40	36	
Very Light Removal	Light Removal	Light Removal	Light Removal	Moderate Removal	Heavy Removal	Heavy Removal	Heavy Removal	Heavy Removal	

PART #	UPC-A	GRIT	GRADING	QTY/ PACK	PACKS/ CASE
Aluminum Oxide Portable Belts - Handy Packs					
2-1/2" x 14" (R215, R255)					
07660721581	07660721581	9	120	Fine	2 5**
07660721582	07660721582	6	80	Medium	2 5**
07660721583	07660721583	3	50	Coarse	2 5**
3" x 18" (R215, R255)					
07660702244	07660748430	7	120	Fine	2 5**
07660702245	07660748450	5	80	Medium	2 5**
07660702246	07660748465	9	50	Coarse	2 5**
3" x 21" (R215, R255)					
07660702240	07660748490	1	120	Fine	2 5**
07660702241	07660748505	2	80	Medium	2 5**
07660702242	07660748520	5	50	Coarse	2 5**
07660702243	07660748521	2	36	Extra Coarse	2 5**
3" x 24" (R215, R255)					
07660702236	07660748600	4	120	Fine	2 5**
07660702237	07660748620	2	80	Medium	2 5**
07660702238	07660748630	1	50	Coarse	2 5**
07660702239	07660748631	8	36	Extra Coarse	2 5**
4" x 24" (R215, R255)					
07660702233	07660748710	0	120	Fine	2 5**
07660702234	07660748725	4	80	Medium	2 5**
07660702235	07660748740	7	50	Coarse	2 5**
Aluminum Oxide Portable Belts - Job Packs					
3" x 18" (R215, R255)					
07660700969	07660700969	2	120	Very Fine	5 5**
07660700968	07660700968	5	80	Medium	5 5**
07660700964	07660700964	7	50	Coarse	5 5**
3" x 21" (R215, R255)					
07660705287	07660705287	2	220	Extra Fine	5 5**
07660702062	07660702062	8	120	Very Fine	5 5**
07660702064	07660702064	2	80	Medium	5 5**
07660701740	07660701740	6	50	Coarse	5 5**
07660701741	07660701741	3	36	Extra Coarse	5 5**
3" x 24" (R215, R255)					
07660702065	07660702065	9	120	Very Fine	5 5**
07660702066	07660702066	6	100	Fine	5 5**
07660702067	07660702067	3	80	Medium	5 5**
07660701742	07660701742	0	50	Coarse	5 5**
07660701743	07660701743	7	36	Extra Coarse	5 5**
4" x 24" (R215, R255)					
07660705285	07660705285	8	180	Ex Fine	5 5**
07660702068	07660702068	0	120	Very Fine	5 5**
07660702069	07660702069	7	80	Medium	5 5**
07660701744	07660701744	4	50	Coarse	5 5**
07660701745	07660701745	1	36	Extra Coarse	5 5**

PART #	UPC-A	GRIT	GRADING	QTY/ PACK	PACKS/ CASE
Aluminum Oxide Portable Belts - Bulk - UPC Bar Coded					
2-1/2" x 16" (R215, R255)					
78072780448	78072780448	7	120	Fine	10 50
78072780449	78072780449	4	80	Medium	10 50
78072780450	78072780450	0	50	Coarse	10 50
78072780451	78072780451	7	36	Extra Coarse	5 25
3" x 18" (R215, R255)					
78072727992	78072727992	6	120	Fine	10 50
78072727993	78072727993	3	80	Medium	10 50
78072727994	78072727994	0	50	Coarse	10 50
78072780447	78072780447	0	36	Extra Coarse	5 25
3" x 21" (R215, R255)					
78072727922	78072727922	3	120	Fine	10 50
78072727923	78072727923	0	100	Medium	10 50
78072727924	78072727924	7	80	Medium	10 50
78072727925	78072727925	4	60	Coarse	10 50
78072727926	78072727926	1	50	Coarse	10 50
78072727927	78072727927	8	40	Extra Coarse	10 50
78072781846	78072781846	3	36	Extra Coarse	5 25
3" x 24" (R215, R255)					
78072727932	78072727932	2	120	Fine	10 50
78072727933	78072727933	9	100	Medium	10 50
78072727934	78072727934	6	80	Medium	10 50
78072727935	78072727935	3	60	Coarse	10 50
78072727936	78072727936	0	50	Coarse	10 50
78072727937	78072727937	7	40	Extra Coarse	10 50
78072781847	78072781847	7	36	Extra Coarse	5 25
4" x 21-3/4" (R215, R255)					
78072780440	78072780440	1	80	Medium	10 50
78072780441	78072780441	8	50	Coarse	10 50
4" x 24" (R215, R255)					
78072727942	78072727942	1	120	Fine	10 50
78072727943	78072727943	8	100	Medium	10 50
78072727944	78072727944	5	80	Medium	10 50
78072727945	78072727945	2	60	Coarse	10 50
78072727946	78072727946	9	50	Coarse	10 50
78072727947	78072727947	6	40	Extra Coarse	10 50
78072780438	78072780438	8	36	Extra Coarse	5 25

Aluminum Oxide Portable / Benchstand Belts

PART #	UPC-A	GRIT	GRADING	QTY/ PACK	PACKS/ CASE
Aluminum Oxide Benchstand Belts - Handy Packs					
1" x 30" (R215, R255)					
07660704729	07660704729 8	Asst.	1F, 1M, 1C	3	5**
1" x 42" (R215, R255)					
07660701966	07660701966 0	Asst.	1F, 1M, 1C	3	10**
4" x 36" (R215, R255)					
07660748665	07660748665 3	220X	Very Fine	1	6**
07660748660	07660748660 8	120	Fine	1	6**
07660748675	07660748675 2	80	Medium	1	6**
07660748690	07660748690 5	50	Coarse	1	6**
6" x 48" (R215, R255)					
07660705282	07660705282 7	220	Very Fine	1	10**
07660705281	07660705281 0	180	Very Fine	1	10**
07660701722	07660701722 2	120	Fine	1	10**
07660705279	07660705279 7	100	Medium	1	10**
07660701721	07660701721 5	80	Medium	1	10**
07660701720	07660701720 8	50	Coarse	1	10**

PART #	UPC-A	GRIT	GRADING	QTY/ PACK	PACKS/ CASE
Aluminum Oxide Benchstand Belts - Bulk - UPC Bar Coded					
4" x 36" (R215, R255)					
78072727957	78072727957 5	120X	Fine	10	50
78072727958	78072727958 2	100X	Medium	10	50
78072727959	78072727959 9	80X	Medium	10	50
78072727960	78072727960 5	60X	Coarse	10	50
78072727961	78072727961 2	50X	Coarse	10	50
78072727962	78072727962 9	40X	Extra Coarse	10	50
78072727963	78072727963 6	36X	Extra Coarse	10	50
6" x 48" (R215, R255)					
78072727981	78072727981 0	120X	Fine	10	20
78072727982	78072727982 7	100X	Medium	10	20
78072727983	78072727983 4	80X	Medium	10	20
78072727984	78072727984 1	60X	Coarse	10	20
78072727985	78072727985 8	50X	Coarse	10	20
78072727986	78072727986 5	40X	Extra Coarse	10	20
78072727987	78072727987 2	36X	Extra Coarse	10	20
Aluminum Oxide Benchstand Belts - Bulk - Non UPC					
1" x 42" (R215, R255)					
78072720875	78072720875 9	180X	Very Fine	50	200
78072720885	78072720885 8	120X	Fine	50	200
78072720890	78072720890 2	100X	Medium	50	200
78072720895	78072720895 7	80X	Medium	50	200
78072720900	78072720900 8	60X	Coarse	50	200
78072720905	78072720905 3	50X	Coarse	50	200
78072720910	78072720910 7	40X	Extra Coarse	50	200



Blades/Cups/Specialty

Norton Clipper Diamond Blades are the choice of professionals because of their faster cut rate, constant depth of cut and less downtime versus standard abrasives blades. Choose Norton Clipper Charger for maximum productivity, longest life and lowest total cost. Choose Norton Clipper Classic for high productivity. Choose Norton Clipper ValuPlus for quality and value.

Photo not intended for instruction. Always comply with OSHA and ANSI B7.1.

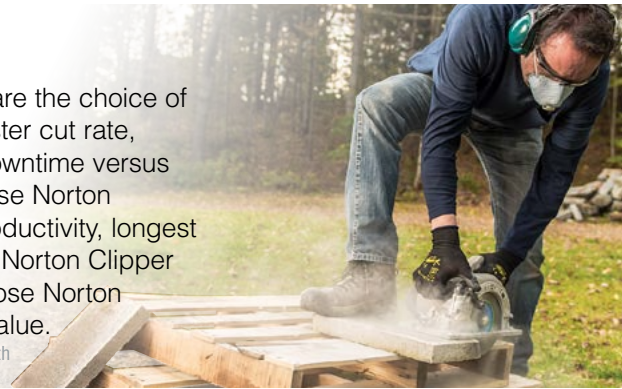

Segmented Rim

- Most aggressive cutting action for use on the widest variety of materials.
- Typically used on high speed, walk-behind and masonry saw blades.



Continuous Rim

- Provides the smoothest cut.
- For use on porcelain, ceramic tile, marble and other hard materials requiring a high quality cut.

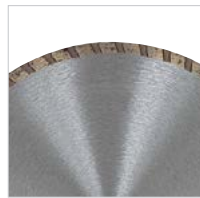

Turbo Rim

- Aggressive cutting action with a smoother quality cut.
- For use on harder materials such as granite, marble and stone, to reduce chipping.



Tuck Pointing

- Economical for small to medium tuck pointing jobs. High quality performance for heavy grout removal or mortar jointing.
- Heavy duty wide segment reduces wear in abrasive materials.

PART #	UPC-A	SIZE	MAX RPM	QTY/ PKG
Norton Clipper Charger High-Performance Blades				
Continuous Rim - Turbo				
07660705475	07660705475	3 4" x .080" x 7/8" - 5/8-20mm	15000	1
07660704023	07660704023	7 4-1/2" x .080" x 7/8"-5/8-20mm	13300	1
07660704022	07660704022	0 7" x .090" x DM-7/8-5/8	8370	1
Norton Clipper Classic General-Purpose Blades				
Combination Pack				
07660705344	07660705344	4-1/2" x .080" x 7/8"-5/8-20mm	13300	5
Continuous Rim - Turbo				
07660704018	07660704018	3 4" x .080" x 7/8"-5/8-20mm	15000	5 (bulk)
07660702792	07660702792	4 4" x .080" x 7/8"-5/8-20mm	5000	1
07660704017	07660704017	6 4-1/2" x .080" x 7/8"-5/8-20mm	13300	5 (bulk)
07660702790	07660702790	0 4-1/2" x .080" x 7/8"-5/8-20mm	13300	1
07660704016	07660704016	9 7" x .090" x DM-7/8-5/8	8370	5 (bulk)
07660702787	07660702787	0 7" x .090" x DM-7/8-5/8	8370	1
07660702780	07660702780	1 10" x .100" x 1-7/8"-5/8	6115	1
Segmented Rim				
07660702791	07660702791	7 4" x .080" x 7/8"-5/8-20mm	15000	1
07660702789	07660702789	4 4-1/2" x .080" x 7/8"-5/8-20mm	13300	1
70184684463	70184684463	5 4-1/2" x .080" x 7/8"-5/8-20mm	13300	5 (bulk)
07660702786	07660702786	3 7" x .090" x DM-7/8-5/8	8370	1
70184684464	70184684464	2 7" x .090" x DM-7/8-5/8	8370	5 (bulk)
07660701201	07660701201	2 10" x .100" x 1-7/8"-5/8	6115	1
70184681383	70184681383	9 12" x .110" x 1/20"mm	6300	1
70184681309	70184681309	9 14" x .110" x 1/20"mm	5460	1
07660701230	07660701230	2 16" x .125" x 1/20"mm	4500	1
Cup Wheels - Single Row For Fast Stock Removal				
70184682555	70184682555	9 4" x 5/8"-11	15000	1
70184682593	70184682593	5 7" x 5/8"-11	8370	1
Cup Wheels - Double Row For Long Life, Smooth Finish				
70184682586	70184682586	3 4" x 5/8"-11	15000	1
70184682595	70184682595	5 7" x 5/8"-11	8370	1

PART #	UPC-A	SIZE	MAX RPM	QTY/ PKG
Norton Clipper Classic General-Purpose Blades				
Wet/Dry Cutting Continuous Rim				
07660702793	07660702793	1 4" x .080" x 7/8"-5/8-20mm	15000	1
07660701194	07660701194	7 4-1/2" x .080" x 7/8"-5/8-20mm	13300	1
07660702788	07660702788	7 7" x .090" x DM-7/8-5/8	8370	1
07660702785	07660702785	6 8" x .070" x 5/8"	7640	1
07660702784	07660702784	9 10" x .070" x 5/8"	6115	1
Norton Clipper ValuPlus General-Purpose Blades				
Continuous Rim				
70184684087	70184684087	3 4" x .080" x 7/8"-5/8-20mm	15000	1
70184684088	70184684088	0 4-1/2" x .080" x 7/8"-5/8-20mm	13300	1
70184684089	70184684089	7 7" x .090" x DM-7/8-5/8	8370	1
Turbo Rim				
70184684105	70184684105	4 4" x .080" x 7/8", 5/8, 20mm	15000	1
70184684106	70184684106	1 4-1/2" x .086" x 7/8", 5/8, 20mm	3300	1
70184684107	70184684107	8 7" x .090" x DM, 7/8, 5/8	8370	1
Segmented Rim				
70184684098	70184684098	3 4" x .080" x 7/8"-5/8-20mm	15000	1
70184684099	70184684099	6 4-1/2" x .080" x 7/8"-5/8-20mm	13300	1
70184684100	70184684100	9 7" x .090" x DM-7/8-5/8	8370	1
Specialty				
Norton Clipper DUO - High Speed General-Purpose				
70184683611	70184683611	1 12" x .110" x 1"/20mm	6300	1
70184683612	70184683612	8 14" x .110" x 1"/20mm	5460	1
Norton Clipper 4x4 MaxCut				
70184645927	70184645927	3 12" x .118" x 1"/20mm	6300	1
70184645926	70184645926	6 14" x .125" x 1"/20mm	5460	1
Norton Clipper Rescue/Demolition				
70184684361	70184684361	4 14" x .140" x 1"/20mm	5460	1
Norton Clipper Slicer - Flush Cut- Dry - Turbo Rim				
70184684546	70184684546	5 4-1/2" x .040" x 7/8"	13300	1
70184684545	70184684545	8 5" x .040" x 7/8"	12000	1
Tuck Pointing				
70184684020	70184684020	0 4" x .250" x 7/8"-5/8	15000	1
70184681779	70184681779	0 7" x .250" x 7/8"-5/8-20mm	8370	1



Right Angle Grinder Cut-Off

The Norton offering of thin, unique cut-off blades delivers a full range of sizes and thicknesses for high-demand applications like cutting and cleaning metal studs, masonry stainless steel, tubing and sheet metal.



FEATURES & BENEFITS

- Fastest cutting wheels in the market
- Will deliver a fast cut with longer life without added operator pressure
- Reinforced to tackle tough portable and fixed-base cut-off applications

SPEC CHECK

Metal

Steel, Stainless, Iron, Sheet metal

Masonry

Concrete, Brick, Cinder block, Patio stones

Asphalt

Asphalt, Green concrete

Aluminum

Aluminum, Bronze, Copper

PART #	UPC-A	SIZE	MAX RPM	WHLs/ CASE
Right Angle Cut-off Blades (Type 01/41) - Bulk - UPC Bar Coded				
Metal - Aluminum Oxide				
07660701616	07660701616	4" x .040" x 5/8"	15280	25
07660701617	07660701617	4-1/2" x .040" x 7/8"	13580	25
07660701618	07660701618	5" x .040" x 7/8"	12225	25
07660702757	07660702757	6" x .040" x 7/8"	10185	25
Masonry - Silicon Carbide				
07660701620	07660701620	4" x 1/16" x 5/8"	15280	15
07660701621	07660701621	4-1/2" x 1/16" x 7/8"	13580	15
07660701622	07660701622	5" x 1/16" x 7/8"	12225	5
Metal - Gemini Aluminum Oxide				
66243527956	66243527956	4" x .040" x 5/8"	15280	25
66252823602	66252823602	4-1/2" x .045" x 7/8"	13580	25
66252823603	66252823603	5" x .045" x 7/8"	12225	25
66252823604	66252823604	6" x .045" x 7/8"	10185	25
66243527955	66243527955	4" x 3/32" x 5/8"	15280	25
66252823599	66252823599	4-1/2" x 3/32" x 7/8"	13580	25
66252823600	66252823600	5" x 3/32" x 7/8"	12225	25
66252823601	66252823601	6" x 3/32" x 7/8"	10185	25
Metal - BlueFire Zirconia Alumina/Aluminum Oxide				
66252843208	66252843208	4-1/2" x 1/16" x 7/8"	13580	25
66252843209	66252843209	5" x 1/16" x 7/8"	12225	25
66252843210	66252843210	6" x 1/16" x 7/8"	10185	25
Right Angle Cut-off Blades (Type 01/41) - Job Packs (Pole Packs)				
Metal - Aluminum Oxide				
07660703987	07660703987	4" x .040" x 5/8"	15280	5/20
07660703988	07660703988	4-1/2" x .040" x 7/8"	13580	5/20
Right Angle Cut-off Blades (Type 27/42) - Bulk - UPC Bar Coded				
Metal - Aluminum Oxide				
07660705249	07660705249	4" x .045" x 5/8"	15280	25
66252843604	66252843604	4-1/2" x .045" x 7/8"	13580	25
66252842015	66252842015	6" x .045" x 7/8"	10185	25
07660705251	07660705251	7" x 1/16" x 7/8"	8600	10
Metal - Gemini Aluminum Oxide				
66252842180	66252842180	4" x .045" x 5/8"	15280	25
66252842026	66252842026	4-1/2" x .045" x 7/8"	13580	25
66252842025	66252842025	4-1/2" x .045" x 5/8"-11	13580	10
66252842036	66252842036	5" x .045" x 7/8"	12225	25
66252841939	66252841939	5" x .045" x 5/8"-11	12225	10
66252842202	66252842202	6" x .045" x 7/8"	10185	25
66252830587	66252830587	6" x .045" x 5/8"-11	10185	10
66252912626	66252912626	7" x 1/16" x 7/8"	8600	20



Depressed Center Wheels

The depressed center design allows the flange/lock nut to recess within the wheel so that it can be used for various grinding and cutting applications. Depressed center wheels are designed to handle the most severe right angle grinding applications, from heavy stock removal to rough blending. Depressed center wheels may also be referred to as raised hub wheels or by their shape designation of "Type," with Type 27 being the most popular.

1/4" are designed for grinding:

- offhand stock removal of all types of metal and masonry
- smoothing welds
- pipe beveling

1/8" are designed to be used for both light grinding or cutting:

- offhand cut-off of all metal and masonry materials
- notching or cleaning pipes and weld beads

.125" are designed to be used at a 90° angle for cutting only



Professionals Want Choices

Norton NorZon Plus is the highest performance line in the industry. Invented and made in America, now improved and expanded.



Performance on Fire

Engineered with a proprietary NorZon grain upgrade, the Norton BlueFire design offers faster removal rate, longer product life and increased productivity for better performance value.



The Right Choice Every Time

The re-engineered Norton Gemini RightCut 100% aluminum oxide wheels provide thinner, faster cutting with a burr-free, precision cut and improved operator comfort.

PART #	UPC-A	SIZE	MAX RPM	WHLs/ CASE
Accessory For Right Angle Grinders - Handy Packs				
Adaptor Kit				
07660789275	07660789275	1 Adaptor kit for 7" & 9" wheels	N/A	1
Depressed Center Wheels (Type 27) - Bulk - UPC Bar Coded				
Metal - NorZon Plus, For Grinding				
66252842178	66252842178	3" x 1/4" x 3/8"	18000	25
66252842002	66252842002	4" x 1/4" x 3/8"	15280	25
66252842003	66252842003	4" x 1/4" x 5/8"	15280	25
66252843328	66252843328	4-1/2" x 1/4" x 7/8"	13580	25
66252843326	66252843326	4-1/2" x 1/4" x 5/8"-11	13580	10
66252843334	66252843334	5" x 1/4" x 7/8"	12225	25
66252843332	66252843332	5" x 1/4" x 5/8"-11	12225	10
66252809376	66252809376	6" x 1/4" x 7/8"	10185	20
66252917880	66252917880	7" x 1/4" x 7/8"	8600	20
66252917881	66252917881	7" x 1/4" x 5/8"-11	8600	10
66253021633	66253021633	9" x 1/4" x 7/8"	6600	20
66253021634	66253021634	9" x 1/4" x 5/8"-11	6600	10

PART #	UPC-A	SIZE	MAX RPM	WHLs/ CASE
Depressed Center Wheels (Type 27) - Bulk - UPC Bar Coded				
Metal - NorZon Plus, For Light Grinding and Cutting				
66252842177	66252842177	6 3" x 1/8" x 3/8"	18000	25
66252842004	66252842004	5 4" x 1/8" x 3/8"	15280	25
66252842005	66252842005	2 4" x 1/8" x 5/8"	15280	25
66252843324	66252843324	3 4-1/2" x 1/8" x 7/8"	13580	25
66252843323	66252843323	6 4-1/2" x 1/8" x 5/8"-11	13580	10
66252843331	66252843331	0 5" x 1/8" x 7/8"	12225	25
66252938854	66252938854	2 7" x 1/8" x 7/8"	8600	20
66252938855	66252938855	9 7" x 1/8" x 5/8"-11	8600	10
66253048896	66253048896	5 9" x 1/8" x 7/8"	6600	20
66253048897	66253048897	2 9" x 1/8" x 5/8"-11	6600	10
Metal - NorZon Plus, For Pipe Notching				
66252939184	66252939184	9 7" x 1/8" x 5/8"-11	8600	10
66253049066	66253049066	1 9" x 1/8" x 5/8"-11	6600	10
Depressed Center Wheels (Type 27/42) - Bulk - UPC Bar Coded				
Metal - NorZon Plus, For Cutting Only				
66252842001	66252842001	4 4" x .125" x 3/8"	15280	25
66252843322	66252843322	9 4-1/2" x .125" x 7/8"	13580	25
66252843321	66252843321	2 4-1/2" x .125" x 5/8"-11	13580	10

Depressed Center Wheels

PART #	UPC-A	SIZE	MAX RPM	WHLs/ CASE
Depressed Center Wheel (Type 27) - Bulk - UPC Bar Coded				
Metal - BlueFire Zirconia Alumina, For Grinding				
66252843179	66252843179	9 4" x 1/4" x 3/8"	15280	25
66252843177	66252843177	5 4" x 1/4" x 5/8"	15280	25
66252843214	66252843214	7 4-1/2" x 1/4" x 7/8"	13580	25
66252843213	66252843213	0 4-1/2" x 1/4" x 5/8"-11	13580	10
66252843218	66252843218	5 5" x 1/4" x 7/8"	12225	25
66252843217	66252843217	8 5" x 1/4" x 5/8"-11	12225	10
66252843236	66252843236	9 7" x 1/4" x 7/8"	8600	20
66252843235	66252843235	2 7" x 1/4" x 5/8"-11	8600	10
66252843247	66252843247	5 9" x 1/4" x 7/8"	6600	20
66252843246	66252843246	8 9" x 1/4" x 5/8"-11	6600	10
Metal - BlueFire Zirconia Alumina, For Light Grinding and Cutting				
66252843178	66252843178	2 4" x 1/8" x 3/8"	15280	25
66252843176	66252843176	8 4" x 1/8" x 5/8"	15280	25
66252843212	66252843212	3 4-1/2" x 1/8" x 7/8"	13580	25
66252843211	66252843211	6 4-1/2" x 1/8" x 5/8"-11	13580	10
66252843216	66252843216	1 5" x 1/8" x 7/8"	12225	25
66252843215	66252843215	4 5" x 1/8" x 5/8"-11	12225	10
66252843234	66252843234	5 7" x 1/8" x 7/8"	8600	20
66252843233	66252843233	8 7" x 1/8" x 5/8"-11	8600	10
66252843245	66252843245	1 9" x 1/8" x 7/8"	6600	20
66252843244	66252843244	4 9" x 1/8" x 5/8"-11	6600	10
Metal - Gemini Aluminum Oxide, For Grinding				
66252842179	66252842179	0 3" x 1/4" x 3/8"	18000	25
66252842018	66252842018	1 4" x 1/4" x 3/8"	15280	25
66252842019	66252842019	9 4" x 1/4" x 5/8"	15280	25
66252843594	66252843594	0 4-1/2" x 1/4" x 7/8"	13580	25
66252843593	66252843593	3 4-1/2" x 1/4" x 5/8"-11	13580	10
66252843598	66252843598	8 5" x 1/4" x 7/8"	12225	25
66252801865	66252801865	5 6" x 1/4" x 7/8"	10185	20
66252940098	66252940098	5 7" x 1/4" x 7/8"	8600	20
66252940148	66252940148	7 7" x 1/4" x 5/8"-11	8600	10
66253048991	66253048991	7 9" x 1/4" x 7/8"	6600	20
66253049104	66253049104	0 9" x 1/4" x 5/8"-11	6600	10
Metal - Gemini Aluminum Oxide, For Light Grinding and Cutting				
66252842016	66252842016	8 4" x 1/8" x 3/8"	15280	25
66252842017	66252842017	5 4" x 1/8" x 5/8"	15280	25
66252843591	66252843591	9 4-1/2" x 1/8" x 7/8"	13580	25
66252843590	66252843590	1 4-1/2" x 1/8" x 5/8"-11	13580	10
66252843596	66252843596	4 5" x 1/8" x 7/8"	12225	25
66252801864	66252801864	8 6" x 1/8" x 7/8"	10185	20
66252939207	66252939207	5 7" x 1/8" x 7/8"	8600	20
66252939259	66252939259	4 7" x 1/8" x 5/8"-11	8600	10
66253048994	66253048994	8 9" x 1/8" x 7/8"	6600	20
66253048983	66253048983	2 9" x 1/8" x 5/8"-11	6600	10
Depressed Center Wheel (Type 27/42) - Bulk - UPC Bar Coded				
Metal - Gemini Aluminum Oxide, For Cutting				
66252912626	66252912626	7 7" x 1/16" x 7/8"	8600	20

PART #	UPC-A	SIZE	MAX RPM	WHLs/ CASE
Depressed Center Wheel (Type 27) - Bulk - UPC Bar Coded				
Metal - Aluminum Oxide, For Grinding				
66252842011	66252842011	3 4" x 1/4" x 5/8"	15280	25
66252843607	66252843607	6 4-1/2" x 1/4" x 7/8"	13580	25
66252843605	66252843605	3 4-1/2" x 1/4" x 5/8"-11	13580	10
66252843614	66252843614	5 5" x 1/4" x 7/8"	12225	25
66252843613	66252843613	8 5" x 1/4" x 5/8"-11	12225	10
07660775936	07660775936	8 7" x 1/4" x 7/8"	8600	5
07660775940	07660775940	5 7" x 1/4" x 5/8"-11	8600	5
07660775938	07660775938	2 9" x 1/4" x 5/8"-11	6600	5
Metal - Aluminum Oxide, For Light Grinding and Cutting				
66252842014	66252842014	4 4" x 1/8" x 5/8"	15280	25
66252843611	66252843611	4 4-1/2" x 1/8" x 7/8"	13580	25
66252843609	66252843609	0 4-1/2" x 1/8" x 5/8"-11	13580	10
66252843616	66252843616	9 5" x 1/8" x 7/8"	12225	25
66252843615	66252843615	1 5" x 1/8" x 5/8"-11	12225	10
07660775956	07660775956	4 7" x 1/8" x 7/8"	8600	5
07660702678	07660702678	1 7" x 1/8" x 5/8"-11	8600	10
Depressed Center Wheels (Type 27) - Bulk - UPC Bar Coded				
Masonry - Silicon Carbide, For Grinding				
66252842010	66252842010	6 4" x 1/4" x 5/8"	15280	25
66252843600	66252843600	8 4-1/2" x 1/4" x 7/8"	13580	25
66252843599	66252843599	5 4-1/2" x 1/4" x 5/8"-11	13580	10
66252843602	66252843602	1 5" x 1/4" x 7/8"	12225	25
07660775942	07660775942	9 7" x 1/4" x 5/8"-11	8600	5
07660775937	07660775937	5 9" x 1/4" x 5/8"-11	6600	5
Masonry - Silicon Carbide, For Light Grinding and Cutting				
66252842013	66252842013	7 4" x 1/8" x 5/8"	15280	25
66252843601	66252843601	5 4-1/2" x 1/8" x 7/8"	13580	25

Small Diameter Reinforced Cut-off Blades

Small diameter cut-off wheels are designed for traditional cut-off applications and feature full fiberglass reinforcing. Used on small cut-off tools for fast cut-off and slotting of all types of metal.



PART #	UPC-A	SIZE	MAX RPM	WHLS/ CASE
Small Diameter Cut-off Blades (Type 01/41) - Handy Packs				
Metal - Aluminum Oxide				
07660747767	076607 47767 5	3" x 1/16" x 3/8"	25465	25
66252843624	662528 43624 5	3" x 1/16" x 3/8"	5 pack w/ mandrel	25465 5
07660747769	076607 47769 9	Mandrel	Accessory	5
Small Diameter Cut-off Blades (Type 01/41) - UPC Bar Coded				
Metal - Aluminum Oxide				
07660789451	076607 89451 9	3" x .035" x 3/8"	25465	25
07660789384	076607 89384 0	3" x 1/8" x 3/8"	25465	25
07660789453	076607 89453 3	4" x .035" x 3/8"	19100	25
07660789387	076607 89387 1	4" x 1/8" x 3/8"	19100	25
Small Diameter Cut-off Blades (Type 01/41) - Bulk - UPC Bar Coded				
Metal - BlueFire Zirconia Alumina				
66252843174	662528 43174 4	3" x .035" x 3/8"	25465	25
66252843175	662528 43175 1	3" x 1/16" x 3/8"	25465	25
66252843173	662528 43173 7	4" x .035" x 3/8"	19100	25
66252843171	662528 43171 3	4" x 1/16" x 3/8"	19100	25
66252843172	662528 43172 0	4" x 1/8" x 3/8"	19100	25

PART #	UPC-A	SIZE	MAX RPM	WHLS/ CASE
Small Diameter Cut-off Blades (Type 01/41) - Bulk - Non UPC				
Metal - Aluminum Oxide				
66243411393	662434 11393 2	2" x .035" x 1/4"	30560	25
66243411395	662434 11395 6	2" x 1/16" x 1/4"	30560	25
66243411402	662434 11402 1	2" x 1/8" x 1/4"	30560	25
66243510627	662435 10627 8	3" x .035" x 1/4"	25465	25
66243510628	662435 10628 5	3" x .035" x 3/8"	25465	25
66243510645	662435 10645 2	3" x 1/16" x 1/4"	25465	25
66243510647	662435 10647 6	3" x 1/16" x 3/8"	25465	25
66243510650	662435 10650 6	3" x 1/8" x 1/4"	25465	25
66243510651	662435 10651 3	3" x 1/8" x 3/8"	25465	25
66243510629	662435 10629 2	4" x .035" x 1/4"	19100	25
66243510630	662435 10630 8	4" x .035" x 3/8"	19100	25
66243510654	662435 10654 4	4" x 1/16" x 1/4"	19100	25
66243510655	662435 10655 1	4" x 1/16" x 3/8"	19100	25
66243510658	662435 10658 2	4" x 1/8" x 1/4"	19100	25
66243510659	662435 10659 9	4" x 1/8" x 3/8"	19100	25

Circular Saw Reinforced Cut-off Blades

Used for deburring, cleaning, slotting and cutting of all types of metal and masonry. This includes cutting sheet metal and roof decking.



PART #	UPC-A	SIZE	MAX RPM	WHLS/ CASE
Circular Saw Reinforced Cut-off Blades (Type 01/41) - Handy Packs				
Metal - Aluminum Oxide				
07660789000	076607 89000 9	6-1/2" x 1/8" x DM-5/8	9405	20
07660789005	076607 89005 4	7" x 1/8" x DM-5/8	8730	20
07660789010	076607 89010 8	8" x 1/8" x DM-5/8	7640	20
Masonry - Silicon Carbide				
07660789050	076607 89050 4	6-1/2" x 1/8" x DM-5/8	9405	20
07660789055	076607 89055 9	7" x 1/8" x DM-5/8	8730	20
07660789070	076607 89070 2	8" x 1/8" x DM-5/8	7640	20

PART #	UPC-A	SIZE	MAX RPM	WHLS/ CASE
Circular Saw Reinforced Cut-off Blades (Type 01/41) - Bulk - UPC Bar Coded				
Metal - Aluminum Oxide				
07660789098	076607 89098 6	6-1/2" x 1/8" x DM-5/8	9405	10
07660789097	076607 89097 9	7" x 1/8" x DM-5/8	8730	25**
07660789096	076607 89096 2	8" x 1/8" x DM-5/8	7640	10
Masonry - Silicon Carbide				
07660789089	076607 89089 4	6-1/2" x 1/8" x DM-5/8	9405	10
07660789088	076607 89088 7	7" x 1/8" x DM-5/8	8730	25**
07660789086	076607 89086 3	8" x 1/8" x DM-5/8	7640	10



High-Speed Reinforced Cut-off Blades

For deburring, cleaning, slotting and cutting of all types of metal and masonry.

Universal Arbor Blades

Two blade sizes in one. A 20mm bushing is included in the 1" molded arbor hole. The wheel with bushing can be mounted directly on a 20mm arbor. Or, the bushing can be removed exposing a 1" arbor hole which can be mounted to any 1" saw arbor. Once the 20mm bushing is removed, it cannot be replaced.

Road Construction Blade

Used on walk-behind machine for sawing green concrete, cured concrete and asphalt.

PART #	UPC-A	SIZE		MAX RPM	WHLs/ CASE
High Speed Reinforced Cut-off Blades (Type 01/41) - Bulk - UPC Bar Coded					
Metal - Aluminum Oxide					
07660705494	07660705494	4	12" x 1/8" x 1"20mm	Universal Arbor	6300 10
07660705496	07660705496	8	14" x 1/8" x 1"20mm	Universal Arbor	5400 10
66252830886	66252830886	2	16" x 1/8" x 1"20mm	Universal Arbor	4800 10
Masonry - Silicon Carbide					
07660705493	07660705493	7	12" x 1/8" x 1"20mm	Universal Arbor	6300 10
07660705495	07660705495	1	14" x 1/8" x 1"20mm	Universal Arbor	5400 10
70184623029	70184623029	2	16" x 1/8" x 1"20mm	Universal Arbor	4800 10



Chop Saw Reinforced Cut-off Blades

For use on low horsepower cut-off machines. These machines can be easily moved, but the workpiece is carried to the machine. Especially popular in the construction industry because of its portability and ability to provide a straight, clean cut.

Primary uses include:

- Cutting metal studs, rebar, angle iron, and tubing

PART #	UPC-A	SIZE	MAX RPM	WHLs/ CASE
Chop Saw Reinforced (Type 01/41) - Bulk - UPC Bar Coded				
Metal - BlueFire Zirconia Alumina/Aluminum Oxide				
66252843254	66252843254	3	14" x 7/64" x 1"	4365 10
Metal - Aluminum Oxide				
07660789400	07660789400	7	12" x 7/64" x 1"	4365 5
07660789399	07660789399	4	14" x 7/64" x 1"	4365 5
07660703970	07660703970	5	14" x 7/64" x 1"	4365 5/5
Metal - Aluminum Oxide (Steel Stud)				
07660789405	07660789405	2	14" x 7/64" x 1"	4365 10

PART #	UPC-A	SIZE	MAX RPM	WHLs/ CASE
Chop Saw Reinforced (Type 01/41) - Bulk - UPC Bar Coded				
Metal - Gemini Aluminum Oxide				
66253207554	66253207554	5	12" x 7/64" x 1"	5095 10
66253306627	66253306627	6	14" x 7/64" x 1"	4365 10
66253410198	66253410198	3	16" x 7/64" x 1"	3820 10

Stationary Saw Reinforced Cut-off Blades

For use on a range of fixed base, higher horsepower cut-off machines where the workpiece is carried to the machine. Designed for higher cut-off production of all types of metal and masonry:

- Heavy bar stock, rebar, thick wall tubing and pipe



PART #	UPC-A	SIZE	MAX RPM	WHLs/ CASE
Stationary Saw Cut-off Blades (Type 01/41) - Bulk - UPC Bar Coded				
Metal - Aluminum Oxide				
07660789390	07660789390	1 10" x 3/32" x 5/8"	6110	5
07660789392	07660789392	5 12" x 1/8" x 1"	5095	10
07660789395	07660789395	6 14" x 1/8" x 1"	4365	10
Gemini - Aluminum Oxide				
66253410183	66253410183	9 16" x 5/32" x 1" Fast Cut	3820	10
69078609033	69078609033	5 20" x 3/16" x 1" Fast Cut	2170	5
Masonry - Silicon Carbide				
07660789391	07660789391	8 10" x 3/32" x 5/8"	6110	5

Mounted Points - Handy Packs

For removing burrs and flash finishing any kind of metal surface in a confined area. Fast stock removal and free cutting action. Use "A" or "B" shapes for medium to heavy duty blending. Use "W" shapes for offhand and precision grinding of medium to heavy stock.



TIP

Use "A" or "B" shapes for medium to heavy duty blending. Use "W" shapes for offhand and precision grinding of medium to heavy stock.



PART #	UPC-A	SIZE	SHAPE	MAX RPM	WHLs/ CASE
Mounted Points - Handy Packs					
1/4" Shank					
07660724376	07660724376	8 1" x 1-1/4" 1/4" shank	A2	34240	1/25
07660724419	07660724419	2 3/8" x 3/4" 1/4" shank	B52	78340	1/25
07660724549	07660724549	6 3/4" x 3/4" 1/4" shank	W204	36510	1/25
07660724564	07660724564	9 1" x 1/2" 1/4" shank	W218	37890	1/25

Max. RPM valid to 1/2" overhang. See package insert for other overhangs.

Bench & Pedestal

Bring back your high speed dry grinders! The fastest cutting wheels on the market are also the coolest. A constant supply of sharp cutting points with the Norton patented SG (ceramic alumina) grain gives the Premium Norton Bench & Pedestal wheels an incredible burn-free cut with controlled micro fracturing of the grain. Great for all bench and pedestal operations, especially hollow grinding of plane blades and chisels.



ARBOR ADAPTER BUSHINGS

DIA.	CENTER HOLE	1/2"	5/8"	3/4"	7/8"	1"	1-1/4"
5", 6", 7"	1"	•	•	•	•		
8"	1"		•	•	•		
10"	1-1/4"			•	•	•	
12"	1-1/2"					•	•

NOTE: Each 5", 6", 7", 8", 10" and 12" wheel is supplied with additional arbor bushings, so one specification can meet the needs of several machines with different arbor sizes.

PART #	UPC-A	SIZE	GRIT	QTY/ PKG	PKG/ CASE
Premium Blue Ceramic Alumina (I-Grade)					
07660704685	07660704685	7 6" x 3/4" x 1"	3SG46-I	1	5
07660704684	07660704684	0 6" x 3/4" x 1"	3SG60-I	1	5
07660704683	07660704683	3 6" x 3/4" x 1"	3SG80-I	1	5
07660704682	07660704682	6 6" x 3/4" x 1"	3SG100-I	1	5
07660704681	07660704681	9 6" x 3/4" x 1"	3SG120-I	1	5
07660704680	07660704680	2 6" x 1" x 1"	3SG46-I	1	5
07660704660	07660704660	4 8" x 1" x 1"	3SG46-I	1	5
07660704659	07660704659	8 8" x 1" x 1"	3SG60-I	1	5
07660704658	07660704658	1 8" x 1" x 1"	3SG80-I	1	5
07660704657	07660704657	4 8" x 1" x 1"	3SG100-I	1	5
07660705364	07660705364	0 8" x 1" x 1"	3SG120-I	1	5
Premium Blue Ceramic Alumina (K-Grade)					
07660705411	07660705411	1 6" x 3/4" x 1"	3SG46-K	1	5
07660705412	07660705412	8 6" x 3/4" x 1"	3SG80-K	1	5
07660705413	07660705413	5 6" x 1" x 1"	3SG46-K	1	5
07660705414	07660705414	2 6" x 1" x 1"	3SG80-K	1	5
07660705421	07660705421	0 8" x 1" x 1"	3SG46-K	1	5
07660705422	07660705422	7 8" x 1" x 1"	3SG80-K	1	5
White Aluminum Oxide					
07660788248	07660788248	6 6" x 3/4" x 1"	Extra Fine 150	1	5
07660788247	07660788247	9 6" x 3/4" x 1"	Fine 100	1	5
07660788246	07660788246	2 6" x 3/4" x 1"	Medium 60	1	5
07660788263	07660788263	9 6" x 1" x 1"	Extra Fine 150	1	5
07660788262	07660788262	2 6" x 1" x 1"	Fine 100	1	5
07660788261	07660788261	5 6" x 1" x 1"	Medium 60	1	5
07660788283	07660788283	7 8" x 1" x 1"	Extra Fine 150	1	5
07660788282	07660788282	0 8" x 1" x 1"	Fine 100	1	5
07660788281	07660788281	3 8" x 1" x 1"	Medium 60	1	5
Dressing Sticks - Handy Packs					
07660710466	07660710466	3 1" x 1" x 6" Stick	Silicon Carbide-Med	1	10**
66260148820	66260148820	7 Diamond Dresser with Handle - IAGHD		1	5

PART #	UPC-A	SIZE	GRIT	MAX ROM	WHEEL/ CASE
Silicon Carbide For Non-Metal (Green) - Handy Packs					
66252837190	66252837190	3 6" x 3/4" x 1"	Medium 60	4140	1
66252837191	66252837191	0 6" x 3/4" x 1"	Fine 100	4140	1
66252837192	66252837192	7 6" x 3/4" x 1"	Extra Fine 150	4140	1
66252837187	66252837187	3 6" x 1" x 1"	Medium 60	4140	1
66252837193	66252837193	4 6" x 1" x 1"	Fine 100	4140	1
66252837194	66252837194	1 6" x 1" x 1"	Extra Fine 150	4140	1
66252942300	66252942300	7 7" x 1" x 1"	Medium 60	3600	1
66252942301	66252942301	4 7" x 1" x 1"	Fine 100	3600	1
66252942302	66252942302	1 7" x 1" x 1"	Extra Fine 150	3600	1
66253044087	66253044087	1 8" x 1" x 1"	Medium 60	3600	1
66253044534	66253044534	0 8" x 1" x 1"	Fine 100	3600	1
66253044535	66253044535	7 8" x 1" x 1"	Extra Fine 150	3600	1
66253144536	66253144536	3 10" x 1" x 1-1/4"	Medium 60	2485	1
66253160366	66253160366	4 10" x 1" x 1-1/4"	Fine 100	2485	1
66253263359	66253263359	2 12" x 2" x 1-1/4"	Medium 60	2070	1
66253263360	66253263360	8 12" x 2" x 1-1/4"	Fine 100	2070	1
General Purpose Aluminum Oxide For Metal (Brown) - Handy Packs					
07660788201	07660788201	1 5" x 1/2" x 1"	Fine 100	4965	1
07660788202	07660788202	8 5" x 1/2" x 1"	Medium 60	4965	1
07660788205	07660788205	9 5" x 3/4" x 1"	Fine 100	4965	1
07660788210	07660788210	3 5" x 3/4" x 1"	Medium 60	4965	1
07660788215	07660788215	8 5" x 3/4" x 1"	Coarse 36	4965	1
07660788225	07660788225	7 5" x 1" x 1"	Medium 60	4965	1
07660788230	07660788230	5 5" x 1" x 1"	Coarse 36	4965	1
07660788235	07660788235	6 6" x 3/4" x 1"	Fine 100	4140	1
07660788240	07660788240	0 6" x 3/4" x 1"	Medium 60	4140	1
07660788245	07660788245	5 6" x 3/4" x 1"	Coarse 36	4140	1
07660788250	07660788250	9 6" x 1" x 1"	Fine 100	4140	1
07660788255	07660788255	4 6" x 1" x 1"	Medium 60	4140	1
07660788260	07660788260	8 6" x 1" x 1"	Coarse 36	4140	1
07660788265	07660788265	3 7" x 1" x 1"	Fine 100	3600	1
07660788270	07660788270	7 7" x 1" x 1"	Medium 60	3600	1
07660788275	07660788275	2 7" x 1" x 1"	Coarse 36	3600	1
07660788280	07660788280	6 8" x 1" x 1"	Fine 100	3600	1
07660788285	07660788285	1 8" x 1" x 1"	Medium 60	3600	1
07660788286	07660788286	8 8" x 1" x 1"	Coarse 36	3600	1
07660788290	07660788290	5 10" x 1" x 1-1/4"	Medium 60	2485	1
07660788295	07660788295	0 10" x 1" x 1-1/4"	Coarse 36	2485	1
66253263054	66253263054	6 12" x 2" x 1-1/2"	Very Coarse 24	2070	1
66253263055	66253263055	3 12" x 2" x 1-1/2"	Coarse 36	2070	1
66253263056	66253263056	0 12" x 2" x 1-1/2"	Medium 60	2070	1



Cup Brushes

Our broad wire brush offering includes all the basic shapes and configurations: cups, saucer cups, wheels, end brushes and hand brushes - in standard and full cable twist knot, crimped and stringer bead designs.

Typical application includes:

- Cleaning rust, scale and dirt
- Light deburring
- Edge blending
- Roughening for adhesion
- Finishing for appearance
- Finish preparation prior to plating or painting

Knotted Wire Cup Brushes

High-impact cutting and cleaning on more demanding applications such as heavy deburring, weld cleaning and cleaning larger surfaces. Use Double Row Knotted Cup brushes for heavy-duty, aggressive action in very severe applications.



Knotted cup - stainless



Knotted cup - STEEL



Knotted cup with guard

PART #	UPC-A	SIZE	MAX RPM	BRUSHES PER BOX
For Stainless Steel - Knotted Cup - Single Row				
69936653340	699366 53340 8	2-3/4" x .020" x 5/8"-11	15,000	5
66252833947	662528 33947 7	with bridle 4" x .020" x 5/8"-11	9,000	5
For Steel - Knotted Cup With Protective Guard - Single Row				
66252833492	662528 33492 2	2-3/4" x .020" x 5/8"-11	15,000	5
66252833496	662528 33496 0	4" x .020" x 5/8"-11	9,000	5
66252833497	662528 33497 7	5" x .020" x 5/8"-11	6,500	5
For Steel - Knotted Cup - Single Row				
69936653336	699366 53336 1	2-3/4" x .020" x 5/8"-11	15,000	5
69936653345	699366 53345 3	4" x .023" x 5/8"-11	9,000	5
69936605965	699366 05965 6	6" x .023" x 5/8"-11	6,500	5
69936602003	699366 02003 8	6" x .035" x 5/8"-11	6,500	5
For Steel - Knotted Cup - Double Row				
69936653346	699366 53346 0	6" x .020" x 5/8"-11	6,000	1*

Knotted Wire Cup Brushes

For light- to medium-duty brushing applications on flat or irregular surfaces, and bevel buffing.



Crimped cut



Crimped cut with guard



PART #	UPC-A	SIZE	MAX RPM	BRUSHES PER BOX
For Steel - Crimped Cup - Single Row With Protective Guard				
66252833493	662528 33493 9	3" x 12"x.009 brass x 5/8"-11	15,000	5
66252833494	662528 33494 6	4" x 12"x.009 brass x 5/8"-11	9,000	5
For Steel - Crimped Cup - Single Row				
69936653341	699366 53341 5	3" x .014" x 5/8"-11	15,000	5
69936653347	699366 53347 7	4" x .014" x 5/8"-11	9,000	5
69936653348	699366 53348 4	6" x .014" x 5/8"-11	6,000	5
69936653349	699366 53349 1	6" x .020" x 5/8"-11	6,000	1*

Twist Knot Wire Wheel Brushes

For the tougher applications, especially for weld passes or other demanding applications.



PART #	UPC-A	SIZE	MAX RPM	BRUSHES PER BOX
For Stainless Steel - Full Cable				
69936653333	69936653333	4" x .020" x 5/8"-11	20,000	5
66252833488	66252833488	5" x .020" x 5/8"-11	12,500	5
For Steel - Full Cable				
69936653331	69936653331	4" x .020" x 5/8"-11	20,000	6*
66252833487	66252833487	5" x .020" x 5/8"-11	12,500	5
69936653352	69936653352	6" x .023" x 5/8"-11	12,500	5
Standard Twist				
69936606275	69936606275	4-1/2" x .020" x 5/8"-11	20,000	5

Bench & Pedestal Wire Wheels

Narrow face stringer bead wire delivers high impact cutting and cleaning for the toughest applications. Specially suited for groove and weld bead, corners and t-connections. Large wire wheels clean concrete and asphalt joints and cracks quickly and efficiently before filling or scaling.

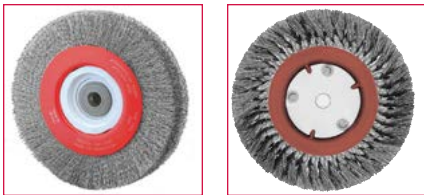

PART #	UPC-A	SIZE	MAX RPM	BRUSHES PER BOX
For Steel - Crimped Bench Wheel - Narrow 1/2" Face				
69936653306	69936653306	6" x .014" x 1/2"-2	6500	5
For Steel - Crimped Bench Wheels - Medium 3/4" Face				
69936653324	69936653324	6" x .014" x 1/2"-2	6500	5
69936653326	69936653326	8" x .014" x 1/2"-2	4500	5
For Steel - Standard Twist Knot Bench Wheel				
69936653327	69936653327	6" x .020" x 5/8"-11	12500	5

Note: Bushing sizes included with each brush.

Stringer Bead Knot Wire Brushes

Specially suited for groove and weld bead, corners and t-connections.



PART #	UPC-A	SIZE	MAX RPM	BRUSHES PER BOX
For Stainless Steel - For Angle Grinders				
69936606278	69936606278	4" x .020" x 5/8"-11	15,000	5
66252833491	66252833491	5" x .020" x 5/8"-11	12,000	10*
69936653351	69936653351	6" x .020" x 5/8"-11	9,000	10*
For Steel - For Angle Grinders				
69936606277	69936606277	4" x .020" x 5/8"-11	15,000	5
66252833489	66252833489	4" x .020" x 5/8"-11	15,000	6*
66252833490	66252833490	5" x .020" x 5/8"-11	12,000	10*
69936653350	69936653350	6" x .020" x 5/8"-11	9,000	10*
69936653329	69936653329	6-7/8" x .020" x 5/8"-11	9,000	10*

Saucer Cup Wire Brushes

Ideal for cleaning corners and other hard to reach areas.



PART #	UPC-A	SIZE	MAX RPM	BRUSHES PER BOX
For Steel - Twist Knot Saucer Cup				
66252833483	66252833483	4" x .020" x 5/8"-11	15,000	5

End Brushes

For use on die grinders to clean and debur a recessed area or the inside diameter of a tube or pipe.



Hand Brushes

The narrow design allows for hand cleaning or deburring into tight areas and slots.



Inspection brush



3" x 19" long handle



4" x 16" Shoe handle



Plastic Handle Stainless



Plastic Handle Steel

PART #	UPC-A	SIZE	MAX RPM	BRUSHES PER BOX
For Stainless Steel - Stem Mounted Crimped				
69936606145	699366 06145	1 3/4" x .006" x 1/4" Shank	20,000	10*
For Steel - Stem Mounted Knotted				
69936653316	699366 53316	3 3/4" x .020" x 1/4" Shank	20,000	10*
69936606279	699366 06279	3 1" x .014" x 1/4" Shank	20,000	10*
69936653310	699366 53310	1" x .020" x 1/4" Shank	20,000	10*
For Steel - Stem Mounted Crimped				
69936653317	699366 53317	0 3/4" x .014" x 1/4" Shank	20,000	10*
69936653309	699366 53309	5 1" x .020" x 1/4" Shank	20,000	10*

PART #	UPC-A	SIZE	BRUSHES PER BOX
For Stainless Steel			
66252833950	662528 33950	7 Scratch Brush 3" x 19" Long Handle	12*
66252833951	662528 33951	4 Scratch Brush 4" x 16" Shoe Handle	30*
66252833953	662528 33953	8 Scratch Brush Plastic Handle	24*
66252833952	662528 33952	1 Inspection Brush 3" x 7"	36*
For Steel			
66252833948	662528 33948	4 Scratch Brush 3" x 19" Long Handle	12*
66252833949	662528 33949	1 Scratch Brush 4" x 16" Shoe Handle	30*
66252833954	662528 33954	5 Scratch Brush Plastic Handle	24*



Norton Painter's Plastic

Our multi-purpose plastic sheeting protects virtually any area from sanding dust and paint overspray with ease - even after repositioning. Mono films and linear low density plastics (LLDPE) don't compare.



FEATURES & BENEFITS

- Resists tearing and solvent bleed-through with lightweight .31 mil High-Density Polyethylene (HDPE) plastic
- Holds in place as it clings to horizontal or vertical surfaces during taping with its natural electrostatic properties
- Attracts and holds sanding debris for a dust free finish
- Drapes easily over furniture

PART #	UPC-A	SIZE	QTY/PACK	PACKS/CASE
07660768142	076607 68142 3	9' x 400 ft.	1	1
07660768143	076607 68143 0	12' x 400 ft.	1	1

Note: pallet quantity is 96 rolls



Norton Hand Masking Film

Norton Hand Masking Film is specially designed to resist paint flaking during multiple-coat paint applications. Paint overspray adheres to the outside layer of plastic, preventing flaking into the base coat and resulting in a cleaner overall work space. Offered in four different sizes with a .375 mil thickness, this clear film will allow you to achieve a high quality job in less time and protect from overspray.

PART #	UPC-A	SIZE	QTY/PACK	PACKS/CASE
07660768305	076607 68305 2	24" x 180' Pre-folded Masking Film - .375mil	1	12
07660768306	076607 68306 9	48" x 180' Pre-folded Masking Film - .375mil	1	12
07660768307	076607 68307 6	72" x 90' Pre-folded Masking Film - .375mil	1	12
07660768308	076607 68308 3	99" x 90' Pre-folded Masking Film - .375mil	1	12



Premium Grade Clean Release Tape

The premium grade, clean release tape comes in a full range of widths for maximum versatility. It has been designed to extremely high standards with tough adhesive strength and maximum flexibility, which means it conforms easily and contours to regular surfaces. Leaves no residue and stays in place until you take it off.

PART #	UPC-A	SIZE	QTY/PACK	PACKS/CASE
07660702450	076607 02450 3	3/4"	1	48
07660702451	076607 02451 0	1"	1	36
07660702452	076607 02452 7	1-1/2"	1	24
07660702453	076607 02453 4	2"	1	24



Non-Woven Pads And Rolls

Non-woven pads are an ideal replacement for steel wool for heavy-duty cleaning and stripping through finishing to light-duty polishing.

- Flexible - can be cut or folded
- Won't rust, shred or splinter
- Washable and reusable
- Use with/without chemicals



PART #	UPC-A	GRIT	GRADING	QTY/ PACK	PACKS/ CASE
Non-Woven Rolls - Bulk					
2" x 15 ft. Pad Rolls					
66261008108	66261008108	6	Asst.	1F,1VF,1UF	1 1
Non-Woven Pads - Handy Packs					
4-3/8" x 11"					
07660748146	07660748146	7	Gray	Between Coats Finishing	1 20**
07660748147	07660748147	4	Green	Paint & Varnish Stripping	1 20**
07660748148	07660748148	1	Maroon	Metal Finishing	1 20**
Non-Woven Pads - Bulk - Non-UPC					
6" x 9" Hand Pads					
66261045600	66261045600	6	White	(456)	10 6
66261074800	66261074800	2	Gray	(748)	20 3
66261079600	66261079600	3	Green	(796)	20 3
66261074700	66261074700	5	Maroon	(747)	20 3
66261074000	66261074000	6	Brown	(740)	20 2
Hand Pad Holder - Bulk					
3-1/4" x 5-1/2"					
66261047583	66261047583	0	Holder		1 -

PART #	UPC-A	GRIT	GRADING	QTY/ PACK	PACKS/ CASE
Synthetic Steel Wool - Handy Packs					
4-3/8" x 5-1/2"					
07660701726	07660701726	0	White	0000 Super Fine	2 10**
07660701727	07660701727	7	Gray	000 Extra Fine	2 10**
07660701728	07660701728	4	Green	0 Fine	2 10**
07660701729	07660701729	1	Charcoal	1 Medium	2 10**
07660703858	07660703858	0	Asst.	1 M, 1F, 1XF	1 10**

Starting Recommendation Guide

Least Aggressive

Most Aggressive

#456 (WHITE) NON-ABRASIVE	#748 (GRAY) MICRO FINE SILICON CARBIDE	#796 (GREEN) VERY FINE ALUMINUM OXIDE	#747 (MAROON) VERY FINE ALUMINUM OXIDE	#740 (BROWN) MEDIUM ALUMINUM OXIDE	#181 (BLUE) COARSE	#180 (GREEN) EXTRA COARSE
Cleaning Pad	Final Shine Pad	Scouring Pad	General Purpose Pad	Heavy Duty Pad	Stripping Pad	Stripping Pad
0000 Super Fine Steel Wool Equivalent	000 Extra Fine Steel Wool Equivalent	0 Fine Steel Wool Equivalent	N/A	N/A	2 Coarse Steel Wool Equivalent	3 Extra Coarse Steel Wool Equivalent
Cleaning • glass • fiberglass • porcelain • ceramic • chrome • copper • stainless steel Wood • highlighting • rubbing Use with liquid detergent	Light Cleaning • steel • non-steel Denibbing plastic Defuzzing wood Finishing areas for blending Final rub	Removing • stains/marks • rust • corrosion • oxidation	Cleaning Finishing Deburring • machinery • tools Removing Rust Defuzzing Wood Light Deburring Preparing surfaces for painting intricate parts	Removing Rust Deburring Blending	Use with chemical strippers for heavy duty stripping and cleaning to remove paint, varnish, lacquer, and other coatings Heavy duty cleaning of grills, metal outdoor furniture, etc.	Use with chemical strippers for heavy duty stripping and scrubbing of surfaces to remove paint, varnish and other coatings



Rotolo Foam

Rotolo Foam pre-cut sheets are conveniently packaged in a roll form and perforated every 5-1/2". They are ideal for fine sanding on round edges, contours and curves, and deliver an outstanding finish.

PART #	UPC-A	GRIT	GRADING	QTY/ PACK	PACKS/ CASE
Rotolo Foam Rolls					
115M x 25M Perforated Every 5-1/2" (A275)					
63642557616	636425 57616	7 1000	115M x 25M	1	2
63642557613	636425 57613	6 800	115M x 25M	1	2
63642557612	636425 57612	9 600	115M x 25M	1	2
63642557611	636425 57611	2 500	115M x 25M	1	2
63642557608	636425 57608	2 400	115M x 25M	1	2
63642557606	636425 57606	8 320	115M x 25M	1	2
63642557604	636425 57604	4 280	115M x 25M	1	2
63642557602	636425 57602	0 240	115M x 25M	1	2
63642557600	636425 57600	6 220	115M x 25M	1	2
63642557599	636425 57599	3 180	115M x 25M	1	2
63642557584	636425 57584	9 150	115M x 25M	1	2
63642535316	636425 35316	4 120	115M x 25M	1	2





Micro-Fiber

Micro-Fiber Cloths have edges that collect debris as opposed to pushing it away. The particles are trapped in between the fibers and can be rinsed or machine washed to release heavily embedded particles. Micro-fiber products can be washed up to 300+ times without losing cleaning and trapping abilities, which will save you labor time and additional costs of multiple cleaning products and chemicals.

- Cleaning Cloth (Blue) is used for general wet or dry cleaning applications
- Dry Tack Cloth (Red) has a low profile to resist snagging and pick up embedded debris
- Polishing Cloth (Yellow) is ideal for streak-free cleaning of mirrors and optical lenses

PART #	UPC-A	GRIT	GRADING	QTY/ PACK	PACKS/ CASE
Cleaning Micro-Fiber Cloth (Blue)					
07660705300	07660705300	8	Cleaning	Blue	- 20
Dry Tack Micro-Fiber Cloth (Red)					
07660706038	07660706038	9	Dry Tack	Red	1 12**
07660704025	07660704025	1	Dry Tack	Red	- 20
Polishing Micro-Fiber Cloth (Yellow)					
07660705301	07660705301	5	Polishing	Yellow	- 20
Tack Cloth					
07660749008	07660749008	7		Tack Cloth	1 144

12 boxes of 12

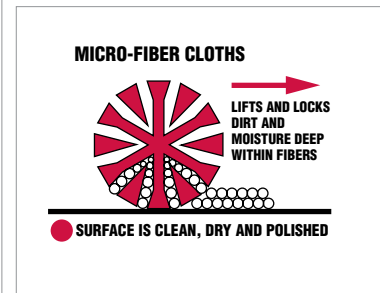
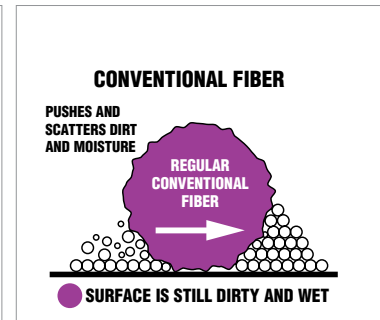
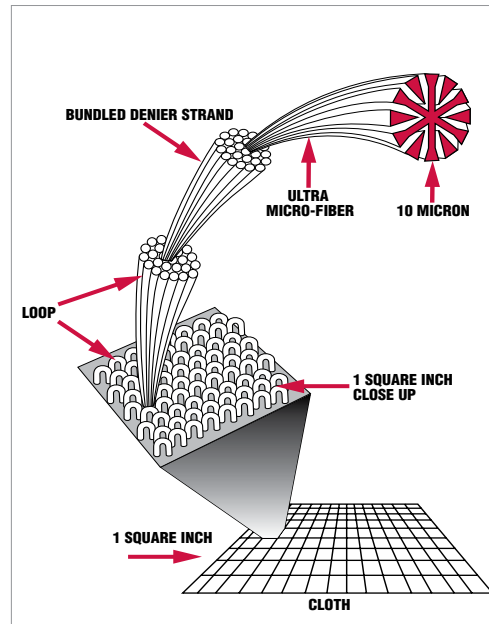

TIP



Micro-fiber is virtually scratch resistant but may pick up debris that can scratch. Clean micro-fiber products often for best results.



Nitrile & Latex Gloves

Norton Nitrile and Latex Disposable Gloves provide options for safety and comfort while tackling even the toughest repair jobs. Available in a full range of styles and sizes, including:

- Blue General-Purpose 4 mil Nitrile Gloves - ideal for smaller projects or when changing gloves frequently is necessary.
- Black Heavy-Duty 6 mil Nitrile Gloves - designed for longer use in more difficult applications.
- Orange Heavy-Duty 7 mil Nitrile Gloves - feature a “diamond” pattern texture to allow for excellent gripping properties. Perfect for jobs you need extra grip to hold onto tools or containers.
- White Textured 7 mil Latex Gloves - for those who prefer/need the tighter fit of the latex design. Excellent for all applications. Gloves do contain natural rubber latex which may cause allergic reactions.

PART #	UPC-A	DESCRIPTION	QTY/ PACK	PACKS/ CASE
66623390700	666233 90700 6	4 mil Nitrile Gloves (Blue) Medium	100	10
66623390701	666233 90701 3	4 mil Nitrile Gloves (Blue) Large	100	10
66623390702	666233 90702 0	4 mil Nitrile Gloves (Blue) XL	100	10
66623390703	666233 90703 7	4 mil Nitrile Gloves (Blue) XXL	100	10
66623390704	666233 90704 4	6 mil Nitrile Gloves (Black) Medium	100	10
66623390705	666233 90705 1	6 mil Nitrile Gloves (Black) Large	100	10
66623390706	666233 90706 8	6 mil Nitrile Gloves (Black) XL	100	10
66623390707	666233 90707 5	6 mil Nitrile Gloves (Black) XXL	100	10
66623390708	666233 90708 2	7 mil Textured Nitrile Gloves (Orange) Medium	50	10
66623390709	666233 90709 9	7 mil Textured Nitrile Gloves (Orange) Large	50	10
66623390710	666233 90710 5	7 mil Textured Nitrile Gloves (Orange) XL	50	10
66623390711	666233 90711 2	7 mil Textured Nitrile Gloves (Orange) XXL	50	10
66623390712	666233 90712 9	7 mil Latex Gloves (White) Medium	100	10
66623390713	666233 90713 6	7 mil Latex Gloves (White) Large	100	10
66623390714	666233 90714 3	7 mil Latex Gloves (White) XL	100	10
66623390715	666233 90715 0	7 mil Latex Gloves (White) XXL	100	10



Glasses

Our line of Norton Safety Glasses features a full range of eyewear options to ensure you always have the right protection for your project. Glasses meet all of the pertinent ANSI specifications for safety eye wear. Each pair of glasses is individually wrapped for convenience and can be hung on a pegboard display.

- Norton Standard Safety Glasses - Economical wrap-around single lens provides full panoramic view. Polycarbonate lenses are coated for superior scratch-resistance.
- Norton Premium Safety Glasses - Rubber temple tips and built-in rubber nose piece keep eye wear secure for the active worker. Scratch resistant anti-fog polycarbonate lens provide 99% UVA/B/C rays protection.
- Norton Over Prescription Glasses - Designed to fit today's prescription eye wear, these scratch-resistant glasses are 100% polycarbonate and deliver 99% UVA/B rays protection.

PART #	UPC-A	DESCRIPTION	QTY/ PACK	PACKS/ CASE
07660768280	07660 768280 2	Norton Safety Glasses	12	25
07660768281	07660 768281 9	Norton Premium Safety Glasses	12	25
07660768282	07660 768282 6	Norton Over Prescription Safety Glasses	12	25

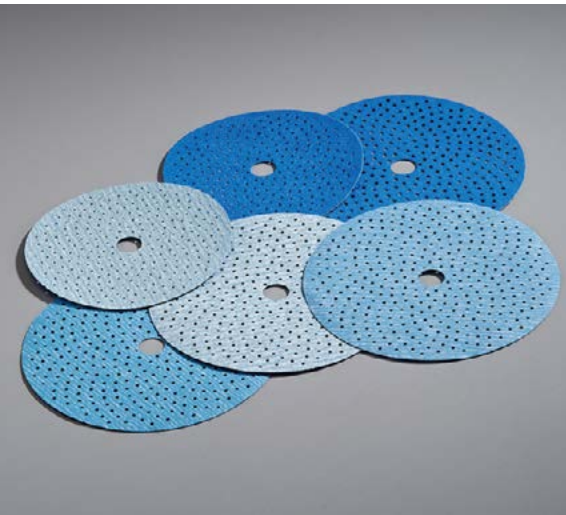

Multi-Air Cyclonic

Revolutionary Norton Multi-Air Cyclonic hook & loop vacuum discs raise the bar in power sanding with a precision laser-cut, spiral-hole design that provides maximum dust extraction for a cleaner work environment with fewer disc changes and greater productivity.



FEATURES & BENEFITS

- Precision laser-cut, spiral-hole hook & loop vacuum design removes material consistently throughout the life of the disc while maximizing dust extraction for a cleaner work environment
- Specialized multi-hole pattern allows for use on any random orbital sander regardless of hole pattern - including unique Festool® sander models
- Premium ceramic abrasive provides a superior cut on all surfaces, lasts substantially longer and removes material faster than conventional abrasives and uses a No-Fil coating to resist clogging/loading during sanding
- Unique fiber-reinforced latex/paper backing is flexible, strong, and tear-resistant

TIER:	BEST
BRAND:	Norton
CAP CODE:	A975 NO-FIL
ABRASIVE:	Ceramic Alumina
PAPER BACKING WEIGHT:	B- & C-Weight
OTHER:	P-Graded

SIZE	GRIT	MIN. / STD PKG.	PART #
5" x 11/16"	80	50/200	776960 07745
	120	50/200	776960 07753
	150	50/200	776960 07755
	180	50/200	776960 07756
	220	50/200	776960 07757
	240	50/200	776960 07760
	280	50/200	776960 07762
	320	50/200	776960 07763
	400	50/200	776960 07765
	500	50/200	776960 07768
6" x 11/16"	80	50/200	776960 07770
	120	50/200	776960 07773
	150	50/200	776960 07774
	180	50/200	776960 07775
	220	50/200	776960 07776
	240	50/200	776960 07777
	280	50/200	776960 07778
	320	50/200	776960 07781
	400	50/200	776960 07784
	500	50/200	776960 07785
600	50/200	776960 07786	
800	50/200	776960 07787	
1000	50/200	776960 07788	

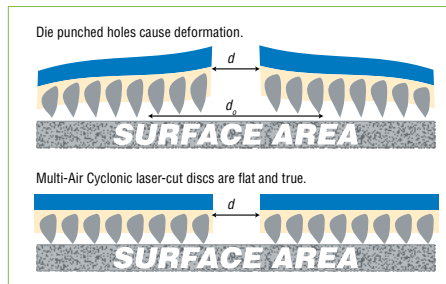
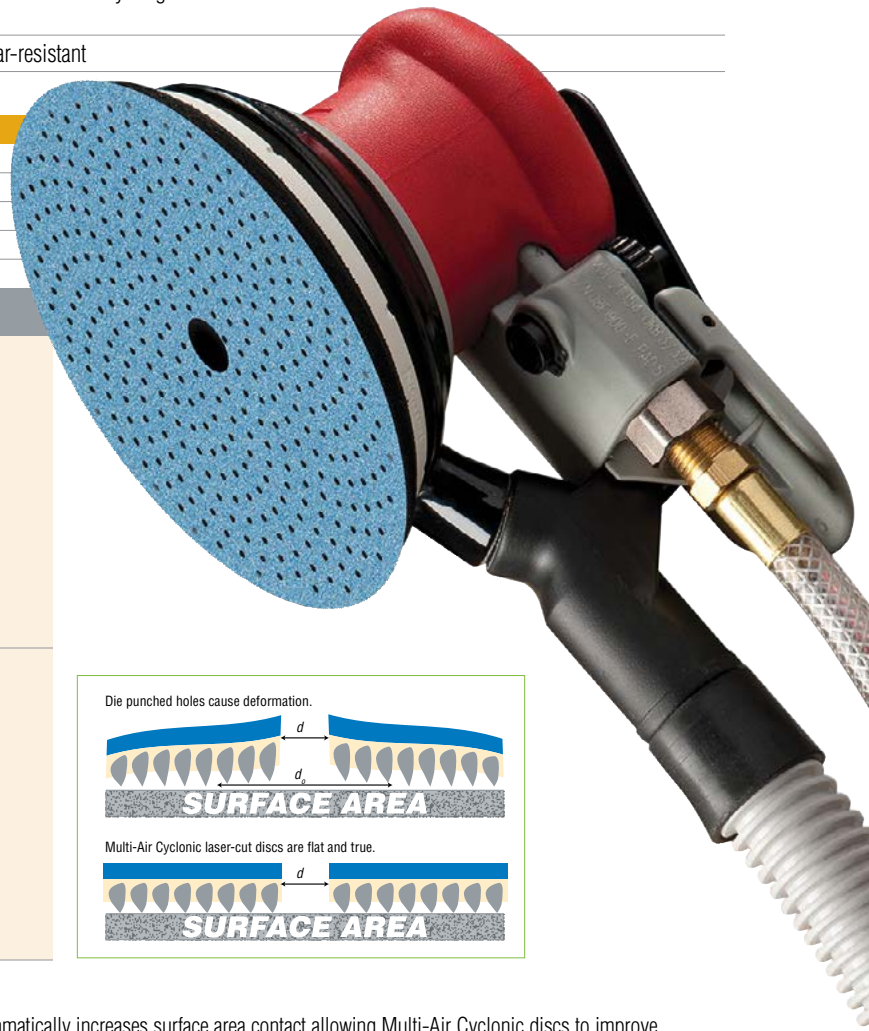

Improved Dust Extraction / Increased Productivity

The upgrade to precise, flat, laser-cut holes instead of die-punched holes, dramatically increases surface area contact allowing Multi-Air Cyclonic discs to improve productivity by 32% versus conventional multi-hole sanding and by 60% versus non-vacuum sanding. The end result is more holes for dust extraction, more abrasive coverage for a better cut and no deformation - for full surface contact utilizing all the cutting power of the premium ceramic grain.

Material/Application-to-Product Recommendation Guide

	BEST Highest Productivity - Lowest Total Cost		BETTER Excellent Blend of Performance & Price		GOOD Consistent Performance - Low Initial Price
	Heavy-Medium Stock Removal	Light Stock Removal-Finishing	Heavy-Medium Stock Removal	Light Stock Removal-Finishing	Light Stock Removal-Finishing
Primed, Painted Surfaces		A975	H875P	A275	PB273
Fiberglass / Composites / Gel Coats		A975	H875P	A275	PB273
Wood		A975	H875P	A275	PB273
Metal	H920	A975	H822	A275	PB273
Body Fillers / Compounds / Plastics		A975	H875P	A275	PB273

Application/Grit Recommendation Guide

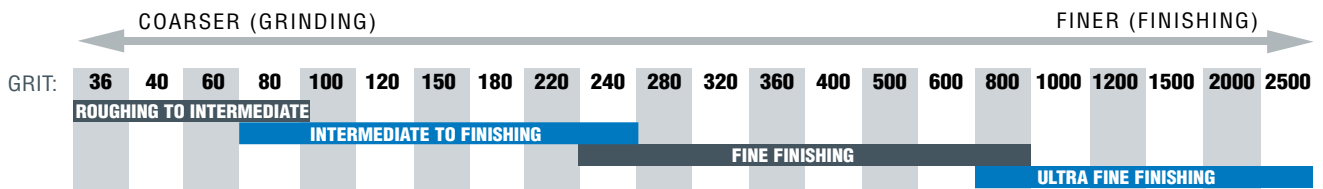

Cross Reference Guide



	BEST		BETTER					GOOD	
	F-Wt.	B- & C-Wt.	F-Wt.	E-Wt.	B-Wt.	B-Wt.	B-Wt.	C-Wt.	B-Wt.
NORTON	Norton SG H920	ProSand/Dry Ice A975	BlueFire H822	BlueFire H875P	Adalox A275	Adalox A270	Durite A475	Adalox A290	PB273
MERIT									
3M	763U, 751I	734U, 735U, 765L	-	750U, 751U, 740I, 745I	216U, 255L, 260L, 334U	210U, 268L, 360L	414N, 415N, 405N, 415U, 435U	236U	214U, 316U Red. NX
Hermes	CB115	-	BW 115	-	VC154-LL	VC152	PSF-LL, SF168	HCAB-LL, HC135, VC151-LL	-
Indasa	-	-	-	-	RedLine	-	-	-	WhiteLine
Klingspor	-	PS36	PS20, PS21, PS22	-	PS33	-	PL35	PS33	PL36
Mirka	-	-	-	Royal Coarse Cut	Q-Silver, Royal, Royal Micro	Silver	CaratFlex, PolarStar	Bulldog Gold, Basecut	Carat (B), Basecut
SIA	-	1950	1820, 1919	1820, 1919	1940, 1950	-	1748	1947	-
VSM	-	-	-	KP510E, KP709	MPG	-	CP131A	KP911	MP10

Light-Weight Paper Discs



NO-FIL NORTON DRYICE A975

BEST CHOICE FOR THE MOST DEMANDING SANDING APPLICATIONS

FEATURES

- P-graded Norton SG ceramic alumina abrasive
- Unique fiber-reinforced, flexible B- and C-weight latex-saturated backing
- Water-based No-Fil stearate, non-pigmented

BENEFITS

- Fastest cut rate; longest life of any paper disc
- 50-60% improvement in tear strength, longer life in all applications
- Flexible
- Provides maximum load resistance and extended life
- No color transfer



NO-FIL NORTON ADALOX A275

BETTER CHOICE FOR HIGH-PERFORMANCE DRY FINISHING ON ALL MATERIALS

FEATURES

- Premium P-graded, heat-treated aluminum oxide abrasive
- Unique fiber-reinforced, flexible B-weight latex-saturated backing
- Water-based stearate, non-pigmented, No-Fil coating
- 5" and 6" individual PSA discs in fine grits have a tabbed, white translucent liner

BENEFITS

- Superior life, fast cut rate, consistent finish
- 50-60% improvement in tear strength
- Flexible
- Provides maximum load resistance and extended life
- No color transfer to work
- The PSA adhesive is protected from airborne contaminants
- The tab allows easier removal of the paper liner



NO-FIL NORTON DURITE A475

BETTER CHOICE FOR HARD-TO-SAND SURFACES AND WOOD APPLICATIONS

FEATURES

- P-graded, hard, silicon carbide abrasive
- Water-based stearate, non-pigmented, No-Fil coating
- Durable, fiber-reinforced, B-weight latex paper

BENEFITS

- Easy penetration of the hardest surfaces
- Resists loading for the longest usable product life
- No color transfer to work
- Provides flexibility and resistance to tearing



MERIT NO-LOAD PB273

GOOD CHOICE FOR SANDING PAINT, PRIMER, PLASTICS, FIBERGLASS, AND WHITEWOOD AT A LOW INITIAL PRICE

FEATURES

- P-graded, aluminum oxide abrasive
- Flexible latex B-weight backing, with a full resin bond and open coat
- Water-based stearate, non-pigmented, No-Fil coating

BENEFITS

- Fast cutting action and extended life with consistent finish
- Improved resistance to delamination; no delamination to back-up pad
- Provides improved load resistance
- No color transfer to work

Heavy-Weight Paper Discs



NORTON SG H920

BEST CHOICE FOR MORE DEMANDING STOCK REMOVAL APPLICATIONS

FEATURES

- Durable and friable Norton SG ceramic alumina abrasive
- Strong, heavy F-weight paper, synthetically-coated

BENEFITS

- Maximum life; fast aggressive cutting action, yet cool cutting
- Maximum durability and chip resistance, ideal for soldered and welded areas, and unpainted metal applications



NORTON BLUEFIRE H875P

BETTER CHOICE FOR SOFT MATERIAL APPLICATIONS

FEATURES

- Next-generation zirconia alumina abrasive
- Strong, heavy, E-weight paper
- Open coat design

BENEFITS

- Extended life over original zirconia alumina products
- Improved cut rate
- Increased durability and chip resistance, flexible
- Reduced loading; ideal for body-filler, fiberglass and composites

Availability
Stick & Sand (PSA)
Heavy-Weight Disc Rolls
Non-Vacuum



TIER:

BEST

BETTER

BETTER

BRAND:

Norton

Norton

Norton

CAP CODE:

H920

H822

H875P

ABRASIVE:

Ceramic Alumina

Zirconia Alumina

Zirconia Alumina

PAPER BACKING WEIGHT:

F-Weight

F-Weight

E-Weight

SIZE	GRIT	ROLLS/STD. PKG.	DISCS/ ROLL	PART #	PART #	PART #
5	60	4	100	662611 49873	662611 137310	662611 124977
	80	4	100	662611 49872	662611 137309	
	100	4	100	662611 49871	662611 137308	
	120	4	100	662611 49870	662611 137307	
6	60	4	100	662611 49876 662611 49874 662611 49879	662611 137323	662611 125573
	80	4	100		662611 137322	
	120	4	100			
8	100	4	50		662611 137333	
	120	4	50			

Refer to the end of this section for back-up pads and accessories.

Availability
Stick & Sand (PSA)
Light-Weight Disc
Rolls Non-Vacuum



TIER:	BEST	BETTER	BETTER	GOOD	GOOD
BRAND:	Norton	Norton	Norton	Norton	Merit
CAP CODE:	A975 NO-FIL	A275 NO-FIL	A475 NO-FIL	A290 NO-FIL	PB273 NO-LOAD
ABRASIVE:	Ceramic Alumina	Aluminum Oxide	Silicon Carbide	Aluminum Oxide	Aluminum Oxide
PAPER BACKING WEIGHT:	B- & C-Weight	B-Weight	B-Weight	C-Weight	B-Weight
OTHER:	P-Graded	P-Graded	P-Graded	P-Graded	P-Graded

SIZE	GRIT	ROLLS/ STD. PKG.	DISCS/ ROLL	PART #	PART #	PART #	PART #	PART #
3-1/2	80	4	100		662611 36376			
	120	4	100		662611 36375			
	180	4	100		662611 36373			
	220	4	100		662611 36372			
	280	4	100		662611 36370			
	320	4	100		662611 36369			
	400	4	100		662611 36368			
5	60	4	100				662611 49831	
	80	4	100	662611 40502	662611 31464*	662544 87415	662611 49830	666233 62930
	100	4	100	662611 40501	662611 31463*	662544 87417	662611 49829	
	120	4	100	662611 40500	662611 31462*	662544 87418	662611 49828	666233 62929
	150	4	100	662611 40499	662611 31461*	662544 87440	662611 49827	666233 62928
	180	4	100	662611 40498	662611 31460*	662544 87441	662611 49826	666233 62927
	220	4	100	662611 42474	662611 31459*	662544 87442	662611 49825	666233 62926
	240	4	100	662611 55380	662611 31458*	662544 87443	662611 49824	666233 62925
	280	4	100	662611 55379	662611 31457*		662611 49823	
	320	4	100	662611 55378	662611 31456*	662544 87444	662611 49822	666233 62924
	400	4	100	662611 55377	662611 31455*	662610 65293	662611 49821	666233 62923
	500	4	100	662544 80231	662611 31453*			
	600	4	100	666233 05608	662611 31452*	662544 21217		666233 62922
800	4	100	662544 80230	662611 31451*	662544 01221		666233 62921	
6	60	4	100				662611 49847	
	80	4	100	662611 40512	662611 31481*	662544 87446	662611 49842	666233 62940
	100	4	100	662611 40511	662611 31480*		662611 49841	699573 52447
	120	4	100	662611 40510	662611 31479*	662544 87447	662611 49840	666233 62939
	150	4	100	662611 40509	662611 31478*		662611 49839	666233 62938
	180	4	100	662611 40508	662611 31477*	662544 87448	662611 49838	666233 62937
	220	4	100	662611 48340	662611 31476*	662544 87449	662611 49837	666233 62936
	240	4	100	662611 55376	662611 31475*		662611 49836	666233 62935
	280	4	100	662611 55375	662611 31474*		662611 49835	
	320	4	100	662611 55374	662611 31473*	662544 87450	662611 49834	666233 62934
	400	4	100	662611 55373	662611 31471*		662611 49833	666233 62933
	500	4	100	636425 06198	662611 31470*			
	600	4	100	636425 06199	662611 31469*			666233 62932
800	4	100	636425 06200	662611 31468*			666233 62931	
8	80	4	100		662611 31617			
	120	4	100		662611 31615			
	150	4	100		662611 31614			
	180	4	100		662611 31613			
	320	4	100		662611 31609			

* PACKAGING STANDARDS A275 = 6/100

Refer to the end of this section for back-up pads and accessories.

Availability
Stick & Sand (PSA)
Light-Weight Disc
Rolls Vacuum



TIER: **BETTER**

BRAND: Norton
CAP CODE: **A275 NO-FIL**
ABRASIVE: Aluminum Oxide
PAPER BACKING WEIGHT: B-Weight
OTHER: P-Graded



TIER: **GOOD**

BRAND: Norton
CAP CODE: **A290 NO-FIL**
ABRASIVE: Aluminum Oxide
PAPER BACKING WEIGHT: C-Weight
OTHER: P-Graded

SIZE	GRIT	ROLLS/STD. PKG.	DISCS/ROLL	PART #	ROLLS/STD. PKG.	DISCS/ROLL	PART #		
				 5 IN. X 5 HOLE DIE #3329					 5 IN. X 5 HOLE DIE #3329
5"	60				4	100	662611 30266		
	80	6	100	662611 31498	4	100	662611 30265		
	100	6	100	662611 31497	4	100	662611 30264		
	120	6	100	662611 31496	4	100	662611 30263		
	150	6	100	662611 31495	4	100	662611 30262		
	180	6	100	662611 31494	4	100	662611 30261		
	220	6	100	662611 31493	4	100	662611 30260		
	240	6	100	662611 31492	4	100	662611 30259		
	320	6	100	662611 31490	4	100	662611 30258		
	400	6	100	662611 31488					
500	6	100	662611 31487						
				 6 IN. X 6 HOLE DIE #3333					 6 IN. X 6 HOLE DIE #3333
6"	80	6	100	662611 31515	4	100	662611 30276		
	100	6	100	662611 31514	4	100	662611 30275		
	120	6	100	662611 31513	4	100	662611 30274		
	150	6	100	662611 31512	4	100	662611 30273		
	180	6	100	662611 31511	4	100	662611 30272		
	220	6	100	662611 31510	4	100	662611 30271		
	240	6	100	662611 31509					
	280	6	100	662611 31508					
	320	6	100	662611 31507	4	100	662611 30268		
	400	6	100	662611 31505					
600	6	100	662611 31503						

Refer to the end of this section for back-up pads and accessories.



PSA Disc Roll Dispenser

- Norton Disc Roll Dispensers feature heavy-duty construction and a rubberized finish to protect your product, as well as the finish on your workpiece
- These versatile dispensers are designed to accommodate any 5" or 6" disc roll or sheet roll
- Can be attached to a wall or stacked for multi-grit or multi-diameter operations
- Discs are individually dispensed and removed from the roll by a cutter bar

DESCRIPTION	STD. PKG.	PART #
PSA Disc Roll Dispenser		
Single Disc Roll Dispenser	1	636425 42772
Double Disc Roll Dispenser (shown)	1	636425 02981

Availability
Stick & Sand (PSA)
Individual Discs

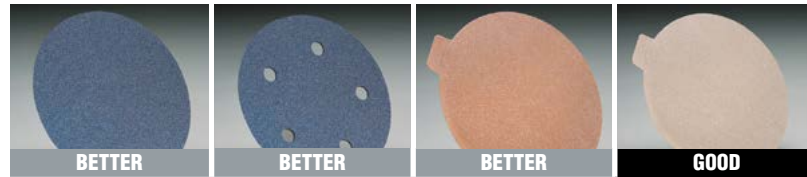

TIER:	BETTER	BETTER	BETTER	GOOD
BRAND:	Norton	Norton	Norton	Merit
CAP CODE:	H875P	H875P	A275 NO-FIL	PB273 NO-LOAD
ABRASIVE:	Zirconia Alumina	Zirconia Alumina	Aluminum Oxide	Aluminum Oxide
PAPER BACKING WEIGHT:	E-Weight	E-Weight	B-Weight	B-Weight
FASTENING:	PSA	PSA Vacuum	PSA Tabbed	PSA Tabbed
OTHER:			P-Graded	P-Graded

SIZE	GRIT	MIN. / STD PKG.	PART #	PART #	PART #	PART #
5"	36	50/200	662611 25436			
	40	50/200	662611 25307			
	80	50/200	662611 25244			
	100	100/400				699573 48198 ‡
	120	100/400				699573 48200
	150	100/400				699573 48201
	180	100/400				699573 48202
	220	100/400				699573 48203
	240	100/400				699573 48204
	320	100/400				
	400	100/400				699573 48206
	600	100/400				
	800	100/400				699573 48223
	1000	100/400			662611 31450	
1200	100/400			662611 31449		
				 6" X 6 HOLE DIE #3371		
6"	36	50/200	662611 23575			
	40	50/200	662611 23574	662611 23580		
	80	50/200	662611 23573			
	1000	100/400			662611 31467	
	1200	100/400			662611 31466	
	1500	100/400			662611 31465	
				 8" X 8 HOLE DIE #3370		
8"	36	25/100	662611 23578	662611 23584		
	40	25/100	662611 23577			
	80	25/100	662611 23576	662611 23582		

PACKAGING STANDARDS:
MIN. / STD. PKG.
‡ PB273 = 100/400

Refer to the end of this section for back-up pads and accessories.

Availability
Hook & Loop
Individual Discs
Non-Vacuum



TIER:	BEST	BEST	BETTER	BETTER	BETTER	GOOD	GOOD
BRAND:	Norton	Norton	Norton	Norton	Norton	Norton	Merit
CAP CODE:	H920	A975 NO-FIL	H875P	A275 NO-FIL	A475 NO-FIL	A290 NO-FIL	PB273 NO-LOAD
ABRASIVE:	Ceramic Alumina	Ceramic Alumina	Zirconia Alumina	Aluminum Oxide	Silicon Carbide	Aluminum Oxide	Aluminum Oxide
PAPER BACKING WEIGHT:	F-Weight	B- & C-Weight	E-Weight	B-Weight	B-Weight	C-Weight	B-Weight
OTHER:		P-Graded		P-Graded	P-Graded	P-Graded	P-Graded

SIZE	GRIT	MIN./ STD PKG.	PART #	PART #	PART #	PART #	PART #	PART #	PART #
3"	80	50/200		636425 05990		662611 131532			
	100	50/200				662611 144926			
	120	50/200		636425 05991		662611 128688			
	150	50/200		636425 05992		662611 140385			
	180	50/200		636425 05993		662611 131528			
	220	50/200		636425 05994		662611 131527			
	240	50/200		636425 05995		662611 131526			
	320	50/200		636425 05996		662611 131524			
	400	50/200		636425 05997		662611 136995			
	500	50/200		636425 05998		662611 131521			
	600	50/200		636425 05999		662611 136996			
	800	50/200		636425 06000		662611 131519			
	1000	50/200		636425 06001		662611 135900			
	1200	50/200							
1500	50/200			636425 06002		662611 147434			
5"	40	25/100			662611 125684				
	60	100/400	662611 149864*				662611 130224		
	80	100/400	662611 149865*	662611 140522‡	662611 125444•	662611 131549	662611 149907	666233 62950	
	100	100/400	662611 149866*	662611 140521‡		662611 131548	662611 149906	666233 65788	
	120	100/400	662611 149867*	662611 140520‡		662611 131547	662611 149905	666233 62949	
	150	100/400		662611 140519‡		662611 131546	662611 149904	666233 62948	
	180	100/400		662611 140518‡		662611 131545	662611 149903	666233 62947	
	220	100/400		662611 149541‡		662611 131544	662611 149902	666233 62946	
	240	100/400		662611 149540‡		662611 131543		666233 62945	
	280	100/400				662611 131542			
	320	100/400		662611 149538‡		662611 131541		662611 149900	666233 62944
	400	100/400		662611 149537‡		662611 131539	662610 52270	662611 149899	666233 62943
	500	100/400		662544 80233‡		662611 131538			
	600	100/400				662611 131537	662544 21221		666233 62942
	800	100/400		662544 80232‡		662611 131536	662610 52267		666233 62941
	1000	100/400				662611 131535	662610 52254		
1200	100/400				662611 131534				
1500	100/400				662611 131533				
6"	36	25/100			662611 123590				
	40	25/100			662611 123589				
	80	100/400		662611 140532‡	662611 123588•	662611 131566	662611 149916	666233 62960	
	100	100/400		662611 140531‡		662611 131565	662611 149915	666233 65789	
	120	100/400		662611 140530‡		662611 131564	662611 149914	666233 62959	
	150	100/400		662611 140529‡		662611 131563	662611 149913	666233 62958	
	180	100/400		662611 140528‡		662611 131562	662611 149912	666233 62957	
	220	100/400		662611 149546‡		662611 131561	662611 149911	666233 62956	
	240	100/400				662611 131560		666233 62955	
	280	100/400				662611 131559			
	320	100/400		662611 149543‡		662611 131558	662611 149910	662611 149909	666233 62954
	400	100/400		662611 149542‡		662611 131556	662611 149908	662611 149908	666233 62953
	500	100/400		636425 06202‡		662611 131555			
	600	100/400		636425 06203‡		662611 131554			666233 62952
	800	100/400		636425 06204‡		662611 131553	662610 52268		666233 62951
	1000	100/400		636425 06375‡		662611 131552	662610 52255		
1200	100/400		636425 06376‡		662611 131551				
1500	100/400		636425 06377‡		662611 131550				
8"	36	25/100			662611 123593				
	40	25/100			662611 123592				
	60	50/250							
	80	50/250			662611 123591•				
	100	50/250							
	120	100/400				662611 131662			
	180	100/400				662611 131661			







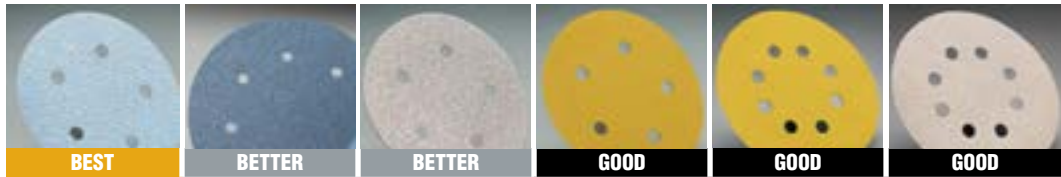

PACKAGING STANDARDS: MIN. / STD. PKG.
 * H920 = 50/250
 † A975 = 50/200
 ‡ H875P = 25/100

Refer to the end of this section for back-up pads and accessories.

**Availability
Hook & Loop
Individual Discs
Vacuum**

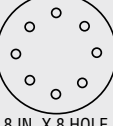

TIER:	BEST	BETTER	BETTER	GOOD	GOOD	GOOD
BRAND:	Norton	Norton	Norton	Norton	Norton	Merit
CAP CODE:	A975 NO-FIL	H875P	A275 NO-FIL	A290 NO-FIL	A290 NO-FIL	PB273 NO-LOAD
ABRASIVE:	Ceramic Alumina	Zirconia Alumina	Aluminum Oxide	Aluminum Oxide	Aluminum Oxide	Aluminum Oxide
PAPER BACKING WEIGHT:	B- & C-Weight	E-Weight	B-Weight	C-Weight	C-Weight	B-Weight
OTHER:	P-Graded		P-Graded	P-Graded	P-Graded	P-Graded

SIZE	GRIT	MIN./ STD PKG.	PART #	PART #	PART #	PART #	PART #	PART #
			 5 IN. X 5 HOLE DIE #3328		 5 IN. X 5 HOLE DIE #3328	 5 IN. X 5 HOLE DIE #3328	 5 IN. X 8 HOLE DIE #3392	 5 IN. X 8 HOLE DIE #3392
5	60	100/400				662611 30236 ‡	662611 30245 ‡	
	80	100/400	662611 40517 ‡		662611 31583	662611 30235 ‡	662611 30244 ‡	666233 66071
	100	100/400			662611 31582	662611 30234 ‡	662611 30243 ‡	
	120	100/400	662611 40515 ‡		662611 31581	662611 30233 ‡	662611 30242 ‡	666233 69778
	150	100/400			662611 31580	662611 30232 ‡	662611 30241 ‡	666233 66073
	180	100/400			662611 31579	662611 30231 ‡	662611 30240 ‡	666233 66074
	220	100/400			662611 31578	662611 30230 ‡	662611 30239 ‡	666233 66075
	240	100/400			662611 31577			
	320	100/400			662611 31575	662611 30227 ‡	662611 30238 ‡	666233 66077
	400	100/400			662611 31573	662611 30226 ‡		
	600	100/400			662611 31571			
			 6 IN. X 6 HOLE DIE #3371		 6 IN. X 6 HOLE DIE #3371	 6 IN. X 6 HOLE DIE #3371		 6 IN. X 6 HOLE DIE #3371
6	80	100/400	662611 40527 ‡		662611 31600	662611 30255 ‡		666233 67394
	100	100/400			662611 31599			
	120	100/400			662611 31598	662611 30253 ‡		
	150	100/400			662611 31597			666233 67397
	180	100/400			662611 31596	662611 30251 ‡		666233 67398
	220	100/400			662611 31595	662611 30250 ‡		666233 67399
	280	100/400			662611 31593			
	320	100/400	662611 49553 ‡		662611 31592			666233 67400
	400	100/400			662611 31590			666233 67401
	600	100/400			662611 31588			
	800	100/400			662611 31587			
	1000	100/400			662611 31586			
	1200	100/400			662611 31585			
	1500	100/400			662611 31584			
				 8 IN. X 8 HOLE DIE #3370				
8	36	25/100			662611 23598			
	80	25/100			662611 23596			

PACKAGING STANDARDS: ‡ A975, A975 VACUUM, A290 VACUUM = 50/200



Multi-Air Foam Interface Pads

- Designed for use with fine grit Multi-Air Cyclonic Hook & Loop sanding discs to improve both surface finish and cut rate
- Use with Multi-Air Hook & Loop Disc Back-Up Pads
- Align the interface pad with the Multi-Air back up pad then simply attach the disc to the interface pad because the holes do not have to be lined up

DESCRIPTION	STD. PKG.	PART #
Multi-Air Foam Interface Pads		
5" Diameter x 1/2" Thick Pad	8	636425 85864
6" Diameter x 1/2" Thick Pad	12	076607 19359

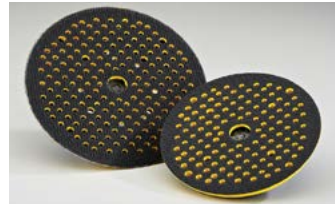

Multi-Air Hook & Loop Back-up Pads with Vacuum Holes

- Innovative design optimized for maximum air flow and powerful dust extraction
- Pads are engineered with a durable urethane foam, heat-resistant plastic, a molded-in 5/16"-24 spindle, and hooked face
- Holes in the disc do not have to be matched up with the holes in the pad, so changeover is fast and easy

DESCRIPTION	MAX. RPM	STD. PKG.	PART #
Multi-Air Hook & Loop Back-Up Pads with Vacuum Holes			
5" (125mm) with 5/16"-24 Shank, Medium-Density Urethane Pad	15,000	5	666233 76000
6" (150mm) with 5/16"-24 Shank, Medium-Density Urethane Pad	15,000	5	636425 06160



Low-Profile Pads for Dual Action / Random Orbital Sanders

- Soft density low-profile pads utilize 1/2" thick foam for fine finish sanding and offer moderate conformability
- Medium low-profile pads have 1/2" thick urethane foam for intermediate and finish sanding
- Available with PSA or hook and loop faces; both designs are shock resistant and have a fiberglass backing plate with a riveted 5/16"-24 threaded shank for added strength and increased heat resistance
- Available with standard hole patterns for vacuum-assist sanding

DESCRIPTION	MAX. RPM	STD. PKG.	PART #
Low Profile Pads for DA/Random Orbital Sanders			
3" Hook & Loop Soft Low-Profile	12,000	10*	636425 06128
3-1/4" Hook & Loop Buffing Pad		5*	662610 85302
5" PSA Soft Low-Profile	12,000	5*	636425 06126
5" PSA Medium Low-Profile	15,000	5*	636425 06131
5" PSA Medium Low-Profile with 5 vacuum holes	15,000	5*	636425 06132
5" Hook & Loop Soft Low-Profile	12,000	5*	636425 06129
5" Hook & Loop Medium Low-Profile	15,000	5*	636425 06135
5" Hook & Loop Medium Low-Profile with 5 vacuum holes	15,000	5*	636425 06136
6" PSA Soft Low-Profile	12,000	5*	636425 06127
6" PSA Medium Low-Profile	15,000	5*	636425 06133
6" PSA Medium Low-Profile with 6 vacuum holes	15,000	5*	636425 06134
6" Hook & Loop Soft Low-Profile	12,000	5*	636425 06130
6" Hook & Loop Medium Low-Profile	15,000	5*	636425 06137
6" Hook & Loop Medium Low-Profile with 6 vacuum holes	15,000	5*	636425 06138
8" Hook & Loop Medium Low-Profile with 8 vacuum holes, 5 screw	1,500	5*	636425 43712
8" Hook & Loop Medium Low-Profile with 8 vacuum holes, 6 screw	1,500	5*	636425 43714

* PACKED IN INDIVIDUAL CLAMSHELL

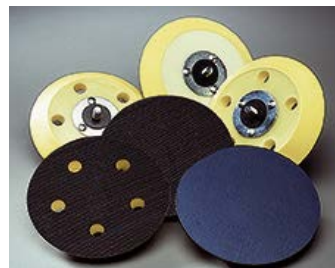

Tapered Pads for Dual Action / Random Orbital Sanders

- Designed with medium density polyurethane foam and a tapered edge for conformability, these pads are firm enough for flat surfaces, yet soft enough for severe curves and contours
- Available with either PSA (vinyl) or hook and loop faces in vacuum or non-vacuum
- The 5" and 6" pads are shock resistant and have a fiberglass backing plate with a riveted 5/16"-24 threaded shank for use on random orbital or dual action sanders
- The 8" pads have a 5/8"-11 threaded female hub

DESCRIPTION	MAX. RPM	STD. PKG.	PART #
Tapered Pads for DA/Random Orbital Sanders			
5" PSA Medium Tapered	15,000	5*	636425 06139
5" PSA Medium Tapered with 5 vacuum holes	15,000	5*	636425 06140
5" Hook & Loop Medium Tapered	15,000	5*	636425 06143
5" Hook & Loop Medium Tapered with 5 vacuum holes	15,000	5*	636425 06144
6" PSA Medium Tapered	15,000	5*	636425 06141
6" PSA Medium Tapered with 6 vacuum holes	15,000	5*	636425 06142
6" Hook & Loop Medium Tapered	15,000	5*	636425 06145
6" Hook & Loop Medium Tapered with 6 vacuum holes	15,000	5*	636425 06146
8" PSA Medium Tapered	6,000	5*	636425 43112
8" Hook & Loop Medium Tapered	3,200	5*	636425 43704

* PACKED IN INDIVIDUAL CLAMSHELL



Hook & Loop
Foam Interface
Pads

- Designed for use with our fine grit hook and loop sanding discs
- Improve both surface finish and cut rate
- Use with hook and loop back-up pads

DESCRIPTION	STD. PKG.	PART #
Foam Hook & Loop Interface Pads		
3" Diameter, 1/2" Thick Interface	10	636425 05457
6" Diameter, 1/2" Thick Interface	5	636425 42089
5" Diameter, 3/4" Thick Interface	2	636425 02161
6" Diameter, 3/4" Thick Interface	20	636425 02162



Half Moon
Hand Pad

- The unique half moon pad uses a standard 5" hook and loop disc folded in half, which adheres to the hooks on the pad face
- The straight edge of the pad allows the operator to sand corners, contours, narrow crevices and minute imperfections without over-sanding

DESCRIPTION	STD. PKG.	PART #
Half Moon Hand Pad		
5" Hook and Loop	10	636425 02768



Polishing
Adapter Pad

- Converts your standard hook and loop pad into a soft polishing pad
- The foam adapter is 3/8" thick and is excellent for fine grits where minimal removal is required
- It is ideal for either flat or contour surfaces

DESCRIPTION	MAX. RPM	STD. PKG.	PART #
Polishing Adapter Pad			
5" Hook and Loop Adapter Pad	3,786	10	636425 03121



Ergonomic
Hand Sanders

- The ergonomic palm sander is uniquely designed to be user-friendly, with finger indentations for the operator
- It quickly converts standard 5" and 6" hook and loop discs into hand sanders for finishing flat surfaces

DESCRIPTION	STD. PKG.	PART #
Ergonomic Hand Sander		
5" Hook and Loop	5	636425 03147
6" Hook and Loop	5	636425 03726



Disc
Hand Pads

- Hand pads eliminate finger sanding
- The ultra-thin 3/16" thick pad is composed of a single layer of neoprene foam and is designed for maximum flexibility - producing excellent finishes
- The 1" thick pad is composed of two layers, neoprene and polyester foam, for excellent conformability and softness, resulting in fine finishes
- Each pad has an elastic hand strap to hold it firmly in place
- Available with either PSA (vinyl) faces or hook and loop face

DESCRIPTION	STD. PKG.	PART #
Disc Hand Pads		
5" x 3/16" Thick Soft Foam PSA	10	636425 03111
5" x 1" Thick Soft Foam PSA	10	636425 02842
5" x 1" Thick Soft Foam Hook and Loop	10	636425 03117



Panel and
Adhesive
Cleaner

- Removes adhesives, tar, grease, wax, body sealers, undercoating sprays, and silicone from most surfaces
- Aggressive cleaner is safe to use on most paint applications
- Packaged with squirt dispenser
- Use as directed

DESCRIPTION	STD. PKG.	PART #
Panel and Adhesive Cleaner		
Quart Can	12	076607 82780



Wide - Cloth

Cloth woodworking wide belts are used for rough stock removal and dimensioning. Our FastTrack express belt service has an extensive range of sizes and specifications with exceptional leadtimes.

W x L	GRIT	BEST	GOOD	W x L	GRIT	BEST	GOOD	W x L	GRIT	BEST	GOOD	W x L	GRIT	BEST	GOOD
		Z/A Y-WT.	A/O X-WT.			Z/A Y-WT.	A/O X-WT.			Z/A Y-WT.	A/O X-WT.			Z/A Y-WT.	A/O X-WT.
4" x 90"	36	60846	60000	6" x 108"	36	60920	60078	6" x 168"	36	60976	60138	18" x 85"	36	61031	60208
	40	60847	60001		40	60921	60079		40	60977	60139		40	61032	60209
	50	60848	60002		50	60922	60080		50	60978	60140		50	61033	60210
	60	60849	60003		60	60923	60081		60	60979	60141		60	61034	60211
	80	60850	60004		80	60924	60082		80	60980	60142		80	61035	60212
	100	60851	60005		100	60925	60083		100	60981	60143		100	61036	60213
	120	60852	60006		120	60926	60084		120	60982	60144		120	61037	60214
	150	60007			150	60085			150	60145			150	60215	
	180	60008			180	60086			180	60146			180	60216	
220	60009		220	60087		220	60147		220	60217					
4" x 132"	36	60863	60019	6" x 132"	36	60938	60098	6" x 186"	36	60993	60158	19" x 48"	36	61038	60218
	40	60864	60020		40	60939	60099		40	60994	60159		40	61039	60219
	50	60865	60021		50	60940	60100		50	60995	60160		50	61040	60220
	60	60866	60022		60	60941	60101		60	60996	60161		60	61041	60221
	80	60867	60023		80	60942	60102		80	60997	60162		80	61042	60222
	100	60868	60024		100	60943	60103		100	60998	60163		100	61043	60223
	120	60869	60025		120	60944	60104		120	60999	60164		120	61044	60224
	150	60026			150	60105			150	60165			150	60225	
	180	60027			180	60106			180	60166			180	60226	
220	60028		220	60107		220	60167		220	60227					
6" x 80"	36	60889	60038	6" x 144"	36	60955	60108	18" x 48"	36	61010	60178	24" x 48"	36	61075	60248
	40	60890	60039		40	60956	60109		40	61011	60179		40	61076	60249
	50	60891	60040		50	60957	60110		50	61012	60180		50	61077	60250
	60	60892	60041		60	60958	60111		60	61013	60181		60	61078	60251
	80	60893	60042		80	60959	60112		80	61014	60182		80	61079	60252
	100	60894	60043		100	60960	60113		100	61015	60183		100	61080	60253
	120	60895	60044		120	60961	60114		120	61016	60184		120	61081	60254
	150	60045			150	60115			150	60185			150	60255	
	180	60046			180	60116			180	60186			180	60256	
220	60047		220	60117		220	60187		220	60257					
6" x 89"	36	60906	60058	6" x 158"	36	60962	60118	18" x 72"	36	61017	60188	24" x 55"	36	61083	60258
	40	60907	60059		40	60963	60119		40	61018	60189		40	61084	60259
	50	60908	60060		50	60964	60120		50	61019	60190		50	61085	60260
	60	60909	60061		60	60965	60121		60	61020	60191		60	61086	60261
	80	60910	60062		80	60966	60122		80	61021	60192		80	61087	60262
	100	60911	60063		100	60967	60123		100	61022	60193		100	61088	60263
	120	60912	60064		120	60968	60124		120	61023	60194		120	61089	60264
	150	60065			150	60125			150	60195			150	60265	
	180	60066			180	60126			180	60196			180	60266	
220	60067		220	60127		220	60197		220	60267					
6" x 90"	36	60913	60068	6" x 159"	36	60969	60128	18" x 75"	36	61024	60198	24" x 60"	36	61091	60268
	40	60914	60069		40	60970	60129		40	61025	60199		40	61092	60269
	50	60915	60070		50	60971	60130		50	61026	60200		50	61093	60270
	60	60916	60071		60	60972	60131		60	61027	60201		60	61094	60271
	80	60917	60072		80	60973	60132		80	61028	60202		80	61095	60272
	100	60918	60073		100	60974	60133		100	61029	60203		100	61096	60273
	120	60919	60074		120	60975	60134		120	61030	60204		120	61097	60274
	150	60075			150	60135			150	60205			150	60275	
	180	60076			180	60136			180	60206			180	60276	
220	60077		220	60137		220	60207		220	60277					

W x L	GRIT	BEST	GOOD	W x L	GRIT	BEST	GOOD	W x L	GRIT	BEST	GOOD	W x L	GRIT	BEST	GOOD
		Z/A Y-WT.	A/O X-WT.			Z/A Y-WT.	A/O X-WT.			Z/A Y-WT.	A/O X-WT.			Z/A Y-WT.	A/O X-WT.
24" x 72"	36	61099	60278	25" x 75"	36	61155	60348	36" x 48"	36	61211	60418	37" x 48"	36	61267	60488
	40	61100	60279		40	61156	60349		40	61212	60419		40	61268	60489
	50	61101	60280		50	61157	60350		50	61213	60420		50	61269	60490
	60	61102	60281		60	61158	60351		60	61214	60421		60	61270	60491
	80	61103	60282		80	61159	60352		80	61215	60422		80	61271	60492
	100	61104	60283		100	61160	60353		100	61216	60423		100	61272	60493
	120	61105	60284		120	61161	60354		120	61217	60424		120	61273	60494
	150		60285		150		60355		150		60425		150		60495
	180		60286		180		60356		180		60426		180		60496
220		60287	220		60357	220		60427	220		60497				
24" x 75"	36	61107	60288	25" x 103"	36	61163	60358	36" x 55"	36	61219	60428	37" x 60"	36	61275	60498
	40	61108	60289		40	61164	60359		40	61220	60429		40	61276	60499
	50	61109	60290		50	61165	60360		50	61221	60430		50	61277	60500
	60	61110	60291		60	61166	60361		60	61222	60431		60	61278	60501
	80	61111	60292		80	61167	60362		80	61223	60432		80	61279	60502
	100	61112	60293		100	61168	60363		100	61224	60433		100	61280	60503
	120	61113	60294		120	61169	60364		120	61225	60434		120	61281	60504
	150		60295		150		60365		150		60435		150		60505
	180		60296		180		60366		180		60436		180		60506
220		60297	220		60367	220		60437	220		60507				
24" x 84"	36	61115	60298	30" x 72"	36	61171	60368	36" x 60"	36	61227	60438	37" x 72"	36	61283	60508
	40	61116	60299		40	61172	60369		40	61228	60439		40	61284	60509
	50	61117	60300		50	61173	60370		50	61229	60440		50	61285	60510
	60	61118	60301		60	61174	60371		60	61230	60441		60	61286	60511
	80	61119	60302		80	61175	60372		80	61231	60442		80	61287	60512
	100	61120	60303		100	61176	60373		100	61232	60443		100	61288	60513
	120	61121	60304		120	61177	60374		120	61233	60444		120	61289	60514
	150		60305		150		60375		150		60445		150		60515
	180		60306		180		60376		180		60446		180		60516
220		60307	220		60377	220		60447	220		60517				
24" x 103"	36	61123	60308	30" x 75"	36	61179	60378	36" x 72"	36	61235	60448	37" x 75"	36	61291	60518
	40	61124	60309		40	61180	60379		40	61236	60449		40	61292	60519
	50	61125	60310		50	61181	60380		50	61237	60450		50	61293	60520
	60	61126	60311		60	61182	60381		60	61238	60451		60	61294	60521
	80	61127	60312		80	61183	60382		80	61239	60452		80	61295	60522
	100	61128	60313		100	61184	60383		100	61240	60453		100	61296	60523
	120	61129	60314		120	61185	60384		120	61241	60454		120	61297	60524
	150		60315		150		60385		150		60455		150		60525
	180		60316		180		60386		180		60456		180		60526
220		60317	220		02488	220		60457	220		60527				
25" x 48"	36	61131	60318	30" x 84"	36	61187	60388	36" x 75"	36	61243	60458	37" x 103"	36	61299	60528
	40	61132	60319		40	61188	60389		40	61244	60459		40	61300	60529
	50	61133	60320		50	61189	60390		50	61245	60460		50	61301	60530
	60	61134	60321		60	61190	60391		60	61246	60461		60	61302	60531
	80	61135	60322		80	61191	60392		80	61247	60462		80	61303	60532
	100	61136	60323		100	61192	60393		100	61248	60463		100	61304	60533
	120	61137	60324		120	61193	60394		120	61249	60464		120	61305	60534
	150		60325		150		60395		150		60465		150		60535
	180		60326		180		60396		180		60466		180		60536
220		60327	220		60397	220		60467	220		60537				
25" x 60"	36	61139	60328	30" x 103"	36	61195	60398	36" x 84"	36	61251	60468	38" x 103"	36		60538
	40	61140	60329		40	61196	60399		40	61252	60469		40		60539
	50	61141	60330		50	61197	60400		50	61253	60470		50		60540
	60	61142	60331		60	61198	60401		60	61254	60471		60		60541
	80	61143	60332		80	61199	60402		80	61255	60472		80		60542
	100	61144	60333		100	61200	60403		100	61256	60473		100		60543
	120	61145	60334		120	61201	60404		120	61257	60474		120		60544
	150		60335		150		60405		150		60475		150		60545
	180		60336		180		60406		180		60476		180		60546
220		60337	220		60407	220		60477	220		60547				
25" x 72"	36	61147	60338	35" x 75"	36	61203	60408	36" x 103"	36	61259	60478	40" x 75"	36	61307	60548
	40	61148	60339		40	61204	60409		40	61260	60479		40	61308	60549
	50	61149	60340		50	61205	60410		50	61261	60480		50	61309	60550
	60	61150	60341		60	61206	60411		60	61262	60481		60	61310	60551
	80	61151	60342		80	61207	60412		80	61263	60482		80	61311	60552
	100	61152	60343		100	61208	60413		100	61264	60483		100	61312	60553
	120	61153	60344		120	61209	60414		120	61265	60484		120	61313	60554
	150		60345		150		60415		150		60485		150		60555
	180		60346		180		60416		180		60486		180		60556
220		60347	220		60417	220		60487	220		60557				

				BEST				GOOD							
				Z/A Y-WT.				A/O X-WT.							
W x L	GRIT	076607-	076607-	W x L	GRIT	076607-	076607-	W x L	GRIT	076607-	076607-	W x L	GRIT	076607-	076607-
42" x 72"	36	61315	60568	43" x 75"	36	61355	60638	44" x 103"	36	61395	60698	52" x 75"	36	61435	60758
	40	61316	60569		40	61356	60639		40	61396	60699		40	61436	60759
	50	61317	60570		50	61357	60640		50	61397	60700		50	61437	60760
	60	61318	60571		60	61358	60641		60	61398	60701		60	61438	60761
	80	61319	60572		80	61359	60642		80	61399	60702		80	61439	60762
	100	61320	60573		100	61360	60643		100	61400	60703		100	61440	60763
	120	61321	60574		120	61361	60644		120	61401	60704		120	61441	60764
	150		60575		150		60645		150		60705		150		60765
	180		60576		180		60646		180		60706		180		60766
220		60577	220		60647	220		60707	220		60767				
42" x 75"	36	61323	60578	43" x 85"	36	61363	60648	50" x 75"	36	61403	60718	52" x 85"	36	61443	60768
	40	61324	60579		40	61364	60649		40	60404	60719		40	61444	60769
	50	61325	60580		50	61365	60650		50	61405	60720		50	61445	60770
	60	61326	60581		60	61366	60651		60	61406	60721		60	61446	60771
	80	61327	60582		80	61367	60652		80	61407	60722		80	61447	60772
	100	61328	60583		100	61368	60653		100	61408	60723		100	61448	60773
	120	61329	60584		120	61369	60654		120	61409	60724		120	61449	60774
	150		60585		150		60655		150		60725		150		60775
	180		60586		180		60656		180		60726		180		60776
220		60587	220		60657	220		60727	220		60777				
42" x 84"	36	61331	60598	43" x 103"	36	61371	60658	50" x 84"	36	61411	60728	52" x 103"	36	61451	60778
	40	61332	60599		40	61372	60659		40	61412	60729		40	61452	60779
	50	61333	60600		50	61373	60660		50	61413	60730		50	61453	60780
	60	61334	60601		60	61374	60661		60	61414	60731		60	61454	60781
	80	61335	60602		80	61375	60662		80	61415	60732		80	61455	60782
	100	61336	60603		100	61376	60663		100	61416	60733		100	61456	60783
	120	61337	60604		120	61377	60664		120	61417	60734		120	61457	60784
	150		60605		150		60665		150		60735		150		60785
	180		60606		180		60666		180		60736		180		60786
220		60607	220		60667	220		60737	220		60787				
43" x 60"	36	61339	60618	44" x 75"	36	61379	60668	50" x 103"	36	61419	60738				
	40	61340	60619		40	61380	60669		40	61420	60739				
	50	61341	60620		50	61381	60670		50	61421	60740				
	60	61342	60621		60	61382	60671		60	61422	60741				
	80	61343	60622		80	61383	60672		80	61423	60742				
	100	61344	60623		100	61384	60673		100	61424	60743				
	120	61345	60624		120	61385	60674		120	61425	60744				
	150		60625		150		60675		150		60745				
	180		60626		180		60676		180		60746				
220		60627	220		60677	220		60747							
43" x 72"	36	61347	60628	44" x 85"	36	60387	60678	51" x 103"	36	61427	60748				
	40	61348	60629		40	61388	60679		40	61428	60749				
	50	61349	60630		50	62389	60680		50		60750				
	60	61350	60631		60	63390	60681		60	61430	60751				
	80	61351	60632		80	64391	60682		80	61431	60752				
	100	61352	60633		100	65392	60683		100	61432	60753				
	120	61353	60634		120	66393	60684		120	61433	60754				
	150		60635		150		60685		150		60755				
	180		60636		180		60686		180		60756				
220		60637	220		60687	220		60757							



Sharpening Stones

Norton has been the world leader in sharpening stones for over 100 years for every professional market. Our retail packaged line rings the same quality to the DIY market. The Knife & Scissor Sharpener is the entry level design that provides a quick and portable tool for 100s of sharpening applications. Abrasive Stones are designed for lower costs, lower usage sharpening applications. Diamond Stones are the latest addition which provides the optimum in performance and life. Each stone is specifically designed for a popular sharpening application and packaged to sell.



PART #	UPC-A	SIZE	GRIT	QTY/ PKG	PKG/ CASE
Diamond Stones - Handy Packs					
Bench Stone					
66253268081	66253268081	7 6" x 2-1/2"	Fine	1	2
66253268082	66253268082	4 6" x 2-1/2"	Coarse	1	2
Mechanical - Handy Packs					
Knife & Scissors Sharpener					
07660787520	07660787520	4 2-1/2" x 6"	Carbide	1	12
<i>Sharpeners come in Red, Yellow, and Green (4 of each)</i>					
Abrasive Sharpening Stones - Handy Packs					
Axe & Hatchet Sharpener					
07660785316	07660785316	5 3" x 5/8" round	Combination	1	10
Pocket Knife Sharpener					
07660787937	07660787937	0 3" x 7/8" x 3/8" w/case	Medium	1	5**
07660787600	07660787600	3 3" x 7/8" x 3/8"	Medium	1	5**
Economy Tool & Knife Sharpener					
07660787933	07660787933	2 6" x 2" x 3/4"	Combination	1	5**
07660787934	07660787934	9 8" x 2" x 3/4"	Combination	1	10
High Quality Tool & Knife Sharpener					
07660787935	07660787935	6 6" x 2" x 3/4"	Combination	1	5**
Chisel & Planer Blade Sharpener					
07660787936	07660787936	3 8" x 2" x 3/4"	Combination	1	10
Household Knife & Tool Sharpener					
07660787939	07660787939	4 7" x 1" x 1/2"	Fine	1	5**
Farm Tool Sharpener					
07660787730	07660787730	7 10" x 1-1/4" x 3/4"	Coarse	1	10
Lawn & Garden Tool Sharpener					
07660787938	07660787938	7 9-1/2" x 1-3/8" x 1/2"	Coarse	1	10
Sharpening Stone Oil					
07660787940	07660787940	0 4-1/2 oz	N/A	1	5**

PART #	UPC-A	SIZE	GRIT	QTY/ PKG	PKG/ CASE
Rubbing Bricks - Bulk					
61463687830	61463687830	0 8" x 2" x 2"	Plain	1	5
61463687840	61463687840	9 6" x 2" x 2"	Fluted	1	5
61463687845	61463687845	4 8" x 2" x 2"	Fluted	1	5
61463687800	61463687800	3 6" x 3" x 1"	Fluted w/ handle	1	5
61463687795	61463687795	2 8" x 3-1/2" x 1-1/2"	Fluted w/ handle	1	5



Racking

Modular designs for mix and match display needs



Short Peg Rack

Part number **07660702270**

- UPC-A number 07660702270 7
- holds 4", 4-1/2", 5" bulk depressed center wheels, cut-off blades or fibre discs
- over tag area for price label
- empty wire displayer
- 6 units/box



Record Slot Wheel Rack

Part number **07660702269**

- UPC-A number 07660702269 1
- holds 12", 14" or 16" bulk cut-off blades, chop saw blades or diamond blades
- can fit 2 SKUs per rack or 1 SKU, doubled up
- display at base due to product weight
- wire displayer (product not included)
- 2 units/box



Single Stack Blade Rack

Part number **07660702273**

- UPC-A number 07660702273 8
- holds 6-1/2", 7", 8", 10" bulk cut-off blades
- holds 7" bulk diamond blades
- holds 5", 7", 9" bulk fibre discs
- display on pegboard or shelf
- front plate for pricing and store info
- empty wire displayer
- 2 units/box



Pocket Wheel Rack

Part number **07660705347**

- UPC-A number 07660705347 3
- holds 12" blades in bottom pocket and 12" or 14" in top pocket
- fits 2 SKUs per rack or 1 SKU, double faced
- design more evenly distributes product weight and provides enhanced visibility of item(s)
- wire displayer (product not included)
- 1 unit/box



Long Peg Rack

Part number **07660702271**

- UPC-A number 07660702271 4
- holds 7" hubbed depressed center wheels
- holds other mid-size diameter discs requiring better dispersement of product weight
- over tag area for price label
- empty wire displayer
- 2 units/box



Basket Bench Wheel Rack

Part number **07660702272**

- UPC-A number 07660702272 1
- holds 6" - 8" bench & pedestal wheel boxes
- can also hold 7" job pack circular saw cut-off blade boxes
- front plate for pricing and store info
- wire displayer (product not included)
- 2 units/box



Flap Disc Rack

Part number **07660704157**

- UPC-A number 07660704157 9
- holds 4" or 4-1/2" flap discs (handy packs or bulk)
- merchandises 3 ways: hangs on pegboard, mounts to an upright beam, or sits on a shelf/counter
- wire rack comes with header (product not included)
- 2/pack



Wire Tray For Bulk Portable Belts

Part number **07660702266**

- UPC-A number 07660702266 0 (2 trays/box)
- modular unit for displaying portable belts on pegboard
- set belt boxes on wire tray to hold belts and identify size and grit
- can also be used for other products as a shelf unit
- multiple racks can be positioned vertically and/or side by side for maximum impact



3-Way 9" x 11" Handy Pack Sheet Rack

Part number **07660702296**

- UPC-A number 07660702296 7
- vertical, space saving 3-pocket rack for 9" x 11" handy packs
- sits on counter/shelf, mounts to an upright beam using washers on back to bolt through or hangs on pegboard
- price tag area per grit
- each pocket fits 15 packs
- 1 unit/box



9" x 11" Handy Pack Spacesaver Merchandiser

Part number **07660748932**

- UPC-A number 07660748932 6
- space saving 3-pocket rack hangs on pegboard to display 9" x 11" Handy Pack sheets
- can be used horizontal (as shown) or vertical
- each pocket fits 15-20 packs
- 1 unit/box



9" x 11" Sheet Merchandiser

Part number **07660701113**

- UPC-A number 07660701113 8
- displays 9" x 11" bulk sheets, job packs, and handy packs
- individual, stackable trays from bottom to top for sturdy, free-standing counter display or pegboard/wall mounting without front to back movement
- durable wire gauge to withstand wear; won't bend or sag
- full width, front plate for quick product identification
- 4 trays/box



Product Identification Strips

Part number **07660703963**

- UPC-A number 07660703963 7
- must order with 9" x 11" Sheet Merchandiser (#01113)
- adhesive backed label for quick attachment
- color coded to match product category, bilingual
- individual grit labels provided to customize at retail
- 1 set/envelope

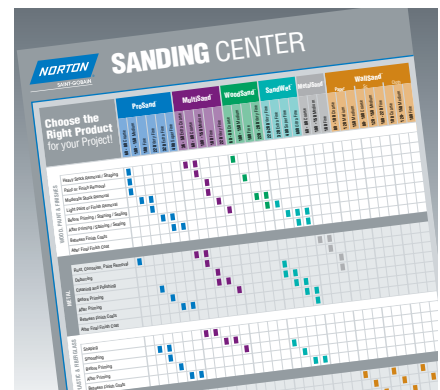

Grit Guide Header

Part number **07660701967**

- UPC-A number 07660701967 7
- use with 9" x 11" Sheet Merchandiser (#01113) or any hand sanding set
- 11"w x 12"h header for selecting the right 9" x 11" sheet by application
- color coded to packaging, bilingual
- 1 unit/box

Signage (24" w x 12" h)

Self-selling signage and cross merchandising solutions



Cutting and Grinding Header:
Part number **07660721890** UPC-A number 07660721890 2 1/1



Power Sanding Header:
Part number **07660721891** UPC-A number 07660721891 9 1/1

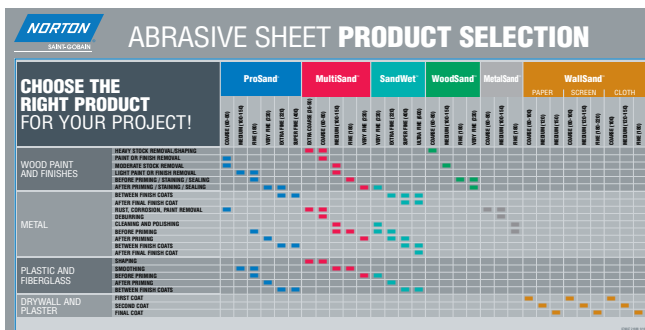

Sheet Guide Header:
Part number **07660721888** UPC-A number 07660721888 9 1/1



ProSand Sponge Header:
Part number **07660710104** UPC-A number 07660710104 4 1/1



ProSand Sheet Header:
Part number **07660710101** UPC-A number 07660710101 3 1/1



Logo Header:
Part number **07660721886** UPC-A number 07660721886 5 1/1



Off Shelf Display

Unique solutions for effectively and prominently showcasing products in high traffic areas.

MultiSand Bonus Pack Display

Part number **07660702670**

- UPC-A number 07660702670 5
- 75 Fine/Medium Sponges of 02081
- Dimensions - (assembled): 42"H x 17"W x 17" (shippable): 21"H x 17"W x 17"
- Weight - 25 lbs.
- Cube - 3.5 cu. ft.

UPC-A	PAGE	UPC-A	PAGE	UPC-A	PAGE	UPC-A	PAGE	UPC-A	PAGE	UPC-A	PAGE
05539510684	26	07660701632	21	07660702050	6	07660702466	17	07660703227	20	07660704173	16
05539510693	26	07660701633	21	07660702051	6	07660702487	16	07660703228	20	07660704657	40
07660700151	9	07660701634	21	07660702052	6	07660702495	22	07660703229	20	07660704658	40
07660700152	9	07660701635	21	07660702057	6	07660702496	22	07660703230	20	07660704659	40
07660700153	9	07660701636	21	07660702061	6	07660702497	22	07660703231	20	07660704660	40
07660700154	9	07660701637	21	07660702062	31	07660702498	22	07660703232	20	07660704680	40
07660700155	9	07660701641	22	07660702064	31	07660702499	22	07660703233	20	07660704681	40
07660700156	9	07660701642	22	07660702065	31	07660702500	22	07660703234	20	07660704682	40
07660700157	9	07660701643	22	07660702066	31	07660702533	15	07660703251	15	07660704683	40
07660700158	9	07660701644	22	07660702067	31	07660702534	15	07660703252	15	07660704684	40
07660700159	9	07660701645	22	07660702068	31	07660702535	15	07660703253	15	07660704685	40
07660700160	9	07660701646	22	07660702069	31	07660702600	12	07660703292	17	07660704729	32
07660700354	6	07660701647	22	07660702081	12	07660702612	5	07660703858	46	07660704735	12
07660700355	6	07660701649	22	07660702082	12	07660702613	5	07660703886	27	07660704738	25
07660700356	6	07660701650	22	07660702206	21	07660702616	5	07660703887	27	07660704746	15
07660700357	6	07660701651	22	07660702207	21	07660702617	5	07660703888	27	07660704747	15
07660700358	6	07660701652	22	07660702208	21	07660702618	5	07660703889	27	07660705249	34
07660700365	6	07660701654	17	07660702209	21	07660702619	5	07660703890	27	07660705251	34
07660700935	12	07660701655	17	07660702225	30	07660702620	5	07660703891	27	07660705278	23
07660700936	12	07660701656	17	07660702226	30	07660702621	5	07660703892	27	07660705279	32
07660700937	12	07660701683	25	07660702227	30	07660702622	5	07660703893	27	07660705281	32
07660700938	12	07660701693	25	07660702228	30	07660702623	9	07660703894	27	07660705282	32
07660700939	12	07660701703	25	07660702229	30	07660702624	9	07660703895	27	07660705285	31
07660700941	16	07660701715	16	07660702230	30	07660702625	9	07660703896	27	07660705287	31
07660700944	16	07660701717	30	07660702231	30	07660702626	9	07660703897	27	07660705289	14
07660700946	13	07660701720	32	07660702233	31	07660702627	9	07660703963	66	07660705291	14
07660700947	13	07660701721	32	07660702234	31	07660702628	9	07660703968	21	07660705292	14
07660700948	13	07660701722	32	07660702235	31	07660702629	9	07660703970	38	07660705300	48
07660700949	13	07660701726	46	07660702236	31	07660702630	9	07660703987	34	07660705301	48
07660700950	13	07660701727	46	07660702237	31	07660702631	9	07660703988	34	07660705311	5
07660700964	31	07660701728	46	07660702238	31	07660702632	5	07660703991	30	07660705312	5
07660700968	31	07660701729	46	07660702239	31	07660702633	5	07660703992	30	07660705313	5
07660700969	31	07660701740	31	07660702240	31	07660702636	5	07660703993	30	07660705314	5
07660701110	13	07660701741	31	07660702241	31	07660702637	5	07660703995	30	07660705320	20
07660701113	66	07660701742	31	07660702242	31	07660702638	5	07660703996	30	07660705322	20
07660701146	28	07660701743	31	07660702243	31	07660702639	5	07660703997	30	07660705324	20
07660701147	28	07660701744	31	07660702244	31	07660702640	5	07660703999	30	07660705326	20
07660701148	28	07660701745	31	07660702245	31	07660702641	5	07660704000	30	07660705344	33
07660701149	28	07660701809	22	07660702246	31	07660702642	5	07660704001	30	07660705347	65
07660701194	33	07660701811	22	07660702253	26	07660702670	12, 67	07660704003	30	07660705364	40
07660701201	33	07660701812	22	07660702255	12	07660702678	36	07660704004	30	07660705386	5
07660701208	15	07660701815	22	07660702256	12	07660702704	28	07660704005	30	07660705411	40
07660701209	15	07660701845	16	07660702257	12	07660702705	28	07660704013	26	07660705412	40
07660701217	26	07660701860	15	07660702263	16	07660702706	28	07660704015	26	07660705413	40
07660701222	16	07660701861	15	07660702266	66	07660702707	28	07660704016	33	07660705414	40
07660701223	8	07660701862	15	07660702269	65	07660702757	34	07660704017	33	07660705421	40
07660701224	8	07660701863	15	07660702270	65	07660702769	6	07660704018	33	07660705422	40
07660701225	8	07660701864	15	07660702271	65	07660702770	6	07660704022	33	07660705441	6
07660701226	8	07660701875	12	07660702272	65	07660702771	6	07660704023	33	07660705442	6
07660701230	33	07660701885	13	07660702273	65	07660702772	6	07660704025	48	07660705444	6
07660701293	9	07660701886	16	07660702275	6	07660702780	33	07660704030	13	07660705445	6
07660701294	9	07660701887	15	07660702284	16	07660702784	33	07660704031	13	07660705446	6
07660701295	9	07660701888	15	07660702285	16	07660702785	33	07660704032	13	07660705447	6
07660701296	9	07660701889	6	07660702286	13	07660702786	33	07660704033	20	07660705452	6
07660701300	16	07660701909	26	07660702296	66	07660702787	33	07660704034	20	07660705453	6
07660701301	16	07660701910	26	07660702299	15	07660702788	33	07660704035	20	07660705454	22
07660701302	15	07660701911	26	07660702314	28	07660702789	33	07660704036	20	07660705455	22
07660701303	15	07660701912	26	07660702315	28	07660702790	33	07660704037	20	07660705456	22
07660701304	15	07660701913	26	07660702316	28	07660702791	33	07660704038	20	07660705466	26
07660701305	15	07660701914	26	07660702317	28	07660702792	33	07660704041	20	07660705472	30
07660701307	10	07660701915	26	07660702318	28	07660702793	33	07660704056	21	07660705473	30
07660701308	10	07660701916	26	07660702320	21	07660703074	13	07660704057	21	07660705474	30
07660701309	10	07660701919	15	07660702343	8	07660703075	13	07660704058	21	07660705475	33
07660701311	16	07660701920	15	07660702344	8	07660703076	13	07660704059	21	07660705484	20
07660701312	16	07660701921	15	07660702345	8	07660703077	13	07660704060	21	07660705486	20
07660701511	9	07660701966	32	07660702388	27	07660703078	13	07660704061	21	07660705487	20
07660701512	9	07660701967	66	07660702389	27	07660703205	24	07660704062	21	07660705488	20
07660701513	9	07660701973	23	07660702390	27	07660703206	24	07660704063	21	07660705489	20
07660701514	9	07660701975	23	07660702391	27	07660703207	24	07660704064	21	07660705490	20
07660701515	9	07660701981	23	07660702395	27	07660703211	24	07660704065	13	07660705493	38
07660701516	9	07660701986	23	07660702396	27	07660703212	24	07660704066	13	07660705494	38
07660701517	9	07660701987	23	07660702397	27	07660703213	24	07660704067	13	07660705495	38
07660701518	9	07660701989	23	07660702398	27	07660703214	24	07660704068	13	07660705496	38
07660701579	7	07660701991	23	07660702399	27	07660703215	24	07660704069	13	07660705504	7
07660701580	7	07660701994	23	07660702400	27	07660703216	24	07660704070	13	07660705505	7
07660701581	7	07660701996	23	07660702401	27	07660703217	20	07660704145	6	07660705506	7
07660701582	7	07660701998	23	07660702411	18	07660703218	20	07660704146	6	07660705507	7
07660701583	7	07660702001	21	07660702412	18	07660703219	20	07660704147	6	07660706038	48
07660701584	7	07660702003	21	07660702450	45	07660703220	20	07660704148	6	07660706048	14
07660701616	34	07660702005	21	07660702451	45	07660703221	20	07660704153	6	07660706049	14
07660701617	34	07660702007	21	07660702452	45	07660703222	20	07660704154	6	07660710101	67
07660701618	34	07660702045	26	07660702453	45	07660703223	20	07660704155	6	07660710466	40
07660701620	34	07660702046	26	07660702463	17	07660703224	20	07660704157	65	07660719359	59
07660701621	34	07660702047	26	07660702464	17	07660703225	20	07660704169	16	07660721525	29
07660701622	34	07660702048	26	07660702465	17	07660703226	20	07660704171	16	07660721527	29

UPC-A	PAGE	UPC-A	PAGE	UPC-A	PAGE	UPC-A	PAGE	UPC-A	PAGE	UPC-A	PAGE
07660721529	29	07660748675	32	07660749507	12	07660768282	49	07660788262	40	63642506128	59
07660721532	29	07660748690	32	07660749600	30	07660768283	15	07660788263	40	63642506129	59
07660721534	29	07660748710	31	07660749602	30	07660768284	15	07660788265	40	63642506130	59
07660721536	29	07660748725	31	07660749604	30	07660768285	15	07660788270	40	63642506131	59
07660721546	29	07660748740	31	07660749610	30	07660768286	15	07660788275	40	63642506132	59
07660721548	29	07660748780	22	07660749611	30	07660768288	12	07660788280	40	63642506133	59
07660721550	29	07660748795	22	07660749612	30	07660768289	12	07660788281	40	63642506134	59
07660721581	31	07660748835	22	07660749613	30	07660768290	12	07660788282	40	63642506135	59
07660721582	31	07660748906	22	07660768100	15	07660768300	17	07660788283	40	63642506136	59
07660721583	31	07660748907	22	07660768101	15	07660768305	44	07660788285	40	63642506137	59
07660721602	28	07660748908	22	07660768102	15	07660768306	44	07660788286	40	63642506138	59
07660721763	16	07660748909	22	07660768103	15	07660768307	44	07660788290	40	63642506139	59
07660721764	16	07660748910	22	07660768104	18	07660768308	44	07660788295	40	63642506140	59
07660721765	16	07660748911	22	07660768105	18	07660768318	16	07660789000	37	63642506141	59
07660721766	16	07660748919	22	07660768106	18	07660768319	16	07660789005	37	63642506142	59
07660721767	16	07660748932	66	07660768107	18	07660768320	16	07660789010	37	63642506143	59
07660721775	12	07660749008	48	07660768108	6	07660768321	16	07660789050	37	63642506144	59
07660721886	67	07660749126	6	07660768109	6	07660768322	16	07660789055	37	63642506145	59
07660721888	67	07660749127	6	07660768110	6	07660768323	36	07660789070	37	63642506146	59
07660721890	67	07660749128	6	07660768111	6	07660768324	36	07660789086	37	63642506149	59
07660721891	67	07660749129	6	07660768119	29	07660768325	36	07660789088	37	63642506198	54
07660724376	39	07660749155	21	07660768120	29	07660768326	36	07660789089	37	63642506199	54
07660724419	39	07660749156	21	07660768121	29	07660768327	36	07660789096	37	63642506200	57
07660724549	39	07660749157	21	07660768122	29	07660768328	11	07660789097	37	63642506203	57
07660724564	39	07660749158	21	07660768123	29	076607682064	11	07660789098	37	63642506204	57
07660743135	22	07660749159	21	07660768124	29	076607682065	11	07660789275	35	63642506205	57
07660743140	6	07660749165	21	07660768125	29	076607682066	11	07660789384	37	63642506375	57
07660747710	6	07660749166	21	07660768126	29	076607682067	11	07660789387	37	63642506376	57
07660747720	6	07660749209	21	07660768127	29	076607682068	11	07660789390	39	63642506377	57
07660747725	6	07660749210	21	07660768128	29	076607682069	11	07660789391	39	63642535316	47
07660747735	6	07660749211	21	07660768129	29	076607682070	11	07660789392	39	63642536313	13
07660747740	6	07660749212	21	07660768139	11	076607682071	11	07660789395	39	63642536314	13
07660747750	6	07660749213	21	07660768140	11	076607682072	11	07660789399	38	63642542089	60
07660747765	6	07660749214	21	07660768141	11	076607682073	11	07660789400	38	63642542772	55
07660747767	37	07660749215	21	07660768142	44	076607682074	11	07660789401	39	63642543112	59
07660747769	37	07660749216	21	07660768143	44	076607682075	11	07660789405	38	63642543421	25
07660747805	7	07660749217	21	07660768156	5	076607682076	11	07660789430	36	63642543422	25
07660747820	7	07660749218	21	07660768157	5	076607682077	11	07660789431	36	63642543423	25
07660747835	7	07660749219	21	07660768158	5	076607682078	11	07660789432	36	63642543424	25
07660747855	7	07660749220	21	07660768159	5	076607682079	11	07660789451	37	63642543425	25
07660747965	7	07660749221	21	07660768160	5	076607682080	11	07660789453	37	63642543426	25
07660747980	7	07660749222	21	07660768161	5	076607682081	11	07660789455	37	63642543704	59
07660747990	7	07660749223	21	07660768162	5	076607682082	11	08834190172	24	63642543712	59
07660748010	7	07660749224	21	07660768163	5	076607682083	11	08834190767	24	63642543714	59
07660748025	7	07660749225	21	07660768164	5	076607682084	11	08834190933	24	63642552868	13
07660748052	8	07660749231	22	07660768165	5	076607682085	11	08834193649	24	63642552869	13
07660748053	8	07660749232	22	07660768166	5	076607682086	11	08834193650	24	63642552870	13
07660748054	8	07660749236	22	07660768167	5	076607682088	11	08834193651	24	63642555784	47
07660748055	8	07660749237	22	07660768168	5	076607682088	11	08834193652	24	63642557599	47
07660748058	8	07660749238	22	07660768171	5	076607682780	60	08834193725	24	63642557600	47
07660748060	8	07660749239	22	07660768172	5	076607684002	6	08834194360	24	63642557602	47
07660748080	8	07660749240	22	07660768173	5	076607684024	6	08834194362	24	63642557604	47
07660748090	8	07660749242	22	07660768174	5	076607684025	6	08834194514	24	63642557606	47
07660748110	8	07660749244	22	07660768175	5	076607684042	6	61463687795	64	63642557608	47
07660748130	6	07660749246	22	07660768177	5	076607684250	6	61463687800	64	63642557611	47
07660748132	6	07660749247	6	07660768182	5	076607684251	6	61463687830	64	63642557612	47
07660748143	14	07660749248	6	07660768187	5	076607684252	6	61463687840	64	63642557613	47
07660748144	14	07660749249	6	07660768183	5	076607685316	64	61463687845	64	63642557616	47
07660748145	14	07660749250	6	07660768184	5	076607687520	64	61463687845	64	63642557617	47
07660748146	46	07660749251	6	07660768185	5	076607687600	64	63642502122	25	63642558864	59
07660748147	46	07660749252	6	07660768186	26	076607687730	64	076607687600	64	66243411393	37
07660748148	46	07660749253	6	07660768187	26	076607687933	64	076607687933	64	66243411395	37
07660748295	6	07660749254	6	07660768188	26	076607687936	64	076607687936	64	66243411402	37
07660748300	6	07660749256	30	07660768189	26	076607687934	64	076607687934	64	66243510512	36
07660748301	6	07660749258	30	07660768190	26	076607687935	64	076607687935	64	66243510627	37
07660748302	6	07660749259	30	07660768221	11	076607687936	64	076607687936	64	66243510628	37
07660748310	6	07660749262	30	07660768230	30	076607687937	64	076607687937	64	66243510629	37
07660748325	6	07660749264	30	07660768231	30	076607687938	64	076607687938	64	66243510630	37
07660748335	6	07660749265	30	07660768232	30	076607687939	64	076607687939	64	66243510645	37
07660748353	6	07660749266	30	07660768233	30	076607687940	64	076607687940	64	66243510647	37
07660748354	6	07660749268	30	07660768234	30	076607688201	60	076607687940	64	66243510650	37
07660748355	6	07660749270	30	07660768235	30	076607688202	40	076607688201	60	66243510651	37
07660748430	31	07660749271	30	07660768236	30	076607688204	40	076607688202	40	66243510653	37
07660748450	31	07660749272	30	07660768237	17	076607688210	40	076607688204	40	66243510654	37
07660748465	31	07660749273	30	07660768238	17	076607688215	40	076607688210	40	66243510655	37
07660748490	31	07660749274	30	07660768239	6	076607688216	40	076607688215	40	66243510656	37
07660748495	31	07660749277	30	07660768240	18	076607688220	40	076607688216	40	66243510657	37
07660748505	31	07660749278	30	07660768241	6	076607688225	40	076607688220	40	66243510658	37
07660748520	31	07660749282	28	07660768242	15	076607688230	40	076607688225	40	66243527955	34
07660748521	31	07660749283	28	07660768243	15	076607688235	40	076607688230	40	66243527956	34
07660748600	31	07660749284	28	07660768245	15	076607688240	40	076607688235	40	66252801864	36
07660748620	31	07660749288	28	07660768246	11	076607688245	40	076607688240	40	66252801865	36
07660748630	31	07660749302	12	07660768276	6	076607688246	40	076607688245	40	66252809376	35
07660748631	31	07660749503	12	07660768277	11	076607688247	40	076607688246	40	66252809376	35
07660748660	32	07660749504	12	07660768278	20	076607688248	40	076607688247	40	66252823599	37

UPC-A	PAGE	UPC-A	PAGE	UPC-A	PAGE	UPC-A	PAGE	UPC-A	PAGE	UPC-A	PAGE
66252830587	34	66252843331	35	66254487396	10	66261123576	56	66261130239	58	66261131524	57
66252830886	38	66252843332	35	66254487397	10	66261123577	56	66261130240	58	66261131526	57
66252833483	42	66252843334	35	66254487398	10	66261123578	56	66261130241	58	66261131527	57
66252833487	42	66252843590	36	66254487399	10	66261123580	56	66261130242	58	66261131528	57
66252833488	42	66252843591	36	66254487400	10	66261123582	56	66261130243	58	66261131532	57
66252833489	42	66252843593	36	66254487415	54	66261123584	56	66261130244	58	66261131533	57
66252833490	42	66252843594	36	66254487417	54	66261123588	57	66261130245	58	66261131534	57
66252833491	42	66252843596	36	66254487418	54	66261123589	57	66261130250	58	66261131535	57
66252833492	41	66252843598	36	66254487440	54	66261123590	57	66261130251	58	66261131536	57
66252833493	41	66252843599	36	66254487441	54	66261123591	57	66261130253	58	66261131537	57
66252833494	41	66252843600	36	66254487442	54	66261123592	57	66261130255	58	66261131538	57
66252833496	41	66252843601	36	66254487443	54	66261123593	57	66261130258	55	66261131539	57
66252833497	41	66252843602	36	66254487444	54	66261123596	58	66261130259	55	66261131541	57
66252833947	41	66252843604	34	66254487446	54	66261123598	58	66261130260	55	66261131542	57
66252833948	43	66252843605	36	66254487447	54	66261124977	53	66261130261	55	66261131543	57
66252833949	43	66252843607	36	66254487448	54	66261125244	56	66261130262	55	66261131544	57
66252833950	43	66252843609	36	66254487449	54	66261125307	56	66261130263	55	66261131545	57
66252833951	43	66252843611	36	66254487450	54	66261125436	56	66261130264	55	66261131546	57
66252833952	43	66252843613	36	66260148820	46	66261125444	57	66261130265	55	66261131547	57
66252833953	43	66252843614	36	66261008108	46	66261125573	53	66261130266	55	66261131548	57
66252833954	43	66252843615	36	66261045600	46	66261125615	23	66261130268	55	66261131549	57
66252837187	40	66252843616	36	66261047583	46	66261125616	23	66261130271	55	66261131550	57
66252837190	40	66252843624	37	66261052254	57	66261125684	57	66261130272	55	66261131551	57
66252837191	40	66252912626	34, 36	66261052255	57	66261126266	14	66261130273	55	66261131552	57
66252837192	40	66252917880	35	66261052267	57	66261126267	14	66261130274	55	66261131553	57
66252837193	40	66252917881	35	66261052268	57	66261126268	14	66261130275	55	66261131554	57
66252837194	40	66252938854	35	66261052270	57	66261126269	14	66261130276	55	66261131555	57
66252841939	34	66252938855	35	66261065293	54	66261126270	14	66261130331	10	66261131556	57
66252842001	35	66252939184	35	66261074000	46	66261126271	14	66261130332	10	66261131558	57
66252842002	35	66252939207	36	66261074700	46	66261126272	14	66261130333	10	66261131559	57
66252842003	35	66252939259	36	66261074800	46	66261126273	14	66261130334	10	66261131560	57
66252842004	35	66252940098	36	66261079600	46	66261126274	14	66261131449	56	66261131561	57
66252842005	35	66252940148	36	66261085302	59	66261126275	14	66261131450	56	66261131562	57
66252842010	36	66252942300	40	66261100245	10	66261126276	14	66261131451	54	66261131563	57
66252842011	36	66252942301	40	66261100285	10	66261126278	14	66261131452	54	66261131564	57
66252842013	36	66252942302	40	66261100290	10	66261126279	14	66261131453	54	66261131565	57
66252842014	36	66253021633	35	66261100295	10	66261126280	14	66261131454	54	66261131566	57
66252842015	34	66253021634	35	66261100315	10	66261126281	14	66261131456	54	66261131571	58
66252842016	36	66253044087	40	66261100320	10	66261126282	14	66261131457	54	66261131573	58
66252842017	36	66253044534	40	66261100325	10	66261126283	14	66261131458	54	66261131575	58
66252842018	36	66253044535	40	66261100330	10	66261126284	14	66261131459	54	66261131577	58
66252842019	36	66253048896	35	66261100335	10	66261126285	14	66261131460	54	66261131578	58
66252842025	34	66253048897	35	66261100915	16	66261126286	14	66261131461	54	66261131579	58
66252842026	34	66253048983	36	66261100920	16	66261126287	14	66261131462	54	66261131580	58
66252842036	34	66253048991	36	66261100935	16	66261126288	14	66261131463	54	66261131581	58
66252842177	35	66253048994	36	66261100940	16	66261126289	14	66261131464	54	66261131582	58
66252842178	35	66253049066	36	66261100945	16	66261126290	14	66261131465	56	66261131583	58
66252842179	36	66253049104	35	66261100950	16	66261126291	14	66261131466	56	66261131584	58
66252842180	34	66253144536	40	66261100955	16	66261126292	14	66261131467	56	66261131585	58
66252842202	34	66253160366	40	66261100960	16	66261126293	14	66261131468	54	66261131586	58
66252843171	37	66253207554	38	66261101150	10	66261126294	14	66261131469	54	66261131587	58
66252843172	37	66253263054	40	66261101155	10	66261126295	14	66261131470	54	66261131588	58
66252843173	37	66253263055	40	66261101160	10	66261126296	14	66261131471	54	66261131590	58
66252843174	37	66253263056	40	66261101165	10	66261126297	14	66261131473	54	66261131592	58
66252843175	37	66253263359	40	66261101170	10	66261126298	14	66261131474	54	66261131593	58
66252843176	36	66253263360	40	66261101175	10	66261126299	14	66261131475	54	66261131595	58
66252843177	36	66253268081	64	66261101255	10	66261126300	10	66261131476	54	66261131596	58
66252843178	36	66253268082	64	66261101380	10	66261126331	10	66261131477	54	66261131597	58
66252843179	36	66253306627	38	66261101385	10	66261126332	10	66261131478	54	66261131598	58
66252843208	34	66253410183	39	66261101390	10	66261126333	10	66261131479	54	66261131599	58
66252843209	34	66253410198	38	66261101488	10	66261126334	10	66261131480	54	66261131600	58
66252843210	34	66254401221	54	66261101489	10	66261126335	10	66261131481	54	66261131609	54
66252843211	36	66254419963	24	66261101490	10	66261126336	10	66261131487	55	66261131612	54
66252843212	36	66254419978	24	66261101495	10	66261126337	10	66261131488	55	66261131613	54
66252843213	36	66254419984	24	66261101500	10	66261126338	10	66261131490	55	66261131614	54
66252843214	36	66254419987	24	66261101505	10	66261126339	10	66261131492	55	66261131615	54
66252843215	36	66254419994	24	66261101525	10	66261126340	10	66261131493	55	66261131617	54
66252843216	36	66254419996	24	66261101530	10	66261127278	14	66261131494	55	66261131618	10
66252843217	36	66254419997	24	66261101535	10	66261127279	14	66261131495	55	66261131619	10
66252843218	36	66254420004	24	66261101555	10	66261127280	14	66261131496	55	66261131620	10
66252843233	36	66254420006	24	66261101560	10	66261127281	14	66261131497	55	66261131621	10
66252843234	36	66254420007	24	66261101570	10	66261127282	14	66261131498	55	66261131622	10
66252843235	36	66254420008	24	66261101861	10	66261127283	14	66261131503	55	66261131624	10
66252843236	36	66254420010	24	66261101862	10	66261127284	14	66261131505	55	66261131626	10
66252843244	36	66254420012	24	66261104714	15	66261127285	14	66261131507	55	66261131627	10
66252843245	36	66254420013	24	66261104716	15	66261130226	58	66261131508	55	66261131628	10
66252843246	36	66254421217	54	66261104717	15	66261130227	58	66261131509	55	66261131629	10
66252843247	36	66254421221	57	66261104718	15	66261130230	58	66261131510	55	66261131630	10
66252843254	38	66254480230	54	66261104719	15	66261130231	58	66261131511	55	66261131631	10
66252843321	35	66254480231	54	66261107265	14	66261130232	58	66261131512	55	66261131632	10
66252843322	35	66254480232	57	66261107270	14	66261130233	58	66261131513	55	66261131633	10
66252843323	35	66254480233	57	66261107275	14	66261130234	58	66261131514	55	66261131634	10
66252843324	35	66254487393	10	66261123573	56	66261130235	58	66261131515	55	66261131661	57
66252843326	35	66254487394	10	66261123574	56	66261130236	58	66261131519	57	66261131662	57
66252843328	35	66254487395	10	66261123575	56	66261130238	58	66261131521	57	66261131	

UPC-A	PAGE	UPC-A	PAGE	UPC-A	PAGE	UPC-A	PAGE	UPC-A	PAGE	UPC-A	PAGE
66261131683	6	66261138592	25	66261149842	54	66623357281	26	66623390706	49	70184684546	33
66261131685	6	66261138593	25	66261149847	54	66623357282	26	66623390707	49	77696007745	50
66261131686	6	66261138594	25	66261149864	57	66623357283	26	66623390708	49	77696007753	50
66261131687	6	66261138600	25	66261149865	57	66623357284	26	66623390709	49	77696007755	50
66261131688	6	66261138601	25	66261149866	57	66623357285	26	66623390710	49	77696007756	50
66261131689	6	66261139360	10	66261149867	57	66623357286	26	66623390711	49	77696007757	50
66261131690	6	66261139361	10	66261149870	53	66623357287	26	66623390712	49	77696007760	50
66261131692	14	66261139362	10	66261149871	53	66623357288	26	66623390713	49	77696007762	50
66261131693	14	66261139363	10	66261149872	53	66623357289	26	66623390714	49	77696007763	50
66261131694	14	66261139364	10	66261149873	53	66623362921	54	66623390715	49	77696007765	50
66261131695	14	66261139365	10	66261149874	53	66623362922	54	69936602003	41	77696007768	50
66261131696	14	66261139366	10	66261149876	53	66623362923	54	69936605965	41	77696007770	50
66261131697	14	66261139367	10	66261149879	53	66623362924	54	69936606145	43	77696007773	50
66261134425	17	66261139377	10	66261149899	57	66623362925	54	69936606275	42	77696007774	50
66261135900	57	66261139378	10	66261149900	57	66623362926	54	69936606277	42	77696007775	50
66261136350	23	66261139379	10	66261149902	57	66623362927	54	69936606278	42	77696007776	50
66261136351	23	66261139380	10	66261149903	57	66623362928	54	69936606279	43	77696007777	50
66261136352	23	66261139381	10	66261149904	57	66623362929	54	69936653306	42	77696007778	50
66261136354	23	66261140385	57	66261149905	57	66623362930	54	69936653309	43	77696007781	50
66261136355	23	66261140498	54	66261149906	57	66623362931	54	69936653310	43	77696007784	50
66261136368	54	66261140499	54	66261149907	57	66623362932	54	69936653316	43	77696007785	50
66261136369	54	66261140500	54	66261149908	57	66623362933	54	69936653317	43	77696007786	50
66261136370	54	66261140501	54	66261149909	57	66623362934	54	69936653324	42	77696007787	50
66261136372	54	66261140502	54	66261149910	57	66623362935	54	69936653326	42	77696007788	50
66261136373	54	66261140508	54	66261149911	57	66623362936	54	69936653327	42	77696007791	50
66261136375	54	66261140509	54	66261149912	57	66623362937	54	69936653329	42	77696007793	50
66261136376	54	66261140510	54	66261149913	57	66623362938	54	69936653331	42	77696007795	50
66261136576	23	66261140511	54	66261149914	57	66623362939	54	69936653333	42	78072720875	32
66261136581	23	66261140512	54	66261149915	57	66623362940	54	69936653336	41	78072720885	32
66261136582	23	66261140515	58	66261149916	57	66623362941	57	69936653340	41	78072720890	32
66261136583	23	66261140517	58	66261155373	54	66623362942	57	69936653341	41	78072720895	32
66261136584	23	66261140518	57	66261155374	54	66623362943	57	69936653345	41	78072720900	32
66261136585	23	66261140519	57	66261155375	54	66623362944	57	69936653346	41	78072720905	32
66261136586	23	66261140520	57	66261155376	54	66623362945	57	69936653347	41	78072720910	32
66261136587	23	66261140521	57	66261155377	54	66623362946	57	69936653348	41	78072727932	31
66261136588	23	66261140522	57	66261155378	54	66623362947	57	69936653349	41	78072727933	31
66261136589	23	66261140527	58	66261155379	54	66623362948	57	69936653350	42	78072727934	31
66261136592	23	66261140528	57	66261155380	54	66623362949	57	69936653351	42	78072727935	31
66261136593	23	66261140529	57	66261156659	17	66623362950	57	69936653352	42	78072727936	31
66261136594	23	66261140530	57	66261158171	17	66623362951	57	69957348198	56	78072727937	31
66261136595	23	66261140531	57	66623305608	54	66623362952	57	69957348200	56	78072727942	31
66261136596	23	66261140532	57	66623311870	10	66623362953	57	69957348201	56	78072727943	31
66261136600	23	66261142474	54	66623311871	10	66623362954	57	69957348202	56	78072727944	31
66261136601	23	66261144926	57	66623311873	10	66623362955	57	69957348203	56	78072727945	31
66261136602	23	66261147434	57	66623311874	10	66623362956	57	69957348204	56	78072727946	31
66261136604	23	66261148340	54	66623311875	10	66623362957	57	69957348206	56	78072727947	31
66261136606	23	66261149537	57	66623311876	10	66623362958	57	69957348223	56	78072727957	32
66261136607	23	66261149538	57	66623311877	10	66623362959	57	69957352447	54	78072727958	32
66261136613	23	66261149540	57	66623311878	10	66623362960	57	70184623029	38	78072727959	32
66261136614	23	66261149541	57	66623311879	10	66623365598	25	70184645926	33	78072727960	32
66261136615	23	66261149542	57	66623353306	26	66623365600	25	70184645927	33	78072727961	32
66261136620	23	66261149543	57	66623353309	26	66623365788	57	70184681309	33	78072727962	32
66261136625	23	66261149546	57	66623353310	26	66623365789	57	70184681383	33	78072727963	32
66261136630	23	66261149553	58	66623353311	26	66623366015	25	70184681779	33	78072727981	32
66261136635	23	66261149821	54	66623353312	26	66623366071	58	70184682555	33	78072727982	32
66261136995	57	66261149822	54	66623353313	26	66623366073	58	70184682586	33	78072727983	32
66261136996	57	66261149823	54	66623353314	26	66623366074	58	70184682593	33	78072727984	32
66261137307	53	66261149824	54	66623355578	25	66623366075	58	70184682595	33	78072727985	32
66261137308	53	66261149825	54	66623355594	25	66623366077	58	70184683611	33	78072727986	32
66261137309	53	66261149826	54	66623355595	25	66623367394	58	70184683612	33	78072727987	32
66261137310	53	66261149827	54	66623355596	25	66623367397	58	70184684020	33	78072727992	31
66261137322	53	66261149828	54	66623355597	25	66623367398	58	70184684087	33	78072727993	31
66261137323	53	66261149829	54	66623355598	25	66623367399	58	70184684088	33	78072727994	31
66261137333	53	66261149830	54	66623355599	25	66623367400	58	70184684089	33	78072780438	31
66261138452	25	66261149831	54	66623356001	25	66623367401	58	70184684098	33	78072780440	31
66261138453	25	66261149833	54	66623356002	25	66623369778	58	70184684099	33	78072780441	31
66261138454	25	66261149834	54	66623356003	25	66623374368	20	70184684100	33	78072780447	31
66261138456	25	66261149835	54	66623356004	25	66623376000	59	70184684105	33	78072780448	31
66261138457	25	66261149836	54	66623356005	25	66623390700	49	70184684106	33	78072780449	31
66261138561	25	66261149837	54	66623357276	26	66623390701	49	70184684107	33	78072780450	31
66261138562	25	66261149838	54	66623357277	26	66623390702	49	70184684361	33	78072780451	31
66261138563	25	66261149839	54	66623357278	26	66623390703	49	70184684463	33	78072781847	31
66261138590	25	66261149840	54	66623357279	26	66623390704	49	70184684464	33		
66261138591	25	66261149841	54	66623357280	26	66623390705	49	70184684545	33		

NORTON DO-IT-YOURSELF AND CONTRACTOR MARKET



Flexibility and Conformability in the Palm of Your Hand.

Norton ProSand has every angle covered with various shapes, sizes and grit combinations of sanding sponges. Last longer than sandpaper.



Bulk Up Fast with Norton WallSand.

Packaged in bulk, Norton WallSand bulk drywall sheets meet the unique needs of drywall contractors and deliver flawless walls and ceilings with fewer trips to the store to stock up.



It's Time to Clean the Air.

Norton ProSand Multi-Air Cyclonic Discs feature a multi-hole design pattern that maximizes dust extraction for all 5" & 6" random orbital sanders. For all surfaces and coatings.



Fast and Tough for the Most Demanding Jobs.

Norton Diamond Blades are the choice of professionals vs. abrasive blades with faster cut rate, constant depth of cut and less downtime.



Norton Has You Covered.

Norton Painter's Plastic protects virtually any area from sanding dust and paint overspray with ease - even after repositioning. Mono films and linear low density plastics (LLDPE) don't compare.



Time is Money. Spend it Wisely.

Designed with the professional woodworker in mind, Norton Red Heat belts feature a self-sharpening ceramic alumina grain which allows them to sand all species of wood from the softest pines to extremely hard woods.





CATALOG #460

STANDARD PRODUCTS CATALOG FOR THE
**PROFESSIONAL
CLEANING MARKET**



QUALITY WITHOUT COMPROMISE™



Our Mission

We offer powerful, precise, user-friendly solutions in floor maintenance, natural stone care, wood floor sanding and culinary sharpening/food service products. By working closely with end-users and distributing partners, we design and provide customized solutions to secure the best option for performance, cost and safety.

Our Expertise

Norton is the leading brand of Saint-Gobain Abrasives, with more than 135 years of experience in manufacturing abrasives.

We are committed to providing access to our expert's knowledge whenever you need it. Whether it is through our [Process Solutions Program \(PSP\)](#), ongoing training programs, or through on-line expert articles and white papers you can stay up-to-date with Norton where and when you need it.

Bring us your grinding challenges, we have solutions!

Our Commitment

You be the final judge in performance! We are so confident of the superior performance of our abrasive products, as recommended for specific applications, that we invite in-plant tests against any other brand of abrasive product on the market.

✓ NO-RISK TEST

General Information

Norton Floor Pad Application Recommendation Chart **4**
 Floor Pad Performance **4**
 Floor Maintenance Pads **4**
 Pad / Machine / Finish Recommendations **5**
 Pro Cleaning Products Sales Support **5**
 Competitive Cross References **6**
 Part-to-Page Reference **25**

General-Purpose Pads

Stripping **7**
 Scrubbing and Cleaning **8**
 Buffing and Polishing **9**

Ultra High-Speed Burnishing Pads

Burnishing **10**

Specialty Pads

Maroon Enviro Stripping **12**

Non-Woven Products

Hand and Utility Pads **13**
 Hand Pad Recommendations **13**
 Utility Pad Recommendations **13**

Applicators and Micro-Fiber

Floor Finish Applicators **14**
 Micro-Fiber Cloths **14**

Specialty Wood Floor Pads

Conditioning **15**
 Wood Floor **16**
 Screens **17**

Concrete and Stone Care

Diamond Pad Performance Data **18**
 Diamond Floor Pads **18**
 Grinding, Polishing, and Protecting **19**

Culinary Sharpening and Food Service Products

Professional Sharpening Systems **20**
 Professional Sharpening Stones **21**
 Sharpening Accessories **22**
 Cleaning, Scrubbing, and Polishing **23**
 Steel Wool **24**

HOW DO NORTON
 FLOOR PADS STACK UP
 AGAINST THE COMPETITION?
BETTER.

Thicker pad with open web structure for longer life and less loading. Manufacturing process efficiencies for increased tensile strength and uniform grain distribution. Breadth of line for broadest application coverage.

Contact us to see how Norton pads stack up for you.



NORTON FLOOR MAINTENANCE PADS FOR THE PROFESSIONAL CLEANING MARKET

Norton Floor Pad Application Recommendation Chart

RPM	MACHINE	CHEMICAL/WET OR DRY	PAD RECOMMENDATION	RESULTS
Stripping				
175+	Electric & Auto Scrub	Strip Solution/Wet	Ultra Blue Stripper High Productivity Black Strip Black Super Strip	Strips even the most severe floors quickly and effectively. Removes tough finishes and extreme wax build up. Provides uniform finish removal in wet stripping applications.
Scrubbing				
175+	Electric & Auto Scrub	Cleaner/Wet	Green Super Scrub Blue Super Clean	Removes the toughest scuff marks in heavily soiled areas. Scrubs dirt and grime in heavy spray cleaning applications.
Spray Buffing				
175+	Electric	Spray Buff Solution/Wet	Red Buffer	Produces a high gloss finish when dry or spray buffing.
350-1200	Electric	Spray Buff Solution	Grizzly Bear Lite Grizzly Bear	Creates a high luster finish on soft and flexible surfaces. Removes heavy marks and produces a high luster shine on hard finishes.
1200+	Electric	Spray Buff Solution/ Mop On Restorer	Ultra Grizzly Bear	Quickly removes scratches and marks to leave a glistening finish.
Buffing & Polishing				
175+	Electric	Dry or Restoration Process	White Super Gloss	Produces a mirror gloss shine during low speed polishing.
350-1200	Propane	Dry or Restoration Process	Champagne Polish & Burnish Grizzly Bear Lite Aqua Ultra High Speed Burnish	Creates the highest gloss of any pad on the market. Restores a high luster shine quickly and easily. Produces a "wet-look" shine on soft to medium hard finishes.
Burnishing				
1500-3000	Propane	Dry or Restoration Process	Pink "Topshine" Burnish Ultra Grizzly Bear Grizzly Bear Grizzly Bear Lite Aqua Ultra High Speed Burnish	Revives the gloss to dull floors on hard finishes only. Removes marks and scratches on medium to hard finishes. Removes heavy marks and produces a high luster shine on hard finishes. Produces a high luster shine on soft to medium finishes. Produces the "wet-look" shine on soft, medium and metal-free finishes.
1000-2000	Electric & Battery	Dry or Restoration Process	Thermal Burnish	Produce an outstanding shine on soft to medium finishes.
1000-3000	Electric & Battery	Dry or Restoration Process	Pink "Topshine" Burnish Ultra Grizzly Bear Grizzly Bear Grizzly Bear Lite Aqua Ultra High Speed Burnish	Revives the gloss to dull floors on hard finishes only. Removes marks and scratches on medium to hard finishes. Removes heavy marks and produces a high luster shine on hard finishes. Produces a high luster shine on soft to medium finishes. Produces "wet-look" shine on soft to medium and metal-free finishes.
1500-2000	Electric & Battery	Dry or Restoration Process	Champagne Polish & Burnish	Creates the highest gloss of any pad on the market.

Floor Pad Performance

General Purpose Thick Line Pads



Ultra High Speed Finishing Pads



Pad / Machine / Finish Recommendations

FINISH	PROPANE BURNISHER 2000-3000 RPM			PROPANE STRIPPING 175-350 RPM			BATTERY BURNISHER 1500-2500 RPM			ELECTRIC 1500+ RPM			ELECTRIC BURNISHER 1000 RPM			ELECTRIC SWING 175-350 RPM			AUTOSCRUB 500 RPM			
	SOFT	MED	HARD	SOFT	MED	HARD	SOFT	MED	HARD	SOFT	MED	HARD	SOFT	MED	HARD	SOFT	MED	HARD	SOFT	MED	HARD	
General Purpose Pads																						
Ultra Blue Stripper				X	X	X											X	X	X	X	X	X
High Pro Black Strip				X	X	X											X	X	X	X	X	X
Black Super Strip				X	X	X											X	X	X	X	X	X
Green Super Scrub																	X	X	X	X	X	X
Blue Super Clean																	X	X	X	X	X	X
Red Buffer																	X	X	X	X	X	X
White Super Gloss	X	X	X					X	X	X	X	X	X	X	X	X	X	X	X	X	X	X

Ultra High Speed Burnishing Pads

Pink Topshine			X					X			X											
Ultra Grizzly Bear		X	X					X	X		X	X		X	X							
Grizzly Bear		X	X					X	X		X	X		X	X							
Grizzly Bear Lite	X	X						X	X		X	X		X	X							
Thermal Burnish								X	X		X	X		X	X							
Aqua UHS	X	X						X	X		X	X		X	X							
Champagne Burnish											X			X								

Pro Cleaning Products Sales Support



Norton Floor Pad Rainbow Kits

20" Low Speed Rainbow Pack

Includes: Ultra Blue Stripper, High Pro Black Strip, Black Super Strip, Green Super Scrub, Blue Super Clean, Red Buffer, White Super Gloss

#66261051638

20" High Speed Rainbow Pack

Includes: Champagne Polish & Burnish, Lite Blue Burnish, Mint Soft Burnish, Aqua UHS, Thermal Burnish, Grizzly Bear Lite, Ultra Grizzly Bear, and Pink "Topshine" Burnish

#66261051636

27" High Speed Rainbow Pack

Includes: Champagne Polish & Burnish, Lite Blue Burnish, Mint Soft Burnish, Aqua UHS, Grizzly Bear Lite, Ultra Grizzly Bear and Pink "Topshine" Burnish

#66261019932



Bear-Tex Utility Pads Rainbow Pack

5 Pads

#66261014575

Competitive Cross References

NORTON	3M	ETC.	AMERICO	ACS/SCRUBBLE
--------	----	------	---------	--------------

General-Purpose Pads

Ultra Blue Stripper	7300 High Productivity	Diamondback Extreme	Dominator	N/A
High Productivity Black Strip	7200 Black Stripper	Razorback	HP500 Heavy Duty Stripping	Type 73 Emerald Hy-Pro
Black Super Strip	7100 Brown Stripper	Black Strip/Boss Hawg	Black Stripping	Type 72 Black Strip
Green Super Scrub	5000 Topline Pre-Burnish	Green Scrub	Green Scrub	Type 55 Green Scrubber
Blue Super Clean	5300 Blue Cleaner	Blue Cleaner	Blue Cleaner	Type 53 Blue Cleaner
Red Buffer	5100 Red Buffer	Red Buff	Red Spray Buff	Type 51 Red Buffer
White Super Polish	4100 White Super Polish	White Polish	White Polish	Type 41 White Polishing

Burnishing Pads

Pink Topshine Burnish	3600 Eraser	N/A	Remover Burnishing	Type 36 Pink Burnishing
Ultra Grizzly Bear	3500 Natural Blend Tan	Gorilla	Porko Plus	Type 37 Hair Blend Ex Heavy
Grizzly Bear	3500 Natural Blend Tan	Gorilla	Porko Plus	Type 37 Hair Blend Ex Heavy
Grizzly Bear Lite	3300 Natural Blend White	Gorilla Lite	Combo	Type 33 Hair Blend Light
Thermal Burnish	3400 Tan Burnish	Super Speed Rubberized	Image Beige Burnishing	Type 42 Beige Poly Thermal
Aqua Ultra High Speed Burnish	3100 Aqua Burnish	Aqua Plus	N/A	Type 31 Aqua Burnishing
Champagne Polish & Burnish	4200 Beige Buffer	The Cure	Champagne Burnishing	N/A

NORTON	TWISTER	ACS/CYCLONE D	3M TRIZACT	DIAMOND PRODUCTS CANADA
--------	---------	---------------	------------	-------------------------

Diamond Maintenance Pads

(1) 400 Grit/ Coarse	Red Pad	400 Grit	N/A	N/A
(2) 800 Grit /Medium	White Pad	800 Grit	Sienna	N/A
(3) 1500 Grit/ Fine	Yellow Pad	1500 Grit	N/A	Poly Pad (Lite Blue)
(4) 3000 Grit /Very Fine	Green Pad	3000 Grit	Purple	Poly Pad Plus (Lite Blue)
8000 Grit Polish	N/A	N/A	N/A	N/A

STRIPPING PADS

No matter how severe the floor is you are stripping, Norton has a pad that will work for you. Each stripping pad is durable, long lasting, and designed with open construction to allow finish and stripping solutions to flow through and to resist clogging.



Ultra Blue Stripper

For use on the most severe floors. This pad has extra heavy-duty fibers, more abrasive grain and an open weave designed to strip floors quickly and effectively, reducing labor costs.



High Productivity Black Strip

For floors with extreme wax buildup, this pad will cut away old finish quickly with its tough, porous construction.



Black Super Strip

A thick pad for wet stripping applications that is aggressive, durable and consistent.

PART #	SIZE	PADS/ CASE
Round Pads		
66261014185	11"	5
66261014186 <i>NS</i>	12"	5
66261014187	13"	5
66261014188	14"	5
66261014189	15"	5
66261014190	16"	5
66261014191	17"	5
66261014192	18"	5
66261014193	19"	5
66261014194	20"	5
Rectangular Pads		
66261059425	14" x 20"	5
69957397738 <i>NS</i>	14" x 28"	5

NS Non-Stock Item (5 case MOQ)
** Also available as a non-stock item*

All pads on pages 7 – 11 come with a 3-1/4" removable centerpiece.

PART #	SIZE	PADS/ CASE
Round Pads		
66261000614 <i>NS</i>	7-3/4"	5
66261000618 <i>NS</i>	12"	5
66261000452	13"	5
66261000453	14"	5
66261051612	15"	5
66261052001	16"	5
66261052002	17"	5
66261052003	18"	5
66261052004	19"	5
66261052005	20"	5
66261051885	21"	5
662610 * <i>NS</i>	21" (1/4"hole)	5
66261000919	22"	5
66261000736 <i>NS</i>	23"	5
66261000965 <i>NS</i>	24"	5
66261005091	27"	5
Rectangular Pads		
66254437378	14" x 20"	5
69957397632 <i>NS</i>	14" x 28"	5

PART #	SIZE	PADS/ CASE
Round Pads		
66261001833 <i>NS</i>	6-1/2"	5
66261000467 <i>NS</i>	7-3/4"	5
66261003015 <i>NS</i>	9"	5
66261000466	10"	5
66261000695	11"	5
66261000728	12"	5
66261054223	13"	5
66261054224	14"	5
66261054225	15"	5
66261054226	16"	5
66261054227	17"	5
66261054228	18"	5
66261054229	19"	5
66261054230	20"	5
66261054231	21"	5
66261054232	22"	5
66261000213 <i>NS</i>	24"	5
66261005095 <i>NS</i>	25"	5
66261005097 <i>NS</i>	27"	5
Rectangular Pads		
66261051677 <i>NS</i>	12" x 18"	5
69957399170	14" x 20"	5
69957397630 <i>NS</i>	14" x 28"	5

MACHINES USED



TECH TIP

For cost savings, pads can be cleaned and re-used. Clean by using a high pressure spray nozzle to remove fresh debris. Pads may be soaked in detergent or diluted stripping solution to dissolve heavy embedded soil or finish.

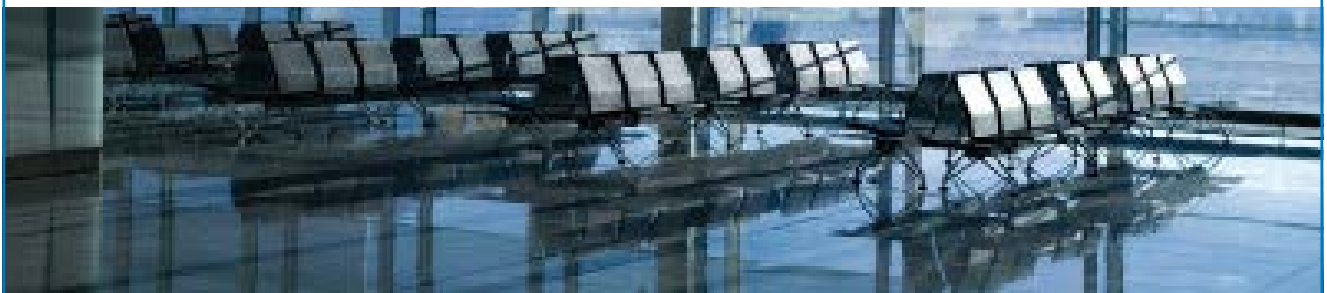

SCRUBBING AND CLEANING PADS

For general scrubbing and cleaning applications, Norton offers two pads that will remove surface dirt and grime to get your floor back in shape before re-coating or buffing.



Green Super Scrub

A heavy-duty wet scrubbing pad that will remove the toughest scuff marks in heavily soiled traffic areas.

PART #	SIZE	PADS/ CASE
Round Pads		
66261051605 <i>NS</i>	7-3/4"	5
66261051602	12"	5
66261054257	13"	5
66261054258	14"	5
66261054259	15"	5
66261054260	16"	5
66261054261	17"	5
66261054262	18"	5
66261054263	19"	5
66261054264	20"	5
66261054265	21"	5
66261054266 <i>NS</i>	22"	5
66261051601 <i>NS</i>	23"	5
Rectangular Pads		
66254437375 <i>NS</i>	14" x 20"	5
66254437373 <i>NS</i>	14" x 28"	5



Blue Super Clean

For general duty scrubbing or heavy spray cleaning jobs.

PART #	SIZE	PADS/ CASE
Round Pads		
66261051604 <i>NS</i>	7-3/4"	5
66261051606	10"	5
66261051897	11"	5
66261051899	12"	5
66261054240	13"	5
66261054241	14"	5
66261054242	15"	5
66261054243	16"	5
66261054244	17"	5
66261054245	18"	5
66261054246	19"	5
66261054247	20"	5
66261054248	21"	5
66261005109 <i>NS</i>	27"	5
Rectangular Pads		
66261193207	14" x 20"	5
69957397628 <i>NS</i>	14" x 28"	5

All pads on pages 7 – 11 come with a 3-1/4" removable centerpiece.



MACHINES USED



BUFFING AND POLISHING PADS

Designed to achieve a consistent finish with a mirror gloss shine.



Red Buffer

Generally used where a high gloss finish is desired when dry or spray buffing. It can also be used for light cleaning applications.

PART #	SIZE	PADS/ CASE
Round Pads		
6626100546 <i>NS</i>	7-3/4"	5
66261054284	10"	5
66261000565	11"	5
66261000566	12"	5
66261054272	13"	5
66261054273	14"	5
66261054274	15"	5
66261054275	16"	5
66261054276	17"	5
66261054277	18"	5
66261054278	19"	5
66261054279	20"	5
66261054280	21"	5
66261054281	22"	5
66261000249 <i>NS</i>	24"	5
66261005115 <i>NS</i>	27"	5
Rectangular Pads		
66261051672	12" x 18"	5
66261193014	14" x 20"	5
69957397578	14" x 28"	5
69957397625 <i>NS</i>	14" x 32"	5

NS Non-Stock Item (5 case MOQ)
* Also available as a non-stock item

All pads on pages 7 – 11 come with a 3-1/4" removable centerpiece.



White Super Gloss

A non-abrasive polishing/buffing pad, used dry or with a fine mist to yield a mirror gloss shine.

PART #	SIZE	PADS/ CASE
Round Pads		
66261008823 <i>NS</i>	6-1/2"	5
66261000214 <i>NS</i>	7-3/4"	5
66261051628 <i>NS</i>	10"	5
66261000207	11"	5
66261000176	12"	5
66261054205	13"	5
66261054206	14"	5
66261054207	15"	5
66261054208	16"	5
66261054209	17"	5
66261054210	18"	5
66261054211	19"	5
66261054212	20"	5
66261054213	21"	5
66261054214 <i>NS</i>	22"	5
66261000003	24"	5
66261005121	27"	5
66261005122 <i>NS</i>	28"	5
Rectangular Pads		
66261193022	14" x 20"	5
69957397626 <i>NS</i>	14" x 28"	5
69957397627 <i>NS</i>	14" x 32"	5



White Super 54 Pad

A non-abrasive pad used as a general purpose driver pad on orbital sanders, usually with PSA sanding sheets or screens. Due to the softness of the pad, abrasive products leave less of a scratch pattern.

PART #	SIZE	PADS/ CASE
Round Pads		
66261141782	16"	5
77696094538	20"	5
Rectangular Pads (for Squar-Buff, Clarke, Deva, Silverline)		
66261006547	12" x 18"	5



MACHINES USED



BURNISHING PADS

Burnishing pads for light scuff removal to renewing that wet-look finish. Engineered with fibers that are durable enough to clean and use again, yet resilient enough to conform to the floor surface for better coverage. This pad-to-floor coverage equates to less labor time and overall performance use of the pad. These pads help to prolong re-coating applications and maintain a high facility image.



Ultra Grizzly Bear

Special blend of synthetic and natural hair fibers with the highest hair content for more aggressive burnishing. Quickly removes scratches and marks to leave floors glistening.



Grizzly Bear

The perfect blend of fibers for jobs requiring additional lubrication to achieve a glossy shine. Additional pad flexibility and more aggressive than the Grizzly Lite Pad.



Grizzly Bear Lite

For a lighter blend of natural hair, the Grizzly Bear Lite produces an exceptional high luster to finishes, especially on soft and flexible surfaces. The natural and synthetic fibers combined with a soft resin, helps restore a high luster shine, quickly and easily.

PART #	SIZE	PADS/ CASE
Round Pads		
66261015254	6-1/2"	5
66261002980 <i>NS</i>	7-3/4"	5
66261057800 <i>NS</i>	13"	5
66261000610 <i>NS</i>	14"	5
66261051600 <i>NS</i>	15"	5
66261057801	17"	5
66261057802	18"	5
66261057803	19"	5
66261057804	20"	5
66261057805	21"	5
66261003325 <i>NS</i>	21" (1/4"hole)	5
66261005151	27"	5
66261002788	27" (1/4"hole)	5
66261005152 <i>NS</i>	28"	5

PART #	SIZE	PADS/ CASE
Round Pads		
77696045627 <i>NS</i>	6-1/2"	5
77696045628 <i>NS</i>	7-3/4"	5
77696045632 <i>NS</i>	13"	5
77696045635	17"	5
77696045637	19"	5
77696045638	20"	5
77696045639	21"	5
77696045643	24"	5
77696045645	27"	5
77696045646 <i>NS</i>	28"	5

*NS Non-Stock Item (5 case MOQ)
* Also available as a non-stock item*

PART #	SIZE	PADS/ CASE
Round Pads		
66261015506 <i>NS</i>	7-3/4"	5
66261010124 <i>NS</i>	13"	5
66261010125 <i>NS</i>	14"	5
66261007792	17"	5
66261007793	18"	5
66261007794	19"	5
66261007795	20"	5
66261007796	21"	5
66261007797	24"	5
66261007798	27"	5
66261007799	27" (1/4"hole)	5
66261010643	28"	5



Pink "Topshine" Burnish

Multi-purpose pad for ultra high-speed machines. Revives gloss on dull floors in a single pass. This totally synthetic pad works best when floors have a good base coat of finish and can be substituted for natural hair pads in health care facilities. For hard finishes only.

PART #	SIZE	PADS/ CASE
Round Pads		
66261005660 <i>NS</i>	13"	5
66261006112 <i>NS</i>	14"	5
66261005321 <i>NS</i>	16"	5
66261005662	17"	5
66261006336 <i>NS</i>	18"	5
66261005479	19"	5
66261005155	20"	5
66261005156	21"	5
66261005568 <i>NS</i>	22"	5
66261005168	24"	5
66261005127	27"	5
66261005128 <i>NS</i>	28"	5

All pads on pages 7 – 11 come with a 3-1/4" removable centerpiece.



MACHINES USED



BURNISHING PADS

Burnishing pads for light scuff removal to renewing that wet-look finish. Engineered with fibers that are durable enough to clean and use again, yet resilient enough to conform to the floor surface for better coverage. This pad-to-floor coverage equates to less labor time and overall performance use of the pad. These pads help to prolong re-coating applications and maintain a high facility image.

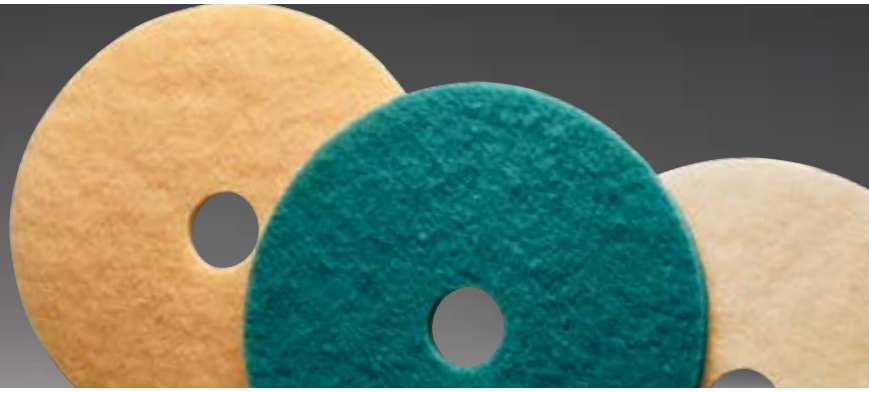

Thermal Burnish

A unique, rubberized binder formulation provides outstanding results on soft to medium hardness finishes.



Aqua Ultra High Speed Burnish

Engineered to produce the "wet-look" shine on soft to medium hardness finishes. This pad is an excellent general purpose pad and works especially well on metal-free finishes.



Champagne Polish and Burnish

Soft binders combined with fine fibers create the highest gloss of any pad on the market. Use on machines 1500-2000 rpm on soft to medium finishes.

PART #	SIZE	PADS/ CASE
Round Pads		
66261002037 <i>NS</i>	16"	5
66261055347	17"	5
66261055346	19"	5
66261055345	20"	5
66261055343	21"	5
66261055340 <i>NS</i>	24"	5
66261005145	27"	5

PART #	SIZE	PADS/ CASE
Round Pads		
66261002554	17"	5
66261002556	19"	5
66261002557	20"	5
66261002558	21"	5
66261004247	24"	5
66261005133	27"	5
66261005134	28"	5

PART #	SIZE	PADS/ CASE
Round Pads		
66261051625 <i>NS</i>	12"	5
66261057600 <i>NS</i>	13"	5
66261057601 <i>NS</i>	15"	5
66261057604 <i>NS</i>	16"	5
66261057607	17"	5
66261057609	18"	5
66261057610	19"	5
66261057611	20"	5
66261057612	21"	5
66261000604 <i>NS</i>	22"	5
66261000606	24"	5
66261005139	27"	5
66261057618 <i>NS</i>	27" (1/4" hole)	5
66261005140	28"	5

TECH TIP

Swirling and powdering are the result of a floor pad that is too aggressive for the floor finish. Move to a softer, less aggressive floor pad. If scuff marks and scratches are not being removed, move to a more aggressive pad.



*NS Non-Stock Item (5 case MOQ)
* Also available as a non-stock item*

All pads on pages 7 – 11 come with a 3-1/4" removable centerpiece.



MACHINES USED

MAROON ENVIRO STRIPPING PADS

These 1/4" pads are designed with a flexible web allowing more pad-to-surface contact. The high-quality abrasive grain provides a uniform cut to remove old finish with minimal work. This fiber and abrasive combination, when used with only water, creates the perfect green solution to stripping applications.

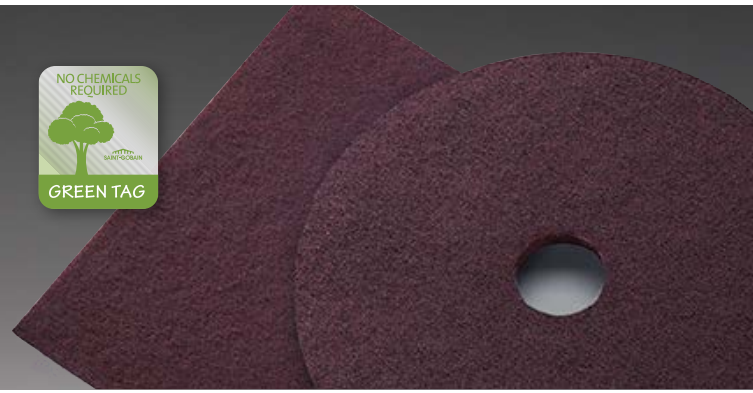

Strips with Water

Resilient construction, with a uniform web for consistent strip pattern. Premium aluminum oxide grain lasts longer and cuts faster. Ideal for residential and institutional areas concerned with use of conventional toxic chemical strippers.

PART #	SIZE	GRIT	PADS/ CASE
Round Pads			
662610 67531 NS	12"	Very Fine	10
662610 69129	13"	Very Fine	10
662610 69130 NS	14"	Very Fine	10
662610 69131	17"	Very Fine	10
699573 13627 NS	18"	Very Fine	10
662610 69132	20"	Very Fine	10

Other sizes available, contact Customer Service

PART #	SIZE	GRIT	PADS/ CASE
Rectangular Pads			
662610 65892	14" x 20"	Very Fine	10
662610 65894	14" x 28"	Very Fine	10
662610 65896 NS	14" x 32"	Very Fine	10

NS Non-Stock Item (5 case MOQ)

* Also available as a non-stock item



MACHINES USED



NON-WOVEN HAND AND UTILITY PADS

A complete offering from non-abrasive polishing pads to aggressive, heavy duty cleaning pads. Hand and utility pads are made from a non-woven, nylon fiber web that can be surface coated or completely impregnated with abrasive grain and bonded with synthetic resins. The unique manufacturing process produces a uniform dispersment of abrasive grain throughout the web for consistent coverage.

Tough and resilient, Norton utility pads resist snagging or tearing and will not shred. Additionally, they can be used wet or dry, will not rust, oxidize or cause metal contamination.

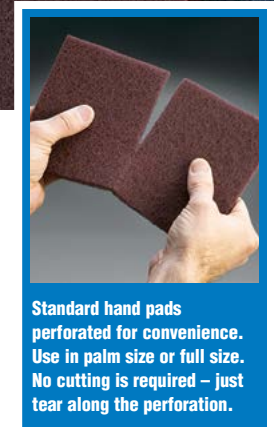

Standard hand pads perforated for convenience. Use in palm size or full size. No cutting is required – just tear along the perforation.

Hand Pad Recommendations

Hand Pads

PART #	PAD #	PADS/CASE
6" x 9" x 1/4"		
662610 59384 P	98/456	60 (6 boxes of 10)
662610 59395 P	96/668	60 (6 boxes of 10)
662610 52208 P	96/668	60 (bulk packed)
6995731 7251	96	60 (6 packs of 10)
662610 59393 P	86/616	60 (6 boxes of 10)
662610 52209 P	614	60 (6 boxes of 10)
662610 59400 P	707	60 (3 boxes of 20)

P Perforated Pads

Hand Pad Holder

PART #	DESCRIPTION	QTY/CASE
Hand Pad Holder		
662610 47583	Holder	10



← LEAST AGGRESSIVE
MOST AGGRESSIVE →

White: 98/456 Cleaning / Light-Duty The mildest acting, non-abrasive pad for cleaning sinks, tubs, showers, porcelain bowls, countertops, vinyl and plastic upholstery.	Green: 96/668 Clean and Scour / General-Purpose A medium-grade pad used for scouring pots, pans, broilers and ovens; removing rust and corrosion; and cleaning persistent marks from walls and baseboards.	Green: 96 Economy Scrub and Clean An economically-priced, medium pad, slightly more aggressive than the General-Purpose Pad, for cleaning and scouring pots, pans, broilers, and ovens; and removing rust and corrosion.	Dark Green: 86/616 Clean and Scour / Heavy-Duty Excellent coarse grade pad for removing excessive grease and burned-on foods from pots, pans, ovens and broilers, as well as removing rust and corrosion.	Black: 614 Stripping / Heavy-Duty Extremely aggressive coarse grade pad ideal for baseboard cleaning of wax build-up. Also good for cleaning griddles and other heavy duty jobs.	Maroon: 707 General-Duty Heavy-duty fine grade pad used when industrial solvents are needed when cleaning, i.e. MEK.

Utility Pad Recommendations

Utility Pads

PART #	COLOR	PADS/CASE
4-5/8" x 10"		
662610 59413	White	20 (4 Boxes of 5)
662610 59381	Red	20 (4 Boxes of 5)
662610 59382	Blue	20 (4 Boxes of 5)
662610 52211	Black	20 (4 Boxes of 5)
662610 52207	Black Hi-Pro	20 (4 Boxes of 5)
6995731 14155	Ultra Blue Stripper	20 (4 Boxes of 5)

Utility Pad Holders / Kit

PART #	DESCRIPTION	QTY/CASE
Utility Pad Holder		
662610 59431	Swivel Attachment	10
Utility Pad Kit		
076607 05388	Pad Swivel Holder Kit	1
	1 Swivel Holder,	
	1 Black Pad and	
	1 White Pad	



← LEAST AGGRESSIVE
MOST AGGRESSIVE →

White Light cleaning applications – non-abrasive	Red General-purpose cleaning pad	Blue Designed for medium-duty cleaning	Black Stripping of light finish buildup and scuff or heel marks	Ultra Blue Stripper For very aggressive stripping in less time

MACHINE USED



Floor Finish Applicators / Micro-Fiber Cloths

FINISH YOUR FLOORS WITH CONFIDENCE

Norton floor finish applicators will help you to quickly and easily apply floor finish or sealer, are easy to use, and provide superior results for your hardwood floor projects.

Created with the professional contractor in mind with four options to choose from we have the right applicator to give you the finished look your customers demand.

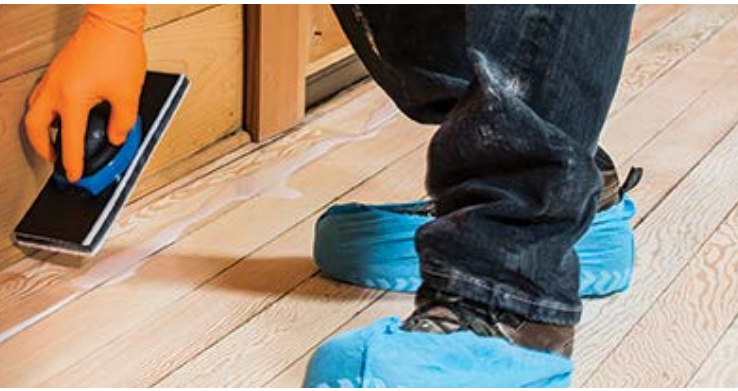

PART #	DESCRIPTION	CASE QTY.
Wood Block Applicator		
66261170583	10"	16
66261170584	12"	16
66261170585	14"	8
66261170586	16"	8
Synthetic Lamb's Wool Refill Pad		
66261170579	10"	20
66261170580	12"	20
66261170581	14"	20
66261170582	16"	20
Trim Tool and Refill Pads		
66261170572	9" Trim tool & pad	10
66261170573	9" Trim pad refill	36

PART #	DESCRIPTION	CASE QTY.
T-Bars		
66261170626	12"	20
66261170627	18"	20
T-Bar Sleeves		
66261170576	12"	8
66261170577	18"	8
66261170578	24"	8
Roller Covers and Cage		
66261170574	9" - 1/4" Microfiber	12
66261170575	9" - 3/8" Microfiber	12
66261170587	9" - 1/4" Mohair	12
66261170588	9" Roller frame	12

MICRO-FIBER PRODUCTS

Use the micro-fiber products dry for general cleaning. To remove spills, stains or grime, lightly dampen the product for best results. All micro-fiber products can be used with or without chemicals.

Micro-fiber products can be washed up to 300+ times without losing cleaning and trapping abilities. Micro-fiber products save you labor time and additional costs of multiple cleaning products and chemicals.



Cleaning Cloth (Blue)

Used for general wet or dry applications. Works best when sprayed with a light water mist to deep clean.

PART #	SIZE	QTY
Cleaning Cloth (Blue)		
07660705300	16" x 16"	20



Dry Tack / Dusting Cloth (Red)

Low profile to resist snagging and help pick up embedded debris. This cloth is used in a dry dusting application.

PART #	SIZE	QTY
Dry Tack Cloth (Red)		
07660704025	16" x 16"	20



Polishing Cloth (Yellow)

Streak-free cleaning of mirrors, optical lens and high polishing items.

PART #	SIZE	QTY
Polishing Cloth (Yellow)		
07660705301	16" x 16"	20



Carpet/Spin Bonnets

These pads are super absorbent and can be used on both sides for longer-lasting use before laundering. Recommended on low-speed machines of 175-350 RPM. With the multiple washing abilities, these products will outlast their traditional counterparts.

PART #	SIZE	QTY.
Carpet/Spin Bonnet		
66261015385	17"	2
66261015387	20"	2

TECH TIP

Micro-fiber is virtually scratch resistant but may pick up debris that can scratch. Clean micro-fiber products often for best results.

MACHINE USED



CONDITIONING PADS

These 1/4" thick pads are manufactured with the finest fibers, resins and abrasives to allow multiple levels of surface blending of water-based urethanes on hardwood floors.



Maroon Heavy Duty Pad
Aggressive pad designed for surface smoothing of wood fibers raised by water-based sealers and finishes.



Dark Maroon General Purpose Pad
Designed for deburring, smoothing, cleaning and general surface conditioning of wood floor surfaces between coats of water-based or solvent-based finishes.

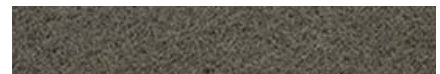

Gray Light Buffing Pad
Ultra fine grit for cleaning and light conditioning prior to final coating.

Rectangular Pads

PART #	GRIT	PADS/ CASE
12" x 18" (Squar-Buff, Clarke, Deva, Silverline)		
66261006547	White Super 54	5
66261009217	Very Fine/Dark Maroon	10
14" x 20"		
66261048383	NS Medium/Maroon	10
66261189205	NS Very Fine/Dark Maroon	10
14" x 28"		
66261048390	NS Medium/Maroon	10
14" x 32"		
66261052645	NS Very Fine/Dark Maroon	10

Other sizes available, contact Customer Service

Round Pads

PART #	GRIT	PADS/ CASE
16" Diameter		
66261002056	Medium/Maroon	10
66261002055	P Very Fine/Dark Maroon	10
66261002054	Ultra Fine/Gray	10
18" Diameter		
66261002220	NS Medium/Maroon	10
66261002218	P Very Fine/Dark Maroon	10
20" Diameter		
66261015689	NS Medium/Maroon	10
66261014691	P Very Fine/Dark Maroon	10
66261015083	Ultra Fine/Gray	10

P Perforated Pads



P = PERFORATED PADS

Available in our Dark Maroon Conditioning pads. Get more with this perforated pad. The 7" disc is easily removed for use on a edger machine or simply as a hand pad, while the 16" pad is used on standard floor machines.



MACHINE USED



BETWEEN COAT SANDING DISC AND SCREEN DRIVERS

Our patent-pending design allows you to smooth and prep the surface of the floor to properly accept the next coat of finish without the risk of nasty swirl marks. We offer four grits: coarse, medium, fine and very fine to accommodate any application. The foam backing pad allows the product to abrade the surface without penetrating deep into the finish, resulting in a smoother overall floor.



Screen Driver Pads

Designed specifically for driving sanding screens. Unique design prevents slippage for improved product life, cut, and finish. Minimizes dish out of soft grain. Use the pad by itself to buff on stain under a rotary buffer as the pad will hold and disperse stain evenly over the floor without slinging.

PART #	COLOR	PKG / CASE
12" x 18" Rectangular x 1" Thick		
66261006547	White	5
15" Diameter x 1/4" Thick		
66261018833	White	10
16" Diameter x 1/4" Thick		
66261016968	White	10
16" Diameter x 1" Thick		
66261141782	White	5
17" Diameter x 1/4" Thick		
66261017116	White	10
18" Diameter x 1/4" Thick		
66261018834	White	10
19" Diameter x 1/4" Thick		
66261017117	White	10
20" Diameter x 1/4" Thick		
66261017118	White	10



SandDollar Pads

Norton SandDollar pads have a long life (approximately 1500 sf/pad) and are extremely durable and tear resistant. The aluminum oxide grain bonded to the foam backing allows the pad to properly abrade the finish while still producing a very fine scratch pattern.

PART #	GRIT / COLOR	PKG / CASE
16" Diameter		
66261194109	Coarse / Blue	4 / 4
66261194114	Medium / Red	4 / 4
66261194115	Fine / Yellow	4 / 4
66261194117	Very Fine / Green	4 / 4
66261194874	Assorted / 1 of each color	4 / 4
20" Diameter		
66623398561	Coarse / Blue	4 / 4
66623383384	Medium Red	4 / 4

TECH TIP

BETWEEN COATS

Don't over use your abrasive product when abrading between coats of finish. A worn out abrasive will still dull the surface, but it may not be putting the proper scratch into the finish to get a good mechanical bond for the next coat of finish. If the surface isn't abraded properly, you can wind up with finish peeling, flaking and chipping. It's a lot less expensive to use a few more abrasive products on the job than to go and re-sand a job because of finish failure.



MACHINE USED



TECH TIP



BUFFING ON STAIN

Buffing on stain is a technique that is gaining in popularity due to the time savings over traditional method sand the use of fewer materials, like rags and stain.

Our screen driver pads in tandem with our maroon conditioning pads create the perfect system for applying stain with a rotary buffer. The unique design of the screen driver pad allows it to hold and apply stain evenly on the floor without slinging.

The maroon pad (with 7" center removed) is placed on top of the screen driver pad. This center hole creates a "trough" where the stain is poured. This system is then driven with either a screen driver or maroon pad on the buffer drive plate. The screen driver and maroon pad remain on the floor during the process. The operator only needs to tip back the buffer to add more stain to the "trough." This makes for less mess.

TYPICAL PROCESS

- Edges are cut in and wiped off by hand in appropriate size section of floor
- Stain is applied to main section of floor with buffer
- A clean screen driver pad is put on the buffer to buff off excess stain left on floor
- Move to next section of floor

NOTE:

- Not all stain can be applied with this method, check with stain manufacturer
- Do not work to large of an area to avoid lap marks
- Dispose of used pads properly, they are flammable

LARGE DIAMETER SCREEN DISCS

Screen products can be used on a variety of surfaces such as hardwood floors, natural stone surfaces, and concrete. They may be used wet or dry and are recommended for use on low speed machines which operate at 175 – 350 RPM. The uniform open mesh construction of our screen products combined with our superior coating and bonding technologies, helps produce an exceptional finished product with long life and better performance.

FEATURES & BENEFITS

- Tough screen backing
- Extremely fast cut rate and long life
- Coarse grits available in 80 to 150 grits
- Can use both sides of disc – rinse and reuse until worn.

SCREEN DISC PERFORMANCE GUIDE

PRODUCT	PERFORMANCE
Durite	Better choice for superior performance at conventional market price
Silicon Carbide	Good choice for quality and value with consistent performance and low initial price

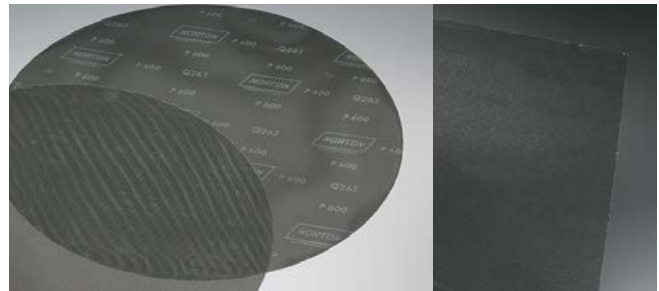
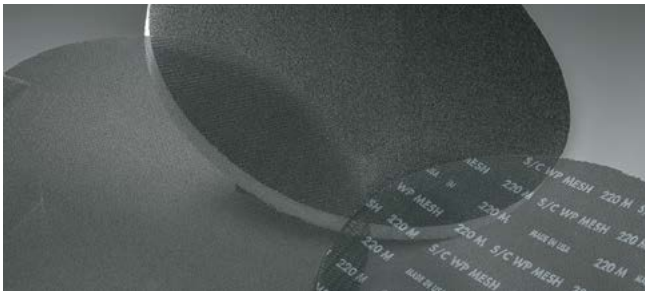

Norton Durite

Durite abrasive is bonded to an inter-woven polyester knit backing provides increased durability and life. Full resin bond provides excellent grain retention.

Silicon Carbide

Silicon carbide abrasive in a cost-effective design offers outstanding combination of performance and value.

Round Discs

PART #	GRIT	PKG / CASE	PART #	GRIT	PKG / CASE
15" Diameter			18" Diameter		
66261120509	150	10	66261120526	180	10
66261120510	120	10	66261120527	150	10
66261120511	100	10	66261120528	120	10
66261120512	80	10	66261120529	100	10
16" Diameter			19" Diameter		
66261123032	220	10	66261120530	80	10
66261120515	150	10	66261120531	60	10
66261120516	120	10	20" Diameter		
66261120517	100	10	66261120533 NS	150	10
66261120518	80	10	66261120534 NS	120	10
66261120519	60	10	66261120535	100	10
17" Diameter			66261120536	80	10
66261131726 NS	220	10	66261120537	60	10
66261120520	180	10	20" Diameter		
66261120521	150	10	66261120538 NS	180	10
66261120522	120	10	66261120539	150	10
66261120523	100	10	66261120540	120	10
66261120524	80	10	66261120541	100	10
66261120525	60	10	66261120542	80	10
			66261120543	60	10

Round Discs

PART #	GRIT	PKG / CASE
15" Diameter		
66261157321 NS	120	10
16" Diameter		
66261148894	220	10
66261148895	180	10
66261148896	150	10
66261148897	120	10
66261148898	100	10
66261148899	80	10
66261148900	60	10
17" Diameter		
66261148902	150	10
66261148903	120	10
66261148904	100	10
66261148905	80	10
66261148906	60	10
18" Diameter		
66261157331	120	10
66261148907	100	10
66261148908	80	10
66261148909	60	10
19" Diameter		
66261157334	100	10
66261157332	60	10
20" Diameter		
66261148910	120	10
66261148911	100	10
66261148912	80	10
66261148913	60	10

Rectangular Sheets

PART #	GRIT	PKG / CASE
14" x 20"		
66254448364 NS	180	10
66261199170 NS	150	10
66261199169 NS	120	10
66261199168 NS	100	10
66261199167 NS	80	10
66261199166 NS	60	10
14" x 28"		
66261183312 NS	220	10
66261183310 NS	150	10
66261183309 NS	120	10
66261183308 NS	100	10
66261183307 NS	80	10

TECH TIP

Screens can be rinsed and reused to prolong sanding life. Rinsing the screens removes any debris or build up in the screen, exposing a fresh cutting surface.



Additional sizes available as non-stock. Please Inquire.

12", 13", 14", 21" and 22" diameter

MACHINES USED

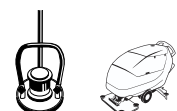

FLOOR DIAMOND MAINTENANCE PADS

Offer a variety of uses on concrete and natural stone floors. From deep cleaning to regular maintenance cleaning, these pads are the answer to your floor finishing issues. Made with a robust interlocking web, they are designed to withstand the harsh applications of concrete and natural stone floor maintenance. Available in a wide grit range permitting light maintenance to a final shine for most routine maintenance programs on all machine types. High quality diamond and a supreme bonding system allow the pads to take a dull floor and pop a mirror gloss shine.



Coarse/400

Perfect for cleaning and resurfacing concrete or natural stone floors. Works very well on floors that are very dirty with light surface scratches. The coarse grit pad should be followed by the medium pad.



Medium/800

The second step to resurfacing a natural stone or concrete floor following the coarse pad. It can also be the starting pad if the floor is slightly dirty with faint surface scratches.



Fine/1500

The third step in the resurfacing of a natural stone or concrete floor following the medium grit. Can also be used as a maintenance pad on most surfaces to keep the shine of the floor on a regular basis.



Very Fine/3000

The final step in the resurfacing of a natural stone or concrete floor following the fine grit. Is also recommended for ongoing maintenance of the floor to maintain a regular shine.

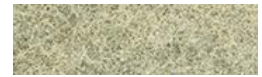

8000 Grit High Gloss Polish

Bring exceptional gloss to any natural stone floor. Backed with a natural hair pad backing this diamond will exceed your expectations. Best recommended use on a high speed electric or propane burnisher.

PART #	SIZE	QTY
701846 43513	7"	2
701846 43517	13"	2
701846 41575	17"	2
701846 41579	20"	2
701846 44146	27"	2

PART #	SIZE	QTY
701846 43514	7"	2
701846 43518	13"	2
701846 41576	17"	2
701846 41580	20"	2
701846 44147	27"	2

PART #	SIZE	QTY
701846 43515	7"	2
701846 43519	13"	2
701846 41577	17"	2
701846 41581	20"	2
701846 41583	27"	2

PART #	SIZE	QTY
701846 43516	7"	2
701846 43520	13"	2
701846 41578	17"	2
701846 41582	20"	2
701846 41584	27"	2

PART #	SIZE	QTY
701846 01982	NS 17"	2
701846 01983	NS 20"	2
701846 01984	NS 21"	2
701846 01985	NS 24"	2
701846 01986	NS 27"	2

Diamond Pad Performance Data

PAD	GRIT	TIME LASTED	AREA POLISHED
COARSE	400	3 hrs 30 min	23,589 sq. ft
MEDIUM	800	6 hrs 50 min	48,589 sq. ft
FINE	1500	9 hrs 10 min	64,777 sq. ft
VERY FINE	3000	9 hrs 10 min	64,777 sq. ft

Internal Testing performed on a polished concrete floor.

Assorted Packs

Perfect for applications where only a few pads are needed to get the job done. Available in the two most popular sizes, the assorted packs contain one each of the grit types; coarse, medium, fine and very fine.

PART #	SIZE	QTY
701846 41589	17"	4
701846 41590	20"	4

SURFACE STRIP AND PREP PAD

This floor pad is specifically designed for removing existing finishes or creating a "bite" surface for a new sealer. A specialized manufacturing process allows the abrasive grain and bond to be evenly dispersed throughout the web, enhancing pad life under extreme conditions of hard floor surface cleaning. The self-cleaning high quality abrasive grain combination allows the pad to evenly clean and strip while producing a floor surface that is ready for specified finish. Increase production by using in conjunction with diluted stripping products.



Surface Strip and Prep Pad

Tough web construction for removal of heavy grime or light surface grinding with lower overall cost compared to normal floor pad usage and performance. Can be used wet or dry. For use on concrete only.

PART #	SIZE	PADS/CASE
662611 98600	NS 17"	5
662611 98602	NS 20"	5

NS Non-Stock Item (5 case MOQ)

TECH TIP

These pads are ideal for marble and terrazzo for both deep cleaning/ renovating and standard maintenance to keep the shine. However, these pads are not recommended for granite.



MACHINES USED



PROLONGING THE LIFE OF YOUR FLOORS WHILE PROTECTING THE ENVIRONMENT

The Norton Natural Stone Care line of premium floor coatings conforms to "Green Leaf/LEED Qualifying" with each product containing less than 50g/L of V.O.C.s. They are environmentally-friendly and require no special or hazardous disposal methods. Each unique formula configuration provides a finish that protects against stains and surface wear, prolonging the life of the floor.



Diamond Polishing Discs

The high quality diamond design delivers superior cut and finish, and its reinforced hook keeps it in place throughout the whole process. Used in conjunction with the Red Buffer Pads.

PART #	COLOR	GRIT/GRADE	PIECES/ PACK
076607 68291	NS Black	Coarse	4
076607 68292	NS Red	Medium	4
076607 68293	NS Yellow	Fine	4
076607 68294	NS Green	Metal Bond	4



Impregnator (HD)

Hardener/Densifier for use in the grinding and polishing process (metal/resin bonded abrasives) of concrete and terrazzo surfaces. Ideal for repolishing and restoring worn and damaged surfaces.

PART #	DESCRIPTION	QTY
701846 30564	1 Gallon	1
701846 30565	5 Gallon	1



Protector/Restorer

Advanced, high gloss stain and wear protection that delivers rapid shine development with increased abrasion and stain protection. Restores the "wet" look to polished or finished concrete, factory-finished and terrazzo floors.

PART #	DESCRIPTION	QTY
701846 30574	1 Gallon	1
701846 30575	5 Gallon	1

TECH TIP

Coatings need to be applied in thin even layers on the floor surface. Depending on coverage area, you may want to apply coating with pump up or low pressure sprayer. We recommend that once the coating is sprayed on to the floor, that a pre dampened micro-fiber pad is used to ensure that the surface is completely covered and coating is spread consistently and evenly on floor surface.



MACHINE USED



A QUALITY NORTON STONE FOR EVERY JOB

Professional butchers to the line chef, Norton sharpening systems have the perfect combinations of oil stones for any job.

The black plastic case will protect your stone while offering a clean, safe, non-slip work area to sharpen your blade or tool.



Pro Tri-Stone System – IM313 Series
IM313 Multi-Oilstone systems contain three 11-1/2" oil stones, which permit long, sweeping strokes for faster and more precise sharpening and honing of all large, wider straight-edged knives. The heavy base has a non-skid bottom. Each IM313 system includes a pint of Norton oil, plastic angle guide, and reservoir unit.

IM313 for General Sharpening: Coarse Crystolon quickly restores worn edges; medium Crystolon produces the average edge needed for most knives; and fine India stone hones for a sharper edge.

IM313 CIS for Sharpening and Finishing: Coarse Crystolon for heavy stock removal; medium India for initial sharpening or resharping and Soft Arkansas for honing and final finishing.

PART #	DESCRIPTION	PKG/ CASE
11-1/2" x 2-1/2" x 1/2"		
614636 85960	IM313 One each Coarse Crystolon, Medium Crystolon and Fine India Sharpening Stones; Black Case	1/1
662532 42008	IM313 CIS One each Coarse Crystolon, Medium India and Soft Arkansas Sharpening Stones; Black Case	1/1



Home Tri-Stone System – IM200 Series
The smaller 8" stone IM200 systems provide the same quality sharpening features as the IM313 – making them the perfect choice for small restaurants and home chefs! All IM200 systems contain 4-1/2 oz of lubricating oil, plastic angle guide, and the reservoir unit.

IM200 for General Sharpening: Coarse Crystolon quickly restores worn edges; medium Crystolon produces the average edge needed for most knives; and fine India stone hones for a sharper edge.

IM200S for Sharpest Edges: Medium Crystolon quickly restores worn edges; medium India for resharping; extra fine Soft Arkansas for honing and final finishing

PART #	DESCRIPTION	PKG/ CASE
8" x 2" x 1/2"		
614636 91260	IM200B One each Coarse Crystolon, Medium Crystolon and Fine India Sharpening Stones; Black Case	1/1
662532 42006	IM200S One each Medium Crystolon, Medium India and Soft Arkansas Sharpening Stones; Black Case	1/1



Combination Stones

Choose one stone or a sequence of stones to quickly restore the cutting edge on all straight-edge knives. All oil stones are porous in nature. Oil is required to keep the pores open and working efficiently.

Level 1 Crystolon Combination CCS8: Coarse and fine grit sharp-cutting silicon carbide abrasive surfaces for general sharpening (to moderate tolerances) when the speed of sharpening is more important than the fineness of the cutting edges. Gray in color.

Level 2 India Combination ICS8: Coarse and fine grit aluminum oxide abrasive surfaces produce strong, keen, long-lasting edges on quality knives. Orange/brown in color.

Level 3 India/Soft Arkansas Combination SIMCS8: Medium grit aluminum oxide (India) and extra fine grit Soft Arkansas surfaces for start-to-finish sharpening and honing. Preferred by chefs to maintain knives at top performance. India side is orange/brown; Arkansas side off-white.

PART #	DESCRIPTION	PKG/ CASE
8" x 2" x 3/4"		
662435 92750	CCS8 Coarse/Fine Crystolon	1/5
662435 92751	ICS8 Coarse/Fine India	1/5
662435 92753	SIMCS8 Medium India/Soft Arkansas	1/5



Combination Stone Systems IM50

This durable ABS plastic case has non-slip rubber feet. The case acts as a small oil reservoir while sharpening, and also provides clean storage when not in use. See above for descriptions of the combination stones.

All IM50 stations include 1 sharpening stone, 4-1/2 oz oil, plastic angle guide and a black storage case.

Create Your Own Sharpening Station
For a larger sharpening stone system, choose the 11-1/2" x 2-1/2" x 1" stone best suited to your needs, and pair it with the protective Black Case for 11-1/2" stones.

PART #	DESCRIPTION	PKG/ CASE
8" x 2" x 3/4"		
699366 42504	IM50 Includes Coarse/Fine India Sharpening Stone; Black Case	1/1
614636 91259	Black Case Fits 8" Stones	1/5
<i>Create your own IM50 - Use the CCS8 or SIMCS8 with the Black Case for 8" Stones.</i>		
11-1/2" x 2-1/2" x 1"		
614636 85840	JUM3 Coarse/Fine Crystolon	1/2
614636 85851	IM2 Coarse/Fine India	1/2
614636 87239	IC11 Med./Fine Crystolon/India	1/2
662530 62898	Black Case Fits 11-1/2" Stones	1/5

TAKE YOUR BLADE TO THE NEXT LEVEL

From the newest pure aluminum oxide ceramic stones to the old world Japanese-style water stones, Norton stones are on the edge of knife sharpening technology.

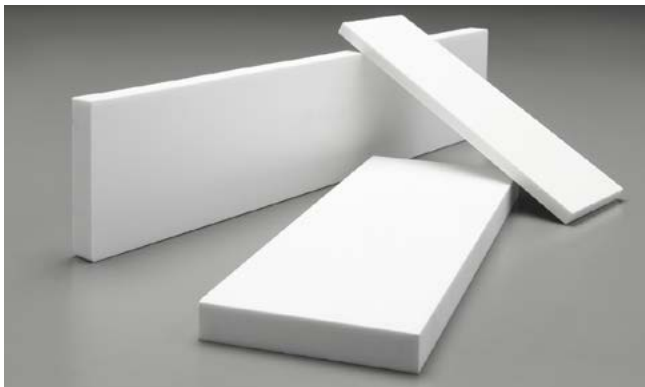
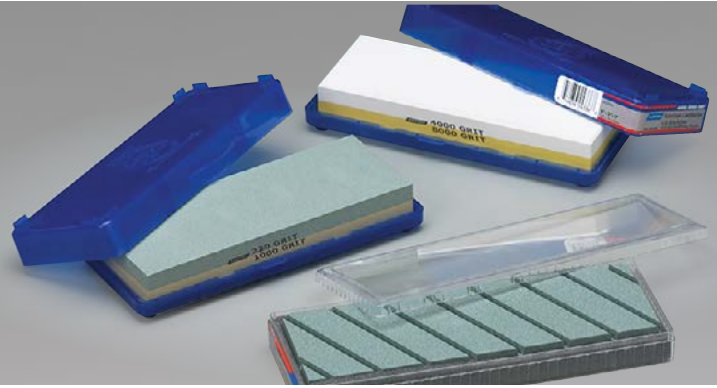

Ascent Ceramic Bench Stone

Our Norton Pike Ascent Ceramic Bench Stones will allow you to take your sharpening to a completely new level. The fine and ultra-fine surface finishes produce a keener edge than possible with traditional sharpening stones. Made from ultrafine, exceptionally pure aluminum oxide grain, these stones will work on all types of metal and are exceptionally hard and wear resistant. They are machined flat and will not dish even after years of use. For best results, Ceramic stones should be used dry, no need for oil or water lubrication.

PART #	STONE SIZE	PKG/CASE
690786 43670	1/2" x 1" x 4" Fine	1/1
690786 43671	1/2" x 1" x 4" Ultra Fine	1/1
690786 43672	1/2" x 2" x 6" Fine	1/1
690786 43673	1/2" x 2" x 6" Ultra Fine	1/1
690786 43674	1/2" x 2" x 8" Fine	1/1
690786 43675	1/2" x 2" x 8" Ultra Fine	1/1
690786 43676	1/2" x 3" x 8" Fine	1/1
690786 43677	1/2" x 3" x 8" Ultra Fine	1/1
690786 43678	1/2" x 2-1/2" x 11-1/2" Fine	1/1
690786 43679	1/2" x 2-1/2" x 11-1/2" Ultra Fine	1/1

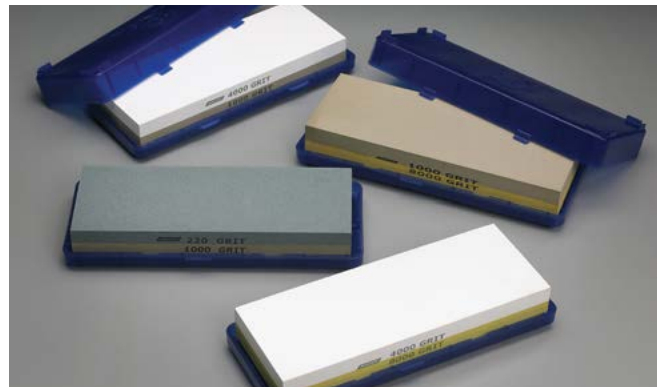

Japanese-Style Waterstones

Waterstones are synthetic stones designed to be softer than oil stone. The softer stones are used with water as the lubricant (versus oil) to develop a fast-cutting slurry. The Norton Waterstone system was designed in a carefully planned an efficient sharpening sequence. You get the level of abrasiveness you need at each stage, without wasting time trying to sharpen your knives on a grit that is too fine, too soon. These stones are very popular for the Japanese-style knives.

Level 1 200 Grit: Used to repair damaged or extremely dull blades.

Level 2 1000 Grit: Used to produce strong, keen, long-lasting edges on quality knives.

Level 3 4000 Grit: Used to hone a sharp blade to an ultra fine finish. Preferred by chefs to maintain knives at top performance.

Level 4 8000 Grit: Used for finest edges and tightest tolerances. Produces a highly polished finish for razor-sharp blades. Produces a great finish on Japanese-style knives.

PART #	DESCRIPTION	STONE SIZE	PKG/CASE
614636 24335	Combination 220 / 1000	8" x 3" x 1"	1/5
614636 24450	Combination 1000 / 4000	8" x 3" x 1"	1/5
699366 55039	Combination 1000 / 8000	8" x 3" x 1"	1/5
614636 24336	Combination 4000 / 8000	8" x 3" x 1"	1/5
076607 87943	Waterstone Starter Kit 1-220/1000, 1-4000/8000		1/1



Flattening Stone

After repeated uses, every waterstone starts to become concave (curved) as the abrasive is worn away during th sharpening process. To maintain the flat surface on th stone, it is essential to flatten it periodically with a flattening stone.

- Coarse grit silicon carbide stone
- Promotes maximum cutting for all grit sizes of waterstones
- Diagonal grooves
- Provides swarf removal
- Superbly flat with hard bond
- Produces extremely flat results on al waterstones

PART #	DESCRIPTION	STONE SIZE	PKG/CASE
699366 87444	Flattening Stone	9" x 3" x 3/4"	1/5

LIFE IN THE KITCHEN MADE EASIER

Norton's sharpening portfolio includes a hand held sharpener for quick edge repair, food safe sharpening oil to increase the life of your stones and accessories designed to make the sharpening process easier.

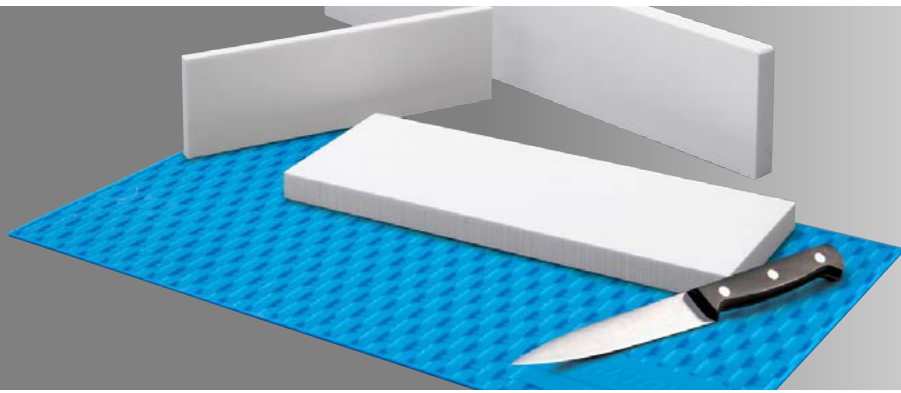

Crystolon Sharpening Steel

The new Norton Crystolon sharpening steel is easy to use and restores a blade's finish fast! Hold and use just like a conventional steel by sharpening the knife on the sides as needed. Unlike using a conventional steel that trues a knife's blade, the Norton steel removes metal thus imparting a new edge. The steel can be used without water or oil although the steel should be wiped clean after use. With a 10" rod, it is suited for most kitchen knives. It will fit conveniently into a knife block, can be hung up, or stored in the drawer. Easy to use for all skill levels – you will be amazed by the results!

PART #	DESCRIPTION	SIZE	PKG/ CASE
662532 40433	Crystolon Sharpening Steel	10" rod	8/8



Norton Sharpening Oil

Norton Oil is a highly refined lubricating oil specifically formulated for sharpening stone use, but equally ideal for all lubricating jobs. It will not load or "gum-up" sharpening stones. Meets U.S. Pharmacopoeia standards for mineral oil purity; it may be used around food preparation operations.

PART #	DESCRIPTION	SIZE	PKG/ CASE
614636 87760	Oil	4-1/2 oz	20/20
614636 87770	Oil	1 Pint	20/20



Non-Slip Silicon Sharpening Stone Mat

Non-slip silicon-sharpening mat is the perfect complement to the Norton line of Whetstones and Waterstones. Measuring 8" x 14", it is large enough to handle all conventionally sized sharpening stones.

A textured surface on both sides keeps the mat firmly in place on your work surface while also keeping your sharpening stone from moving during use. Ideal for use with stones sold without a non-skid base, it can also be used in conjunction with stone holders to keep them extra secure.

This thin and flexible mat can be rolled or folded for compact storage and is easily cleaned with soap and water.

PART #	DESCRIPTION	SIZE	PKG/ CASE
690786 48467	Non-Slip Sharpening Stone Mat	8" x 15"	25

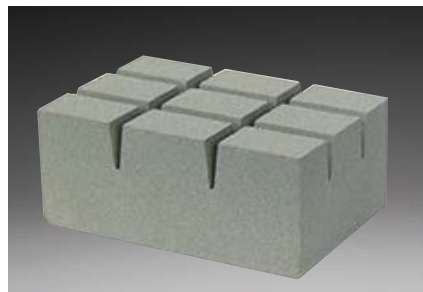

Griddle Brick

Medium aluminum oxide stone quickly cleans away carbon build-up and other residue on your grill without leaving fibers.

PART #	DESCRIPTION	SIZE	PKG/ CASE
614636 87870	Griddle Brick	4-1/2 x 3 x 2	1/5



Pull-Through Sharpener

The knife and scissors mechanical sharpener is a quick and portable tool for hundreds of sharpening applications.

PART #	DESCRIPTION	PKG/ CASE
076607 87520	Knife and Scissors Pull-Through Sharpener	6/6

SPONGE PADS

Cellulose sponges are made of durable, high quality cellulose. These sponges will hold many times their own weight in liquids, which gives you maximum absorbency for spills or carrying cleaning solutions.



Clean 'N Sponge Light-Duty #63/875
Cellulose sponge carries water or cleaning solution to the job and later wipes up residue. Excellent for cleaning vitreous china sinks, tubs, toilets, ceramic, plastic and rubber, tile countertops, desks, screens, etc. Non-woven material has gentle cleaning action.

PART #	SIZE	COLOR	PADS/ CASE
662610 59402	3-1/4" x 6-1/4" x 1"	White	40 (4 boxes of 10)



Scour 'N Sponge General-Purpose #74/893
Cellulose sponge carries water or detergent to the job surface. Extra strong non-woven material scours, scrubs and cleans the area. Sponge carries residue away. Excellent for cleaning stoves, counters, cooking utensils, ceilings and walls.

PART #	SIZE	COLOR	PADS/ CASE
662610 59403	3-1/4" x 6-1/4" x 1"	Green	40 (4 boxes of 10)



Heavy Duty Pot and Pan Scrubber 881
The pot and pan scrubber utilizes heavy fibers and an open weave to help create an aggressive pad for cleaning stubborn baked-on messes.

PART #	SIZE	PADS/ CASE
662610 55388	3-1/2" x 5"	40



Food Pro – Economy Green Scrub Pad
Mildly aggressive pad for effective scrubbing and cleaning action. Perfect for use in schools, restaurant and hospitality facilities. Perforated.

PART #	SIZE / DESCR.	PADS/ CASE
662610 69600	6" x 9" x 1/4" Green #96	10/box / 6 boxes



Stainless Steel Scrubber SS50G
A #300 series scrubber of the longest lasting stainless steel that will not rust or splinter.

PART #	SIZE	PADS/ CASE
662610 16505	3" Diameter	72 (12 packs of 6)



Grill/Griddle Screen, Pad and Holder
Open Mesh Griddle Screen
Ideal for use during heavy-duty cleaning of burnt on grease and food build-up.
Heat-Resistant Holder
Designed specifically for use with the griddle screen and polishing pad.

PART #	SIZE	PADS/ CASE
076607 03201	4" x 5-1/2"	100
662610 47583	3-1/4" x 5-1/2"	10



STEEL WOOL

A PERFECT GRADE FOR ANY PROJECT

Quickly remove rust and other contaminants from any metal surface.
Perfect for the restaurant kitchen or work shop.

Chose the right grade for your woodworking or wood floor project to efficiently clean and smooth.



Eight Grades – Infinite Possibilities

Norton Steel Wool is the perfect all-purpose choice for professional contractors and do-it-yourselfers. Made of thin bundled fibers, the soft abrasive can be used for cleaning, smoothing and polishing with grades varying from extra coarse #4 for heavy stripping to super fine #0000 for finishing. Color-coded packaging and grade indicator make it easy to choose the right coarseness for the job at hand, whether it's removing rust, dirt, varnish, or stripping paint from exterior woodwork. This product has been designed get into those hard-to-reach areas and compress to any shape for endless uses.

- Ideal for most household projects, including removing rust, dirt, varnish, or stripping paint from exterior woodwork
- Thin metal fibers bundled together easily compress to any shape so pads can be used in hard-to-reach areas and contoured surfaces
- Available in grades ranging from extra course #4 for heavy stripping to super fine #0000 for finishing and polishing
- Color coded packaging and grade indicator chart make finding the right grit easy

PART #	GRIT	PACK	PKS/CASE
076607 68112	0000 Super Fine	12	6
076607 68113	000 Extra Fine	12	6
076607 68114	00 Very Fine	12	6
076607 68115	0 Fine	12	6
076607 68116	1 Medium	12	6
076607 68117	2 Medium/Coarse	12	6
076607 68118	3 Coarse	12	6
076607 68335	4 Extra Coarse	12	6

APPLICATION/GRIT RECOMMENDATION GUIDE



PART #	PAGE	PART #	PAGE	PART #	PAGE	PART #	PAGE	PART #	PAGE	PART #	PAGE
07660703201	23	66261000618	7	66261009217	15	66261054205	9	66261057607	11	66261120539	17
07660704025	14	66261000695	7	66261010124	10	66261054206	9	66261057609	11	66261120540	17
07660705300	14	66261000728	7	66261010125	10	66261054207	9	66261057610	11	66261120541	17
07660705301	14	66261000736	7	66261010643	10	66261054208	9	66261057611	11	66261120542	17
07660705388	13	66261000919	7	66261014185	7	66261054209	9	66261057612	11	66261120543	17
07660768112	24	66261000965	7	66261014186	7	66261054210	9	66261057618	11	66261123032	17
07660768113	24	66261001833	7	66261014187	7	66261054211	9	66261057800	10	66261131726	17
07660768114	24	66261002037	11	66261014188	7	66261054212	9	66261057801	10	66261141782	9, 16
07660768115	24	66261002054	15	66261014189	7	66261054213	9	66261057802	10	66261148894	17
07660768116	24	66261002055	15	66261014190	7	66261054214	9	66261057803	10	66261148895	17
07660768117	24	66261002056	15	66261014191	7	66261054223	7	66261057804	10	66261148896	17
07660768118	24	66261002218	15	66261014192	7	66261054224	7	66261057805	10	66261148897	17
07660768291	19	66261002220	15	66261014193	7	66261054225	7	66261059381	13	66261148898	17
07660768292	19	66261002554	11	66261014194	7	66261054226	7	66261059382	13	66261148899	17
07660768293	19	66261002556	11	66261014575	5	66261054227	7	66261059384	13	66261148900	17
07660768294	19	66261002557	11	66261014691	15	66261054228	7	66261059393	13	66261148902	17
07660768335	24	66261002558	11	66261015083	15	66261054229	7	66261059395	13	66261148903	17
07660787520	22	66261002788	10	66261015254	10	66261054230	7	66261059400	13	66261148904	17
07660787943	21	66261002980	10	66261015385	14	66261054231	7	66261059402	23	66261148905	17
61463624335	21	66261003015	7	66261015387	14	66261054232	7	66261059403	23	66261148906	17
61463624336	21	66261003325	10	66261015506	10	66261054240	8	66261059413	13	66261148907	17
61463624450	21	66261004247	11	66261015689	15	66261054241	8	66261059425	7	66261148908	17
61463685840	20	66261005091	7	66261016505	23	66261054242	8	66261059431	13	66261148909	17
61463685851	20	66261005095	7	66261016968	16	66261054243	8	66261065892	12	66261148910	17
61463685960	20	66261005097	7	66261017116	16	66261054244	8	66261065894	12	66261148911	17
61463687239	20	66261005109	8	66261017117	16	66261054245	8	66261065896	12	66261148912	17
61463687760	22	66261005115	9	66261017118	16	66261054246	8	66261067531	12	66261148913	17
61463687770	22	66261005121	9	66261018833	16	66261054247	8	66261069129	12	66261157321	17
61463687870	22	66261005122	9	66261018834	16	66261054248	8	66261069130	12	66261157331	17
61463691259	20	66261005127	10	66261019932	5	66261054257	8	66261069131	12	66261157332	17
61463691260	20	66261005128	10	66261047583	13, 23	66261054258	8	66261069132	12	66261157334	17
66243592750	20	66261005133	11	66261048383	15	66261054259	8	66261069600	23	66261170572	14
66243592751	20	66261005134	11	66261048390	15	66261054260	8	66261120509	17	66261170573	14
66243592753	20	66261005139	11	66261051600	10	66261054261	8	66261120510	17	66261170574	14
66253062898	20	66261005140	11	66261051601	8	66261054262	8	66261120511	17	66261170575	14
66253240433	22	66261005145	11	66261051602	8	66261054263	8	66261120512	17	66261170576	14
66253242006	20	66261005151	10	66261051604	8	66261054264	8	66261120515	17	66261170577	14
66253242008	20	66261005152	10	66261051605	8	66261054265	8	66261120516	17	66261170578	14
66254437373	8	66261005155	10	66261051606	8	66261054266	8	66261120517	17	66261170579	14
66254437375	8	66261005156	10	66261051612	7	66261054272	9	66261120518	17	66261170580	14
66254437378	7	66261005168	10	66261051625	11	66261054273	9	66261120519	17	66261170581	14
66254448364	17	66261005321	10	66261051628	9	66261054274	9	66261120520	17	66261170582	14
66261000003	9	66261005479	10	66261051636	5	66261054275	9	66261120521	17	66261170583	14
66261000176	9	66261005568	10	66261051638	5	66261054276	9	66261120522	17	66261170584	14
66261000207	9	66261005660	10	66261051672	9	66261054277	9	66261120523	17	66261170585	14
66261000213	7	66261005662	10	66261051677	7	66261054278	9	66261120524	17	66261170586	14
66261000214	9	66261006112	10	66261051885	7	66261054279	9	66261120525	17	66261170587	14
66261000249	9	66261006336	10	66261051897	8	66261054280	9	66261120526	17	66261170588	14
66261000452	7	66261006547	9,	66261051899	8	66261054281	9	66261120527	17	66261170626	14
66261000453	7		15-16	66261052001	7	66261054284	9	66261120528	17	66261170627	14
66261000466	7	66261007792	10	66261052002	7	66261055340	11	66261120529	17	66261183307	17
66261000467	7	66261007793	10	66261052003	7	66261055343	11	66261120530	17	66261183308	17
66261000546	9	66261007794	10	66261052004	7	66261055345	11	66261120531	17	66261183309	17
66261000565	9	66261007795	10	66261052005	7	66261055346	11	66261120533	17	66261183310	17
66261000566	9	66261007796	10	66261052207	13	66261055347	11	66261120534	17	66261183312	17
66261000604	11	66261007797	10	66261052208	13	66261055388	23	66261120535	17	66261189205	15
66261000606	11	66261007798	10	66261052209	13	66261057600	11	66261120536	17	66261193014	9
66261000610	10	66261007799	10	66261052211	13	66261057601	11	66261120537	17	66261193022	9
66261000614	7	66261008823	9	66261052645	15	66261057604	11	66261120538	17	66261193207	8

PART #	PAGE	PART #	PAGE	PART #	PAGE	PART #	PAGE	PART #	PAGE	PART #	PAGE
662611 94109	16	690786 43671	21	699573 17251	13	701846 30564	19	701846 41590	18	776960 45637	10
662611 94114	16	690786 43672	21	699573 97578	9	701846 30565	19	701846 43513	18	776960 45638	10
662611 94115	16	690786 43673	21	699573 97625	9	701846 30574	19	701846 43514	18	776960 45639	10
662611 94117	16	690786 43674	21	699573 97626	9	701846 30575	19	701846 43515	18	776960 45643	10
662611 94874	16	690786 43675	21	699573 97627	9	701846 41575	18	701846 43516	18	776960 45645	10
662611 98600	18	690786 43676	21	699573 97628	8	701846 41576	18	701846 43517	18	776960 45646	10
662611 98602	18	690786 43677	21	699573 97630	7	701846 41577	18	701846 43518	18	776960 94538	9
662611 99166	17	690786 43678	21	699573 97632	7	701846 41578	18	701846 43519	18		
662611 99167	17	690786 43679	21	699573 97738	7	701846 41579	18	701846 43520	18		
662611 99168	17	690786 48467	22	699573 99170	7	701846 41580	18	701846 44146	18		
662611 99169	17	699366 42504	20	701846 01982	18	701846 41581	18	701846 44147	18		
662611 99170	17	699366 55039	21	701846 01983	18	701846 41582	18	776960 45627	10		
666233 83384	16	699366 87444	21	701846 01984	18	701846 41583	18	776960 45628	10		
666233 98561	16	699573 13627	12	701846 01985	18	701846 41584	18	776960 45632	10		
690786 43670	21	699573 14155	13	701846 01986	18	701846 41589	18	776960 45635	10		

TRADEMARKS

All Trademarks used in these pages are trademarks of Saint-Gobain Abrasives unless otherwise indicated.

CLEAN 'N SPONGE™
DURITE®
ENVIRO™

GRIZZLY BEAR LITE™
GRIZZLY BEAR™
IMPREGNATOR™

NORTON®
SAND DOLLAR™

SCOUR 'N SPONGE™
ULTRA GRIZZLY BEAR™

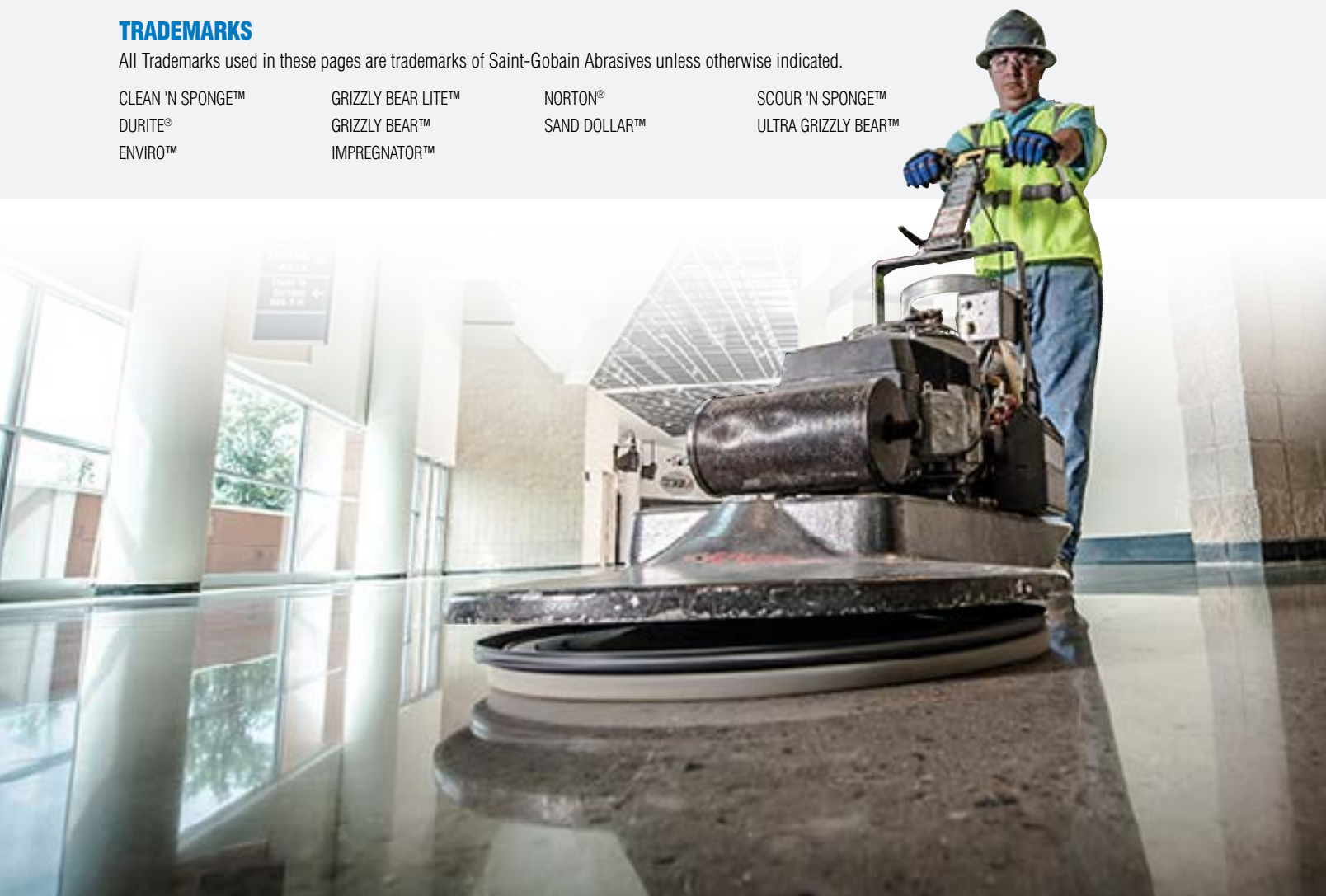

AT THE END OF THE DAY, **NORTON MAKES CLEAN-UP EASIER!**



Our food service product line just got bigger. Offering everything from hand pads, scrubbers, griddle screens, sponges, micro-fiber and more. **Make us your next call.**

NORTON PROFESSIONAL CLEANING MARKET



Floor Pads

The Right Pad for the Job

Tough, quality floor pads are manufactured to be thicker, with an open web structure for longer life and less loading. Each pad is designed for specific application needs.



Enviro Stripping Pads

Strips with Just Water!

Quality abrasive grain provides uniform cut for removal of finishes with minimal work and no use of harmful chemicals.



Norton SandDollar

Strip Away Old Ideas

A unique between coats/surface prep disc that replaces PSA strips and maroon pads.



Diamond Floor Maintenance Pads

Superior Shine

Withstands the harsh cleaning and maintenance of concrete and natural stone to provide a high shine.



6" x 9" Hand Pads

Scrub and Clean

From porcelain sinks to griddle tops, there's a pad to get the job done.

NORTON

SAINT-GOBAIN

CATALOG #350

PRODUCTS FOR THE
**PROFESSIONAL
HARDWOOD
FLOORING
MARKET**



THE **MUSCLE** BEHIND THE MACHINE®



BELTS

Blaze R975 Cloth **3**
 Red Heat R955P Cloth **4**
 BlueFire R831 Cloth **5**
 Neon R766 Cloth **5**
 Durite Silicon Carbide R418 Cloth **6**

ROLLS

Blaze R975 Cloth **7**
 Red Heat R955P Cloth & H955 Paper **8**
 BlueFire R831 Cloth & H831 Paper **8**
 Neon R766 Cloth & H766 Paper **9**
 Durite H425 & S413 Paper **9**

SHEETS AND BACK-UP PADS

Red Heat Q955 Screen **10**
 Neon H766 Paper **10**
 Durite Orbital Paper Sheets **11**
 Durite Orbital Screens **11**
 Orbital Non-Woven Back-up Pads **11**

EDGER DISCS AND PADS

Red Heat H955 Paper **12**
 BlueFire H831 Paper **13**
 Neon H766 Paper **13**
 Durite H425 & S413 Paper **14**
 Blaze-X F970 Fiber **14**
 Red Heat Q955 Screen **15**
 Screen-Bak Q421 Screen **15**
 Non-Woven Back-up & Conditioning Pads **15**

LARGE DIAMETER DISCS

Durite H425 & S413 Paper **16**
 Neon H766 Paper **17**
 Red Heat H955P Paper **17**
 Durite Double-Sided H425 & S413 Paper **18**
 Silicon Carbide H422 & S456 Paper **18**

HOOK AND LOOP DISCS

Red Heat H955 Paper **19**
 BlueFire H831 Paper **20**
 MeshPower Ceramic Mesh **21**

HOOK AND LOOP ORBITAL DISCS

ProSand Multi-Air Cyclonic **22**
 Blaze A995 Multi-Air Cyclonic **23**

SCREEN DISCS

Red Heat Q955 Screen **24**
 Durite Q421 Screen **25**
 Silicon Carbide Q425 Screen **25**
 Screen Driver Pads **26**

BETWEEN COATS

SandDollar Pads **27**
 Non-Woven Conditioning Pads **28**
 Aluminum Oxide PSA Sheet Rolls **28**
 Ceramic Alumina PSA Sheet Rolls **28**
 Clean & Prep Pads **28**
 Buffing Pads **29**

Rotolo Pre-Cut Foam Sanding Pads **29**

ACCESSORIES

Floor Finish Applicators **30**
 Hand Scraper / Sharpener Kit **31**
 Pro Game Line Tape **31**
 Premium Grade Clean Release Tape **31**
 Plastic Sheeting **31**
 Epoxy/Kit/Gun/Nozzles **32**
 Microfiber Cloths **32**
 Disposable Gloves **32**
 Mechanics Gloves **32**

CROSS REFERENCE

Part-to-Page **33**
 Janka Hardness Scale **35**

Mounted to a belt machine for continuous sanding

Levelling floors and achieving a very smooth finish

Used to do the main portion of the floor

Ideal for heavy stock removal

Popular with professional contractors for use on larger jobs



Best choice for sport floor market and extremely effective sanding pre-finished floors



BLAZE R975 CLOTH / BLAZE PLUS R980PP CLOTH

- Super-sharp premium ceramic grain cuts fast and delivers unparalleled longevity resulting in less belt changes and more footage per job. Leaves a fine scratch for easier sanding and a better overall finish
- Open coat grain design minimizes loading and provides an aggressive cut to easily sand through multiple layers of tough coatings
- Anti static backing improves dust collection and keeps machines cleaner
- Tough poly-cotton backing is extremely strong and flexible for improved tracking and easy application/installation on drum sanders
- Choose heavy-duty, longer-lasting Blaze R980PP for the hardest floor surfaces

PART #	GRIT	STD. PKG.
7-7/8" x 29-1/2" Blaze R975		
66261150000	5	120 5 / 5
66261150001	2	100 5 / 5
66261150002	9	80 5 / 5
66261150003	6	60 5 / 5
66261150004	3	50 5 / 5
66261150005	0	40 5 / 5
66261150007	4	36 5 / 5
66261150008	1	24 5 / 5
7-7/8" x 29-1/2" Blaze Plus R980PP		
78072715991	4	40 5 / 5
78072715992	1	36 5 / 5
78072715993	8	24 5 / 5
9-7/8" x 29-1/2" Blaze R975		
66261150009	8	120 5 / 5
66261150011	1	100 5 / 5
66261150012	8	80 5 / 5
66261150013	5	60 5 / 5
66261150014	2	50 5 / 5
66261150016	6	40 5 / 5
66261150017	3	36 5 / 5
66261150018	0	24 5 / 5

PART #	GRIT	STD. PKG.
9-7/8" x 29-1/2" Blaze Plus R980PP		
78072715988	4 NS	40 5 / 5
78072715989	1 NS	36 5 / 5
78027215990	7 NS	24 5 / 5
11-7/8" x 29-1/2" Blaze R975		
66261150019	7	120 5 / 5
66261150020	3	100 5 / 5
66261150021	0	80 5 / 5
66261150022	7	60 5 / 5
66261150023	4	50 5 / 5
66261150024	1	40 5 / 5
66261150025	8	36 5 / 5
66261150026	5	24 5 / 5
11-7/8" x 29-1/2" Blaze Plus R980PP		
78072715997	6	40 5 / 5
78072715998	3	36 5 / 5
78072716007	1	24 5 / 5
11-7/8" x 31-1/2" Blaze R975		
66261150027	2 NS	120 5 / 10
66261150028	9	100 5 / 5
66261150029	6	80 5 / 5
66261150031	9	60 5 / 5

PART #	GRIT	STD. PKG.
11-7/8" x 31-1/2" Blaze R975 continued		
66261150032	6	50 5 / 5
66261150033	3	40 5 / 5
66261150034	0	36 5 / 5
66261150035	7	24 5 / 5

THE MOST VALUABLE PRODUCT IN THE SPORT FLOOR MARKET

Norton Blaze delivers an incredibly sharp cut unrivaled in the sport floor market. Designed to cut faster and more aggressively, it has the unique ability to remove multiple layers of coatings quickly and without issue.

Designed specifically for the toughest sanding applications, Norton Blaze tackles gym floor re-sands with ease and is proven to cut through UV-cured pre-finished floors in one pass. When you're racing against the clock to get the job done, put Norton Blaze in your starting lineup.

Best choice for smoothest finish



RED HEAT R955P CLOTH

- Provide significant increase in square foot coverage, sanding anywhere from 1,000 - 3,000 square feet
- Provide a cut so aggressive you can flatten the floor using one or two grits finer than any other belt
- Cut through A/O pre-finished flooring with ease and minimal belt consumption

PART #	GRIT	STD. PKG.
7-7/8" x 29-1/2"		
699573 45027 7	120	5 / 5
699573 45028 4	100	5 / 5
699573 45029 1	80	5 / 5
699573 45030 7	60	5 / 5
699573 45031 4	50	5 / 5
699573 45032 1	40	5 / 5
699573 45033 8	36	5 / 5
699573 45034 5	24	5 / 5
7-7/8" x 33"		
662610 40691 9 <i>FT</i>	100	5 / 5
662610 40692 6 <i>FT</i>	80	5 / 5
662610 40693 3 <i>FT</i>	60	5 / 5
662610 40694 0 <i>FT</i>	50	5 / 5
662610 40695 7 <i>FT</i>	40	5 / 5
662610 40696 4 <i>FT</i>	36	5 / 5
662610 40697 1 <i>FT</i>	24	5 / 5
8" x 19"		
636425 95807 9 <i>NS</i>	120	5 / 10
076607 68084 6	100	5 / 5
076607 68085 3	80	5 / 5
076607 68086 0	60	5 / 5
636425 95803 1 <i>NS</i>	50	5 / 10
636425 95802 4 <i>NS</i>	40	5 / 10
076607 68087 7	36	5 / 5
076607 68088 4	24	5 / 5

PART #	GRIT	STD. PKG.
9-7/8" x 29-1/2"		
699573 46299 7 <i>FT</i>	120	5 / 5
699573 46298 0	100	5 / 5
699573 46297 3	80	5 / 5
699573 46296 6	60	5 / 5
699573 46295 9	50	5 / 5
699573 46294 2	40	5 / 5
699573 46293 5	36	5 / 5
699573 46292 8 <i>NS</i>	24	5 / 10
11-7/8" x 21-11/16"		
699573 92506 5 <i>NS</i>	100	5 / 10
699573 92505 8 <i>NS</i>	80	5 / 10
699573 92504 1 <i>NS</i>	60	5 / 10
699573 92503 4 <i>NS</i>	50	5 / 10
699573 92502 7 <i>NS</i>	40	5 / 10
699573 92501 0 <i>NS</i>	36	5 / 10
699573 92500 3 <i>NS</i>	24	5 / 10
11-7/8" x 29-1/2"		
699573 45035 2 <i>FT</i>	120	5 / 5
699573 45036 9	100	5 / 5
699573 45037 6	80	5 / 5
699573 45038 3	60	5 / 5
699573 45039 0	50	5 / 5
699573 45040 6	40	5 / 5
699573 45041 3	36	5 / 5
699573 45042 0 <i>NS</i>	24	5 / 10

PART #	GRIT	STD. PKG.
11-7/8" x 31-1/2"		
636425 92878 2 <i>FT</i>	120	5 / 10
636425 92879 9	100	5 / 5
636425 92880 5	80	5 / 5
636425 92881 2	60	5 / 5
636425 92882 9	50	5 / 5
636425 92883 6	40	5 / 5
636425 92884 3	36	5 / 5
636425 92885 0	24	5 / 5

FT FastTrack Item NS Non-Stock Item

UNLEASH THE HEAT!

100% patented SG (Seeded Gel) ceramic alumina abrasive for longest life, fastest cut and more consistent finish. Tough X-weight cotton cloth backing is extremely flexible and shock absorbent for extreme conditions. No risk of color transfer with assured color consistency. Ideal for larger jobs and harder A/O finishes.

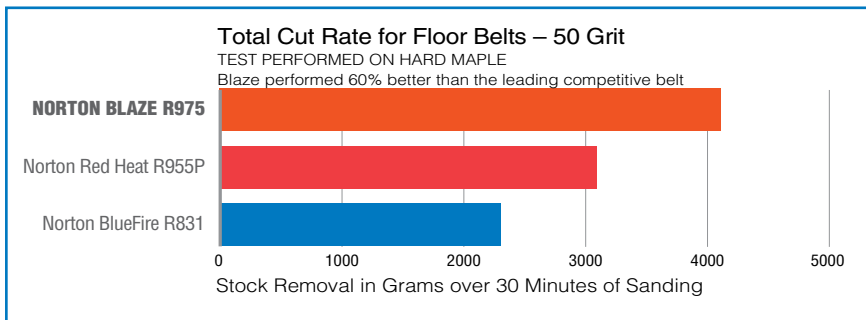

TECH TIP

When sanding pre-finished floors, common sense would say to start by using the coarsest grit available to sand off a very tough coating. In reality, the opposite is true. By starting with a coarse grit, you will get decreased product life and performance.

The proper sanding technique for pre-finished floors involves sanding the floor first with a finer grit, usually 80 grit. Sand the finish lightly with 80 grit, just to scratch the surface. Then come back with a coarser grit, usually 40 or 50 grit is coarse enough to remove the finish. Using this technique will greatly increase product life and cut rate. This technique works for the edger as well as the belt sander.

Better choice for fast cut on hard wood species



BLUEFIRE R831 CLOTH

- Next generation of patented, premium, self-sharpening, 100% zirconia alumina abrasive for longer life, faster cut and outstanding durability
- The anti-static technology increases dust collection efficiency for a cleaner working environment
- The improved resin bond ensures grain retention under the most demanding applications
- The consistent scratch pattern means the finest finish of the floor

PART #	GRIT	STD. PKG.
7-7/8" x 29-1/2"		
66623319968 5	120	10 / 10
66623319969 2	100	10 / 10
66623319970 8	80	10 / 10
66623319971 5	60	10 / 10
66623319972 2	50	10 / 10
66623319973 9	40	10 / 10
66623319975 3	36	10 / 10
66623319974 6	24	10 / 10
7-7/8" x 33"		
66623319976 0 <i>FT</i>	120	10 / 10
66623319977 6	100	10 / 10
66623319978 4	80	10 / 10
66623319979 1	60	10 / 10
66623319980 7	50	10 / 10
66623319981 4 <i>FT</i>	40	10 / 20
66623319983 8 <i>FT</i>	36	10 / 20
66623319982 1 <i>FT</i>	24	10 / 10

PART #	GRIT	STD. PKG.
9-7/8" x 29-1/2"		
66623319960 9 <i>FT</i>	120	10 / 10
66623319961 6	100	10 / 10
66623319962 3	80	10 / 10
66623319963 0	60	10 / 10
66623319964 7	50	10 / 10
66623319965 4	40	10 / 10
66623319967 8	36	10 / 10
66623319966 1 <i>FT</i>	24	10 / 10
11-7/8" x 29-1/2"		
66623319944 9 <i>FT</i>	120	10 / 10
66623319945 6	100	10 / 10
66623319946 3	80	10 / 10
66623319947 0	60	10 / 10
66623319948 7	50	10 / 10
66623319949 4	40	10 / 10
66623319951 7	36	10 / 10
66623319950 0 <i>FT</i>	24	10 / 10

PART #	GRIT	STD. PKG.
11-7/8" x 31-1/2"		
66623374202 7 <i>FT</i>	120	10 / 10
66623374203 4 <i>FT</i>	100	10 / 10
66623374205 8 <i>FT</i>	80	10 / 10
66623374206 5 <i>FT</i>	60	10 / 10
66623374208 9 <i>FT</i>	50	10 / 10
66623374209 6 <i>FT</i>	40	10 / 10
66623374210 2 <i>FT</i>	36	10 / 10
66623374211 9 <i>FT</i>	24	10 / 10

FT FastTrack Item

*Additional Sizes Available as Non-Stock:
7-7/8" x 21-11/16" and 11-7/8" x 21-11/16"*

Good choice when value and performance are key

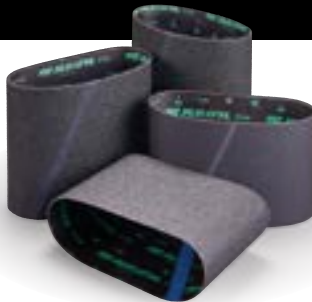

NEON R766 CLOTH

- Designed with durability and quality in mind at an economical price, Norton Neon floor sanding belts are the ideal choice for any general floor sanding job
- From exotic to domestic hardwood, Norton Neon provides quality results at a great price
- If performance, versatility and value are key, all signs point to Norton Neon

PART #	GRIT	STD. PKG.
7-7/8" x 29-1/2" (R766)		
63642524645 6	120	10 / 10
77696036429 1	100	10 / 10
66623372284 5	80	10 / 10
66623372283 8	60	10 / 10
66623372282 1	50	10 / 10
66623372281 4	40	10 / 10
66623372280 7	36	10 / 10
66623372279 1	24	10 / 10
9-7/8" x 29-1/2" (R766)		
63642574601 0 <i>FT</i>	120	10 / 10
63642574600 3	100	10 / 10
63642574604 1	80	10 / 10
63642574605 8	60	10 / 10
63642574606 5 <i>NS</i>	50	10 / 10
63642574607 2	40	10 / 10
63642574608 9	36	10 / 10
63642574609 6	24	10 / 10

PART #	GRIT	STD. PKG.
11-7/8" x 21-11/16" (R766)		
63642577635 2 <i>NS</i>	120	10 / 10
63642577636 9 <i>NS</i>	100	10 / 10
63642577637 6 <i>NS</i>	80	10 / 10
63642577638 3 <i>NS</i>	60	10 / 10
63642577639 0 <i>NS</i>	50	10 / 10
63642577640 6 <i>NS</i>	40	10 / 10
63642577641 3 <i>NS</i>	36	10 / 10
63642577642 0 <i>NS</i>	24	10 / 10
11-7/8" x 29-1/2" (R766)		
63642574602 7 <i>FT</i>	120	10 / 10
63642574603 4 <i>FT</i>	100	10 / 10
66623377653 4 <i>FT</i>	80	10 / 10
66623377651 0 <i>FT</i>	60	10 / 10
66623377650 3 <i>FT</i>	50	10 / 10
66623377649 7 <i>FT</i>	40	10 / 10
66623377648 0 <i>FT</i>	36	10 / 10
66623377647 3 <i>FT</i>	24	10 / 10

PART #	GRIT	STD. PKG.
11-7/8" x 31-1/2" (R766)		
63642577643 7 <i>FT</i>	120	10 / 10
63642577644 4 <i>FT</i>	100	10 / 10
66623377661 9 <i>FT</i>	80	10 / 10
66623377660 2 <i>FT</i>	60	10 / 10
66623377658 9 <i>FT</i>	50	10 / 10
66623377657 2 <i>FT</i>	40	10 / 10
66623377656 5 <i>FT</i>	36	10 / 10
66623377654 1 <i>FT</i>	24	10 / 10

FT FastTrack Item NS Non-Stock Item

*Additional Size Available as Non-Stock:
7-7/8" x 21-11/16"*



Good choice for heavy stock removal

DURITE SILICON CARBIDE R418 CLOTH

- Heavy Y-weight backing for extremely difficult applications
- Extra coarse grit silicon carbide grain provides significant stock removal

PART #	GRIT	STD. PKG.
7-7/8" x 29-1/2"		
78072769536 8	16	10 / 10
8" x 19"		
78072772102 9 <i>NS</i>	16	10 / 20
9-7/8" x 29-1/2"		
78072772053 4 <i>NS</i>	16	10 / 10

PART #	GRIT	STD. PKG.
11-7/8" x 29-1/2"		
78072772104 3 <i>NS</i>	16	10 / 10
11-1/2" x 31-1/2"		
78072772105 0 <i>NS</i>	16	10 / 10

NS Non-Stock Item

GET ON THE WINNING TRACK!

The Norton Fast Track Belt Service

FastTrack is a special order service for sanding belts. Items are identified as FastTrack in the catalog by FT following the part number. Orders for all FT and NS items can be placed on regular stock orders submitted through Customer Service.

2-Day Manufacturing Lead Time

ORDER REQUIREMENTS:

- Minimum order qty: 1 case per order
- Maximum order qty: 2 cases per order

NOTE: Standard manufacturing leeway of 10% ±.



Used to do the main portion of the floor

A pre-cut roll cover is cut to spec and mechanically applied to a rubber drum

Rolls are preferred for their ease of storing and carrying over pre-cut sheets

Rolls are generally used for larger jobs

Commonly used in the rental trade due to its lower cost vs. belt sanders



Best choice for sport floor market and extremely effective sanding pre-finished floors



BLAZE R975 CLOTH / BLAZE R980P CLOTH

- Super-sharp premium ceramic grain cuts fast and delivers unparalleled longevity resulting in less belt changes and more footage per job. Leaves a fine scratch for easier sanding and a better overall finish
- Open coat grain design minimizes loading and provides an aggressive cut to easily sand through multiple layers of tough coatings
- Anti static backing improves dust collection and keeps machines cleaner
- Tough poly-cotton backing is extremely strong and flexible for improved tracking and easy application/installation on drum sanders
- Choose heavy-duty, longer-lasting Blaze R980P for the hardest floor surfaces

PART #	GRIT	STD. PKG.
Blaze R975 Cloth		
8" x 25 yards (R975)		
66261150037 1	120	1 / 1
66261150040 1	60	1 / 1
66261150041 8	50	1 / 1
66261150043 2	40	1 / 1
66261150044 9	36	1 / 1
66261150045 6 <i>NS</i>	24	1 / 5
12" x 25 yards (R975)		
66261150046 3	120	1 / 1
66261150047 0	100	1 / 1
66261150048 7	80	1 / 1
66261150049 4	60	1 / 1
66261150050 0	50	1 / 1
66261150051 7	40	1 / 1
66261150052 4	36	1 / 1
66261150053 1	24	1 / 1

PART #	GRIT	STD. PKG.
Blaze Plus R980P Cloth		
12" x 25 yards (R980P)		
66261121207 6 <i>NS</i>	40	1 / 1
78072713926 8 <i>NS</i>	36	1 / 1
78072704407 4 <i>NS</i>	24	1 / 1
<i>NS Non-Stock Item</i>		

THE MOST VALUABLE PRODUCT IN THE SPORT FLOOR MARKET

Norton Blaze delivers an incredibly sharp cut unrivaled in the sport floor market. Designed to cut faster and more aggressively, it has the unique ability to remove multiple layers of coatings quickly and without issue.

Designed specifically for the toughest sanding applications, Norton Blaze tackles gym floor re-sands with ease and is proven to cut through UV-cured pre-finished floors in one pass. When you're racing against the clock to get the job done, put Norton Blaze in your starting lineup.

Best choice for overall smoothest finish



RED HEAT R955P CLOTH & H955 PAPER

- 100% patented ceramic alumina (SG) abrasive for longest life, fastest cut and more consistent finish
- Ultra tough Y-weight backing is extremely flexible and shock absorbent
- No risk of color transfer with assured color consistency. Ideal for larger jobs and harder A/O finishes

PART #	GRIT	STD. PKG.
R955 Cloth		
8" x 25 yards (R955P)		
66261183283 0 <i>NS</i>	120	1 / 5
66261183284 7	100	1 / 1
66261183285 4	80	1 / 1
66261183286 1	60	1 / 1
66261183287 8	50	1 / 1
66261183288 5	40	1 / 1
66261183289 2	36	1 / 1
66261183290 8 <i>NS</i>	24	1 / 5
12" x 25 yards (R955P)		
66261183291 5 <i>NS</i>	120	1 / 3
66261183292 2	100	1 / 1
66261183293 9	80	1 / 1
66261183294 6	60	1 / 1
66261183295 3	50	1 / 1
66261183296 0	40	1 / 1
66261183297 7	36	1 / 1
66261183298 4	24	1 / 1

PART #	GRIT	STD. PKG.
H955 Paper		
8" x 25 yards (H955)		
66623305450 2 <i>NS</i>	100	1 / 5
66623305451 9	80	1 / 1
66623305452 7	60	1 / 1
66623305453 3	50	1 / 1
66623305454 0	40	1 / 1
66623305455 7	36	1 / 1
66623305456 4	24	1 / 1
8" x 50 yards (H955)		
66261055940 4 <i>NS</i>	120	1 / 6
66261055939 0 <i>NS</i>	100	1 / 6
66261055938 4 <i>NS</i>	80	1 / 6
66261055937 7 <i>NS</i>	60	1 / 6
66261055936 0 <i>NS</i>	50	1 / 6
66261055935 3 <i>NS</i>	40	1 / 6
66261055934 6 <i>NS</i>	36	1 / 6

PART #	GRIT	STD. PKG.
H955 Paper (continued)		
12" x 50 yards (H955)		
66261055948 6 <i>NS</i>	120	1 / 3
66261055947 9 <i>NS</i>	100	1 / 3
66261055946 2 <i>NS</i>	80	1 / 3
66261055945 5 <i>NS</i>	60	1 / 3
66261055944 8 <i>NS</i>	50	1 / 3
66261055943 1 <i>NS</i>	40	1 / 3
66261055942 4 <i>NS</i>	36	1 / 3
66261055941 7 <i>NS</i>	24	1 / 3

NS Non-Stock Item

Better choice for fast cut on hard wood species



BLUEFIRE R831 CLOTH & H831 PAPER

- Proprietary patented grain technology produces one of the finest scratch patterns in the industry for a better looking finish
- Self-sharpening zirconia alumina abrasive provides improved life and cut rate that outlasts conventional zirconia 2 to 1
- Improved resin bond ensures grain retention and provides an aggressive cut on demanding applications

PART #	GRIT	STD. PKG.
R831 Cloth		
8" x 25 yards (R831)		
66623319992 0 <i>NS</i>	120	1 / 5
66623319993 7	100	1 / 1
66623319994 4	80	1 / 1
66623319995 1	60	1 / 1
66623319996 8	50	1 / 1
66623319997 5	40	1 / 1
66623319998 2	36	1 / 1
66623319999 9	24	1 / 1
12" x 25 yards (R831)		
66623319985 2	100	1 / 1
66623319986 9	80	1 / 1
66623319987 6	60	1 / 1
66623319988 3	50	1 / 1
66623319989 0	40	1 / 1
66623319990 6	36	1 / 1
66623319991 3	24	1 / 1

PART #	GRIT	STD. PKG.
H831 Paper		
8" x 25 yards (H831)		
66623319896 1 <i>NS</i>	120	1 / 5
66623319897 8	100	1 / 1
66623319898 5	80	1 / 1
66623319899 2	60	1 / 1
66623319901 2	40	1 / 1
66623319902 9	36	1 / 1
66623319903 6 <i>NS</i>	24	1 / 5
8" x 50 yards (H831)		
66623374264 5 <i>NS</i>	120	1 / 5
66623374268 3 <i>NS</i>	100	1 / 5
66623374269 0	80	1 / 1
66623374271 3	60	1 / 1
66623374272 0 <i>NS</i>	50	1 / 5
66623374273 7	40	1 / 1
66623374274 4	36	1 / 1
66623374270 6 <i>NS</i>	24	1 / 5

PART #	GRIT	STD. PKG.
H831 Paper (continued)		
12" x 25 yards (H831)		
66623319888 6 <i>NS</i>	120	1 / 3
66623319889 3 <i>NS</i>	100	1 / 3
66623319890 9 <i>NS</i>	80	1 / 3
66623319891 6 <i>NS</i>	60	1 / 3
66623319892 3 <i>NS</i>	50	1 / 3
66623319893 0 <i>NS</i>	40	1 / 3
66623319894 7 <i>NS</i>	36	1 / 3
66623319895 4 <i>NS</i>	24	1 / 3
12" x 50 yards (H831)		
66623374275 1 <i>NS</i>	120	1 / 3
66623374223 2 <i>NS</i>	100	1 / 3
66623374277 5 <i>NS</i>	80	1 / 3
66623374278 2	60	1 / 1
66623374279 9	50	1 / 1
66623374280 5 <i>NS</i>	40	1 / 3
66623374281 2	36	1 / 1
66623374282 9	24	1 / 1

NS Non-Stock Item

Good choice when value and performance are key

NEON R766 CLOTH & H766 PAPER



- Designed with durability and quality in mind at an economical price, Norton Neon floor sanding rolls are the ideal choice for any general floor sanding job
- From exotic to domestic hardwood, Norton Neon provides quality results at a great price

PART #	GRIT	STD. PKG.
R766 Cloth		
8" x 25 yards (R766)		
63642574610 2 <i>NS</i>	120	1/5
77696069570 8 <i>NS</i>	100	1/5
77696069569 2 <i>NS</i>	80	1/5
77696069568 5 <i>NS</i>	60	1/5
77696069567 8 <i>NS</i>	50	1/5
77696069566 1 <i>NS</i>	40	1/5
77696069565 4 <i>NS</i>	36	1/5
77696069564 7 <i>NS</i>	24	1/5
12" x 25 yards (R766)		
63642574611 9 <i>NS</i>	120	1/3
63642574612 6 <i>NS</i>	100	1/3
63642574613 3 <i>NS</i>	80	1/3
63642574614 0 <i>NS</i>	60	1/3
63642574615 7 <i>NS</i>	50	1/3
63642574616 4 <i>NS</i>	40	1/3
63642574617 1 <i>NS</i>	36	1/3
63642574618 8 <i>NS</i>	24	1/3

PART #	GRIT	STD. PKG.
H766 Paper		
8" x 50 yards (H766)		
66261170593 6	120	1/1
66261170594 3	100	1/1
66261170595 0	80	1/1
66261170596 7	60	1/1
66261170597 4	50	1/1
66261170598 1	40	1/1
66261170599 8	36	1/1
69957365435 4 <i>NS</i>	30	1/5
66261170600 1	24	1/1

PART #	GRIT	STD. PKG.
H766 Paper (continued)		
12" x 50 yards (H766)		
66261170601 8	120	1/1
66261170602 5	100	1/1
66261170603 2	80	1/1
66261170604 9	60	1/1
66261170605 6	50	1/1
66261170606 3	40	1/1
66261170607 0	36	1/1
69957368456 1 <i>NS</i>	30	1/3
66261170608 7	24	1/1

NS Non-Stock Item

Good choice for quality and consistency

DURITE H425 & S413 PAPER

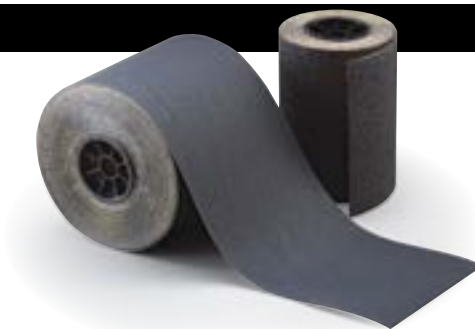

- 100% silicon carbide abrasive with heavy E, F and combination paper backings for quality cut and strength on the job
- Traditional abrasive grain provides value and consistent performance at a competitive price

PART #	GRIT	STD. PKG.
8" x 7.5 yards (270")		
66261123412 2 <i>NS</i>	120	3/3
66261147150 3	100	3/3
66261115629 5	80	3/3
66261115600 4	60	3/3
66261115627 1	40	3/3
66261112748 6	36	3/3
66261102431 0 <i>NS</i>	30	3/3
66261113270 1	20	3/3

NS Non-Stock Item

PART #	GRIT	STD. PKG.
8" x 50 yards		
66261123042 1	120	1/1
66261146880 0	100	1/1
66261146885 5	80	1/1
66261146890 9	60	1/1
66261146895 4	50	1/1
66261146900 5	40	1/1
66261146905 0	36	1/1
66261146910 4	30	1/1
66261146915 9	24	1/1
66261146920 3	20	1/1
66261146925 8	16	1/1
66261146930 2	12	1/1

PART #	GRIT	STD. PKG.
12" x 50 yards		
66261123043 8	120	1/1
66261147010 0	100	1/1
66261147015 5	80	1/1
66261147020 9	60	1/1
66261147025 4	50	1/1
66261147030 8	40	1/1
66261147035 3	36	1/1
66261147040 7	30	1/1
66261147045 2	24	1/1
66261147050 6	20	1/1
66261147055 1	16	1/1
66261113954 0 <i>NS</i>	12	1/3

Used to do the main portion of the floor

Excellent for sanding both the main area and the perimeter of the floor

Cut specifically to fit existing machines

Offered in PSA and Double-sided for ease of application



Best choice for overall smoothest finish



RED HEAT Q955 SCREEN

- 100% patented SG ceramic grain combined with long life provides a consistent cut and finish over the life of the screen, virtually eliminating the risk of burnishing the wood

PART #	GRIT	STD. PKG.
12" x 18"		
699573 12135 1 <i>NS</i>	220	10 / 20
699573 21935 5 <i>NS</i>	180	10 / 20
662610 44748 6 <i>NS</i>	150	10 / 20
662610 44746 2 <i>NS</i>	120	10 / 20
662610 44745 5 <i>NS</i>	100	10 / 20
662610 44742 4 <i>NS</i>	80	10 / 20

PART #	GRIT	STD. PKG.
14" x 20"		
666233 08395 3 <i>NS</i>	180	10 / 20
662544 76404 8 <i>NS</i>	150	10 / 20
666233 14702 0 <i>NS</i>	120	10 / 20
662544 76403 1 <i>NS</i>	100	10 / 20
666233 14701 3 <i>NS</i>	80	10 / 20

NS Non-Stock Item

Good choice when value and performance are key

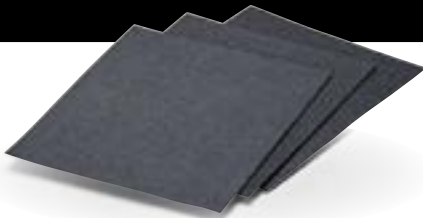

NEON H766 PAPER

- Neon sheets are a blend of zirconia alumina and silicon carbide giving a boost both in cut rate and life
- The addition of the heavy weight anti-stat backing allows the Neon product to sand much cleaner than other paper discs

PART #	GRIT	STD. PKG.
8" x 19-1/2" (H766)		
699573 42184 0 <i>NS</i>	120	10 / 50
699573 42185 7 <i>NS</i>	100	10 / 50
699573 42186 4 <i>NS</i>	80	10 / 50
699573 42190 1 <i>NS</i>	60	10 / 50
699573 42192 5 <i>NS</i>	50	10 / 50
699573 42198 7 <i>NS</i>	40	10 / 50
699573 42199 4 <i>NS</i>	36	10 / 50
699573 42206 9 <i>NS</i>	24	10 / 50
8" x 20-3/16" (H766)		
699573 42213 7 <i>NS</i>	120	10 / 100
699573 42214 4 <i>NS</i>	100	10 / 50
699573 42215 1 <i>NS</i>	80	10 / 50
699573 42216 8 <i>NS</i>	60	10 / 50

PART #	GRIT	STD. PKG.
8" x 20-3/16" (H766) (continued)		
699573 42217 5 <i>NS</i>	50	10 / 100
699573 42218 2 <i>NS</i>	40	10 / 50
699573 42219 9 <i>NS</i>	36	10 / 50
699573 42220 5 <i>NS</i>	24	10 / 100
8" x 26-1/8" (H766)		
699573 42221 2 <i>NS</i>	120	10 / 100
699573 42222 9 <i>NS</i>	100	10 / 100
699573 42223 6 <i>NS</i>	80	10 / 100
699573 42224 3 <i>NS</i>	60	10 / 100
699573 42225 0 <i>NS</i>	50	10 / 100
699573 42226 7 <i>NS</i>	40	10 / 100
699573 42227 4 <i>NS</i>	36	10 / 100
699573 42228 1 <i>NS</i>	24	10 / 100

PART #	GRIT	STD. PKG.
12" x 26-7/8" (H766)		
699573 42233 5 <i>NS</i>	120	10 / 100
699573 42234 2 <i>NS</i>	100	10 / 100
699573 42245 8 <i>NS</i>	80	10 / 100
699573 42246 5 <i>NS</i>	60	10 / 100
699573 42247 2 <i>NS</i>	50	10 / 100
699573 42249 6 <i>NS</i>	40	10 / 100
699573 42252 6 <i>NS</i>	36	10 / 100
699573 42254 0 <i>NS</i>	24	10 / 100

NS Non-Stock Item

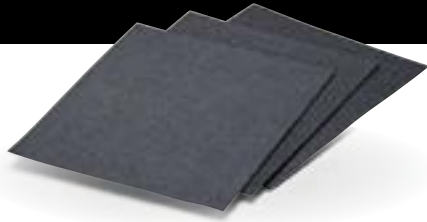

Good choice for all applications

DURITE ORBITAL PAPER SHEETS

- 100% silicon carbide abrasive coated with abrasive on both sides for twice the life, quick switch, no PSA contamination, increased tear resistance
- Strong E&F weight paper for durability

PART #	GRIT	STD. PKG.
Double-Sided Paper (H425/S413)		
12" x 18"		
662611 43140 8	120	10 / 10
662611 43141 5	100	10 / 10
662611 43142 2	80	10 / 10
662611 43143 9	60	10 / 10
662611 43144 6	40	10 / 10
662611 43145 3	36	10 / 10
662611 49158 1	20	10 / 10

PART #	GRIT	STD. PKG.
PSA Paper (H425/S413)		
12" x 18"		
662611 42832 3	120	20 / 20
662611 22409 3	100	20 / 20
076607 01385 9	80	20 / 20
076607 01386 6	60	20 / 20
076607 01387 3	36	10 / 10
076607 01388 0	20	10 / 10

PART #	GRIT	STD. PKG.
PSA Paper – Economical (H422/S456)		
12" x 18"		
662611 22408 6	80	20 / 20
662611 22407 9	60	20 / 20
662611 22406 2	36	20 / 20
662611 22410 9	20	10 / 10

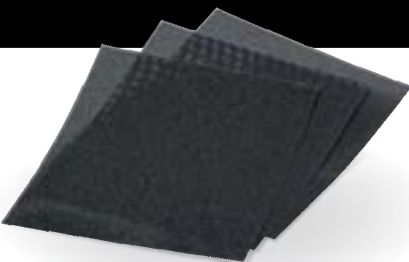

Good choice for recoats

DURITE ORBITAL SCREENS

- Inter-woven polyester knit backing with abrasive grain on both sides and open mesh for load resistance
- Rinse and reuse for longer sanding life
- Cuts more aggressively than paper or cloth

PART #	GRIT	STD. PKG.
Screen-Bak (Q421)		
12" x 18"		
662611 22411 6	180	10 / 10
076607 02490 9	150	10 / 10
076607 01393 4	120	10 / 10
076607 02489 3	100	10 / 10
662611 22415 4	80	10 / 10
662610 29395 3 <i>NS</i>	60	10 / 40

PART #	GRIT	STD. PKG.
Screen-Bak (Q421)		
14" x 32"		
699573 25881 1 <i>NS</i>	220	10 / 20
699573 25882 8 <i>NS</i>	180	10 / 20
699573 25884 2 <i>NS</i>	150	10 / 20
699573 25885 9 <i>NS</i>	120	10 / 20
699573 25886 6 <i>NS</i>	100	10 / 20
699573 25887 3 <i>NS</i>	80	10 / 20
699573 25888 0 <i>NS</i>	60	10 / 20

NS Non-Stock

PART #	GRIT	STD. PKG.
Screen (Q425)		
14" x 20"		
662544 48365 9 <i>NS</i>	220	10 / 20
662544 48364 2 <i>NS</i>	180	10 / 20
662611 99170 4 <i>NS</i>	150	10 / 10
662611 99169 8 <i>NS</i>	120	10 / 10
662611 99168 1 <i>NS</i>	100	10 / 10
662611 99167 4 <i>NS</i>	80	10 / 10
14" x 28"		
662611 83312 7 <i>NS</i>	220	10 / 20
662611 83311 0 <i>NS</i>	180	10 / 20
662611 83310 3 <i>NS</i>	150	10 / 10
662611 83309 7 <i>NS</i>	120	10 / 10
662611 83308 0 <i>NS</i>	100	10 / 10
662611 83307 3 <i>NS</i>	80	10 / 20
662611 83306 6 <i>NS</i>	60	10 / 20



Good choice for all sheets

ORBITAL NON-WOVEN BACK-UP PADS

- Used in conjunction with the PSA or double sided paper sheets.
- The orbital machine rests on top of the non-woven pad which acts as the driver for the abrasive, cutting softer leaving less of a scratch pattern.
- Choose white (non-abrasive) or red for a general purpose driver pad. Pad only - choose maroon for between coats abrasion and gray for light conditioning.

PART #	COLOR/GRIT	STD. PKG.
12" x 18"		
662610 06547 5	White, Super 54	5 / 5
662610 09217 4	Maroon, Very Fine	10 / 10
662610 09218 1 <i>NS</i>	Gray, Ultra Fine	10 / 10

PART #	COLOR/GRIT	STD. PKG.
12" x 18" (UPC Bar Coded)		
076607 01392 7	White	5 / 5
076607 03846 3	Red	5 / 5

PART #	COLOR/GRIT	STD. PKG.
12" x 24"		
662610 51676 7	White	5 / 5

Used on hand-held edging machines

To sand areas where the drum/belt sander does not reach



Best choice for overall smoothest finish



RED HEAT H955 PAPER

- 100% patented seeded gel (SG) ceramic grain is super sharp for fast coatings removal while providing longer life and less loading.
- Strong F-weight backing resists tearing.
- Produces a finer scratch pattern.

PART #	GRIT	STD. PKG.
6-7/8" x 7/8"		
662610 55950 9	120	25 / 25
662610 55951 6	100	25 / 25
662610 55952 3	80	25 / 25
662610 55953 0	60	25 / 25
662610 55954 7	50	25 / 25
662610 55955 4	40	25 / 25
662610 55956 1	36	25 / 25

PART #	GRIT	STD. PKG.
7" x 5/16"		
662610 55958 5	120	25 / 25
662610 55959 2	100	25 / 25
662610 55960 8	80	25 / 25
662610 55961 5	60	25 / 25
662610 55962 2	50	25 / 25
662610 55963 9	40	25 / 25
662610 55964 6	36	25 / 25
662610 55965 3	24	25 / 25

PART #	GRIT	STD. PKG.
7" x 7/8"		
662610 55966 0	120	25 / 25
662610 40283 6	100	25 / 25
662610 40284 3	80	25 / 25
662610 40285 0	60	25 / 25
662610 55967 7	50	25 / 25
662610 55968 4	40	25 / 25
662610 40286 7	36	25 / 25
662610 55969 1	24	25 / 25

Better choice for fast cut on hard wood species



BLUEFIRE H831 PAPER

- Next generation Zirconia grain is razor sharp for faster cutting and longer life
- Strong F-weight backing resists tearing
- Leaves a fine scratch pattern for less visible sanding marks
- Anti-static technology resists loading and minimizes airborne dust

PART #	GRIT	STD. PKG.
6-7/8" x 7/8"		
66623319920 3 <i>NS</i>	120	25 / 2000
66623319921 0	100	25 / 25
66623319922 7	80	25 / 25
66623319923 4	60	25 / 25
66623319924 1	50	25 / 25
66623319925 8	40	25 / 25
66623319926 5	36	25 / 25

NS Non-Stock Item

PART #	GRIT	STD. PKG.
7" x 5/16"		
66623319904 3	120	25 / 25
66623319905 0	100	25 / 25
66623319906 7	80	25 / 25
66623319907 4	60	25 / 25
66623319908 1	50	25 / 25
66623319909 8	40	25 / 25
66623319910 4	36	25 / 25
66623319911 1	24	25 / 25

PART #	GRIT	STD. PKG.
7" x 7/8"		
66623319912 8	120	25 / 25
66623319913 5	100	25 / 25
66623319914 2	80	25 / 25
66623319915 9	60	25 / 25
66623319916 6	50	25 / 25
66623319917 3	40	25 / 25
66623319918 0	36	25 / 25
66623319919 7	24	25 / 25

Good choice when value and performance are key



NEON H766 PAPER

- Blend of premium abrasive grains
- Heavy-weight fiber-reinforced backing
- Anti-stat properties providing excellent dust extraction

PART #	GRIT	STD. PKG.
7" x 5/16"		
69957319461 4	120	10 / 100
69957319462 1	100	10 / 100
69957319463 8	80	10 / 100
69957319464 5	60	10 / 100
69957319465 2	50	10 / 100
69957319467 6	40	10 / 50
69957319468 3	36	10 / 50
69957319469 0	24	10 / 50

PART #	GRIT	STD. PKG.
7" x 7/8"		
69957319470 6	120	10 / 100
69957319471 3	100	10 / 100
69957319472 0	80	10 / 100
69957319473 7	60	10 / 100
69957319474 4	50	10 / 100
69957319475 1	40	10 / 50
69957319476 8	36	10 / 50
69957319478 2	24	10 / 50

VALUE AND PERFORMANCE!

The Neon discs are a blend of zirconia alumina and silicon carbide giving it a boost both in cut rate and life. The addition the heavy weight anti-stat backing allows the Neon product to sand much cleaner than other paper discs. We have also offered the Neon Edger discs in 10 packs so you can sell them by the pack or by the full box.



Good choice for quality and consistency



DURITE H425 & S413 PAPER

- 100% silicon carbide abrasive with heavy E, F and combination paper backings for quality cut and strength on the job.
- Traditional abrasive grain provides consistent performance and value at a competitive price.

PART #	GRIT	STD. PKG.
7" x 5/16"		
662611 35063 1	120	100 / 100
662611 35064 8	100	100 / 100
662611 35065 5	80	100 / 100
662611 35066 2	60	100 / 100
662611 35067 9	50	100 / 100
662611 35068 6	40	50 / 50
662611 35069 3	36	50 / 50
662611 35070 9	30	50 / 50
662611 35071 6	24	50 / 50
662611 35072 3	20	50 / 50
662611 35073 0	16	50 / 50
662611 35074 7	12	25 / 25

PART #	GRIT	STD. PKG.
7" x 7/8"		
662611 35075 4	120	100 / 100
662611 35076 1	100	100 / 100
662611 35077 8	80	100 / 100
662611 35078 5	60	100 / 100
662611 35079 2	50	100 / 100
662611 35080 8	40	50 / 50
662611 35081 5	36	50 / 50
662611 35082 2	30	50 / 50
662611 35083 9	24	50 / 50
662611 35084 6	20	50 / 50
662611 35085 3	16	50 / 50
662611 35086 0	12	25 / 25

Best choice for prefinished flooring



BLAZE-X F970 FIBER

- Improved ceramic alumina micro-fracturing grain constantly exposes sharper grain edges to significantly increase cut rate and life
- Heavier fiber backing for additional strength and tear resistance
- Product design is ideal for applications where aggressive cut rate and product life is critical
- Ceramic grain offers super-fine scratch patterns

PART #	GRIT	STD. PKG.
7" x 7/8" (F970)		
699573 70204 8	80	25 / 25
699573 70203 1	60	25 / 25
699573 70202 4	50	25 / 25
699573 70201 7	36	25 / 25

BLAZING THE WAY!

Designed for the most rugged of floor sanding applications, BlazeX fiber discs offer superior cut rates and product life. The stiffer fiber back gives BlazeX an aggressive cut while the ceramic grain gives it a natural super-fine scratch pattern. Whether you are dealing with aluminum oxide coated pre-finished flooring or several layers of hard finish the Norton BlazeX fiber disc will offer the best cut rate and longevity of any product on the market.

Best choice for overall smoothest finish



RED HEAT Q955 SCREEN

- 100% patented SG ceramic grain combined with long life provides a consistent cut and finish over the life of the screen, virtually eliminating the risk of burnishing the wood.

PART #	GRIT	STD. PKG.
5" x 0"		
699573 44606 5 <i>NS</i>	220	20 / 40
699573 44604 1 <i>NS</i>	180	20 / 40
699573 44601 0 <i>NS</i>	150	20 / 40
636425 30594 1 <i>NS</i>	120	20 / 40
636425 30593 4 <i>NS</i>	100	20 / 40
636425 30592 7 <i>NS</i>	80	20 / 40
6" x 0"		
699573 44625 6 <i>NS</i>	220	20 / 40
699573 44620 1 <i>NS</i>	180	20 / 40
699573 44618 8 <i>NS</i>	150	20 / 40
699573 44616 4 <i>NS</i>	120	20 / 40
699573 44615 7 <i>NS</i>	100	20 / 40
699573 44614 0 <i>NS</i>	80	20 / 40

PART #	GRIT	STD. PKG.
7-7/8" x 3/16"		
699573 65332 5 <i>NS</i>	220	40 / 80
662610 81826 2	150	30 / 30
662610 81824 8	120	30 / 30
662610 81822 4	100	30 / 30
662610 81820 0	80	30 / 30

NS Non-Stock Item

PART #	GRIT	STD. PKG.
White SandScreen Driver Pads		
5" x 0"		
699573 45338 4	White	20
6" x 0"		
699573 45342 1	White	20

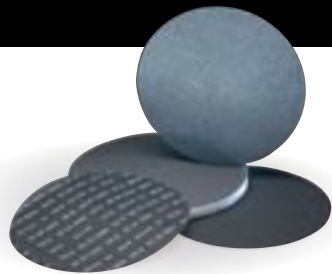

Good choice for performance and value

SCREEN-BAK Q421 SCREEN

- Inter-woven polyester knit backing with abrasive grain on both sides and open mesh for load resistance.
- Rinse and reuse for longer sanding life.
- Cuts more aggressively than paper or cloth.

PART #	GRIT	STD. PKG.
7-7/8" x 3/16"		
662611 23814 4	180	20 / 20
662611 31731 3	150	20 / 20
662611 31732 0	120	20 / 20
662611 31733 7	100	20 / 20
662611 31734 4	80	20 / 20
662611 31730 6	60	20 / 20

PART #	GRIT	STD. PKG.
7" x 5/16"		
662611 31817 4 <i>NS</i>	120	20 / 40
662611 31818 1	100	20 / 20
662611 31819 8	80	20 / 20
662611 19583 6 <i>NS</i>	60	20 / 120

PART #	GRIT	STD. PKG.
7" x 7/8"		
662611 23046 9 <i>NS</i>	150	20 / 120
662611 13130 8 <i>NS</i>	120	20 / 120
662611 31821 1	100	20 / 20
662611 31822 8	80	20 / 20
662611 07073 7	60	20 / 20

NS Non-Stock Item



The ideal choice for a finer finish

NON-WOVEN BACK-UP & CONDITIONING PADS

- Designed to soften the cut of edger disc
- Offer several types of material that vary in density

PART #	GRIT	STD. PKG.
Maroon		
7" x 5/16"		
662610 31815 1	N/W	40 / 40
7" x 7/8"		
662610 31816 8	N/W	40 / 40
7-7/8" x 3/16" Trio		
662610 07703 4	N/W	40 / 40

NS Non-Stock Item

PART #	GRIT	STD. PKG.
White Back-up Pad		
7" x 5/16"		
662610 14022 6 <i>NS</i>	N/W	80 / 80
7" x 7/8"		
662610 02211 9 <i>NS</i>	N/W	100 / 100

TECH TIP

Used with a Conditioning Pad, screens can be an optional step in the edging sequence to provide a much finer finish than a paper disc.



Used for
hard plating

Aggressive cutting
easily blends scratches
from edger and
drum sanders

For final sanding to
prevent dish out of
softer grain

Reduces dish out of
springwood on strip and
plank floors

Ideal for surface prep on
wood and concrete to
remove various residues



Good choice for quality and consistency

DURITE H425 & S413 PAPER

- 100% silicon carbide abrasive with heavy E, F and combination paper backings for quality cut and strength
- Value and consistent performance at a competitive price
- Versatile cut ideal for soft to medium hardness of wood

PART #	GRIT	STD. PKG.
15" x 2"		
662611 131735 1 <i>NS</i>	120	25 / 200
662611 46465 9 <i>NS</i>	100	25 / 200
662611 46470 3 <i>NS</i>	80	25 / 200
662611 104794 4 <i>NS</i>	60	25 / 200
662611 46490 1	36	25 / 25
662611 46505 2 <i>NS</i>	20	25 / 200
662611 46510 6	16	25 / 25
662611 46515 1	12	25 / 25
16" x 2"		
662611 131736 8 <i>NS</i>	120	25 / 200
662611 46585 4	100	25 / 25
662611 46590 8	80	25 / 25
662611 46595 3	60	25 / 25
662611 46600 4	50	25 / 25
662611 46605 9	40	25 / 25
662611 46610 3	36	25 / 25

PART #	GRIT	STD. PKG.
16" x 2" continued		
662611 46615 8	30	25 / 25
662611 101452 6 <i>NS</i>	24	25 / 200
662611 46620 2	20	25 / 25
662611 46625 7	16	25 / 25
662611 46630 1	12	25 / 25
17" x 2"		
662611 131737 5 <i>NS</i>	120	25 / 200
662611 100117 5	100	25 / 25
662611 10792 1	80	25 / 25
662611 100267 7	60	25 / 25
662611 107163 5 <i>NS</i>	50	25 / 100
662611 113134 6 <i>NS</i>	40	25 / 100
662611 100115 1	36	25 / 25
662611 110508 8 <i>NS</i>	24	25 / 100
662611 46680 6	20	25 / 25
662611 100118 2	16	25 / 200
662611 115747 6 <i>NS</i>	12	25 / 200

PART #	GRIT	STD. PKG.
19" x 2"		
662611 103815 7 <i>NS</i>	100	25 / 50
662611 106717 1 <i>NS</i>	80	25 / 50
662611 102001 5 <i>NS</i>	60	25 / 50
662611 113139 1 <i>NS</i>	50	25 / 50
662611 113141 4 <i>NS</i>	40	25 / 50
662611 115764 3 <i>NS</i>	36	25 / 50
662611 146705 6 <i>NS</i>	20	25 / 50
662611 105624 3 <i>NS</i>	16	25 / 100
662611 110401 2 <i>NS</i>	12	25 / 50

NS Non-Stock Item

DURABILITY – THE MARKET STANDARD!

Durite – 100% silicon carbide abrasive with heavy E, F and combination paper backings for quality cut and strength. Value and consistent performance at a competitive price. Ideal for soft to medium hardness of wood.

Good choice when value and performance are key



NEON H766 PAPER

- The Neon discs are a blend of zirconia alumina and silicon carbide giving it a boost both in cut rate and life.
- The addition the heavy weight anti-stat backing allows the Neon product to sand much cleaner than other paper discs.

PART #	GRIT	STD. PKG.
15" x 2"		
69957342096 6 <i>NS</i>	120	25 / 200
69957342100 0 <i>NS</i>	100	25 / 200
69957342101 7 <i>NS</i>	80	25 / 200
69957342107 9 <i>NS</i>	60	25 / 200
69957342108 6 <i>NS</i>	50	25 / 200
69957342109 3 <i>NS</i>	40	25 / 200
69957342121 5	36	25 / 25
69957342122 2 <i>NS</i>	30	25 / 200
69957342123 9 <i>NS</i>	24	25 / 200
16" x 2"		
69957342124 6	120	25 / 25
69957342125 3	100	25 / 25
69957342128 4	80	25 / 25
69957342129 1	60	25 / 25
69957342130 7	50	25 / 25
69957342134 5	40	25 / 25
69957342135 2	36	25 / 25
69957342136 9	30	25 / 25
69957342137 6 <i>NS</i>	24	25 / 200

PART #	GRIT	STD. PKG.
17" x 2"		
69957342138 3 <i>NS</i>	120	25 / 200
69957342139 0	100	25 / 25
69957342140 6	80	25 / 25
69957342149 9	60	25 / 25
69957342153 6 <i>NS</i>	50	25 / 200
69957342155 0 <i>NS</i>	40	25 / 200
69957342161 1	36	25 / 25
69957342167 3 <i>NS</i>	30	25 / 200
69957342168 0 <i>NS</i>	24	25 / 200

PART #	GRIT	STD. PKG.
19" x 2"		
69957342169 7 <i>NS</i>	120	25 / 50
69957342174 1 <i>NS</i>	100	25 / 50
69957342175 8 <i>NS</i>	80	25 / 50
69957342176 5 <i>NS</i>	60	25 / 50
69957342177 2 <i>NS</i>	50	25 / 50
69957342178 9 <i>NS</i>	40	25 / 50
69957342180 2 <i>NS</i>	36	25 / 50
69957342181 9 <i>NS</i>	30	25 / 50
69957342182 6 <i>NS</i>	24	25 / 50

NS Non-Stock Item

Best choice for overall smoothest finish



RED HEAT H955P PAPER

- 100% patented SG (Seeded Gel) ceramic alumina grain with heavy F-weight backing produces a much finer scratch pattern than typical silicon carbide discs
- Ideal for the hardest wood species
- Best choice for parquet and multi-species floors

PART #	GRIT	STD. PKG.
16" x 2"		
66261055759 8 <i>NS</i>	120	10 / 40
66261055760 4	100	10 / 10
66261055762 8 <i>NS</i>	80	10 / 40
66261055827 4	60	10 / 10
66261055828 1	50	10 / 10
66261055829 8 <i>NS</i>	40	10 / 40
66261055830 4 <i>NS</i>	36	10 / 40
66261055831 1	24	10 / 10

NS Non-Stock Item

Additional Sizes Available as Non-Stock:

15" x 2", 16" x 2", 16" x 4", 17" x 2", 19" x 2"
Better Paper and 15" x 2", 17" x 2", 20" x 2"
Good Paper.

Good choice for quality and consistency



DURITE DOUBLE-SIDED H425 & S413 PAPER

- 100% silicon carbide abrasive coated with abrasive on both sides for twice the life, quick switch, no PSA contamination, increased tear resistance.
- Strong E&F weight paper for increased durability.

PART #	GRIT	STD. PKG.
16" Blank Disc		
662611 43128 6	120	10 / 10
662611 43129 3	100	10 / 10
662611 43130 9	80	10 / 10
662611 43131 6	60	10 / 10
662611 43132 3	40	10 / 10
662611 43133 0	36	10 / 10
662611 49150 1	20	10 / 10

PART #	GRIT	STD. PKG.
17" Blank Disc		
662611 49152 5	100	10 / 10
662611 49153 2	80	10 / 10
662611 49154 9	60	10 / 10
662611 49155 6	36	10 / 10

PART #	GRIT	STD. PKG.
20" Blank Disc		
662611 49157 0	80	10 / 10
662611 49059 7 <i>NS</i>	60	10 / 10
662611 49507 3	20	10 / 10

NS Non-Stock Item

TECH TIP

Double-sided discs make hard plating simpler and easier by eliminating the need to mechanically fasten the disc to the bottom of the buffer. When using single sided large discs in hard plating, it is recommended to apply two discs at a time making sure the slots at the center hole of each disc are offset. This will help prevent the disc from prematurely tearing at the center hole.

Always use a screen driver pad with a double sided disc to prevent slippage, and get the flattest surface possible. You can sandwich a screen driver pad between two double sided discs to increase stiffness for an even flatter surface.

Good choice for performance and value

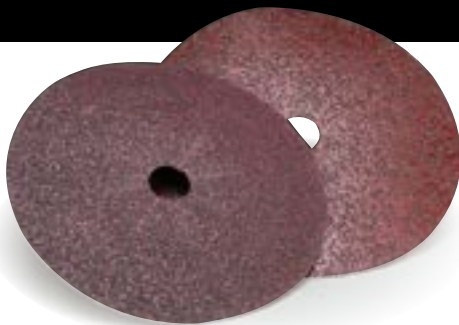

SILICON CARBIDE H422 & S456 PAPER

- 100% silicon carbide abrasive in E-weight and combination backing
- Cost-effective design offers strong performance with outstanding value

PART #	GRIT	STD. PKG.
15" x 2"		
662611 24687 1 <i>NS</i>	100	10 / 40
662611 24686 6 <i>NS</i>	80	10 / 40
662611 35872 9 <i>NS</i>	60	10 / 40
662611 24680 4	36	10 / 10
662611 24636 1	20	10 / 10
662611 24671 2 <i>NS</i>	16	10 / 40
662611 35874 3	12	10 / 10
16" x 2"		
662611 24644 6	100	10 / 10
662611 24665 1	80	10 / 10
662611 24659 0	60	10 / 10
662611 24650 7	36	10 / 10
662611 24637 8	20	10 / 10
662611 24672 9	16	10 / 10
662611 28561 2	12	10 / 10

PART #	GRIT	STD. PKG.
17" x 2"		
662611 24679 8	100	10 / 10
662611 24687 3	80	10 / 10
662611 24684 2	60	10 / 10
662611 24682 8 <i>NS</i>	40	10 / 200
662611 24651 4	36	10 / 10
662611 24638 5	20	10 / 10
662611 24673 6	16	10 / 40
662611 36231 3	12	10 / 10

PART #	GRIT	STD. PKG.
20" x 2"		
662611 35735 7 <i>NS</i>	100	10 / 40
662611 35736 4 <i>NS</i>	80	10 / 50
662611 35737 1	60	10 / 10
662611 39519 9 <i>NS</i>	40	10 / 50
662611 35738 8	36	10 / 10
662611 35739 5	20	10 / 10
662611 35740 1 <i>NS</i>	16	10 / 40
662611 35741 8	12	10 / 10

NS Non-Stock Item

Able to flatten typical overwood with 80 grit or finer

Scratches are much finer than any other product for very easy blending



Best choice for overall smoothest finish



RED HEAT H955 PAPER

- 100% patented SG (Seeded Gel) ceramic grain produces much finer scratch pattern than silicon carbide; extremely sharp, fast cutting and 2-3 times the life of silicon carbide; Perfect on harder wood species
- Inter-woven polyester knit backing and increased durability and life
- Full resin bond and excellent grain retention

PART #	GRIT	STD. PKG.
4" x 0" Hook and Loop (H955)		
77696085539 3 NS	120	30 / 60
77696085783 0 NS	100	30 / 60
77696085785 4 NS	80	30 / 60
77696085786 1 NS	60	30 / 60
77696085787 8 NS	50	30 / 60
77696085788 5 NS	40	30 / 60
77696085789 2 NS	36	30 / 60
77696085790 8 NS	24	30 / 60
5" x 0" Hook and Loop (H955)		
66254440813 3	120	50 / 250
66261069004 2	100	50 / 250
66261069003 5	80	50 / 250
66254440811 9	60	50 / 250
66254440810 2	50	50 / 50
66254408866 3	40	50 / 50
66254440809 6	36	50 / 50

PART #	GRIT	STD. PKG.
5-7/8" x 0" Hook and Loop (H955)		
66261078093 4	120	25 / 25
66261078094 4	100	25 / 25
66261078095 1	80	25 / 25
66261078096 8	60	25 / 25
66261078097 5	50	25 / 25
66261078098 2	40	25 / 25
66261078099 9	36	25 / 25
66261078100 6	24	25 / 25
6" x 0" Hook and Loop (H955)		
66261159696 1	P120	40 / 40
66261159697 8	P100	40 / 40
66261159699 2	P80	40 / 40
66261159700 5	P60	40 / 40
66261159701 2	P50	40 / 40
66261159702 9	P40	40 / 40
66261159703 6	P36	40 / 40
66261159704 3	P24	40 / 40

PART #	GRIT	STD. PKG.
7" x 0" Hook and Loop (H955)		
66261078101 6 NS	120	25 / 25
66261078102 3	100	25 / 25
66261078103 0	80	25 / 25
66261078104 7	60	25 / 25
66261078105 4	50	25 / 25
66261078106 1	40	25 / 25
66261078107 8	36	25 / 25
66261078108 5	24	25 / 25
8" x 0" Hook and Loop (H955)		
66261078109 2	120	30 / 30
66261078110 8	100	30 / 30
66261078111 5	80	30 / 30
66261078112 2	60	30 / 30
66261078113 9	50	30 / 30
66261078114 6	40	30 / 30
66261078115 3	36	30 / 30
66261078116 0 NS	24	30 / 120

NS Non-Stock Item

SHIFT INTO HIGH GEAR!

100% patented SG (Seeded Gel) ceramic alumina abrasive for longest life, fastest cut and more consistent finish. Tough F-weight backing is extremely flexible and shock absorbent for extreme conditions. No risk of color transfer with assured color consistency. Ideal for larger jobs and harder A/O finishes.

Better choice for fast cut on hard wood species

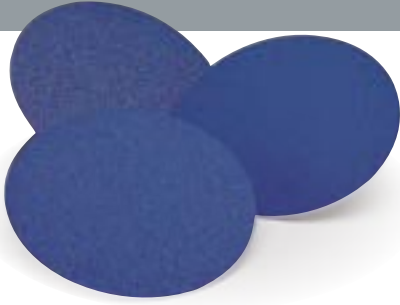

BLUEFIRE H831 PAPER

- Next generation of patented, premium, self-sharpening, 100% zirconia alumina abrasive for longer life, faster cut and outstanding durability
- The anti-static technology increases dust collection efficiency for a cleaner working environment
- The improved resin bond ensures grain retention under the most demanding applications
- And, the consistent scratch pattern means the finest finish of the floor

PART #	GRIT	STD. PKG.
5-7/8" x 0		
66623319928 9 <i>NS</i>	120	25 / 400
66623319929 6	100	25 / 100
66623319930 2	80	25 / 100
66623319931 9	60	25 / 100
66623319932 6	50	25 / 100
66623319933 3	40	25 / 100
66623319934 0	36	25 / 100
66623319935 7 <i>NS</i>	24	25 / 400
6" x 0 U-Sand		
66623374353 6	120	25 / 25
66623374354 3	100	25 / 25
66623374355 0	80	25 / 25
66623374356 7	60	25 / 25
66623374357 4	50	25 / 25
66623374358 1	40	25 / 25
66623374359 8	36	25 / 25
66623374360 4	24	25 / 25

PART #	GRIT	STD. PKG.
6"-7/8" x 0" EZ Sand		
66623319936 4 <i>NS</i>	120	25 / 400
66623319937 1	100	25 / 100
66623319938 8	80	25 / 100
66623319939 5	60	25 / 100
66623319940 1	50	25 / 100
66623319941 8	40	25 / 100
66623319942 5	36	25 / 100
7" x 0		
66623374344 4	120	25 / 25
66623374345 1	100	25 / 25
66623374346 8	80	25 / 25
66623374347 5	60	25 / 25
66623374349 9	50	25 / 25
66623374350 5	40	25 / 25
66623374351 2	36	25 / 25
66623374352 9	24	25 / 25

PART #	GRIT	STD. PKG.
8" x 0 Trio		
66623374361 1	120	25 / 100
66623374362 8	100	25 / 100
66623374363 5	80	25 / 100
66623374364 2	60	25 / 100
66623374365 9	50	25 / 100
66623374366 6	40	25 / 100
66623374367 3	36	25 / 100
Conversion Pads		
7" x 5/16"		
66261149716 9		5 / 5
7" x 7/8"		
66261149717 6		5 / 5
<i>NS Non-Stock</i>		



TECH TIP

Multi-Disc Machine Guide

DISC SIZE	MACHINE
4" x 0"	Satellite
5" x 0"	Bona Multi Disc, Clarke HydraSand
5-7/8" x 0"	Bona Power Drive
6" x 0"	U-Sand
6-7/8" x 0"	Clarke EZ Sand
8" x 0"	Trio, Clarke 3DS

Edger Disc Machine Guide

DISC SIZE	MACHINE
4" x 0"	Bona Dual Edge
5-7/8" x 0"	Flip, Elan, Bona Mini Edge
7" x 0"	Unico, Bona Edge

Best choice for powerful dust extraction



MESHPower CERAMIC MESH

- Mesh backing for optimum dust extraction
- Full ceramic grain for excellent cut rates and superior scratch pattern
- Hook and loop design ideal for random orbital sanders as well as multi-head equipment and standard rotary buffers
- Product design delivers extensive product life

PART #	GRIT	STD. PKG.
5" Ceramic Hook & Loop Discs – Job Pack		
07660768444	8	320 50 / 200
07660768445	5	220 50 / 200
07660768446	2	180 50 / 200
07660768447	9	150 50 / 200
07660768448	6	120 50 / 200
07660768449	3	100 50 / 200
07660768450	9	80 50 / 200
6" Ceramic Hook & Loop Discs – Bulk		
66261170640	7	220 50 / 50
66261170641	4	180 50 / 50
66261170642	1	150 50 / 50
66261170643	8	120 50 / 50
66261170644	5	100 50 / 50
66261170645	2	80 50 / 50
8" Ceramic Hook & Loop Discs – Bulk		
66261170646	9	220 30 / 30
66261170647	6	180 30 / 30
66261170648	3	150 30 / 30
66261170649	0	120 30 / 30
77696099000	1	100 30 / 30
77696099001	8	80 30 / 30

PART #	GRIT	STD. PKG.
16" Ceramic Hook & Loop Discs		
77696099002	5	220 10 / 10
77696099003	2	180 10 / 10
77696099004	9	150 10 / 10
77696099005	6	120 10 / 10
77696099006	3	100 10 / 10
77696099007	0	80 10 / 10

Powerful Dust Extraction Means a Cleaner Environment

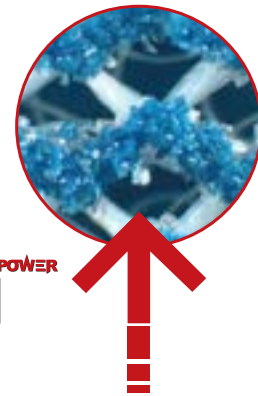
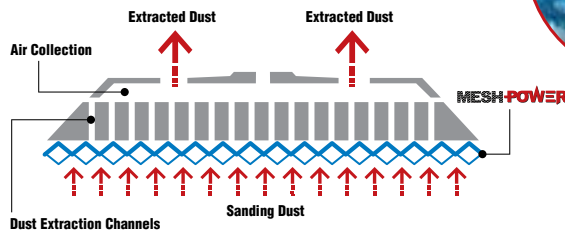

FOR A BREATH OF FRESH AIR

The new Norton MeshPower discs are fully ceramic products designed for both raw wood sanding as well as between coat abrasion. The robust product design allows the MeshPower disc to sand for extended periods of time while delivering super-fast cut and an extremely fine scratch pattern.

The discs can be used on a variety of equipment including: random orbital sanders, multi-head rotary attachments and 16" buffers under a driver pad such as our Norton Very Fine Dark Maroon Pad.

The fully mesh backing design offers superior dust extraction and is ideal where you want an aggressive cutting action but really fine scratch pattern. The built-in hook and loop backing makes attaching the discs to the driver plates quick and easy.



Ideal for removing edger marks and sanding stair treads

Orbital discs are used on hand-held machines for final sanding of edges and stair treads



universally DUST FREE!

- Spiral-hole hook & loop vacuum design removes material consistently while maximizing dust extraction for a cleaner work environment
- Features a No-Fil coating to resist clogging/loading during sanding
- Specialized multi-hole pattern allows for use on any random orbital sander regardless of hole pattern – including unique Festool* sander models
- Unique fiber-reinforced latex/paper backing is flexible, strong, and tear-resistant

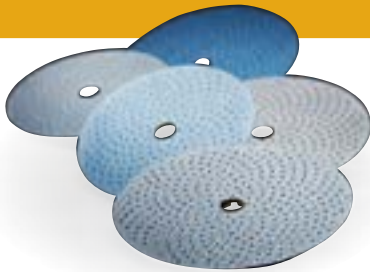

Best choice for pro results with a power tool

PROSAND MULTI-AIR CYCLONIC

- Premium ceramic alumina abrasive provides superior cut on all surfaces, lasts substantially longer and cuts faster than conventional abrasives and has been open coated to resist clogging and loading during sanding
- Universal multi-hole pattern fits all 5" and 6" random orbital sanders.
- Ideal for tight spots and stair treads.

PART #	GRIT	STD. PKG.
5" x Multi-Hole Hook & Sand		
07660704041 1	P320	50 / 200
07660704038 1	P220	50 / 200
07660704037 4	P180	50 / 200
07660704036 7	P150	50 / 200
07660704035 0	P120	50 / 200
07660704034 3	P100	50 / 200
07660704033 6	P80	50 / 200
66623374368 0	P60	50 / 200
07660768279 6	P40	50 / 200

PART #	GRIT	STD. PKG.
6" x Multi-Hole Hook & Sand		
07660705483 8 <i>NS</i>	P320	50 / 2000
07660705484 5	P220	50 / 200
07660705486 9	P150	50 / 200
07660705487 6	P120	50 / 200
07660705488 3	P100	50 / 200
07660705489 0	P80	50 / 200
07660705490 6	P60	50 / 200

NS Non-Stock Item

Orbital Disc Grit Guide

GRIT	BASIC APPLICATION
Extra Fine (320)	For primer, sealer and between coats sanding
Very Fine (220)	For very fine sanding of bare surfaces, primer and sealer sanding
Fine (180)	For finish sanding and cleaning of bare surfaces
Medium (150/120/100)	For light removal and smoothing of bare surfaces
Coarse (80/60)	For moderate removal and levelling of surface imperfections



Best choice for fastest cut

BLAZE A995 MULTI-AIR CYCLONIC

- Super tough backing
- Premium blend of ceramic grain
- Ultra-fine scratch pattern

PART #	GRIT	STD. PKG.
5" x Multi-Hole Hook & Sand		
636425 97504 5	220	50 / 200
636425 97503 8	180	50 / 200
636425 97502 1	150	50 / 200
636425 97501 4	120	50 / 200
699573 67757 5	100	50 / 200
636425 97500 7	80	50 / 200

PART #	GRIT	STD. PKG.
6" x Multi-Hole Hook & Sand		
636425 97509 0	220	50 / 200
636425 97508 3	180	50 / 200
636425 97507 6	150	50 / 200
636425 97506 9	120	50 / 200
699573 67758 2	100	50 / 200
636425 97505 2	80	50 / 200

ULTIMATE STRENGTH – NO MORE WEAR AND TEAR

An all-new exclusive backing design provides extraordinary strength with tear resistance well beyond any flexible paper disc in the market, as much 2-3X. This super-tough, polyester-reinforced D-weight hook & loop backing means exceptional edge adhesion of the grain even in the most demanding floorsanding applications; so, grain shed is virtually non-existent and the result is outstanding durability.



TECH TIP

To remove swirl marks left from edging. Consider sanding the edges with an orbital sander. For best results and to avoid halos, use the same grit on the orbital sander as you previously used on the edger. The super sharp ceramic alumina grain will easily remove edger marks and produce a scratch free finish.

Used for final sanding to blend sanding marks from edger and belt/drum sander

Always use a screen driver pad to prevent screen slippage and to maximize performance



Best choice for overall smoothest finish



RED HEAT Q955 SCREEN

- 100% patented SG ceramic grain
- Extremely sharp and fast cutting
- 2-3 times the life of Silicon Carbide
- Produces a finer scratch pattern than Silicon Carbide minimizing swirl marks

PART #	GRIT	STD. PKG.
15" Diameter		
636425 77090 9 <i>NS</i>	180	10 / 40
662610 26292 8 <i>NS</i>	150	10 / 40
662610 26293 5 <i>NS</i>	120	10 / 40
662610 26295 9 <i>NS</i>	100	10 / 40
662610 26296 6	80	10 / 10
16" Diameter		
662610 71018 4	220	10 / 10
662610 71017 7	180	10 / 10
662610 26297 3	150	10 / 10
662610 26299 7	120	10 / 10
662610 26300 0	100	10 / 10
662610 26301 7	80	10 / 10

PART #	GRIT	STD. PKG.
17" Diameter		
662544 80746 2 <i>NS</i>	220	10 / 20
662610 26302 4	150	10 / 10
662610 26303 1	120	10 / 10
662610 26304 8	100	10 / 10
662610 26305 5	80	10 / 10
18" Diameter		
662544 80747 9 <i>NS</i>	220	10 / 40
776960 68696 6 <i>NS</i>	180	10 / 40
662610 26306 2 <i>NS</i>	150	10 / 40
662610 26307 9 <i>NS</i>	120	10 / 40
662610 26308 6 <i>NS</i>	100	10 / 40
662610 26309 3 <i>NS</i>	80	10 / 10

PART #	GRIT	STD. PKG.
20" Diameter		
662544 80748 6	220	10 / 10
666233 04169 4	180	10 / 10
662610 26311 6	150	10 / 10
662610 26312 3	120	10 / 10
662610 26313 0	100	10 / 10
662610 26314 7	80	10 / 10

NS Non-Stock

SMOOTH FINISH FROM THE START!

100% patented SG (Seeded Gel) ceramic alumina abrasive for longest life, fastest cut and more consistent finish. Tough F-weight backing is extremely flexible and shock absorbent for extreme conditions. No risk of color transfer with assured color consistency. Ideal for larger jobs and harder A/O finishes.

Good choice for quality and consistency



DURITE Q421 SCREEN

- 100% Silicon Carbide grain bonded to an inter-woven polyester knit backing provides increased durability and life
- Full resin bond provides excellent grain retention

PART #	GRIT	STD. PKG.
15" Diameter		
66261121490 2	220	10 / 10
66261120508 5	180	10 / 10
66261120509 2	150	10 / 10
66261120510 8	120	10 / 10
66261120511 5	100	10 / 10
66261120512 2	80	10 / 10
66261120513 9	60	10 / 10
16" Diameter		
66261123032 2	220	10 / 10
66261120514 6	180	10 / 10
66261120515 3	150	10 / 10
66261120516 0	120	10 / 10
66261120517 7	100	10 / 10
66261120518 4	80	10 / 10
66261120519 1	60	10 / 10

PART #	GRIT	STD. PKG.
17" Diameter		
66261131726 9 <i>NS</i>	220	10 / 20
66261120520 7	180	10 / 10
66261120521 4	150	10 / 10
66261120522 1	120	10 / 10
66261120523 8	100	10 / 10
66261120524 5	80	10 / 10
66261120525 2	60	10 / 10
18" Diameter		
66261131727 6	220	10 / 10
66261120526 9	180	10 / 10
66261120527 6	150	10 / 10
66261120528 3	120	10 / 10
66261120529 0	100	10 / 10
66261120530 6	80	10 / 10
66261120531 3	60	10 / 10

PART #	GRIT	STD. PKG.
19" Diameter		
66261120532 0 <i>NS</i>	180	10 / 20
66261120533 7 <i>NS</i>	150	10 / 20
66261120534 4 <i>NS</i>	120	10 / 20
66261120535 1	100	10 / 10
66261120536 8	80	10 / 10
66261120537 5	60	10 / 10
20" Diameter		
66261143724 0 <i>NS</i>	220	10 / 20
66261120538 2 <i>NS</i>	180	10 / 10
66261120539 9	150	10 / 10
66261120540 5	120	10 / 10
66261120541 2	100	10 / 10
66261120542 9	80	10 / 10
66261120543 6	60	10 / 10

NS Non-Stock

Good choice for performance and value

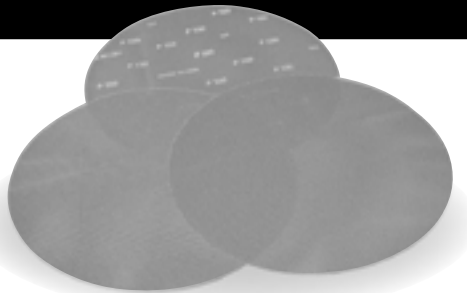

SILICON CARBIDE Q425 SCREEN

- Silicon Carbide abrasive in a cost effective design offers outstanding combination of performance and value

PART #	GRIT	STD. PKG.
15" Diameter		
66261157321 4 <i>WSL</i>	120	10 / 10
66261157320 7 <i>WSL</i>	100	10 / 40
66261157319 1 <i>WSL</i>	80	10 / 20
16" Diameter		
66261148894 2	220	10 / 10
66261148895 6	180	10 / 10
66261148896 3	150	10 / 10
66261148897 0	120	10 / 10
66261148898 7	100	10 / 10
66261148899 4	80	10 / 10
66261148900 1	60	10 / 10

PART #	GRIT	STD. PKG.
17" Diameter		
66261148901 7	180	10 / 10
66261148902 4	150	10 / 10
66261148903 1	120	10 / 10
66261148904 8	100	10 / 10
66261148905 5	80	10 / 10
66261148906 2	60	10 / 10
18" Diameter		
66261157331 3	120	10 / 10
66261148907 0	100	10 / 10
66261148908 6	80	10 / 10
66261148909 3	60	10 / 10

PART #	GRIT	STD. PKG.
19" Diameter		
66261157335 5 <i>NS</i>	120	10 / 40
66261157334 2 <i>NS</i>	100	10 / 20
66261157333 9	80	10 / 10
66261157332 6	60	10 / 10
20" Diameter		
66261157342 7	220	10 / 10
66261157341 0	180	10 / 10
66261157340 3	150	10 / 10
66261148910 5	120	10 / 10
66261148911 2	100	10 / 10
66261148912 9	80	10 / 10
66261148913 6	60	10 / 10

NS Non-Stock WSL While Supplies Last

Best choice for driving screen discs



SCREEN DRIVER PADS

- Designed specifically for driving sanding screens and double sided discs
- Unique design prevents slippage which improves screen/disc life, cut, and finish
- Minimizes dish out of soft grain
- Can be used to buff on stain under a rotary buffer. The pad will hold and disperse stain evenly over the floor without slinging.

PART #	GRIT	STD. PKG.
15" x 1/4" Diameter		
66261018833 4	White	10 / 10
16" x 1/4" Diameter		
66261016968 6	White	10 / 10

PART #	GRIT	STD. PKG.
17" x 1/4" Diameter		
66261017116 3	White	10 / 10
20" x 1/4" Diameter		
66261017118 6	White	10 / 10



Used for multiple levels of surface blending on hardwood floors

Used between coats of finish to give the surface a texture to adhere to

Used to remove dust particles and raised fibers between coats

patented FOAM DESIGN!

The new way to sand between coats of finish. Unique pending design allows you to smooth and prep the surface of the floor to properly accept the next coat of finish without the risk of nasty swirl marks. Four grits – coarse, medium, fine and very fine – accommodate any application. The foam backing pad allows the product to abrade the surface without penetrating deep into the finish, resulting in a smoother overall floor.

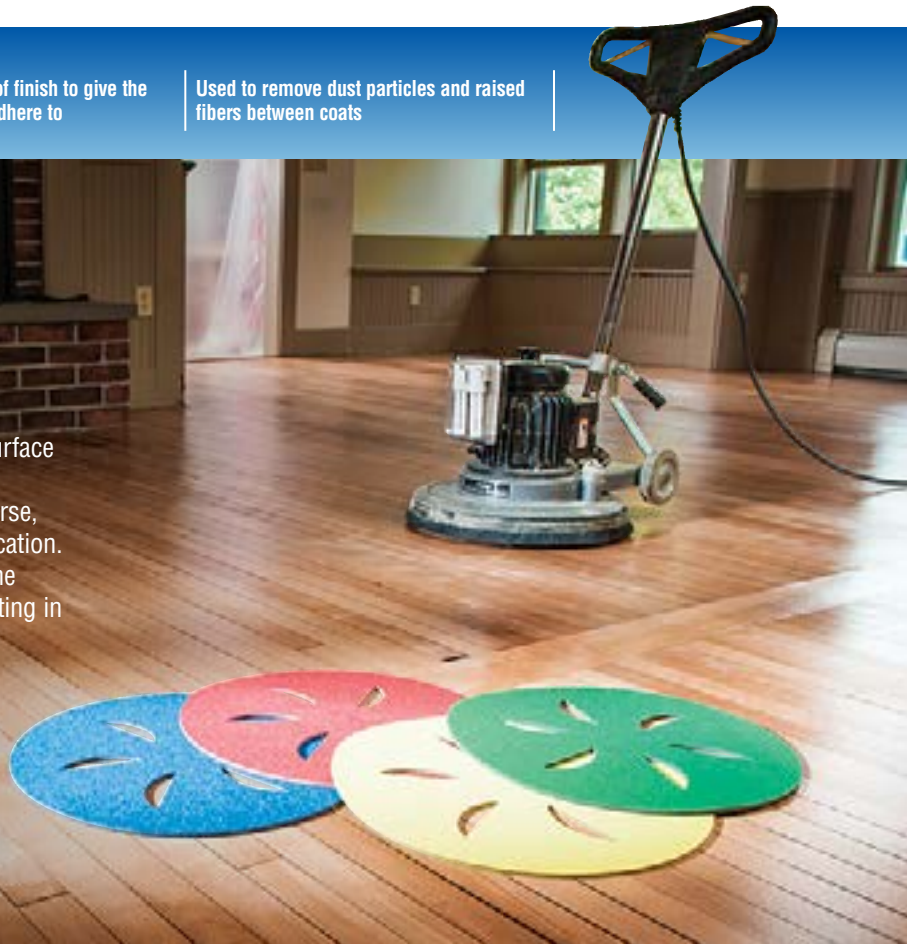

Application Guide

BETWEEN COATS APPLICATION	SANDDOLLAR PADS
Surface Prep / Re coat Heavy Scratches	Blue or Red
Surface Prep / Re coat Light Scratches	Red
Sealer Coat Solvent Base	Blue
Sealer Coat Water Base	Red
Finish Coat Solvent Base	Red or Yellow
Finish Coat Water Base	Yellow or Green

TECH TIP

Don't over use your abrasive product when abrading between coats of finish. A worn out abrasive will still dull the surface, but it may not be putting the proper scratch into the finish to get a good mechanical bond for the next coat of finish.

If the surface isn't abraded properly, you can wind up with finish peeling, flaking and chipping. It's a lot less expensive to use a few more abrasive products on the job than to go and re-sand a job because of finish failure.

Best choice for eliminating scratches between coats



SANDDOLLAR PADS

- Norton SandDollar foam pads have a long life - approximately 1500 ft/pad
- Pads are extremely durable and tear resistant
- Design virtually eliminates the chance of cutting through the finish

PART #	GRIT	STD. PKG.
16" Diameter		
66261194117	4 Very Fine / Green	4 / 4
66261194115	0 Fine / Yellow	4 / 4
66261194114	3 Medium / Red	4 / 4
66261194109	9 Coarse / Blue	4 / 4
66261194874	6 Asst. / 1 of each color	4 / 4

PART #	GRIT	STD. PKG.
16" Diameter (Bulk)		
66261102209	5 NS Very Fine / Green	90 / 90
66261102208	8 NS Fine / Yellow	90 / 90
66261102207	1 NS Medium / Red	90 / 90
66261102206	4 NS Coarse / Blue	90 / 90
20" Diameter		
66261106348	7 Fine/Yellow	4 / 4
66623383384	8 Medium / Red	4 / 4
66623398561	5 Coarse / Blue	4 / 4

PART #	GRIT	STD. PKG.
14" x 20"		
77696084091	7 NS Medium / Red	4 / 4
77696084095	5 NS Coarse / Blue	4 / 4
14" x 28"		
77696089042	4 NS Medium / Red	8 / 8
77696089043	1 NS Coarse / Blue	8 / 8

NS Non-Stock

Good choice for abrading between coats of finish



NON-WOVEN CONDITIONING PADS

- These 1/4" thick pads are manufactured with the finest fibers, resins and abrasives
- The unique design of this pad has a perforated 7" disc that is easily removed for use on an edger machine or simply as a hand pad
- Use a maroon conditioning pad in conjunction with our aluminum oxide PSA sheet roll, applied in strips to the pad; this combination is especially effective on water-based finishes where screening takes away too much finish

ALUMINUM OXIDE PSA SHEET ROLLS

- Use a maroon conditioning pad in conjunction with our aluminum oxide PSA sheet roll, applied in strips to the pad
- This combination is especially effective on water-based finishes where screening will take away too much finish.

CERAMIC ALUMINA PSA SHEET ROLLS

- Use a maroon conditioning pad in conjunction with our ceramic alumina PSA sheet roll, applied in strips to the pad
- The ceramic grain allows for extra-long life and super-fine scratch pattern

Application Guide

BETWEEN COATS APPLICATION	DARK MAROON PAD AND PSA SHEETS
Surface Prep / Re-coat Light Scratches	Pad w/ 150 Grit PSA
Sealer Coat Solvent Base	Pad w/ 150 Grit PSA
Sealer Coat Water Base	Pad w/ 150 or 180 Grit PSA
Finish Coat Solvent Base	Pad w/ 150 or 180 Grit PSA
Finish Coat Water Base	Pad w/ 220 or 240 Grit PSA

PART #	GRIT/COLOR	STD. PKG.
Non-Woven Conditioning Pads		
16" Diameter		
66261002054	2 Ultra Fine / Gray	10 / 10
66261002055	9 Very Fine / Dark Maroon	10 / 10
66261002056	6 Medium / Maroon	10 / 10
18" Diameter		
66261002218	8 Very Fine / Dark Maroon	10 / 10
66261002220	1 NS Medium / Maroon	10 / 10
19" Diameter		
66261019794	7 NS Very Fine / Dark Maroon	10 / 10
20" Diameter		
66261015083	6 NS Ultra Fine / Gray	10 / 100
66261014691	4 Very Fine / Dark Maroon	10 / 10
66261015689	0 NS Medium / Maroon	10 / 10

NS Non-Stock

PART #	GRIT	STD. PKG.
Aluminum Oxide PSA Sheet Rolls – A275		
2-3/4" x 30 yards		
66261131689	7 120	1 / 5
66261131690	3 100	1 / 5
2-3/4" x 45 yards		
66261131681	1 400	1 / 5
66261131683	5 320	1 / 5
66261131685	9 240	1 / 5
66261131686	6 220	1 / 5
66261131687	3 180	1 / 5
66261131688	0 150	1 / 5
Ceramic Alumina PSA Sheet Rolls – A975		
2-3/4" x 30 yards		
66261149564	6 120	1 / 5
2-3/4" x 45 yards		
66261149558	5 320	1 / 5
66261149561	5 220	1 / 5
66261149562	2 180	1 / 5



Good choice for cleaning or polishing floors

CLEAN & PREP PADS

- Provides a deeper cleaning than a standard maroon pad
- 16" Disc has a perforated 7" disc that can be removed and used on an edger machine
- Can be used to abrade between coats of oil or water based finish.

PART #	GRIT	STD. PKG.
16" Diameter		
66261170589	9 Medium	10 / 10
17" Diameter		
66261170590	5 Medium	10 / 10
20" Diameter		
66261170591	2 Medium	10 / 10

Good choice for cleaning or polishing floors



BUFFING PADS

- **RED BUFFER PAD:** Generally used where a high gloss finish is desired when dry or spray buffing. It can also be used for light cleaning applications.
- **WHITE SUPER GLOSS PAD:** A non-abrasive polishing/buffing pad, used dry or with a fine mist to yield a mirror gloss shine.

PART #	SIZE	STD. PKG.
Red Buffer		
662610 54275 4	16"	5 / 5
662610 54276 1	17"	5 / 5
662610 54277 8	18"	5 / 5
662610 54278 5	19"	5 / 5
662610 54279 2	20"	5 / 5

PART #	SIZE	STD. PKG.
White Super Gloss		
662611 41782 2	16" High Density	5 / 5
662610 54208 2	16"	5 / 5
662610 54209 9	17"	5 / 5
662610 54210 5	18"	5 / 5
662610 54211 2	19"	5 / 5
776960 95438 6	20" High Density	5 / 5
662610 54212 9	20"	5 / 5

Additional Sizes Available as Non-Stock:
21" up to 32"

Additional Pads Available:
Stripping Pads - Ultra Blue, High Pro Black, and Black Super Strip



Ideal for fine sanding flat, contoured, round and curved surfaces

ROTOLO PRE-CUT FOAM SANDING PADS

- A275 (premium P-graded, aluminum oxide grain with No-Fil coating) on Rotolo foam backing is: perfect for hand sanding without leaving finger marks; provides outstanding finish on wood, metal, and composites, and primers, sealers and top coats; fast cutting and long life without loading; compatible with all coatings; 50% – 60% improvement in tear strength
- 4-1/2" wide x 82' long roll perforated every 5-1/2" – Standard 1/4 sheet size for hand or machine sanding; 178 sheets per roll
- Convenient dispensing box that protects A275 Rotolo foam from damage

PART #	SIZE	STD. PKG.
A275 OP Foam Sanding Pads		
636425 57616 7	P1000	2
636425 57613 6	P800	2
636425 57612 9	P600	2
636425 57611 2	P500	2
636425 57608 2	P400	2
636425 57606 8	P320	2
636425 57604 4	P280	2
636425 57602 0	P240	2
636425 57600 6	P220	2
636425 57599 3	P180	2
636425 57584 9	P150	2
636425 35316 4	P120	2

Application / Grit Recommendation Guide

GRIT	APPLICATION
P120, P150, P180	Cleaning/repairing minor defects, removing putty and fillers
P220, P240, P280	Final sanding and removing coarse grit scratches
P320, P400	Feather edging, scuffing primer or new parts before painting, sealer sanding
P500, P600	Final sanding for base coat, between coat sanding of top coats
P800, P1000	Sanding clear coats to remove minor defects

FOR OUTSTANDING FINISHES!

Rotolo foam pre-cut sheets, are ideal for fine sanding flat, contoured, round and curved surfaces. The combination of high-performance A275 non-loading sandpaper and the special Rotolo foam backing makes this product ideal for sanding waterborne and solvent-based coatings where controlling cut and generating a uniform consistent finish is critical.

Excellent assortment for all applications and types of finish

Trim pads are hook & loop making application and removal simple and easy

Lamb's wool pads tie on instead of clamping making application and removal simple and easy.



Four applicator options to give you the finished look your customers demand

FLOOR FINISH APPLICATORS



- **LAMB'S WOOL BLOCKS AND REFILL PADS:** Our synthetic lamb's wool blocks and refill pads are made out of high quality material to ensure an excellent coating of finish. The refill pads include a drawstring that is tied around the block making the attachment/removal of the lamb's wool refill pad a snap saving time and money.
- **TRIM TOOL AND REFILL PADS:** The trim tool and refill pads use a unique hook and loop application making the attachment and removal of the pad easy and safe. No more worrying about the pad sliding out of the holder. It makes cleaning the pads much easier. The tool itself is designed with a low-profile "button" style handle that allows you to hand apply finish into tight areas. Moreover, you can detach the handle to get to the threaded portion of the tool to attach a pole.
- **T-BARS AND SLEEVES:** Our durable and rugged T-bar construction is designed for longevity. The in-line swivel makes turning and pulling finish easier and smoother. The rugged pole attachment design will work with most any pole. Our T-bar sleeves are comprised of high-end flocking material along with durable tubing to give you a long lasting and consistent product. Each cover is a half an inch longer than the T-bar itself giving you an area to grab onto the cover and pull it off easily.
- **ROLLER COVERS AND CAGE:** We are offering our roller covers in both micro-fiber and mohair to accommodate most floor finishes. Our non-shedding roller covers are designed to offer a smooth and consistent coating of finish. The roller cage itself utilizes a smoother rolling mechanism creating a very smooth rolling application.

PART #	DESCRIPTION	CASE QTY.
Wood Block Applicator		
66261170583	7 10"	16
66261170584	4 12"	16
66261170585	1 14"	8
66261170586	8 16"	8
Synthetic Lamb's Wool Refill Pad		
66261170579	0 10"	20
66261170580	6 12"	20
66261170581	3 14"	20
66261170582	0 16"	20

PART #	DESCRIPTION	CASE QTY.
Trim Tool and Refill Pads		
66261170572	1 9" Trim tool & pad	10
66261170573	8 9" Trim pad refill	36
T-Bars		
66261170626	1 12"	20
66261170627	8 18"	20
T-Bar Sleeves		
66261170576	9 12"	8
66261170577	6 18"	8
66261170578	3 24"	8

PART #	DESCRIPTION	CASE QTY.
Roller Covers and Cage		
66261170574	5 9" - 1/4" Microfiber	12
66261170575	2 9" - 3/8" Microfiber	12
66261170587	5 9" - 1/4" Mohair	12
66261170588	2 9" Roller Cage	12

Faster cutting and consistent blade sharpening



HAND SCRAPER / SHARPENER KIT

- Comes with a custom sharpening jig which provides a super-sharp and consistent blade while eliminating the dangers of sharpening with a file by hand
- Ergonomic handle provides a comfortable feel and its flex allows for maximum scraping capacity
- To sharpen blade simply attach to the guide rod of the sharpening jig; a few passes and its ready to go
- The kit comes with two handles and two blades (one 3/4" and one 1-1/2.); replacement blades are sold separately

PART #	DESCRIPTION	STD. PKG.
Hand Scraper / Sharpener Kit		
66261170592 9	Scraper Kit	1 / 12
66261170625 4	Replacement Blades	25 / 25

Ideal choice for masking and hanging plastic sheeting for dust control



PRO GAME LINE TAPE

- This premium grade tape is specifically designed for all your game line and striping needs
- The tape exhibits excellent edge block while completely releasing from the floor when removed leaving no residue
- Flexible, tough backing allows the tape to turn easily while not tearing during application or removal
- It also works extremely well in conjunction with plastic sheeting for dust control

PART #	SIZE	STD. PKG.
60 Yard Rolls		
07660768301 3	.70"	48
07660768302 9	.94"	36

PART #	SIZE	STD. PKG.
60 Yard Rolls		
07660768303 2	1.41"	24
07660768304 8	1.89"	24

Ideal for masking and hanging plastic sheeting for dust control



PREMIUM GRADE CLEAN RELEASE TAPE

- Premium grade, clean-release tape meets or exceeds market standards
- Available in various widths for maximum versatility
- Medium adhesion masking means just enough tackiness to stick well to surfaces without the risk of pulling off point from the wall or leaving adhesive behind

PART #	SIZE	STD. PKG.
60 Yard Rolls		
07660702450 3	3/4"	48
07660702451 0	1"	36

PART #	SIZE	STD. PKG.
60 Yard Rolls		
07660702452 7	1-1/2"	24
07660702453 4	2"	24

Ideal for dust control



PLASTIC SHEETING

- Our multi-purpose plastic sheeting protects virtually any area from sanding dust
- Its tough .31 mil. High-Density Polyethylene (HDPE) plastic resists tearing
- Natural electrostatic properties allow it to cling to vertical surfaces during taping
- Attracts and holds sanding dust for a cleaner work environment.

PART #	SIZE	STD. PKG.
07660768142 3	9' x 400' - .31 mil.	1 / 1

PART #	SIZE	STD. PKG.
07660768143 0	12' x 400' - .31 mil.	1 / 1

Good choice for board repairs



EPOXY/KIT/GUN/NOZZLES

- Five minute open time ideal for all board repairs
- Clear adhesive – excellent for knot and defect repair
- 1-1/2" needle for hollow board repair;
- Sseveral nozzles and needles for multiple use
- Quick, cost-efficient, and easy-to-use dispensing gun is also available

PART #	QTY/PACK	PACKS/CASE
Fast Set Epoxy Kit		
662611 70630 8	1	6
Hardwood Floor Epoxy		
776960 99008 7	1	6

PART #	QTY/PACK	PACKS/CASE
Dispensing Gun		
662611 70631 5	1	10
Mixing Nozzles		
662611 70633 9	10	10

Good choice for dust tacking



MICROFIBER CLOTHS

- Microfiber Cloths have edges that collect debris as opposed to pushing it away and can be washed up to 300 times
- Cleaning Cloth (Blue) is used for general wet or dry cleaning applications
- Dry Tack Cloth (Red) has a low profile to resist snagging and pick up embedded debris
- Polishing Cloth (Yellow) is ideal for streak free cleaning of mirrors and optical lenses.

PART #	SIZE	STD. PKG.
Cleaning Cloth (Blue)		
076607 05300 8	16" x 16"	20 / 20

PART #	SIZE	STD. PKG.
Dry Tack Cloth (Red)		
076607 04025 1	16" x 16"	20 / 20

PART #	SIZE	STD. PKG.
Polishing Cloth (Yellow)		
076607 05301 5	16" x 16"	20 / 20

Good choice for hand protection



DISPOSABLE GLOVES

- Norton nitrile disposable gloves provide options for safety and comfort while tackling even the toughest repair jobs
- Available in a full range of styles and sizes, from the economical blue 4mil nitrile gloves ideal for smaller projects to the textured orange 7 mil nitrile gloves featuring "diamond" textured pattern with excellent gripping properties

PART #	SIZE	PIECES/PACK	PACKS/CASE
Blue - General-Purpose (4 mil.) Nitrile			
666233 90700 6	Medium	100	10
666233 90701 3	Large	100	10
666233 90702 0	X-Large	100	10
666233 90703 7	XX-Large	100	10

PART #	SIZE	PIECES/PACK	PACKS/CASE
Black - Heavy-Duty (6 mil.) Nitrile			
666233 90704 4	Medium	100	10
666233 90705 1	Large	100	10
666233 90706 8	X-Large	100	10
666233 90707 5	XX-Large	100	10

PART #	SIZE	PIECES/PACK	PACKS/CASE
Orange - Textured (7 mil.) Nitrile			
666233 90708 2	Medium	50	10
666233 90709 9	Large	50	10
666233 90710 5	X-Large	50	10
666233 90711 2	XX-Large	50	10

Best choice for hand protection



MECHANICS GLOVES

- Full non-slip silicon-printed palm
- Touch screen function on index finger knuckle and terry cloth on thumb
- Hook and loop closure

PART #	SIZE	QTY./PACK	PACKS/CASE
Mechanics Gloves			
076607 68400 4	One Size	1 Pair	10 Pairs

Part-to-Page Cross Reference

PART #	PG. #	PART #	PG. #	PART #	PG. #	PART #	PG. #	PART #	PG. #	PART #	PG. #	PART #	PG. #
07660701385	11	63642574610	9	66261026297	24	66261055959	12	66261119583	15	66261131689	28	66261146600	16
07660701386	11	63642574611	9	66261026299	24	66261055960	12	66261120508	25	66261131690	28	66261146605	16
07660701387	11	63642574612	9	66261026300	24	66261055961	12	66261120509	25	66261131726	25	66261146610	16
07660701388	11	63642574613	9	66261026301	24	66261055962	12	66261120510	25	66261131727	25	66261146615	16
07660701392	11	63642574614	9	66261026302	24	66261055963	12	66261120511	25	66261131730	15	66261146620	16
07660701393	11	63642574615	9	66261026303	24	66261055964	12	66261120512	25	66261131731	15	66261146625	16
07660702450	31	63642574616	9	66261026304	24	66261055965	12	66261120513	25	66261131732	15	66261146630	16
07660702451	31	63642574617	9	66261026305	24	66261055966	12	66261120514	25	66261131733	15	66261146680	16
07660702452	31	63642574618	9	66261026306	24	66261055967	12	66261120515	25	66261131734	15	66261146705	16
07660702453	31	63642577090	24	66261026307	24	66261055968	12	66261120516	25	66261131735	16	66261146880	9
07660702489	11	63642577635	5	66261026308	24	66261055969	12	66261120517	25	66261131736	16	66261146885	9
07660702490	11	63642577636	5	66261026309	24	66261059003	19	66261120518	25	66261131737	16	66261146890	9
07660703846	11	63642577637	5	66261026311	24	66261069004	19	66261120519	25	66261131817	15	66261146895	9
07660704025	32	63642577638	5	66261026312	24	66261071017	24	66261120520	25	66261131818	15	66261146900	9
07660704033	22	63642577639	5	66261026313	24	66261071018	24	66261120521	25	66261131819	15	66261146905	9
07660704034	22	63642577640	5	66261026314	24	66261078093	19	66261120522	25	66261131821	15	66261146910	9
07660704035	22	63642577641	5	66261029395	11	66261078094	19	66261120523	25	66261131822	15	66261146915	9
07660704036	22	63642577642	5	66261031815	15	66261078095	19	66261120524	25	66261135063	14	66261146920	9
07660704037	22	63642577643	5	66261031816	15	66261078096	19	66261120525	25	66261135064	14	66261146925	9
07660704038	22	63642577644	5	66261040283	12	66261078097	19	66261120526	25	66261135065	14	66261146930	9
07660704041	22	63642592878	4	66261040284	12	66261078098	19	66261120527	25	66261135066	14	66261147010	9
07660705300	32	63642592879	4	66261040285	12	66261078099	19	66261120528	25	66261135067	14	66261147015	9
07660705301	32	63642592880	4	66261040286	12	66261078100	19	66261120529	25	66261135068	14	66261147020	9
07660705483	22	63642592881	4	66261040691	4	66261078101	19	66261120530	25	66261135069	14	66261147025	9
07660705484	22	63642592882	4	66261040692	4	66261078102	19	66261120531	25	66261135070	14	66261147030	9
07660705486	22	63642592883	4	66261040693	4	66261078103	19	66261120532	25	66261135071	14	66261147035	9
07660705487	22	63642592884	4	66261040694	4	66261078104	19	66261120533	25	66261135072	14	66261147040	9
07660705488	22	63642592885	4	66261040695	4	66261078105	19	66261120534	25	66261135073	14	66261147045	9
07660705489	22	63642595802	4	66261040696	4	66261078106	19	66261120535	25	66261135074	14	66261147050	9
07660705490	22	63642595803	4	66261040697	4	66261078107	19	66261120536	25	66261135075	14	66261147055	9
07660768084	4	63642595807	4	66261044742	10	66261078108	19	66261120537	25	66261135076	14	66261147150	9
07660768085	4	63642597500	23	66261044745	10	66261078109	19	66261120538	25	66261135077	14	66261148894	25
07660768086	4	63642597501	23	66261044746	10	66261078110	19	66261120539	25	66261135078	14	66261148895	25
07660768087	4	63642597502	23	66261044748	10	66261078111	19	66261120540	25	66261135079	14	66261148896	25
07660768088	4	63642597503	23	66261051676	11	66261078112	19	66261120541	25	66261135080	14	66261148897	25
07660768142	31	63642597504	23	66261054208	29	66261078113	19	66261120542	25	66261135081	14	66261148898	25
07660768143	31	63642597505	23	66261054209	29	66261078114	19	66261120543	25	66261135082	14	66261148899	25
07660768279	22	63642597506	23	66261054210	29	66261078115	19	66261121207	7	66261135083	14	66261148900	25
07660768301	31	63642597507	23	66261054211	29	66261078116	19	66261121490	25	66261135084	14	66261148901	25
07660768302	31	63642597508	23	66261054212	29	66261081820	15	66261122406	11	66261135085	14	66261148902	25
07660768303	31	63642597509	23	66261054275	29	66261081822	15	66261122407	11	66261135086	14	66261148903	25
07660768304	31	66254408866	19	66261054276	29	66261081824	15	66261122408	11	66261135735	18	66261148904	25
07660768400	32	66254440809	19	66261054277	29	66261081826	15	66261122409	11	66261135736	18	66261148905	25
07660768444	21	66254440810	19	66261054278	29	66261100115	16	66261122410	11	66261135737	18	66261148906	25
07660768445	21	66254440811	19	66261054279	29	66261100117	16	66261122411	11	66261135738	18	66261148907	25
07660768446	21	66254440813	19	66261055759	17	66261100118	16	66261122415	11	66261135739	18	66261148908	25
07660768447	21	66254448364	11	66261055760	17	66261100267	16	66261123032	25	66261135740	18	66261148909	25
07660768448	21	66254448365	11	66261055762	17	66261101452	16	66261123042	9	66261135741	18	66261148910	25
07660768449	21	662544476403	10	66261055827	17	66261102001	16	66261123043	9	66261135872	18	66261148911	25
07660768450	21	662544476404	10	66261055828	17	66261102206	27	66261123046	15	66261135874	18	66261148912	25
63642524645	5	66254480746	24	66261055829	17	66261102207	27	66261123412	9	66261136231	18	66261148913	25
63642530592	15	66254480747	24	66261055830	17	66261102208	27	66261123814	15	66261139519	18	66261149059	18
63642530593	15	66254480748	24	66261055831	17	66261102209	27	66261124636	18	66261141782	29	66261149150	18
63642530594	15	66261002054	28	66261055934	8	66261102431	9	66261124637	18	66261142832	11	66261149152	18
63642535316	29	66261002055	28	66261055935	8	66261103815	16	66261124638	18	66261143128	18	66261149153	18
63642557584	29	66261002056	28	66261055936	8	66261104794	16	66261124644	18	66261143129	18	66261149154	18
63642557599	29	66261002211	15	66261055937	8	66261105624	16	66261124650	18	66261143130	18	66261149155	18
63642557600	29	66261002218	28	66261055938	8	66261106348	27	66261124651	18	66261143131	18	66261149157	18
63642557602	29	66261002220	28	66261055939	8	66261106717	16	66261124659	18	66261143132	18	66261149158	11
63642557604	29	66261006547	11	66261055940	8	66261107073	15	66261124665	18	66261143133	18	66261149507	18
63642557606	29	66261007703	15	66261055941	8	66261107163	16	66261124671	18	66261143140	11	66261149558	28
63642557608	29	66261009217	11	66261055942	8	66261110401	16	66261124672	18	66261143141	11	66261149561	28
63642557611	29	66261009218	11	66261055943	8	66261110508	16	66261124673	18	66261143142	11	66261149562	28
63642557612	29	66261014022	15	66261055944	8	66261110792	16	66261124679	18	66261143143	11	66261149564	28
63642557613	29	66261014691	28	66261055945	8	66261112748	9	66261124680	18	66261143144	11	66261149716	20
63642557616	29	66261015083	28	66261055946	8	66261113130	15	66261124682	18	66261143145	11	66261149717	20
63642574600	5	66261015689	28	66261055947	8	66261113134	16	66261124684	18	66261143724	25	66261150000	3
63642574601	5	66261016968	26	66261055948	8	66261113139	16	66261124686	18	66261146465	16	66261150001	3
63642574602	5	66261017116	26	66261055950	12	66261113141	16	66261124687	18	66261146470	16	66261150002	3
63642574603	5	66261017118	26	66261055951	12	66261113270	9	66261128561	18	66261146490	16	66261150003	3
63642574604	5	66261018833	26	66261055952	12	66261113954	9	66261131681	28	66261146505	16	66261150004	3
63642574605	5	66261019794	28	66261055953	12	66261115600	9	66261131683	28	66261146510	16	66261150005	3
63642574606	5	66261026292	24	66261055954	12	66261115627	9	66261131685	28	66261146515	16	66261150007	3
63642574607	5	66261026293	24	66261055955	12								

Part-to-Page Cross Reference

PART #	PG. #	PART #	PG. #	PART #	PG. #	PART #	PG. #	PART #	PG. #	PART #	PG. #	PART #	PG. #
66261150012	3	66261170593	9	66623319889	8	66623319976	5	66623374368	22	69957342161	17	69957346297	4
66261150013	3	66261170594	9	66623319890	8	66623319977	5	66623377647	5	69957342167	17	69957346298	4
66261150014	3	66261170595	9	66623319891	8	66623319978	5	66623377648	5	69957342168	17	69957346299	4
66261150016	3	66261170596	9	66623319892	8	66623319979	5	66623377649	5	69957342169	17	69957365332	15
66261150017	3	66261170597	9	66623319893	8	66623319980	5	66623377650	5	69957342174	17	69957365435	9
66261150018	3	66261170598	9	66623319894	8	66623319981	5	66623377651	5	69957342175	17	69957367757	23
66261150019	3	66261170599	9	66623319895	8	66623319982	5	66623377653	5	69957342176	17	69957367758	23
66261150020	3	66261170600	9	66623319896	8	66623319983	5	66623377654	5	69957342177	17	69957368456	9
66261150021	3	66261170601	9	66623319897	8	66623319985	8	66623377656	5	69957342178	17	69957370201	14
66261150022	3	66261170602	9	66623319898	8	66623319986	8	66623377657	5	69957342180	17	69957370202	14
66261150023	3	66261170603	9	66623319899	8	66623319987	8	66623377658	5	69957342181	17	69957370203	14
66261150024	3	66261170604	9	66623319901	8	66623319988	8	66623377660	5	69957342182	17	69957370204	14
66261150025	3	66261170605	9	66623319902	8	66623319989	8	66623377661	5	69957342184	10	69957392500	4
66261150026	3	66261170606	9	66623319903	8	66623319990	8	66623383384	27	69957342185	10	69957392501	4
66261150027	3	66261170607	9	66623319904	13	66623319991	8	66623390700	32	69957342186	10	69957392502	4
66261150028	3	66261170608	9	66623319905	13	66623319992	8	66623390701	32	69957342190	10	69957392503	4
66261150029	3	66261170625	31	66623319906	13	66623319993	8	66623390702	32	69957342192	10	69957392504	4
66261150031	3	66261170626	30	66623319907	13	66623319994	8	66623390703	32	69957342198	10	69957392505	4
66261150032	3	66261170627	30	66623319908	13	66623319995	8	66623390704	32	69957342199	10	69957392506	4
66261150033	3	66261170630	32	66623319909	13	66623319996	8	66623390705	32	69957342206	10	69957396249	5
66261150034	3	66261170631	32	66623319910	13	66623319997	8	66623390706	32	69957342213	10	77696068696	24
66261150035	3	66261170633	32	66623319911	13	66623319998	8	66623390707	32	69957342214	10	77696069564	9
66261150037	7	66261170640	21	66623319912	13	66623319999	8	66623390708	32	69957342215	10	77696069565	9
66261150040	7	66261170641	21	66623319913	13	66623372279	5	66623390709	32	69957342216	10	77696069566	9
66261150041	7	66261170642	21	66623319914	13	66623372280	5	66623390710	32	69957342217	10	77696069567	9
66261150043	7	66261170643	21	66623319915	13	66623372281	5	66623390711	32	69957342218	10	77696069568	9
66261150044	7	66261170644	21	66623319916	13	66623372282	5	66623398561	27	69957342219	10	77696069569	9
66261150045	7	66261170645	21	66623319917	13	66623372283	5	66623399573	12135	69957342220	10	77696069570	9
66261150046	7	66261170646	21	66623319918	13	66623372284	5	69957319461	13	69957342221	10	77696084091	27
66261150047	7	66261170647	21	66623319919	13	66623374202	5	69957319462	13	69957342222	10	77696084095	27
66261150048	7	66261170648	21	66623319920	13	66623374203	5	69957319463	13	69957342223	10	77696085539	19
66261150049	7	66261170649	21	66623319921	13	66623374205	5	69957319464	13	69957342224	10	77696085783	19
66261150050	7	66261183283	8	66623319922	13	66623374206	5	69957319465	13	69957342225	10	77696085785	19
66261150051	7	66261183284	8	66623319923	13	66623374208	5	69957319467	13	69957342226	10	77696085786	19
66261150052	7	66261183285	8	66623319924	13	66623374209	5	69957319468	13	69957342227	10	77696085787	19
66261150053	7	66261183286	8	66623319925	13	66623374210	5	69957319469	13	69957342228	10	77696085788	19
66261157319	25	66261183287	8	66623319926	13	66623374211	5	69957319470	13	69957342233	10	77696085789	19
66261157320	25	66261183288	8	66623319928	20	66623374223	8	69957319471	13	69957342234	10	77696085790	19
66261157321	25	66261183289	8	66623319929	20	66623374264	8	69957319472	13	69957342245	10	77696089042	27
66261157331	25	66261183290	8	66623319930	20	66623374268	8	69957319473	13	69957342246	10	77696089043	27
66261157332	25	66261183291	8	66623319931	20	66623374269	8	69957319474	13	69957342247	10	77696095438	29
66261157333	25	66261183292	8	66623319932	20	66623374270	8	69957319475	13	69957342249	10	77696099000	21
66261157334	25	66261183293	8	66623319933	20	66623374271	8	69957319476	13	69957342252	10	77696099001	21
66261157335	25	66261183294	8	66623319934	20	66623374272	8	69957319478	13	69957342254	10	77696099002	21
66261157340	25	66261183295	8	66623319935	20	66623374273	8	69957321935	10	69957344601	15	77696099003	21
66261157341	25	66261183296	8	66623319936	20	66623374274	8	69957325881	11	69957344604	15	77696099004	21
66261157342	25	66261183297	8	66623319937	20	66623374275	8	69957325882	11	69957344606	15	77696099005	21
66261159696	19	66261183298	8	66623319938	20	66623374277	8	69957325884	11	69957344614	15	77696099006	21
66261159697	19	66261183306	11	66623319939	20	66623374278	8	69957325885	11	69957344615	15	77696099007	21
66261159699	19	66261183307	11	66623319940	20	66623374279	8	69957325886	11	69957344616	15	77696099008	32
66261159700	19	66261183308	11	66623319941	20	66623374280	8	69957325887	11	69957344618	15	78072715990	3
66261159701	19	66261183309	11	66623319942	20	66623374281	8	69957325888	11	69957344620	15	78072704407	7
66261159702	19	66261183310	11	66623319944	5	66623374282	8	69957342096	17	69957344625	15	78072713926	7
66261159703	19	66261183311	11	66623319945	5	66623374344	20	69957342100	17	69957345027	4	78072715988	3
66261159704	19	66261183312	11	66623319946	5	66623374345	20	69957342101	17	69957345028	4	78072715989	3
66261170572	30	66261194109	27	66623319947	5	66623374346	20	69957342107	17	69957345029	4	78072715991	3
66261170573	30	66261194114	27	66623319948	5	66623374347	20	69957342108	17	69957345030	4	78072715992	3
66261170574	30	66261194115	27	66623319949	5	66623374349	20	69957342109	17	69957345031	4	78072715993	3
66261170575	30	66261194117	27	66623319950	5	66623374350	20	69957342121	17	69957345032	4	78072715997	3
66261170576	30	66261194874	27	66623319951	5	66623374351	20	69957342122	17	69957345033	4	78072715998	3
66261170577	30	66261199167	11	66623319960	5	66623374352	20	69957342123	17	69957345034	4	78072716007	3
66261170578	30	66261199168	11	66623319961	5	66623374353	20	69957342124	17	69957345035	4	78072769536	6
66261170579	30	66261199169	11	66623319962	5	66623374354	20	69957342125	17	69957345036	4	78072772053	6
66261170580	30	66261199170	11	66623319963	5	66623374355	20	69957342128	17	69957345037	4	78072772102	6
66261170581	30	66623304169	24	66623319964	5	66623374356	20	69957342129	17	69957345038	4	78072772104	6
66261170582	30	66623305450	8	66623319965	5	66623374357	20	69957342130	17	69957345039	4	78072772105	6
66261170583	30	66623305451	8	66623319966	5	66623374358	20	69957342134	17	69957345040	4		
66261170584	30	66623305452	8	66623319967	5	66623374359	20	69957342135	17	69957345041	4		
66261170585	30	66623305453	8	66623319968	5	66623374360	20	69957342136	17	69957345042	4		
66261170586	30	66623305454	8	66623319969	5	66623374361	20	69957342137	17	69957345338	15		
66261170587	30	66623305455	8	66623319970	5	66623374362	20	69957342138	17	69957345342	15		
66261170588	30	66623305456	8	66623319971	5	66623374363	20	69957342139	17	69957346292	4		
66261170589	28	66623308395	10	66623319972	5	66623374364	20	69957342140	17	69957346293	4		
66261170590	28	66623314701	10	66623319973	5	66623374365	20	69957342149	17	69957346294	4		
66261170591	28	66623314702	10	66623319974	5	66623374366	20	69957342153	17	69957346295	4		

Wood Flooring Species

MEASUREMENT CRITERIA

The Janka hardness test is a measurement of the force necessary to embed a .444-inch steel ball to half its diameter in wood. It is the industry standard for gauging the ability of various species to tolerate denting and normal wear, as well as being a good indication of the effort required to either sand, nail, or saw the particular wood.



WOOD SPECIES	HARDNESS	SANDING PRODUCT					
		BLAZE	RED HEAT	BLUEFIRE	NEON		
Imported Woods		BLAZE	RED HEAT	BLUEFIRE	NEON		
Tipe / Brazilian Walnut / Lapacho	3684						
Cumaru / Brazilian Teak	3540						
Ebony	3220						
Brazilian Redwood / Paraju	3190						
Angelim Pedra	3040						
Bloodwood	2900						
Red Mahogany, Turpentine	2697						
Spotted Gum	2473						
Brazilian Cherry / Jatoba	2350						
Mesquite	2345						
Santos Mahogany, Bocote, Cabreuva	2200						
Pradoo	2170						
Brushbox	2135						
Karri	2030						
Sydney Blue Gum	2023						
Bubinga	1980						
Cameron	1940						
Tallowwood	1933						
Merbau	1925						
Amendoim	1912						
Jarra	1910						
Purpleheart	1860						
Goncalo Alves / Tigerwood	1850						
Hickory / Pecan / Satinwood	1820						
Atzilia / Doussie	1810						
Bangkirai	1798						
Rosewood	1780						
African Padauk	1725						
Blackwood	1720						
Merbau	1712						
Kempas	1710						
Locust	1700						
Highland Beech	1686						
Wenge, Red Pine	1630						
Tualang	1624						
Zebrawood	1575						
True Pine, Timborana	1570						
Peroba	1557						
Kambala	1540						
Sapele / Sapelli	1510						
Curupixa	1490						
Sweet Birch	1470						
Common Hardwoods				BLAZE	RED HEAT	BLUEFIRE	NEON
Hard Maple / Sugar Maple	1450						
Coffee Bean	1390						
Natural Bamboo (represents one species)	1380						
Australian Cypress	1375						
White Oak	1360						
Tasmanian Oak	1350						
Ribbon Gum	1349						
Ash (White)	1320						
American Beech	1300						
Red Oak (Northern)	1290						
Softer Hardwoods							
Carribean Heart Pine	1280						
Yellow Birch	1260						
Movingui	1230						
Heart Pine	1225						
Carbonized Bamboo (represents one species)	1180						
Cocobolo	1136						
Brazilian Eucalyptus / Rose Gum	1125						
Makore	1100						
Boreal	1023						
Black Walnut	1010						
Teak	1000						
Sakura	995						
Black Cherry, Imbuia	950						
Boire	940						
Paper Birch	910						
Cedar	900						
Southern Yellow Pine (Longleaf)	870						
Lacewood, Leopardwood	840						
Parana	780						
Sycamore	770						
Shedua	710						
Southern Yellow Pine (Loblolly and Shortleaf)	690						
Douglas Fir	660						
Larch	590						
Chestnut	540						
Hemlock	500						
White Pine	420						
Basswood	410						
Eastern White Pine	380						

NORTON

SAINT-GOBAIN®

PRODUCTS FOR THE PROFESSIONAL HARDWOOD FLOORING MARKET



NORTON BLAZE
BLAZE YOUR WAY TO PRODUCTIVITY!

Tackle gym floor re-sands and UV-cured pre-finished floors with ease.



NORTON NEON
AFFORDABLE VERSATILITY!

Designed with durability and quality in mind at an economical price.



NORTON SANDDOLLAR
STRIP AWAY OLD IDEAS!

Smooth and prep the surface of the floor to properly accept the next coat of finish without risk of swirl marks.



NORTON RED HEAT
HOOK & LOOP DISCS!

For the finest scratch pattern in the industry.



FINISH YOUR FLOORS
WITH CONFIDENCE!

Applicators designed to quickly and easily apply floor finish or sealer with superior results.



NORTON HARDWOOD FLOOR
FAST SET EPOXY KITS!

Designed with a quick set time, the Norton Fast Set Epoxy is perfect for all board repairs.

Reshaping
your
world.



AUTOMOTIVE AFTERMARKET REFINISHING PRODUCTS



QUALITY THAT PAYS™





NORGRIP PAPER DISCS



GRIT	5" VAC NORGRIP MULTI-AIR CYCLONIC DISCS	6" VAC NORGRIP MULTI-AIR CYCLONIC DISCS	6" VAC NORGRIP MULTI-AIR CYCLONIC DISCS	6" NORGRIP DISCS
P400	–	636425 97517	–	–
P320	–	636425 97516	–	–
P220	636425 97504	636425 97509	–	636425 97514
P180	636425 97503	636425 97508	–	636425 97513
P150	636425 97502	636425 97507	–	636425 97512
P120	636425 97501	636425 97506	–	636425 97511
P80	636425 97500	636425 97505	–	636425 97510
P40	–	–	636425 97515	–
PKG/CASE	50/4	50/4	25/4	50/4



NORGRIP SHEET ROLLS



GRIT	2-3/4" x 13 YDS NORGRIP MULTI-AIR CYCLONIC ROLLS	2-3/4" x 9 YDS NORGRIP MULTI-AIR CYCLONIC ROLLS
P400	776960 30001	–
P320	776960 30000	–
P220	699573 08903	–
P180	699573 08902	–
P150	699573 08901	–
P120	699573 08900	–
P80	699573 08899	–
P40	–	699573 65500
PKG/CASE	1/4	1/4





NORGRIP MULTI-AIR CYCLONIC DISCS



GRIT	3" NORGRIP MULTI-AIR CYCLONIC DISCS	6" NORGRIP MULTI-AIR CYCLONIC DISCS
P1000B	776960 95016	776960 07788
P800B	776960 95015	776960 07787
P600B	776960 95014	776960 07786
P500B	776960 95013	776960 07785
P400B	776960 95012	776960 07784
P320B	776960 95011	776960 07781
P280B	–	776960 07778
P240B	776960 95010	776960 07777
P220B	776960 95009	776960 07776
P180B	776960 95008	776960 07775
P150B	776960 95007	776960 07774
P120C	776960 95006	776960 07773
P80C	776960 95005	776960 07770
PKG/CASE	50/4	50/4



SHEET ROLLS

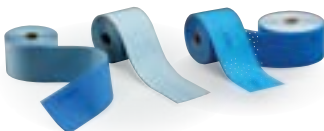

GRIT	2-3/4" x 45 YDS PSA SHEET ROLLS	2-3/4" x 13 YDS NORGRIP SHEET ROLLS	2-3/4" x 13 YDS NORGRIP MULTI-AIR CYCLONIC SHEET ROLLS	4-1/2" x 13 YDS NORGRIP MULTI-AIR CYCLONIC SHEET ROLLS
P600B	–	666233 29548	636425 06124	–
P500B	–	666233 29547	636425 06123	–
P400B	662611 49557	666233 29518	636425 06122	666233 90517
P320B	662611 49558	636425 06255	636425 06121	666233 90518
P240B	–	–	636425 06120	–
P220B	662611 49561	636425 06256	636425 06119	666233 90519
P180B	662611 49562	636425 06257	636425 06118	666233 90520
P150B	–	–	636425 06117	666233 90521
P120C	662611 49564	636425 06259	636425 06114	666233 90522
P80C	662611 49566	636425 06261	636425 06113	666233 90523
PKG/CASE	1/5	1/4	1/4	1/4

MULTI-AIR NORGRIP PAD



DESCRIPTION	6" x 5/16"-24 THREAD BACKUP PAD / YELLOW	6" x 1/2" THICKNESS INTERFACE PAD
Medium	636425 06160	–
Interface	–	076607 19359
PKG/CASE	5/1	12/1



PSA AND NORGRIP DISCS



GRIT	6" PSA DISC ROLLS	6" NORGRIP DISCS
P1500B	—	636425 06377
P1200B	—	636425 06376
P1000B	—	636425 06375
P800B	636425 06200	636425 06204
P600B	636425 06199	636425 06203
P500B	636425 06198	636425 06202
P400B	662611 55373	662611 49542
P320B	662611 55374	662611 49543
P240B	662611 55376	662611 49545
P220B	662611 48340	662611 49546
P180B	662611 40508	662611 40528
P150B	662611 40509	662611 40529
P120C	662611 40510	662611 40530
P100C	662611 40511	662611 40531
P80C	662611 40512	662611 40532
PKG/CASE	100/4	50/4



NORGRIP DISCS



GRIT	3" NORGRIP DISCS	6" NORGRIP DISCS	6" VAC NORGRIP MULTI-AIR CYCLONIC DISCS
P1500B	662611 47434	662611 31550	—
P1200B	—	662611 31551	—
P1000B	662611 35900	662611 31552	666233 90514
P800B	662611 31519	662611 31553	666233 90513
P600B	662611 36996	662611 31554	666233 90512
P500B	662611 31521	662611 31555	666233 90511
P400B	662611 36995	662611 31556	666233 90510
P320B	662611 31524	662611 31558	666233 90509
P280B	—	662611 31559	—
P240B	662611 31526	662611 31560	666233 90508
P220B	662611 31527	662611 31561	666233 90507
P180B	662611 31528	662611 31562	666233 90506
P150B	662611 40385	662611 31563	666233 90505
P120B	662611 28688	662611 31564	666233 90504
P100B	662611 44926	662611 31565	—
P80B	662611 31532	662611 31566	666233 90503
PKG/CASE	50/4	100/4	100/4

PSA DISCS



GRIT	6" PSA DISCS (TABBED)	6" PSA DISC ROLLS	6" VAC PSA DISC ROLLS
P1500B	662611 31465	—	—
P1200B	662611 31466	—	—
P1000B	662611 31467	—	—
P800B	—	662611 31468	—
P600B	—	662611 31469	666233 31503
P500B	—	662611 31470	—
P400B	—	662611 31471	666233 31505
P320B	—	662611 31473	666233 31507
P280B	—	662611 31474	666233 31508
P240B	—	662611 31475	666233 31509
P220B	—	662611 31476	666233 31510
P180B	—	662611 31477	666233 31511
P150B	—	662611 31478	666233 31512
P120B	—	662611 31479	666233 31513
P100B	—	662611 31480	666233 31514
P80B	—	662611 31481	666233 31515
PKG/CASE	100/4	100/6	100/4

NORTON **A275OP™**
abrasives

BODY FILE SHEETS

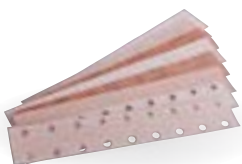

GRIT	2-3/4" x 17-1/2" CLIP-ON BODY FILE SHEETS	2-3/4" x 16-1/2" PSA BODY FILE SHEETS	2-3/4" x 16-1/2" NORGRIP BODY FILE SHEETS
P220B	662611 31647	662611 31635	662611 31641
P180B	662611 31648	662611 31636	662611 31642
P150B	662611 31649	662611 31637	662611 31643
P120B	662611 31650	662611 31638	662611 31644
P100B	662611 31651	662611 31639	662611 31645
P80B	662611 31652	662611 31640	662611 31646
PKG/CASE	50/10	50/10	50/10

NORTON **A275OP™**
abrasives

BODY FILE SHEETS AND 9x11 SHEETS



GRIT	2-3/4" x 16" VAC NORGRIP BODY FILE SHEETS	9" x 11" SHEETS
P1500B	—	662611 31618
P1200B	—	662611 31619
P1000B	—	662611 31620
P800B	—	662611 31621
P600B	—	662611 31622
P500B	—	662611 31623
P400B	—	662611 31624
P320B	—	662611 31626
P280B	—	662611 31627
P240B	—	662611 31628
P220B	—	662611 31629
P180B	662611 31654	662611 31630
P150B	—	662611 31631
P120B	662611 31656	662611 31632
P100B	662611 31657	662611 31633
P80B	—	662611 31634
PKG/CASE	50/10	1/5



NORTON **A275OP™**

SHEET ROLLS



GRIT	2-3/4" x 45 YDS PSA ROLLS	2-3/4" x 30 YDS PSA ROLLS	2-3/4" x 25 YDS PSA ROLLS	2-3/4" x 13 YDS MULTI-AIR CYCLONIC NORGRIP ROLLS
P600B	662611 31679	—	—	—
P400B	662611 31681	—	—	662611 56071
P320B	662611 31683	—	—	662611 56070
P240B	662611 31685	—	—	662611 46068
P220B	662611 31686	—	—	636425 04663
P180B	662611 31687	—	—	662611 56067
P150B	662611 31688	—	—	662611 56066
P120B	—	662611 31689	—	662611 56065
P100B	—	662611 31690	—	—
P80B	—	—	662611 31691	662611 56064
PKG/ CASE	1/5	1/5	1/5	1/4

NORTON **GOLD**
RESERVE

PSA DISC ROLLS

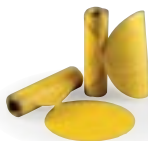

GRIT	6" PSA DISC ROLLS (25/ROLL)	6" PSA DISC ROLLS (100/ROLL)
P800B	—	636425 06164
P600B	—	662610 40261
P500B	—	636425 06165
P400B	636425 06176	662611 83823
P320B	636425 06177	662611 83822
P240B	—	662611 83821
P220B	636425 06178	662611 83820
P180B	636425 06179	662611 83819
P150B	—	662611 83818
P120B	—	662611 83817
P100B	—	662611 83816
P80B	636425 06182	662611 83815
PKG/CASE	1/6	1/4





PSA AND NORGRIP DISCS



GRIT	6" PSA DISCS (TABBED)	6" NORGRIP DISCS	6" VAC NORGRIP DISCS
P800B	–	636425 06226	666233 34797
P600B	–	636425 06227	666233 34796
P500B	–	636425 06228	–
P400B	662611 83832	636425 06229	666233 34794
P320B	662611 83831	636425 06230	666233 34793
P240B	662611 83830	636425 06225	–
P220B	662611 83829	636425 06231	666233 34791
P180B	662611 83828	636425 06232	666233 34790
P150B	662611 83827	636425 06233	–
P120B	662611 83826	636425 06234	666233 34788
P100B	662611 83825	636425 06235	666233 34787
P80B	662611 83824	636425 06236	666233 34786
80E	–	666233 34800*	–
40E	–	666233 34801*	–
PKG/CASE	100/4	50/4 * 25/4	50/4



BODY FILE SHEETS AND ROLLS

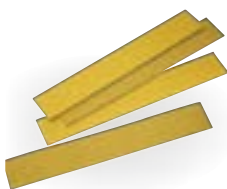

GRIT	2-3/4" x 16-1/2" PSA BODY FILE SHEETS	2-3/4" x 16-1/2" NORGRIP BODY FILE SHEETS	2-3/4" x 25 YDS PSA SHEET ROLLS
P400B	–	–	636425 06147
P320B	–	–	636425 06148
P220B	–	636425 06242	636425 06149
P180B	–	636425 06241	636425 06150
P150B	–	636425 06240	636425 06151
P120B	–	636425 06239	636425 06152
P100B	–	636425 06238	–
P80B	–	636425 06237	636425 06153
P80C	–	–	662611 60325
P80E	636425 06196	666233 34804	–
P40E	636425 06195	666233 34805	–
P36E	636425 06194	–	–
PKG/CASE	25/5	25/5	1/5



DISCS



GRIT	5" ALUMINUM OXIDE DISCS	6" ALUMINUM OXIDE DISCS
400	636425 06457	636425 06464
320	636425 06456	636425 06463
240	636425 06455	636425 06462
220	636425 06454	636425 06461
180	636425 06453	636425 06460
120	636425 06452	636425 06459
80	636425 06451	636425 06458
PKG/CASE	50/200	50/200



DISCS



GRIT	6" PSA DISCS	8" PSA DISCS	6" PSA VAC DISCS	8" PSA VAC DISCS
80E	662611 23573	662611 23576	–	662611 23582
40E	662611 23574	662611 23577	662611 23580	–
36E	662611 23575	662611 23578	–	662611 23584
PKG/CASE	50/4	25/4	50/4	25/4



GRIT	6" NORGRIP DISCS	8" NORGRIP DISCS	8" NORGRIP VAC DISCS
80E	662611 23588	662611 23591	662611 23596
40E	662611 23589	662611 23592	–
36E	662611 23590	662611 23593	662611 23598
PKG/CASE	25/4	25/4	25/4

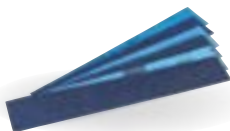

SHEETS



GRIT	2-3/4" x 17-1/2" CLIP-ON BODY FILE SHEETS	2-3/4" x 16-1/2" PSA BODY FILE SHEETS	2-3/4" x 16-1/2" NORGRIP BODY FILE SHEETS
180E	662611 26511	–	–
100E	662611 26512	662611 25595*	–
80E	662611 23620	662611 23608	662611 23614
40E	662611 23621	662611 23609	662611 23615
36E	662611 23622	662611 23610	662611 23616
PKG/CASE	50/5	50/5 * 50/10	25/5



WATERPROOF SHEETS



GRIT	9" x 11" SHEETS
2500B	662611 39377
2000B	662611 39378
1500B	662611 39379
1200B	662611 39380
1000B	662611 39381
P800B	662611 39382
P600B	662611 39383
P500B	662611 39384
P400B	662611 39385
P320B	662611 39386
P240B	662611 39388
P220B	662611 39389
PKG/CASE	50/5



NORTON *PUREice*[®]

Q175 FILM DISCS



GRIT	COLOR	3" NORGRIP DISCS	6" NORGRIP DISCS
P1500	Blue	776960 88704	776960 88716
P1200	Green	776960 88703	776960 88715
P1000	Red	776960 88702	776960 88714
P800	Black	776960 88701	776960 88713
PKG/CASE		50/4	50/4
Interface Pads		636425 05457	636425 42089
Back-Up Pads		636425 06128	636425 06137 or 636425 06145 (tapered)

NORTON *ice*[™]

MICROFINISHING FOAM DISCS



GRIT	COLOR	3" NORGRIP DISCS	6" NORGRIP DISCS
3000	Green	636425 06020	636425 06013
2000	Magenta	636425 06021	636425 06014
1500	Blue	636425 06022	636425 06015
Back-Up Pad		636425 06128 *	636425 06130 *
PKG/CASE		6/4 *10/1	15/4 *5/1

NORTON *LIQUIDice*[®]

POLISHING SYSTEM



DESCRIPTION	PART #	PKG/CASE
Extra Cut Quart	636425 97116	4
Extra Cut Gallon	636425 06078	2
NorGrip Backup Pad	636425 42080	3
Wool Pad - Step 1	636425 42077	6
Blue Foam Pad - Step 2	636425 42078	6
White Foam Pad - Step 3	636425 42079	6
Waffle Orange Foam - Step 1	636425 06379	6
Waffle Blue Foam - Step 2	636425 06380	6
Waffle White Foam - Step 3	636425 06381	6
3" NorGrip Backup Pad	636425 06128	10
3" Wool Pad - Step 1	636425 43832	10/40
3" Blue Foam Pad - Step 2	636425 05459	10/40
3" White Foam Pad - Step 3	636425 05460	10/40
Clean Up Detailer 32 oz.	636425 42082	4
Micro-Fiber Cloth	636425 04402	5/20

ROTOLO FOAM

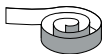

GRIT	4-1/2" x 82' (PERFORATED) FOAM ROLLS
P320	636425 57606
P400	636425 57608
P500	636425 57611
P600	636425 57612
P800	636425 57613
P1000	636425 57616
PKG/CASE	1/2

NORTON *SOFT TOUCH* SPONGES



DESCRIPTION	4-1/2" x 5-1/2" x 3/16" SPONGES
Micro Fine	076607 03078
Ultra Fine	076607 03077
Super Fine	076607 03076
Fine	076607 03075
Medium	076607 03074
PKG/CASE	20/4

NORTON *BEAR-TEX* SCUFF PADS, ROLLS AND THIN-FLEX



DESCRIPTION	6" x 9" SCUFF PADS	4-1/2" x 9" THIN-FLEX PADS	6" THIN-FLEX DISCS
Gold	662610 58005*	662611 13519*	662611 13517*
Gray	662610 58002	636425 06167	666233 34771
Maroon	662610 58000	636425 06166	666233 34770
White (Non-Abrasive)	662610 58001		
PKG/CASE	20/3 *10/3	25/4 *10/10	25/4 *10/4

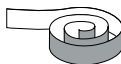
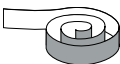

DESCRIPTION	4" x 30' THIN-FLEX ROLLS	4" x 30' BEAR-TEX ROLLS
Gray	636425 03021	636425 02999
Maroon	636425 03023	636425 03009
PKG/CASE	1/1	1/1

PORTABLE FILE BELTS



GRIT	BLAZE	BLAZE (5PK)	BLUEFIRE	BEAR-TEX
1/2" x 18"				
120	662610 41384	776960 69246	780727 28567	662610 55311 (VF)
80	699573 98023	776960 69245	780727 28568	–
60	699573 98022	776960 69244	780727 28569	662610 55310 (M)
40	699573 98021	776960 69243	662544 44193	662610 55309 (C)
3/8" x 13"				
60	699573 45359	–	780727 40295	–
80	699573 92150	–	780727 36062	–
PKG/CASE	50	5/25	50	24



CUT-OFF BLADES



SIZE	PART #
3" x 1/16"	662533 71059
3" x 1/32"	662533 71058
PKG/CASE	5/10

TR MINI FLAP DISCS



GRIT	2" BLAZE	3" BLAZE	2" BLUEFIRE	3" BLUEFIRE
120	776960 90149	776960 90154	776960 90169	776960 90174
80	776960 90148	776960 90153	776960 90168	776960 90173
60	776960 90147	776960 90152	776960 90167	776960 90172
40	776960 90146	776960 90151	776960 90166	776960 90171
36	776960 90145	776960 90150	776960 90165	776960 90170
PKG/CASE	10/1	10/1	10/1	10/1

DESCRIPTION	2" AND 3"
TR Back-Up Pad	088341 64922
PKG/CASE	1



2" AND 3" SPEED-LOK TR DISCS



GRIT	2" BLAZE	3" BLAZE	2" BLUEFIRE	3" BLUEFIRE
80	662611 62324	662611 62334	662611 21049	662611 21054
60	662611 62322	662611 62332	662611 21048	662611 21053
50	662611 62320	662611 62330	662611 38670	662611 38673
36	662611 62318	662611 62328	662611 38671	662611 38674
24	—	—	662611 38672	662611 38675
PKG/CASE	25/1	25/1	25/1	25/1



SURFACE CONDITIONING DISCS



GRIT	2" VORTEX	3" VORTEX	2" BEAR-TEX	3" BEAR-TEX
Very Fine	666233 90502	666233 35437	662610 09189	662610 09192
Medium	666233 90501	666233 35430	662610 09190	662610 17522
Coarse	666233 90500	666233 35417	662610 09191	662610 09194
PKG/CASE	25/1	25/1	25/1	25/1



SURFACE BLENDING DISCS



DESCRIPTION	BLAZE	VORTEX
2" Speed-Lok TR	666233 38632	666233 34782
3" Speed-Lok TR	666233 38633	666233 34783
PKG/CASE	10/1	10/1



TR AND TR+ DISCS



DESCRIPTION	PART #	PKG/CASE
2" Speed-Lok TR	666233 31051	10/1
3" Speed-Lok TR	666233 31053	10/1
4" x 1/2" TR+	666233 31054	5/1
Back-up Pad TR+	636425 55106	1/1
4" x 1/2" x 1/4" Hole	662610 09324	5/20
Mandrel	662610 09502	1/1



GRINDING DISCS



GRIT	5" x 7/8" DISCS	7" x 7/8" DISCS	5" x 7/8" FOIL PACK DISCS
80	699573 98009	699573 98014	—
50	699573 98007	699573 98012	—
36	699573 98006	699573 98011	—
24	699573 98005	699573 98010	662544 64822
PKG/CASE	25/1	25/1	10/50



GRINDING DISCS



GRIT	5" x 7/8" DISCS	7" x 7/8" DISCS
80	776960 08422	776960 08432
60	776960 08414	776960 08431
50	776960 08413	776960 08430
36	776960 08412	776960 08429
24	776960 08407	776960 10018
PKG/CASE	25/1	25/1



GRINDING DISCS



GRIT	5" x 7/8" DISCS	7" x 7/8" DISCS
80	662611 38600	662611 38590
60	662611 38601	662611 38591
50	662611 38561	662611 38592
36	662611 38562	662611 38593
24	662611 38563	662611 38594
PKG/CASE	25/1	25/1

NORTON TOOLS



DESCRIPTION	PART #	QTY/ CASE
2" Single Sander	662611 50076	1
2" Kit	662611 50077	1
Includes: 1 – Norton 2" Sander, 25 – 2" 36 Grit Norton Blaze R980P 3-Ply TR Discs (662611 62318), 50 – 2" Medium Grit Norton Rapid Prep Non-Woven TR Discs (662610 09190), 1 – 2" Medium Density Back-Up Pad (662610 55103)		
2" Mini Angle Sander Carry Case	699573 40172	1
Includes: 1 – 2" Mini Angle Sander, 5 – 2" 36 Grit Norton Blaze R980P 3-Ply TR Discs (662611 62318), 5 – 2" Medium Grit Norton Rapid Prep Non-Woven TR Discs (662610 09190), 1 – 2" Medium Density Back-Up Pad (662610 55103)		
3" Single Sander	699573 82154	1
3" Kit	699573 82155	1
Includes: 1 – Norton 3" Sander, 25 – 3" 36 Grit Norton Blaze R980P 3-Ply TR discs (662611 62328), 25 – 3" Medium Grit Norton Rapid Prep Non-Woven TR discs (662610 17522), 1 – 3" Medium Density Back-Up Pad (662610 55105)		
Straight Cut-Off Wheel Tool	666233 91379	1

NORTON VAC RACK



DESCRIPTION	PART #	QTY/ CASE
Norton VAC RACK Bundle (includes cart, vacuum system, 1-16.5' Pneumatic anti-static hose, 1 – 2-way terminal, 2 tool hooks, 6 – 3" hooks, and 2 shelves)	699573 12400	1
6" 9mm throw orbital sander	699573 66126	1
6" 6mm throw orbital sander	699573 12633	1
6" 3mm throw orbital sander	699573 12636	1
Multi-hole back-up pad	699573 12647	5
16.5' (5m) hose for pneumatic tool	699573 12637	1
26.2' (8m) hose for pneumatic tool	699573 45325	1
16.5' (5m) suction hose	699573 12638	2
26.2' (8m) suction hose	699573 45336	1
Multi-hole interface pad	699573 45337	4





AUTO LINE

DESCRIPTION	PART #	PKG/CASE
Impact Toughened – 220ml 2:1	636425 06427	6
Metal Door Skin Bonding – 220ml 2:1 Acrylic	636425 06419	6
Metal Panel/Weld Bonding – 220ml 2:1 Acrylic	636425 06420	6
Epoxy Panel Bonder – 30 min – 220ml 2:1	636425 06418	6
Epoxy Panel Bonder – 90 min – 220ml 2:1	636425 06421	6
45 seconds - 220ml 1:1 Urethane	636425 04647	6
1 minute – 220ml 1:1 Urethane	636425 04615	6
5 minutes – 220ml 1:1 Urethane	636425 04616	6
15 minutes – 220ml 1:1 Urethane	636425 04617	6
Adhesion Promoter - Aerosol	636425 04625	12
Controlled Flow SS - 220ml 1:1 Epoxy	636425 06402	6
Seam Sealer – 220ml 1:1 Epoxy	636425 97120	6
Self Leveling – 220ml 1:1 Epoxy	636425 97121	6
Bare Metal Seam Sealer - 220ml 1:1 Epoxy	636425 06398	6
Repair and Filler – 220ml 1:1 Epoxy	636425 06412	6
SMC/Fiberglass Repair – 220ml 1:1 Epoxy	636425 06417	6
Heavy Duty Manual Gun for 220ml	636425 41400	1
Mixing Tips 24 element for 220ml	636425 04628	6/10
Sprayable Seam Sealer Starter Kit	636425 06403	1
Sprayable Seam Sealer Mixing Tips	636425 06404	6/10
Pneumatic Applicator Gun for 220ml	636425 41399	1
Nylon Reinforcing Tape - 2" x 65"	636425 04632	6

ADHESIVES, SEALERS AND COATINGS

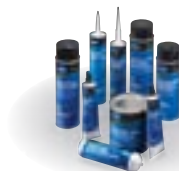

DESCRIPTION	SIZE	COLOR	PART #	PKG/CASE
Urethane Windshield Sealer	1/10 gal. cartridge		076607 82735	12
Quick Set Seam Sealer	1/10 gal. cartridge	Beige	076607 82750	12
Urethane Seam Sealer Sausage Pack		White	076607 82751	6
Rubberized Undercoat Premium	24 oz. can		076607 82775	6
Weatherstrip Adhesive	5 oz. tube	Amber	076607 82706	12
Weatherstrip Adhesive	5 oz. tube	Black	076607 82705	12
Black Powder Guide Coat	100g		666233 34772	6
Panel and Adhesive Cleaner	Quart can		076607 82780	12
Attachment Tape Adhesion Promoter			636425 04670	6



PAINTABLE PLASTIC SHEETING



SIZE	BLUE SHEETING	OVERSPRAY
12' x 400'	636425 03344	636425 06727
16' x 350'	636425 03345	–
16' x 400'	–	636425 06728
20' x 350'	636425 03723	–
PKG/CASE	1	1

NORTON **BLUEWRAP**[™]
PROTECTIVE PLASTIC

PROTECTIVE PLASTIC



DESCRIPTION/SIZE	PART #
Weather Barrier 36" x 100' (9 lbs.) 3 mil thick	636425 05920
Wheel Maskers (50/roll) Paintable	636425 05922
Bucket Seat Covers (125/roll) Non-Slip	636425 05921
Floor Mats (125/roll)	636425 05923
PKG/CASE	1

WHITE "PAINT-CHECK" MASKING PAPER

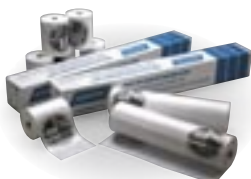

LENGTH	6"	12"	18"	36"
750'	636425 00402	636425 00403	636425 00404	636425 00407
PKG/CASE	6	3	2	1



FOAM MASKING TAPE



DESCRIPTION	1/2" x 54.6 YDS	3/4" x 54.6 YDS
Foam Masking Tape (13mm)	662544 70735	–
Premium Foam Masking Tape (20mm)	–	662544 70746
PKG/CASE	1	1

CLOTH DUCT TAPE

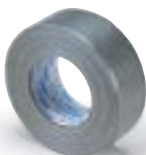

DESCRIPTION	2" x 60 YDS
Norton Duct Tape	636425 78000
IPG Duct Tape AC20	077922 74977
PKG/CASE	24

FINE LINE TAPE



SIZE/DESCRIPTION	1/8"	1/4"	1/2"
36 Yard Roll	636425 72018	636425 72014	636425 72012
PKG/CASE	12	12	12

FACTORY GRADE AUTOMOTIVE ATTACHMENT TAPE



SIZE/DESCRIPTION	PART #	PKG/CASE
1/4" x 5 yds.	636425 98650	12
1/2" x 5 yds.	636425 98651	9
7/8" x 5 yds.	636425 98652	7

PREMIUM AUTOMOTIVE ATTACHMENT TAPE



SIZE/DESCRIPTION	PART #	PKG/CASE
1/4" x 20 yds.	636425 05620	12
1/2" x 20 yds.	636425 05621	12
7/8" x 20 yds.	636425 05622	12
Adhesion Promoter 4 fl. oz.	636425 04670	6



AEROSOLS

DESCRIPTION	COLOR	PART #	SIZE	CASE
Primers				
Weld-Thru Primer	Zinc	666233 91000	12.5 oz	6
Weld Thru Primer	Copper	666233 91001	12.5 oz	6
Universal Primer	Gray	666233 91003	11.2 oz	6
High Build Primer	Gray	666233 91007	12 oz	6
Acid Etch Primer	Gray	666233 91010	12.9 oz	6
Coatings				
Dry Guide Coat	Black	666233 91008	10.9 oz	6
Satin Trim	Black	666233 91013	10.9 oz	6
Matte Trim	Black	666233 91014	11 oz	6
e-Coat	Black	666233 91015	12.6 oz	6
e-Coat	Grey	666233 91016	12.7 oz	6
e-Coat	Olive Green	666233 91017	12.8 oz	6
e-Coat	Light Green	666233 91018	12.7 oz	6
e-Coat	Tan	666233 91019	12.9 oz	6
e-Coat	White	666233 91025	12.4 oz.	6
e-Coat	Olive Brown	666233 91026	11.9 oz.	6
e-Coat	Dark Green	666233 91027	11.9 oz.	6
e-Coat	Field Drab	666233 91028	11.9 oz.	6
Rocker Panel Texture Coat	Gray	666233 91011	13.2 oz	6
Rocker Panel Texture Coat	Black	666233 91012	13.2 oz	6
Cleaners				
Surface Degreaser	–	666233 91009	9.9 oz	6
Spray Gun Paint Remover	Opaque	666233 91024	15 oz	6
Cavity Wax				
Cavity Wax	–	666233 91022	13.2 oz	12
Cavity Wax Applicator Wand	–	666233 91023	–	1



ERASER WHEEL

DESCRIPTION	PART #	CASE
Premium Eraser Wheel	666233 91380	1



VACUUM HAND BLOCKS & INTERFACE PADS

SIZE/DESCRIPTION	VACUUM HAND BLOCK	INTERFACE PAD
125 x 70mm	666233 91381	666233 91384
200 x 70mm	666233 91382	666233 91385
400 x 70mm	666233 91383	666233 91386
PKG/CASE	1	20



BUFFING PADS

SIZE	DESCRIPTION	PART #	CASE
Single-Sided CCS Waffle Foam Pads			
8"	Cutting - White	666233 91306	6
8"	Polishing - Black	666233 91307	6
8"	Finishing - Blue	666233 91308	6
3.5"	Cutting - Orange	666233 91319	6
3.5"	Polishing - Black	666233 91320	6
3.5"	Finishing - Blue	666233 91321	6
Double-Sided CCS Waffle Foam Pads			
8"	Cutting - White	666233 91310	6
8"	Polishing - Black	666233 91311	6
8"	Finishing - Blue	666233 91312	6
Cutting Wool Pads			
8"	Single-Sided	666233 91315	6
3.5"	Single-Sided	666233 91318	6
8"	Double-Sided	666233 91309	6
Accessories			
8"	Single-Sided Back-up Plate	666233 91314	6
8"	Double-Sided Pad Adapter	666233 91313	6
3.5"	Single-Sided Back-up Plate	666233 91316	6
3" and 6"	Rotary Extensions	666233 91317	6

Farecla



POLISHING SYSTEM

DESCRIPTION	PART #	CASE
G360 Super Fast Compound	666233 90600	6
G360 Super Fast Finish	666233 90601	6





MASKING TAPE



SIZE	PG	AM	CASE
(3/4") 18mm x 54.8m	087143 00310	087143 00314	48
(1") 24mm x 54.8m	087143 00311	087143 00315	36
(1-1/2") 36mm x 54.8m	087143 00312	087143 00316	24
(2") 48mm x 54.8m	087143 00313	087143 00317	24



MASKING TAPE



SIZE	OM	GT	CASE
(3/4") 18mm x 54.8m	087143 00306	077922 00552	48
(1") 24mm x 54.8m	087143 00307	077922 00553	36
(1-1/2") 36mm x 54.8m	087143 00308	077922 00554	24
(2") 48mm x 54.8m	087143 00309	077922 00555	24



BLUE FINE LINE TAPE



SIZE	32.9M (36YD) ROLL	CASE
(1/8") 3.17mm	662611 82688	15
(1/4") 6.35mm	662611 82686	14
(1/2") 12.7mm	662611 82685	13



TOOLS



SIZE/DESCRIPTION	PART #	CASE
Vacuum Random-Orbit Action Sander		
520 Hutchins 3/32" ProFinisher 6"	660614 01390	1
523 Hutchins 3/32" ProFinisher 3"	660614 01464	1
620 Hutchins 3/16" ProFinisher 6"	660614 01404	1
623 Hutchins 3/16" ProFinisher 3"	660614 01465	1
720 Hutchins 5/16" ProFinisher 6"	660614 01469	1
Vacuum Orbital Sander		
525 Hutchins 2-3/4 x 5-1/2" ProFinisher	660614 01547	1
Vacuum Pad		
759 Hutchins 2-3/4" x 8" ProFinisher	660614 01540	1

STRUCTURAL ADHESIVES



DESCRIPTION	SIZE	PART #	CASE
100EZ Plastic Repair Adhesive (Heat-Set)	300mL	808498 10043	6
108B Metal Bonding Adhesive (Medium)	225mL	808498 10005	6
109B Metal Bonding Adhesive (Medium)	50mL	808498 10006	12
110B Metal Bonding Adhesive (Fast)	225mL	808498 10035	6
111B Metal Bonding Adhesive (Fast)	50mL	808498 10007	12
112B Metal Bonding Adhesive (Slow)	225mL	808498 10036	6
113B Metal Bonding Adhesive (Slow)	50mL	808498 10008	12
2098 Crash Durable Structural Adhesive (Slow)	6.59oz.	808498 10172	6
114LG Plastic Finishing Adhesive (Fast)	300mL	808498 10167	6
114SM Plastic Finishing Adhesive (Fast)	50mL	808498 10166	12
121 Flexible Foam (Super Fast)	300mL	808498 10058	6
124 Flexible Foam (Super Fast)	50mL	808498 10011	12
123 Non-Sag Seam Sealer (Fast)	300mL	808498 10041	6
126 Non-Sag Seam Sealer (Fast)	50mL	808498 10037	12
123EZ Non-Sag Seam Sealer (Medium)	300mL	808498 10045	6
129 Controlled Flow Seam Sealer (Fast)	300mL	808498 10075	6
130 Rigid Foam (Super Fast)	300mL	808498 10129	6
132 Plastic Repair Adhesive (Super Fast)	300mL	808498 10168	6
133 Plastic Repair Adhesive (Super Fast)	50mL	808498 10169	12
141 Clear Plastic Bonding Adhesive (Fast)	300mL	808498 10034	6
140 Clear Plastic Bonding Adhesive (Fast)	50mL	808498 10015	12
142 Plastic Repair Adhesive (Fast)	300mL	808498 10029	6
143 Plastic Repair Adhesive (Fast)	50mL	808498 10030	12
147 Plastic Bonding Adhesive (Medium)	300mL	808498 10042	6
152 Plastic Repair Adhesive (Medium)	300mL	808498 10106	6
153 Plastic Repair Adhesive (Medium)	50mL	808498 10107	12
208B Panel Bonding Adhesive (Slow)	300mL	808498 10175	6
231 Sound Dampening Material	300ml	666233 90998	6
234 Sound Dampening Material	50ml	666233 90999	12
800DTM (Neutral) Direct-to-Metal Adhesive/Sealer	281mL	808498 10170	12
803DTM (Black) Direct-to-Metal Adhesive/Sealer	281mL	808498 10171	12
802HD High Definition Sprayable Sealer	310.5mL	808498 10158	12
804HD High Definition Sprayable Sealer	310.5mL	808498 10159	12
805HD High Definition Sprayable Sealer	310.5mL	808498 10160	12
806HD High Definition Sprayable Sealer	310.5mL	808498 10161	12





Refinish Solutions Group



Your Productivity Partner





CATALOG 200

PROFESSIONAL SHARPENING PRODUCTS AND DRESSING STICKS



GENERAL INFORMATION	2
BENCHSTONES	6
LUBRICANTS	9
MULTI-FUNCTIONAL CASES	9
WATERSTONES	10
SHARPENING SYSTEMS / STATIONS	11
INSTRUCTIONAL DVDS	13
STONE ROLL KITS	14
ABRASIVE FILES	15
ABRASIVE SLIPS	19
SPECIALTY STONES	22
POCKET STONES	24
RUBBING BRICKS	25
DIY RETAIL PACKS	26
CUTLERY / FOOD SERVICE RETAIL PACKS	27
DIAMOND BENCHSTONES	28
DIAMOND LAPPING COMPOUND	29
DRESSING STICKS	30

The Norton Pike Story

The birth of the sharpening stone industry in the United States dates back to 1823 in a small village of New Hampshire, when a farmer discovered that stones in his pasture were ideal for sharpening scythes and axes. This excellent deposit of mica schist became the foundation for the Pike Company – the first supplier of commercially available natural sharpening stones in North America.

Using the nearby Connecticut River for transportation, the Pike Company was able to distribute the product of its quarries to a broad regional, national, and eventually, world market. As time went on, the company expanded its original product offering to include over twenty varieties of natural stone, including the Arkansas line. Quarried from the novaculite deposits near Hot Springs, AR, these stones soon replaced mica schist as the quality standard in premium



natural sharpening stones. They remain so today - no other stone can approach their fine performance characteristics.

As Norton developed its position in synthetic abrasives, Pike Company complemented its natural stone line with the new aluminum oxide and silicon carbide bonded abrasives. This strengthened its position in that portion of the market requiring fast-cutting, heavy-stock-removing sharpening stones.

During this period, the Pike Company consolidated its operations in Littleton, New Hampshire. In 1932, after years of close association, Norton Company purchased the Pike Company. Norton Company was subsequently purchased by Saint-Gobain Abrasives, Inc. (the global leader in abrasive sales and technology). Norton continues to serve world markets with the broadest line of natural and synthetic sharpening stones available.

How To Order Product

To enable your authorized Norton Distributor to fill your order quickly and accurately, please be sure to include your billing and shipping address, purchase order number, and the following product information:

- **UPC Number** – the 11 digit product code found in each product availability chart to the right of the product description.
- **Item Description** – identifies the type of product ordered, such as benchstone, file, rubbing brick, etc.
- **Size and Dimensions** – such as length x width x height (6 x 2 x 1) for a benchstone.
- **Product Specification** – example Medium Crystolon
- **Product Number** – such as MJB6 benchstone
- **Quantity Ordered** – the quantity of pieces ordered – not the number of cases (example: 5 benchstones, not 1 case). Quantities are listed in each product availability chart.

To determine the price of any item in this catalog, contact your Norton Distributor. For a listing of authorized Norton Distributors in your local trading area, call us at the Customer Service numbers below.

Norton Sharpening Stones Marking System Guide

EXAMPLE: **MJF234** = MEDIUM CRYSTOLON FILE, ROUND, 3/8" x 4"

NOTE: This chart is intended as a reference guide only. Not all products will meet this convention.

M J F 2 3 4

ABRASIVE GRIT SIZE*	ABRASIVE TYPE	PRODUCT TYPE	SHAPE	THICK/WIDTH	LENGTH
C = coarse (A100, 37C100)	J = Crystolon (Silicon Carbide)	B = Benchstone	0 = Square	1 = 1/4"	2 = 2"
M = medium (A240, 37C150)	Blank = India (Aluminum Oxide)	E = Jointer Stone	1 = Triangle	2 = 5/16"	3 = 3"
F = fine (A320, 37C280)	Hard or Soft Arkansas is indicated in abrasive size position	F = File	2 = Round	3 = 3/8"	4 = 4"
S = Soft Arkansas (400-600)		M = Mounted Benchstone	3 = Half Round	4 = 1/2"	5 = 5"
H = Hard Translucent Arkansas (1500-2000)		P = Pocket Stone	4 = Silversmith	5 = 5/8"	6 = 6"
*Pike product is ungraded		S = Slip	5 = Tapered Triangle	6 = 3/4"	
			6 = Tapered Round	7 = 1"	
			7 = Other		

Abrasive Features and Applications

Man-made/Synthetic Stones are manufactured with abrasives graded to a consistent particle size, blended with selected bonding agents, molded to shape, and finished to exacting surface configurations.

- **Crystolon®** stones, manufactured with silicon carbide abrasives, are the best choice for quick sharpening where the speed in producing the edge is more important than the fineness of the cutting edge. Gray in color. Available in coarse, medium and fine grits.
- **India®** stones, manufactured with aluminum oxide abrasives, are preferred for imparting durable, smooth-cutting edges and for close tolerances. Orange/brown in color. Available in coarse, medium and fine grits.

100% Natural Stones are quarried from the finest Ozark novaculite (silicon quartz) deposits, precision sawn to size, and finished to exacting surface configurations. Although there are no industry established standards for classifying hardness, particle size, or color of natural stones, the standards established by Norton nearly 100 years ago are accepted by most knowledgeable sources as industry standards. However, all suppliers do not adhere to these standards; some choose to classify and label sharpening stones at their own discretion. This has resulted in much confusion for users, who experience widely varying performance levels between similarly

identified stones of different manufacturers. Norton guarantees a given product will duplicate performance stone after stone. For this reason, we have trademarked the Norton Arkansas Stones as a guarantee of Norton quality and performance. When sharpening, these Arkansas stones do not remove as much metal as man-made stones; hence tools and knives last significantly longer. Due to their unique crystalline structure, Arkansas stones polish as they sharpen, imparting a keen, smooth edge/surface.

- **Norton Soft Arkansas®** (extra fine) stones are the coarsest-grained and least dense of the natural stones. Used primarily to sharpen and upgrade tool and knife edges to an even, polished surface, frequently after sharpening with synthetic stones. Opaque milky-white in color.
- **Norton Hard Translucent Arkansas®** (ultra fine) stones are the finest-grained and most dense natural stone available. Used to produce the keenest, most precise finish possible. They impart polished, razor-like edges. Translucent white in its purest form, hard translucent Arkansas may contain shades of red, yellow and gray. Translucent stones are named for their ability to let light pass through.

Note: color variations in these stones are the result of geological events that have occurred over many millions of years and will not affect the performance of the stone.

Application Guide and Page Index

Benchstones – pages 6-10

APPLICATION	COARSE/MEDIUM SHARPENING	FINE STONING	FINISH HONING
Chip Breakers	-	Fine Crystolon Benchstone	-
Draw Knives	Coarse Crystolon Benchstone	Fine India Benchstone	Hard Arkansas Benchstone
Scrapers	Coarse Crystolon Benchstone	Fine India Benchstone	Hard Arkansas Benchstone
Chisels (Wood)	Coarse Crystolon Benchstone Waterstone	Fine India Benchstone Waterstone	Hard Arkansas Benchstone Waterstone
Plane Blades	Coarse Crystolon Benchstone Waterstone	Fine India Benchstone Waterstone	Hard Arkansas Benchstone Waterstone

Slips – pages 19-22

APPLICATION	COARSE/MEDIUM SHARPENING	FINE STONING
Milling Cutter	Medium India Round Edge Slip	Fine India Round Edge Slip
Carbide Tools		Fine Crystolon Slip for Carbide Tools
Carving Tools	Medium India Carving Tools Slip	
Gouges (Wood)	-	Fine India Gouge Stone

Abrasive Files – pages 14-18

APPLICATION	COARSE/MEDIUM SHARPENING	FINE STONING	FINISH HONING
Form Cutter	Coarse or Medium India Knife Blade	Fine India Knife Blade	-
Keyways	Coarse or Medium India Square File	Fine India Square File	-
Lathe Bits	Medium India Square File	Fine India Square File	-
Radius Tools	Medium India Round File	Fine India Round File	-
Reamers	Medium India Reamer Stone+	Fine India Reamer Stone+	-
Router Bits	-	Fine India Square File	-
Saws	Coarse India Triangular File	Fine India Tapered Triangular File	-
Center Punches	Medium India Triangular File	Fine India Triangular File	-
Magnetic Chucks	Medium Crystolon Round File	Fine India Round File	-
Molding Cutters*	Coarse or Medium India File	Fine India File	-
Countersinks	Coarse India Triangular File	Fine India Triangular File	Hard Arkansas Triangular File
Tap Threads	-	Fine India Triangular File	-

* SELECT SHAPE TO FIT CONFIGURATION
+ REAMER STONES ARE FOUND ON PAGE 23

Rubbing Bricks – page 25

APPLICATION	RUBBING BRICK
Castings (scouring)	Crystolon Plain Rubbing Brick
Mold Marks (removing)	Crystolon Fluted Rubbing Brick

Relative Sharpening Comparisons for Norton Stone Products

CRYSTOLON (SILICON CARBIDE) INDIA (ALUMINUM OXIDE)	ARKANSAS (SOFT, HARD TRANSLUCENT)	DIAMOND STONES	WATERSTONES		COATED ABRASIVES (WATERPROOF SANDPAPER)		DIAMOND COMPOUND MICRON SIZE
			JIS (JAPAN)	CAMI (USA)	FAPA (EUROPE)		
Coarse Crystolon		Diamond			P100	141	
					P120	127	
Coarse India					120	116	
					P150	97	
Medium Crystolon		Extra Coarse Diamond (220)	Norton 220		150	93	
					180	78	
Medium India					220	65	
					P220	60	
Medium Crystolon					P240	58	
					240	53.5	
Medium India					P280	52.5	
						50	
Fine Crystolon		Coarse Diamond (325)			P320	46	
					280	45	
Fine India					P360	40.5	
					360	36	
Fine Crystolon					P400	35	
					360	29	
Fine India					P600	25.8	
					400	23	
Ex. Fine India	Soft Arkansas	Fine Diamond (600)	600		P800	22	
					800	20	
Ex. Fine India					P1200	16	
					Norton 1000	14	
Ex. Fine India		Extra Fine Diamond (1200)	1200		800	12.6	
					P1500	11	
Ex. Fine India					P2000	10.3	
					1500	9.2	
Ex. Fine India					9	9	
					1500	8.4	
Ex. Fine India	Hard Translucent Arkansas				P2500	7.5	
					Norton 2000	6	
Ex. Fine India					Norton 4000	6	
					2000	5	
Ex. Fine India					Norton 8000	3	
					8000	1.2	
Ex. Fine India					1	1	
					15000	0.5	

Stock and Non-Stock

If our comprehensive standard stock line does not provide a completely suitable product offering for individual needs, different grades, shapes and dimensional tolerances can be manufactured on special order. All non-stock requests should be referred to Customer Service Sharpening Stones.

Product Warranty

WARRANTY – Norton warrants the products in this catalog to be free from defects in material or workmanship for a period of one year from the date of purchase. Norton's sole obligation under this warranty shall be to repair or replace, at Norton's option, any product which is non-conforming provided any such product failure was not caused by a subsequent modification of the product, misuse or a failure to follow any applicable instructions for the product.

EXCEPT FOR THE FOREGOING, NORTON EXPRESSLY DISCLAIMS ALL OTHER GUARANTIES AND/OR WARRANTIES, EXPRESS OR IMPLIED, INCLUDING THE WARRANTIES OF MERCHANTABILITY AND FITNESS FOR A PARTICULAR PURPOSE.

Liability Limitation

NORTON'S LIABILITY FOR ANY LOSS OR DAMAGE ARISING OUT OF OR RESULTING FROM THE USE OF THE PRODUCT SHALL NOT EXCEED THE PURCHASE PRICE THEREOF, REGARDLESS OF WHETHER SUCH LIABILITY ARISES IN CONTRACT, TORT (INCLUDING WITHOUT LIMITATION NEGLIGENCE OR STRICT LIABILITY), OR OTHERWISE, AND IN NO EVENT SHALL NORTON BE LIABLE FOR INDIRECT, SPECIAL, INCIDENTAL OR CONSEQUENTIAL DAMAGES OF ANY KIND. NO REPRESENTATIVE OF NORTON, NOR ANY OF NORTON'S DISTRIBUTORS OR DEALERS, IS AUTHORIZED TO MODIFY THIS WARRANTY OR ISSUE ANY WARRANTY REGARDING THE PRODUCTS IN THIS CATALOG.

Trademarks

The following names and designs are trademarks used by Saint-Gobain Abrasives.

ALUNDUM®
CRYSTOLON®
INDIA®

MULTI-OILSTONE®
NORTON®
NORTON HARD TRANSLUCENT ARKANSAS®

NORTON SOFT ARKANSAS®
TUFBAK®
AND OTHERS



A TOOL IS ONLY AS GOOD AS ITS EDGE™

SAINT-GOBAIN

Sharpening Basics

Knives and Blades

Most manufacturers ship their cutting tools without keen edges to avoid damage in transit. The blades need a good sharpening to realize their full potential. Use the largest stone affordable for a straight edge as it allows use of full surface for wider tools.

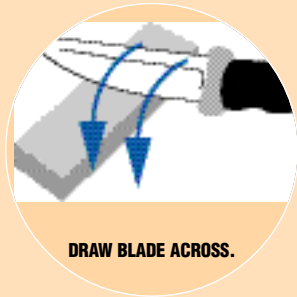

DRAW BLADE ACROSS.

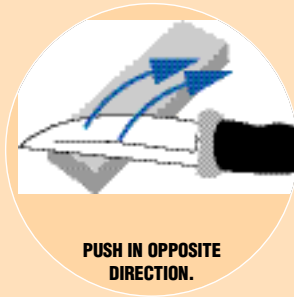

PUSH IN OPPOSITE DIRECTION.

1. Place the heel of the blade flat on the stone in a perpendicular or slightly angled position.
2. Tilt the back of the blade up to the desired angle (15° to 30° depending on the application: 15° for filet knives, 23° for kitchen or pocket knives, and 30° for cleavers).
3. Holding wrists rigid, draw the blade diagonally against the surface for the length of the stone – like you were trying to take a thin slice of the stone – beginning at the heel of the knife and ending at the top.
4. Flip the blade over and repeat from the opposite end. Continue this action until a wire edge appears.
5. Then move to the next finer stone and repeat until sufficiently sharp.

NOTE: IT IS VERY IMPORTANT THAT THE ANGLE PRESENTED TO THE STONE AT THE BEGINNING OF THE PROCESS BE MAINTAINED THROUGHOUT THE SEQUENCE.

Woodworking Tools

The procedures and products used for sharpening straight-edged woodworking tools are widely debated by woodworking experts. Today there are many combinations of products that can provide the finish and sharpness for every level of woodworking project. Norton abrasives, alone, provide all the products for every method of choice. Outlined below are the basic procedures and product recommendations by steps.

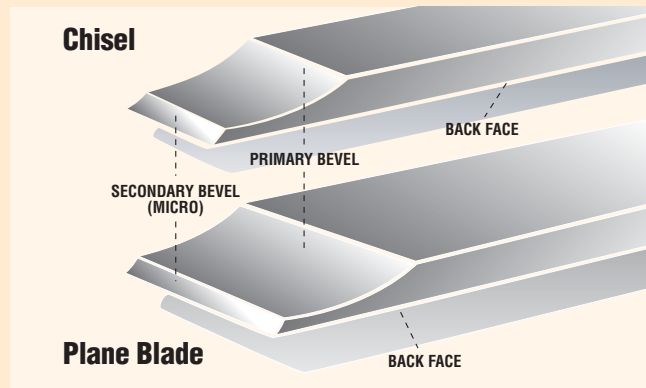

PROCEDURE	OIL STONE SYSTEM	WATERSTONE SYSTEM	
BACK FACE			
Steps 1-4 are only needed on new tools or damaged tools. The flatter and more polished the back is, the sharper the cutting edge will be and the longer it will stay sharp.			
Step 1*	Heavy stock removal	Cryston – Coarse	220 grit
Step 2*	Light stock removal	India – Medium or Fine	1000 grit
Step 3	Final finishing and polishing	Norton Hard Translucent Arkansas	4000 grit
Step 4	Highly reflective polishing	1 Micron Diamond Compound ***	8000 grit
PRIMARY BEVEL			
Step 5 is done on new tools or whenever a tool is damaged. Otherwise, this step is done every 10-15 resharpenings of the secondary (micro) bevel.			
Step 5 (Option 1)	Creating a concave primary bevel – hollow grinding**	Bench wheel – 38A60-J	Bench wheel - 38A60-J
Step 5 (Option 2)*	Creating a flat primary bevel	India – Medium or Fine	1000 grit
SECONDARY (MICRO) BEVEL			
Steps 6-8 are done frequently to keep tools in excellent condition. Each step should be done until a burr or wire edge forms. This burr or wire edge is a signal that it is time to move to the next step. This wire edge must be removed and is done by alternately rubbing the back face and secondary angle of the tool on the finest stone until the wire edge falls off. If the wire edge does not fall off with this procedure, check the back of the tool for flatness.			
Step 6*	Initial sharpening or resharpening	India - Medium or Fine	1000 grit
Step 7	Final finishing & polishing	Norton Hard Translucent Arkansas	4000 grit
Step 8	Highly reflective polishing	1 Micron Diamond Compound***	8000 grit

* OTHER ABRASIVE PRODUCTS SUCH AS DIAMOND BENCHSTONES, DIAMOND COMPOUND AND COATED ABRASIVES WILL PERFORM STEPS 1, 2, 5 & 6. SEE PAGES 28 AND 29.

** HOLLOW GRINDING IS DONE ON A BENCH GRINDER: 6" WHEELS ARE RECOMMENDED FOR A SLIGHTLY LARGER CURVATURE.

*** DIAMOND COMPOUND MUST BE USED ON A VERY FLAT SURFACE TO ACHIEVE THE HIGHLY REFLECTIVE POLISH. (SEE PAGE 29)

tip Sharpness Testing – Woodworking Tools

The first way to tell is visual; a sharp edge reflects no light. Once this is done, it is recommended that the tool be tested by slicing down on an end grain of soft pine. If the end grain is ragged, the tool is not sharp enough. If there are only scratches on the end grain, tiny fragments of the wire edge may be left and continued polishing is needed. A truly sharp blade will leave a cut on the end grain that looks almost burnished.

Norton offers a line of both synthetic (Crystolon and India) and Natural (Hard and Soft Arkansas) abrasive benchstones. Choose one stone or a sequence of stones to quickly restore the cutting edge on all straight-edge tools.

All oil stones are porous in nature. Oil is required to keep the pores open and working efficiently.

Typical applications include restoring the cutting edge on straight-edged tools such as chisels, plane blades, wood lathe cutters, draw knives, spoke shaves, knives, and precision tools and delicate instruments.



SPECcheck

Benchstone Troubleshooting Guide

PROBLEM	POSSIBLE CAUSE	CORRECTION
Clogging, glazing or loading of the stone surface	Insufficient lubrication to suspend residue	Saturate the stone surface with Norton oil
Excessive metal removal from tool edge	Stone is too coarse Stone is too soft	Use a finer grit Use a different abrasive type
Tool edge breaks down quickly	Poor quality steel Edge too thin	Use higher quality tool Correct edge angle to duplicate original edge angle (knives = 15° to 20°)
Tool edge not sharp enough	Stone is too coarse	Hone with finer grit or choose an India or Arkansas abrasive
Tool doesn't cut properly	Check for correct bevel angle Check for wire edge Edge out of true (rounded corners)	Change bevel angle to duplicate original edge angle Remove wire edge by running across a piece of hardwood once or twice Vertically pass tool over benchstone to square corners

Choose one or a sequence of benchstones to restore a cutting edge

Use oil

- For best benchstone performance, to keep stones free cutting, with no loading or gumming, use stones with oil.
- If stones do gum-up or load, clean with kerosene or warm soapy water

Use of stones on flat tools

- Flat-bladed tools require flat stones. All benchstones (except diamond) can be flattened by rubbing on waterproof sandpaper against a flat surface.

Use of stones on round or shaped tool

- Shaped tools require shaped stones.
- Select an appropriately-shaped abrasive file or slip.

Maintain correct tool edge bevel angle

- Many knives and tools have 2 bevels:
 - The blade bevel (the back of the edge), once correctly set, is seldom sharpened.
 - The edge bevel does the cutting – and requires sharpening to 15 to 20 degrees.
 - Too acute an edge bevel will weaken, dull quickly and breakdown.
 - Too obtuse an edge bevel will not cut properly.

The final step

- Sharpening often leads to a minute burr (wire edge) on the tool.
- Remove this by "stropping" the tool on leather or hard wood for the best cutting edge.



While sharpening knives, blades and tools, be careful to keep fingers away from sharp edges.

Single Grit Abrasive Benchstones

Single Grit Abrasive Benchstones

FEATURES	BENEFITS
<ul style="list-style-type: none"> • Crystolon – Premium silicon carbide abrasive 	<ul style="list-style-type: none"> • Fast cutting stone; ideal for general sharpening of cutting tools • Fast stock removal for quick edge shaping with minimal loading
<ul style="list-style-type: none"> • India – Smooth cutting aluminum oxide abrasive, our patent for a fine finish 	<ul style="list-style-type: none"> • Long lasting cutting edge • The choice of artisans, craftsmen and mechanics • Ideal for clean deburring, generating keen edges and quality finishes
<ul style="list-style-type: none"> • Arkansas – Natural premium Novaculite quarried in Arkansas and available in Soft and Hard Translucent 	<ul style="list-style-type: none"> • Sharpest possible razor edges • Near mirror finishes • Use for finer honing after India stone
<ul style="list-style-type: none"> • Ohio Bluestone – Soft-graded natural stone quarried in Ohio 	<ul style="list-style-type: none"> • Produces finely honed edges and excellent finishes



A TOOL IS ONLY AS GOOD AS ITS EDGE™

BENCHSTONES

SIZE L x W x H	QTY. PKG.	QTY. CASE	SPECIFICATION	PRODUCT NO.	UPC NO.
CRYSTOLON (SILICON CARBIDE) BENCHSTONES					
SINGLE GRIT					
4 x 1 x 1/4	1	5	Coarse	CJB14	61463685470 0
4 x 1 x 1/4	1	5	Medium	MJB14	61463685465 6
4 x 1 x 1/4	1	5	Fine	FJB14	61463685460 1
4 x 1 x 1/2	1	5	Coarse	CJB24	61463685485 4
4 x 1 x 1/2	1	5	Medium	MJB24	61463685480 9
4 x 1 x 1/2	1	5	Fine	FJB24	61463685475 5
5 x 2 x 5/8	1	5	Medium	MJB35	61463685495 3
5 x 2 x 5/8	1	5	Fine	FJB35	61463685490 8
6 x 2 x 1	1	5	Coarse	CJB6	61463685510 3
6 x 2 x 1	1	5	Medium	MJB6	61463685505 9
6 x 2 x 1	1	5	Fine	FJB6	61463685500 4
8 x 2 x 1	1	5	Coarse	CJB8	61463685525 7
8 x 2 x 1	1	5	Medium	MJB8	61463685520 2
8 x 2 x 1	1	5	Fine	FJB8	61463685515 8
8 x 3 x 1/2	1	5	Coarse – Replacement Stone for IM83	CJB83	61463654459 5
8 x 3 x 1/2	1	5	Medium – Replacement Stone for IM83	MJB83	61463654458 8
8 x 3 x 1/2	1	5	Fine – Replacement Stone for IM83	FJB83	61463654457 1
11-1/2 x 2-1/2 x 1/2	1	2	Coarse – Replacement Stone for IM313	JM3	61463685980 4
11-1/2 x 2-1/2 x 1/2	1	2	Medium – Replacement Stone for IM313	JM6	61463685975 0
INDIA (ALUMINUM OXIDE) BENCHSTONES					
SINGLE GRIT					
4 x 1 x 1/4	1	5	Coarse	CB14	61463685580 6
4 x 1 x 1/4	1	5	Medium	MB14	61463685575 2
4 x 1 x 1/4	1	5	Fine	FB14	61463685570 7
4 x 1 x 1/2	1	5	Coarse	CB24	61463685595 0
4 x 1 x 1/2	1	5	Medium	MB24	61463685590 5
4 x 1 x 1/2	1	5	Fine	FB24	61463685585 1
5 x 2 x 5/8	1	5	Medium	MB35	61463685605 6
5 x 2 x 5/8	1	5	Fine	FB35	61463685600 1
6 x 2 x 1	1	5	Coarse	CB6	61463685620 9
6 x 2 x 1	1	5	Medium	MB6	61463685615 5
6 x 2 x 1	1	5	Fine	FB6	61463685610 0
8 x 2 x 1	1	5	Coarse	CB8	61463685635 3
8 x 2 x 1	1	5	Medium	MB8	61463685630 8
8 x 2 x 1	1	5	Fine	FB8	61463685625 4
8 x 3 x 1/2	1	5	Coarse – Replacement Stone for IM83	CB83	61463654462 5
8 x 3 x 1/2	1	5	Medium – Replacement Stone for IM83	MB83	61463654461 8
8 x 3 x 1/2	1	5	Fine – Replacement Stone for IM83	FB83	61463654460 1
11-1/2 x 2-1/2 x 1/2	1	2	Medium – Replacement Stone for IM313	IM6	61463654214 0
11-1/2 x 2-1/2 x 1/2	1	2	Fine – Replacement Stone for IM313	IM9	61463685970 5
ARKANSAS BENCHSTONES					
SINGLE GRIT HARD TRANSLUCENT ARKANSAS					
4 x 2 x 3/4-1	1	5	Ultra Fine	HB4	61463685655 1
6 x 2 x 3/4-1	1	5	Ultra Fine	HB6	61463685660 5
6 x 2 x 3/4-1	1	5	Ultra Fine w/ Wooden Box	HM6	61463685930 9
8 x 2 x 3/4-1	1	5	Ultra Fine	HB8	61463685665 0
8 x 2 x 3/4-1	1	2	Ultra Fine w/ Wooden Box	HM8	61463685935 4
8 x 3 x 1/2	1	5	Ultra Fine – Replacement Stone for IM83	HTB83	61463654464 9
11-1/2 x 2-1/2 x 1/2	1	1	Ultra Fine – Replacement Stone for IM313	HM11	61463685965 1
SINGLE GRIT SOFT ARKANSAS					
3 x 1 x 3/8	5	10	Extra Fine	SB13	61463687560 6
4 x 2 x 3/4-1	1	5	Extra Fine	SB4	61463685670 4
6 x 2 x 3/4-1	1	5	Extra Fine	SB6	61463685675 9
8 x 2 x 3/4-1	1	5	Extra Fine	SB8	61463685680 3
11-1/2 x 2-1/2 x 1/2	1	1	Extra Fine – Replacement Stone for IM313	SM11	61463653897 6
11-1/2 x 2-1/2 x 1	1	2	Extra Fine	SB11	61463653901 0
ECONOMY BENCHSTONES - OHIO BLUESTONE					
SINGLE GRIT (BULK PACKED)					
4 x 2 x 3/4-1	1	10	Medium	KB4	61463685720 6
6 x 2 x 3/4-1	1	10	Medium	KB6	61463685725 1
8 x 2 x 3/4-1	1	5	Medium	KB8	61463685730 5
OIL STONE STARTER KIT					
8 x 3 x 1/2	1	1	1 Medium, India, 1 Ultra Fine Hard Arkansas, 4.5 oz Oil and Instructional DVD		07660787942 4
OIL STONE INSTRUCTIONAL DVD					
N/A	1	1	Oil Stone DVD		07660787945 5

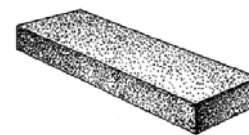

tip Use Norton oil to optimize the performance of Crystolon, India and Arkansas stones.

While sharpening knives, blades and tools, be careful to keep fingers away from sharp edges.

Combination Grit Abrasive Benchstones

Combination Grit Abrasive Benchstones

FEATURES AND APPLICATIONS

Crystolon Combination

Coarse and fine grit sharp-cutting silicon carbide abrasive surfaces for general sharpening (to moderate tolerances) when the speed of sharpening is more important than the fineness of the cutting edges. Gray in color.

India Combination

Coarse and fine grit aluminum oxide abrasive surfaces produce strong, keen, long-lasting edges on quality tools. Orange/brown in color.

Crystolon/India Combination

Fast-sharpening, medium grit silicon carbide (Crystolon) and fine aluminum oxide (India) abrasive surfaces for keen, long-lasting edges on quality tools. Crystolon side is dark gray in color, India side is orange.

India/Soft Arkansas Combination

Coarse grit aluminum oxide (India) and extra fine grit Soft Arkansas surfaces for start-to-finish sharpening and honing. Preferred by woodworkers for sharpening straight blades and gouges. India side is brown; Arkansas side off-white.

India/Hard Translucent Arkansas Combination

Fine India aluminum oxide and ultra fine Hard Translucent Arkansas surfaces produce the finest edges. Produces a highly polished finish. Orange/off-white in color.

Soft/Hard Translucent Arkansas Combination

Extra fine grit Soft Arkansas surfaces and ultra fine grit Hard Translucent Arkansas surfaces for finest edges and tightest tolerances. Produces a highly polished finish. Off-white in color.

Giant Combination Stones

11-1/2" and 12" bench oil stones are used to sharpen large edge tools with long sweeping strokes.

SIZE L X W X H	QTY. PKG.	QTY. CASE	SPECIFICATION	PRODUCT NO.	UPC NO.
CRYSTOLON (SILICON CARBIDE) BENCHSTONES					
COMBINATION GRIT					
4 x 1 Round	1	5	Coarse/Fine	JB64	61463685435 9
4 x 1-3/4 x 5/8	1	5	Coarse/Fine	JB134	61463685440 3
5 x 2 x 3/4	1	5	Coarse/Fine	JB45	61463685445 8
6 x 2 x 1	1	5	Coarse/Fine with Anniversary Box	JB6	61463685450 2
8 x 2 x 1	1	5	Coarse/Fine with Anniversary Box	JB8	61463685455 7
11-1/2 x 2-1/2 x 1	1	2	Coarse/Fine	JUM3	61463685840 1
12 x 2-1/2 x 1-1/2	1	2	Coarse/Fine	JUM4	61463685855 5
INDIA (ALUMINUM OXIDE) BENCHSTONES					
COMBINATION GRIT					
4 x 1 Round	1	5	Coarse/Fine	IB64	61463685545 5
4 x 1-3/4 x 5/8	1	5	Coarse/Fine	IB134	61463685550 9
5 x 2 x 3/4	1	5	Coarse/Fine	IB45	61463685555 4
6 x 2 x 1	1	5	Coarse/Fine with Anniversary Box	IB6	61463685560 8
8 x 2 x 1	1	5	Coarse/Fine with Anniversary Box	IB8	61463685565 3
11-1/2 x 2-1/2 x 1	1	2	Coarse/Fine	IM2	61463685851 7
CRYSTOLON/INDIA BENCHSTONES					
COMBINATION GRIT					
6 x 2 x 1	1	5	Medium/Fine	IC6	61463685643 8
11-1/2 x 2 x 1	1	2	Medium/Fine	IC11	61463687239 1
INDIA/SOFT ARKANSAS BENCHSTONES					
COMBINATION GRIT					
6 x 2 x 1	1	5	Coarse/Extra Fine	SIB6	61463685700 8
8 x 2 x 1	1	5	Coarse/Extra Fine	SIB8	61463653908 9
11-1/2 x 2-1/2 x 1	1	1	Coarse/Extra Fine	SIB11	61463653920 1
INDIA/HARD TRANSLUCENT ARKANSAS BENCHSTONES					
COMBINATION GRIT					
7 x 2 x 1	1	1	Fine/Ultra Fine with Wooden Box	HIB27	61463685865 4
SOFT/HARD TRANSLUCENT ARKANSAS BENCHSTONES					
COMBINATION GRIT					
8 x 2 x 1	1	5	Extra Fine/Ultra Fine	HSB8	61463653909 6
11-1/2 x 2-1/2 x 1	1	2	Extra Fine/Ultra Fine	HSB11	61463653921 8
ECONOMY BENCHSTONES - ALUMINUM OXIDE					
COMBINATION GRIT (BULK PACKED)					
8 x 2 x 1		5	Coarse/Fine	UPB8	61463685755 8

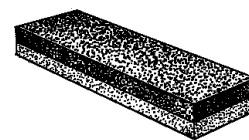



Benchstone Performance Attributes

ABRASIVE	FAST CUT		SHARPENING		HONING	SHARPEST EDGE	
Grit Size	Coarse	Medium	Fine	Extra Fine		Ultra Fine	
Product	Diamond	Crystolon	India	Soft Arkansas	Waterstone	Hard Arkansas	
Color	Silver Metallic	Grey	Orange/ Brown	Milky White	Orange to White	Translucent	

Precision Benchstones

Precision Benchstones

FEATURES AND APPLICATIONS

Jewelers' Benchstones – These stones are excellent for sharpening the fine, precision cutting tools used by jewelers, engravers and artisans.

Penknife Precision Benchstones – Ideal for sharpening cutting tools, laboratory blades, surgical instruments, engravers' and die makers' tools, and pocket knives to the keenest edge.

SIZE L x W x H	QTY. PKG.	QTY. CASE	SPECIFICATION	PRODUCT NO.	UPC NO.
JEWELERS' BENCHSTONES					
4 x 2 x 3/8	1	5	Ultra Fine – Hard Translucent Arkansas	HB24	61463687525 5
6 x 2 x 3/8	1	5	Ultra Fine – Hard Translucent Arkansas	HB26	61463687530 9
PENKNIFE PRECISION BENCHSTONES					
3 x 1 x 3/8	5	10	Ultra Fine – Hard Translucent Arkansas	HB13	61463687550 7
4 x 1 x 3/8	5	10	Extra Fine – Soft Arkansas	SB14	61463687565 1
4 x 1 x 3/8	5	10	Ultra Fine – Hard Translucent Arkansas	HB14	61463687555 2



Sharpening Stone Lubricants and Cases

Norton Oil

FEATURES AND APPLICATIONS

Norton Oil is a highly refined lubricating oil specifically formulated for sharpening stone use, but equally ideal for all lubricating jobs. It will not load or “gum-up” sharpening stones. Meets U.S. Pharmacopoeia standards for mineral oil purity; it may be used around food preparation operations.



Non-oil-based Sharpening Solutions



FEATURES AND APPLICATIONS

Initially designed for food service applications, these organic, biodegradable solutions provide lubrication essential to maintaining a good sharpening surface, and are also easy to clean off with just water – making them ideal for any application where cleanliness is key.



Multi-functional Cases



FEATURES AND APPLICATIONS

These, rugged plastic cases are ideal for stone storage and protection, and their no-slip feet keep them in place during sharpening. Use different colors to help distinguish various grits.



SIZE	QTY. PKG.	QTY. CASE	SPECIFICATION	PRODUCT NO.	UPC NO.
SHARPENING STONE OIL					
4-1/2 oz.	1	20	Oil	XB1	61463687760 0
1 Pint	1	20	Oil	XB5	61463687770 9
1 Quart	1	5	Oil	XB2	61463687775 4
SHARPENING NON-OIL SOLUTION					
new! 8 oz.	1	12	Unscented		66253072273 1
new! 8 oz.	1	12	Citrus-scented		66253072278 6

SIZE	QTY. PKG.	QTY. CASE	SPECIFICATION	UPC NO.
SHARPENING STONE CASES				
Fits Stones 8 x 2 x 1	1	5	Black IM150 case	61463691259 2 new!
Fits Stones 8 x 3 x 1/2	1	5	Grey	69936688098 4 new!
Fits Stones 8 x 3 x 1/2	1	5	Blue	69936635427 0 new!
Fits Stones 8 x 3 x 1/2	1	5	Orange	69936688095 3 new!
Fits Stones 8 x 3 x 1/2	1	5	Black	66253084636 9 new!
Fits Stones 11-1/2 x 2-1/2 x 1	1	5	Black	66253062898 9 new!

WATERSTONES

Waterstones are synthetic stones designed to be softer than oil stones. These softer grade stones are used with water as the lubricant (versus oil) to develop a fast cutting slurry. The Norton Waterstone system was designed in a carefully planned sequence to create sharpening efficiency. You get the level of abrasiveness you need at each stage, without wasting time trying to sharpen your tools on a grit that is too fine, too soon.



Waterstones – Produce superior edges for planes and straight chisels

FEATURES

- System of four synthetic “Japanese-type” stones designed to work together, with water
- Softer than traditional oilstones – providing lapping action

BENEFITS

- Fast sharpening, fine finish
- Superb results with low pressure

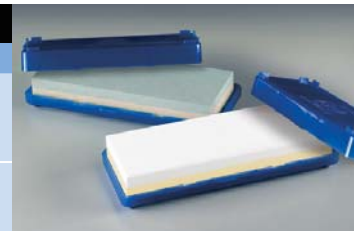

Prep Stone

FEATURES

- This synthetic stone raises the slurry

BENEFITS

- Speeds up the slurry-making process needed to cut and polish with waterstones

Flattening Stone

FEATURES

- Coarse grit silicon carbide stone
- Diagonal grooves
- Superbly flat with hard bond

BENEFITS

- Promotes maximum cutting for all grit sizes of waterstones
- Provide swarf removal
- Produces extremely flat results on all waterstones

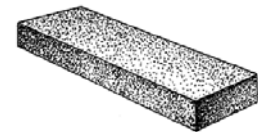
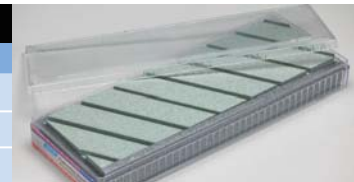

SIZE L X W X H	QTY. PKG.	QTY. CASE	GRIT/ABRASIVE	UPC NO.
WATERSTONES				
SINGLE GRIT (BULK-PACKED)				
8 x 3 x 1	1	5	220	61463689505 5
8 x 3 x 1	1	5	1000	61463689506 2
8 x 3 x 1	1	5	4000	61463689507 9
8 x 3 x 1	1	5	8000	61463689508 6
8 x 3 x 1 Set	1	1	4 Stones: 220, 1000, 4000, 8000 Grit	61463624334 4
COMBINATION GRIT (BULK-PACKED)				
8 x 3 x 1	1	5	220 / 1000	61463624335 1
8 x 3 x 1	1	5	1000 / 4000	61463624450 1
8 x 3 x 1	1	5	1000 / 8000	69936655039 9
8 x 3 x 1	1	5	4000 / 8000	61463624336 8
PREP STONE				
20mm x 20mm x 3"	1	5	Aluminum Oxide	66243439361 7
FLATTENING STONE WITH DIAGONAL GROOVES				
9 x 3 x 3/4	1	5	Silicon Carbide	69936687444 0
WATERSTONE STARTER KIT				
8 x 3 x 1	1	1	1 -220/1000, 1- 4000/8000, 1 Flattening Stone, and Instructional DVD	07660787943 1
WATERSTONE INSTRUCTIONAL DVD				
N/A	1	1	Waterstone DVD	07660787944 8

Maximizing Waterstone Performance

- Wet waterstone
- Rub evenly with the prep stone to create slurry
- Evening off the high spots will make for less-frequent flattening of the waterstones
- Waterstones wear concave with use; periodically flatten with flattening stone

tips

NORTON

SAINT-GOBAIN

A TOOL IS ONLY AS GOOD AS ITS EDGE™

SHARPENING SYSTEMS

Norton manufactures three types of sharpening systems to provide complete sharpening solutions: dual-stone sharpening kits, single-stone sharpening stations, and tri-stone rotating base systems. All offer a range of replacement stones, including some specifications beyond those supplied with the original purchase. This permits the user not only to replace worn or damaged stones, but to also substitute different specifications to tailor the unit to best suit his own requirement.



Dual-Stone Sharpening Starter Kits

Waterstone Starter Kit – For the new tool sharpener

new!

FEATURES AND BENEFITS

The two combination stones in this kit offer a complete grit range from 220 for major edge repair, to 8000 for producing a mirror finish. The coarse grit, silicon carbide flattening stone allows the user to quickly and easily maintain the waterstones. An instructional DVD, hosted by tool expert Joel Moskowitz, offers a step-by-step, freehand method for sharpening many woodworking tools.



Oil Stone Starter Kit – For the new woodworker

new!

FEATURES AND BENEFITS

This kit provides new woodworkers with the best stone/oil assortment to get started. The medium aluminum oxide (India) stone is ideal for imparting a durable, smooth cutting surface, while the ultra fine Hard Translucent Arkansas stone produces a polished, razor-like edge. The lubricating oil provided is specifically formulated for optimal lubricity. Woodworking expert, Maurice Fraser, offers his simple freehand sharpening method on the included instructional DVD.



SIZE L X W X H	QTY. PKG.	QTY. CASE	KIT INCLUDES	PRODUCT NO.	UPC NO.
WATERSTONE STARTER KIT					
new! 8 x 3 x 1	1	1	1 220/1000, 1 4000/8000, 1 Flattening Stone, and Instructional DVD		07660787943 1
OIL STONE STARTER KIT					
new! 8 x 3 x 1/2	1	1	1 Medium. India, 1 Ultra Fine Hard Arkansas, 4.5 oz Oil and Instructional DVD		07660787942 4

Single-Stone Sharpening Stations

IM50 Single-stone Workbench Stations

FEATURES AND BENEFITS

This durable ABS plastic case has non-slip rubber feet. The case acts as a small oil reservoir while sharpening, and also provides clean storage when not in use. Fits all 8 x 2 and 6 x 2 bench stones (see pages 6-8).

All IM50 stations include 1 sharpening stone, 4-1/2 oz oil, plastic angle guide and a storage case.

- IM50 Coarse/Fine Crystolon Combination stone – for sharpening and finishing
- IM50-C Coarse Crystolon stone – for rapid stock removal
- IM50-I Medium India stone – for light stock removal and initial sharpening



SIZE L X W X H	QTY. PKG.	QTY. CASE	KIT INCLUDES	PRODUCT NO.	UPC NO.
IM50 SINGLE-STONE STATIONS					
8 x 2 x 1	1	1	1 Coarse/Fine Crystolon Combination, 4-1/2 oz Oil, Angle Guide, Storage Case	IM50	61463653907 2†
8 x 2 x 1	1	1	1 Coarse Crystolon, 4-1/2 oz. Oil, Angle Guide, Storage Case	IM50-C	61463654860 9*
8 x 2 x 1	1	1	1 Medium India, 4-1/2 oz. Oil, Angle Guide, Storage Case	IM50-I	61463654861 6*
IM50 REPLACEMENT CASE					
8 x 2 x 1	1	5	IM50 Case, Black		61463691259 2

NOTE: SEE BENCHSTONE LISTINGS ON PAGE 6 – 8 FOR ALL 8 X 2 REPLACEMENT STONES.

† NON-STOCK; 2 WEEK LEAD-TIME * NON-STOCK; 3 WEEK LEAD-TIME

Tri-Stone Rotating Base Sharpening Systems

IM83 Portable Sharpening Stone Systems

new!



FEATURES AND BENEFITS

These unique "tool-box" portable systems allow you to sharpen tools wherever needed. Sturdy metal latches secure the cover and storage case – where small tools can be housed. The IM83 is designed like all our other sharpening systems; the stones can be replaced to customize the unit to individual requirements. These systems are ideal for industrial toolrooms, restaurants, knife manufacturers as well as home DIYers and sportsmen.

All IM83 systems include 3 sharpening stones, an instructional DVD in the base, and a reservoir carrying case. The oil stone systems also include 4-1/2 oz. oil.

IM83-W Portable Waterstone System – Tool Repair to Fine Finishes

This portable sharpening system is equipped with a carefully engineered sequence of waterstones for clean, efficient sharpening. The waterstones can easily be maintained with the flattening stone provided.

IM83-O Portable Oil Stone System – Straight-Edged Tool Sharpening

The coarse silicon carbide (Crystolon) stone in this system repairs damaged edges quickly; the medium aluminum oxide (India) stone imparts a durable, smooth cutting edge; and the fine aluminum oxide (India) stone provides the final sharpening and polishing stage.

IM83-A Portable Oil Stone System – Complete Woodworking Tool Maintenance

This system contains oilstones with a grit sequence specially designed for woodworking tools. The coarse silicon carbide (Crystolon) stone removes heavy stock; the medium aluminum oxide (India) is ideal for initial sharpening of new tools; and the ultra fine Hard Translucent Arkansas stone produces the most precise edge possible.



SIZE L X W X H	QTY. PKG.	QTY. CASE	KIT INCLUDES	PRODUCT NO.	UPC NO.
IM83 PORTABLE SYSTEMS					
new! 8 x 3 x 1	1	1	1 ea of 1000, 4000, 8000 Grit Waterstones, 1 Flattening Stone Instructional DVD in Base, Reservoir Carrying Case	IM83-W	66243582825 5
new! 8 x 3 x 1/2	1	1	1 Coarse Crystolon, 1 Medium India, 1 Fine India, 4-1/2 oz Oil, Instructional DVD in Base, Reservoir Carrying Case	IM83-O	66243582823 1
new! 8 x 3 x 1/2	1	1	1 Coarse Crystolon, 1 Medium India, 1 Ultra Fine Hard Arkansas, 4-1/2 oz Oil, Instructional DVD in Base, Reservoir Carrying Case	IM83-A	66243582824 8*
IM83 REPLACEMENT STONES					
8 x 3 x 1/2	1	5	Coarse Crystolon	CJB83	61463654459 5
8 x 3 x 1/2	1	5	Medium Crystolon	MJB83	61463654458 8
8 x 3 x 1/2	1	5	Fine Crystolon	FJB83	61463654457 1
8 x 3 x 1/2	1	5	Coarse India	CB83	61463654462 5
8 x 3 x 1/2	1	5	Medium India	MB83	61463654461 8
8 x 3 x 1/2	1	5	Fine India	FB83	61463654460 1
8 x 3 x 1/2	1	5	Ultra Fine Hard Arkansas	HTB83	61463654464 9
8 x 3 x 1	1	5	1000 Grit Waterstone		61463689506 2
8 x 3 x 1	1	5	4000 Grit Waterstone		61463689507 9
8 x 3 x 1	1	5	8000 Grit Waterstone		61463689508 6

* NON-STOCK; 3 WEEK LEAD-TIME

- The base of the tri-stone system acts as an oil reservoir permitting continuous submersion of the unused stones, keeping them clean and saturated, ready for immediate use and years of utility.

tip

- Rotating the handle brings the desired stone into position for sharpening.
- All offer a range of replacement stones to: replace worn or damaged stones, or substitute different specifications to customize the system.

IM100 3-in-1 Tool and Knife Sharpening Systems – Small straight-edged tool sharpening

FEATURES AND BENEFITS

The smallest system, designed for general sharpening, the IM100 is an affordable choice for small knives, cutlery, and woodworking tools. 4-1/2 oz. of lubricating oil and a reservoir unit complete both IM100 and IM101 systems.

IM100 - For general sharpening – coarse Crystolon quickly restores worn edges; medium Crystolon produces the average edge needed for most tools; and fine India stone hones for a sharper edge.

IM101 - For sharpest edges – fine India, extra fine Soft Arkansas and ultra fine Hard Translucent Arkansas stones are the choice for honing and fine finishing.



SIZE L X W X H	QTY. PKG.	QTY. CASE	KIT INCLUDES	PRODUCT NO.	UPC NO.
IM100 SYSTEMS					
6 x 2 x 1/2	1	5	1 Coarse Crystolon, 1 Medium Crystolon, 1 Fine India, 4-1/2 oz Oil, Reservoir Unit	IM100	61463685356 7
6 x 2 x 1/2	1	5	1 Fine India, 1 Extra Fine Soft Arkansas, 1 Ultra Fine Hard Arkansas, 4-1/2 oz Oil, Reservoir Unit	IM101	61463685357 4*
IM100 REPLACEMENT STONES					
6 x 2 x 1/2	1	5	Coarse Crystolon	JM31	61463685352 9
6 x 2 x 1/2	1	5	Medium Crystolon	JM61	61463685350 5
6 x 2 x 1/2	1	5	Fine India	IM91	61463685348 2

NOTE: SEE BENCHSTONE LISTINGS ON PAGE 6 – 8 FOR ALL 6 X 2 REPLACEMENT STONES.

* NON-STOCK; 3 WEEK LEAD-TIME

SHARPENING SYSTEMS

IM313 Multi-Oilstone Sharpening Systems - Large straight-edged tool sharpening

FEATURES AND BENEFITS

Considered by many to be the ultimate sharpening systems, IM313 Multi-Oilstone systems contain three oil stones. The 11-1/2" stone length permits long, sweeping strokes for faster and more precise sharpening and honing of all large, wider straight-edged tools. The heavy base has a non-skid bottom.

A pint of Norton oil, plastic angle guide, and reservoir unit are included with each IM313 system.

IM313 – For general sharpening – coarse Crystolon quickly restores worn edges; medium Crystolon produces the average edge needed for most tools; and fine India stone hones for a sharper edge.

IM313-CIH – For sharpening and finishing – coarse Crystolon for heavy stock removal; medium India for initial sharpening or resharpening and ultra fine Hard Translucent Arkansas for honing and final finishing.

IM313-CSH – For sharpest edges – medium Crystolon produces the average edge needed for most tools; extra fine Soft Arkansas for honing and ultra fine Hard Translucent Arkansas for final finishing.



SIZE L X W X H	QTY. PKG.	QTY. CASE	KIT INCLUDES	PRODUCT NO.	UPC NO.
IM313 SYSTEMS					
11-1/2 x 2-1/2 x 1/2	1	1	1 Coarse Crystolon, 1 Medium Crystolon, 1 Fine India, 1 Pint Oil, Angle Guide, Reservoir Unit	IM313	61463685960 6
11-1/2 x 2-1/2 x 1/2	1	1	1 Coarse Crystolon, 1 Medium India, 1 Ultra Fine Hard Arkansas, 1 Pint Oil, Angle Guide, Reservoir Unit	IM313-CIH	61463654212 6
11-1/2 x 2-1/2 x 1/2	1	1	1 Medium Crystolon, 1 Extra Fine Soft Arkansas, 1 Ultra Fine Hard Arkansas, 1 Pint Oil, Angle Guide, Reservoir Unit	IM313-CSH	61463653904 1†

IM-313 REPLACEMENT PARTS

11-1/2 x 2-1/2 x 1/2	1	2	Coarse Crystolon Stone	JM3	61463685980 4
11-1/2 x 2-1/2 x 1/2	1	2	Medium Crystolon Stone	JM6	61463685975 0
11-1/2 x 2-1/2 x 1/2	1	2	Medium India Stone	IM6	61463654214 0
11-1/2 x 2-1/2 x 1/2	1	2	Fine India Stone	IM9	61463685970 5
11-1/2 x 2-1/2 x 1/2	1	2	Extra Fine Soft Arkansas Stone	SM11	61463653897 6
11-1/2 x 2-1/2 x 1/2	1	2	Ultra Fine Hard Arkansas Stone	HM11	61463685965 1
11-1/2 x 2-1/2 x 3/8	1	5	Diamond 220 Grit Stone		61463690640 9
11-1/2 x 2-1/2 x 3/8	1	5	Diamond 325 Grit Stone		61463690641 6
11-1/2 x 2-1/2 x 3/8	1	5	Diamond 600 Grit Stone		61463690642 3
11-1/2 x 2-1/2 x 3/8	1	5	Diamond 1200 Grit Stone		61463690643 0
IM-313 Feet	1	5	IM-313 Feet		61463624194 4
IM-313 Cover	1	5	IM-313 Cover		61463685985 9
IM-313 Stone Holder	1	5	IM-313 Stone Holder		61463685990 3
IM-313 Base	1	5	IM-313 Base		61463686000 8

† NON-STOCK; 2 WEEK LEAD-TIME

IM200 Professional Sharpening Systems – Versatile, multi-size tool and knife sharpener

FEATURES AND BENEFITS

The smaller 8" stone IM200 systems provide the same quality sharpening features as the IM313 – making them the perfect choice for small restaurants and home DIYers.

They all contain 4-1/2 oz of lubricating oil, plastic angle guide, and the reservoir unit.

IM200 – For general sharpening – coarse Crystolon quickly restores worn edges; medium Crystolon produces the average edge needed for most tools; and fine India stone hones for a sharper edge.

IM200N – For sharpest edges – medium India for the initial sharpening or resharpening; extra fine Soft Arkansas for honing and ultra fine Hard Translucent Arkansas for final finishing .



SIZE L X W X H	QTY. PKG.	QTY. CASE	KIT INCLUDES	PRODUCT NO.	UPC NO.
IM200 SYSTEMS					
8 x 2 x 3/8	1	1	1 Coarse Crystolon, 1 Medium Crystolon, 1 Fine India, 4-1/2 oz Oil, Angle Guide, Reservoir Unit	IM200	61463691260 8
8 x 2 x 3/8	1	1	1 Medium India, 1 Extra Fine Soft Arkansas, 1 Ultra Fine Hard Arkansas, 4-1/2 oz Oil, Angle Guide, Reservoir Unit	IM200N	61463652510 5*

IM200 REPLACEMENT STONES

8 x 2 x 3/8	1	5	Medium Crystolon		66253054576 7
8 x 2 x 3/8	1	5	Coarse India		66253054571 2
8 x 2 x 3/8	1	5	Fine India		66253054572 9

NOTE: SEE BENCHSTONE LISTINGS ON PAGE 6 – 8 FOR ALL 8 X 2 AND 6 X 2 REPLACEMENT STONES.

* NON-STOCK; 3 WEEK LEAD-TIME

new!

Instructional DVD Offering

Ideal for sales training and end-user self-study. Learn to efficiently use these sharpening products to maintain tools at peak performance and prolong their life – to make all your sharpening, honing, etc applications easier.

Waterstone 07660787944 8

Oil Stone 07660787945 5

Cutlery 66253029073 5

tip

ABRASIVE FILES

Norton abrasive files hold their shape while imparting the finest, most uniform finish on precision machine parts and in tool and die making. Abrasive files are ideal for any deburring, chamfering or radiusing job, or for filing delicate parts. Select the file shape that matches the contour of the surface being stoned.

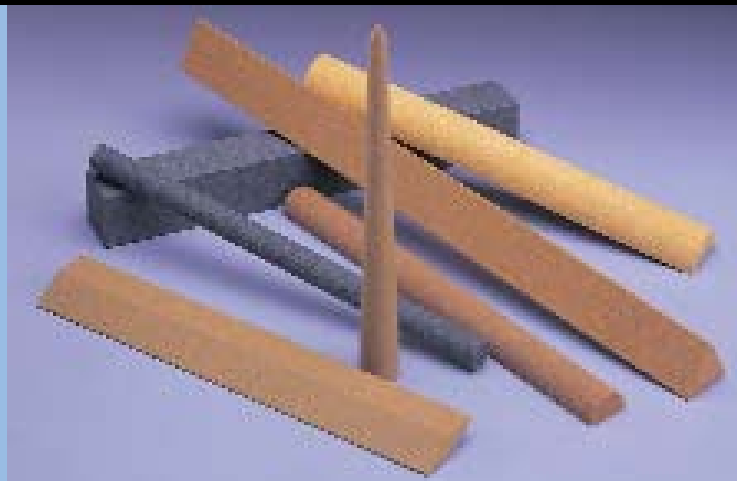

Abrasive Files

FEATURES AND APPLICATIONS

Crystolon Files – Fast-acting silicon carbide products, Crystolon files are designed for use where moderate tolerances are acceptable.

India Files – India files are ideal when a close tolerance is more important than the speed of cut.

Hard Translucent Arkansas Files – Hard Arkansas has an ultra fine grit that produces the finest edge possible while maintaining tolerances unequalled by any other abrasive file. It will also produce a highly polished finish.

Stone Roll Kits

General Purpose Stone Roll Kit

FEATURES AND APPLICATIONS

Thirty-five (35) stones in a variety of abrasives, grits, shapes and sizes. Housed in a durable vinyl roll that offers protection, easy portability, and full stone display. The stones are fastened by an elastic strap which permits easy removal and replacement of all items.



CONTENTS	QTY/ PKG	PKG/ CASE	UPC NO.
GENERAL PURPOSE STONE ROLL KIT			
35 Stones (See Below)	1	1	61463686841 7

TYPE	SIZE	SPECIFICATION	PROD. NO.
Auger Bit Stone	4 Long	India, Medium	MT10
Benchstone, Single Grit	4x1x1/4	Crystolon, Coarse	CJB14
Benchstone, Combination Grit	4x1-3/4x5/8	Crystolon, Combination	JB134
Benchstone, Combination Grit	4x1-3/4x3/8	India, Combination	IB134
Bevel File	3x3/8x1/8	Hard Translucent, UF	HF833
Diamond-shaped File	4x9/16x3/16	India, Medium	MT134
Diamond-shaped File	3x1/2x3/16	Hard Translucent, UF	HF843
Flat File	3x3/8x1/8	Hard Translucent, UF	HF823
Half Round File	4x3/8	India, Medium	MF334
Knife Blade	4x1x1/8 Back	India, Medium	MF724
Knife Blade	3x3/4x1/8 Back	Hard Translucent, UF	HF873
Oval File	3x1/2x3/16	Hard Translucent, UF	HF853
Penknife Benchstone	4x1x3/8	Soft Arkansas, Extra fine	SB14
Round Pointed File	3x5/16 Base	India, Medium	MF723
Round Pointed File	3x1/4 Base	Hard Translucent, UF	HF863
Reamer Stone	3-1/2x3/4x3/16	India, Medium	MT123
Round Edge Slip	4x1x7/16x3/16	India, Fine	FS14
Round Edge Slip	4x1-3/4x3/8x1/8	Hard Translucent, UF	HS4

CONTINUED

TYPE	SIZE	SPECIFICATION	PROD. NO.
Round File	4x3/8	Crystolon, Fine	FJF234
Round File	4x1/4	India, Fine	FF214
Round File	3x1/4	Hard Translucent, UF	HF813
Round Tapered File	4x1/2x1/4	India, Medium	MF644
Silversmith File	4x5/16x3/16x5/16x1/16	India, Medium	MF414
Silversmith File	4x3/8x3/16x1/8x1/16	India, Medium	MF424
Silversmith File	3-1/2x7/16x3/16	India, Medium	MF433
Silversmith File	4x7/16x3/16x1/8	India, Medium	MF434
Silversmith File	4x1/2x1/16	India, Medium	MF444
Silversmith File	4x1/2x3/16x3/16x1/16	India, Medium	MF454
Silversmith File	4x1/2x1/4x5/16x1/8	India, Medium	MF464
Silversmith File	4x1/2x1/4x5/16x1/8	India, Medium	MF474
Square File,	4x3/8	India, Coarse	CF34
Square File	3x1/4	Hard Translucent, UF	HF13
Tri. Tapered File	4x1/2x1/4	India, Medium	MF544
Triangular File	4x3/8	Crystolon, Medium	MJF134
Triangular File	3x1/4	Hard Translucent, UF	HF113



A TOOL IS ONLY AS GOOD AS ITS EDGE™

ABRASIVE FILES

Woodworking Stone Roll Kit

FEATURES AND APPLICATIONS

Housed in a durable vinyl roll are twenty-seven (27) stones custom designed to provide the experienced woodworker, wood turner and wood carver with a comprehensive assortment of shapes, sizes and grit combinations for sharpening woodworking tools.



CONTENTS	QTY/ PKG	PKG/ CASE	UPC NO.
WOODWORKING STONE ROLL KIT			
27 Stones (See Below)	1	1	61463654521 9

TYPE	SIZE	SPECIFICATION	PROD. NO.
Auger Bit Stone	4 Long	India, Medium	MT10
Carving Tool Slip	2-1/4x7/8x3/16	India, Medium	MS12
Carving Tool Slip	2-1/4x7/8x3/16	Hard Translucent, UF	AS12
Carving Tool Slip	2-1/4x7/8x3/16	India, Medium	MS22
Carving Tool Slip	2-1/4x7/8x3/16	Hard Translucent, UF	AS22
Carving Tool Slip	2-1/4x7/8x3/16	India, Medium	MS42
Carving Tool Slip	2-1/4x7/8x3/16	Hard Translucent, UF	AS42
Diamond-shaped File	4x9/16x3/16	India, Medium	MT134
Diamond-shaped File	3x1/2x3/16	Hard Translucent, UF	HF843
Gouge Stone	6x2x1x1/2x3/8	India, Fine	FS76
Knife Blade	4x1x1/8 Back	India, Medium	MF724
Knife Blade	3x3/4x1/8 Back	Hard Translucent, UF	HF873
Round Edge Slip	4-1/2x1-3/4x1/4x3/32	India, Medium	MS24
Round Edge Slip	4-1/2x1-3/4x1/4x3/32	India, Fine	FS24
Round Edge Slip	3 x 1-3/4x1/4x1/16	Hard Translucent, UF	HS3
Round Edge Slip	4-1/2x1-3/4x3/8x1/8	India, Medium	MS34
Round Edge Slip	4-1/2x1-3/4x3/8x1/8	India, Fine	FS34
Round Edge Slip	4x1-3/4x3/8x1/8	Hard Translucent, UF	HS4

CONTINUED

TYPE	SIZE	SPECIFICATION	PROD. NO.
Round File	3x1/4	Hard Translucent, UF	HF813
Round Tapered File	4x1/2x1/4	India, Medium	MF644
Square File	4x3/8	India, Medium	MF34
Square File	3x3/8	Hard Translucent, UF	HF33
Taper-shaped Stone	4x3/8x3/16x1/8x1/16	India, Medium	MF424
Taper-shaped Stone	4x1/2x1/4x5/16x1/8	India, Medium	MF464
Triangular Tapered File	4x1/2x1/4	India, Medium	MF544
Triangular File	4x3/8	India, Medium	MF134
Triangular File	3x1/4	Hard Translucent, UF	HF113

Abrasive Files

Square Abrasive Files

FEATURES AND APPLICATIONS

Square File applications range from dimensioning keyways to maintain fit, stoning faces on router bits, touching-up edges of reamer teeth, and lapping/honing to close tolerances to produce the finest edge on precision instruments, die work and delicate tools.



SIZE L X H	QTY. PKG.	QTY. CASE	SPECIFICATION	PRODUCT NO.	UPC NO.
SQUARE ABRASIVE FILES (BULK-PACKED)					
CRYSTOLON (SILICON CARBIDE)					
4 x 3/8	5	20	Fine	FJF34	61463686030 5
4 x 1/2	5	20	Medium	MJF44	61463686045 9
4 x 1/2	5	20	Fine	FJF44	61463686040 4
6 x 1	5	20	Medium	MJF76	61463625039 7
HARD TRANSLUCENT ARKANSAS					
3 x 1/4	5	10	Ultra Fine	HF13	61463686590 4
3 x 3/8	5	10	Ultra Fine	HF33	61463686595 9
3 x 1/2	5	10	Ultra Fine	HF43	61463686600 0

SIZE L X H	QTY. PKG.	QTY. CASE	SPECIFICATION	PRODUCT NO.	UPC NO.
SQUARE ABRASIVE FILES (BULK-PACKED)					
INDIA (ALUMINUM OXIDE)					
4 x 1/4	5	20	Coarse	CF14	61463686075 6
4 x 1/4	5	20	Medium	MF14	61463686070 1
4 x 1/4	5	20	Fine	FF14	61463686065 7
4 x 3/8	5	20	Coarse	CF34	61463686090 9
4 x 3/8	5	20	Medium	MF34	61463686085 9
4 x 3/8	5	20	Fine	FF34	61463686080 0
4 x 1/2	5	20	Coarse	CF44	61463686105 0
4 x 1/2	5	20	Medium	MF44	61463686100 5
4 x 1/2	5	20	Fine	FF44	61463686095 4
6 x 1/2	5	20	Coarse	CF46	61463686120 3
6 x 1/2	5	20	Medium	MF46	61463686115 9
6 x 1/2	5	20	Fine	FF46	61463686110 4
6 x 5/8	5	20	Medium	MF56	61463686130 2
6 x 5/8	5	20	Fine	FF56	61463686125 8
6 x 3/4	5	20	Coarse	CF66	61463686150 0
6 x 3/4	5	20	Medium	MF66	61463686145 6
6 x 3/4	5	20	Fine	FF66	61463686140 1
6 x 1	5	20	Coarse	CF76	61463686165 4
6 x 1	5	20	Medium	MF76	61463686160 9
6 x 1	5	20	Fine	FF76	61463686155 5

Abrasive Files

Triangular Abrasive Files

FEATURES AND APPLICATIONS

Triangular Files are used for a variety of deburring, chamfering and radiusing applications including cleaning tap threads, stoning cutting surfaces of milling cutters, lapping honing tools, dies and molds, and putting precision points on center punches.

The India line also offers Tapered Triangles...used by mechanics and tool and die makers to impart the correct edge in the least time.



Round Abrasive Files

FEATURES AND APPLICATIONS

Round Files are ideal for deburring, chamfering, radiusing, lapping, honing, for cleaning radius tools to a burr-free edge, and for dimensioning compound curves on templates.

Round Tapered Files are used by craftsmen, woodworkers, and die makers as the unique shape for imparting the correct edge quickly.

Round Pointed Abrasive Files are ideally suited for engravers and die sinkers for stoning difficult recesses on instruments and die tools.

Half Round Files offer both a round and a flat surface for imparting a fine finish on precision machine parts, tools and dies.

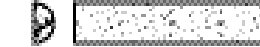
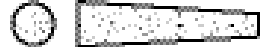

SIZE L X W X H	QTY. PKG.	QTY. CASE	SPECIFICATION	PRODUCT NO.	UPC NO.
-------------------	--------------	--------------	---------------	----------------	---------

TRIANGULAR ABRASIVE FILES (BULK-PACKED)

CRYSTOLON (SILICON CARBIDE)

4 x 1/4	5	20	Fine	FJF114	61463686185 2
4 x 1/2	5	20	Fine	FJF144	61463686205 7

INDIA (ALUMINUM OXIDE)

4 x 1/4	5	20	Coarse	CF114	61463686240 8
4 x 1/4	5	20	Medium	MF114	61463686235 4
4 x 1/4	5	20	Fine	FF114	61463686230 9
4 x 3/8	5	20	Coarse	CF134	61463686255 2
4 x 3/8	5	20	Medium	MF134	61463686250 7
4 x 3/8	5	20	Fine	FF134	61463686245 3
4 x 1/2	5	20	Coarse	CF144	61463686270 5
4 x 1/2	5	20	Medium	MF144	61463686265 1
4 x 1/2	5	20	Fine	FF144	61463686260 6
6 x 1/2	5	20	Coarse	CF146	61463686285 9
6 x 1/2	5	20	Medium	MF146	61463686280 4
6 x 1/2	5	20	Fine	FF146	61463686275 0
6 x 5/8	5	20	Medium	MF156	61463686295 8
6 x 5/8	5	20	Fine	FF156	61463686290 3
6 x 3/4	5	20	Medium	MF166	61463686310 8
6 x 3/4	5	20	Fine	FF166	61463686305 4
6 x 1	5	20	Medium	MF176	61463686325 2
6 x 1	5	20	Fine	FF176	61463686320 7

HARD TRANSLUCENT ARKANSAS

3 x 1/4	5	10	Ultra Fine	HF113	61463686620 8
3 x 3/8	5	10	Ultra Fine	HF133	61463686625 3
3 x 1/2	5	10	Ultra Fine	HF143	61463686630 7

TRIANGULAR TAPERED ABRASIVE FILES (BULK-PACKED)

INDIA (ALUMINUM OXIDE)

4 x 1/2 x 1/4	5	20	Medium	MF544	61463686685 7
4 x 1/2 x 1/4	5	20	Fine	FF544	61463686680 2

HALF ROUND ABRASIVE FILES (BULK-PACKED)

INDIA (ALUMINUM OXIDE)

4 x 1/4	5	20	Medium	MF314	61463686355 9
4 x 1/4	5	20	Fine	FF314	61463686350 4
4 x 3/8	5	20	Medium	MF334	61463686385 6
4 x 3/8	5	20	Fine	FF334	61463686380 1
4 x 1/2	5	20	Coarse	CF344	61463686405 1
4 x 1/2	5	20	Medium	MF344	61463686400 6
4 x 1/2	5	20	Fine	FF344	61463686395 5

SIZE L X W X H	QTY. PKG.	QTY. CASE	SPECIFICATION	PRODUCT NO.	UPC NO.
-------------------	--------------	--------------	---------------	----------------	---------

ROUND ABRASIVE FILES (BULK-PACKED)

CRYSTOLON (SILICON CARBIDE)

4 x 1/4	5	20	Medium	MJF214	61463686430 3
4 x 1/4	5	20	Fine	FJF214	61463686425 9
4 x 3/8	5	20	Medium	MJF234	61463686440 2

INDIA (ALUMINUM OXIDE)

4 x 1/4	5	20	Coarse	CF214	61463686480 8
4 x 1/4	5	20	Medium	MF214	61463686475 4
4 x 1/4	5	20	Fine	FF214	61463686470 9
4 x 3/8	5	20	Coarse	CF234	61463686495 2
4 x 3/8	5	20	Medium	MF234	61463686490 7
4 x 3/8	5	20	Fine	FF234	61463686485 3
4 x 1/2	5	20	Coarse	CF244	61463686510 2
4 x 1/2	5	20	Medium	MF244	61463686505 8
4 x 1/2	5	20	Fine	FF244	61463686500 3
6 x 1/2	5	20	Coarse	CF246	61463686525 6
6 x 1/2	5	20	Medium	MF246	61463686520 1
6 x 1/2	5	20	Fine	FF246	61463686515 7
6 x 5/8	5	20	Medium	MF256	61463686535 5
6 x 3/4	5	20	Medium	MF266	61463686550 8
6 x 1	5	20	Medium	MF276	61463686565 2

HARD TRANSLUCENT ARKANSAS

3 x 1/4	5	10	Ultra Fine	HF813	61463686800 4
---------	---	----	------------	-------	---------------

ROUND POINTED ABRASIVE FILES (BULK-PACKED)

INDIA (ALUMINUM OXIDE)

3 x 5/16 Base	5	20	Coarse	CF723	61463686750 2
3 x 5/16 Base	5	20	Medium	MF723	61463686745 8
3 x 5/16 Base	5	20	Fine	FF723	61463686740 3

HARD TRANSLUCENT ARKANSAS

3 x 1/4 Base	5	10	Ultra Fine	HF863	61463686825 7
--------------	---	----	------------	-------	---------------

ROUND TAPERED ABRASIVE FILES (BULK-PACKED)

INDIA (ALUMINUM OXIDE)

4 x 1/2 x 1/4	5	20	Coarse	CF644	61463686660 4
4 x 1/2 x 1/4	5	20	Medium	MF644	61463686655 0
4 x 1/2 x 1/4	5	20	Fine	FF644	61463686650 5

Diamond-shaped Abrasive Files

FEATURES AND APPLICATIONS

Diamond-shaped Files are precision sharpening favorites for cleaning acute angles in dies and molds, and for stoning geometric chasers and sewing machine feeds.

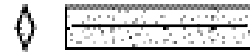

Beveled Abrasive File

FEATURES AND APPLICATIONS

Beveled Files are preferred by exacting artisans, jewelers, mechanics, and watchmakers for honing the finest of finishes. These extremely hard files provide years of service.

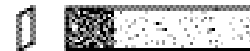

Flat Abrasive File

FEATURES AND APPLICATIONS

The Flat File is the choice of mechanics, artisans and jewelers. This long lasting file produces the finest finishes.



Oval Abrasive File

FEATURES AND APPLICATIONS

The Oval File's shape makes it ideal for finishing and honing recesses or curved edges of precision instruments.



Knife Blade Files

FEATURES AND APPLICATIONS

Knife Blade Files are used by clock and watch makers to quickly sharpen, hone and maintain the edges and points of cutting tools.



Abrasive File Sets

FEATURES AND APPLICATIONS

Hard Translucent Arkansas File Kit

This kit provides a selection of our most popular square, triangular, round and knife blade files in ultra fine Hard Translucent Arkansas for honing and polishing a wide range of configurations.

Hard Translucent Arkansas-India File Kit

This kit contains an assortment of files for finishing, honing and polishing applications. It contains a selection of the most popular file shapes/sizes in both fine grit India and ultra fine grit Hard Translucent Arkansas.



SIZE L X W X H	QTY. PKG.	QTY. CASE	SPECIFICATION	PRODUCT NO.	UPC NO.
DIAMOND-SHAPED ABRASIVE FILES (BULK-PACKED)					
INDIA (ALUMINUM OXIDE)					
4 x 9/16 x 3/16	5	20	Coarse	CT134	61463686720 5
4 x 9/16 x 3/16	5	20	Medium	MT134	61463686715 1
4 x 9/16 x 3/16	5	20	Fine	FT134	61463686710 6
HARD TRANSLUCENT ARKANSAS					
3 x 1/2 x 3/16	5	10	Ultra Fine	HF843	61463686815 8
BEVELED ABRASIVE FILE (BULK-PACKED)					
HARD TRANSLUCENT ARKANSAS					
3 x 3/8 x 1/8	5	10	Ultra Fine	HF833	61463686810 3
FLAT ABRASIVE FILE (BULK-PACKED)					
HARD TRANSLUCENT ARKANSAS					
3 x 3/8 x 1/8	5	10	Ultra Fine	HF823	61463686805 9
OVAL ABRASIVE FILE (BULK-PACKED)					
HARD TRANSLUCENT ARKANSAS					
3 x 1/2 x 3/16	5	10	Ultra Fine	HF853	61463686820 2

SIZE L X W X H	QTY. PKG.	QTY. CASE	SPECIFICATION	PRODUCT NO.	UPC NO.
KNIFE BLADE FILES (BULK-PACKED)					
INDIA (ALUMINUM OXIDE)					
4 x 1 x 1/8 Back	5	20	Coarse	CF724	61463686780 9
4 x 1 x 1/8 Back	5	20	Medium	MF724	61463686775 5
4 x 1 x 1/8 Back	5	20	Fine	FF724	61463686770 0
HARD TRANSLUCENT ARKANSAS					
3 x 3/4 x 1/8	5	10	Ultra Fine	HF873	61463686830 1
ABRASIVE FILE SETS					
HARD TRANSLUCENT ARKANSAS FILE SET					
	1	5			61463686839 4
1 Each of Ultra Fine Hard Arkansas HF13, HF113, HF813, and HF873					
HARD TRANSLUCENT ARKANSAS AND INDIA FILE SET					
	1	5			61463686840 0
1 Each of Ultra Fine Hard Arkansas HF13, HF43, HF113, HF813, HF873, and Fine India FF14, FF44, FF114, FF214, FF724					

Abrasive Files

Engravers' Chuck & Points

FEATURES AND APPLICATIONS

Engravers' Points are the choice of professional die-makers for cleaning tight corners and recesses where close tolerances and accuracy are a must. The Engravers' Chuck is a knurled nickel-plated tool designed to hold the Engravers' Point.

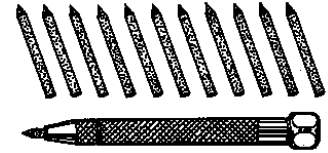

Silversmith Precision Files

FEATURES AND APPLICATIONS

These aluminum oxide precision-shaped stones are designed for use by silversmiths and mechanics for close tolerance lapping, touching-up instruments, and for cleaning tools and dies.

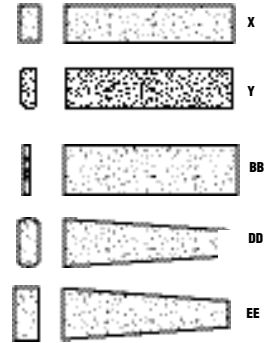

DIMENSIONS AND SHAPE	QTY. PKG.	QTY. CASE	SPECIFICATION	PRODUCT NO.	UPC NO.
ENGRAVERS' CHUCK AND POINTS (BULK-PACKED)					
Engravers' Chuck	5	10		XT1	61463687485 2
INDIA (ALUMINUM OXIDE)					
1 x 1/8 Point	5	20	Fine	FT11	61463687495 1
SOFT ARKANSAS					
1 x 1/8 Point	5	20	Extra Fine	AT11	61463687490 6
SILVERSMITH PRECISION FILES (BULK-PACKED)					
INDIA (ALUMINUM OXIDE)					
4 x 5/16 x 3/16 x 5/16 x 1/16 - X	5	20	Medium	MF414	61463686855 4
4 x 5/16 x 3/16 x 5/16 x 1/16 - X	5	20	Fine	FF414	61463686850 9
4 x 3/8 x 3/16 x 1/8 x 1/16 - Y	5	20	Medium	MF424	61463686915 5
4 x 3/8 x 3/16 x 1/8 x 1/16 - Y	5	20	Fine	FF424	61463686910 0
4 x 7/16 x 3/16 x 1/8	5	20	Fine	FF434	61463686940 7
4 x 1/2 x 1/16 - BB	5	20	Coarse	CF444	61463686965 0
4 x 1/2 x 1/16 - BB	5	20	Medium	MF444	61463686960 5
4 x 1/2 x 1/16 - BB	5	20	Fine	FF444	61463686955 1
4 x 1/2 x 1/4 x 5/16 x 1/8 - DD	5	20	Fine	FF464	61463686985 8
4 x 1/2 x 1/4 x 5/16 x 1/8 - EE	5	20	Medium	MF474	61463687005 2
4 x 1/2 x 1/4 x 5/16 x 1/8 - EE	5	20	Fine	FF474	61463687000 7

ABRASIVE SLIPS

Norton abrasive slips impart the finest, most uniform finish on curved knives and tools, molders' knives, wood gouges, bead planers, carving tools and carbide-tipped tools. These fast-acting slips hold their shape and are long lasting.

The Crystolon and India stones are designed for preliminary sharpening and the Norton Hard Translucent Arkansas is the product of choice for achieving the finest finish possible.



Carbide Tool Slips

FEATURES AND APPLICATIONS

Crystolon (silicon carbide) Slips are used to maintain the edge of carbide tools – keeping regrinding costs and time to an absolute minimum. Not oil-filled.

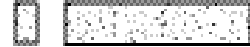

Round Edge Slips

FEATURES AND APPLICATIONS

Round Edge Slips are ideal for precision sharpening and honing of bead planers, curved knives and tools, molders' knives and wood gouges.



SIZE L X W X H	QTY. PKG.	QTY. CASE	SPECIFICATION	PRODUCT NO.	UPC NO.
CARBIDE TOOL SLIPS					
CRYSTOLON (SILICON CARBIDE)					
new! 3-1/2 x 3/4 x 1/2	5	20	Coarse	CJT63	61463687295 7
new! 3-1/2 x 3/4 x 1/2	5	20	Medium	MJT63	61463687290 2
3-1/2 x 3/4 x 1/2	5	20	Fine	FJT63	61463687285 8
Set of Three Above new!	5	10	Coarse, Medium & Fine	J63	61463687300 8
ROUND EDGE SLIPS					
CRYSTOLON (SILICON CARBIDE)					
4-1/2 x 1-3/4 x 1/4 x 3/32	5	10	Medium	MJS24	61463687080 9
4-1/2 x 1-3/4 x 1/4 x 3/32	5	10	Fine	FJS24	61463687075 5
4-1/2 x 1-3/4 x 1/2 x 3/16	5	10	Coarse	CJS44	61463687100 4
4-1/2 x 1-3/4 x 1/2 x 3/16	5	10	Medium	MJS44	61463687095 3
4-1/2 x 1-3/4 x 1/2 x 3/16	5	10	Fine	FJS44	61463687090 8
6 x 2-1/4 x 3/4 x 3/8	5	10	Medium	MJS66	61463687110 3
6 x 2-1/4 x 3/4 x 3/8	5	10	Fine	FJS66	61463687105 9
INDIA (ALUMINUM OXIDE)					
4 x 1 x 7/16 x 3/16	5	10	Medium	MS14	61463687140 0
4 x 1 x 7/16 x 3/16	5	10	Fine	FS14	61463687135 6
4 x 1-3/4 x 3/8 x 1/8 x 5/16 x 3/32	5	10	Fine	FS15	61463687190 5
4-1/2 x 1-3/4 x 1/4 x 3/32	5	10	Coarse	CS24	61463687155 4
4-1/2 x 1-3/4 x 1/4 x 3/32	5	10	Medium	MS24	61463687150 9
4-1/2 x 1-3/4 x 1/4 x 3/32	5	10	Fine	FS24	61463687145 5
4-1/2 x 1-3/4 x 3/8 x 1/8	5	10	Coarse	CS34	61463687170 7
4-1/2 x 1-3/4 x 3/8 x 1/8	5	10	Medium	MS34	61463687165 3
4-1/2 x 1-3/4 x 3/8 x 1/8	5	10	Fine	FS34	61463687160 8
4-1/2 x 1-3/4 x 1/2 x 3/16	5	10	Coarse	CS44	61463687185 1
4-1/2 x 1-3/4 x 1/2 x 3/16	5	10	Medium	MS44	61463687180 6
4-1/2 x 1-3/4 x 1/2 x 3/16	5	10	Fine	FS44	61463687175 2
5 x 1 x 5/16 x 3/32	5	10	Medium	MS15	61463687195 0
5 x 1 x 5/16 x 3/32	5	10	Fine	FS15	61463687190 5
HARD TRANSLUCENT ARKANSAS					
3 x 1-3/4 x 1/4 x 1/16	5	10	Ultra Fine	HS3	61463687040 3
4 x 1-1/4 x 1/4 x 1/8	5	10	Ultra Fine	HS14	61463687050 2
4 x 1-3/4 x 3/8 x 1/8	5	10	Ultra Fine	HS4	61463687045 8
SOFT ARKANSAS					
4 x 1-3/4 x 3/8 x 1/8 x 5/16 x 3/32	5	10	Extra Fine	SS4	61463687055 7

Abrasive Slips for Woodworking

Multiform Super Slip

new!

FEATURES AND APPLICATIONS

Multiform Super Slips are designed to fit gouges and V-parting tools. The two different edge shapes make them universal sharpeners. One edge is tapered from 1/2" to 1/8" diameter to handle various curves on tools. The other has a straight, angled taper which forms a knife edge for honing small and large V-parting tools. Use Norton India for initial sharpening and Norton Hard Translucent Arkansas for finishing and polishing.



Carving Tool Slips

FEATURES AND APPLICATIONS

Carving Tool Slips are ideal for sharpening, final finishing and maintaining the edge required on the special gouges, knives and deep-grooved tools used in carving wood.

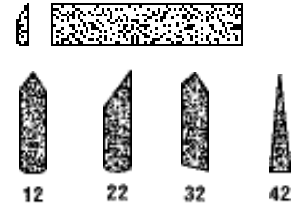

SIZE L x W x H	QTY. PKG.	QTY. CASE	SPECIFICATION	PRODUCT NO.	UPC NO.
MULTIFORM SUPER SLIPS					
INDIA (ALUMINUM OXIDE)					
new! 4-1/2 x 1-3/4 x 1/2 x 3/8	5	10	Medium	MSSP-44	69936613416 2
new! 4-1/2 x 1-3/4 x 1/2 x 3/8	5	10	Fine	FSSP-44	69936613411 7
HARD TRANSLUCENT ARKANSAS					
new! 4-1/2 x 1-7/8 x 1/2 x 3/8	5	10	Ultra Fine	HTSSP-44	69936613425 4
CARVING TOOL SLIPS					
INDIA (ALUMINUM OXIDE)					
new! 2-1/4 x 7/8 x 3/16	5	20	Medium	MS12	61463687215 5
2-1/4 x 7/8 x 3/16	5	20	Medium	MS22	61463687220 9
new! 2-1/4 x 7/8 x 3/16	5	20	Medium	MS32	61463687225 4
new! 2-1/4 x 7/8 x 3/16	5	20	Medium	MS42	61463687230 8
HARD TRANSLUCENT ARKANSAS					
new! 2-1/4 x 7/8 x 3/16	5	20	Ultra Fine	AS12	61463687250 6
new! 2-1/4 x 7/8 x 3/16	5	20	Ultra Fine	AS22	61463687255 1
new! 2-1/4 x 7/8 x 3/16	5	20	Ultra Fine	AS32	61463687260 5

Chris Pye's Signature Series Woodcarvers' Sharpening Stone Kits – For Woodcarving Gouges

FEATURES AND APPLICATIONS

Chris Pye, professional Master Woodcarver, along with Norton abrasive engineers, have developed the first slip stones exclusively for sharpening woodcarvers', woodworkers' and hobbyists' gouges.

The dimensions and specifications of the stones in each kit correspond perfectly to a specific size of wood carving gouges and V-Tools. The 4-sided slip stones have a different profile for each side, ranging from very flat to semicircular with incremental curves in between. One edge of these unique stones fits the sweep of the gouge to efficiently create an inside bevel or remove any burrs.

All kits are housed in durable plastic storage cases. 3 kits have 1 India (aluminum oxide) and 1 ultra fine Hard Translucent Arkansas slip stone to sharpen and polish. The Benchstone Kits produce the smoothest cutting edges.

new!



SIZE L x W x H	QTY. PKG.	QTY. CASE	KIT INCLUDES	PRODUCT NO.	UPC NO.
CHRIS PYE'S SIGNATURE SERIES WOODCARVERS' SHARPENING STONE KITS					
SCULPTURE SLIP STONE KIT					
new! 3" x 3" x 18mm (.709")	1	2	1 each: Coarse India, Ultra Fine Hard Arkansas		66253064728 7
STANDARD #1 SLIP STONE KIT					
new! 3" x 3" x 12mm (.472")	1	2	1 each: Coarse India, Ultra Fine Hard Arkansas		66253064732 4
STANDARD #2 SLIP STONE KIT					
new! 3" x 3" x 6mm (.236")	1	2	1 each: Medium India, Ultra Fine Hard Arkansas		66253064730 0
DETAIL SLIP STONE KIT					
new! Various	1	4	one 3" x 3" x 3mm (.118") Medium India, three 2" x 1" x 3mm (.118") Ultra Fine Hard Arkansas		66253064726 3
V-STONE KIT					
new! 2- 1/2" x 2-1/2" x 10mm (.254")	1	4	1 Ultra Fine Hard Arkansas V-Stone		66253064727 0
INDIA BENCHSTONE KIT					
new! 8 x 2 x 1	1	1	1 Coarse/Fine India Combination Stone, Plastic Storage Case and 4-1/2 oz. Oil	IM50	61463655188 3
HARD TRANSLUCENT ARKANSAS BENCHSTONE KIT					
new! 8 x 2 x 1	1	1	1 UF Hard Arkansas Stone, Plastic Storage Case and 4-1/2 oz. Oil	IM50-H	61463654862 3*

* NON-STOCK; 3 WEEK LEAD-TIME



Chris Pye

SPECIALTY STONES

Norton continues to offer specialty stones with optimum specifications and unique shapes that conform to, and quickly sharpen, specific tools.

The offering includes stones for sharpening and honing woodworking and craftsmen's tools, machine tools, large specialty stones for gardening tools, and pocket stones for sportsmen and outdoor enthusiasts.



Specialty Stones for Woodworking

Specialty Stones for Woodworking

FEATURES AND APPLICATIONS

Gouge Sharpening Stone

India (aluminum oxide) Gouge Sharpening Stones have a unique shape for sharpening and lapping inside and outside curved surfaces on gouges and other cutting tools. An indispensable tool for woodworkers, mechanics, artisans and craftsmen.

Jointer Stones

Jointer Stones provide a fast method of restoring and maintaining the cutting edges of mechanical jointing devices on automatic planers.

Auger Bit Stone

Designed specially for sharpening drill bits used in wood and metal drilling. They are frequently preferred over metal files because of their unique shape.

Grooved Carver's Stone

Designed for honing rounded tips.

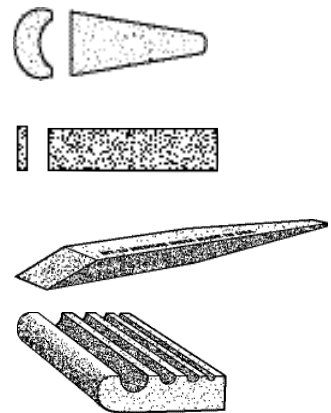

SIZE L X W X H	QTY. PKG.	QTY. CASE	SPECIFICATION	PRODUCT NO.	UPC NO.
GOUGE SHARPENING STONE					
INDIA (ALUMINUM OXIDE)					
6 x 2 x 1 x 1/2 x 3/8	5	10	Fine	FS76	61463687305 3
JOINTER STONES					
CRYSTOLON (SILICON CARBIDE)					
4 x 3/4 x 3/8	5	10	Medium	JE74	61463687335 0
4 x 3/4 x 1/2	5	10	Medium	JE84	61463687340 4
INDIA (ALUMINUM OXIDE)					
4 x 3/4 x 5/16	5	10	Coarse	IE64	61463687370 1
4 x 3/4 x 3/8	5	10	Coarse	IE74	61463687375 6
4 x 3/4 x 1/2	5	10	Coarse	IE84	61463687380 0
AUGER BIT STONE					
INDIA (ALUMINUM OXIDE)					
4" Long	5	10	Medium	MT10	61463687470 8
GROOVED CARVER'S STONE					
HARD TRANSLUCENT ARKANSAS					
4 x 1-1/2 x 1/2	1	5	Ultra Fine	HG4	61463685915 6



A TOOL IS ONLY AS GOOD AS ITS EDGE™

Specialty Stones for Machine Tools

Specialty Stones for Machine Tools

FEATURES AND APPLICATIONS

Machine Knife Stone

Crystolon (silicon carbide) Machine Knife Stones offer both coarse and fine sides for sharpening and honing paper and cloth-cutting knives and planer knives on the machine. The groove around the middle of the stone protects fingers and provides a secure hold.

Reamer Stones

India (aluminum oxide) Reamer Stones are durable, fast-cutting stones designed for imparting a professional edge on reamers, taps and rough rounders on shoe machine tools.

Boat Stones

Boat Stones are medium grit, medium grade stones that are easy to hold and use. Excellent for deburring and breaking sharp edges on dies, fixtures and machined parts, and for deburring grinder magnetic chucks.

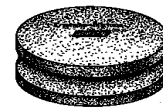

SIZE L x W x H	QTY. PKG.	QTY. CASE	SPECIFICATION	PRODUCT NO.	UPC NO.
MACHINE KNIFE STONE					
CRYSTOLON (SILICON CARBIDE)					
4" Diam. x 1-1/2 Thick	1	5	Coarse/Fine	JB74	61463687570 5
REAMER STONES					
INDIA (ALUMINUM OXIDE)					
4-1/2 x 1 x 5/16	5	10	Medium	MT124	61463687420 3
4-1/2 x 1 x 5/16	5	10	Fine	FT124	61463687415 9
5 x 1 x 3/16	5	10	Medium	MT125	61463687430 2
5 x 1 x 3/16	5	10	Fine	FT125	61463687425 8
6 x 1 x 1/4	5	10	Medium	MT126	61463687440 1
6 x 1 x 1/4	5	10	Fine	FT126	61463687435 7
BOAT STONES (BULK PACKED)					
CRYSTOLON (SILICON CARBIDE)					
9 x 2-1/2 x 1-1/2	10	50	37C80-HV		61463610369 3
INDIA (ALUMINUM OXIDE)					
9 x 2-1/2 x 1-1/2	10	50	38A60-IVBE		61463610503 1

Large Specialty Stones

Large Specialty Stones

FEATURES AND APPLICATIONS

Lawn and Garden Tool Stone

Used by gardeners and homeowners, the elliptical shape makes the stone conformable to all flat and curved cutting edges.

Sickle & Scythe Stones

Produce a fast-cutting edge on sickles, scythes and brush hooks. These stones are the most frequently chosen where the speed of sharpening is the primary consideration.

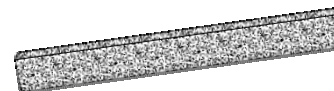

SIZE L x W x H	QTY. PKG.	QTY. CASE	SPECIFICATION	PRODUCT NO.	UPC NO.
LAWN AND GARDEN TOOL STONE (RETAIL-PACKED)					
CRYSTOLON (SILICON CARBIDE)					
9-1/2 x 1-3/8 x 1/2	1	10	Medium	JT911	07660787938 7
SICKLE AND SCYTHE STONES (BULK-PACKED)					
CRYSTOLON (SILICON CARBIDE)					
10 x 1-1/4 x 3/4	5	10	Coarse	TJ3	61463687731 0
INDIA (ALUMINUM OXIDE)					
10 x 1-5/16 x 3/4	5	10	Coarse	TD1	61463687715 0

Large Specialty Stones continued

Large Specialty Stones

FEATURES AND APPLICATIONS

Tradesmen's Utility Stones

Used for sharpening trimming knives and as an abrasive file in many different industries. The JT910 does not have a handle, while the JT920 & JT930 have wooden handles.

Utility File

A long wedge shape stone with four flat sides designed for sharpening coarse cutting edges on cutting implements and edged garden tools. Wooden handles make them easy to use. They will outlast and out-sharpen metal files.



SIZE L X W X H	QTY. PKG.	QTY. CASE	SPECIFICATION	PRODUCT NO.	UPC NO.
TRADESMEN'S UTILITY STONES					
CRYSTOLON (SILICON CARBIDE)					
10 x 1-1/4 x 3/4 (Bulk-Packed)	5	10	Medium	JT910	61463687665 8
14-3/4 Overall (w/ Handle)	5	10	Coarse/Fine	JT930	61463687675 8
14-3/4 Overall (w/ Handle)	5	10	Medium	JT920	61463687670 2
UTILITY FILE (BULK-PACKED)					
CRYSTOLON (SILICON CARBIDE)					
14 Overall (w/ Handle)	5	10	Coarse	JD2	61463687750 1

Pocket Stones

Pocket Stones

FEATURES AND APPLICATIONS

Pocket Stones

Convenient and easily transported. Ideal for outdoor enthusiasts to sharpen scissors, knives, axes, etc. Available in a protective case.



SIZE L X W X H	QTY. PKG.	QTY. CASE	SPECIFICATION	PRODUCT NO.	UPC NO.
POCKET STONES					
INDIA SPORTSMAN POCKET STONE					
3 x 1-1/2 x 1/2	1	50	Coarse/Fine	IBP34	61463690705 5
INDIA POCKET STONE					
4 x 3/4 x 1/4	1	25	Fine	IBP4	61463624153 1
CRYSTOLON POCKET STONE W/ CASE					
3 x 7/8 x 3/8 w/ Case		50	Fine	JP14	61463690703 1
CRYSTOLON HALF-ROUND FISH HOOK STONE W/ POUCH					
3" x 1/2" w/ Pouch		50	Fine		61463624072 5

RUBBING BRICKS

Hard crystolon rubbing bricks are used for heavy-duty applications such as rubbing floors, cleaning and scouring castings, rubbing down concrete and removing mold marks.



Floor Rubbing Bricks

FEATURES AND APPLICATIONS

Crystolon floor rubbing bricks are designed to fit the chucks of common concrete floor grinding equipment - to rub down the concrete and remove mold marks. The 8" brick has a center score that facilitates dividing the brick in half ...an economical alternative to buying two 4" bricks. Reusable wooden wedges anchor the bricks to the equipment chucks.

Hand Rubbing Bricks

FEATURES AND APPLICATIONS

Hand Rubbing Bricks, manufactured with extra coarse silicon carbide abrasive, are available in three types...plain, fluted and fluted with handle.

Plain Bricks are the choice of mechanics and foundrymen for dressing grinding wheels and cleaning or scouring castings.

Fluted Bricks are used by masons and stone workers for rubbing down concrete and removing mold marks. The diagonal flutes provide sharp edges, a clean shearing action, and carry away debris.

Fluted Bricks with Handle make quick work of removing mold marks and rubbing down concrete. The firmly attached handle reduces fatigue and facilitates overhead, wall and floor work.

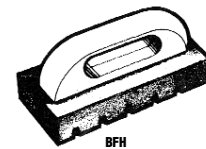
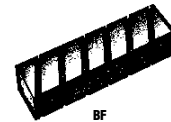
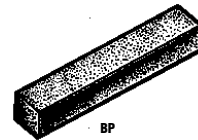

SIZE L X W X H	QTY. PKG.	QTY. CASE	SPECIFICATION	PRODUCT NO.	UPC NO.
RUBBING BRICKS (BULK-PACKED) – CRYSTOLON					
PLAIN FLOOR RUBBING BRICKS W/ WOODEN WEDGES					
4 x 2 x 2	1	6	C6-R		61463653292 9
4 x 2 x 2	1	6	C10-R		61463653293 6
4 x 2 x 2	1	6	C24-R		61463653294 3
4 x 2 x 2	1	6	C80-R		61463653295 0
FLOOR RUBBING BRICK W/ CENTER SCORE					
8 x 2 x 2	1	5	C120-R		61463685296 6
PLAIN HAND RUBBING BRICKS					
8 x 2 x 2	1	5	C24	BP28	61463687830 0
FLUTED HAND RUBBING BRICKS					
6 x 2 x 2	1	5	C20	BF26	61463687840 9
8 x 2 x 2	1	5	C20	BF28	61463687845 4
FLUTED HAND RUBBING BRICKS W/ HANDLE					
6 x 3 x 1	1	5	C20	BFH6	61463687800 3
8 x 3-1/2 x 1-1/2	1	5	C20	235	61463687795 2
WOODEN WEDGES					
	6	6			61463685297 3

RETAIL-PACKAGED PRODUCTS – DO-IT-YOURSELF (D-I-Y)

Our retail-packaged line brings Norton quality to the DIY market. Each stone is specifically designed for a popular sharpening application and packaged to sell.

Diamond stones provide the optimum in performance and life.

The Knife & Scissor Sharpener is the entry level design that provides a quick and portable tool for hundreds of sharpening applications.

Abrasive Sharpening Stones are designed for lower costs, lower usage sharpening applications.

The compact, handheld Rolling Wheel Knife Sharpener has two slots, to sharpen each side of the blade. It has a built-in proper angle for sharpening. No lubricant needed.



SIZE L X W X H	QTY. PKG.	QTY. CASE	SPECIFICATION	PRODUCT NO.	UPC NO.
DIAMOND STONES					
POCKET STONE					
4 x 1 x 3/16	1	6	Coarse		07660787500 6
COMBINATION POCKET STONE W/ /HANDLE					
9-1/4 x 1-3/8 x 1/2	1	4	Coarse/Fine		07660787505 1
BENCHSTONE					
6 x 2-1/2 x 1/4	1	2	Fine		07660787510 5
6 x 2-1/2 x 1/4	1	2	Coarse		07660787515 0
KNIFE AND SCISSORS MECHANICAL SHARPENER					
6 x 2 x 5/8	1	6	Carbide		07660787520 4
ABRASIVE SHARPENING STONES					
AXE & HATCHET SHARPENER					
3 x 5/8 round	1	10	Coarse/Fine Crystolon	JT3	07660785316 5
POCKET KNIFE SHARPENER					
3 x 7/8 x 3/8	1	5	Fine Crystolon	JP13	07660787600 3
3 x 7/8 x 3/8 w/ Case	1	5	Medium Aluminum Oxide	EZP13	07660787937 0
3 x 1-1/2 x 1/2 w/ Case	1	5	Coarse/Fine Aluminum Oxide		07660787630 0
ECONOMY TOOL & KNIFE SHARPENER					
6 x 2 x 3/4	1	5	Coarse/Fine Aluminum Oxide		07660787933 2
8 x 2 x 3/4	1	10	Coarse/Fine Aluminum Oxide		07660787934 9
8 x 2 x 1	1	10	Coarse/Fine Aluminum Oxide		61463685755 8
HIGH QUALITY TOOL & KNIFE SHARPENER					
6 x 2 x 3/4	1	5	Coarse/Fine Crystolon		07660787935 6
CHISEL & PLANER BLADE SHARPENER					
8 x 2 x 3/4	1	10	Coarse/Fine India		07660787936 3
HOUSEHOLD KNIFE & TOOL SHARPENER					
7-1/2	1	5	Fine Crystolon		07660787939 4
FARM TOOL SHARPENER					
10 x 1-1/4 x 3/4	1	10	Coarse Crystolon		07660787730 7
LAWN & GARDEN TOOL SHARPENER					
9-1/2 x 1-3/8 x 1/2	1	10	Medium Crystolon		07660787938 7
GRIDDLE BRICK					
4-1/2 x 3 x 2	1	5	Medium Aluminum Oxide		61463687870 6
SHARPENING STONE OIL					
4-1/2 oz.	1	5			07660787940 0
ROLLING-WHEEL KNIFE SHARPENER					
	12	12	Slotted, Handheld		66253092616 0



tip Most manufacturer's ship their cutting tools without keen edges to avoid damage in transit. The blade tool/blade will need a good sharpening to realize its full potential.



A Tool Is Only As Good As Its Edge™

RETAIL-PACKAGED PRODUCTS – CUTLERY/FOOD SERVICE

Norton sharpening systems and stones provide chefs with a complete range of sharpening products. Designed for today's modern kitchen and durable enough for years of dependable use.



SIZE L X W X H	QTY. PKG.	QTY. CASE	PACKAGE INCLUDES	PRODUCT NO.	UPC NO.
IM50 SINGLE-STONE SHARPENING STATIONS					
8 x 2 x 1	1	5	1 Coarse/Fine India Combination Stone, 4.5 oz Pharmacopoeia Grade Mineral Oil, Angle Guide, BLACK Base and Cover		69936642504 8
8 x 2 x 1	1	5	1 Coarse/Fine India Combination Stone, 4.5 oz Pharmacopoeia Grade Mineral Oil, Angle Guide, WHITE Base and Cover		66243580109 8
8 x 2 x 1	1	5	1 Soft Arkansas/Medium India Combination Stone, 4.5 oz Pharmacopoeia Grade Mineral Oil, Angle Guide, BLACK Base and Cover		69936643993 9
8 x 2 x 1	1	5	1 Soft Arkansas/Medium India Combination Stone, 4.5 oz Pharmacopoeia Grade Mineral Oil, Angle Guide, WHITE Base and Cover		66243580110 4
IM50 STATION REPLACEMENT CASES					
fits 8 x 2 x 1 stones	1	5	IM50 Case, Black		69936612790 4
fits 8 x 2 x 1 stones	1	5	IM50 Case, White		69936612799 7
IM200 TRI-STONE SHARPENING SYSTEM					
8 x 2 x 1	1	5	1 Coarse Crystolon, 1 Medium Crystolon and 1 Fine India Stone, 4.5 oz Pharmacopoeia Grade Mineral Oil, Angle Guide, and 1 BLACK Reservoir Unit		61463691265 3
8 x 2 x 1	1	5	1 Coarse Crystolon, 1 Medium Crystolon, 1 Fine India Stone, 4.5 oz Pharmacopoeia Grade Mineral Oil, Angle Guide, and 1 WHITE Reservoir Unit		61463691266 0
RETAIL ASSORTMENT					
	1	1	3 IM200 Units with Black Case, 1 IM200 Unit with White Case, 2 IM50 Units with Black Case, 1 IM50 Unit with White Case, 5 Instructional Booklet/Wedge Packages, 2 Packages of Oil in Decorative Boxes, and Copies of a Promotional Tri-fold in an Acrylic Holder		66253025026 5
COMBINATION BENCHSTONES (AND REPLACEMENT STONES FOR ABOVE SYSTEMS)					
8 x 2 x 3/4	1	5	Coarse/Fine Crystolon Combination Stone	CCS8	66243592750 7
8 x 2 x 3/4	1	5	Coarse/Fine India Combination Stone	ICS8	66243592751 4
8 x 2 x 3/4	1	5	Medium India/Soft Arkansas Combination Stone	SIMCS8	66243592753 8
8 x 2 x 3/4	1	5	Soft Arkansas/Hard Arkansas Combination Stone	HSCS8	66243592755 2
SHARPENING INSTRUCTIONS					
N/A	1	5	Cutlery Instructional DVD		66253029073 5
N/A	1	5	Instructional Booklet and Plastic Angle Wedge		69936612802 4
SHARPENING LUBRICANT					
4-1/2 oz	1	5	Pharmacopoeia Grade Oil – Individually-boxed		66243592747 7
4-1/2 oz	1	20	Pharmacopoeia Grade Oil – Bulk-packed		61463687760 0
8 oz	1	12	Sharpening Stone Solution – Non-oil-based, Citrus Scent		66253072278 6
8 oz.	1	12	Sharpening Stone Solution – Non-oil-based, Unscented		66253072273 1

For a complete description of the items in these Retail Packages, please see appropriate previous sections of this catalog

DIAMOND BENCHSTONES

Diamonds are the hardest known sharpening material.

Typical Applications

- Initial sharpening procedures
- Rapid stock removal
- Sharpening any hard material - including carbide
- Tool and knife repair
- Deburring, filing and abrading



Diamond Benchstones – The fastest cutting stone

FEATURES

- Single, solid, monocrystalline diamonds (use with water)
- Diamond abrasive with a nickel bond on a core of solid steel

BENEFITS

- Fastest cut
- Longest life
- Wear resistant, unbreakable
- Will not groove, cup, or hollow
- Holds tolerance of $\pm .002$ "

SIZE L X H	QTY. PKG.	QTY. CASE	SPECIFICATION	UPC NO.
DIAMOND BENCHSTONES				
SINGLE GRIT				
3-1/3 x 7/8 x 3/16	1	10	220	61463690624 9
3-1/3 x 7/8 x 3/16	1	10	325	61463690625 6
3-1/3 x 7/8 x 3/16	1	10	600	61463690626 3
3-1/3 x 7/8 x 3/16	1	10	1200	61463690627 0
6 x 2 x 1/4	1	5	325	61463690633 1
6 x 2 x 1/4	1	5	600	61463690634 8
new! 8 x 2 x 1/4	1	5	220	61463690636 2
new! 8 x 2 x 1/4	1	5	600	61463690638 6
new! 8 x 2 x 1/4	1	5	1200	61463690639 3
11-1/2 x 2-1/2 x 3/8	1	5	220	61463690640 9
11-1/2 x 2-1/2 x 3/8	1	5	325	61463690641 6
11-1/2 x 2-1/2 x 3/8	1	5	600	61463690642 3
11-1/2 x 2-1/2 x 3/8	1	5	1200	61463690643 0



The recommended lubricant for diamond benchstones is water, although oil may be used



DIAMOND LAPPING COMPOUND

Engineered to meet all OSHA and EPA safety requirements, these oil-soluble diamond lapping compounds produce high finishes and tight final tolerances.

Used after a sharpening sequence, diamond compound contains diamond particles suspended in oil to provide a highly polished and reflective finish on the backface of tools. Use on a cast iron plate, hard maple board, MDF board or leather strop.

Typical Applications

- Polishing for final dimensions of molds and dies
- Charging lapping plates and discs
- Tool polishing
- Honing fine edges of high-end woodworking tools
- Lapping seals
- Turbo charger for benchstones to speed up the cut rate and improve the finish



DIAMOND LAPPING COMPOUND

Diamond Sharpening Stones – The fastest cutting stone

FEATURES

- Micrograded synthetic diamond powders uniformly sized and distributed in a liquid vehicle
- Pre-engineered diamond concentrations, color-coded to industry standards
- Easy to use 5 or 18 gram plastic syringes

BENEFITS

- Work well with metals and ceramics
- Easily identify application – from preparatory lapping to finest finishing
- Quick dispensing and clean up

Polishing Kit

FEATURES AND APPLICATIONS

For the complete sharpening system, this polishing kit provides a sequence of grade 30 (medium cut), grade 15 (light cut), grade 6 (highly polished) and grade 3 (fine finish) diamond lapping compounds along with four MDF blocks and lubricant.



SIZE	QTY/ PKG	PKG/ CASE	COLOR	APPLICATION	GRADE	MICRON SIZE	UPC NO.
DIAMOND LAPPING COMPOUND							
OIL SOLUBLE							
5 Gram Syringe	1	5	Grey	High Mirror Finish	Grade 1/4	0-1/2 Micron	61463691123 6
5 Gram Syringe	1	5	Ivory	Very Fine Finish	Grade 1	0-2 Micron	61463691133 5
18 Gram Syringe	1	5	Ivory	Very Fine Finish	Grade 1	0-2 Micron	61463691134 2
5 Gram Syringe	1	5	Yellow	Fine Finish	Grade 3	2-4 Micron	61463691138 0
18 Gram Syringe	1	5	Yellow	Fine Finish	Grade 3	2-4 Micron	61463691139 7
5 Gram Syringe	1	5	Orange	Highly Polished	Grade 6	4-8 Micron	61463691143 4
5 Gram Syringe	1	5	Green	Polished	Grade 9	8-12 Micron	61463691148 9
18 Gram Syringe	1	5	Green	Polished	Grade 9	8-12 Micron	61463691149 6
5 Gram Syringe	1	5	Blue	Light Cut	Grade 15	12-22 Micron	61463691153 3
18 Gram Syringe	1	5	Blue	Light Cut	Grade 15	12-22 Micron	61463691154 0
5 Gram Syringe	1	5	Red	Medium Cut	Grade 30	22-36 Micron	61463691158 8
5 Gram Syringe	1	5	Brown	Fast Cut	Grade 45	35-54 Micron	61463691163 2
18 Gram Syringe	1	5	Brown	Fast Cut	Grade 45	35-54 Micron	61463691164 9
POLISHING KIT							
HANDY PACK KIT INCLUDES:							
5 Gram Syringes	1	1	4 Diamond Paste Syringes: 3u, 6u, 15u, 30u, 4 MDF Blocks and 1 Bottle of Lubricant				07660702462 6



Diamond lapping compound can be used to “turbo charge” oil stones. Use a Grade 9 with medium India stones and Grade 3 with Norton Hard Translucent Arkansas stones to improve the cut rate and finish on tough/hard steel. Grade 1 used on a piece of hard maple or MDF will provide a highly polished finish.

DRESSING STICKS

Regular use of properly selected dressing sticks will help you achieve maximum performance from your grinding wheels.

Typical Applications

- Truing, cleaning and dressing diamond, CBN and conventional abrasive wheels



Norbide High Performance Sticks

FEATURES AND BENEFITS

For offhand truing and dressing of medium grit, soft and medium-grade vitrified grinding wheels. Norbide and Boron Carbide are the hardest sticks you can buy. Made from boron nitride, they are well suited for dressing toolroom and cutter wheels 10" and smaller, especially cup and saucer shapes.

Vitrified Dressing Sticks

FEATURES AND BENEFITS

Aluminum Oxide (White)

For dressing and cleaning CBN wheels; these sticks also work well for diamond wheels.

Silicon Carbide (Black)

Coarse grit (24) and hard-grade (R and harder) sticks are used for dressing conventional vitrified wheels. Finer grit and softer grades are used for dressing diamond wheels.

SIZE L x W x H	QTY. PKG.	QTY. CASE	SPECIFICATION	UPC NO.
NORBIDE HIGH PERFORMANCE STICKS				
3 x 7/16 x 3/16	5	5	Boron Carbide	61463629472 8
3 x 1/2 x 3/16	5	5	Norbide	61463610148 4
VITRIFIED DRESSING STICKS				
ALUMINUM OXIDE				
4 x 1/2 x 1/2	5	5	38A220-HVBE	61463610555 0
6 x 1/2 x 1/2	5	5	38A150-IVBE	61463610303 7
6 x 1/2 x 1/2	5	5	38A220-HVBE	61463610103 3
4 x 3/4 x 1/2	5	5	38A60-LVBE	61463610415 7
4 x 3/4 x 3/4	5	5	38A60-LVBE	61463610440 9
4 x 3/4 x 3/4	5	5	38A80-MVBE	61463610362 4
4 x 3/4 x 3/4	5	5	38A150-HVBE	61463610291 7
4 x 3/4 x 3/4	5	5	38A150-IVBE	61463610368 6
4 x 3/4 x 3/4	5	5	38A220-HVBE	61463610290 0
8 x 3/4 x 3/4	5	5	38A220-HVBE	61463610280 1
6 x 1 x 1	5	5	38A150-HVBE	61463610405 8
6 x 1 x 1	5	5	38A150-IVBE	61463610453 9
6 x 1 x 1	5	5	38A220-HVBE	61463610406 5
8 x 1 x 1	5	5	38A120-IVBE	61463610390 7
8 x 1 x 1	5	5	38A150-IVBE	61463610455 3

SIZE L x W x H	QTY. PKG.	QTY. CASE	SPECIFICATION	UPC NO.
VITRIFIED DRESSING STICKS				
SILICON CARBIDE				
6 x 1/2 x 1/2	5	5	37C100-LV	61463610201 6
6 x 1/2 x 1/2	5	5	37C150-KV	61463610205 4
6 x 1/2 x 1/2	5	5	37C150-LV	61463610206 1
6 x 1/2 x 1/2	5	5	37C150-MV	61463610207 8
6 x 1/2 x 1/2	5	5	37C220-KV	61463610214 6
6 x 3/4 x 3/4	5	5	37C150-LV	61463610375 4
6 x 1 x 1	5	5	37C20-SVK	61463610459 1
6 x 1 x 1	5	5	37C24-SVK	61463610462 1
6 x 1 x 1	5	5	37C24-TVK	61463610354 9
6 x 1 x 1	5	5	37C46-RVK	61463610466 9
6 x 1 x 1	5	5	37C80-NV	61463610393 8
6 x 1 x 1	5	5	37C150-KV	61463610438 6
6 x 1 x 1	5	5	37C220-KV	61463610398 3
6 x 1 x 1 Retail Carded	5	5	Medium	07660710466 3
8 x 1 x 1	5	5	37C20-SVK	61463610469 0
8 x 1 x 1	5	5	37C24-SVK	61463610471 3
8 x 2 x 1	5	5	37C16-TVK	61463610482 9
8 x 2 x 1	5	5	37C24-TVK	61463610485 0
8 x 2 x 2	5	5	37C24-SVK	61463610490 4
VITRIFIED ROUND DRESSING STICKS				
SILICON CARBIDE				
6 x 1/2 (L x D)	5	5	37C24-SVK	61463610371 6
6 x 1	5	5	VERY COARSE S/C	61463687905 5

DRESSING STICKS

Vitrified Superfine Dressing Sticks

FEATURES AND BENEFITS

Super fine grit aluminum oxide and silicon carbide vitrified abrasive sticks for dressing superabrasive wheels.

SIZE L X W X H	QTY. PKG.	QTY. CASE	SPECIFICATION	UPC NO.
VITRIFIED SUPERFINE DRESSING STICKS				
SILICON CARBIDE				
6 x 1/2 x 1/2	5	5	NMVC320-J5VCA	61463615599 9
6 x 1/2 x 1/2	5	5	NMVC400-J5VCA	61463650324 0
6 x 1 x 1	5	5	NMVC320-J5VCA	61463610605 2
6 x 1 x 1	5	5	NMVC400-J5VCA	61463650450 6
ALUMINUM OXIDE				
8 x 1 x 1	5	5	NSA320-H8V	61463610597 0

Multi-Point Diamond Dressing Tool with Handle

new!

FEATURES AND BENEFITS

Screwdriver-handled multi-point dressing tool. Using the standard Norton 1A diamond section designed for most toolroom bench grinding wheels, this tool makes truing and dressing safe and simple. Simply align the long surface of the tool flat with the pedestal support on the bench grinder, then press into the wheel slightly. Move the tool slightly right then left, without going off the wheel and dressing is complete.

QTY. PKG.	QTY. CASE	SPECIFICATION	PRODUCT NO.	UPC NO.
MULTI-POINT DIAMOND DRESSING TOOL				
1	5	T-Handle Hand Dresser	IA6HD	66260148820 7

Offhand Dressing Stick and Holder

FEATURES AND BENEFITS

This convenient metal holder and round stick are widely used by mechanics and foundrymen for truing, dressing and changing the face of the wheel. The JT246 dressing stick – a very coarse grit silicon carbide for dressing conventional vitrified wheels – is firmly held and adjusted by the knurled control.



SIZE L X D	QTY. PKG.	QTY. CASE	DESCRIPTION	PRODUCT NO.	UPC NO.
OFFHAND DRESSING STICK AND HOLDER					
SILICON CARBIDE					
10" Overall	5	10	Dressing Stick and Holder	H6	61463687895 9
6 x 1/2 Round	5	10	Replacement Dressing Stick - Very Coarse	JT246	61463687900 0

SPECcheck



Selecting the appropriate dressing stick for each application depends on the wheel size, type, speed, specification and grit size, as well as the workpiece material. Initial starting specifications are listed below. We recommend testing several sticks to find the best one for your application.

Dressing Stick Starting Recommendations

VITRIFIED DRESSING STICKS		
	PRODUCT	SPECIFICATION
SUPERABRASIVE WHEELS – RESIN AND VITRIFIED BOND		
- 80, 100 and 120 Grits	Dressing Stick	38A150-HVBE
- 150, 180 and 220 Grits	Dressing Stick	38A220-HVBE
- 320 and Finer Grits	Superfine Stick	NMVC400-J5VCA
SUPERABRASIVE WHEELS – METAL BOND		
- 80, 100 and 120 Grits	Dressing Stick	37C80-NV
- 150, 180 and 220 Grits	Dressing Stick	37C150-KV
- 240 and Finer Grits	Dressing Stick	37C220-KV
CONVENTIONAL VITRIFIED WHEELS – VITRIFIED BOND		
- 46 Grit and Finer and M Grade and Softer	High Performance Dressing Stick	Norbide
	Conventional Dressing Stick	37C24-SVK

tips

Dressing Diamond and CBN Wheels

- Resin and Vitrified Bond, Diamond and CBN Wheels: Choose a dressing stick one or two grit sizes finer than the abrasive in the wheel – in a soft grade (H or I).

- Metal Bond, Diamond and CBN Wheels

Choose a stick the same grit size or one grit size coarser than the abrasive in the wheel – in a medium grade (K–M).



While sharpening knives, blades and tools, be careful to keep fingers away from sharp edges.

DRESSING STICKS

Rubber Finishing Sticks

FEATURES AND BENEFITS

These sticks are used for manual, or mechanical honing on machines where they are mounted in holders or fixtures. Intended for use where precision dimensional limits and grade controls are required, such as die polishing.

SIZE L X W X H	QTY. PKG.	QTY. CASE	SPECIFICATION	UPC NO.
RUBBER FINISHING STICKS				
ALUMINUM OXIDE				
6 x 1/2 x 1/2	5	20	57A120-B2RR	61463610608 3
6 x 1 x 1/2	5	20	57A120-B2RR	61463610609 0

FastTrack Made-To-Order Microabrasive Sticks

Superfinishing blank stock encompasses a wide range of different specifications. These blanks can be finished to your dimensional requirements within two weeks from the date that the order is received at Norton. Small lots, for test purposes, can be express shipped.

APPLICATIONS	ABRASIVE TYPE BOND	GRIT	TREATMENT TYPE
Superfinishing, Finishing and Dressing	NLA - V NMVC - VCA NSA - V	240 - 1200	Sulfur, Wax
Honing	SG - VS SGG - VS1	54 - 220	Sulfur, Wax



A TOOL IS ONLY AS GOOD AS ITS EDGE™

THE NORTON NAME IS YOUR ASSURANCE OF THE FINEST SHARPENING PRODUCT AVAILABLE.



Reshaping
your
world.



CATALOG #8716

CONSTRUCTION
DISTRIBUTION MARKET
**FLOOR CARE
PRODUCTS**

- DIAMOND
- COATED
- NON-WOVEN



ALL THE **MUSCLE** YOU NEED™



Made with a robust interlocking web, these diamond maintenance pads are designed to deliver a consistent finish and withstand the harsh applications of concrete and natural stone floor maintenance. Can be used on all wet and dry machines.

COARSE FLOOR POLISHING PADS

The coarse diamond maintenance pad is perfect for cleaning and resurfacing concrete or natural stone floors. It works very well for floors that are very dirty with light surface scratches. The coarse grit pad should be followed by the medium pad as you re-surface the floor.

UPC	SIZE	GRIT	QTY
701846 43513 0	7"	400	2
701846 43517 8	13"	400	2
701846 41575 0	17"	400	2
701846 41579 8	20"	400	2
701846 44146 9	27"	400	2



MEDIUM FLOOR POLISHING PADS

The medium grit pad is the second step to re-surfacing a natural stone or concrete floor following the coarse pad. It can also be the starting pad if the floor is slightly dirty with faint surface scratches.

UPC	SIZE	GRIT	QTY
701846 43514 7	7"	800	2
701846 43518 5	13"	800	2
701846 41576 7	17"	800	2
701846 41580 4	20"	800	2
701846 44147 6	27"	800	2



FINE FLOOR POLISHING PADS

The fine grit pad is the third step in the re-surfacing of a natural stone or concrete floor following the medium grit. Can also be used a maintenance pad on most surfaces to keep the shine of the floor on a regular basis.

UPC	SIZE	GRIT	QTY
701846 43515 4	7"	1500	2
701846 43519 2	13"	1500	2
701846 41577 4	17"	1500	2
701846 41581 1	20"	1500	2
701846 41583 5	27"	1500	2



VERY FINE FLOOR POLISHING PADS

The very fine grit pad is the final step in the re-surfacing of a natural stone or concrete floor following the fine grit pad. It is also the recommended pad for on-going maintenance of the floor to keep the shine level of the floor on a regular basis.

UPC	SIZE	GRIT	QTY
701846 43516 1	7"	3000	2
701846 43520 8	13"	3000	2
701846 41578 1	17"	3000	2
701846 41582 8	20"	3000	2
701846 41584 2	27"	3000	2



ASSORTED FLOOR POLISHING PADS

Perfect for applications where only a few pads are needed to get the job done. Available in the two most popular sizes, the assorted packs contain one each of the grit types; coarse, medium, fine and very fine.

UPC	SIZE	GRIT	QTY
701846 41589 7	17"	1 each of 400, 800, 1500, 3000	4
701846 41590 3	20"	1 each of 400, 800, 1500, 3000	4



FLOOR SANDING BELTS

Abrasive floor sanding belts are mounted to a belt machine for continuous sanding of the main portion of the floor. Ideal for heavy stock removal, leveling floors and achieving a very smooth finish. Popular with professional contractors for use on larger jobs.

NORTON BLUEFIRE (R831 CLOTH)

Try Norton Blue Fire for improved cut rate, extended life and less loading than conventional sanding belts – utilizing the Norton patented zirconia alumina grain technology for the very best finish.

UPC	GRIT	MIN PKG	CASE
7-7/8" x 29-1/2" (LAGLER-HUMMEL, PROSAND, GALAXY 2000)			
666233 19968 5	120	10	10
666233 19969 2	100	10	10
666233 19970 8	80	10	10
666233 19971 5	60	10	10
666233 19972 2	50	10	10
666233 19973 9	40	10	10
666233 19975 3	36	10	10
666233 19974 6	24	10	10

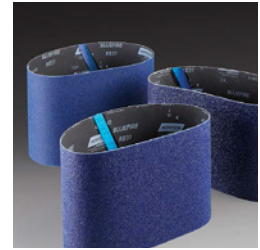

NORTON DURITE (R422 CLOTH)

Choose our 100% Norton Durite silicon carbide abrasive with tough X-weight cotton backing for quality cut and low initial cost.

UPC	GRIT	MIN PKG	CASE
7-7/8" x 29-1/2" (LAGLER-HUMMEL, PROSAND, GALAXY 2000)			
780727 20780 6	120	10	10
780727 16000 2	100	10	10
780727 16001 9	80	10	10
780727 16002 6	60	10	10
780727 16003 3	50	10	10
780727 16004 0	40	10	10
780727 16005 7	36	10	10
780727 16006 4	24	10	10
780727 69536 8	16	10	10
8" x 19" (CLARKE EZ-8)			
780727 10307 8	120	10	10
076607 00726 1	100	10	10
076607 00727 8	80	10	10
076607 00728 5	60	10	10
780727 10308 4	50	10	10
780727 43002 0	40	10	10
076607 00729 2	36	10	10
076607 00730 0	24	10	10
780727 72102 9 FT	16	10	10



FT = FASTTRACK ITEM



FLOOR SANDING ROLLS

Floor sanding rolls are used for larger jobs such as the main portion of the floor. A pre-cut roll cover is cut to spec and mechanically applied to a rubber drum. Rolls are preferred for their ease of storing and carrying over pre-cut sheets. Rolls are commonly used in the rental trade due to their lower cost versus sanding belts.

NORTON BLUEFIRE (H PAPER)

The Norton Blue Fire with its patented zirconia alumina grain improves cut rate, extends life and provides less loading than conventional sanding belts.

UPC	GRIT	MIN PKG	CASE
8" x 50 YD			
666233 74264 5	120	1	1
666233 74268 3	100	1	1
666233 74269 0	80	1	1
666233 74271 3	60	1	1
666233 74272 0	50	1	1
666233 74273 7	40	1	1
666233 74274 4	36	1	1
666233 74270 6	24	1	1

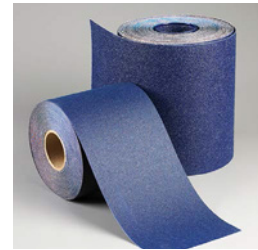

NORTON DURITE (H425, H422, S413 PAPER)

The industry standard Norton Durite silicon carbide abrasive paper provides both a quality cut and a low initial cost

UPC	GRIT	MIN PKG	CASE
8" x 7-1/2" YD (270")			
662611 23412 2 NS	120	3	3
662611 47150 3	100	3	3
662611 15629 5	80	3	3
662611 15600 4	60	3	3
662611 15628 8	50	3	3
662611 15627 1	40	3	3
662611 12748 6	36	3	3
662611 02431 0	30	3	3
662611 13270 1	20	3	3
8" x 50 YD			
662611 23444 3	100	1	1
662611 23446 7	80	1	1
662611 23445 0	60	1	1
662611 23785 7	40	1	1
662611 23786 4 NS	36	1	1
662610 38958 8	24	1	1
662611 23789 5 NS	20	1	1
662611 23788 8 NS	16	1	1

NS = NON-STOCK

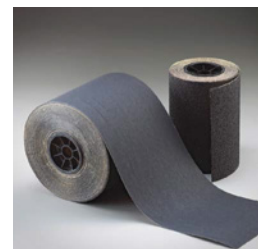

true blue REINVENTED

A unique microstructure, optimal chemistry, and superior process control give Norton BlueFire a significant performance advantage with material removal rates and up to 30% longer life over conventional zirconia products. The proven performance of the original blue belt is now infused with the newest grain technology for even greater results.



FLOOR SANDING SHEETS / COVERS

A wide array of choices from high productivity to low cost, floor sanding silicon carbide sheets and covers are pre-cut to meet manufacturers drum sander specs. Ideal for all phases of a small job.

PAPER DRUM COVERS			
UPC	GRIT	MIN PKG	CASE
4-1/2" x 16-3/8" (FLORBOSS)			
662611 31739 9	100	10	50
662611 31740 5	80	10	50
662611 31741 2	60	10	50
662611 31742 9 NS	40	10	50
662611 31743 6	36	10	50
662611 23811 3	20	10	50
662611 31745 0 NS	16	10	50
699573 48816 4	12	10	50
8" x 17-1/2" (SILVERLINE SLV8)			
662611 96420 3	100	10	50
662611 96442 5	80	10	50
662611 96421 0	60	10	50
662611 96422 7	50	10	50
662611 96424 1	40	10	50
662611 96425 8	36	10	50
662611 96426 5	24	10	50
8" x 19-1/2" (CLARKE 8" MODEL DU-8, DU8R & D48R)			
662611 46738 4	100	10	50
662611 46739 1	80	10	50
662611 46740 7	60	10	50
662611 46742 1	40	10	50
662611 46743 8	36	10	50
662611 46745 2	20	10	50
662611 46746 9	16	10	50
662611 00255 4 NS	12	10	50
8" x 20" (AMERICAN)			
699573 47988 9 NS	100	10	50
699573 47989 6 NS	80	10	50
699573 47990 2 NS	60	10	50
699573 47991 9 NS	40	10	50
699573 47992 6 NS	36	10	50
699573 47997 1 NS	20	10	50
699573 47999 5 NS	16	10	50
8" x 20-3/16" (SILVERLINE SL 8)			
662611 42093 8 NS	120	10	100
662611 46762 9	100	10	50
662611 46763 6	80	10	50
662611 46765 0	60	10	50
662611 46766 7	40	10	50
662611 46767 4	36	10	50
662611 46770 4	20	10	50
662611 46771 1 NS	16	10	50
8" x 20-1/4" (CLARKE EC-8 NO NOTCHES)			
662611 31754 2	100	10	50
662611 31755 9	80	10	50
662611 31756 6	60	10	50
662611 10408 1	50	10	50
662611 31757 3	40	10	50
662611 31758 0	36	10	50
662611 31759 7 NS	20	10	50
662611 31760 3 NS	16	10	50

NS = NON-STOCK

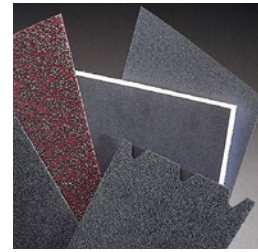

Orbital sheets are pre-cut to meet manufacturers drum sander specs. Easy to use, popular in the rental trade, they are used on a square or rectangular-shaped sander that sands in a short, orbital pattern. Ideal for all phases of a small job, they can also be used as a polisher.

DOUBLE-SIDED PAPER

100% silicon carbide abrasive coated with abrasive on both sides for twice the life, quick switch, no PSA contamination, increased tear resistance. Strong E & F weight paper for increased durability.

UPC	GRIT	MIN PKG	CASE
12" x 18" (SQUARE-BUFF, CLARKE, DEVA, SILVERLINE)			
662611 43140 8	120	10	10
662611 43141 5	100	10	10
662611 43142 2	80	10	10
662611 43143 9	60	10	10
662611 43144 6 NS	40	10	10
662611 43145 3	36	10	10
662611 49158 7	20	10	10
12" x 24" (SQUARE-BUFF, CLARKE, DEVA, SILVERLINE)			
662611 43146 0	120	10	10
662611 43147 7 NS	100	10	10
662611 43148 4 NS	80	10	10
662611 43149 1 NS	60	10	10
662611 43150 7 NS	40	10	10
662611 43151 4 NS	36	10	10
662611 49159 4 NS	20	10	10

NS = NON-STOCK

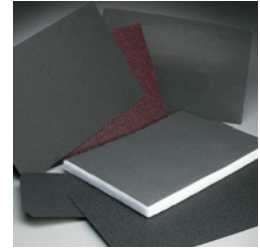

SCREEN-BAK

Screen discs are inter-woven polyester open mesh with abrasive grain on both sides for maximum life and use. Rinse and reuse. Screens tend to abrade more aggressively than paper or cloth. Always use with a non-woven back-up pad. The orbital machines rests on top of the non-woven pad which acts as the driver for the abrasive screen, cutting softer to leave less of a scratch pattern. Choose white (non-abrasive) or red for a general purpose driver pad. Choose maroon for between coats abrasion with pad only.

UPC	GRIT	MIN PKG	CASE
12" x 18" SCREENS (SQUARE-BUFF, CLARKE, DEVA, SILVERLINE)			
662611 22411 6	180	10	10
076607 02490 9	150	10	10
076607 01393 4	120	10	10
076607 02489 3	100	10	10
662611 22415 4	80	10	10
12" x 24" SCREENS (FLOOR KING M101-24)			
662611 35719 7 NS	180	10	10
662611 35720 3 NS	150	10	10
662611 35721 0 NS	120	10	10
662611 35722 7 NS	100	10	10
662611 35723 4 NS	80	10	10
12" x 18" x 1/4" BACK-UP PADS			
662610 51664 9	Tan		10
662610 51665 6	White		10
662610 06179 8 NS	Green		10
12" x 18" x 1" BACK-UP PADS – UPC CODED (SQUARE-BUFF, CLARKE, DEVA, SILVERLINE)			
076607 01392 7	White, Super 54		5
662610 09217 4	Maroon Very Fine		10
076607 03846 3	Thick Red		5
12" x 24" x 1" BACK-UP PADS (FLOOR KING M101-24)			
662610 51676 7	White, Super 54		5
12" x 24" x 1/4" BACK-UP PADS			
662610 51669 4	White		10

NS = NON-STOCK

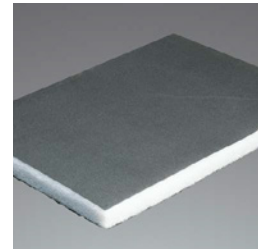

TECH TIP

To mount, place a paper or screen sheet on the floor, then place the non-woven driver pad on top. Next, tilt the machine back on a 45 degree angle and then lower it squarely on top of the driver pad.

LARGE DIAMETER DISCS

Large diameter discs are great for removing material such as glue, carpet backing and other heavy residues on wood floors. Also used to hard plate, final blending of the floor and between coats sanding.

PAPER (DURITE H422 / S456 PAPER)

Paper discs come in heavy E, F and combination paper backings for quality cut and strength.

UPC	GRIT	MIN PKG	CASE
15" x 2"			
662611 24678 1 NS	100	10	10
662611 24686 6	80	10	10
662611 35872 9 NS	60	10	10
662611 24680 4	36	10	10
662611 24636 1	20	10	10
662611 24671 2	16	10	10
662611 35874 3	12	10	10
16" x 2"			
662611 24644 6	100	10	10
662611 24665 1	80	10	10
662611 24659 0	60	10	10
662611 39520 5 NS	40	10	10
662611 24650 7	36	10	10
662611 24637 8	20	10	10
662611 24672 9	16	10	10
662611 28561 2	12	10	10
17" x 2"			
662611 24679 8	100	10	10
662611 24687 3	80	10	10
662611 24684 2	60	10	10
662611 24682 8 NS	40	10	10
662611 24651 4	36	10	10
662611 24638 5	20	10	10
662611 24673 6 NS	16	10	10
662611 36231 3	12	10	10
19" x 2"			
699573 48005 2 NS	100	10	10
699573 48006 9 NS	80	10	10
699573 48007 6 NS	60	10	10
699573 48008 3 NS	40	10	10
699573 48010 6 NS	36	10	10
699573 48012 0 NS	20	10	10
699573 48014 4 NS	16	10	10
20" x 2"			
662611 35735 7	100	10	10
662611 35736 4 NS	80	10	10
662611 35737 1	60	10	10
662611 39519 9 NS	40	10	10
662611 35738 8	36	10	10
662611 35739 5	20	10	10
662611 35740 1	16	10	10
662611 35741 8	12	10	10

NS = NON-STOCK

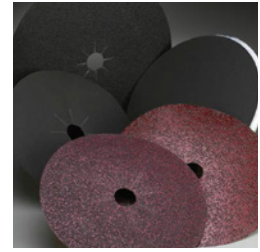

PAPER – DOUBLE-SIDED (DURITE H425 / S413)

Double-sided discs are coated on both sides for twice the life and not PSA contamination, quicker change, and increased resistance to tearing.

UPC	GRIT	MIN PKG	CASE
16" BLANK DISC			
662611 43128 6	120	10	10
662611 43129 3	100	10	10
662611 43130 9	80	10	10
662611 43131 6	60	10	10
662611 43132 3	40	10	10
662611 43133 0	36	10	10
662611 49150 1	20	10	10
17" BLANK DISC			
662611 49152 5	100	10	10
662611 49153 2	80	10	10
662611 49154 9	60	10	10
662611 49155 6	36	10	10
662611 49151 8 NS	20	10	10
20" BLANK DISC			
662611 49156 3 NS	100	10	10
662611 49157 0	80	10	10
662611 49059 7	60	10	10
662611 49058 0 NS	36	10	10
662611 49057 3 NS	20	10	10

NS = NON-STOCK



TECH TIP

Remember the buffer sands at the 3 o'clock position as you look down at the machine. Make sure you screen the unfinished wood with the screen cutting in the same direction as the grain.

Double-sided discs make hard plating simpler and easier by eliminating the need to mechanically fasten the disc to the bottom of the buffer. Always use a screen driver pad with a double-sided disc to prevent slippage, and get the flattest surface possible. You can sandwich a screen driver pad between two double-sided discs to increase stiffness for an even flatter surface.



For use on hand-held edger machine to sand areas where the drum/belt sander does not reach.

NORTON BLUEFIRE (H831 PAPER)

Norton BlueFire has a patented zirconia alumina grain to provide the smoothest finish with less down time.

UPC	GRIT	MIN PKG	CASE
7" x 5/16" (PROSAND, SILVERLINE, RED-DEVIL, AMERICAN SPINNER)			
666233 19904 3	120	25	25
666233 19905 0	100	25	25
666233 19906 7	80	25	25
666233 19907 4	60	25	25
666233 19908 1	50	25	25
666233 19909 8	40	25	25
666233 19910 4	36	25	25
666233 19911 1	24	25	25
7" x 7/8" (CLARKE, HOLD, PORTER CABLE, SKIL, TENNANT)			
666233 19912 8	120	25	25
666233 19913 5	100	25	25
666233 19914 2	80	25	25
666233 19915 9	60	25	25
666233 19916 6	50	25	25
666233 19917 3	40	25	25
666233 19918 0	36	25	25
666233 19919 7	24	25	25

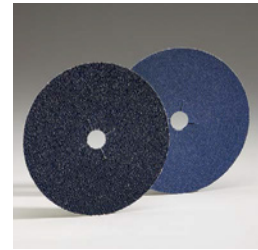

NORTON DURITE

Norton Durite has a traditional silicon carbide grain allowing smooth finishes with less cost.

UPC	GRIT	MIN PKG	CASE
5" x 1/4" (CLARKE)			
662611 45845 0	100	100	500
662611 45850 4	80	100	500
662611 45855 9	60	100	500
662611 45860 3	50	100	500
662611 45865 8	40	100	500
662611 45870 2	36	100	500
662611 45875 7	30	100	500
662611 10788 4	24	100	500
662611 45885 6	20	50	250
662611 45890 0	16	50	250
662611 04473 8 NS	12	50	250
7" x 5/16" (PROSAND, SILVERLINE, RED-DEVIL, AMERICAN SPINNER)			
662611 35063 1	120	100	100
662611 35064 8	100	100	100
662611 35065 5	80	100	100
662611 35066 2	60	100	100
662611 35067 9	50	100	100
662611 35068 6	40	50	50
662611 35069 3	36	50	50
662611 35070 9	30	50	50
662611 35071 6	24	50	50
662611 35072 3	20	50	50
662611 35073 0	16	50	50
662611 35074 7	12	25	25
7" x 7/8" (CLARKE, HOLD, PORTER CABLE, SKIL, TENNANT)			
662611 35075 4	120	100	100
662611 35076 1	100	100	100
662611 35077 8	80	100	100
662611 35078 5	60	100	100
662611 35079 2	50	100	100
662611 35080 8	40	50	50
662611 35081 5	36	50	50
662611 35082 2	30	50	50
662611 35083 9	24	50	50
662611 35084 6	20	50	50
662611 35085 3	16	50	50
662611 35086 0	12	25	25



NS = NON-STOCK

NORTON BLUEFIRE EDGERS HOOK & LOOP (PAPER)

Norton BlueFire has a patented zirconia alumina grain to provide the smoothest finish with less down time.

UPC	GRIT	MIN PKG	CASE
7" x 0 - CLARK, PROSAND, SILVERLINE			
666233 74344 4	120	25	25
666233 74345 1	100	25	25
666233 74346 8	80	25	25
666233 74347 5	60	25	25
666233 74349 9	50	25	25
666233 74350 5	40	25	25
666233 74351 2	36	25	25
666233 74352 9	24	25	25
8" x 0 - LAGLER TRIO			
666233 74361 1	120	25	100
666233 74362 8	100	25	100
666233 74363 5	80	25	100
666233 74364 2	60	25	100
666233 74365 9	50	25	100
666233 74366 6	40	25	100
666233 74367 3	36	25	100
662610 02311 6	Back-up / Conditioning Pad	Maroon – Very Fine	80

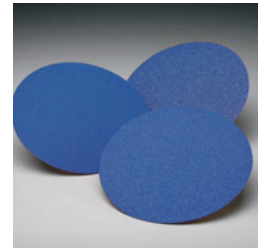

EDGERS HOOK & LOOP (PAPER)

Specially designed with hook & loop fastening system for ease of attachment. Strong backing for tear resistance.

UPC	GRIT	MIN PKG	CASE
5" x 0 (8 VAC HOLES) – ALUMINUM OXIDE			
662611 30239 5	220	50	200
662611 30240 1	180	50	200
662611 30241 8	150	50	200
662611 30242 5	120	50	200
662611 30243 2	100	50	200
662611 30244 9	80	50	200
662611 30245 6	60	50	200
6" x 0 (U-SAND) – SILICON CARBIDE			
662611 96408 1	100	40	40
662611 96411 1	80	40	40
662611 95622 2	60	40	40
662611 96412 8	50	40	40
662611 96414 2	40	40	40
662611 96416 6	36	40	40
662611 95623 9	24	40	40
076607 03093 1	Back-up / Conditioning Pad	Maroon – Very Fine	10

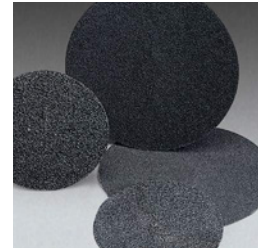

SCREEN-BAK (Q421 SCREEN)

Screen-Bak is an inter-woven polyester knit backing with abrasive grain on both sides. Reusable, tear resistant and more aggressive than paper or cloth products.

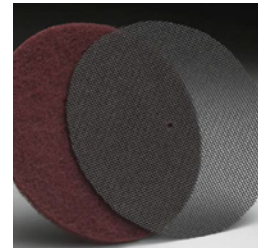

UPC		GRIT	MIN PKG	CASE
7-7/8" x 3/16" (LAGLER TRIO)				
662611 23814	4	180	20	40
662611 31731	3	150	20	40
662611 31732	0	120	20	40
662611 31733	7	100	20	40
662611 31734	4	80	20	40
662611 31730	6	60	20	40
662610 07703	4 NS	Back-up / Conditioning Pad	Maroon – Very Fine	40
7" x 5/16"				
662611 23812	0 NS	180	20	40
662611 23044	5 NS	150	20	40
662611 31817	4	120	20	40
662611 31818	1	100	20	40
662611 31819	8	80	20	40
662611 19583	6 NS	60	20	40
662610 31815	1	Back-up / Conditioning Pad	Maroon – Very Fine	40
7" x 7/8"				
662611 23813	7 NS	180	20	40
662611 23046	9 NS	150	20	40
662611 13130	8	120	20	40
662611 31821	1	100	20	40
662611 31822	8	80	20	40
662611 07073	7 NS	60	20	40
662610 31816	8	Back-up / Conditioning Pad	Maroon – Very Fine	40

NS = NON-STOCK

TECH TIP

Used with a Maroon Conditioning Pad, screens can be an optional step in the edging sequence to provide a much finer finish than a paper disc.



The Screen-Bak discs are more aggressive, durable and have longer life than most other screen products in the industry. Manufactured with an inter-locking polyester knit backing, coated with abrasive on both sides and the open mesh for load resistance make recoating projects easy and economical.

SCREEN-BAK (Q421)			
UPC	GRIT	MIN PKG	CASE
13" DIAMETER			
662611 20497 2 NS	150	10	10
662611 20498 9 NS	120	10	10
662611 20499 6	100	10	10
662611 20500 9	80	10	10
662611 20501 0	60	10	10
15" DIAMETER			
662611 21490 2	220	10	10
662611 20508 5	180	10	10
662611 20509 2	150	10	10
662611 20510 8	120	10	10
662611 20511 5	100	10	10
662611 20512 2	80	10	10
662611 20513 9	60	10	10
16" DIAMETER			
662611 23032 2	220	10	10
662611 20514 6	180	10	10
662611 20515 3	150	10	10
662611 20516 0	120	10	10
662611 20517 7	100	10	10
662611 20518 4	80	10	10
662611 20519 1	60	10	10
17" DIAMETER			
662611 31726 9 NS	220	10	10
662611 20520 7	180	10	10
662611 20521 4	150	10	10
662611 20522 1	120	10	10
662611 20523 8	100	10	10
662611 20524 5	80	10	10
662611 20525 2	60	10	10
18" DIAMETER			
662611 31727 6	220	10	10
662611 20526 9	180	10	10
662611 20527 6	150	10	10
662611 20528 3	120	10	10
662611 20529 0	100	10	10
662611 20530 6	80	10	10
662611 20531 3	60	10	10
19" DIAMETER			
662611 20532 0 NS	180	10	10
662611 20533 7 NS	150	10	10
662611 20534 4	120	10	10
662611 20535 1	100	10	10
662611 20536 8	80	10	10
662611 20537 5	60	10	10
20" DIAMETER			
662611 20538 2 NS	180	10	10
662611 20539 9	150	10	10
662611 20540 5	120	10	10
662611 20541 2	100	10	10
662611 20542 9	80	10	10
662611 20543 6	60	10	10
21" DIAMETER			
662611 20544 3 NS	180	10	10
662611 20545 0 NS	150	10	10
662611 20546 7 NS	120	10	10
662611 20547 4 NS	100	10	10
662611 20548 1 NS	80	10	10
662611 20549 8 NS	60	10	10

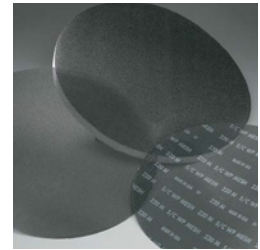

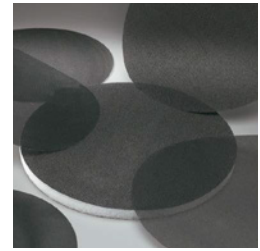

SCREEN-BAK (Q425)			
UPC	GRIT	MIN PKG	CASE
15" DIAMETER			
662611 57321 4	120	10	10
662611 57320 7	100	10	10
662611 57319 1	80	10	10
662611 57318 4	60	10	10
16" DIAMETER			
662611 48894 2	220	10	10
662611 48895 6	180	10	10
662611 48896 3	150	10	10
662611 48897 0	120	10	10
662611 48898 7	100	10	10
662611 48899 4	80	10	10
662611 48900 1	60	10	10
17" DIAMETER			
662611 48901 7	180	10	10
662611 48902 4	150	10	10
662611 48903 1	120	10	10
662611 48904 8	100	10	10
662611 48905 5	80	10	10
662611 48906 2	60	10	10
18" DIAMETER			
662611 57331 3	120	10	10
662611 48907 0	100	10	10
662611 48908 6	80	10	10
662611 48909 3	60	10	10
19" DIAMETER			
662611 57335 5	120	10	10
662611 57334 2	100	10	10
662611 57333 9	80	10	10
662611 57332 6	60	10	10
20" DIAMETER			
662611 48910 5	120	10	10
662611 48911 2	100	10	10
662611 48912 9	80	10	10
662611 48913 6	60	10	10

TECH TIP

Screens can be rinsed and reused to prolong sanding life. Rinsing the screens removes any debris or build-up in the screen, exposing a fresh cutting surface.

THIN FLOOR MAINTENANCE PADS

Designed with a thick, open web, superior grain distribution and coating process allows extended pad life with high performance results. Heavy fiber and coarse grains provide quick finish removal. Fine fiber combinations that are resilient to conform to the floor for mirror finishes when buffing. Traditional rental-grade pads.

THIN FLOOR PADS		
UPC	COLOR	PADS PER CASE
13" x 1/4"		
662610 59080 9 NS	White	10
662610 59082 3 NS	Green	10
662610 59083 0 NS	Black	10
15" x 1/4"		
662610 59089 2 NS	Tan	10
662610 59088 5 NS	White	10
662610 59090 8 NS	Green	10
662610 59091 5 NS	Black	10
16" x 1/4"		
662610 59093 9 NS	Tan	10
662610 59092 2 NS	White	10
662610 59094 6 NS	Green	10
662610 59095 3	Black	10
662610 51679 3	Tan	5
17" x 1/4"		
662610 59097 7	Tan	10
662610 59096 0	White	10
662610 59098 4	Green	10
662610 59099 1	Black	10
18" x 1/4"		
662610 59101 1 NS	Tan	10
662610 59100 4 NS	White	10
662610 59102 8 NS	Green	10
20" x 1/4"		
662610 59110 3	Green	10
662610 59111 0 NS	Black	10



NS = NON-STOCK

TECH TIP

Swirling and powdering is the result of a floor pad that is too aggressive for the floor finish. Move to a softer, less aggressive floor pad if this occurs. If scuff mark and scratches are not being removed, move to a more aggressive pad.

For cost savings, pads can be cleaned and re-used. Clean by using a high-pressure spray nozzle to remove fresh debris. Pads may be soaked in detergent or diluted stripping solution to dissolve heavy embedded soil or finish.

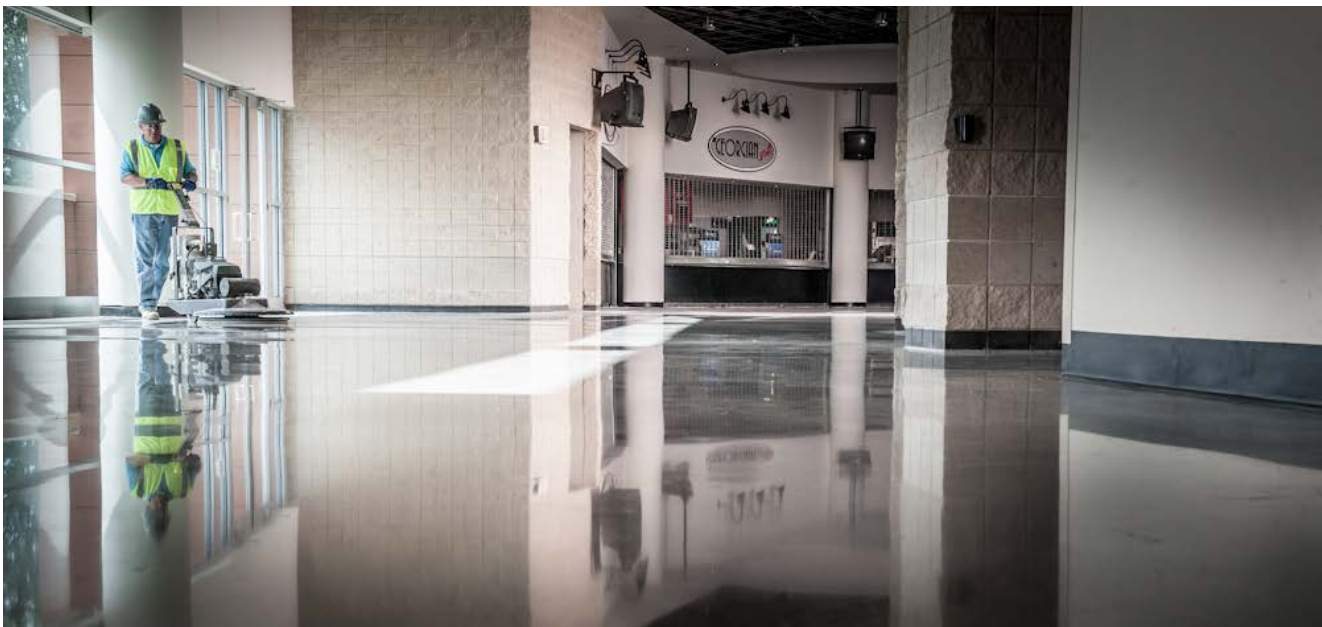

THICK FLOOR MAINTENANCE PADS

Designed with a thick, open web, superior grain distribution and coating process allows extended pad life with high-performance results. Heavy fiber and coarse grains provide quick finish removal. Fine fiber combinations that are resilient to conform to the floor for mirror finishes when buffing. 1" thick for longer life.

THICK FLOOR PADS		
UPC	COLOR	PADS PER CASE
12" x 18" x 1"		
662610 05290 1	Tan	5
662610 06547 5	White	5
662610 51672 4	Red	5
662610 02596 7 NS	Green	5
662610 51677 9	Black	5
13" x 1"		
662610 57600 1 NS	Tan	5
662610 54205 1	White	5
662610 54272 3	Red	5
662610 54240 2	Blue	5
662610 54257 0	Green	5
662610 54223 5	Black	5
15" x 1"		
662610 57601 8 NS	Tan	5
662610 54207 5	White	5
662610 54274 7	Red	5
662610 54242 6	Blue	5
662610 54259 4	Green	5
662610 54225 9	Black	5
16" x 1"		
662610 57604 9 NS	Tan	5
662610 54208 2	White	5
662610 54275 4	Red	5
662610 54243 3	Blue	5
662610 54260 0	Green	5
662610 54226 6	Black	5
17" x 1"		
662610 57607 0	Tan	5
662610 54209 9	White	5
662610 54276 1	Red	5
662610 54244 9	Blue	5
662610 54261 7	Green	5
662610 54227 8	Black	5
18" x 1"		
662610 57609 4	Tan	5
662610 54210 5	White	5
662610 54277 8	Red	5
662610 54245 7	Blue	5
662610 54262 4	Green	5
662610 54228 0	Black	5
20" x 1"		
662610 57611 7	Tan	5
662610 54212 9	White	5
662610 54279 2	Red	5
662610 54247 1	Blue	5
662610 54264 8	Green	5
662610 54230 3	Black	5

NS = NON-STOCK



CONSTRUCTION DISTRIBUTION MARKET FLOOR CARE PRODUCTS



AT THE END OF THE DAY,
NORTON GETS THE JOB DONE.



Diamond Floor Polishing Pads

These diamond maintenance pads are designed to deliver a consistent finish and withstand the harsh applications of concrete and natural stone floor maintenance.



Floor Sanding Belts

Choose our hard-working industry-standard Norton Durite silicon carbide abrasive belts or, try the Norton Blue Fire zirconia alumina abrasive belts for improved cut rate, extended life and less loading than conventional sanding belts.



Floor Sanding Rolls

For those who like to cut their own sizes/shapes, we offer two options; the Norton Blue Fire with its patented zirconia alumina grain or, the industry standard Norton Durite silicon carbide abrasive paper for quality cut and low initial cost.

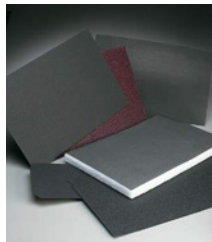

Floor Sanding Sheets / Covers

Wide array of choices from high productivity to low cost, floor sanding silicon carbide sheets and covers are pre-cut to meet manufacturers drum sander specs.

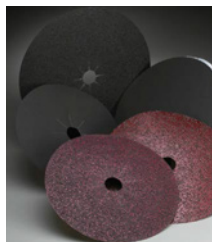

Floor Sanding Discs

Available in Large Diameter, Edger, and Screen in sizes to fit standard machines.



Non-Woven Floor Maintenance Pads

Designed with a thick, open web, superior grain distribution and coating process allows extended pad life with high performance results.



AMERICAN[®]

brand

PERFORMANCE SOLUTIONS FOR THE
**AUTOMOTIVE
AFTERMARKET**





Automotive Aftermarket Masking Solutions

IPG® and Norton are committed to a vision for the Automotive PBE Market to be recognized as a leader in performance masking, surface protection and complementary products – by upholding our customer commitment to deliver solutions that increase productivity, maintain product integrity, contain cost and promote environmental stewardship.



American® brand and Norton products have long been trusted by collision repair professionals for their unsurpassed quality and performance. But we do not rely only on our joint history or reputation. Our mission, as a team, is to build upon this proven performance and exceed the expectations of our customers in the automotive aftermarket.

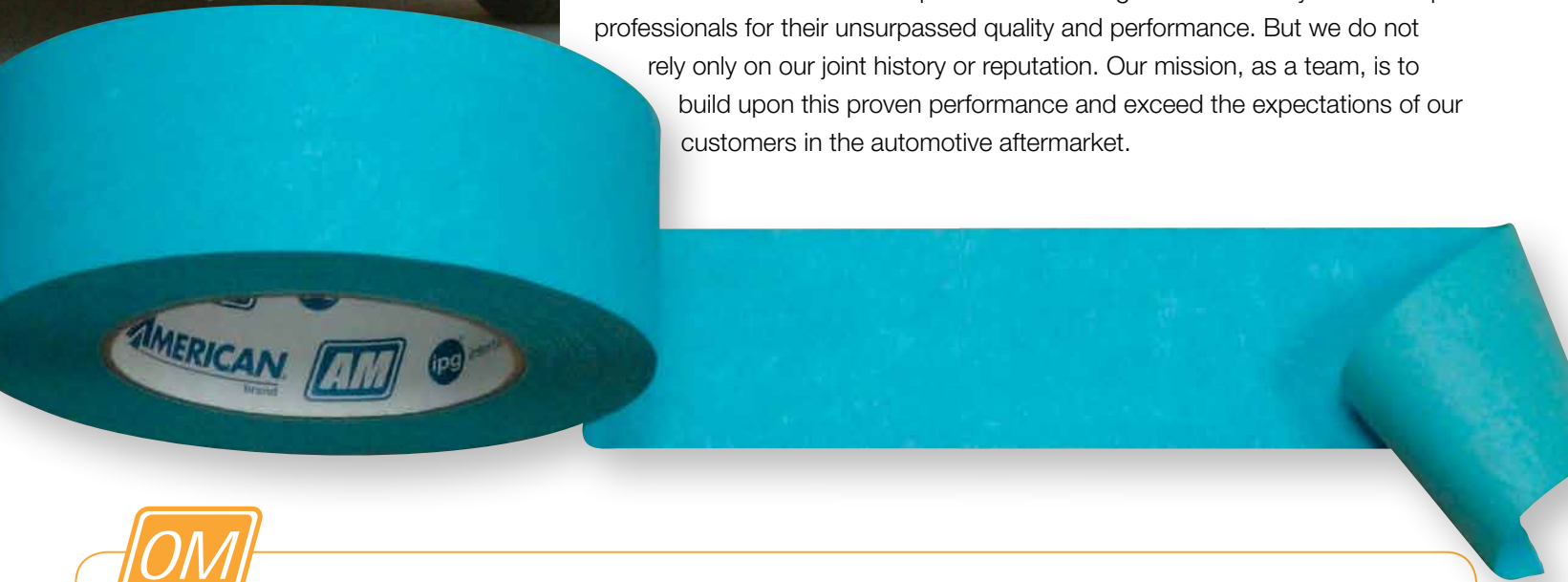

SYNONYMOUS WITH OUTSTANDING MASKING PERFORMANCE!

American® brand Orange Mask® (OM) is a high performance masking tape developed to provide superior adhesion, UV resistance and high conformability. OM unwinds and applies smoothly and removes cleanly to deliver clean crisp paint lines. The superior solution for all automotive refinishers.

PERFORMANCE ADVANTAGES

- Sharp color separation on curves or straight lines
- Exceptional cornering
- Fine crepe paper backing ensures overall sharp paint lines
- Smooth to the touch – easy to work with
- High temperature resistance: 250°F (121°C) for 30 minutes
- 3 day UV resistance
- Excellent adhesion to backing when layered
- Smooth and controlled unwind
- Works with both solvent and waterborne paints
- Clean removal; stain resistant; resists bleed-through
- Superior for wet sanding applications
- Resists paint flaking



Part #	IPG Resource	Size	Case Qty
087143-00577	ORANGE MASK 12	12mm x 54.8m (0.47in x 60yd)	72 rolls
087143-00306	OM1855	18mm x 54.8m (0.70in x 60yd)	48 rolls
087143-00307	OM2455	24mm x 54.8m (0.94in x 60yd)	36 rolls
087143-00308	OM3655	36mm x 54.8m (1.41in x 60yd)	24 rolls
087143-00309	OM4855	48mm x 54.8m (1.88in x 60yd)	24 rolls
087143-00690	OM7655	76mm x 54.8m (2.99in x 60yd)	16 rolls





PG TAKES THE CHECKERED FLAG FOR OVERALL PERFORMANCE!

American® brand PG is a high quality masking tape with good quick stick and holding properties. Designed for paint masking that requires clean and easy removal from a variety of hot or cold surfaces. The state-of-the-art performance features make it a premium tape for automotive refinishing applications.

PERFORMANCE ADVANTAGES

- Sharp color separation on curves or straight lines
- Exceptional cornering
- Fine crepe paper backing ensures overall sharp paint lines
- Smooth to the touch – easy to work with
- High temperature resistance: 250°F (121°C) for 30 minutes
- 3 day UV resistance
- Excellent adhesion to backing when layered
- Smooth and controlled unwind
- Works with both solvent and waterborne paints
- Clean removal; stain resistant; resists bleed-through
- Superior for wet sanding applications
- Resists paint flaking
- Available in narrow widths for detail applications



Part #	IPG Resource	Size	Case Qty
087143-00587	PG27..2	6mm x 54.8m (0.23in x 60yd)	36 rolls
087143-00586	PG27..41	12mm x 54.8m (0.47in x 60yd)	72 rolls
087143-00310	PG1855	18mm x 54.8m (0.70in x 60yd)	48 rolls
087143-00311	PG2455	24mm x 54.8m (0.94in x 60yd)	36 rolls
087143-00312	PG3655	36mm x 54.8m (1.41in x 60yd)	24 rolls
087143-00313	PG4855	48mm x 54.8m (1.88in x 60yd)	24 rolls
087143-00581	PG7255	72mm x 54.8m (2.83in x 60yd)	16 rolls



SEE WHY WE PUT THE AM IN AMERICAN!

American® brand AM is the cost-effective solution designed to perform in many automotive masking applications. AM's rubber-based adhesive provides adhesion to painted surfaces, bare metals and plastics, yet removes cleanly without adhesive residue, paint "flaking" from backside or surface staining.

PERFORMANCE ADVANTAGES

- Good cornering
- Temperature resistance: 225°F (107°C) for 30 minutes
- 3 day UV resistance
- Excellent adhesion to backing when layered
- Controlled unwind
- Works with both solvent and waterborne paints
- Clean removal; stain resistant; resists bleed-through
- Superior for wet sanding applications
- Resists paint flaking



Part #	IPG Resource	Size	Case Qty
087143-00314	AM1855	18mm x 54.8m (0.70in x 60yd)	48 rolls
087143-00315	AM2455	24mm x 54.8m (0.94in x 60yd)	36 rolls
087143-00316	AM3655	36mm x 54.8m (1.41in x 60yd)	24 rolls
087143-00317	AM4855	48mm x 54.8m (1.88in x 60yd)	24 rolls
087143-00580	AM7255	72mm x 54.8m (2.83in x 60yd)	16 rolls





DESIGNED WITH YOUR WALLET AND GOOD REPUTATION IN MIND.

Capable of withstanding oven temperatures up to 250°F (121°C) for one hour, MP provides higher temperature resistance versus most general purpose masking tapes. MP is also UV resistant for up to three days with clean removal. Moisture and stain resistant, its specially designed adhesive sticks firmly and securely to most surfaces and removes cleanly.

PERFORMANCE ADVANTAGES

- Good cornering
- High temperature resistance: 250°F (121°C) for one hour
- Up to 3 day UV resistance
- Excellent adhesion to backing when layered
- Controlled unwind
- Works with both solvent and waterborne paints
- Clean removal; stain resistant; resists bleed-through
- Superior for wet sanding applications
- Resists paint flaking



Part #	IPG Resource	Size	Case Qty
087143-00499	MP1855	18mm x 54.8m (0.70in x 60yd)	48 rolls
087143-00500	MP2455	24mm x 54.8m (0.94in x 60yd)	36 rolls
087143-00501	MP3655	36mm x 54.8m (1.41in x 60yd)	24 rolls
087143-00502	MP4855	48mm x 54.8m (1.88in x 60yd)	24 rolls



RELIABLE PERFORMANCE IN AN ECONOMICAL PACKAGE.

An economical, yet very reliable masking tape to meet the needs of most collision repair and refinish shops. UG offers an excellent balance of quick stick, panel adhesion and holding properties. Under normal temperature conditions, UG is the tape of choice for fast, basic service, including wet-stripping.

PERFORMANCE ADVANTAGES

- Good cornering
- Temperature resistance: 175°F (80°C) for 30 minutes
- Up to 3 day UV resistance
- Excellent adhesion to backing when layered
- Controlled unwind
- Works with both solvent and waterborne paints
- Clean removal; stain resistant; resists bleed-through
- Superior for wet sanding applications
- Resists paint flaking



Part #	IPG Resource	Size	Case Qty
077922-88400	UG1850	18mm x 50m (0.70in x 54.6yd)	48 rolls
077922-88401	UG2450	24mm x 50m (0.94in x 54.6yd)	36 rolls
077922-88402	UG3650	36mm x 50m (1.41in x 54.6yd)	24 rolls
077922-88403	UG4850	48mm x 50m (1.88in x 54.6yd)	24 rolls



519

519 MEDIUM GRADE PAPER MASKING TAPE

An economical masking tape to meet the basic needs of a collision repair shop.

PERFORMANCE ADVANTAGES

- Temperature resistance: 180°F (82°C) for 1 hour
- UV resistant up to 5 hours
- Excellent adhesion to backing when layered
- Works with both solvent and waterborne paints
- Clean removal at ambient temperature; stain resistant; resists bleed-through
- Resists paint flaking



Part #	IPG Resource	Size	Case Qty
077922-73848	73848	18mm x 54.8m (0.70in x 60yd)	48 rolls
077922-73858	73858	24mm x 54.8m (0.94in x 60yd)	36 rolls
077922-73859	73859	36mm x 54.8m (1.41in x 60yd)	24 rolls
077922-73860	73860	48mm x 54.8m (1.88in x 60yd)	24 rolls

TM27

THE PERFECT CHOICE FOR AUTO MOLDING PROTECTION!

American® brand TM27 TrimFast™ is specifically designed for flush mount and inset molding around windshields and other automotive glass. Perforated for easy cornering and eliminates the need for dangerous knives or razor blades. TM27 ensures clean removal from finished paint work without slivering, saving time and money!

PERFORMANCE ADVANTAGES

- Easy to apply and removes cleanly
- Two plastic strips for easy handling
- No release liner for faster installation and less waste
- Pre-folded edge allows ease of removal
- Two sizes in one!



Part #	IPG Resource	Size	Case Qty
077922-00268	TM27..1	50mm x 10m (1.96in x 10.9yd)	24 rolls

HAND MASK FILM

PREVENT OVERSPRAY WITH IPG's HAND MASK FILM!

IPG's Hand Mask is a pre-folded, high density polyethylene masking film designed for multiple transportation applications. The thick and durable 12 micron film is treated to resist overspray flaking during paint applications. This special film is designed with a reinforced top edge formulated to prevent the underlying film from sticking.

PERFORMANCE ADVANTAGES

- Corona-treated so paint won't flake off
- Durable film resists tearing; requires less tape
- Solvent resistant; no bleed-through
- Clings to surface, preventing overspray
- Designed to work with multiple hand dispensers
- 1" core fits most masking machines

in(mm) in the chart to the right indicates length of the material when unfolded.



Part #	IPG Resource	Size	Roll Height	Case Qty
087143-00214	HMF...24	24in x 180ft (609.6mm x 54.9m)	5.35in	12 rolls
087143-00215	HMF...36	36in x 90ft (914.4mm x 27.4m)	6.81in	12 rolls
087143-00216	HMF...48	48in x 180ft (1219.2mm x 54.9m)	8.78in	12 rolls
087143-00217	HMF...72	72in x 90ft (1828.8mm x 27.4m)	9.57in	12 rolls
087143-00218	HMF...99	99in x 90ft (2514.6mm x 27.4m)	13.0in	12 rolls

Product Physical Properties

Product	Backing	Adhesive	Total thickness (mils)	Tensile strength (lb/in of width)	Adhesion to steel (oz/in of width)	Elongation (% at break)	Temperature resistance	Color
OM	Fine crepe paper	Natural rubber/resin	7.1 (0.18mm)	23 (101 N/25mm)	27 (7.4 N/25mm)	12	250°F (121°C) 30 min	Orange
PG	Fine crepe paper	Natural rubber	7.3 (0.19mm)	26 (114 N/25mm)	28 (7.7 N/25mm)	10	250°F (121°C) 30 min	Beige
AM	Saturated crepe paper	Natural rubber/resin	6.6 (0.17mm)	20 (87.5 N/25mm)	28 (7.6 N/25mm)	12	225°F (107°C) 30 min	Aqua (blue-green)
MP	Crepe paper	Natural rubber	6.1 (0.155mm)	25 (109.5 N/25mm)	33 (9 N/25mm)	8	250°F (121°C) 1 hour	Beige
UG	Coarse crepe paper	Natural rubber	5.8 (0.15 mm)	23 (101 N/25mm)	34 (9.3 N/25mm)	14	175°F (80°C) 30 min	Beige
519	Crepe paper	Natural/synthetic rubber	6.0 (0.15mm)	23 (101 N/25mm)	36 (9.8 N/25mm)	7	180°F (82°C) 1 hour	Beige
TM27	Crepe paper/PET film	Rubber/resin	7.6 (0.19mm)	-	30 (8.2 N/25mm)	-	225°F (107°C) 1 hour	Natural





INDUSTRIAL COATINGS PRODUCT SOLUTIONS

KEY MARKET SEGMENTS

AEROSPACE | EMERGENCY VEHICLES | FARM EQUIPMENT | HEAVY TRUCK | RAILCARS | RV'S AND MOBILE HOMES





Quick-Change Rapid Strip Blaze Ceramic Discs



DESCRIPTION	TR+ DISC			DISC WITH MANDREL			TR RAPID STRIP DISC		
	4" TR+	BACK-UP PAD	RPM	4" x 1/4" HOLE	MANDREL	RPM	2" TR	3" TR	RPM
Norton Blaze	66623303921	-	8,000	66261009324	-	6,000	66623331051	-	15,000
Norton Blaze	-	-	-	-	-	-	-	66623331053	12,000
Back-Up Pad	-	63642555106	-	-	-	-	-	-	-
Mandrel with 3-1/16" x 1/4" shank	-	-	-	-	66261009502	-	-	-	-
PKG/CASE	5/1	1/1		5/20	1/1		10/10	10/10	



Surface Conditioning Premium A/O Discs

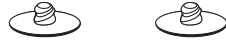

GRIT	NORTON RAPID PREP VORTEX	NORTON RAPID PREP
	2" TR	
Coarse	66623335414	66261009191
Medium	66623335427	66261009190
Fine	66623325035	66623340077
Very Fine	66623335433	66261009189
Super Fine	-	66261091459
3" TR		
Coarse	66623335417	66261009194
Medium	66623335430	66261017522
Fine	66623325038	66623340085
Very Fine	66623335437	66261009192
Super Fine	-	66261091460

2" disc case quantity = 50 discs
3" disc case quantity = 25 discs



Surface Conditioning A/O File Belts

NORTON RAPID PREP	
GRIT	
1/2" x 18"	
Coarse	66261055309
Medium	66261055310
Fine	66623333426
Very Fine	66261055311
1/2" x 24"	
Coarse	66261055312
Medium	66261008972
Fine	66254490859
Very Fine	66261019876
3/4" x 18"	
Coarse	66261002111
Medium	66261015808
Fine	66254490858
Very Fine	66261003622

1/2" wide belt case quantity = 24 belts
3/4" wide belt case quantity = 12 belts



Quick-Change Rapid Blend Vortex Premium Aluminum Oxide Discs

DESCRIPTION	NORTON RAPID BLEND VORTEX	
	2" x 1/4" x TR	3" x 1/4" x TR
3AM Lower Density	66254428237	66254428238
5AM	66254413660	66254413661
7AM Higher Density	66254433510	66254406395
CASE	60	40



Norton Bear-Tex Pads and Discs



DESCRIPTION	GRIT	SCUFF PADS		THIN-FLEX PADS		THIN-FLEX DISCS	SCUFF ROLLS	THIN-FLEX ROLLS	
		6" x 9" PERF. @ 3"	6" x 9"	4-1/2" x 9"	4-1/2" x 9"			4-1/2" x 30" PERF. @ 3" IN PLASTIC WRAP	4-1/2" x 30" PERF. @ 3" IN PLASTIC WRAP
Primer Prep Maroon	320/400	66261058000	66261074700	63642506166	66623398062	66623334770	63642503009	63642503023	77696075500
Color Prep Gray	800/1000	66261058002	66261074800	63642506167	66623398063	66623334771	63642502999	63642503021	77696075502
Clear Blend Prep Gold	1200/1500	-	66261058005*	66261113519*	-	66261113517*	-	-	-
Non-Abrasive White	-	-	66261045600	-	-	-	-	-	-
PKG./CASE		20/60	20/60	25/100	25/25	25/100	1/1	1/3	1/1

* Clear Blend Prep Gold package qty's.: Scuff pad = 10/30; Thin-Flex Pads = 10/10; Disc = 10/40



Norton A970 Non-Stearated,
Non-Pigmented Ceramic

DESCRIPTION	HOOK & LOOP DISCS		MULTI-AIR CYCLONIC HOOK & LOOP	HOOK & LOOP
	3"	3" x 7/8"	3"	5"
P400	66261127344*	66261127349*	66161101014*	66261127354*
P500	66261127345*	66261127350*	66161101015*	66261127355*
P600	66261127346*	66261127351*	66161101016*	66261127356*
P800	66261127347*	66261127352*	66161113684*	66261127357*
P1000	66261127348*	66261127353*	66161101017*	66261127358*
PKG./CASE	100/2000	100/2000	100/2000	100/500

* Non-stock. Ask your Norton representative for current lead-times.



Norton A270 Non-Stearated,
Non-Pigmented A/O

GRIT	PSA DISC ROLLS		HOOK & LOOP DISC ROLLS
	5"	6"	5"
P220B	66261127463	66261127473	—
P320B	66261127465	—	—
P400B	—	—	—
P500B	66261127467	—	66261127268
DISC PER ROLL/ROLLS PER CASE	100/4	100/4	100/4



Norton Blaze A995
No-Fil Ceramic

DESCRIPTION	MULTI-AIR CYCLONIC HOOK & LOOP DISCS		HOOK & LOOP
	5"	6"	6"
P220D	63642597504	63642597509	63642597514
P180D	63642597503	63642597508	63642597513
P150D	63642597502	63642597507	63642597512
P120D	63642597501	63642597506	63642597511
P80D	63642597500	63642597505	63642597510
PKG./CASE	50/200	50/200	50/200



Norton Dry Ice A975 No-Fil Ceramic

GRIT	HOOK & LOOP DISCS			MULTI-AIR CYCLONIC HOOK & LOOP DISCS		PSA DISC ROLLS	
	3"	5"	6"	5"	6"	5"	6"
P1000B	63642506001	—	63642506375	77696007795	77696007788	—	—
P800B	63642506000	66254480232	63642506204	77696007793	77696007787	66254480230	63642506200
P600B	63642505999	66623305616	63642506203	77696007791	77696007786	66623305608	63642506199
P500B	63642505998	66254480233	63642506202	77696007768	77696007785	66254480231	63642506198
P400B	63642505997	66261149537	66261149542	77696007765	77696007784	66261155377	66261155373
P320B	63642505996	66261149538	66261149543	77696007763	77696007781	66261155378	66261155374
P240B	63642505995	66261149540	—	77696007760	77696007777	66261155380	66261155376
P220B	63642505994	66261149541	66261149546	77696007757	77696007776	66261142474	66261148340
P180B	63642505993	66261140518	66261140528	77696007756	77696007775	66261140498	66261140508
P150B	63642505992	66261140519	66261140529	77696007755	77696007774	66261140499	66261140509
P120C	63642505991	66261140520	66261140530	77696007753	77696007773	66261140500	66261140510
P100C	—	66261140521	66261140531	—	—	66261140501	66261140511
P80C	63642505990	66261140522	66261140532	77696007745	77696007770	66261140502	66261140512
PKG./CASE	50/200	50/200	50/200	50/200	50/200	*100/4	*100/4

* Discs per roll/rolls per case = 100/4

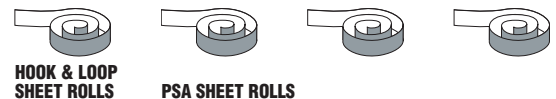

GRIT	HOOK & LOOP SHEET ROLLS	PSA SHEET ROLLS			
	2-3/4" x 13 YDS	2-3/4" x 45 YDS	2-3/4" x 30 YDS	2-3/4" x 25 YDS	
P600B	66623329548	—	—	—	
P500B	66623329547	—	—	—	
P400B	66623329518	66261149557	—	—	
P320B	63642506255	66261149558	—	—	
P220B	63642506256	66261149561	—	—	
P180B	63642506257	66261149562	—	—	
P150B	63642506258	66261149563	—	—	
P120C	63642506259	—	66261149564	—	
P80C	63642506261	—	—	66261149566	
PKG./CASE	1/4	1/5	1/5	1/5	



Norton A275 Original Performance
No-Fil Premium Aluminum Oxide



PSA DISC ROLLS

GRIT	5"	6"	5" VAC	6" VAC
P800B	66261131451	66261131468	-	-
P600B	66261131452	66261131469	-	66261131503
P500B	66261131453	66261131470	66261131487	-
P400B	66261131454	66261131471	66261131488	66261131505
P320B	66261131456	66261131473	66261131490	66261131507
P240B	66261131458	66261131475	66261131492	66261131509
P220B	66261131459	66261131476	66261131493	66261131510
P180B	66261131460	66261131477	66261131494	66261131511
P150B	66261131461	66261131478	66261131495	66261131512
P120B	66261131462	66261131479	66261131496	66261131513
P100B	66261131463	66261131480	66261131497	66261131514
P80B	66261131464	66261131481	66261131498	66261131515

DISCS PER ROLL/ROLLS PER CASE

100/6 100/6 100/6 100/6



HOOK & LOOP DISCS

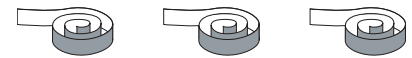

PSA SHEET ROLLS

GRIT	5"	6"	5" VAC	6" VAC	2-3/4" x 45 YDS	2-3/4" x 30 YDS	2-3/4" x 25 YDS
P1000B	66261131535	66261131552	-	66261131586	-	-	-
P800B	66261131536	66261131553	-	66261131587	-	-	-
P600B	66261131537	66261131554	66261131571	66261131588	-	-	-
P500B	66261131538	66261131555	-	-	-	-	-
P400B	66261131539	66261131556	66261131573	66261131590	66261131679	-	-
P320B	66261131541	66261131558	66261131575	66261131592	66261131681	-	-
P240B	66261131543	66261131560	66261131577	-	66261131685	-	-
P220B	66261131544	66261131561	66261131578	66261131595	66261131686	-	-
P180B	66261131545	66261131562	66261131579	66261131596	66261131687	-	-
P150B	66261131546	66261131563	66261131580	66261131597	66261131688	-	-
P120B	66261131547	66261131564	66261131581	66261131598	-	66261131689	-
P100B	66261131548	66261131565	66261131582	66261131599	-	66261131690	-
P80B	66261131549	66261131566	66261131583	66261131600	-	-	66261131691

PKG/CASE

100/4 100/4 100/4 100/4 1/5 1/5 1/5



Norton Gold Reserve A296
No-Fil Premium A/O

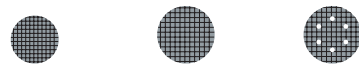

HOOK & LOOP DISCS



HOOK & LOOP BODY FILE SHEETS

GRIT	5"	6"	6" VAC	23/4" x 161/2"
P800B	66623377544	63642506226	66623334797	-
P600B	66261105390	63642506227	66623334796	-
P500B	-	63642506228	66623334795	-
P400B	66623305639	63642506229	66623334794	-
P320B	66623305638	63642506230	66623334793	-
P240B	66254457751	63642506225	66623334792	-
P220B	66623305637	63642506231	66623334791	63642506242
P180B	66623377543	63642506232	66623334790	63642506241
P150B	66623377542	63642506233	66623334789	63642506240
P120B	66623377541	63642506234	66623334788	63642506239
P100B	-	63642506235	66623334787	63642506238
P80B	66623377539	63642506236	66623334786	63642506237

PKG/CASE

*100/400 50/200 50/200 25/125



PSA DISC ROLLS

PSA SHEET ROLLS

PSA TAB DISCS

GRIT	5"	6"	23/4" x 25 YDS	6"
P800B	-	63642506164	-	-
P600B	-	66261040261	-	-
P500B	-	63642506165	-	-
P400B	66261183814	66261183823	63642506147	66261183832
P320B	66261183813	66261183822	63642506148	66261183831
P240B	66261183812	66261183821	-	66261183830
P220B	66261183811	66261183820	63642506149	66261183829
P180B	66261183810	66261183819	63642506150	66261183828
P150B	66261183809	66261183818	63642506151	66261183827
P120B	66261183808	66261183817	63642506152	66261183826
P100B	66261183807	66261183816	-	66261183825
P80B	66261183806	66261183815	63642506153	66261183824

PKG/CASE

*100/4 100/4 1/5 100/400

* Discs per roll/rolls per case = 100/4





**Norton Gold A290
No-Fil Aluminum Oxide**



PSA DISC ROLLS

GRIT	5"	6"	5" VAC	6" VAC
P60C	66261149831	66261149847	66261130266	-
P80C	66261149830	66261149842	66261130265	66261130276
P100C	66261149829	66261149841	66261130264	66261130275
P120C	66261149828	66261149840	66261130263	66261130274
P150C	66261149827	66261149839	66261130262	66261130273
P180C	66261149826	66261149838	66261130261	66261130272
P220C	66261149825	66261149837	66261130260	66261130271
P240C	66261149824	66261149836	66261130259	-
P280C	66261149823	66261149835	-	-
P320C	66261149822	66261149834	66261130258	66261130268
P400C	66261149821	66261149833	-	-
DISCS PER ROLL/ ROLLS PER CASE	100/4	100/4	100/4	100/4



HOOK & LOOP DISCS

GRIT	5"	6"	5" VAC	6" VAC
P60C	66261130224	-	66261130236	-
P80C	66261149907	66261149916	66261130235	66261130255
P100C	66261149906	66261149915	66261130234	-
P120C	66261149905	66261149914	66261130233	66261130253
P150C	66261149904	66261149913	66261130232	-
P180C	66261149903	66261149912	66261130231	66261130251
P220C	66261149902	66261149911	66261130230	66261130250
P280C	-	66261149910	-	-
P320C	66261149900	66261149909	66261130227	-
P400C	66261149899	66261149908	66261130226	-
PKG/CASE	100/400	100/400	50/200	50/200

FINE GRIT, BUFFING AND
DETAIL PRODUCTS



**Norton Q275
No-Fil A/O Film**



**Norton Pure Ice
Q175 A/O Film**

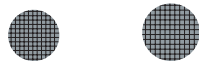

HOOK & LOOP FILM DISCS

GRIT	5"	6"
P80	66261101614	66261101628
P120	66261101613	66261101627
P150	66261101612	66261101626
P180	66261101610	66261101625
P220	66261101609	66261101624
P240	66261101608	66261101623
P320	66261101607	66261101622
P400	66261101606	66261101621
P500	-	66261101620
P600	66261101604	66261101619
P800	66261101603	66261101618
P1000	66261101602	66261101617
P1200	66261101601	66261101616
P1500	66261101600	66261101615
PKG/CASE	50/200	50/200



HOOK & LOOP FILM DISCS

GRIT	3"	5"	6"
P800	77696088701	77696088707	77696088713
P1000	77696088702	77696088708	77696088714
P1200	77696088703	77696088709	77696088715
P1500	77696088704	77696088710	77696088716
PKG/CASE	50/200	50/200	50/200



FINE GRIT, BUFFING AND DETAIL PRODUCTS



Norton Ice Q255 Aluminum Oxide Foam



HOOK & LOOP FOAM DISCS

GRIT	COLOR	3"	6"
3000	Green	63642506020	63642506013
2000	Magenta	—	63642506014
1500	Blue	63642506022	63642506015
PKG/CASE		6/24	15/50



Norton Black Ice T401 Silicon Carbide Waterproof Paper Sheets and Discs



GRIT	1-1/4"	1-1/4"	1-1/4"	3"	3"	5-1/2" x 9"	9" x 11"
1000A						66261139373	66261139381
1200A						66261139372	66261139380
1500A	63642505490*				66261142062#	66261139371	66261139379
2000A	66261123301*	66261106405+		66261106427+	66261147433	66261139370	66261139378
2500A	66261123302*		66261102285*		66261147432	66261139369	66261139377
PKG/CASE	9,000*	2,000	9,000	2,000	50/4	50/5	50/5

* Non-Stock: 500 Discs/Liner Roll; Min. Order Qty = 9,000 Discs (18 Rolls). Order per disc in multiples of 9,000 discs.
 + Non-Stock: Min. Order Qty = 2,000 Discs. Order per disc in multiples of 2,000 discs.
 # Non-Stock: Min. Order Qty = 6,300 Discs. Order per disc in multiples of 6,300 discs.
 Ask your Norton representative for current lead-times.



Norton Defect Removal Products

DESCRIPTION	PART #	PKG/CASE
Norton Liquid Ice Extra-Cut – Quart	63642597116	1/4
Norton Liquid Ice Extra-Cut – Gallon	63642506078	1/2
Norton Liquid Ice Ultra-Fine Machine Glaze – Quart	63642506092	1/4
Clean-Up/Detailer Spray – 32 oz. Spray Bottle	63642542082	1/4
Clean-Up/Detailer Spray – BlueMagnet Microfiber Cloth	63642504402	5/4
Buffing/Polishing Waffle Pads – Hook & Loop Back-Up Pad (5/8"-11)	63642542080	1/3
8" Buffing/Polishing Waffle Pads – Orange Waffle – Step 1	63642506379	1/6
8" Buffing/Polishing Waffle Pads – Blue Waffle – Step 2	63642506380	1/6
8" Buffing/Polishing Waffle Pads – White Waffle – Step 3	63642506381	1/6
Buffing/Polishing Pads – Hook & Loop Back-Up Pad (5/8"-11)	63642542080	1/3
Buffing/Polishing Pads – Super Cut Wool Pad – Step 1	63642542077	1/6
Buffing/Polishing Pads – Blue Cutting Foam Pad – Step 2	63642542078	1/6
Buffing/Polishing Pads – White Finishing Foam Pad – Step 3	63642542079	1/6
3" Buffing/Polishing Pads – Hook & Loop Back-Up Pad (5/16"-24")	63642506128	10/1
3" Buffing/Polishing Pads – Super Cut Wool Pad – Step 1	63642543832	10/4
3" Buffing/Polishing Pads – Blue Cutting Foam Pad – Step 2	63642505459	10/4
3" Buffing/Polishing Pads – White Finishing Foam Pad – Step 3	63642505460	10/4



Mothers® Detailing Products

DESCRIPTION	24 OZ./710ML	32 OZ./946ML	1 GALLON/3.785L	5 GALLON/18.925L	ACCESSORIES
Compounds					
Pro Rubbing Compound	—	07817581132	07817581138	—	—
Pro HD Rubbing Compound	—	07817581232	07817581238	—	—
Pro Machine Glaze	—	07817582332	—	—	—
Pro Finishing/Foam Pad Polish	—	07817583432	—	—	—
Pro Hand Glaze	—	07817584532	—	—	—
Pro Instant Detailer	07817585624	—	07817585638	07817585645	—
Pro Auto Wash Concentrate	—	—	07817580138	07817580145	—
Pro All-Purpose Cleaner Concentrate	—	—	07817587138	07817587145	—
Pro Water-Based Degreaser Concentrate	—	—	07817587538	07817587545	—
Pro Silicone-Free Dressing Ready-To-Use	—	—	07817588538	07817588545	—
Pro Silicone-Free Dressing Concentrate	—	—	07817588638	07817588645	—
Pro Vinyl & Rubber Dressing Ready-To-Use	—	—	07817588138	07817588145	—
Pro Glass Cleaner Concentrate	—	—	07817587638	07817587645	—
Pro Wheel Cleaner Concentrate	—	—	07817587938	07817587945	—
CASE	6	6	4	1	



DESCRIPTION	PART #	QTY.
Accessories		
Faucet For 5 Gal Container – Spigot	07817580005	6
Refillable Polish Dispenser Bottle – 12 oz.	07817580000	12
Metering System for Mothers® Pro Line – Dilutor	63642505986	1
Secondary Spray Bottle for Pro Glass Cleaner Concentrate	07817587632	12
Secondary Spray Bottle for Pro Wheel Cleaner Concentrate	07817587932	12
Secondary Spray Bottle for Pro Instant Detailer	07817585632	12
Secondary Spray Bottle for Pro All-Purpose Cleaner Concentrate	07817587132	12
Secondary Spray Bottle for Pro Water-Based Degreaser Concentrate	07817587532	12
Secondary Spray Bottle for Pro Silicone-Free Dressing Ready-To-Use	07817588532	12
Secondary Spray Bottle for Pro Silicone-Free Dressing Concentrate	07817588632	12
Secondary Spray Bottle for Pro Vinyl & Rubber Dressing	07817588132	12





Norton Blue Sheeting

DESCRIPTION	12' x 400'	16' x 350'	20' x 350'
Blue Sheeting	63642503344	63642503345	63642503723
ROLLS/CASE	1	1	1



Norton Overspray Sheeting

DESCRIPTION	12' x 400'	16' x 400'
Overspray Sheeting	63642506727	63642506728
ROLLS/CASE	1	1



Norton Paint Check Masking Paper

DESCRIPTION	6"	12"	18"	24"	36"
Masking Paper (750' boxed)	63642500402	63642500403	63642500404	63642506224**	63642500407
ROLLS/LOG	6/1	3/1	2/1	24/1	1/1

Each box (or "log") is a total of 36" – comprised of width of individual roll in inches x no. of rolls, e.g. 6" roll x 6 rolls = 36" log; 12" roll x 3 rolls = 36" log, etc., except for the 24" log. Order per number of logs.



Norton Urethane Grade White Masking Paper

DESCRIPTION	6" x 700'	12" x 700'	18" x 700'	36" x 700'
Masking Paper	63642504637	63642504638	63642504639	63642504640
ROLLS/CASE	6	3	2	1

Order by number of individual rolls in multiples of case quantities.



Norton Blue Core 14-Day And High Heat Masking Tape

DESCRIPTION	18MM (3/4")	24MM (1")	36MM (1-1/2")	48MM (2")
Blue Core 14-Day (L = 55m (60 Yard) Roll)	07660702450	07660702451	07660702452	07660702453
High Heat (L = 55m (60 Yard) Roll)	63642506183	07660721949	63642506184	63642506185
ROLLS/CASE	48	36	24	24

Order by number of individual rolls in multiples of case quantities.



Norton Fine Line Tape

DESCRIPTION	1/8"	1/4"	1/2"	3/4"
36 Yard Roll	63642572018	63642572014	63642572012	63642506174
ROLLS/CASE	12	12	12	12

Order by number of individual rolls in multiples of case quantities.



Norton Foam Masking Tape

DESCRIPTION	13MM (1/2" x 54.5 YDS)	20MM (3/4" x 54.6 YDS)
Foam Masking Tape	66254470735	–
Premium Foam Masking Tape	–	66254470746
ROLLS/CASE	1	1



Norton Attachment Tape

DESCRIPTION	1/4" x 20 YDS	1/2" x 20 YDS	7/8" x 20 YDS
Double Sided Acrylic Attachment Tape – Red Liner	63642505620	63642505621	63642505622
ROLLS/CASE	12/1	12/1	12/1

DESCRIPTION	1/2" x 108'	3/4" x 108'	7/8" x 108'	1-1/2" x 108'
Double Sided Acrylic Attachment Tape – Blue Liner	63642506045	63642506046	63642506047	66261151041
ROLLS/CASE	20/1	10/1	10/1	6/1

DESCRIPTION				4 OZ.
Adhesion Promoter – 4oz. Dauber	–	–	–	63642504670
CANS/CASE				6

Order by number of individual rolls/cans in multiples of case quantities.



Norton SoftTouch Foam Sponges

DESCRIPTION	4-1/2" x 5-1/2"
Medium	07660703074
Fine	07660703075
Super Fine	07660703076
Ultra Fine	07660703077
Micro Fine	07660703078
PKG/CASE	20/80



Norton Rotolo Foam Rolls

GRIT	4-1/2" x 82'
P320	63642557606
P400	63642557608
P500	63642557611
P600	63642557612
P800	63642557613
P1000	63642557616
PKG/CASE	1/2



Norton 6", 5", and 3" Back-Up Pads

DESCRIPTION	SOFT / 320 AND FINER		MEDIUM / 320 AND COARSER		TAPERED / 320 AND COARSER	
	PSA	HOOK & LOOP	PSA	HOOK & LOOP	PSA	HOOK & LOOP
5" Plain Face	63642506126	63642506129	63642506131	63642506135	63642506139	63642506143
6" Plain Face	63642506127	63642506130	63642506133	63642506137	63642506141	63642506145
5" Vacuum	—	—	63642506132	63642506136	63642506140	63642506144
6" Vacuum	—	—	63642506134	63642506138	63642506142	63642506146
3" Soft Low-Profile	—	63642506128	—	—	—	—
5" Norton Multi-Air	—	—	—	66623376000	—	—
6" Norton Multi-Air	—	63642560605	—	63642506160	—	—
CASE	5	5	5	5	5	5

Pads have a riveted 5/16"-24 threaded spindle and are made with polyurethane foam with a fiberglass back plate. All pads are packed 5 per case.



Norton Foam Interface Pads

DESCRIPTION	STANDARD INTERFACE PAD		NORTON MULTI-AIR INTERFACE PAD	
	3"	6"	5"	6"
1/2" thick	63642505457	63642542089	63642585864	07660719359
CASE	10/10	5/5	8/16	6/12



Norton Disc Hand Pads

DESCRIPTION	ERGONOMIC PADS	
	PART #	CASE
6" x 1/2" Thick Soft Foam Hook & Loop	63642500906	10
6" Half Moon Hook & Loop	63642500904	10
Ergonomic Hand Sanding Block for 6" PSA Discs	63642503727	5
Ergonomic Hand Sanding Block for 6" Hook & Loop Discs	63642503726	5



Norton Sanding Blocks

DESCRIPTION	2-3/4" x 5"	2-3/4" x 7-3/4"	2-3/4" x 9"	2-3/4" x 16-1/2"	PART #	CASE
Ergonomic						
Soft – PSA	63642542090	—	—	—	—	5
Firm – PSA	63642542091	—	—	—	—	5
Soft – Hook & Loop	63642542092	—	—	—	—	5
Firm – Hook & Loop	63642542093	—	—	—	—	5
Firm – PSA	—	63642542094	—	—	—	5
Firm – Hook & Loop	—	63642542095	—	—	—	5
Sanding Board – PSA	—	—	—	63642542724	—	6
Sanding Board – Hook & Loop	—	—	—	63642552836	—	5
Wet						
Dual Density Wet Sanding Block	—	—	—	—	63642503728	12
Holey Block	—	—	—	—	63642503729	8
Rubber	—	—	—	—	—	—
Hand Sanding Block	—	—	07660701889	—	—	5



F826 FIBER DISCS

The Better Choice for Super Alloys, Steels, and High-Pressure Applications

Our new NorZon BlueFire ceramic aluminum and zirconia alumina blended fiber discs grind and blend a multitude of hard-to-grind materials. With their fast cut rate and longer life over conventional zirconia products, your productivity will increase as total abrasive cost decreases.

FEATURES

- New, improved blend of patented ceramic alumina and zirconia alumina abrasive

BENEFITS

- Fast, aggressive cutting; 76% better metal removal rate than aluminum oxide and 33% better than competitive zirconia alumina fiber discs
- Self-sharpens with use



STOCK REMOVAL | WELD BLENDING | CLEANING AND FINISHING | ENERGY



TM



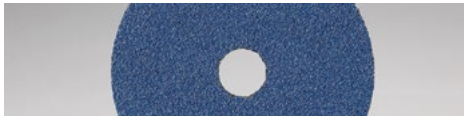

CONVENTIONAL FIBER DISCS

The most heavy-duty of coated abrasive discs with resin over resin construction on heavy-duty vulcanized fiber backing. Designed for applications ranging from heavy stock removal to surface blending. Used with back-up pads on portable angle grinders.

PART #	GRIT	STD. PKG.
4-1/2" X 7/8"		
662611 38457	24	25
662611 38456	36	25
662611 38454	50	25
662611 38453	60	25
662611 38452	80	25
5" X 7/8"		
662611 38563	24	25
662611 38562	36	25
662611 38561	50	25
662611 38601	60	25
662611 38600	80	25
7" X 7/8"		
662611 38594	24	25
662611 38593	36	25
662611 38592	50	25
662611 38591	60	25
662611 38590	80	25
9-1/8" X 7/8"		
662611 38584	24	25
662611 38583	36	25
662611 38582	50	25

Fiber Discs Must Always Be Used With Back-Up Pads – see below



SPEED-CHANGE DISC

These fiber discs feature Norton quick, tool-free, twist-on and off Speed-Change fasteners. Discs lock to standard back-up pads with a unique nut design and are easily removed, increasing your productivity.

PART #	GRIT	STD. PKG.
5" X 5/8-11" SPEED-CHANGE		
662611 38797	24	25
662611 38796	36	25
7" X 5/8-11" SPEED-CHANGE		
662611 38819	24	25
662611 38818	36	25
662611 38817	50	25
662611 38816	60	25

Speed-Change Fiber Discs Must Always Be Used With Back-Up Pads – see below

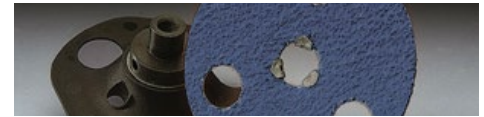

AVOS DISC

Patented, see-through design allows interrupted cut which reduces heat up to 30% over standard discs. Scooped holes create air flow to pull swarf away from grinding zone; cool cutting and extended product life. 5° back-up pad for full utilization of discs – no gouging. Quick, tool-free, twist-on and off Speed-Lok fasteners.

PART #	GRIT	STD. PKG.
4-1/2" SPEED-LOK (3 HOLE)		
662611 29718	24	10
662611 29719	36	10
662611 29720	50	10
662611 29721	60	10
662611 29722	80	10
5" SPEED-LOK (3 HOLE)		
662611 26556	24	10
662611 26557	36	10
662611 26558	50	10
662611 26559	60	10
662611 26560	80	10
7" SPEED-LOK (6 HOLE)		
662611 37454	24	10
662611 37455	36	10
662611 37456	50	10
662611 37457	60	10
662611 37458	80	10

AVOS Fiber Discs Must be used with Avos back-up pads – see below

BACK-UP PADS

PART #	DESCRIPTION	MAX. RPM	STD. PKG.
SMOOTH FACE			
662544 92277	4-1/2" Medium	20,000	5
636425 43235	5" Medium	12,000	5
636425 43245	7" Medium	8,600	5
636425 43270	9" Medium	7,000	5
AIR COOLED STANDARD			
636425 02122	4-1/2" Medium	11,000	5
636425 43421	5" Medium	10,000	5
636425 43422	7" Medium	8,600	5
636425 43423	9" Medium	6,600	5
TOOLS			
636425 43463	#103 Retainer Nut	–	10
636425 43461	66NS Short Retainer Nut	–	10
636425 43005	Spanner Wrench	–	5

Retainer nuts are not included with back-up pads. These must be ordered separately.

AVOS BACK-UP PADS

PART #	DESCRIPTION	MAX. RPM	STD. PKG.
AVOS TRIANGULAR SPEED-LOK BACK-UP PADS			
636425 02985	4-1/2" x 5/8-11	13,000	5
636425 03029	5" x 3/8-24 Pistol Grip*	20,000	5
636425 02517	5" x 5/8-11	13,000	5
636425 03030	5" x 7/16-20 Pistol Grip*	20,000	5
AVOS ROUND SPEED-LOK BACK-UP PADS			
636425 04873	7" x 5/8-11 Hard	8,600	5
636425 04874	7" x 5/8-11 Medium	8,600	5

*Use on air pneumatic and high-speed pistol grip sanders

BETTER

Excellent Blend of Performance and Price





MASKING

BEST PRACTICE

Moldings and Trim

Use trim tape to lift moldings off of the vehicle surface to allow paint coverage under the molding and eliminate a hard paint line. American brand TrimFast tape is perforated for easy tearing. Works well on sidelights, back glass moldings and flush mount windshields.

Objective: Allow paint coverage under the moldings and eliminate hard paint edges around moldings and trim.



Protect Jamb and Body Apertures

Use premium foam masking tape to protect jambs and apertures from overspray and to produce a soft paint edge. Use foam tape instead of masking tape and paper to increase productivity and to save on material costs. Premium foam masking tape can be applied to fixed or moving parts and the offset adhesive should be applied to the inside of the panel. Close the panel then smooth the tape to the desired depth.

Objective: Prevent paint overspray from penetrating jambs, hood and trunk gutters etc. and to produce a soft paint edge.



Windows

Use masking tape and paper to cover windows, lights and trim within the spray area. Use fine line tape first if you have difficult contours to mask.

Objective: Prevent paint overspray on the glass, lights and trim.



Outline with "Paint Check"

To provide optimal conditions in the paint booth, outline the spray area with white Norton "Paint Check" paper.

Objective: Using the white "Paint Check" paper will not distort the light that reflects into the paint match area, as can happen with colored paper. The coverage test "Paint Check" logo helps to gauge paint coverage when needed.



Outline the Spray Area and Cover the Vehicle

Outline the spray area with 1-1/2" masking tape then cover the entire vehicle with plastic sheeting and cut out the area to be sprayed. Attach the plastic along the cut edge to the tape outline using 3/4" or 1-1/2" masking tape.

Objective: Protect panels that are not being painted from overspray.



Final Check

Double check that all exposed areas are covered. It is recommended to cover any exposed wheels with Blue Wrap paintable plastic wheel maskers.

Tip: To keep the paint area cleaner and to save time and money in the detail department, reverse mask wheel wells with 18" masking paper. This will keep the dirt behind the wheel and out of your paint jobs.

Objective: Prevent costly re-work.



MASKING PRODUCTS

SIZE	PART #
AMERICAN BRAND TM27 TRIMFAST	
50mm x 10m (1.96' x 10.94 yds.)	077922-00268
BLUE FINE LINE MASKING TAPE	
1/8" x 36 yds.	636425-72018
1/4" x 36 yds.	636425-72014
1/2" x 36 yds.	636425-72012
3/4" x 36 yds.	636425-06174
PREMIUM FOAM MASKING TAPE	
20mm x 50m (3/4" x 54.6 yds.)	662544-70746
FOAM MASKING TAPE	
13mm x 50m (1/2" x 54.6 yds.)	662544-70735
AMERICAN BRAND PG MASKING TAPE	
18mm x 54.8m	087143-00310
24mm x 54.8m	087143-00311
36mm x 54.8m	087143-00312
48mm x 54.8m	087143-00313
AMERICAN BRAND AM MASKING TAPE	
18mm x 54.8m	087143-00314
24mm x 54.8m	087143-00315
36mm x 54.8m	087143-00316
48mm x 54.8m	087143-00317
BLUE SHEETING™ TRI-LAYER PAINTABLE PLASTIC	
12' x 400'	636425-03344
16' x 350'	636425-03345
20' x 350'	636425-03723
OVERSPRAY PROTECTIVE SHEETING	
12' x 400'	636425-06727
16' x 400'	636425-06728
ANCHOR® BRAND HAND MASK FILM	
24" x 180"	087143-00214
48" x 180"	087143-00216
72" x 90"	087143-00217
99" x 90"	087143-00218
MOBILE MASKEE	
4 tier-2 up to 12', 2 up to 18"	662610-89208
WHITE "PAINT CHECK" MASKING PAPER	
6" x 750'	636425-00402
12" x 750'	636425-00403
18" x 750'	636425-00404
24" x 750'	636425-06224
36" x 750'	636425-00407
BLUE WRAP™ PROTECTIVE PLASTIC	
Wheel Maskers-Fits up to 17"	636425-05922



EFFECTIVE 2013

PROFESSIONAL
DIAMOND BLADE
STOCK OFFERING

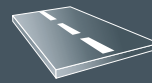

Asphalt and Abrasive Materials

Asphalt, green concrete, asphalt over concrete, abrasive blocks, mortar and other abrasive materials.



ASPHALT AND ASPHALT OVER CONCRETE DIAMOND BLADES

Asphalt cutting is highly damaging to diamond blades, which translates to high costs for contractors. The Norton Charger and Norton Classic professional range of asphalt and asphalt over concrete blades is engineered with blade life in mind; hardness in cores, undercut protection, wide gullet for slurry removal and specifications to meet any aggregate. Choose from our stock program for faster service.

UPC	SIZE	AGGREGATE	HORSEPOWER
Charger Asphalt Diamond Blades			
701846 81478 RDS	14" x .125" x 1"	Medium	13 - 35
701846 81479 RDS	18" x .125" x 1"	Medium	13 - 35
701846 83927 RDS	24" x .175" x 1"	Medium	13 - 35
701846 83928 RDS	26" x .155" x 1"	Medium	35 - 48
701846 83929 RDS	30" x .175" x 1"	Medium	35 - 48
701846 84024 RDS	36" x .187" x 1"	Medium	35 - 48
Classic Asphalt Diamond Blades			
701846 81374 INS	14" x .110" x 1"	Medium	13 - 35
701846 81375 RDS	14" x .125" x 1"	Medium	13 - 35
701846 83895 RDS	16" x .125" x 1"	Medium	13 - 35
701846 81376 RDS	18" x .125" x 1"	Medium	13 - 35
701846 83897 RDS	20" x .125" x 1"	Medium	13 - 35
701846 81476 RDS	24" x .155" x 1"	Medium	13 - 35
701846 83899 RDS	26" x .155" x 1"	Medium	13 - 35
Charger Asphalt Over Concrete Diamond Blades			
701846 81486 RDS	18" x .125" x 1"	Medium	13 - 35
701846 81487 RDS	24" x .155" x 1"	Medium	13 - 35
701846 83396 RDS	30" x .187" x 1"	Medium	35 - 48
701846 83397 RDS	36" x .187" x 1"	Medium	35 - 48

RDS = Radius Drop Segments INS = Inserts

- FAST SERVICE
- QUALITY PERFORMANCE
- GREAT VALUE

ALL THE MUSCLE YOU NEED™

UNDERCUTTING PROTECTION

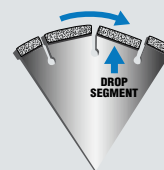

(RDS) Radius Drop Segment

Radius Drop Segments (RDS) protect each blade from damaging effects of undercutting.



Inserts

(S) = Inserts on every fourth landing.
(H) = Inserts on every other landing.



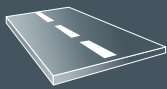

Asphalt and Abrasive Materials

Asphalt, green concrete, asphalt over concrete, abrasive blocks, mortar and other abrasive materials.



Reinforced Concrete and Harder Building Materials

Reinforced concrete, hard bricks, limestone, terrazzo and other hard materials.



GREEN/ EARLY ENTRY DIAMOND BLADES

Green cutting is harsh on the performance of a diamond blade and warrants the highest of quality. Choose from the popular Norton Paradigm or Charger series with specification grades to meet the demands of any aggregate mixture. Or if a special arbor is needed for your early entry machine then the GMAX series has you covered. All the right sizes along with the specification to get you on and off the concrete.

UPC	SIZE	AGGREGATE	HORSEPOWER
Paradigm Green Concrete Diamond Blades			
701846 43592 RDS	14" x .145" x 1"	Hard	35 +
701846 44152 RDS	14" x .190" x 1"	Medium	35 +
701846 44154 RDS	14" x .250" x 1"	Hard	35 +
701846 44153 RDS	14" x .250" x 1"	Medium	35 +
701846 91929 RDS	16" x .145" x 1"	Hard	35 +
Charger Green Concrete Diamond Blades			
701846 81475 RDS	18" x .125" x 1"	Medium	13 - 35
GMAX Green Concrete Diamond Blades			
701846 41866	6" x .110" x *	Soft	4.3
701846 41867	6" x .110" x *	Medium	4.3
701846 41868	6" x .110" x *	Hard	4.3
701846 41863	8" x .110" x *	Hard	6
701846 41864	8" x .110" x *	Medium	6
701846 41860	10" x .110" x *	Hard	13
701846 41861	10" x .110" x *	Medium	13
701846 41862	10" x .110" x *	Soft	13
701846 41869	14" x .125" x *	Hard	23
701846 41870	14" x .125" x *	Medium	23
701846 41871	14" x .125" x *	Soft	23
701846 83758	8" x .110" x 1"	Medium	6
701846 75125	9" x .110" x 1"	Medium	6
701846 84508	10" x .110" x 1"	Medium	6

RDS = Radius Drop Segments * special knock-out arbor

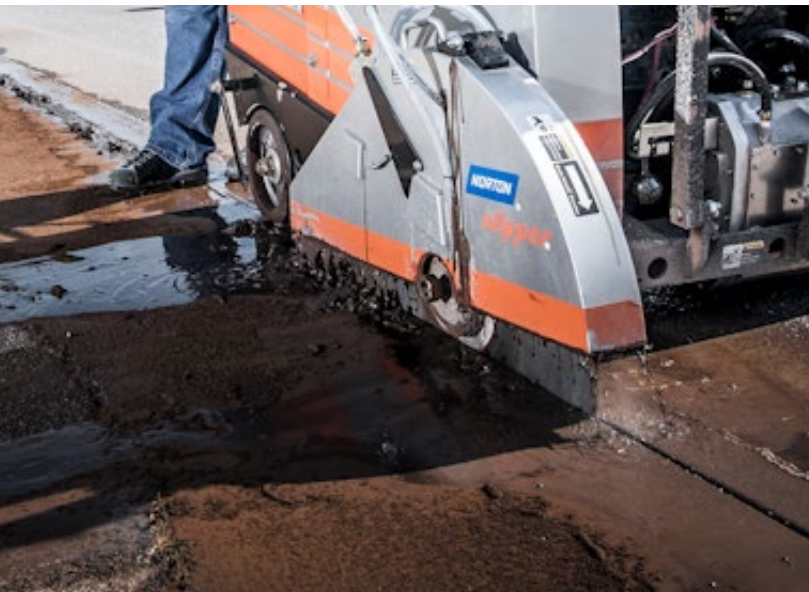

NORTON VMAX WALL SAW DIAMOND BLADES

The Norton VMAX wall saw blades offer a unique, multi-sandwich, laser-welded segment technology for maximum performance in both fast cut and life.

UPC	SIZE	AGGREGATE	HORSEPOWER
VMAX Plus Wall Saw Diamond Blades			
701846 92149	24" x .187" x *	Multi Purpose	All
701846 92405	24" x .210" x *	Multi Purpose	All
VMAX Wall Saw Diamond Blades			
701846 92493	20" x .235" x *	Multi Purpose	All
701846 90911	24" x .187" x *	Multi Purpose	All
701846 90924	24" x .210" x *	Multi Purpose	All
701846 91031	24" x .235" x *	Multi Purpose	All
701846 90927	26" x .235" x *	Multi Purpose	All
701846 90947	30" x .187" x *	Multi Purpose	All
701846 90926	30" x .210" x *	Multi Purpose	All
701846 91013	30" x .235" x *	Multi Purpose	All
701846 91388	32" x .187" x *	Multi Purpose	All
701846 91305	32" x .20" x *	Multi Purpose	All
701846 91050	36" x .235" x *	Multi Purpose	All
701846 91038	42" x .187" x *	Multi Purpose	All
701846 91039	42" x .210" x *	Multi Purpose	All

* VMAX & VMAX PLUS have A34 Arbor



Reinforced Concrete and Harder Building Materials



NORTON CHARGER MASONRY SAW DIAMOND BLADES

The Norton Charger and Norton Classic wall saw blades offer exception price performance to ensure a fast clean cut.

UPC	SIZE	MTL/APPLICATION
Charger Masonry Diamond Blades		
701846 81348	14" x .095" x 1"	Refractory/Hard
701846 81330	14" x .100" x 1"	Masonry/Block
701846 81338	14" x .100" x 1"	Masonry/Combo
701846 81426	18" x .125" x 1"	Masonry/Brick
701846 81456	20" x .125" x 1"	Refractory/Hard
701846 81457	20" x .125" x 1"	Refractory/Hard
701846 81427	20" x .125" x 1"	Masonry/Brick
701846 81429	20" x .125" x 1"	Masonry/GP
701846 84509	21" x .125" x 1"	Masonry Materials
Classic Masonry Saw Diamond Blades		
701846 81331	14" x .100" x 1"	Masonry/Combo
701846 81453	14" x .100" x 1"	Refractory/GP
701846 81454	18" x .125" x 1"	Refractory/GP
701846 81332	20" x .125" x 1"	Masonry/Combo
701846 81455	20" x .125" x 1"	Refractory/Combo
701846 84251	20" x .165" x 1"	Masonry/Refractory



Reinforced Concrete and Harder Building Materials

Reinforced concrete, hard bricks, limestone, terrazzo and other hard materials.



Reinforced Concrete and Harder Building Materials

Reinforced concrete, hard bricks, limestone, terrazzo and other hard materials.



NORTON PARADIGM CURED CONCRETE DIAMOND BLADES

Professional grade cured concrete blades do not get any better than the Norton Paradigm series. The new segment technology increases life as much as 20% while providing a larger operating window in regards to the aggregate type. That translates into less amount of blade designs needed to do the job. Standard Radius Drop Segments provide additional protection to keep the job moving. A full range of sizes and segment widths covers the saw needs while the Norton Paradigm technology reduces your inventory and helps you complete the job on time with less cost.

UPC	SIZE	AGGREGATE	HORSEPOWER
Paradigm Cured Concrete Diamond Blades			
701846 46313 RDS	14" x .125" x 1"	Soft	35 - 48
701846 46314 RDS	16" x .125" x 1"	Soft	35 - 48
701846 46389	16" x .125" x 1"	Medium	48 +
701846 46319 RDS	18" x .125" x 1"	Soft	35 - 48
701846 46410	18" x .155" x 1"	Hard	48 +
701846 46376	20" x .155" x 1"	Soft	48 +
701846 46394	20" x .155" x 1"	Medium	48 +
701846 46395 RDS	24" x .155" x 1"	Medium	48 +
701846 46325 RDS	26" x .155" x 1"	Soft	35 - 48
701846 46397 RDS	26" x .155" x 1"	Medium	35 - 48
701846 46326 RDS	26" x .165" x 1"	Soft	35 - 48
701846 46398 RDS	26" x .165" x 1"	Medium	48 +
701846 46384 RDS	36" x .187" x 1"	Soft	48 +
701846 46388	14" x .125" x 1"	Medium	48 +
701846 46424	14" x .125" x 1"	Hard	48 +
701846 46337	18" x .125" x 1"	Medium	35 - 48
701846 46374	18" x .155" x 1"	Soft	48 +
701846 46392	18" x .155" x 1"	Medium	48 +
701846 46430	20" x .155" x 1"	Hard	48 +
701846 46323 RDS	24" x .155" x 1"	Soft	35 - 48
701846 47288	24" x .175" x 1"	Medium	35 - 48
701846 46361 RDS	26" x .155" x 1"	Hard	35 - 48
701846 46382 RDS	30" x .165" x 1"	Soft	48 +
701846 46400 RDS	30" x .165" x 1"	Medium	48 +
701846 46912 RDS	30" x .165" x 1"	Hard	66 +
701846 47390 RDS	30" x .175" x 1"	Medium	48 +
701846 46402 RDS	36" x .187" x 1"	Medium	48 +
701846 46420 RDS	36" x .187" x 1"	Hard	48 +
701846 46475 RDS	42" x .190" x 1"	Medium	66 +
701846 46386 RDS	48" x .190" x 1"	Medium	48 +

RDS = Radius Drop Segments

CURED CONCRETE DIAMOND BLADES

Norton Charger and Classic professional grade cured concrete blades are among the finest in the industry. With specifications for material ranging from soft to hard as well as meeting saws of all horsepower ranges. Charger for high performance at a good price and wide range of sizes, or try the Norton Classic where price matters to get the job done. Both quality cured blade series with high performance in reinforced cured concrete.

UPC	SIZE	AGGREGATE	HORSEPOWER
Charger Cured Concrete Diamond Blades			
701846 81363	14" x .110" x 1"	Hard	13 - 35
701846 81366	14" x .125" x 1"	Medium	13 - 35
701846 81365	14" x .125" x 1"	Hard	13 - 35
701846 81368	18" x .125" x 1"	Medium	13 - 35
701846 81367	18" x .125" x 1"	Hard	13 - 35
701846 83965	20" x .125" x 1"	Medium	13 - 35
701846 83918	20" x .125" x 1"	Hard	13 - 35
701846 81467	24" x .155" x 1"	Hard	13 - 35
701846 83919	24" x .175" x 1"	Hard	13 - 35
701846 81472	26" x .155" x 1"	Medium	13 - 35
701846 81471	26" x .155" x 1"	Hard	13 - 35
701846 83920	30" x .175" x 1"	Hard	13 - 35
701846 83969	36" x .187" x 1"	Medium	35 - 48
701846 83921	36" x .187" x 1"	Hard	35 - 48
Classic Cured Concrete Diamond Blades			
701846 81359	14" x .125" x 1"	Medium	13 - 35
701846 81360	16" x .125" x 1"	Medium	13 - 35
701846 81361	18" x .125" x 1"	Medium	13 - 35
701846 81362	20" x .125" x 1"	Medium	13 - 35
701846 81465	24" x .155" x 1"	Medium	13 - 35
701846 83833	26" x .155" x 1"	Medium	13 - 35
701846 83386	30" x .175" x 1"	Medium	13 - 35

ALL THE **MUSCLE** YOU NEED™



ALL THE **MUSCLE** YOU NEED™



COMPOSITE MARKET REFINISHING PRODUCTS

FORM #8271 REV. 08/19

© Saint-Gobain August 2019.

Norton, Bear-Tex, Black Ice, Blaze, BlueFire, Blue Sheeting, Dry Ice, Durite, Multi-Air Cyclonic, MeshPower, No-Fil, and SoftTouch are registered trademarks, and Extra-Cut, and Liquid Ice are trademarks of Saint-Gobain Abrasives.



Fiber Discs

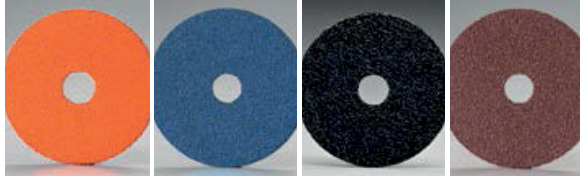

		BEST BLAZE F980 CERAMIC	BETTER BLUEFIRE F826P Z/A	GOOD GEMINI F726 A/O	GOOD METAL F240 A/O
SIZE	GRIT	699573	666233	66233	66233
5"	60	98008	55601	95019	57279
SIZE	GRIT		662611		
5"	50	98007	38561	95018	57278
5"	36	98006	38562	95017	57277
5"	24	98005	38563	95016	57276
7"	60	98013	38591	95032	57286
7"	50	98012	38592	95031	57285
7"	36	98011	38593	95030	57284
7"	24	98010	38594	95029	57283
PKG		25	25	10	25

PSA Paper Rolls



	BEST 2-3/4" PSA ROLL A975 CERAMIC B-WEIGHT	BETTER 2-3/4" PSA ROLL A275 A/O B-WEIGHT	GOOD 2-3/4" PSA ROLL A296 A/O C-WEIGHT	BETTER 2-3/4" PSA A475 S/C C-WEIGHT
GRIT	662611	662611	636425	666233
P800	—	—	—	15256 <i>NS</i>
P600	—	31679	—	15257 <i>NS</i>
P400	49557	31681	06147	15258 <i>NS</i>
P320	49558	31683	06148	06887 <i>NS</i>
P240	—	—	—	06885 <i>NS</i>
P220	49561	31686	06149	06884 <i>NS</i>
P180	49562	31687	06150	15240 <i>NS</i>
P150	49563 <i>NS</i>	31688	06151	—
P120	49564	31689	06152	06883 <i>NS</i>
P100	49565 <i>NS</i>	31690	—	06882 <i>NS</i>
P80	49566	31691	06153	06881 <i>NS</i>
PKG/CS	1/5	1/5	1/5	30 <i>MOQ</i>

NS = Non-Stock Item

A975: 120, 100, & 80 grits are C-Wt

Cloth Quick-Change TR Discs



	BEST 2" BLAZE CERAMIC	BEST 3" BLAZE CERAMIC	BETTER 2" BLUEFIRE Z/A	BETTER 3" BLUEFIRE Z/A
GRIT	662611	662611	662611	662611
80	62324	62334	21049	21054
60	62322	62332	21048	21053
50	62320	62330	38670	38673
36	62318	62328	38671	38674
24	—	—	38672	38675
PKG	25	25	25	25

Fine Finishing Hook & Loop Foam Discs



FOAM DISC	BETTER 3" ICE Q255 A/O	BETTER 6" ICE Q255 A/O	PKG
GRIT/DESCRIPTION	636425	636425	
P3000	06020	06013	6/24
P2000	06021 <i>NS</i>	06014	6/24
P1500	06022	06015	6/24

Paper Sheets



	BEST 5-1/2" x 9" T401 S/C	BEST 9" x 11" T401 S/C	BETTER 9" x 11" T414 S/C	BETTER 9" x 11" A475 S/C
GRIT	662611	662611		776960
P2500	39369	39377	—	—
P2000	39370	39378	—	—
P1500	39371	39379	—	—
P1200	39372	39380	—	—
P1000	39373	39381	—	84697
	T214 A/O	T214 A/O	T414 S/C	A475 S/C
GRIT	662611	662611	662611	662544
P800	39374	39382	—	—
P600	39375	39383	39360	96120
P500	—	39384	39361	—
P400	—	39385	39362	96119
P360	—	—	39363	—
P320	—	39386	39364	87400
P280	—	—	39365	—
P240	—	39388	39366	87399
P220	—	39389	39367	87398
P180	—	—	—	87397
P150	—	—	—	87396
P120	—	—	—	87395
P100	—	—	—	87394
P80	—	—	—	87393*
PKG/CS	50/250	50/250	50/250	100/500

T214 and A475 are P-graded. All paper sheets are B-Wt.

** A475 Min./Std. Pkg. 80 Grit = 50/250*

Non-Woven Bear-Tex Hand Pads and Discs



6" x 9" NON-PERFORATED HAND PADS

DESCRIPTION	662610	PKG
Gray – Final Shine S/C Micro Fine	74800	20/80
Maroon – GP Plus A/O Very Fine	74700	20/80

6" x 9" PERFORATED HAND PADS

	662610	4-1/2" x 9" THIN-FLEX PADS	6" THIN-FLEX DISCS
Maroon-GP Plus A/O Very Fine	84700	—	—
Gray-Color Prep	58002	06167	34771
Maroon-Primer Prep	58000	06166	34770
PKG/CS	20/60	25/100	25/100

SoftTouch Sanding Sponges Coated One Side



4-1/2" x 5-1/2" x 3/16"

GRIT	076607	PKG
60 Medium	03074	80
100 Fine	03075	80
180 Super Fine	03076	80
220 Ultra Fine	03077	80
280 Micro Fine	03078	80

Liquid Ice Polishing System



Non-Woven Surface Finishing TR Discs



	BEST 2" VORTEX	BEST 3" VORTEX
GRIT	662544	662544
Medium	25632	13661
PKG	60	40

	BEST 2" VORTEX	BEST 3" VORTEX	BETTER 2" A/O	BETTER 3" A/O
GRIT	666233	666233	662610	662610
Extra Coarse	35326	36327	16373	16994
Coarse	35414	35417	09191	09194
Medium	35427	35430	09190	17522
Very Fine	35433	35437	09189	09192
Super Fine	—	—	91459	91460
PKG	50	25	50	25

	BEST 2" BLAZE CERAMIC	BEST 3" BLAZE CERAMIC	BETTER 2" SILICON CARBIDE	BETTER 3" SILICON CARBIDE
GRIT	666233	66261	662610	662610
Extra Coarse	03912	096557	13402	13403
PKG	10	10	10	10

	636425	PKG
Extra Cut Quart	97116	4
Extra Cut Gallon	06078	2
Machine Glaze Quart	06092	4
8" NorGrip Backup Pad	42080	3
8" Wool Pad - Step 1	42077	6
8" Blue Foam Pad - Step 2	42078	6
8" White Foam Pad - Step 3	42079	6
8" Waffle Orange Foam - Step 1	06379	6
8" Waffle Blue Foam - Step 2	06380	6
8" Waffle White Foam - Step 3	06381	6
3" NorGrip Backup Pad	06128	10
3" Wool Pad - Step 1	43832	10/40
3" Blue Foam Pad - Step 2	05459	10/40
3" White Foam Pad - Step 3	05460	10/40
Clean Up Detailer 32 oz.	42082	4
Micro-Fiber Cloth	04402	5/20

Electroplated Diamond Products



GRIT	SIZE		PKG
DIAMOND SLOTTED BLADES			
40	3" x 3/32" x 1/4"	662603	1
40	4" x 3/32" x 1/2"	95559	1
40	4" x 3/32" x 3/4"	00360	1
DIAMOND CONTINUOUS RIM SLICER BLADE			
40	4-1/2" x .040" x 7/8"	84528	1
40	5" x .040" x 7/8"	84529	1
40	7" x .060" x 7/8"	84530	1
DIAMOND NON-FLUTED ROUTERS			
40	1/4" x 1" Diamond 1/4" Shank; 2-1/2" Overall	662603	1

Mounted Points, Hole Saws, and MSL Blades are also available in a variety of sizes.

Blaze A995 Multi-Air Cyclonic Ceramic Paper Vacuum Discs



GRIT	BEST		PKG/CS
	5" DISCS	6" DISCS	
	636425	636425	
P220	97504	97509	50/4
P180	97503	97508	50/4
P150	97502	97507	50/4
P120	97501	97506	50/4
P80	97500	97505	50/4

Dry Ice A975 Multi-Air Cyclonic Vacuum No-Fil Paper Discs



GRIT	BEST		PKG/CS
	5" DISCS	6" DISCS	
	776960	776960	
P1000B	07795	07788	50/4
P800B	07793	07787	50/4
P600B	07791	07786	50/4
P500B	07768	07785	50/4
P400B	07765	07784	50/4
P320B	07763	07781	50/4
P280B	07762	07778	50/4
P240B	07760	07777	50/4
P220B	07757	07776	50/4
P180B	07756	07775	50/4
P150B	07755	07774	50/4
P120C	07753	07773	50/4
P80C	07745	07770	50/4

A275 Multi-Air Cyclonic Vacuum No-Fil Paper Discs



GRIT	BETTER		PKG/CS
	6" DISCS		
	666233		
P1000B	90514		100/4
P800B	90513		100/4
P600B	90512		100/4
P500B	90511		100/4
P400B	90510		100/4
P320B	90509		100/4
P240B	90508		100/4
P220B	90507		100/4
P180B	90506		100/4
P150B	90505		100/4
P120C	90504		100/4
P80C	90503		100/4

Dry Ice A975 Ceramic No-Fil Paper Discs



GRIT	BEST		PKG/CS
	5" PSA DISC ROLL	5" HOOK & LOOP	
	666233	666233	
P1500B	—	73555 <i>NS</i>	—
P1200B	—	73554 <i>NS</i>	—
P1000B	—	85023 <i>NS</i>	—
P600B	05608	05616	—
	662544	662544	
P800B	80230	80232	—
P500B	80231 <i>NS</i>	80233	—
	662611	662611	662611
P400B	55377	49537	49547 <i>NS</i>
P320B	55378	49538	49548 <i>NS</i>
P280B	55379	49539 <i>NS</i>	49549 <i>NS</i>
P240B	55380	49540	49550 <i>NS</i>
P220B	42474	49541	49551 <i>NS</i>
P180B	40498	40518	40513 <i>NS</i>
P150B	40499	40519	40514 <i>NS</i>
P120C	40500	40520	40515
P100C	40501	40521	40516 <i>NS</i>
P80C	40502	40522	40517
PKG/CS	1/4 100 Discs/Roll	50/4	50/4

GRIT	BEST		PKG/CS
	6" PSA DISC ROLL	6" HOOK & LOOP	
	636425	636425	
P1500B	—	06377	—
P1200B	—	06376	—
P1000B	—	06375	—
P800B	06200	06204	—
P600B	06199	06203	—
P500B	06198	06202	—
	662611	662611	662611
P400B	55373	49542	49552 <i>NS</i>
P320B	55374	49543	49553 <i>NS</i>
P280B	55375	49544	49554 <i>NS</i>
P240B	55376	49545	49555 <i>NS</i>
P220B	48340	49546	49556 <i>NS</i>
P180B	40508	40528	40523 <i>NS</i>
P150B	40509	40529	40524
P120C	40510	40530	40525 <i>NS</i>
P100C	40511	40531	40526 <i>NS</i>
P80C	40512	40532	40527
P60C	—	—	—
PKG/CS	1/4 — 100 Discs/Roll	50/4	50/4

Order by Number of Packs
NS = Non-Stock Item

A275 Aluminum Oxide No-Fil Paper Discs



Durite A475 Silicon Carbide No-Fil Paper Discs



	BETTER 5" PSA DISC ROLL	BETTER 5" PSA VAC DISC ROLL	BETTER 5" HOOK & LOOP	BETTER 5" VACUUM HOOK & LOOP
GRIT	662611	662611	662611	662611
P1500B	31448 <i>NS</i>	–	31533	31567 <i>NS</i>
P1200B	31449	–	31534	31568 <i>NS</i>
P1000B	31450	–	31535	31569 <i>NS</i>
P800B	31451	31485 <i>NS</i>	31536	31570 <i>NS</i>
P600B	31452	31486 <i>NS</i>	31537	31571
P500B	31453	31487	31538	31572 <i>NS</i>
P400B	31454	31488	31539	31573
P320B	31456	31490	31541	31575
P280B	31457	31491 <i>NS</i>	31542	31576 <i>NS</i>
P240B	31458	31492	31543	31577
P220B	31459	31493	31544	31578
P180B	31460	31494	31545	31579
P150B	31461	31495	31546	31580
P120B	31462	31496	31547	31581
P100B	31463	31497	31548	31582
P80B	31464	31498	31549	31583
PKG/CS	1/6 100 Discs/Roll	1/6 100 Discs/Roll	100/4	100/4

	BETTER 6" PSA DISC ROLL	BETTER 6" PSA VACUUM DISC ROLL	BETTER 6" HOOK & LOOP	BETTER 6" VACUUM HOOK & LOOP
GRIT	662611	662611	662611	662611
P1500B	31465	–	31550	31584
P1200B	31466	–	31551	31585
P1000B	31467	–	31552	31586
P800B	31468	31502 <i>NS</i>	31553	31587
P600B	31469	31503	31554	31588
P500B	31470	31504 <i>NS</i>	31555	31589
P400B	31471	31505	31556	31590
P320B	31473	31507	31558	31592
P280B	31474	31508	31559	31593
P240B	31475	31509	31560	31594
P220B	31476	31510	31561	31595
P180B	31477	31511	31562	31596
P150B	31478	31512	31563	31597
P120B	31479	31513	31564	31598
P100B	31480	31514	31565	31599
P80B	31481	31515	31566	31600
PKG/CS	1/6 100 Discs/Roll	1/6 100 Discs/Roll	100/4	100/4

Order by Number of Packs
NS = Non-Stock Item

	BETTER 5" PSA DISC ROLL	BETTER 5" HOOK & LOOP	BETTER 6" PSA DISC ROLL	BETTER 6" HOOK & LOOP
GRIT	662544	662610	662544	662610
P1000B	01222	52254	–	52255
P800B	01221	52267	–	52268 <i>NS</i>
P600B	21217	*21221	–	–
P400B	**65293	52270	–	52269 <i>NS</i>
P320B	87444	–	87450	–
P240B	87443	–	–	–
P220B	87442	–	87449	–
P180B	87441	–	87448	–
P150B	87440	–	–	–
P120B	87418	–	87447	–
P100B	87417	–	–	–
P80B	87415	–	87446	–
PKG/CS	1/4 100 Discs/Roll	100/4	1/4 100 Discs/Roll	100/4

Order by Number of Packs
*Part number prefix is 662544, **Part number prefix is 662610

Gold A296 Gold Reserve Aluminum Oxide No-Fil B-Weight Paper Discs



	GOOD 5" PSA DISC ROLL	GOOD 5" HOOK & LOOP	GOOD 6" PSA DISC ROLL	GOOD 6" HOOK & LOOP
GRIT	662611	666233	662611	636425
P800B	–	–	–	06226
P600B	–	–	–	06227
P500B	–	–	–	06228
P400B	83814	05639	83823	06229
P320B	83813	05638	83822	06230
P240B	83812	57751	83821	06225
P220B	83811	05637	83820	06231
P180B	83810	77543	83819	06232
P150B	83809	77542	83818	06233
P120B	83808	77541	83817	06234
P100B	83807	–	83816	06235
P80B	83806	77539	83815	06236
PKG/CS	1/4 100 Discs/Roll	100/4	1/4 100 Discs/Roll	100/4

MeshPower Aluminum Oxide Vacuum No-Fil Paper Discs



Back-up Pads and Interface Pads for Cyclonic and Mesh Discs



	GOOD 5" DISCS	GOOD 6" DISCS	
GRIT	636425	636425	PKG/CS
400	06457	06464	50/4
320	06456	06463	50/4
240	06455	06462	50/4
220	06454 <i>NS</i>	06461 <i>NS</i>	50/4
180	06453	06460	50/4
120	06452	06459	50/4
80	06451	06458	50/4

Norton Multi-Air NorGrip Back-up Pads

DIAMETER x THREAD	DENSITY	666233	PKG
5" x 5/16-24	Medium	76000	1/5
DIAMETER x THREAD	DENSITY	636425	PKG
6" x 5/16-24	Medium	06160	1/5
6" x 5/16-24	Soft	60605	1/1

Norton Multi-Air NorGrip Interface Pads

DIAMETER	THICKNESS	636425	076607
5"	1/2"	85864	—
6"	1/2"	—	19359
<i>PKG/CS</i>		<i>8/1</i>	<i>12/1</i>

BlueFire H875 Zirconia Alumina Paper Discs and File Sheets

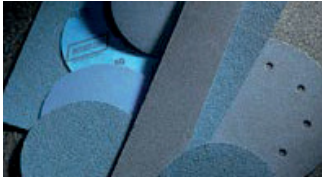

	BETTER 6" PSA	BETTER 6" HOOK & LOOP	BETTER 8" PSA	BETTER 8" HOOK & LOOP
DISCS	662611	662611	662611	662611
80E	23573	23588	23576	23591
40E	23574	23589	23577	23592
36E	23575	23590	23578	23593
<i>PKG/CS</i>	<i>50/4</i>	<i>25/4</i>	<i>25/4</i>	<i>25/4</i>

Back-up Pads for Paper and Film Discs

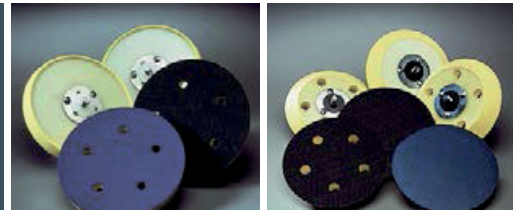

	BETTER 2-3/4" x 17-1/2" CLIP-ON PSA	BETTER 2-3/4" x 16-1/2" PSA	BETTER 2-3/4" x 16-1/2" HOOK & LOOP
FILE SHEETS	662611	662611	662611
80E	23620	23608	23614
40E	23621	23609	23615
36E	23622	23610	23616
<i>PKG/CS</i>	<i>50/5</i>	<i>50/5</i>	<i>25/5</i>

Order by Number of Packs

Long Board Sheets Hook & Loop Sheets

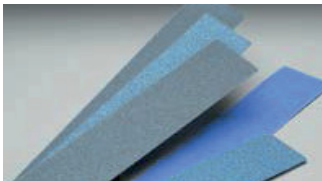

	BETTER H875 4-1/2" X 30"	BETTER A275 4-1/2" X 30"
GRIT	662610	662610
600B	-	23272 <i>NS</i>
400B	-	23271 <i>NS</i>
320B	-	23270 <i>NS</i>
220B	-	23268 <i>NS</i>
180B	-	23267 <i>NS</i>
120B	-	23265 <i>NS</i>
100B	-	23462 <i>NS</i>
80B	-	77906 <i>NS</i>
80E	23464 <i>NS</i>	-
36E	23457 <i>NS</i>	-
<i>PKG./CS</i>	<i>10/25</i>	<i>10/25</i>

SIZE	DESCRIPTION	PSA 636425	HOOK & LOOP 636425	PKG
3"	Soft Low Profile	—	06128	10
5"	Soft Low Profile	06126	06129	5
5"	Med. Low Profile	06131	06135	5
5"	Med. Tapered Edge	06139	06143	5
6"	Soft Low Profile	06127	06130	5
6"	Med. Low Profile	06133	06137	5
6"	Med. Tapered Edge	06141	06145	5
5" x 5 H	Med. Low Profile – Vac.	06132	06136	5
5" x 5 H	Med. Tapered Edge – Vac.	06140	06144	5
6" x 6 H	Med. Low Profile – Vac.	06134	06138	5
6" x 6 H	Med. Tapered Edge – Vac.	06142	06146	5
8"	Med. Tapered Edge	43112	43704	5*
8" x 8 H	Med. Low Profile, 5 screw	43712	—	5*
8" x 8 H	Med. Low Profile, 6 screw	—	43714	5*

*PACKED IN INDIVIDUAL CLAMSHELL

If you're looking for quality abrasives, grinding & sanding, visit our website.