



ACCEL

EDGE

Superchips

DIABLOSPORT

Racepak

HOOKEE
BLACKHEART

FLOWTECH
MOTORSPORT

Holley[®]

MSD

FUELYOUR PASSION

2017 NEW & HOT PRODUCTS

NOS
Nitrous Oxide Systems

EARLS

WEIAND

DEMON
CARBURETION

QUICK FUEL

Mallory

QUICK
TIME

L
LAWRENCE

HAYS





Holley SNIPER EFI

- Bolt on carburetor replacement (designed to fit single & dual carb manifolds)
- ECU fully integrated into throttle body for easy installation!
- Supports up to 650hp (4 injector version) and 1250hp (8 injector version)
- Available in Polished, Hard Core Gray™ & Classic dichromate look finishes
- 4 wire vehicle connection (Battery +, Battery -, Switched ignition & RPM)
- Integrated fuel pressure regulator, ignition timing control & coil driver
- Color touchscreen for setup and gauge views
- Self-tuning ECU - No laptop required!
- Dual mounting pattern allows it to fit a large variety of engines and vehicles.
- Available in base & master kits (Master kits include complete fuel system: fuel pump, filters, hose and fittings)

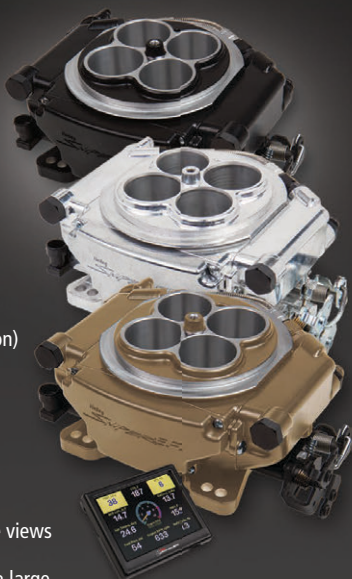

**AVAILABLE IN
MASTER KITS!**



Holley TERMINATOR STEALTH EFI

**CLASSIC CARBURETOR
LOOKS WITH THE
DRIVABILITY OF EFI!**

- Same great self-tuning features of Terminator in a new package!
- Kits available with trans control!
- Fits V8 engines from 250-600 horsepower
- 4150 style 4BBL mounting flange - Bolts on in place of carburetor
- Available in Polished, Hard Core Gray™ & Classic dichromate look finishes
- Fully self-tuning ECU - No laptop required
- Includes full color, 3.5" touch screen LCD for both basic and advanced tuning options
- Timing control option for GM Small Cap HEI and Ford TFI distributors
- Connections for Ford, GM TH350, 700R4 and other transmission linkages
- Optional free software upgrade for full laptop control
- Easy plug and play harnesses with minimal connections
- Full color instructions included with user friendly wiring and fuel system diagrams



**AVAILABLE IN MASTER KITS! EVERYTHING
INCLUDED FOR A COMPLETE INSTALL!**



MULTI-PORT EFI SYSTEMS

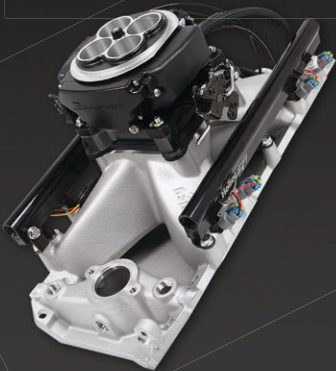

- Throttle body mounted ECU – no extra boxes to mount
- Integrated ignition timing control & coil driver
- Color touchscreen for setup and gauge views
- Calibration Wizard - No laptop required!
- Self-tuning ECU means you don't have to be a computer/tuning wiz to have EFI!
- Available in base & master kits w/ or w/o Intake Manifolds and Injectors! (Master kits include complete fuel system: fuel pump, filters, feed and return hose and all fittings including fuel tank return line bulkhead fitting.)
- Bosch 4.9 oxygen sensor and coolant temp sensor included!

Holley EFI

MID-RISE INTAKES FOR GM LS1/LS2/LS6 & LS3/L92 W/ 105MM TOP



- Provides great performance to 6500 rpm for street/strip performance applications while providing the look of a racing EFI intake manifold
- Unique modular design allows the combination of a traditional dual-plane layout with an EFI manifold plenum to produce great mid-range torque without compromising top end power
- Great for supercharged or turbocharged engines
- Power band from 1500-6500 rpm
- May require an aftermarket hood for some vehicle applications.
- Cast aluminum construction
- Intended for use on all GM LS Gen III or IV engines equipped with LS1/LS2/LS6 or LS3/L92 style cylinder heads (recalibration of the ECU may be required when using this intake manifold design with OE ECU).

NOW AVAILABLE WITH 105MM TOP!

Holley EFI

HI-RAM INTAKE MANIFOLD FOR GM 6.2L LT1



- The base is designed to be modular in to accept a wide range of available tops and to be attractive to builders and fabricators as a foundation for custom induction systems
- Increased runner taper and cross-sectional area designed to perform well on a wide variety of engine configurations
- Increased runner wall thickness near the entries to allow for custom porting
- Intakes with fuel injector provisions include fuel rails machined for -8AN O-ring fittings with passages large enough to accommodate high fuel flow and dampen pressure pulsations in the fuel system
- 3500-8000+ RPM band

NOW FOR NEW GEN V LT ENGINES!

Holley EFI

105MM MONO-BLADE THROTTLE BODIES

- Lightweight billet design (3.5" square bolt pattern)
- Adjustable idle and WOT stops
- O-Ring Grooved for a 100% Air Tight seal between the throttle body and intake manifold
- Indexable throttle lever for a variety of installations
- Non-contact magnetic TPS sensor – Bringing Pro Stock and ARCA Technology to your ride!
- 2 versions: 4" V-band (**112-590**) or Dual O-ring (**112-591**) connections
- Conventional Small Block Ford throttle body bolt pattern (86-93 SBF)



112-590

PERFECT FOR FORCED INDUCTION APPLICATIONS!

Holley EFI

EFI THROTTLE BODY INTAKE ELBOW



300-240

- Dual throttle body bolt pattern
- Fits GM LS & Ford 5.0L throttle bodies
- 105mm throttle body opening
- 100° mounting angle
- Fits intakes w/ 4150 flange
- Slotted mounting holes allow forward, sideways or rearward throttle body mounting
- LS3 Style MAP sensor mounting
- (4) Vacuum Ports – (1) Each 1/4" NPT & 3/8" NPT & (2) 1/8" NPT w/ indirect baffled signal
- (2) Throttle linkage mounting bosses
- Sand cast w/ satin finish
- Overall height 5.12"
- Remote Throttle body V-band adapter kit (**300-250**) and MAP sensor port cover (**300-251**) also available. See pages 15 & 16 for information

USE GM LS OR FORD 5.0L THROTTLE BODY WITH MOST INTAKE MANIFOLDS!

Holley EFI

DOMINATOR FLANGE "BIG DUAL" THROTTLE BODY AIR VALVE

- Lightweight billet design (4500 bolt pattern)
- Dual throttle blades for maximum airflow
- Shafts ride on roller bearings for ultra-smooth throttle actuation
- Flows 2550 CFM
- Versions with and without supplemental injector provisions (4 injectors per TB and rails)
- Non-contact magnetic TPS sensor – Bringing Pro Stock and ARCA Technology to your ride!

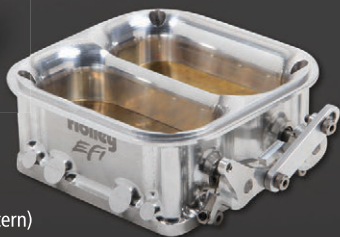

112-593

GREAT FOR X275 NITROUS COMBOS OR A BIG INCH NATURALLY ASPIRATED ENGINE!

Holley EFI

HOLLEY EFI DOMINATOR FLANGE THROTTLE BODY

- Lightweight billet design (4500 bolt pattern)
- Dual throttle blades for maximum airflow
- Shafts ride on roller bearings for ultra-smooth throttle actuation
- Flows 2550 CFM
- Versions with and without supplemental injector provisions (4 injectors per TB and rails)
- Non-contact magnetic TPS sensor - Bringing Pro Stock and ARCA Technology to your ride!



112-592

**GREAT FOR X275
NITROUS COMBOS OR
A BIG INCH NATURALLY
ASPIRATED ENGINE!**

Holley EFI

DIGITAL DASH

The Holley EFI Digital Dash is yet again leaving the competition in the dust. You can now access virtually every tuning parameter, without ever touching your laptop. Our free software/firmware upgrade will unlock the much anticipated: Tuning Mode. With over 800 tuning options available at the touchscreen, you will no longer need to grab a laptop after every 1320' blast. The Holley EFI Digital Dash Tuning Mode will give you access to the following options, and many more!



553-106

**FULL HOLLEY EFI
TUNING NOW
AVAILABLE!**

BASIC TUNING:

- Target AFR (Idle/Cruise/WOT), Acceleration Enrichment, Fuel Prime, Closed loop/Learn, Basic Idle, Spark (Idle/Cruise/WOT), DBW - Pedal vs Throttle, Transmission Control, Shift Points, Shift Tables, WOT Shifts, TCC Setup, Line Pressure

ADVANCED TUNING:

- Startup, Cranking Fuel, After Start Enrichment, Decay Rate, After Start Holdoff
- Accel Enrichment, AE vs TPS ROC, AE vs MAP ROC and more!
- Base Fuel, Target AFR Table, Base Fuel Table, Learn Table, AFR Ratio Offset - Injector End Angle Table, Injector Phasing Table and MORE!
- Spark Tables, Including Knock Retard and Intake Air Modifiers
- Individual Cylinder Tuning, Fuel and Spark Correction per Cylinder!

PERFORMANCE TUNING:

- 3 Timing Retards w/ graphs!
- Rev Limiter 1 and 2 Setup, on/off, and enables!
- Nitrous - 8 Stages of Nitrous Tuning! Including: System Type, Stage Duration, Pedaling Strategy, Min and Max RPM, Stage Delay, Timing Retard
- Boost - Built into the dash you will be able to tune: Boost Launch Target, Boost Safety Setup, Dome Control Setup, Boost vs Speed/Timing/Gear/RPM, Boost Builder, And more!

ADDITIONAL FEATURES:

- Water Methanol / Traction Control / Advanced Tables 1D and 2D / Fan Control / Fuel Pump Control - and the list continues!
- Gauge smoothing
- Unlocks tuning mode!

STAND-ALONE DIGITAL DASH

- Compact, customizable dash for use in a variety of applications
- 7" full color touch screen for easy viewing
- Operating voltage min 8V - 20V
- Weather proof aluminum housing with flexible mounting options
- Completely customizable display
- Multiple gauge & indicator types with limitless customization options
- Quickly toggle between multiple active screens (tune, warm-up, race, drive, etc.)
- Virtual Switch Panel (replaces the need for physical switches)
- Retains the same gauge customization flexibility as the EFI dash, but now allows use with any vehicle
- Powerful data log software provides in-depth analysis (10 samples/sec) of all inputs and outputs, including the integrated 3 axis accelerometer and USB GPS.
- A variety of additional sensors are available for use with the dash, including fuel pressure, nitrous pressure, boost, WBO2 controllers and more!
- User defined alarms for any input
- Configurable progressive shift lights and light bar
- Expandable internal storage on micro SD card
- Support for USB devices such as 554-140 (USB speedometer/GPS)
- Upgradeable with future software enhancements
- Included parts: Standalone digital dash kit with I/O adapter, USB memory stick, terminated vehicle harness, oil pressure sensor, CTS sensor, MAT sensor & USB GPS



553-109

IDEAL FOR ANYTHING FROM A JR DRAGSTER TO A DAILY DRIVER AND MORE!!

Holley EFI

ANALOG-STYLE GAUGES

Compatible with all Holley EFI touch screens, dashes, handheld tuners, and other CAN devices – Great for Holley EFI users looking to install a combination of needle gauges and LCD accessories

- Gauges available in 2-1/16", 3-3/8", or 4-1/2" sizes with either black or white faces
- Bright LED backlighting and pointer allows for easy viewing
- Speedometers available in CAN or GPS versions
- Tachometers available in 8k or 10k,000 RPM versions
- Slim-style mounting requires very little dash space for install
- Internal microprocessor ensures accurate pointer movement in street and racing conditions
- Spin lock ring threads to back of gauge case for simple and secure mounting
- CNC machined billet aluminum bezels with anodized finish
 - Bezels are threaded for easy replacement
- Multiple bezel options available separately
 - User can customize the gauges to their preference



DIGITAL ACCURACY WITH A CLASSIC ANALOG LOOK!

Holley EFI

HOLLEY EFI DUAL SYNC DISTRIBUTORS

- Plug and Play with Holley EFI
- Includes both crank and cam sensors to support sequential EFI operation
- Hall Effect sensor design provides precise timing control and noise immunity
- CNC machined billet aluminum housing
- Integrated LEDs allow for easy setup
- Available for popular applications



PRECISE TIMING & SEQUENTIAL FUEL CONTROL!

Holley EFI

8 CYLINDER SMART COIL KIT

- A plug & play solution for converting your hot rod to coil on plug!

**IMPROVE SPARK DISTRIBUTION WITH
INDIVIDUAL CYLINDER TIMING!**



556-127



Holley EFI

GPS DIGITAL DASH USB MODULE



554-140

**INSTANTLY ADD
A SPEEDOMETER
TO YOUR HOLLEY
EFI DASH!**

- USB connection for user friendly plug and play installations
- The 46" USB cable ensures you will be able to install the GPS Module virtually anywhere on the dash
- Magnetic base provides for multiple mounting solutions
- 10hz Refresh rate for ultra-accurate real time speedometer output
- Requires clear line of sight with the sky for satellite acquisition
- Can only be used with 553-106 or 553-109 (comes supplied with 553-109)

Holley EFI

FUEL SYSTEM KITS

Holley EFI fuel kits are the perfect addition to your Terminator, Sniper or Holley EFI kit. They are engineered using Holley fuel pumps, regulators and filters coupled with quality Earl's Vapor Guard plumbing to provide a fuel system tailored to the needs of your fuel injected hot rod.



526-7

- 526-5 Vapor Guard Fuel System – 20' of Vapor Guard Hose, 12-920 fuel pump, Pre and Post filters, includes all the fittings and mounting hardware
- 526-7 Vapor Guard Fuel System – 40' of Vapor Guard Hose, 12-920 fuel pump, Pre and Post filters, includes all the fittings and mounting hardware

ALL THE PARTS YOU NEED IN ONE BOX!

Holley EFI

ECU CRIMPER TOOL

- High quality ratcheting mechanism ensure every crimp is tight and secure!
- Features adjustable tension settings
- High-traction rubberized handle
- Designed for 28-24, 18-16, 24-20 gauge pins



567-100

**BRINGING PROFESSIONAL
QUALITY WIRING TOOLS
TO YOUR GARAGE!**



SNIPER HI-RAM FABRICATED INTAKE MANIFOLDS

Carbureted & EFI!!

- Budget-friendly fabricated intake manifolds for the following engine platforms:
 - Small Block Chevy
 - Small Block Ford
 - GM LS1/LS2/LS3/LS6/LS7
 - Ford Mod-Motor
 - Ford Coyote
- 3mm (1/8") thick T6061 Aluminum
- EFI Versions available in 90mm, 92mm, and 102mm throttle body openings
- EFI Intakes include high-flow fuel rail kits
- 100% TIG welded
- Carbureted intake versions available in 4150 and 4500 flanges

HIGH QUALITY FABRICATED MANIFOLDS AT A BUDGET-FRIENDLY PRICE!



90, 92 & 102MM THROTTLE BODIES

- Budget-friendly cable operated throttle bodies available in 90mm, 92mm, and 102mm sizes
- Larger bore for increased airflow supporting higher horsepower levels
- Billet aluminum construction
- Laser engrave Sniper EFI logo
- Available in black or silver anodized finish
- Adjustable throttle stop
- Progressive throttle pulley and double return spring



FUEL RAIL KITS

- Fuel Rail Kits for GM LS1/LS2/LS3/L92/LS6/LS7, 2005-10 Ford 4.6L Modular & 11-14 Ford 5.0L Coyote Sniper manifolds with Sniper logo
- Billet aluminum construction
- Includes mounting brackets, crossover line, and hardware
- 3/8" line diameter with -8 fittings





FUEL TANKS



**PERFECT SOLUTION FOR
RETROFIT EFI!**

**DIRECT FIT EFI MUSCLE
CAR TANKS WITH PUMPS
& SENDING UNITS!**

- Tanks are coated galvanized steel then powder coated silver for total corrosion protection
- 255 lph fuel pump with hanger assembly gives you the fuel you need with no in-tank noise
- Sender has 1/4" NPT Supply and Return line ports for easy fuel line connection and a barbed vent fitting
- Fuel level sender included with the correct Ohm range for your factory gauges
- Fuel pump and sender are recessed in the tank to provide an easy installation with no modification to your car
- EFI style tank baffling includes a large 4.3 liter internal fuel tray to prevent fuel pump starvation
- Fits and looks like an OE tank when installed
- We even have notched tanks for the First Gen F-bodies with rear suspension mods and huge tires
- Complete bolt in solution for your EFI conversion
- Includes new tank straps



CARBURETORS

113 years of carburetor experience went into building the ultimate performance street carburetor for your daily driver that would not break the bank! Introducing Street Warrior!



- Performance upgrade for stock to mildly modified V-8 engines
- Calibrated for excellent street performance right out of the box
- Integrated 700R4/200R4 transmission kick down cable mounting
- Vibratory polished aluminum for good looks and long lasting shine
- Upgraded to a 1 Year Warranty!
- Compatible with GM, Chrysler, and Ford A/T kickdown linkage. Additional parts may be required



CARBURETORS

The Track Warrior utilizes the best features from Holley's Race Bred Classic 4150 HP™ carbs. They come in black and purple finishes and are one of the best priced race carburetors in the market!

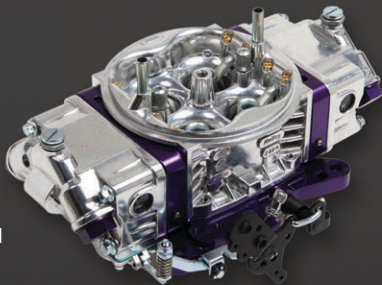

- Optimized race calibrations for outstanding throttle response
- Contoured venturi inlet offers balanced airflow for increased horsepower
- Mechanical secondaries for awesome tire turning performance
- The billet metering blocks feature improved durability over cast blocks, true gasket sealing and are fully adjustable (emulsion bleeds, power valve channel restrictors & idle feed restrictors)
- Available in 650, 750, and 850 CFM versions

Holley® DOMINATOR SP

DOMINATOR SP CARBS

- Designed for use on Drag race, Pro Street, or any high horsepower engines
- Fully machined from venturi throat to throttle bore for predictable & repeatable performance
- Metering blocks feature improved durability, true gasket sealing and tuneability
- Notched float and jet extensions are factory installed
- 5/8-18 inlet threads and standard 4500 fuel inlet spacing
- Factory ready TPS mounting points for use with data acquisition systems (Holley TPS P/N 534-214 available)
- Progressive secondary link installed for perfect off the line launches. No linkage parts under the carburetor (1:1 wire link included in kit)

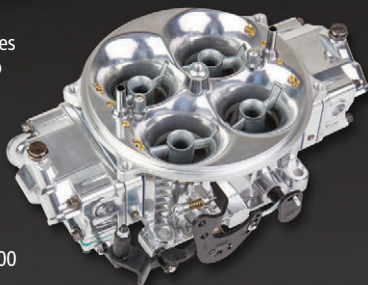

**GREAT DOMINATOR
PERFORMANCE AT A
BUDGET-MINDED PRICE!**

Holley®

MARINE AVENGER CARBURETORS

These all-aluminum carburetors are hard coat anodized in a Hard Core Gray finish to protect them from corrosion in fresh water or salt water conditions. The new Marine Avengers are built to exceed the Coast Guard standards and are J1223 Marine Standard certified. Also has a Limited Lifetime Warranty as our Street Avengers do.

**LATEST CARBURETOR
TECHNOLOGY FOR
YOUR BOAT!**



- Calibrated to compensate for unique engine loads found with boats
- Dual metering block system utilizing four corner idle adjustment for precise tuning
- Throttle shafts are PTFE coated for corrosion protection
- Available in 570 CFM, 670 CFM, and 770 CFM sizes to match your application needs

Holley®

HP MAIN BODY RETRO-FIT KITS

If you can turn a screwdriver, you can get increased horsepower from the new Holley Aluminum HP carburetor main bodies. These aluminum HP main body retrofit kits convert your existing 650, 750, or 850 cfm Double Pumper® to an aluminum HP main body for increased horsepower, torque & airflow.

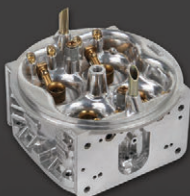

**EASILY
CONVERT YOUR
DOUBLE PUMPER®
TO A RACE
CARBURETOR!**

- Main bodies are factory assembled and kit includes new gaskets to complete the conversion
- New main jets are included, however further tuning may be necessary depending on the application
- Pre-calibrated at the factory for optimum performance and drivability on a wide variety of applications

Holley® **MIGHTY DEMON™**

MODULAR CARBURETORS

Mighty Demons are available in a full range of sizes and options for your street/strip car. For high horsepower street and race engines, the aluminum Mighty Demon™ delivers more power and performance!

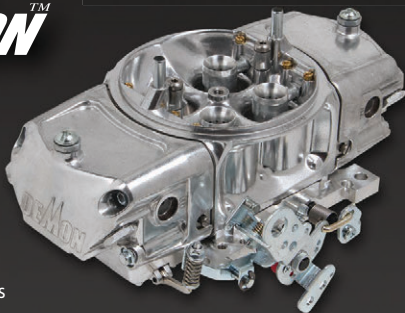

**NOW IN
ALUMINUM FROM
650 TO 850CFM!**

- All aluminum polished construction with billet metering blocks and base plate (Now 40% lighter than the original Demons!)
- Fuel bowls and main body have been redesigned for a sleeker, more stylish appearance
- Completely re-engineered and re-calibrated for better drivability and full throttle performance
- Re-designed throttle lever with integrated Ford A/T, 700-R4, and Chrysler kick down options
- Changeable idle, high-speed air bleeds & power valve restrictions for precise tuning



Holley's patent pending fuel reservoir system designed to reduce fuel starvation issues present in hard cornering, acceleration, stopping, inclines, and low fuel conditions!

- Greatly reduces potential for air to enter into fuel system which can result in poor engine performance and/or stalling
- Surface tension and fluid wicking allow the HydraMat to continue to draw fuel from the tank or cell even when part of the mat is uncovered
- As an area of the HydraMat is uncovered, tiny pores seal off through surface tension, forcing fuel to be drawn from other areas of the mat where fuel continues to be available
- Unique internal reservoir assists in keeping fuel available at the pickup even under extreme fuel slosh conditions
- Eliminates need for specialty reservoirs, sumps and pick up pumps saving cost and greatly reducing complexity

Holley

VR1 & VR2 BRUSHLESS FUEL PUMPS

Featuring brushless pump technology and a twin screw rotor design, the VR1 and VR2 in-line fuel pumps are capable of high pressures and flows while maintaining a low amperage draw and quiet performance. Designed to work on high boosted race cars as well as your daily driven weekend endurance car, these pumps work with gasoline, methanol, and E-85 and can maintain pressures of 130 PSI and up to 335 GPH flow.



SUPPORT OVER 4000HP!

- Each pump includes a 2 step controller for pump speed control.
- Unlike other pumps, the VR Series are built for continuous duty if needed.
- The dual pump models are designed for endurance racing where both pumps are used or one can be a reserve pump
- Can be fully submerged in the fuel cell or chassis mounted



Holley

UNIVERSAL IN-TANK RETRO-FIT FUEL MODULES

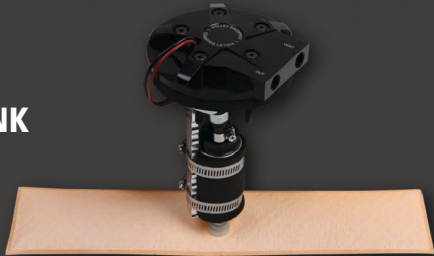

RETURNLESS STYLE

- The easiest way to convert your vehicle to an in-tank, RETURNLESS EFI fuel system
- Eliminates the need for return line and conventional fuel pressure regulator
- Installs in any fuel tank from 5 1/2" to 12" deep
- Includes innovative Holley HydraMat to ensure consistent fuel supply
- Black anodized aluminum construction with 1/4" NPT fittings
- Ideal for Terminator, Sniper TBI conversions or LS engine swaps
- Two different fuel pumps available to match your requirements – 255LPH or 400LPH

RETURN STYLE

- The easiest way to convert your vehicle to an in-tank, EFI fuel system
- Installs in any fuel tank from 5 1/2" to 12" deep
- Includes innovative Holley HydraMat to ensure consistent fuel supply
- Black anodized aluminum construction with 1/4" NPT fittings
- Ideal for Terminator, Sniper, Atomic TBI conversions or LS engine swaps



**THE SIMPLE SOLUTION FOR CONVERTING YOUR
RIDE TO AN IN-TANK EFI FUEL SYSTEM!**

Holley EFI FILTER/REGULATORS - 3/8" NPT OR 8 AN

The new Holley EFI Filter Regulator assembly simplifies your installation by combining the fuel filter and regulator in one assembly that can be mounted in the rear of the vehicle. Thus making your return line for your EFI conversion much shorter.

- 175 GPH 10 Micron filter
- Preset at 59.5 psi
- 3/8" NPT or 8 AN port sizes to match most EFI fuel systems

NO NEED TO RUN A RETURN LINE FROM THE FRONT OF THE CAR!



Holley DIECAST FUEL PRESSURE REGULATORS

AN EFI FUEL PRESSURE REGULATOR FOR UNDER \$60?

That's right! Holley does it again with their new die cast aluminum fuel pressure regulators.

- Die Cast aluminum construction
- Pressure preset at 60 psi
- Also available in a 6 psi carbureted version
- Chrome finish with mounting bracket included
- 3/8" NPT Inlet, Out, and Return ports
- 1/8" NPT Gauge Port
- Boost Reference – 1:1



Holley DOUBLE ADJUSTABLE FUEL PRESSURE REGULATORS

Holley's new double adjustable fuel pressure regulators are designed for high horsepower fuel systems that require a low pressure at idle and higher pressure as the load and engine rpm increase.

- Individual adjustment settings, one for idle and wide open throttle
- Fuel pressure adjustability at idle can help prevent flooding and low rpms
- Wide open throttle settings help to prevent fuel starvation at the top end of the rpm range
- Alcohol and E85 compatible
- 2 Port models available with 8AN and 10AN port sizes
- 4 Port model available with 8 AN inlets and 10 AN return ports



PRECISELY CONTROL IDLE & HIGH PRESSURE INDEPENDENTLY!

Holley LS TALL VALVE COVERS FOR DRY SUMP

- Perfect for LS7 Engines – no oil fill allowance for Dry Sump applications
- Fits all LS Engines using LS2, LS3, LS7 or similar coils with 72mm bolt spacing
- Clearance for up to .750" lift cam with stock style rocker arms
- Available in three finishes

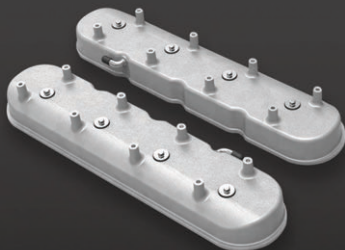

241-92
241-93
241-94

Natural Cast
Polished
Satin Black

ELIMINATES UNNEEDED OIL FILL HOLE!



EXTRA ROCKER ARM CLEARANCE!

Holley

LS TALL VALVE COVERS

- Angled coil mount for smooth, clean look
- Eliminates OE style coil brackets
- Fit LS1, LS2, LS3, LS6 and LS7 engines using coils with a standard LS3 bolt spacing of 72mm
- Provides additional 0.54" internal clearance over factory covers
- Available in four finishes

241-110	Natural Cast
241-111	Polished
241-112	Satin Black
241-113	Gloss Red

Holley

VINTAGE SERIES TALL LS FINNED VALVE COVERS

- Fits all GM LS engines (LS1, LS2, LS3, LS6, and LS7)
- Provides additional 0.54" internal clearance over factory covers
- Ready to install right out of the box with OE style baffle and lengthened style mounting hardware and billet aluminum oil fill cap
- Available in natural cast, polished, satin black & factory orange

CLASSICALLY FINNED FOR A RETRO LOOK!



Holley

ALUMINUM TALL LS VALVE COVERS W/ DOMINATOR LOGO

- Fits all GM LS engines (LS1, LS2, LS3, LS6, and LS7)
- Provides additional 0.54" internal clearance over factory covers
- Eliminates unsightly OE style coil brackets
- Ready to install right out of the box with OE style baffle and lengthened style mounting hardware and billet aluminum oil fill cap
- Also available in polished, satin black and natural cast finishes



ELIMINATES THE COIL ON COVER LOOK!

Holley

LS VALLEY COVERS

- Available for LS1/LS6 & LS2/LS3/LS7/LSX engine platforms
- Choose from classic finned design (matching our valve covers) or trussed for a race inspired look
- Available in die cast or billet aluminum
- Choose from five finishes – Natural Cast, Satin Black, Polished, Gloss Red, and Factory Orange

CLEAN UP THE LOOK OF THE VALLEY WITH A VARIETY OF FINNED OR TRUSSED COVERS!

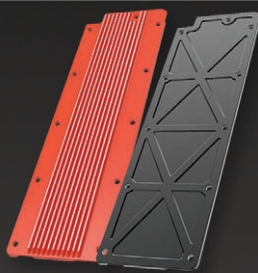

Holley

MUSCLE SERIES COVERS FOR SMALL BLOCK CHEVY

- Designed to fit all 1958-86 Small Block Chevy engines with perimeter bolt patterns
- Die-Cast aluminum construction ensures high detail and reduces the opportunity for warping of the valve cover flange and oil leaks
- Standard height valve cover with pre-installed internal oil baffles
- Factory style twist-in oil fill cap, round Holley emblem, and square oil fill and PCV grommets included
- Available in four finishes to best suit your custom build: natural, polished, gloss black, factory orange

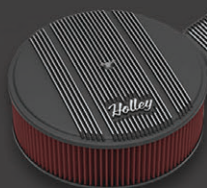

CLASSICALLY INSPIRED FIN DESIGN!



VINTAGE SMALL BLOCK CHEVY AIR CLEANERS AND VALVE COVERS

AIR CLEANERS:

- 14" in diameter and are constructed of die-cast aluminum
- Available in both 3" and 4" heights to ensure proper fitment
- Also available with either paper (white) or premium cotton gauze (red) filter elements
- Include color-matched SureFlo style bases with knock out provisions for a fresh air adapter, which is also included

VALVE COVERS:

- Designed to fit all 1958-86 small block Chevrolet engines with perimeter bolt patterns
- Die-cast aluminum construction ensures high detail and reduces the opportunity for warping of the valve cover flange and oil leaks
- Stand 3.5" tall with pre-installed internal oil baffles. The oil fill and PCV grommets are also included.

Holley GM GEN V LT RETRO-FIT OIL PANS

- Designed for more oil pan to chassis clearance around the front half of the oil pan
- Provides maximum clearance for vehicles where the steering linkage is behind the engine cross-member
- Perfect for: 1967-69 Camaro/Firebird, 1968-74 Nova/Apollo/Ventura/Omega, 1982-92 F-body, 1978-87 G-body, and 1964-72 A-body applications
- Maximum recommended crankshaft stroke – 4.00"
- Can be used anywhere a GM F-Body oil pan can be used
- Provides OEM fitment - Oil filter mounting, OEM oil cooler port provision, OEM engine NVH suppression, OEM flange sealing, proper structural rigidity and OEM bell-housing attachments
- Traditional high-quality cast aluminum appearance with clean exterior styling
- Turbo Oil return 1/2" NPT port

- 302-20** GM LT Retro-Fit Oil Pan, Cast finish
- 302-22** GM LT Drag Race Oil Pan, Cast finish
- 302-30** GM LT Touring Baffle Kit (use w/ 302-20 pans)

GET MORE CLEARANCE FOR YOUR GM GEN V LT ENGINE!



302-20

Holley

GM LS POWER STEERING HARDLINE FOR TYPE II POWER STEERING PUMPS

- Moves inlet connection to more accessible location
- Better appearance
- Steel w/ zinc plating
- Mounting bracket – Better support & strength
- Special banjo bolt & crush washers included
- Works with most Type II power steering pumps



198-202

MOVE POWER STEERING LINE FOR EASY ACCESS & MORE CLEARANCE!

Holley

REMOTE THROTTLE BODY V-BAND ADAPTER KIT

- Billet aluminum construction
- Allows the relocation of the throttle body to a new remote mounting location
- Features GM LS or Ford 5.0L flange with a 4 inch V-Band style flange, and includes gaskets and hardware



300-250

Holley

MAP SENSOR PORT COVER

- Billet aluminum construction
- Eliminates the MAP Sensor and works with most intake manifolds with the LS3 style MAP sensor
- Includes O-ring seal and mounting hardware



300-251

Holley

LS FORWARD-FACING & UPWARD-FACING INLET WATER PUMPS

- Forward inlet allows truck swap engines to be installed in low hood vehicles
- Allows original truck accessories to be used
- Fits all LS engine blocks
- Works with long (truck type) belt spacing
- Standard & middle belt alignment pumps also available

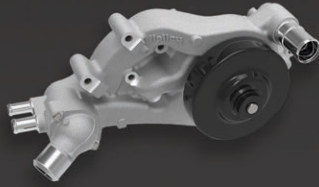

- 22-100** Forward Facing Inlet– All LS with Standard and Middle Belt Alignments
22-101 Forward Facing Inlet– All LS with Long Belt Alignments
22-102 Upward Facing Inlet– All LS with Long Belt Alignments

Holley

105 AMP ALTERNATOR W/ SMALL BODY



197-300

- 105 amp output
- Smaller & lighter than 197-301
- Use when clearance matters on Holley LS accessory brackets
- Uses weatherproof plug/pigtail P/N 197-400 (not included)
- Recommended for use with LS low mount brackets

IMPROVED CLEARANCE ON LS SWAPS!

Holley

GM GEN V LT ACCESSORY DRIVE KITS

- Modular System – Buy installation kit & brackets, or as complete kits
- Upgraded to historically desirable center mounted LS water pump that makes the LT engine look like it belongs in your swap project vehicle!
- Works with LT Truck harmonic balancer (often already on donor engine)
- Cost effective and proven solution

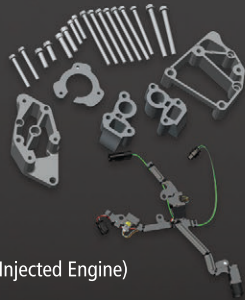

- 21-5** Installation Kit – GM LT (Gen V Direct Injected Engine)
20-170 Complete LT Accessory Drive System w/ Alt, P/S, A/C, water pump, belt
97-180 Replacement Hardware for 20-170

IDEAL FOR GEN V LT ENGINE SWAPS!

16



LOW MOUNT ACCESSORY DRIVE BRACKETS FOR GM LS ENGINES

- Small compact accessory brackets & complete kits
- Modular System – Buy brackets & installation kit or complete kits
- Fits middle and long accessory spacing
- Installation kit 21-4 required w/ long spacing
- A/C brackets & kits use sanden SD7 compressor
- Brackets and kits with or without A/C
- P/S hardline works w/ most type II P/S pumps (Sold Separately)
- Cost effective solution

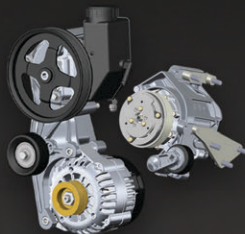

IDEAL FOR LS ENGINE SWAPS W/ LIMITED SPACE OR WHERE A LOW, MORE ATTRACTIVE APPEARANCE IS DESIRED!



CHEVY V8 SMALL CAP DISTRIBUTOR



85701

- CNC machined billet aluminum housing is 1/2" smaller in diameter and over 1" shorter than conventional Chevy V-8 distributors with the "points" type cap
- Supplied with small diameter HEI style distributor cap and rotor
- Will not accept a vacuum advance canister
- O-ring seals can be added to modified blocks to improve oil pressure control
- Must be used with an MSD 6, 7, 8, or 10 Series Ignition
- Special oil tract improves lubrication to the distributor and cam gear
- Maintenance-free magnetic pickup and precision reluctor create stable trigger signals throughout the rpm range
- Easy-to-adjust mechanical advance with supplied springs and stop bushings
- Adjustable slip collar mounting flange for engines with modified deck heights
- Polished steel shaft is QPQ coated and guided by a sealed ball bearing and extra-long sintered bushing
- Advance plate and weights are fine blanked from chrome moly steel and QPQ coated for friction reduction
- Advance weight pins are staked and tig welded to the plate
- Nylon pads ensure smooth operation of the advance weights
- Mechanical advance assembly can be locked out for crank trigger systems



84563

FORD 5.0L BLACK PRO-BILLET DISTRIBUTOR

- Drop in billet replacement for late model Ford TFI 5.0L distributors
- Supplied with a steel gear to work with the factory roller camshaft
- Factory style ignition module accepts factory wiring
- CNC machined billet aluminum housing and billet aluminum base
- Shaft is QPQ coated and guided by a sealed ball bearing
- Supplied with late model distributor cap and rotor

**MSD
BLACK**



85555

CHEVY V8 PRO-BILLET DISTRIBUTOR - BLACK

- CNC machined billet aluminum housing and billet aluminum base
- Will not accept a vacuum advance canister
- Must be used with an MSD Ignition Control
- Supplied with an HEI style distributor cap and rotor (accepts Cap-A-Dapts)
- O-ring seals can be added to modified blocks to improve oil pressure control
- Special oil tract improves lubrication to the distributor and cam gear
- Nylon pads ensure smooth operation of the advance weights
- Advance weight pins are staked and tig welded to the plate
- Mechanical advance assembly can be locked out for crank trigger systems
- Advance plate and weights are fine blanked from chrome moly steel and QPQ coated for friction reduction
- Polished steel shaft is QPQ coated and guided by a sealed ball bearing and extra long sintered bushing
- Maintenance-free magnetic pickup and precision reluctor create stable trigger signals throughout the rpm range
- Easy-to-adjust mechanical advance with supplied springs and stop bushings

**MSD
BLACK**



83653

CHEVY V8 PRO-BILLET HEI DISTRIBUTOR - BLACK

- A complete performance HEI distributor upgrade for Chevy V8 engines
- Supplied with stainless steel distributor cap posts for long life and superior performance
- Full spark energy output to 9,000 RPM
- Supplied with an 8.5 amp, single spark, inductive discharge ignition module, MSD PN 83647, and MSD HEI Coil, PN 8225
- Special oil tract improves lubrication to the distributor and cam gear
- Nylon pads ensure smooth operation of the advance weights
- Advance weight pins are staked and tig welded to the plate
- Mechanical advance assembly can easily be locked out for racing or EFI applications
- Advance plate and weights are fine blanked from chrome moly steel and QPQ coated for friction reduction
- Polished steel shaft is QPQ coated and guided by a sealed ball bearing
- CNC machined billet aluminum housing and billet aluminum base anodized black for a clean look
- Vacuum advance canister for improved economy (can be locked out)
- Easy-to-adjust mechanical advance with supplied springs and stop bushings
- CARB E.O. Approved

**MSD
BLACK**

CHRYSLER 426, 440 PRO-BILLET DISTRIBUTOR - BLACK

**85463**

- Must be used with an MSD Ignition Control
- Polished steel shaft is QPQ coated and guided by a sealed ball bearing for smooth operation at all rpms
- Maintenance-free magnetic pickup and precision reluctor create stable trigger signals throughout the rpm range
- CNC machined billet aluminum housing and billet aluminum base providing superior strength and great looks
- Easy-to-adjust mechanical advance with supplied springs and stop bushings
- Advance plate and weights are fine blanked from chrome moly steel and QPQ coated for friction reduction
- Advance weight pins are staked and tig welded to the plate
- Nylon pads ensure smooth operation of the advance weights
- Mechanical advance assembly can be locked out for crank trigger systems or racing applications
- Vacuum advance canister for improved economy (can be locked out)

MSD

GEN V LT WIRE SETS



- 10.5" length
- 40 - 50 ohms of resistance
- Copper alloy conductor for great voltage carrying capabilities
- Ferro-magnetic impregnated center core
- Sleeve is consisted of a proprietary blend of silicone and synthetic material
- 8.5mm Dual crimp terminals
- Available in red or black

33823 LT Ignition Wires - red**33829** LT Ignition Wires - black**MSD**

LS IGNITION CONTROLLERS



- Fits most LS Engines
- No PC required for basic functionality
- Six preprogrammed timing tables for easy set-up
- Rotary selector switch allows timing changes
- Nitrous and boost compatible
- High speed data acquisition
- Fully Sealed direct plugin connectors
- Programmable step retard
- Launch and max rev limiters
- Optional coolant temperature sensor input
- Launch retard
- Idle timing control
- Individual cylinder timing
- Compatible with all MSD, Accel and GM LS coils
- Available in red or black

6014 LS Controller - red**60143** LS Controller - black

MSD BLACK

6AL DIGITAL IGNITION W/REV CONTROL



64253

- High output with 530 volts and 135mJ of spark energy
- Efficient components use less current to produce more power
- Set an rpm limit with two rotary dials in 100 rpm increments
- Built-in LED for system checks
- All wires exit through a locked, sealed connector
- Compatible with 4, 6 or 8-cylinder engines

MSD BLACK

DIGITAL PROGRAMMABLE 6AL-2 - BLACK



65303

- Advanced features allow for use in street and racing applications
- PC Programmable with easy-to-use Windows based Pro-Data +Software
- Plot a boost timing map with 0.1° per psi accuracy
- Programmable 3-Step Rev Limiter (100 RPM increments)
- Step retard for nitrous applications plus a boost timing map
- Capacitive Discharge technology for fast rise time and maximum spark energy

MSD BLACK

7AL-2 IGNITION CONTROL - BLACK



72223

- Built-in 2-step rev control
- Operates on 4, 6 or 8-cylinder engines
- Diagnostic Troubleshooting LED
- Terminal strips for convenient hookup

MSD

POWER GRID POWER MODULE



7764

- Four high-current solid state switches that can be configured independently or in conjunction by Time, RPM and temperature switching On /OFF as well as by percentage for NOS systems
- Each channel is capable of handling 20 amps of current without the use of a relay
- Can be used to activate a fan, fuel pump, a Nitrous Oxide system, Throttle stop, the possibilities are endless

**MSD
BLACK**

POWER GRID SYSTEM - CONTROLLER ONLY - BLACK



77303

- USB connection for ease of programming
- Timing based on engine rpm and gear value
- Advanced individual cylinder timing based on gear or time
- Five retard stages for nitrous
- Four steps of rpm limits for burnout, spool, launch and overrev
- Output switch set on rpm, pressure or time
- Shift light settings for each gear
- Ignition data acquisition accepts multiple runs
- Crank Trigger system highly recommended

**MSD
BLACK**

CHEVY SMALL BLOCK 7" BALANCER CRANK TRIGGER KIT - BLACK



86103

- 7" Diameter
- Absolutely the most accurate way to trigger the ignition
- The non-magnetic pickup cannot be false triggered
- Powerful magnets are embedded in a billet aluminum trigger wheel
- Kits feature special brackets and mounting hardware for a variety of engines

**MSD
BLACK**

CHEVY SMALL BLOCK 8" BALANCER CRANK TRIGGER KIT - BLACK



86153

- 8" Diameter
- Absolutely the most accurate way to trigger the ignition
- The non-magnetic pickup cannot be false triggered
- Powerful magnets are embedded in a billet aluminum trigger wheel
- Kits feature special brackets and mounting hardware for a variety of engines



7564

STAND ALONE SOLID STATE RELAY KIT

- Up to 20 amps per channel to power electronic components
- 4 independent channels
- Thermal shutdown for overheat protection
- Short circuit protection eliminates the need for fuses
- Versatile mounting options make installation clean and easy
- Activate by switching power or ground
- LED status indicators to ensure proper functionality



690

HYFIRE STREET IGNITION

The Mallory HyFire Street houses today's digitally controlled capacitive discharge ignition technology in a familiar retro housing. A modern take on a classic, the HyFire provides the expected performance synonymous with the Mallory name. Quick starts, smooth idle and powerful spark energy from idle to redline. Bang through the gears with confidence knowing the HyFire's built-in rev limiter is ready just in case!

- Capacitive discharge technology for full ignition power throughout the rpm range
- Multiple sparks improve starting and idle
- Easily connects to points, amplifiers and magnetic pickup distributors
- Adjustable rev limiter for overrev protection adjustable in 100 RPM increments
- Retro design with modern ignition technology



695

HYFIRE RACE IGNITION

Back and better than ever! The Mallory HyFire Pro is much more than vintage good looks. This race ready ignition was born for the strip. Easily set for a 4, 6, or 8 cylinder with the turn of a dial. The same goes for the HyFire Pro's built in rev limiters. That's right, there's two! Stage your car at the line on the low limit for consistent launches and let the race limit ensure your engine is protected at wide open throttle. Advanced digital capacitive discharge ignition technology ensures full power and accurate timing from green at the tree, to the win light at the end of the track.

- Two stages of rev limiting built in for staging and racing
- High output with up to 135 mJ of spark energy delivering power at any RPM
- Accepts Hall-effect, points and mag pickup triggers
- Controlled by a fast, efficient digital processor keeping timing rock steady
- Retro design with modern technology



61212

SUPER BOX CAPACITIVE DISCHARGE IGNITION

- Modern capacitive-discharge technology for full ignition power throughout the rpm range
- Multiple sparks for improved starting, idle and throttle response
- Full power output at high rpm
- Easily connects to points, amplifiers, and magnetic-pickup distributors
- Adjustable rev-limiter for over-rev protection
- 4-, 6-, and 8-cylinder applications
- Accessory harness available for plug & play on most applications

FOR THE PERFORMANCE-MINDED PERSON ON A LIMITED BUDGET!



49505

SUPERTUNER

- Average gains in excess of 30 HP/40 ft.-lbs. for gas and 80 HP/150 ft.-lbs. diesel*
- HD 2.8" color screen with updated interface for easier and faster modifications
- Increased memory and faster processor for improved tuning plus faster updating
- Active fuel management control*
- Performance test (0-60, ¼ mile testing)
- Internet updating using PC software
- Tire size adjustment
- Axle gear ratio adjustment
- Shift point and firmness adjustment*
- Speed and rev limiter adjustments*
- EO # D-745
- Diagnostic capability – read and clear trouble codes with explanation of codes

EASILY PROGRAM YOUR VEHICLE FOR MORE POWER!



PERFECT FOR FORCED INDUCTION WHERE INCREASED FUEL PRESSURE & PRECISE METERING IS REQUIRED!

FUEL INJECTORS

- Provides precise control of fuel delivery and atomization for increased power and improved throttle response.
- All-new units, not modified stock units or re-manufactured from used cores.
- Operates at higher fuel pressures without loss of metering control. Great for blown applications, where increased fuel pressure and precise metering are required.
- State-of-the-art manufacturing processes reduce flow deviations between injectors to improve performance.
- High-Impedance design for greater control with OEM type ECMs.
- New anti-plugging type, which will forever eliminate problems that were once associated with carbon buildup.
- Perfect for Blown/Turbo applications where increased fuel pressure and precise fuel metering is required.
- For all Port Type EFI Manifolds.



FORD LATE MODEL 4.6/5.4/6.8L V8 "COIL ON PLUG" COILS



- Up to 15% more spark energy than OEM coils
- Should see improved throttle response
- High temperature vacuum applied epoxy resists shock and vibration
- Maximizes fuel mileage
- Installation usually takes less than an hour
- Direct OEM replacement
- ODB II compatible – will not trip an engine code

**NOW AVAILABLE IN
BLUE & BLACK!**



FORD IGNITION UPGRADE KITS

EACH KIT CONTAINS:

HP Copper Core Spark Plugs – 8 Pack

- HP Copper Core Plugs – better at transferring energy than iridium or platinum plugs
- C-Cut ground electrode - better exposure to the flame kernel
- One piece design 3-valve plug – no more plugs broken off in head

ACCEL COP SuperCoils – 8 Pack

- Up to 15% more spark energy – increased efficiency
- High temp epoxy potting – lessens shock and vibration
- Maximizes fuel mileage – helps save gas
- Direct OE replacement – usually installs in less than an hour
- OBD II compatible – will not trip a code



**COMPLETE TUNE
UP IN ONE BOX!**



OPTI-SPARK I PERFORMANCE REPLACEMENT DISTRIBUTOR FOR GM LT1



- Cast aluminum housing with precision bearing
- Epoxy over mold with brass terminals
- Rotor is balanced with brass blade and stainless steel spring
- Compatible with high output CD ignition systems
- Spline drive
- Direct OEM replacement



GM HEI BLACK CAP "READY TO RUN" DISTRIBUTORS



- OEM Appearing Cap- for that Factory Look Restoration
- CNC-machined 6061 T-6 aircraft-grade aluminum housing – for Durability
- High performance ACCEL electronics with mechanical advance – for Dependability
- High performance cap and rotor with brass inserts – which are Corrosion Resistant
- High performance SuperCoil included with 59107CK or for those that already have a high output coil already, the 59107K without the coil
- Adjustable vacuum advance – for fine tuning drivability

**PERFORMANCE
DISTRIBUTOR WITH
FACTORY LOOKS!**



EXTREME 9000 CERAMIC WIRE KITS

**NOW AVAILABLE
WITH BLACK
CERAMIC!**

- 8mm Ferro-Spiral core wire now has ceramic boots on the spark plug end of the wires.
- Withstand up to 2,000°F
- Great for running headers with close tolerance, an engine bay with little room, or an RV with boots that melt because of heat
- Ultra-high temperature double silicone construction wire rated at 600°F peak
- 500 ohms/ft Ferro-Spiral core developed for performance use
- Excellent energy delivery to the spark plugs, while providing the highest level of RFI/EMI suppression
- Stainless steel spark plug terminals for maximum spark energy to the plugs





ULTRAPRO SERIES™

HIGH PERFORMANCE FLUID TRANSFER SYSTEM



**INTRODUCING:
THE WORLD'S
MOST
ADVANCED
PLUMBING SYSTEM!**

**ULTRA RUGGED • ULTRA DURABLE
ULTRA LIGHT • ULTRA FLEXIBLE
ULTRA VERSATILE • ULTRA FLOW**

Modern day high performance vehicles require a plumbing system designed to withstand today's modern fluids, harsh environments, brutal vibration, flow requirements & extreme pressures. UltraPro from Earl's was engineered as a system to exceed the rigorous demands of even the most extreme forms of racing but is also at home on the street! Don't settle for good enough. Go UltraPro!

**PTFE
INSIDE!**

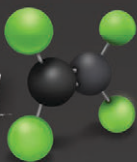

ULTRAPRO SERIES

HIGH PERFORMANCE FLUID TRANSFER SYSTEM

HOSE-ENDS W/ O-RING PORT & HOSE-ENDS W/ WIGGINS CONNECTORS



- Available Dynamic Swivel™ technology used in selected hose-ends allows 360 degrees of rotation of installed line after installation!
- Internal seals are a fluoroelastomer material which is resistant to all known fuel, oil and coolant!
- Bent tube design for unmatched strength and flow!
- UltraPro bent tube hose-ends are Dip-brazed for a permanent and robust bond!
- Designed to withstand harsh environments, brutal vibration, high flow requirements and extreme pressures!
- Black Anodized
- Assembled with an olive that threads onto the double-helix ribbed inner liner of the hose for positive engagement and retention of the hose-ends!
- High stress components are made of high-strength 2024-T8 grade aluminum instead of 6061-T6 aluminum used by competitors!
- Available in Twist-on and Crimp-on styles for more plumbing options at home or at the track!
- SAE port, jump size, and Wiggins connector adapter/hose-ends available
- Straight, 30°, 45°, 60°, 90°, 120°, 150°, and 180° angles available



VAPOR GUARD HOSE AND HOSE ENDS

STOP FUEL VAPORS & FUEL WEeping TODAY!

- Alleviates permeation issue prominent in traditional neoprene & rubber fuel hoses
- Easy to use push-on style hose and fittings, plumbs most fuel systems within minutes
- A rubber hose that will hold up to the corrosive properties of modern day fuels, including E85
- High quality looks with AN style hose ends and adapters



SWIVEL-SEAL & AUTO-FIT REPLACEMENT SOCKETS

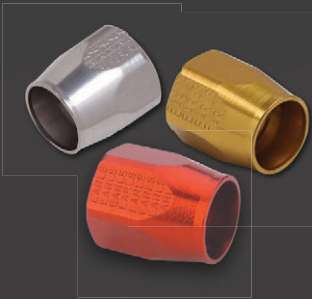

- Aluminum Construction
- Available from -4 to -24 sizes
- Intended for Auto-Flex, Perform-O-Flex, Pro-Lite 350, Pro-Lite Ultra hoses
- Used when sockets are damaged or worn
- When need to reuse hose end
- Available in black, red, pewter and gold anodized finishes

CUSTOM LOOK FOR SWIVEL-SEAL & AUTO-FIT!



ELECTRIC FUEL PUMPS & REGULATORS

- Options for all budgets & performance levels
 - For EFI & Carburetors
- Billet or Die cast construction
- AN O-Ring or NPT ports
- Intended for Truck/SUV/Jeep, drag racing, muscle car, off-road, street, street rod, diesel, modern muscle, autocross, sport compact / import



HIGH QUALITY & RELIABILITY YOU CAN COUNT ON!



FLAME GUARD - BLACK

- Now available in black
- Plain w/o logo
- Non-asbestos
- Sold by the foot, or in precut 3' & 10' lengths

INSULATE YOUR HOSES FROM EXTREME HEAT SOURCES!

NOW AVAILABLE IN BLACK!



SPIN-ON OIL FILTER ADAPTERS FOR LS ENGINES

- Economical way to relocate oil filter
- 1/2" NPT female ports
- Cast aluminum
- O-Ring seals
- Fits GM LS & LT engines



1130ERL



1131ERL



OIL FILTER ADAPTER FOR 5.0L FORD COYOTE ENGINES

- 10 AN O-Ring ports
- Replaces oil filter housing
- Must be used w/ remote filter housing - Ideal for Use w/ 2077ERL (or similar)
- Billet aluminum w/ black anodized finish
- Includes stainless hardware
- O-Ring seals (no gasket required)



1125ERL

IMPROVED CLEARANCE ON YOUR FORD ENGINE SWAPS!



BILLET REMOTE OIL FILTER MOUNT W/ DUAL INLETS

- Billet aluminum
- 3/4" -16 oil filter (fits Fram PH8A or HP1 Oil Filters)
- (4) 10 AN O-Ring Ports
- 2-Bolt mounting
- Inlet & outlet ports on both sides for easy routing of hoses
- 1/8" NPT port

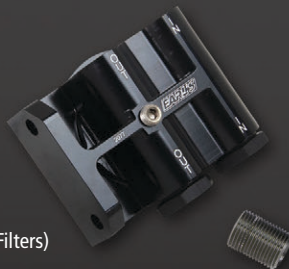

EASY PLUMBING FROM EITHER SIDE!



SPEED-FLEX HOSE W/ BLACK PVC COATING

- Use of extruded PTFE
- Stainless outer braid w/ PVC coating
- Solves pedal travel problem
- Increased brake pedal firmness
- Modulate brakes efficiently
- Improved abrasion resistance
- Easy to cut and assemble
- Use with Speed-Seal hose ends only

NOW AVAILABLE IN BLACK!



LS STEAM TUBE KITS W/ HOSE & ADAPTERS

- Seals to engine with captured FMK O-ring
- Adjustable fitting and hose plumbing path
- Upsized from OE tube sizing to -3 or -4 AN
- Can be used for front only or front/rear applications

**ELIMINATES TRAPPED
AIR, HOT SPOTS AND
OVERHEATING!**



STAINLESS STEEL HARDLINE TUBING

- Available from 3/16" through 5/8" sizes
- Annealed 304 Stainless Steel tubing
- Can be polished for a custom look
- Easily formed w/ tools
- For virtually any requirement
- Easy to form in single or double flare (double flare requires high quality forming tool)
- Shipped in straight lengths only



**IDEAL FOR PRECISE
PLUMBING SYSTEMS!**



STEEL & EASY-FORM (COPPER/NICKEL) HARDLINE TUBING

- Sold in 25' Coils
- Kits include an assortment of tube nuts
- Tubing Sizes: 3/16", 1/4", 5/16", and 3/8"
- Steel tubing w/ Zinc or Olive PVF Coatings
- Available in zinc or olive coated
- Easy-Form is Copper/Nickel Alloy & will never rust or corrode
- Easy-Form is so easy to bend that a tubing bender isn't needed
- DOT approved for hydraulic brake systems
- Ideal for use on all automotive hardline applications





TEMPERATURE GAUGE ADAPTERS

- Billet aluminum
- Red anodized
- 3/8" NPT, 1/2" NPT, or 10 O-Ring port
- Fits temperature sensors w/ 5/8"-18 threads and tapered seat
- Ideal for use w/ most mechanical temperature gauges
- Lighter weight and more attractive than brass adapters



WORKS WITH MOST MECHANICAL TEMP GAUGES!



STAINLESS STEEL ADAPTERS

- Tube nuts & tube sleeves are ideal for use with stainless hardline tubing
- Strong, durable and corrosion free
- Complete stainless system when used with Stainless Auto-Fit or Stainless Speed Seal Hose Ends
- Ideal for marine use
- Can be polished for a custom show car appearance



COMPLETE STAINLESS SYSTEM WHEN USED WITH STAINLESS HOSE ENDS!



HOSE CUT-OFF MACHINE & REPLACEMENT BLADES

- Pre-wired for 115V AC (can be rewired for 230V AC)
- Motor: 1.5 HP
- Amperage: 18.6 Amps - Under full load
- Saw comes with scalloped blade
- OSHA approved
- 12" Wide x 21" Long x 12" Tall
- Designed for bench mounting

D100ERL



MAKES A TOUGH JOB QUICK & EASY!

D101ERL

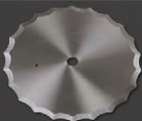

D102ERL



TUBING BENDERS

- Choose from mini or standard size benders
- Mini Bender works with 1/8", 3/16", and 1/4" tubing – Up to 90° Bends
- Standard Bender Works with 3/16", 1/4", 5/16", and 3/8" Tubing – Up to 180° Bends
- Black powder coated
- Works w/ steel, copper, and copper/nickel tubing
- Great value



ECONOMICAL HIGH QUALITY HARDLINE TOOLS!



DISTRIBUTION BLOCK

- 8AN O-ring inlet
- (3) 6AN o-ring outlets
- For various applications
- 1/8" NPT gauge outlet
- Fully CNC machined
- Anodized black

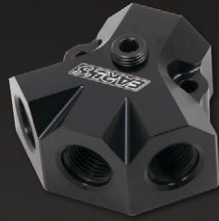

100168ERL



SUPER STOCK HOSE CLAMPS & PLIERS

- Lightweight stainless steel clamps
- Easy to install w/ special pliers
- Sold in packages of 5 pieces



EXTRA PROTECTION IN HIGH TEMP & HIGH PRESSURE APPLICATIONS!



-24 SINGLE-ENDED AN WRENCH

- Use w/ fittings and hose ends
- Short handles
- Use in cramped areas
- Discourages over-tightening
- New wrench size



230424ERL

NOW AVAILABLE IN A NEW SIZE!



-20 & -24 DOUBLE-ENDED AN WRENCHES

- Assembly easier than ever
- Color coded aluminum finish
- Assemble hose and hose ends
- New wrench sizes



230422ERL

NOW AVAILABLE IN NEW SIZE!



TUBING CUTTER W/ DEBURRING TOOL



003ERL

- Cuts 1/8" to 1-3/8" diameter tubing
- Smooth adjustment operation
- Includes deburring tool
- Yellow w/ Black handle
- Replaceable cutting wheel
- Cuts all types of tubing (steel, copper, copper/nickel, and stainless steel)

HIGH PERFORMANCE BLADE CUTS ALL TYPES OF TUBING!



AN ADJUSTABLE WRENCH

- Anodized black with steel nickel knurled adjustment wheel
- Curved lower jaw and chamfered nose for clearance in tight spots
- High quality 7075 billet aluminum w/ smooth operation of adjustment wheel



230400ERL

IDEAL FOR USE IN THE PITS, STAGING LANES OR BACK AT THE SHOP!



ULTRA-PRO HOSE EXPANDER KIT

The hose expander is the first step in the crimping process. This tool expands the ribbed inner liner in preparation for the hose-end barb to be inserted.

- Works with Ultra-Pro hose only
- Overall Dimensions: 16" Long x 2" Wide x 2-3/4" Tall
- Designed for bench mounting



600ERL

EASY ASSEMBLY OF CRIMPED-STYLE HOSE ENDS!



AN TRANSMISSION COOLER LINE ADAPTERS



- Nickel plated steel construction
- High pressure capabilities
- Available for any plumbing situation and many custom applications
- Available for the popular GM Transmissions

IMPROVED TUNNEL CLEARANCE ON LS SWAPS!



OIL COOLER ADAPTERS FOR GM LS & LT ENGINES



- Billet aluminum
- Black anodized
- O-Ring seals
- 10AN male connections
- Optional 180° thermostat & replacement 212° thermostat (Available separately)
- LT Truck engines require adapter plate (Available separately)
- Slim design clears most headers & other accessories
- Ideal for engine swaps & high heat applications

SLIM DESIGNS PROVIDES OPTIMAL HEADER CLEARANCE!

SNIPER

PUSH-ON HOSE

- Synthetic rubber w/ inner fiber braid
- Maximum working pressure 250 PSI
- Maximum working temperature 250°
- Minimum working temperature -40 °
- Suitable for use with diesel fuel, coolant, ATF, and oil
- Easy to cut & assemble
- Accepts Sniper push-on hose ends only
- Not for use w/ Earl's Super Stock hose ends



**QUALITY HOSE FOR
SNIPER HOSE ENDS!**



ALUMINUM WATER OUTLETS

- Includes thermostat housing, o-ring seal, plate and hardware for easy fit
- Available in chrome, black, and hand polished finish
- Available outlets: Straight, 15 degree, 45 degree, and 90 degree
- Easy add-on for your manifold
- Fits most early model V-8
- Lower cooling system temperatures for more power
- Muscle car, drag race, circle track applications



**ROTATES 360°
FOR A PERFECT
FIT!**



**CLASSIC
STYLING!**

NOSTALGIC BLOWER KITS

- 175-275+ Horsepower increases (6-71)
- 200-300+ Horsepower increases (8-71)
- Kits for Small and Big Block Chevrolet and 392 Hemi (6-71 only)
- Option of traditional 1/2" pitch (6-71 only) or 8mm belt drive
- Available polished or unpolished



FABRICATED OIL PAN KITS

Save time, money, and aggravation with these money-saving kits! Each kit packages everything you need to make changing an oil pan a breeze.

- 15 application specific offerings covering popular Chevy, Ford, and Dodge/Chrysler
- Increased oil capacity to keep high performance engine oil systems fed properly
- Pan finishes included black painted and gold irridite
- All kits include the following:
 - Oil Pan
 - Oil Pan Gasket
 - Oil Pan Mounting Bolts
 - Oil Pan Pick-up

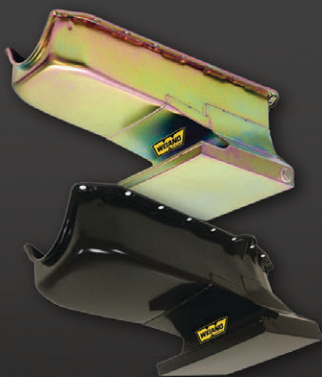



HEADERS & EXHAUST FOR TRUCKS, PERFORMANCE CARS & HOT RODS

Flowtech Headers are the perfect blend of quality and value. From postwar Hot Rods to modern-day performance cars and trucks, Flowtech offers one of the most complete lineups of products on the market. Flowtech has been busy designing many new products for popular applications. High Quality headers for a variety of applications at a great value!



New applications available for:

- Toyota Tundra/Supra/Tacoma
- Chevy Camaro/Corvette
- Chevy Silverado/GMC Sierra
- Ford F-150/Mustang
- Dodge Ram
- Jeep Wrangler/Cherokee

New Specialty Headers also available for:

- Block Huggers
- Lakester
- Demolition Derby/Truck Pulling

LATE MODEL EXHAUST AT A BUDGET-MINDED PRICE!



STAINLESS LS TURBO HEADERS

These "4 to 1" LS Turbo headers are an ideal design creating a compact package allowing a variety of configurations to be used as a universal fit Turbo header.



- CNC mandrel bent tubes
- Heavy-Duty 16-gauge stainless steel tubing
- 3" Collector for maximum strength and flow
- Extra thick 7/16" headers for a leak-free seal
- 3" V-Band flanges and clamps included
- Available in 1-3/4" and 1-7/8" tubing diameters
- Four finishes to choose from: natural, black painted, ceramic coated and polished



Hooker continues to push the boundaries of performance by expanding our line of premium BlackHeart exhaust and engine swap products. Our exhaust products for late model vehicles are designed to be an uncompromising performance upgrade to these cars right off the showroom floor. Our GM LS engine swap products include mounts, crossmembers, headers, and exhaust systems for a variety of vehicles. These platform specific products are engineered to work together to provide optimum driveline angles and fitment; while providing the customer with options for multiple transmission types, horsepower levels, and accessories. Whether you're planning to swap an LS into your 1st Gen Camaro, or looking for performance exhaust for your 2015 Mustang, you can rest assured that the BlackHeart line is engineered to provide maximum performance, ground clearance, and quality.



**NEW PREMIUM EXHAUST
FROM THE #1 BRAND
IN HEADERS - HOOKER!**

NEW APPLICATIONS:

- 1982-92 GM F-Body LS Swap Systems
- 1993-02 GM F-Body LS Swap Systems
- 1964-67 GM A-Body LS Swap Systems
- 1968-72 GM A-Body LS Swap Systems
- 1996-04 Ford Mustang LS Swap Systems
- 1996-04 Ford Mustang GT V8 Exhaust
- 1982-92 Camaro/Firebird V8 Exhaust
- 1993-02 Camaro/Firebird V8 Exhaust
- 2016 Camaro V6 Exhaust
- 2016 Camaro V8 Exhaust
- 2005-13 C6 & Z06 Corvette Exhaust
- 2014-16 C7 & Z06 Corvette Exhaust
- 2014-16 Challenger V8 Exhaust
- 2006-16 Charger V8 Exhaust
- 2005-16 Chrysler 300 V8 Exhaust
- 2005-08 Dodge Magnum V8 Exhaust
- 1991-06 Jeep Wrangler YJ/TJ Exhaust
- 2007-16 Jeep Wrangler JK Exhaust
- 1991-01 Jeep Cherokee XJ Exhaust
- 2007-13 Silverado/Sierra V8 Exhaust
- 2014-16 Silverado/Sierra V8 Exhaust
- 2009-10 Ford F-150 V8 Exhaust
- 2015-16 Ford F-150 Ecoboost Exhaust



LS TURBO EXHAUST MANIFOLDS



- Fits most common LS swap applications & components
- 3" V-Band Outlet – 2.25" crossover connections
- Heat shield to protect heater hoses
- Hardware included – Stainless steel V-bands
- Cast iron construction retains heat and is more durable than steel headers
- More components to come (cross over tubes, and turbo inlets w/ T4 flange)

**AN EASY WAY TO ADD
A TURBO TO YOUR
MUSCLE CAR!**

CATACLEAN

THE ORIGINAL

120009CAT



CATACLEAN FUEL AND EXHAUST SYSTEM CLEANER - 5L TRUCK/ FLEET/INDUSTRIAL AND 40Z. POWERSPORTS

- Easy to use – Simply, Pop, pour, and Go!
- Does not alter fuel composition
- Safe for gasoline/Diesel, and hybrid engines
- Lowers total Hydrocarbon emissions by up to 50%
- Reduces harmful carbon build-up on O₂ sensors
- Improves fuel efficiency
- Legal in all 50 States
- Patented Formula

120008CAT



FABRICATED VALVE COVERS



- 100% TIG welded construction
- Constructed of 6061 T5 aluminum
- 1-piece CNC billet flange for superior sealing
- Available in silver anodized or black coated finishes
- Applications available for popular GM, Ford, and Chrysler engines
- Available with or without breather provisions
- Standard height and tall height available for valvetrain clearance
- Include mounting hardware

PERFORMANCE SHEET METAL LOOK AT A BUDGET-MINDED PRICE!



PREMIUM OVERHAUL GASKET & COMPLETE GASKET SETS W/ MLS HEAD GASKETS



- Designed for maximum sealing of bi-metal (cast iron block/aluminum cylinder head) engines
- Multi-Layered Steel (MLS) cylinder head gaskets
- Ultra-Seal III intake manifold, timing cover, water pump and fuel pump gaskets
- Molded rubber with steel carrier valve cover gaskets
- Remainder of gaskets and seals are high quality Mr.Gasket gaskets!
- For OE replacement, high performance street, drag race and oval track use

MANY APPLICATIONS AVAILABLE!



PRESSURE MASTER HEADER GASKETS

- Reusable/Adaptable
- Graphite foil sealing inserts
- Virtually leakproof
- Seals up to 1200% better
- Superior torque retention
- Longer lasting pre-load
- 90% break loose torque

**AEROSPACE SEALING
TECHNOLOGY
FOR YOUR HIGH
PERFORMANCE ENGINE!**



CHROME MECHANICAL WATER PUMPS

- Lightweight aluminum construction, CNC machined finish
- CNC machined aluminum impeller
- Heavy duty shaft with 5/8" pilot
- Available in Small Block and Big Block Chevy applications in both short and long style
- Pulley hub has two mounting bolt patterns (early/ late models) incorporated 2-1/8" x 2-3/16" and 1-7/8" x 1-13/16"
- High quality chrome plated finish
- Mounting gaskets included

**GREAT FOR STREET
PERFORMANCE &
STREET RODS!**



ELECTRIC WATER PUMPS

- Applications available in cast and billet aluminum housings
- Black and polished finishes available
- Cast housings rated at 35GPM
- Billet housings rated at 40GPM
- Free up lost horsepower from use of mechanical water pumps
- Custom Mr. Gasket or Frostbite on housing for that performance look
- Pumps come complete with gaskets, wiring pigtails, and mounting hardware
- Ford applications available with block off plate
- Applications Available for the following engines:
 - Small Block Chevy
 - Small Block Ford
 - Big Block Chevy
 - Big Block Ford
 - Ford 351C/351M/400M
 - Holden



MECHANICAL FUEL PUMPS



- Flows 80-110 GPH free flow depending on pump model
- Shutoff pressure is factory set from 6.5 to 8 psi
- Fuel pressure regulator is not required due to built-in shutoff
- Heavy duty construction for continuous high rpm operation
- Lower pump body can be clocked in different positions to tailor to your specific orientation needs
- Street fuel pump 80 GPH - inlet & outlet accept 1/4" NPT fittings
- High Output fuel pump 110 GPH - inlet & outlet accept 3/8" NPT fittings



GRIP OF A RACE CLUTCH, PEDAL FEEL OF A STREET CLUTCH!

DRAGON CLAW PERFORMANCE CLUTCHES

- Patented lever assist technology allows clutch to have increased torque holding capacity while maintaining a near stock pedal feel – Proven to hold for turbo and supercharged vehicles with up to 1150 lb.-ft. torque
- Kits come complete with flywheel, alignment tool and hardware ensuring properly matched components and ease of installation
- Light weight construction – Cover is forged from 7075 T6 aircraft grade aluminum; flywheel is forged from 6061 T6 aircraft grade aluminum; complete 2 disc assembly weighs as little as 35 lbs
- Proprietary ceramic friction material is both streetable and aggressive when necessary
- Sprung hub disc centers allow for smooth engagement, less gear lash, and longer transmission life
- No break in period – Install the clutch and drive it!
- 100% American made



PERFORMANCE FLEXPLATES

Hays performance flexplates are constructed from certified billet material to withstand the stress high RPM and severe punishment of racing.

- Built to withstand the stress of high-stall torque converters and quick revving high-RPM engines
- Ring gear welded securely in place
- All flywheels are S.F.I 29.1 certified
- Dual bolt pattern for use with multiple style converters
- Popular applications available in internal and external balanced versions

NEW APPLICATIONS AVAILABLE!



NEW APPLICATIONS AVAILABLE!

PERFORMANCE FLYWHEELS

- SFI-approved – legal for use in racing classes that require SFI certification
- Choose precision CNC-machined 1045 billet steel for maximum strength and durability or 6061-T6 billet aluminum construction for weight reduction and excellent heat dissipation
- Aluminum flywheels feature forged heat treated steel ring gears and replaceable 1045 steel friction surface attached with high-grade fasteners
- CAD designed to provide optimum performance and reliability
- Available in Internal, External, or Zero (Neutral) balanced versions
- Applications offered for a wide variety of engines



BELL HOUSINGS & FLEXPLATES

- Twice the strength of other steel bell housings, with pinpoint dimensional accuracy and stability that obsoletes lesser models made from rolled or stamped steel
- The engine and transmission always stay in alignment through the entire rpm range, eliminating accelerated drivetrain wear caused by bellhousing flex
- Flexplates are quality constructed, built for higher RPM's, zinc plated, factory balanced, double welded & SFI 29.1 Certified

ADAPT ANY ENGINE TO ANY TRANSMISSION!

NEW APPLICATIONS AVAILABLE!



WHEN IT COMES TO KEEPING YOUR RIDE COOL, MAKE IT FROSTBITE!

FROSTBITE ALUMINUM RADIATORS

- 100% TIG welded (Braze) seams
- Aircraft quality aluminum core, fittings, and tanks (Up to 30% weight savings)
- Billet aluminum filler neck & OEM style brass petcock
- More cooling fins per inch for more efficient cooling
- Custom Frostbite high performance 16lb. billet radiator cap
- Polished top and tanks for custom show appearance
- Supporting 1000+ horsepower
- Available for Chevy, Ford, Dodge/Chrysler/Jeep & LS swap applications!





105MM GM LS W/ 4-BOLT THROTTLE BODY



05173NOS

- For use with larger than stock throttle bodies
- Ideal for use with the MSD Atomic LS manifold
- Supports up to 200 HP
- Includes jetting for 100, 125 & 150HP
- Includes an "NOS Blue" 10 lb. nitrous bottle and brackets
- Also available as a "Plate Only" kit; p/n 13437NOS



2010-2014 CAMARO PLATE KIT



05160NOS

INCLUDES AN NOS PROGRESSIVE CONTROLLER!

- For use on the LS3 V8 engine
- Provides exceptionally smooth power delivery
- Single plate between the throttle body and manifold
- Throttle body mounts in stock orientation
- Supports up to 250 RWHP
- Included jetting for 75, 100, 125 & 150 RWHP (Rear Wheel Horse Power)
- New plate outlet design to maximize distribution
- Includes an "NOS Blue" 10 lb. nitrous bottle and brackets
- Also available as a "Plate Only" kit; p/n 13436NOS



STAINLESS & TITANIUM NITROUS FOGGER NOZZLES



DRY NITROUS NOZZLES

Fogger SS1 - 13691NOS

- 1 Stage Dry Nozzle
- Stainless steel construction
- 1/16" NPT Thread
- Stainless steel jet holder

Fogger Ti2 - 13682NOS

- 2 Stage Dry Nozzle
- Titanium construction
- Light as aluminum
- Strong as steel
- 1/16" NPT Thread
- Stainless steel jet holders

Fogger Ti3 - 13683NOS

- 3 Stage Dry Nozzle
- Titanium construction
- Light as aluminum
- Strong as steel
- 1/16" NPT Thread
- Stainless steel jet holders



5 PORT DISTRIBUTION BLOCK

- 6061 Aluminum construction
- 5 x 1/8" NPT ports
- Designed to work with the Fogger 3 Stage Nozzle



16716NOS



SHOWERHEAD DISTRIBUTION BLOCKS

- 6061 Aluminum Construction
- 1 x 3/8" NPT inlet to 4 x 1/8" NPT outlet
- Parallel inlet/outlets for a low profile design
- Profiled internal passages to maximize flow
- Compact size
- Light weight



16752NOS

- 16751NOS – Black showerhead w/o fittings
- 16752NOS – Black showerhead w/ fittings
- 16753NOS – Blue showerhead w/o fittings
- 16754NOS – Blue showerhead w/ fittings



ULTRA HIGH FLOW RACE SOLENOID

- Low 5A current draw
- .25" orifice size
- Supports 700+ HP
- Lightweight 6061 aluminum base
- Not intended for use with progressive controllers



18070NOS



FUEL SOLENOID

- Supports up to 400HP
- .156" orifice size
- 2.8A current draw at 12vdc



18087NOS

NITROUS SOLENOID

- Supports up to 250HP
- .094" orifice size
- 8A current draw at 12vdc



18018NOS



SOLID STATE RELAY

- Ultra-Quick activation (<20uS)
- High current capacity (40 Amp)
- Small size
- Lightweight
- Simple 3 wire connection



15620NOS



250-DS-IQ3S

- Standard data, such as speed, odometer, turn signals, hi/low beam and parking brake indicators are displayed, along with programmable shift and warning lights

IQ3S STREET DASH

- Displays standard road functions
- User defined shift light output
- Displays up to 28 inputs via 4 pages
- Shielded, low luster display for sunlight viewing
- Blue dimmable backlight
- Metric and Imperial capable
- Gear Indicator
- CAN-based and OBD2 compatible (adapter cables available)
- Four user defined alarms
- Connect to any Racepak V-Net data logger
- User defined 5 character sensor input names
- Optional GPS module for speed



230-VM-DASHAPP

V-NET DASH APP MODULE

The Bluetooth module and virtual dash app turns any Android or IOS tablet or phone into an on-the-fly display by streaming data directly from any Racepak data recorder or digital dash. The Racepak Bluetooth V-Net module can be added to any Racepak V-Net system, and after downloading the Racepak Bluetooth App, data can be streamed instantly. The display is based on the popular Racepak IQ3 dash display, and like the IQ3, it features four pages of display that can be swiped left or right to view. Each page shows six user-definable data channels, with programmable warnings. Ipad or similar device not included.



230-VM-EFIUCAN

UNIVERSAL CAN ECU INTERFACE MODULE

The new Universal CAN ECU Interface Module from Racepak streams CAN-based data from aftermarket ECU systems to any Racepak data logger or dash display. This gives the ability to monitor all of the data available from the ECU. Compatible ECU systems include MSD, Holley, AEM, FAST, Haltech, Bigstuff3 and more. An additional adapter cable would be required to connect the 230-VM-EFIUCAN to the ECU.



220-VP-HRS

V-NET HEART RATE SENSOR MODULE

The V-Net Heart Rate Sensor Module gives you the ability to monitor and record the driver's heart rate during a run. The armband containing the heart rate sensor is worn by the driver and connects to the Heart Rate Sensor Module via Bluetooth.

- Heart rate sensor module
- Heart rate armband
- USB armband charger