

OEM[®]
Tools for Professionals

9 Pc. Oil Filter Cap Wrench Set MANUAL

1. APPLICATION

2. OPERATION INSTRUCTIONS

- Set contains 9 cap style wrenches.
- 3 Forged low profile sockets wrenches included:
27 mm, 32 mm and 36 mm sizes.
- 4 High quality, chrome plated aluminum wrenches that fit OE canister filter design caps like a glove, 1 adjustable, 63 mm to 83 mm sizes and a filter wrench for universal applications.
- All wrenches are designed to work with 3/8" square drive tools.
- Intended for hand application only. Not for impact use.



NO.5 (16 Flutes x 86.6mm x 3/8" DR)

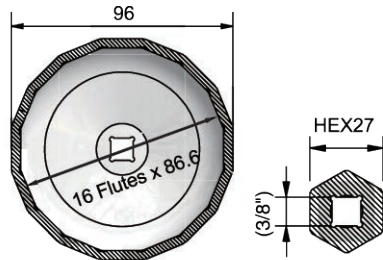
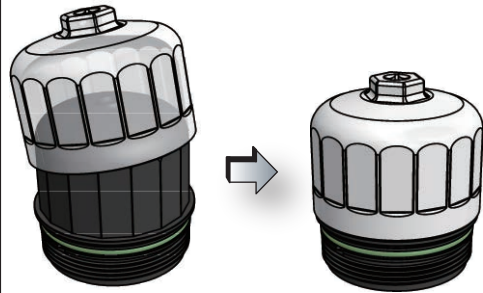

NO.6 (Application range: 63mm~83mm)

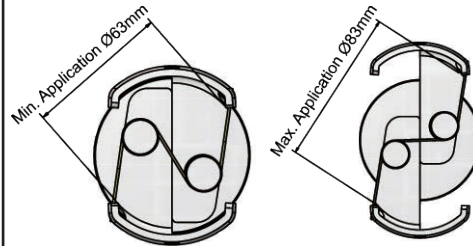

NO.7 (3/8" DR-27mm)

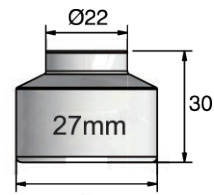

NO.8 (3/8" DR-32mm)

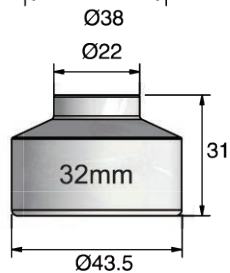

NO.9 (3/8" DR-36mm)

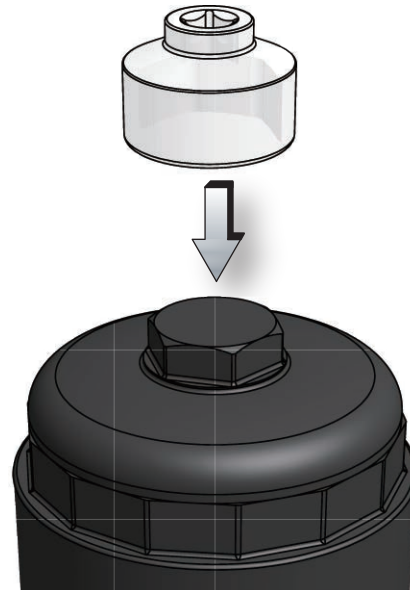
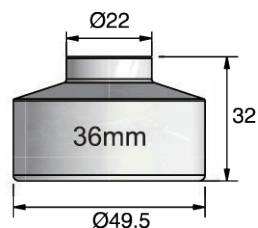

1. APPLICATION

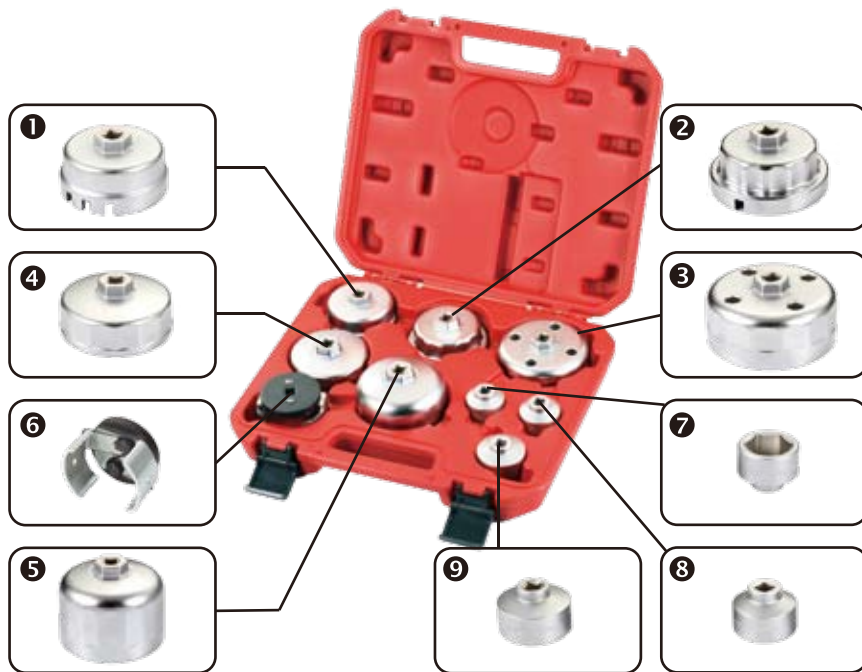

No.	Flutes	Size	DR	Material	Surface Finish	Application
1.	14	64.5mm	3/8"	Aluminum	Chrome	Toyota :Allion, Auris,Corolla axio,Corolla fielder,Corolla rumion,Isis Ist,Noah,Premio,Prius,Voxy,Wish
2.	14	64.5mm	3/8"	Aluminum	Chrome	Toyota 2007-2008 V6 (2006)-all of Vehicles Lexus (2007-)ES350 · GS350 · GS450h · LS460 · RX350 (2008-)LS600h L
3.	15	88.8mm	3/8"	Aluminum	Chrome	Available for Hyundai/Kia
4.	14	74.2mm	3/8"	Aluminum	Chrome	Audi · BMW · Ford · Mazda · Toyota · Volkswagen · Porsche Mercedes(All models with V6 and V8)
5.	16	86.6mm	3/8"	Aluminum	Chrome	BMW · 335i 3.0L Twin Turbo BMW · 535i 3.0L Twin Turbo BMW · BMW 3 Series (E90) BMW · X6 3.0L Twin Turbo Volvo - All Models(1999 - 2006)(exc. 2005 40 & 50 Series)
6.		83mm-83mm	3/8"	SCM440	Galvanized	Universal oil filter wrench:83mm-83mm
7.	6	27mm	3/8"	S45C	Nickel-plating	Mercedes and smart car
8.	6	32mm	3/8"	S45C	Nickel-plating	GM · Opel/Vauxhall 4 cyl. GM 2.2liter ecotech X10XE · X12XE · Y17DT · Y17DTL engines. Mercedes HGV'S e.g. OM364 · OM366 engines.
9.	6	38mm	3/8"	S45C	Nickel-plating	Mercedes diesel engines OM604,OM605,OM606 BMW engines M52 6-cyl,M60 8 cyl,M70 12-cyl Mini One /Copper/Coppers Ford 6.0 liter diesel engine(predominantly used in pickups) VW VR6 engine.

2. OPERATION INSTRUCTION

NO.1 (14 Flutes x 64.5mm x 3/8" DR)

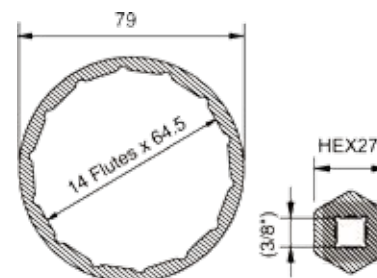

NO.2 (14 Flutes x 64.5mm x 3/8" DR)

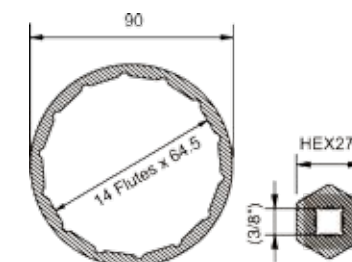
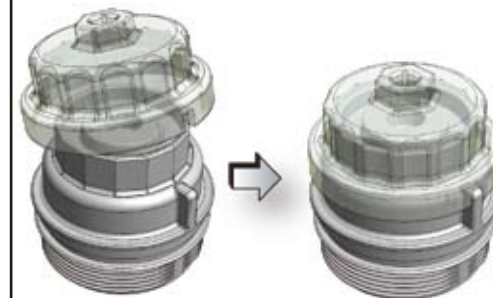

NO.3 (15 Flutes x 88.8mm x 3/8" DR)

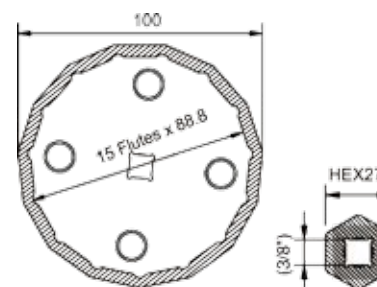

NO.4 (14 Flutes x 74.2mm x 3/8" DR)

