

O-RING

121228



Description: O-RING
SKU: 121228
OEM: 3049221
Product Group: ENGINE PARTS
Product Class: WATER PUMPS & PARTS, PULLEYS
UPC Code: 193807089139
Sell Pack: 10 EA
 (Available to buy in increments of 10)
Weight: 0.03 LBS
Warranty: 2 Years



Details:
 O-Ring
 0.139 in C/S x 1.109 in ID
 3.53 mm C/S x 28.17 mm ID
 Buna N 75, Peroxide Cured / Black Series # -216

Substitute:

SKU	Sell Pack	Weight	Warranty	Description
EGA-0420	10	0.02 LBS	2 Years	O-RING

E-Catalog Pages:

Catalog Page	Description
	O-Rings AS568A

Copyright © 2020 PAI Industries, Inc.
 All rights reserved. All content is property of PAI Industries, Inc, and may not be reproduced or redistributed in any form.

Any reference to OEM names or OEM product identification numbers/descriptions/model numbers is for identification only and does not indicate that it is an OEM part. PAI is not affiliated with Mack Truck, Inc.®, Volvo®, Fuller®, Cummins®, Eaton®, Rockwell®, Caterpillar®, Freightliner®, Hendrickson®, Kenworth®, Detroit Diesel®, International®, Peterbilt®, or Dana®. All Manufacturer's names, numbers, symbols and descriptions are used for reference only. It is not implied that any part listed is the product of these manufacturers.

O-RING

121228

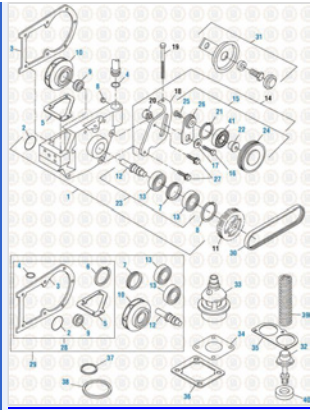

Cummins Engine 2017
With Idler - 88NT - 855 Series

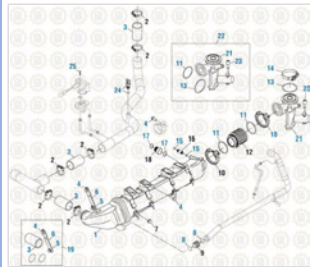

Cummins Engine 2017
EGR Cooler - ISX Series

Component Of:





SKU	Image	Description
131328-201		O-RING KIT
131338		LOWER GASKET KIT
131640		LOWER GASKET KIT

Copyright © 2020 PAI Industries, Inc.
All rights reserved. All content is property of PAI Industries, Inc. and may not be reproduced or redistributed in any form.

Any reference to OEM names or OEM product identification numbers/descriptions/model numbers is for identification only and does not indicate that it is an OEM part. PAI is not affiliated with Mack Truck, Inc.®, Volvo®, Fuller®, Cummins®, Eaton®, Rockwell®, Caterpillar®, Freightliner®, Hendrickson®, Kenworth®, Detroit Diesel®, International®, Peterbilt®, or Dana®. All Manufacturer's names, numbers, symbols and descriptions are used for reference only. It is not implied that any part listed is the product of these manufacturers.

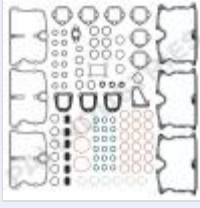
O-RING

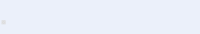
121228

131679		UPPER GASKET KIT
131874		UPPER GASKET KIT
132023		GASKET COOLER KIT
141449		MAJOR INSTALLATION KIT
181808		WATER PUMP
181848		WATER PUMP REPAIR KIT

Cross Reference:	
Manufacturer	OEM Number
CUMMINS	3049221

Copyright © 2020 PAI Industries, Inc.
 All rights reserved. All content is property of PAI Industries, Inc. and may not be reproduced or redistributed in any form.

Any reference to OEM names or OEM product identification numbers/descriptions/model numbers is for identification only and does not indicate that it is an OEM part. PAI is not affiliated with Mack Truck, Inc.®, Volvo®, Fuller®, Cummins®, Eaton®, Rockwell®, Caterpillar®, Freightliner®, Hendrickson®, Kenworth®, Detroit Diesel®, International®, Peterbilt®, or Dana®. All Manufacturer's names, numbers, symbols and descriptions are used for reference only. It is not implied that any part listed is the product of these manufacturers.