

# OIL RETURN GASKET

131480



**Description:** OIL RETURN GASKET  
**SKU:** 131480  
**OEM:** 3937706  
**Product Group:** ENGINE PARTS  
**Product Class:** ENGINE GASKETS, O-RINGS & GASKET SETS  
**UPC Code:** 193807136741  
**Sell Pack:** 10 EA  
 (Available to buy in increments of 10)  
**Weight:** 0.03 LBS  
**Warranty:** 2 Years



**Details:**

Oil Return Gasket  
 CumminsL10 / M11 / ISM Series application

**E-Catalog Pages:**

Catalog Page	Description
	<p><b>Cummins Engine 2017</b>                      Miscellaneous Gaskets - 4B Series</p>

**Copyright © 2020 PAI Industries, Inc.**  
 All rights reserved. All content is property of PAI Industries, Inc. and may not be reproduced or redistributed in any form.

Any reference to OEM names or OEM product identification numbers/descriptions/model numbers is for identification only and does not indicate that it is an OEM part. PAI is not affiliated with Mack Truck, Inc.®, Volvo®, Fuller®, Cummins®, Eaton®, Rockwell®, Caterpillar®, Freightliner®, Hendrickson®, Kenworth®, Detroit Diesel®, International®, Peterbilt®, or Dana®. All Manufacturer's names, numbers, symbols and descriptions are used for reference only. It is not implied that any part listed is the product of these manufacturers.

## OIL RETURN GASKET

131480



**Cummins Engine 2017**  
Turbocharger - 4B Series

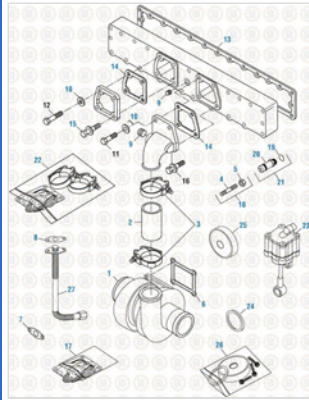

**Cummins Engine 2017**  
Turbochargers - L10 / M11 / ISM Series

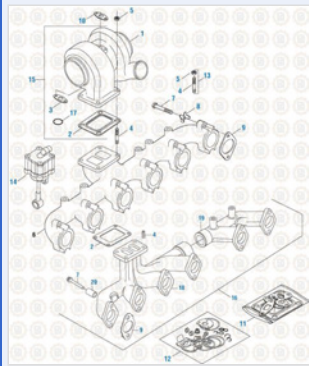

**Cummins Engine 2017**  
Turbocharger and Exhaust Manifold - 6C / ISC / ISL Series

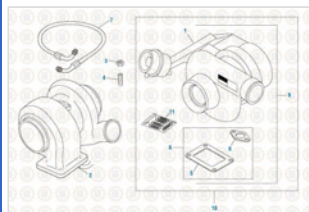

**Cummins Engine 2017**  
Turbocharger - 6B Series

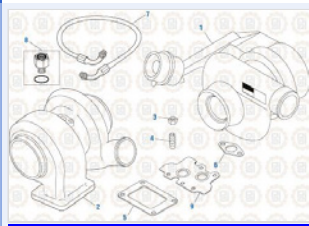





**Cummins Engine 2017**  
Turbocharger - ISB / QSB Series

Copyright © 2020 PAI Industries, Inc.  
All rights reserved. All content is property of PAI Industries, Inc, and may not be reproduced or redistributed in any form.

Any reference to OEM names or OEM product identification numbers/descriptions/model numbers is for identification only and does not indicate that it is an OEM part. PAI is not affiliated with Mack Truck, Inc.®, Volvo®, Fuller®, Cummins®, Eaton®, Rockwell®, Caterpillar®, Freightliner®, Hendrickson®, Kenworth®, Detroit Diesel®, International®, Peterbilt®, or Dana®. All Manufacturer's names, numbers, symbols and descriptions are used for reference only. It is not implied that any part listed is the product of these manufacturers.

# OIL RETURN GASKET

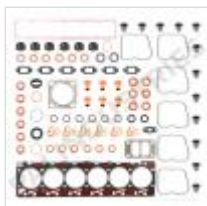
131480





Component Of:		
SKU	Image	Description
<a href="#">131265</a>		UPPER GASKET SET
<a href="#">131265-100</a>	-	UPPER GASKET KIT
<a href="#">131404</a>		UPPER GASKET KIT
<a href="#">131482-100</a>		UPPER GASKET KIT
<a href="#">131482-154</a>	-	OIL GASKET KIT
<a href="#">131566-300</a>	-	GASKET KIT
<a href="#">131601</a>		UPPER GASKET KIT
<a href="#">131602</a>	-	UPPER GASKET KIT
<a href="#">131609</a>	-	UPPER GASKET KIT
<a href="#">131613</a>	-	UPPER GASKET KIT
<a href="#">131635</a>	-	UPPER GASKET KIT
<a href="#">131684</a>		UPPER GASKET SET
<a href="#">131687</a>	-	UPPER GASKET KIT

Copyright © 2020 PAI Industries, Inc.  
 All rights reserved. All content is property of PAI Industries, Inc. and may not be reproduced or redistributed in any form.

Any reference to OEM names or OEM product identification numbers/descriptions/model numbers is for identification only and does not indicate that it is an OEM part. PAI is not affiliated with Mack Truck, Inc.®, Volvo®, Fuller®, Cummins®, Eaton®, Rockwell®, Caterpillar®, Freightliner®, Hendrickson®, Kenworth®, Detroit Diesel®, International®, Peterbilt®, or Dana®. All Manufacturer's names, numbers, symbols and descriptions are used for reference only. It is not implied that any part listed is the product of these manufacturers.

# OIL RETURN GASKET

131480









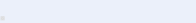

<a href="#">131688</a>		UPPER GASKET KIT
<a href="#">131721</a>		UPPER GASKET SET
<a href="#">131730</a>		UPPER GASKET KIT
<a href="#">131731</a>		UPPER GASKET SET
<a href="#">131741</a>		UPPER GASKET KIT
<a href="#">131743</a>		UPPER GASKET KIT
<a href="#">131809</a>		UPPER GASKET KIT
<a href="#">131814</a>		UPPER GASKET KIT
<a href="#">131874</a>		UPPER GASKET KIT
<a href="#">131881</a>		UPPER GASKET KIT
<a href="#">131883</a>		UPPER GASKET KIT
<a href="#">131888</a>		UPPER GASKET KIT
<a href="#">131906</a>		UPPER GASKET KIT
<a href="#">131953</a>		NATURAL GAS UPPER GASKET KIT
<a href="#">131954</a>		NATURAL GAS UPPER GASKET KIT
<a href="#">132048</a>		UPPER GASKET KIT

Copyright © 2020 PAI Industries, Inc.  
 All rights reserved. All content is property of PAI Industries, Inc. and may not be reproduced or redistributed in any form.

Any reference to OEM names or OEM product identification numbers/descriptions/model numbers is for identification only and does not indicate that it is an OEM part. PAI is not affiliated with Mack Truck, Inc.®, Volvo®, Fuller®, Cummins®, Eaton®, Rockwell®, Caterpillar®, Freightliner®, Hendrickson®, Kenworth®, Detroit Diesel®, International®, Peterbilt®, or Dana®. All Manufacturer's names, numbers, symbols and descriptions are used for reference only. It is not implied that any part listed is the product of these manufacturers.

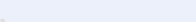
# OIL RETURN GASKET

131480

<p><a href="#">132050</a></p>		<p>TURBOCHARGER GASKET KIT</p>
<p><a href="#">181023</a></p>		<p>EXHAUST MANIFOLD KIT</p>
<p><a href="#">181174</a></p>		<p>TURBOCHARGER KIT</p>
<p><a href="#">181174E</a></p>		<p>TURBOCHARGER KIT</p>
<p><a href="#">181194E</a></p>		<p>TURBOCHARGER</p>
<p><a href="#">181200E</a></p>		<p>TURBOCHARGER</p>
<p><a href="#">EKT-2651</a></p>		<p>INSTALLATION KIT</p>
<p><a href="#">EKT-2663</a></p>		<p>MOUNTING KIT</p>
<p><a href="#">EKT-2668</a></p>		<p>TURBOCHARGER KIT</p>
<p><a href="#">EGK-9266</a></p>		<p>GASKET KIT</p>

Copyright © 2020 PAI Industries, Inc.  
 All rights reserved. All content is property of PAI Industries, Inc. and may not be reproduced or redistributed in any form.

Any reference to OEM names or OEM product identification numbers/descriptions/model numbers is for identification only and does not indicate that it is an OEM part. PAI is not affiliated with Mack Truck, Inc.®, Volvo®, Fuller®, Cummins®, Eaton®, Rockwell®, Caterpillar®, Freightliner®, Hendrickson®, Kenworth®, Detroit Diesel®, International®, Peterbilt®, or Dana®. All Manufacturer's names, numbers, symbols and descriptions are used for reference only. It is not implied that any part listed is the product of these manufacturers.

## OIL RETURN GASKET

131480

[821019](#)

O-RING AND GASKET KIT

[831101](#)

EXHAUST GASKET KIT

[831105](#)

LOWER GASKET KIT

[842026](#)

EGR CLAMP KIT

## Cross Reference:

Manufacturer	OEM Number
CUMMINS	3282113
CUMMINS	3285747
CUMMINS	3928919
CUMMINS	3931350
CUMMINS	3937706
CUMMINS	5264570
CUMMINS	3914388
CUMMINS	3911805
CUMMINS	3819378
CUMMINS	3942725
CUMMINS	3519807
MACK	420643
CUMMINS	5264569
VOLVO	420643

Copyright © 2020 PAI Industries, Inc.

All rights reserved. All content is property of PAI Industries, Inc. and may not be reproduced or redistributed in any form.

Any reference to OEM names or OEM product identification numbers/descriptions/model numbers is for identification only and does not indicate that it is an OEM part. PAI is not affiliated with Mack Truck, Inc.®, Volvo®, Fuller®, Cummins®, Eaton®, Rockwell®, Caterpillar®, Freightliner®, Hendrickson®, Kenworth®, Detroit Diesel®, International®, Peterbilt®, or Dana®. All Manufacturer's names, numbers, symbols and descriptions are used for reference only. It is not implied that any part listed is the product of these manufacturers.