

OIL RETURN GASKET

131494



Description: OIL RETURN GASKET
SKU: 131494
OEM: 3899343
Product Group: ENGINE PARTS
Product Class: ENGINE GASKETS, O-RINGS & GASKET SETS
UPC Code: 193807136888
Sell Pack: 5 EA
 (Available to buy in increments of 5)
Weight: 0.05 LBS
Warranty: 2 Years



Details:

Oil Return Gasket
 Cummins L10 / M11 / ISM Series application

Substitute:

SKU	Sell Pack	Weight	Warranty	Description
431247	5	0.01 LBS	2 Years	TURBOCHARGER DRAIN GASKET

E-Catalog Pages:

Catalog Page	Description

Copyright © 2020 PAI Industries, Inc.
 All rights reserved. All content is property of PAI Industries, Inc, and may not be reproduced or redistributed in any form.



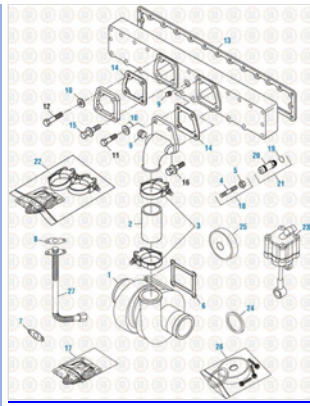

Any reference to OEM names or OEM product identification numbers/descriptions/model numbers is for identification only and does not indicate that it is an OEM part. PAI is not affiliated with Mack Truck, Inc.®, Volvo®, Fuller®, Cummins®, Eaton®, Rockwell®, Caterpillar®, Freightliner®, Hendrickson®, Kenworth®, Detroit Diesel®, International®, Peterbilt®, or Dana®. All Manufacturer's names, numbers, symbols and descriptions are used for reference only. It is not implied that any part listed is the product of these manufacturers.

OIL RETURN GASKET

131494

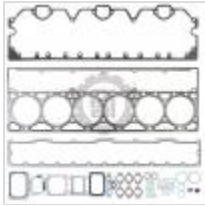

Cummins Engine 2017
Turbochargers - L10 / M11 / ISM Series

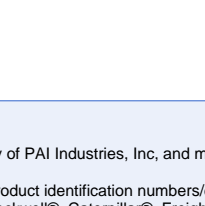
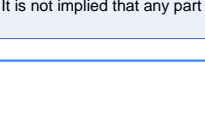
Component Of:		
SKU	Image	Description
131482-100		UPPER GASKET KIT
131482-154		OIL GASKET KIT
131637		UPPER GASKET KIT
131638-152		TURBOCHARGER GASKET KIT
131888		UPPER GASKET KIT
132057		UPPER GASKET KIT

Copyright © 2020 PAI Industries, Inc.
All rights reserved. All content is property of PAI Industries, Inc. and may not be reproduced or redistributed in any form.

Any reference to OEM names or OEM product identification numbers/descriptions/model numbers is for identification only and does not indicate that it is an OEM part. PAI is not affiliated with Mack Truck, Inc.®, Volvo®, Fuller®, Cummins®, Eaton®, Rockwell®, Caterpillar®, Freightliner®, Hendrickson®, Kenworth®, Detroit Diesel®, International®, Peterbilt®, or Dana®. All Manufacturer's names, numbers, symbols and descriptions are used for reference only. It is not implied that any part listed is the product of these manufacturers.

OIL RETURN GASKET

131494

[181199](#)



TURBOCHARGER KIT

[181200E](#)



TURBOCHARGER

[631250-152](#)



TURBO INSTALLATION KIT

[631251-150](#)

HEAD GASKET SUB KIT

[631275-152](#)

TURBOCHARGER MOUNTING KIT

[631309](#)



HEAD GASKET KIT

[631315-152](#)



TURBOCHARGER INTALLATION KIT

[681126](#)

EXHAUST MANIFOLD KIT

[S60001-004](#)

TEST ENGINE KIT

[EKT-2651](#)

INSTALLATION KIT

[EKT-2663](#)

MOUNTING KIT

[EGK-9266](#)



GASKET KIT

Copyright © 2020 PAI Industries, Inc.

All rights reserved. All content is property of PAI Industries, Inc. and may not be reproduced or redistributed in any form.

Any reference to OEM names or OEM product identification numbers/descriptions/model numbers is for identification only and does not indicate that it is an OEM part. PAI is not affiliated with Mack Truck, Inc.®, Volvo®, Fuller®, Cummins®, Eaton®, Rockwell®, Caterpillar®, Freightliner®, Hendrickson®, Kenworth®, Detroit Diesel®, International®, Peterbilt®, or Dana®. All Manufacturer's names, numbers, symbols and descriptions are used for reference only. It is not implied that any part listed is the product of these manufacturers.

OIL RETURN GASKET

131494

Cross Reference:

Manufacturer	OEM Number
CUMMINS	3680324
CUMMINS	3899343
DETROIT DIESEL	08929285
DETROIT DIESEL	8929285

Copyright © 2020 PAI Industries, Inc.

All rights reserved. All content is property of PAI Industries, Inc, and may not be reproduced or redistributed in any form.

Any reference to OEM names or OEM product identification numbers/descriptions/model numbers is for identification only and does not indicate that it is an OEM part. PAI is not affiliated with Mack Truck, Inc.®, Volvo®, Fuller®, Cummins®, Eaton®, Rockwell®, Caterpillar®, Freightliner®, Hendrickson®, Kenworth®, Detroit Diesel®, International®, Peterbilt®, or Dana®. All Manufacturer's names, numbers, symbols and descriptions are used for reference only. It is not implied that any part listed is the product of these manufacturers.