

# O-RING

# 321263

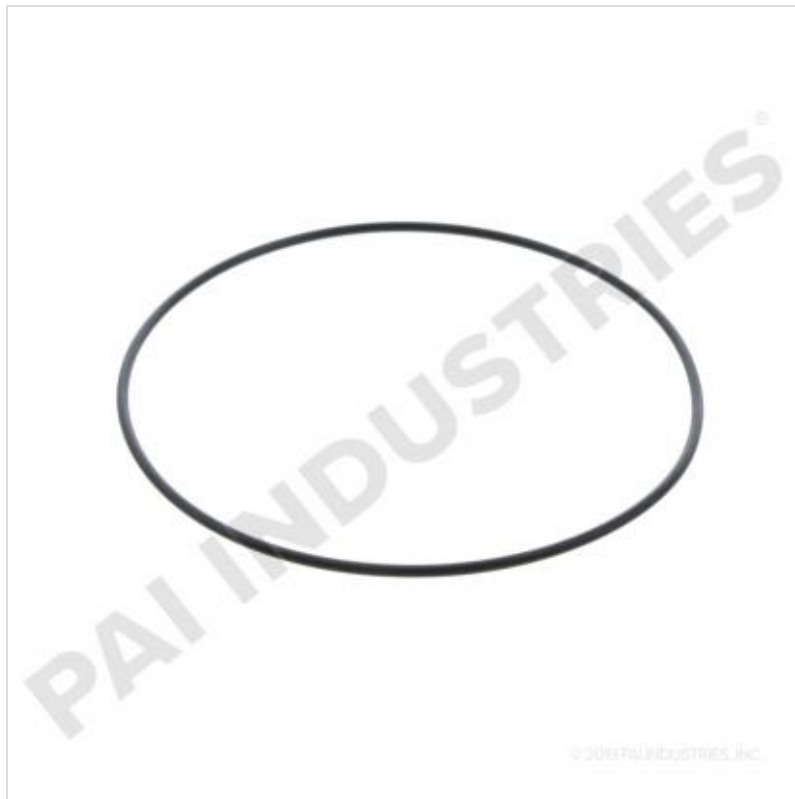

**Description:** O-RING  
**SKU:** 321263  
**OEM:** 5E8771  
**Product Group:** ENGINE PARTS  
**Product Class:** GEAR HOUSINGS & GEAR COVERS;  
 TIMING COVERS  
**UPC Code:** 193807080440  
**Sell Pack:** 10 EA  
 (Available to buy in increments of 10)  
**Weight:** 0.10 LBS  
**Warranty:** 2 Years



**Details:**

O-Ring, 0.103 in C/S x 4.737 in ID  
 2.62 mm C/S x 120.37 mm ID, Viton 75, Series # -158

**E-Catalog Pages:**

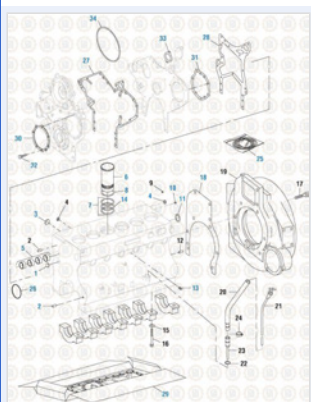
Catalog Page	Description
	<b>O-Rings</b> AS568A
	<b>International Engine 2019</b> Cylinder Block Components - DT-466 (Early to 1993)

**Copyright © 2020 PAI Industries, Inc.**  
 All rights reserved. All content is property of PAI Industries, Inc. and may not be reproduced or redistributed in any form.

Any reference to OEM names or OEM product identification numbers/descriptions/model numbers is for identification only and does not indicate that it is an OEM part. PAI is not affiliated with Mack Truck, Inc.®, Volvo®, Fuller®, Cummins®, Eaton®, Rockwell®, Caterpillar®, Freightliner®, Hendrickson®, Kenworth®, Detroit Diesel®, International®, Peterbilt®, or Dana®. All Manufacturer's names, numbers, symbols and descriptions are used for reference only. It is not implied that any part listed is the product of these manufacturers.

## O-RING

321263

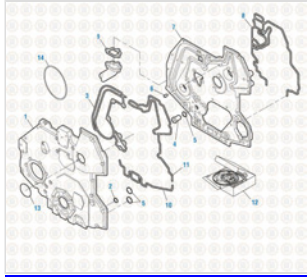
**International Engine 2019**

Gear Cover and Components - DT-466 / DT-530 (1993-1997 PLN)

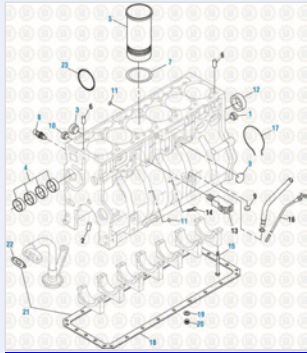
**International Engine 2019**

Cylinder Block Components - DT-466E / DT-530E (2000-2003)

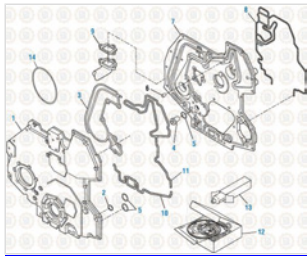
**International Engine 2019**

Gear Cover and Components - DT-466E / DT-530E (2000-2003)

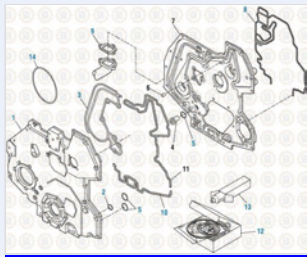
**International Engine 2019**

Gear Covers and Components - DT-466E / DT-530E (1993-1999 HEUI)

**Copyright © 2020 PAI Industries, Inc.**

All rights reserved. All content is property of PAI Industries, Inc, and may not be reproduced or redistributed in any form.

Any reference to OEM names or OEM product identification numbers/descriptions/model numbers is for identification only and does not indicate that it is an OEM part. PAI is not affiliated with Mack Truck, Inc.®, Volvo®, Fuller®, Cummins®, Eaton®, Rockwell®, Caterpillar®, Freightliner®, Hendrickson®, Kenworth®, Detroit Diesel®, International®, Peterbilt®, or Dana®. All Manufacturer's names, numbers, symbols and descriptions are used for reference only. It is not implied that any part listed is the product of these manufacturers.

# O-RING

321263

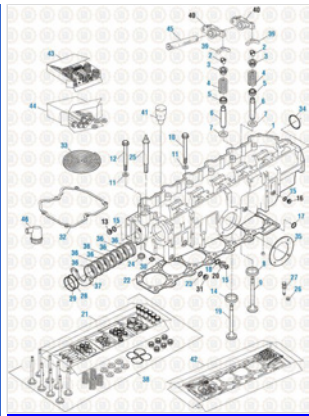

**Caterpillar Engine 2019**  
Cylinder Head - 3406E / C15 / C16 / C18 Series

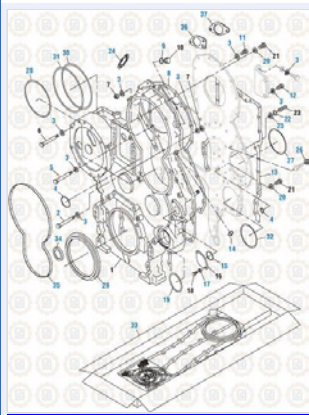

**Caterpillar Engine 2019**  
Front Housing - 3406E / C15 / C16 / C18 Series

**Component Of:**







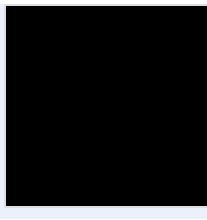

SKU	Image	Description
<a href="#">331125-159</a>	.	FRONT COVER GASKET KIT
<a href="#">331139-158</a>	.	STANDARD O-RING KIT
<a href="#">331165-152</a>	.	CAMSHAFT STANDARD O-RING KIT
<a href="#">331241-155</a>	.	ACCESSORY COVER SEAL KIT
<a href="#">331416</a>		FRONT GASKET KIT

Copyright © 2020 PAI Industries, Inc.  
All rights reserved. All content is property of PAI Industries, Inc. and may not be reproduced or redistributed in any form.

Any reference to OEM names or OEM product identification numbers/descriptions/model numbers is for identification only and does not indicate that it is an OEM part. PAI is not affiliated with Mack Truck, Inc.®, Volvo®, Fuller®, Cummins®, Eaton®, Rockwell®, Caterpillar®, Freightliner®, Hendrickson®, Kenworth®, Detroit Diesel®, International®, Peterbilt®, or Dana®. All Manufacturer's names, numbers, symbols and descriptions are used for reference only. It is not implied that any part listed is the product of these manufacturers.

# O-RING

321263



<p><a href="#">331422</a></p>		<p>FRONT GASKET KIT</p>
<p><a href="#">331495</a></p>		<p>FRONT COVER GASKET KIT</p>
<p><a href="#">331565</a></p>		<p>FRONT COVER GASKET KIT</p>
<p><a href="#">331572</a></p>		<p>FRONT COVER GASKET KIT</p>
<p><a href="#">331608</a></p>		<p>GASKET &amp; SEAL KIT</p>
<p><a href="#">331621</a></p>		<p>FRONT STRUCTURE GASKET SET</p>
<p><a href="#">431234-170</a></p>		<p>GASKET KIT</p>
<p><a href="#">431263</a></p>		<p>FRONT COVER GASKET KIT</p>

Copyright © 2020 PAI Industries, Inc.  
 All rights reserved. All content is property of PAI Industries, Inc. and may not be reproduced or redistributed in any form.

Any reference to OEM names or OEM product identification numbers/descriptions/model numbers is for identification only and does not indicate that it is an OEM part. PAI is not affiliated with Mack Truck, Inc.®, Volvo®, Fuller®, Cummins®, Eaton®, Rockwell®, Caterpillar®, Freightliner®, Hendrickson®, Kenworth®, Detroit Diesel®, International®, Peterbilt®, or Dana®. All Manufacturer's names, numbers, symbols and descriptions are used for reference only. It is not implied that any part listed is the product of these manufacturers.

## O-RING

321263

<a href="#">431273</a>		BLOCK ACCESSORY GASKET KIT
<a href="#">431275</a>		LOWER GASKET KIT

## Cross Reference:

Manufacturer	OEM Number
CATERPILLAR	5E8771
NAVISTAR	1818727
NAVISTAR	1818727C1

Copyright © 2020 PAI Industries, Inc.

All rights reserved. All content is property of PAI Industries, Inc. and may not be reproduced or redistributed in any form.

Any reference to OEM names or OEM product identification numbers/descriptions/model numbers is for identification only and does not indicate that it is an OEM part. PAI is not affiliated with Mack Truck, Inc.®, Volvo®, Fuller®, Cummins®, Eaton®, Rockwell®, Caterpillar®, Freightliner®, Hendrickson®, Kenworth®, Detroit Diesel®, International®, Peterbilt®, or Dana®. All Manufacturer's names, numbers, symbols and descriptions are used for reference only. It is not implied that any part listed is the product of these manufacturers.