

TURBOCHARGER GASKET

331212



Description: TURBOCHARGER GASKET
SKU: 331212
OEM: 1S4295
Product Group: ENGINE PARTS
Product Class: ENGINE GASKETS, O-RINGS & GASKET SETS
UPC Code: 193807124618
Sell Pack: 5 EA
 (Available to buy in increments of 5)
Weight: 0.45 LBS
Warranty: 2 Years



Details:

Turbocharger Gasket
 Caterpillar 3406E application

E-Catalog Pages:

Catalog Page	Description
	<p>Caterpillar Engine 2019 Turbocharger - 3400 Series</p>

Copyright © 2020 PAI Industries, Inc.
 All rights reserved. All content is property of PAI Industries, Inc, and may not be reproduced or redistributed in any form.

Any reference to OEM names or OEM product identification numbers/descriptions/model numbers is for identification only and does not indicate that it is an OEM part. PAI is not affiliated with Mack Truck, Inc.®, Volvo®, Fuller®, Cummins®, Eaton®, Rockwell®, Caterpillar®, Freightliner®, Hendrickson®, Kenworth®, Detroit Diesel®, International®, Peterbilt®, or Dana®. All Manufacturer's names, numbers, symbols and descriptions are used for reference only. It is not implied that any part listed is the product of these manufacturers.

TURBOCHARGER GASKET

331212

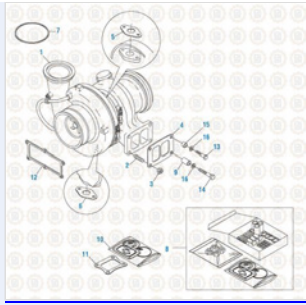

Caterpillar Engine 2019
Turbocharger - 3176 / C9 / C10 / C11 / C12 / C13 Series

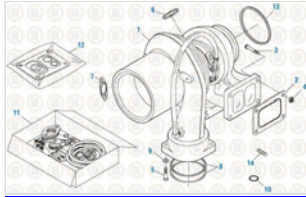

Caterpillar Engine 2019
Turbocharger - 3406E / C15 / C16 / C18 Series

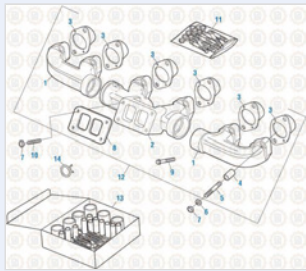

Caterpillar Engine 2019
Exhaust Manifold - 3406E / C15 / C16 / C18 Series

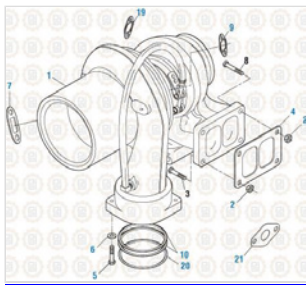

Caterpillar Engine 2019
Turbocharger - 3300 Series

Component Of:





SKU	Image	Description
321306	.	O-RING KIT
331128	.	OVERHAUL GASKET KIT
331165-155	.	TURBOCHARGER GASKET KIT
331192	.	UPPER GASKET AND SEALKIT
331194	.	UPPER GASKET KIT
331196	.	UPPER GASKET KIT
331197	.	UPPER GASKET KIT
331198	.	UPPER GASKET KIT
331199	.	UPPER GASKET KIT

Copyright © 2020 PAI Industries, Inc.
All rights reserved. All content is property of PAI Industries, Inc, and may not be reproduced or redistributed in any form.

Any reference to OEM names or OEM product identification numbers/descriptions/model numbers is for identification only and does not indicate that it is an OEM part. PAI is not affiliated with Mack Truck, Inc.®, Volvo®, Fuller®, Cummins®, Eaton®, Rockwell®, Caterpillar®, Freightliner®, Hendrickson®, Kenworth®, Detroit Diesel®, International®, Peterbilt®, or Dana®. All Manufacturer's names, numbers, symbols and descriptions are used for reference only. It is not implied that any part listed is the product of these manufacturers.

TURBOCHARGER GASKET

331212

331203-152		INSTALLATION KIT
331207		UPPER GASKET KIT
331226		INFRAME ENGINE OVERHAUL GASKET KIT
331230		UPPER GASKET KIT
331233		UPPER GASKET KIT
331234-100		GASKET KIT
331235		UPPER GASKET KIT
331237		UPPER GASKET KIT
331238		UPPER GASKET KIT
331239		UPPER GASKET KIT
331240		UPPER GASKET KIT
331241-153		MOUNTING GASKET KIT
331393		TURBOCHARGER MOUNTING GASKET
331410-152		TURBOCHARGER GASKET SET
331411-152		TURBO GASKET SET
331430		TURBOCHARGER MOUNTING GASKET KIT
331583		TURBOCHARGER INSTALLATION KIT

Copyright © 2020 PAI Industries, Inc.

All rights reserved. All content is property of PAI Industries, Inc. and may not be reproduced or redistributed in any form.

Any reference to OEM names or OEM product identification numbers/descriptions/model numbers is for identification only and does not indicate that it is an OEM part. PAI is not affiliated with Mack Truck, Inc.®, Volvo®, Fuller®, Cummins®, Eaton®, Rockwell®, Caterpillar®, Freightliner®, Hendrickson®, Kenworth®, Detroit Diesel®, International®, Peterbilt®, or Dana®. All Manufacturer's names, numbers, symbols and descriptions are used for reference only. It is not implied that any part listed is the product of these manufacturers.

TURBOCHARGER GASKET

331212

[381192](#)



TURBOCHARGER

[381232](#)



EXHAUST MANIFOLD

Cross Reference:

Manufacturer	OEM Number
CATERPILLAR	1S4295
CATERPILLAR	7H1558
MACK	590GB321
MACK	590GB321A

Copyright © 2020 PAI Industries, Inc.
 All rights reserved. All content is property of PAI Industries, Inc, and may not be reproduced or redistributed in any form.

Any reference to OEM names or OEM product identification numbers/descriptions/model numbers is for identification only and does not indicate that it is an OEM part. PAI is not affiliated with Mack Truck, Inc.®, Volvo®, Fuller®, Cummins®, Eaton®, Rockwell®, Caterpillar®, Freightliner®, Hendrickson®, Kenworth®, Detroit Diesel®, International®, Peterbilt®, or Dana®. All Manufacturer's names, numbers, symbols and descriptions are used for reference only. It is not implied that any part listed is the product of these manufacturers.