

O-RING KIT

GKT-3748

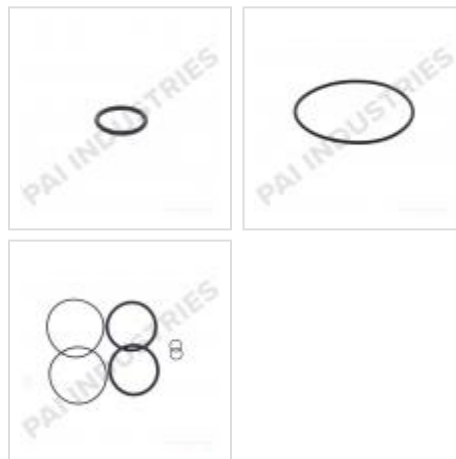

Description: O-RING KIT
SKU: GKT-3748
OEM: 207SH35
Product Group: TRANSMISSION
Product Class: BEARINGS; BEARING, SEAL & GASKET KITS
UPC Code: 193807208417
Sell Pack: 1 EA
Weight: 0.06 LBS
Warranty: 2 Years



Details:

Range Cylinder O-Ring Kit
 Early
 Mack T2080 / T2090 Transmission Application

E-Catalog Pages:

Catalog Page	Description

Copyright © 2020 PAI Industries, Inc.
 All rights reserved. All content is property of PAI Industries, Inc, and may not be reproduced or redistributed in any form.

Any reference to OEM names or OEM product identification numbers/descriptions/model numbers is for identification only and does not indicate that it is an OEM part. PAI is not affiliated with Mack Truck, Inc.®, Volvo®, Fuller®, Cummins®, Eaton®, Rockwell®, Caterpillar®, Freightliner®, Hendrickson®, Kenworth®, Detroit Diesel®, International®, Peterbilt®, or Dana®. All Manufacturer's names, numbers, symbols and descriptions are used for reference only. It is not implied that any part listed is the product of these manufacturers.

O-RING KIT

GKT-3748

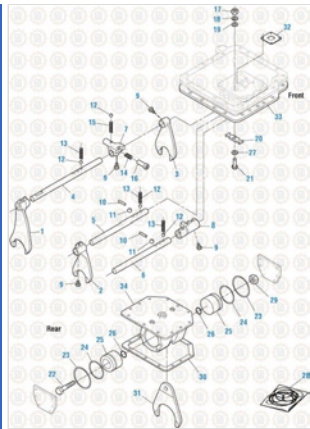

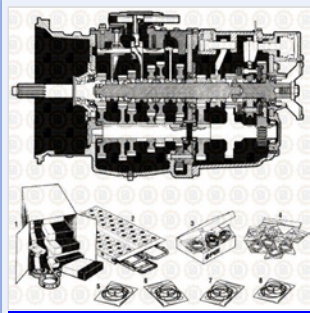

Drive Train 2016
Shifter Components - T2080, T2090 and T2100



Drive Train 2016
13/18 Speed Transmission - T2130 and T2180

Consists Of:

SKU	OEM	Image	Description	Quantity
GGA-2946	56AX533		O-RING	2
GGA-2951	56AX513		O-RING	2
GGA-2947	56AX534		O-RING	2

Copyright © 2020 PAI Industries, Inc.
All rights reserved. All content is property of PAI Industries, Inc. and may not be reproduced or redistributed in any form.

Any reference to OEM names or OEM product identification numbers/descriptions/model numbers is for identification only and does not indicate that it is an OEM part. PAI is not affiliated with Mack Truck, Inc.®, Volvo®, Fuller®, Cummins®, Eaton®, Rockwell®, Caterpillar®, Freightliner®, Hendrickson®, Kenworth®, Detroit Diesel®, International®, Peterbilt®, or Dana®. All Manufacturer's names, numbers, symbols and descriptions are used for reference only. It is not implied that any part listed is the product of these manufacturers.

O-RING KIT

GKT-3748

Component Of:

SKU	Image	Description
GGS-3971		TRANSMISSION GASKET KIT
GBK-6685	.	BEARING AND SEAL KIT
GBK-8957	.	BEARING AND SEAL KIT

Cross Reference:

Manufacturer	OEM Number
MACK	207SH35

Copyright © 2020 PAI Industries, Inc.
All rights reserved. All content is property of PAI Industries, Inc, and may not be reproduced or redistributed in any form.

Any reference to OEM names or OEM product identification numbers/descriptions/model numbers is for identification only and does not indicate that it is an OEM part. PAI is not affiliated with Mack Truck, Inc.®, Volvo®, Fuller®, Cummins®, Eaton®, Rockwell®, Caterpillar®, Freightliner®, Hendrickson®, Kenworth®, Detroit Diesel®, International®, Peterbilt®, or Dana®. All Manufacturer's names, numbers, symbols and descriptions are used for reference only. It is not implied that any part listed is the product of these manufacturers.