

O-RING

EGA-3877

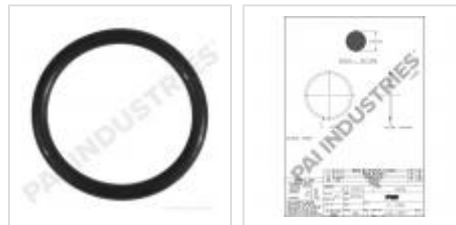

Description: O-RING
SKU: EGA-3877
OEM: 446GC1225
Product Group: ENGINE PARTS
Product Class: OIL PUMPS & RELATED PARTS
UPC Code: 193807209742
Sell Pack: 25 EA
 (Available to buy in increments of 25)
Weight: 0.02 LBS
Warranty: 2 Years



Details:

O-Ring, 0.07 in C/S x 0.739 in ID
 1.78 mm C/S x 18.77 mm ID, Viton 75, Series # -018

E-Catalog Pages:

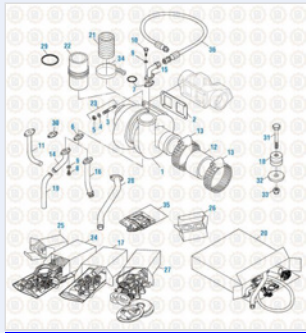
Catalog Page	Description
	<p>O-Rings AS568A</p> <p>PAI Mack & Volvo Applications 2018 Turbocharger - E6 Series</p>

Copyright © 2020 PAI Industries, Inc.
 All rights reserved. All content is property of PAI Industries, Inc. and may not be reproduced or redistributed in any form.

Any reference to OEM names or OEM product identification numbers/descriptions/model numbers is for identification only and does not indicate that it is an OEM part. PAI is not affiliated with Mack Truck, Inc.®, Volvo®, Fuller®, Cummins®, Eaton®, Rockwell®, Caterpillar®, Freightliner®, Hendrickson®, Kenworth®, Detroit Diesel®, International®, Peterbilt®, or Dana®. All Manufacturer's names, numbers, symbols and descriptions are used for reference only. It is not implied that any part listed is the product of these manufacturers.

O-RING

EGA-3877

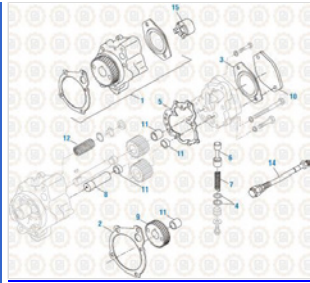

Cummins Engine 2017
Big Cam II, III and IV - FFC - 855 Series

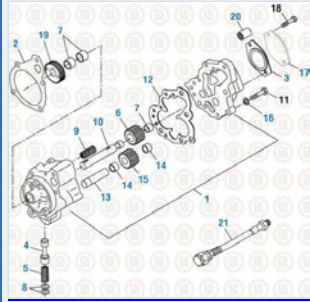

Cummins Engine 2017
Oil Pump Assembly - N14 Series

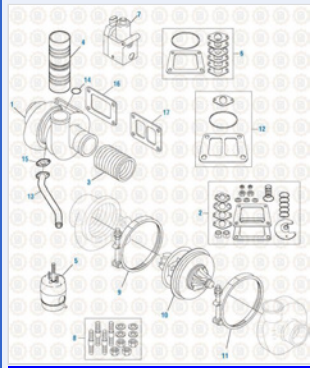

PAI Mack & Volvo Applications 2018
Turbochargers - E7 / E-Tech / ASET

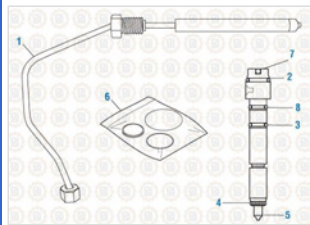

PAI Mack & Volvo Applications 2018
Fuel Injector - E-Tech/ASET - E7 Series

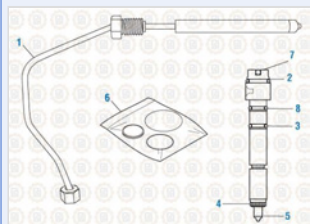

Volvo / Renault Engine Components 2015
Fuel Injection Tubes - Renault / E-Tech





Component Of:

Copyright © 2020 PAI Industries, Inc.
All rights reserved. All content is property of PAI Industries, Inc, and may not be reproduced or redistributed in any form.

Any reference to OEM names or OEM product identification numbers/descriptions/model numbers is for identification only and does not indicate that it is an OEM part. PAI is not affiliated with Mack Truck, Inc.®, Volvo®, Fuller®, Cummins®, Eaton®, Rockwell®, Caterpillar®, Freightliner®, Hendrickson®, Kenworth®, Detroit Diesel®, International®, Peterbilt®, or Dana®. All Manufacturer's names, numbers, symbols and descriptions are used for reference only. It is not implied that any part listed is the product of these manufacturers.

O-RING

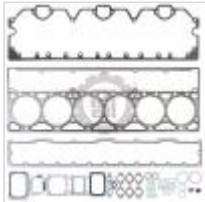
EGA-3877

SKU	Image	Description
331327		FUEL PUMP GASKET KIT
121410	-	MVT REPAIR KIT
131258		GOVERNOR GASKET KIT
131265		UPPER GASKET SET
131265-100	-	UPPER GASKET KIT
131422	-	LOWER GASKET KIT
131482-100		UPPER GASKET KIT
131482-155	-	HEAD GASKET KIT
131504	-	FULE PUMP GASKET KIT
131539		LOWER GASKET KIT
131566-200	-	O-RING KIT





Copyright © 2020 PAI Industries, Inc.

All rights reserved. All content is property of PAI Industries, Inc. and may not be reproduced or redistributed in any form.

Any reference to OEM names or OEM product identification numbers/descriptions/model numbers is for identification only and does not indicate that it is an OEM part. PAI is not affiliated with Mack Truck, Inc.®, Volvo®, Fuller®, Cummins®, Eaton®, Rockwell®, Caterpillar®, Freightliner®, Hendrickson®, Kenworth®, Detroit Diesel®, International®, Peterbilt®, or Dana®. All Manufacturer's names, numbers, symbols and descriptions are used for reference only. It is not implied that any part listed is the product of these manufacturers.

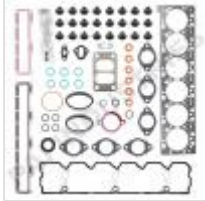
O-RING

EGA-3877

131683		UPPER GASKET KIT
131684		UPPER GASKET SET
131718	-	UPPER GASKET KIT
131743		UPPER GASKET KIT
131756		UPPER GASKET KIT
131809	-	UPPER GASKET KIT
131814		UPPER GASKET KIT
131815	-	UPPER GASKET KIT
131816	-	UPPER GASKET KIT
131865	-	LOWER GASKET KIT
131880	-	UPPER GASKET KIT
131885	-	LOWER GASKET KIT
131888	-	UPPER GASKET KIT
131902	-	LOWER GASKET KIT
131933	-	LOWER GASKET KIT

Copyright © 2020 PAI Industries, Inc.
 All rights reserved. All content is property of PAI Industries, Inc. and may not be reproduced or redistributed in any form.

Any reference to OEM names or OEM product identification numbers/descriptions/model numbers is for identification only and does not indicate that it is an OEM part. PAI is not affiliated with Mack Truck, Inc.®, Volvo®, Fuller®, Cummins®, Eaton®, Rockwell®, Caterpillar®, Freightliner®, Hendrickson®, Kenworth®, Detroit Diesel®, International®, Peterbilt®, or Dana®. All Manufacturer's names, numbers, symbols and descriptions are used for reference only. It is not implied that any part listed is the product of these manufacturers.

O-RING

EGA-3877

[132048](#)



UPPER GASKET KIT

[ERK-3425](#)

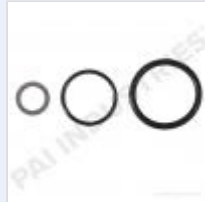

INJECTOR SEAL KIT

[ETK-3675](#)

TURBOCHARGER KIT

[GG-3972](#)

TRANSMISSION GASKET KIT

[831040](#)

TURBOCHARGER INSTALLATION KIT

Cross Reference:

Manufacturer	OEM Number
CUMMINS	3085709
MACK	446GC1225
MACK	745-234972
MACK	745-239745
CUMMINS	145504
CUMMINS	3277354
MACK	446GC2124
CUMMINS	3066914
CUMMINS	3931824
CATERPILLAR	8M8997
MACK	4103-5010284798

Copyright © 2020 PAI Industries, Inc.

All rights reserved. All content is property of PAI Industries, Inc. and may not be reproduced or redistributed in any form.

Any reference to OEM names or OEM product identification numbers/descriptions/model numbers is for identification only and does not indicate that it is an OEM part. PAI is not affiliated with Mack Truck, Inc., Volvo®, Fuller®, Cummins®, Eaton®, Rockwell®, Caterpillar®, Freightliner®, Hendrickson®, Kenworth®, Detroit Diesel®, International®, Peterbilt®, or Dana®. All Manufacturer's names, numbers, symbols and descriptions are used for reference only. It is not implied that any part listed is the product of these manufacturers.