

FRONT SEAL KIT

436005



Description:	FRONT SEAL KIT
SKU:	436005
OEM:	690437C93
Product Group:	ENGINE PARTS
Product Class:	CRANKSHAFTS & SEALS
UPC Code:	193807072865
Sell Pack:	1 EA
Weight:	0.53 LBS
Package Dimensions (LxWxH):	5 x 2 x 5 inches
Warranty:	2 Years

Details:

Front Seal Kit
 Year: 1977-2015 International DT408/DT466/DT360/530 Truck Engines application

E-Catalog Pages:

Catalog Page	Description
	<p>International Engine 2019 Crankshaft - DT-466 (Early to 1993)</p>

Copyright © 2020 PAI Industries, Inc.
 All rights reserved. All content is property of PAI Industries, Inc, and may not be reproduced or redistributed in any form.

Any reference to OEM names or OEM product identification numbers/descriptions/model numbers is for identification only and does not indicate that it is an OEM part. PAI is not affiliated with Mack Truck, Inc.®, Volvo®, Fuller®, Cummins®, Eaton®, Rockwell®, Caterpillar®, Freightliner®, Hendrickson®, Kenworth®, Detroit Diesel®, International®, Peterbilt®, or Dana®. All Manufacturer's names, numbers, symbols and descriptions are used for reference only. It is not implied that any part listed is the product of these manufacturers.

FRONT SEAL KIT

436005

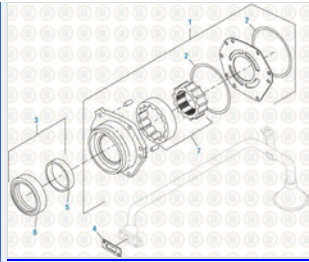

International Engine 2019
Oil Pump - DT-466 (Early to 1993)

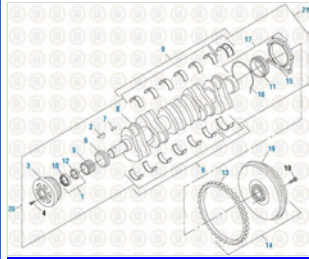

International Engine 2019
Crankshaft - DT-466 / DT-530 (1993-1997 PLN)

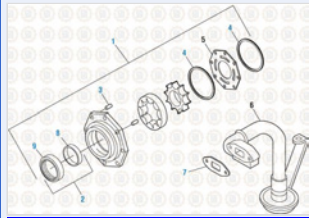

International Engine 2019
Oil Pump - DT-466 / DT-530 (1993-1997 PLN)

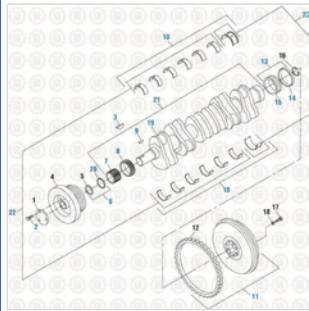

International Engine 2019
Crankshaft - DT-360 Series

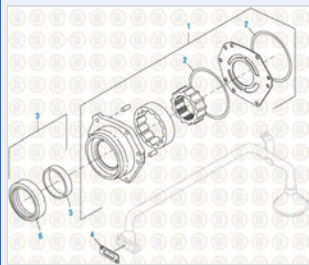

International Engine 2019
Oil Pump - DT-360 Series

Copyright © 2020 PAI Industries, Inc.
All rights reserved. All content is property of PAI Industries, Inc. and may not be reproduced or redistributed in any form.

Any reference to OEM names or OEM product identification numbers/descriptions/model numbers is for identification only and does not indicate that it is an OEM part. PAI is not affiliated with Mack Truck, Inc.®, Volvo®, Fuller®, Cummins®, Eaton®, Rockwell®, Caterpillar®, Freightliner®, Hendrickson®, Kenworth®, Detroit Diesel®, International®, Peterbilt®, or Dana®. All Manufacturer's names, numbers, symbols and descriptions are used for reference only. It is not implied that any part listed is the product of these manufacturers.

FRONT SEAL KIT

436005

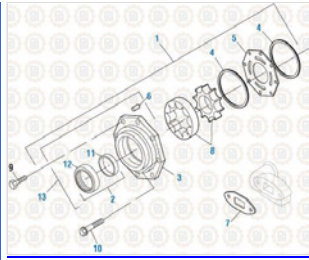
**International Engine 2019**

Oil Pump - DT-466E / DT-530E (2000-2003)

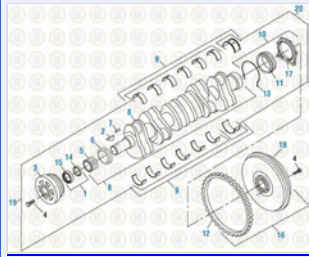
**International Engine 2019**

Crankshaft - DT-466E / DT-530E (2000-2003)

**International Engine 2019**

Crankshaft - DT-466E / DT-570 (2004 & Up)

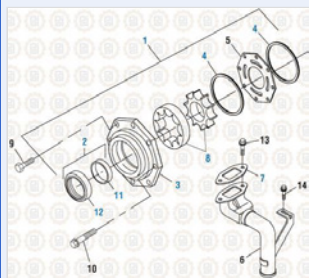
**International Engine 2019**

Oil Pump - DT-466E / DT-570 (2004 & Up)

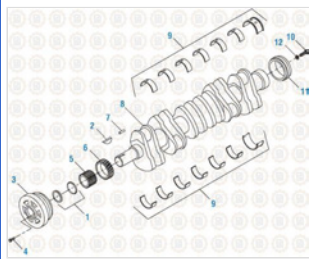
**International Engine 2019**

Crankshaft - DT-466E / DT-530E (1993-1999 HEUI)

Copyright © 2020 PAI Industries, Inc.

All rights reserved. All content is property of PAI Industries, Inc. and may not be reproduced or redistributed in any form.

Any reference to OEM names or OEM product identification numbers/descriptions/model numbers is for identification only and does not indicate that it is an OEM part. PAI is not affiliated with Mack Truck, Inc.®, Volvo®, Fuller®, Cummins®, Eaton®, Rockwell®, Caterpillar®, Freightliner®, Hendrickson®, Kenworth®, Detroit Diesel®, International®, Peterbilt®, or Dana®. All Manufacturer's names, numbers, symbols and descriptions are used for reference only. It is not implied that any part listed is the product of these manufacturers.

FRONT SEAL KIT

436005

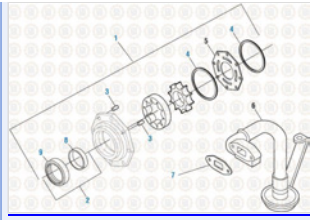

International Engine 2019
Oil Pump - DT-466E / DT-530E (1993-1999 HEUI)

Component Of:

SKU	Image	Description
431332		GASKET KIT
431336		GASKET/BOLT KIT

Cross Reference:

Manufacturer	OEM Number
MACK	4333-690437C92
MACK	4333-690437C93
MACK	4333-690437C94
MACK	4333-690437C95
NAVISTAR	1833095
NAVISTAR	1833095C92
NAVISTAR	1833095C93
NAVISTAR	690437
NAVISTAR	690437C91
NAVISTAR	690437C92
NAVISTAR	690437C93
NAVISTAR	690437C94
NAVISTAR	690437C95
NAVISTAR	1833095C91

Copyright © 2020 PAI Industries, Inc.
All rights reserved. All content is property of PAI Industries, Inc, and may not be reproduced or redistributed in any form.

Any reference to OEM names or OEM product identification numbers/descriptions/model numbers is for identification only and does not indicate that it is an OEM part. PAI is not affiliated with Mack Truck, Inc.®, Volvo®, Fuller®, Cummins®, Eaton®, Rockwell®, Caterpillar®, Freightliner®, Hendrickson®, Kenworth®, Detroit Diesel®, International®, Peterbilt®, or Dana®. All Manufacturer's names, numbers, symbols and descriptions are used for reference only. It is not implied that any part listed is the product of these manufacturers.