

LOWER BEARING KIT

671710



Description:	LOWER BEARING KIT
SKU:	671710
OEM:	23531606
Product Group:	ENGINE PARTS
Product Class:	ENGINE BEARINGS (ALL)
UPC Code:	193807019037
Sell Pack:	1 EA
Weight:	13.75 LBS
Package Dimensions (LxWxH):	10 x 9 x 10 inches
Warranty:	2 Years

Details:
Lower Bearing kit Standard size Detroit Diesel Series 60 application

Substitute:				
SKU	Sell Pack	Weight	Warranty	Description
671710HP	1	13.84 LBS	3 Years	HIGH PERFORMANCE STANDARD BEARING KIT

E-Catalog Pages:	
Catalog Page	Description

Copyright © 2020 PAI Industries, Inc.
All rights reserved. All content is property of PAI Industries, Inc, and may not be reproduced or redistributed in any form.



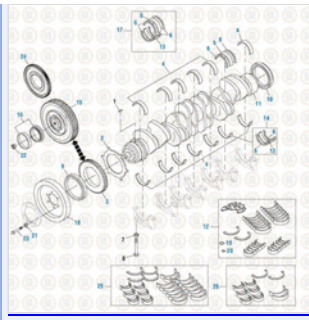

Any reference to OEM names or OEM product identification numbers/descriptions/model numbers is for identification only and does not indicate that it is an OEM part. PAI is not affiliated with Mack Truck, Inc.®, Volvo®, Fuller®, Cummins®, Eaton®, Rockwell®, Caterpillar®, Freightliner®, Hendrickson®, Kenworth®, Detroit Diesel®, International®, Peterbilt®, or Dana®. All Manufacturer's names, numbers, symbols and descriptions are used for reference only. It is not implied that any part listed is the product of these manufacturers.

LOWER BEARING KIT

671710



Detroit Diesel Engine 2019
Crankshaft - Series 60



Consists Of:				
SKU	OEM	Image	Description	Quantity
671590F	23526142		STANDARD ROD BEARING KIT	1
671620	8929085		THRUST WASHER BEARING	2
671610	8929670		MAIN BEARING	6
671615	8929680		MAIN THRUST BEARING	1
631270	5117269		OIL REGULATOR GASKET	1

Copyright © 2020 PAI Industries, Inc.
All rights reserved. All content is property of PAI Industries, Inc. and may not be reproduced or redistributed in any form.

Any reference to OEM names or OEM product identification numbers/descriptions/model numbers is for identification only and does not indicate that it is an OEM part. PAI is not affiliated with Mack Truck, Inc.®, Volvo®, Fuller®, Cummins®, Eaton®, Rockwell®, Caterpillar®, Freightliner®, Hendrickson®, Kenworth®, Detroit Diesel®, International®, Peterbilt®, or Dana®. All Manufacturer's names, numbers, symbols and descriptions are used for reference only. It is not implied that any part listed is the product of these manufacturers.

LOWER BEARING KIT

671710

631271	8929344		OIL PUMP OUTLET GASKET	2
631272	8929347		OUTLET GASKET	1
631273	23505992		OIL PUMP PICKUP GASKET	1
621211	23505891		O-RING	1
621212	23505892		O-RING	1

Component Of:

SKU	Image	Description
S60104-001	.	ENGINE KIT
S60104-001C	.	INFRAME ENGINE KIT
S60104-001OEMRC	.	HIGH PERFORMANCE ENGINE KIT
S60104-017C	.	INFRAME ENGINE KIT
S60104-017OEMRC	.	HIGH PERFORMANCE ENGINE KIT
S60106-001	.	ENGINE KIT
S60106-001C	.	INFRAME ENGINE KIT
S60106-017	.	INFRAME ENGINE KIT
S60106-017C	.	INFRAME ENGINE KIT

Copyright © 2020 PAI Industries, Inc.
 All rights reserved. All content is property of PAI Industries, Inc. and may not be reproduced or redistributed in any form.

Any reference to OEM names or OEM product identification numbers/descriptions/model numbers is for identification only and does not indicate that it is an OEM part. PAI is not affiliated with Mack Truck, Inc.®, Volvo®, Fuller®, Cummins®, Eaton®, Rockwell®, Caterpillar®, Freightliner®, Hendrickson®, Kenworth®, Detroit Diesel®, International®, Peterbilt®, or Dana®. All Manufacturer's names, numbers, symbols and descriptions are used for reference only. It is not implied that any part listed is the product of these manufacturers.

LOWER BEARING KIT

671710

S60106-017HPW	.	HIGH PERFORMANCE WARRANTY ENGINE KIT
S60106-017OEMRC	.	INFRAME ENGINE KIT
S60106-065	.	INFRAME ENGINE KIT
S60106-081	.	INFRAME ENGINE KIT
S60106-081C	.	INFRAME ENGINE KIT
S60106-097	.	ECONOMY INFRAME ENGINE KIT
S60106-113	.	INFRAME ENGINE KIT
S60106D-001	.	INFRAME ENGINE KIT
S60106D-017	.	INFRAME ENGINE KIT
S60109-001	.	ENGINE KIT
S60109-001C	.	INFRAME ENGINE KIT
S60109-017C	.	HIGH PERFORMANCE ENGINE INFRAME KIT
S60118-001	.	ENGINE KIT
S60119-001	.	ENGINE KIT
S60131-001	.	ENGINE KIT
S60131-001C	.	INFRAME ENGINE KIT
S60131-001OEMRC	.	ENGINE KIT
S60131-017	.	CROWNLESS ENGINE KIT
S60141-001	.	PISTONLESS ENGINE KIT
S60141-017	.	INFRAME ENGINE KIT
S60141-033	.	INFRAME ENGINE KIT
S60141-065	.	PISTONLESS ENGINE KIT
S60141-113	.	INFRAME ENGINE KIT
S60144-001	.	PISTONLESS ENGINE KIT
S60609-017	.	ENGINE OVERHAUL KIT
S60609-017OEMR	.	ENGINE OVERHAUL KIT

Cross Reference:

Manufacturer	OEM Number
DETROIT DIESEL	23531606

Copyright © 2020 PAI Industries, Inc.

All rights reserved. All content is property of PAI Industries, Inc, and may not be reproduced or redistributed in any form.

Any reference to OEM names or OEM product identification numbers/descriptions/model numbers is for identification only and does not indicate that it is an OEM part. PAI is not affiliated with Mack Truck, Inc.®, Volvo®, Fuller®, Cummins®, Eaton®, Rockwell®, Caterpillar®, Freightliner®, Hendrickson®, Kenworth®, Detroit Diesel®, International®, Peterbilt®, or Dana®. All Manufacturer's names, numbers, symbols and descriptions are used for reference only. It is not implied that any part listed is the product of these manufacturers.