

FRONT SEAL

EOS-8820



Description: FRONT SEAL
SKU: EOS-8820
OEM: 446GC316
Product Group: ENGINE PARTS
Product Class: CRANKSHAFTS & SEALS
UPC Code: 193807262341
Sell Pack: 1 EA
Weight: 0.24 LBS
Warranty: 2 Years

Details:

SEAL, 3.25 in Free ID x 4.008 in OD x 0.468 in Width
 82.55 mm Free ID x 101.8 mm OD x 11.88 mm Width, Primary Application : Mack E6 Timing Cover/E7 Front Crankshaft

Substitute:

SKU	Sell Pack	Weight	Warranty	Description
EM88200	1	0.22 LBS	1 Year	SEAL

E-Catalog Pages:

Catalog Page	Description

Copyright © 2020 PAI Industries, Inc.
 All rights reserved. All content is property of PAI Industries, Inc, and may not be reproduced or redistributed in any form.

Any reference to OEM names or OEM product identification numbers/descriptions/model numbers is for identification only and does not indicate that it is an OEM part. PAI is not affiliated with Mack Truck, Inc.®, Volvo®, Fuller®, Cummins®, Eaton®, Rockwell®, Caterpillar®, Freightliner®, Hendrickson®, Kenworth®, Detroit Diesel®, International®, Peterbilt®, or Dana®. All Manufacturer's names, numbers, symbols and descriptions are used for reference only. It is not implied that any part listed is the product of these manufacturers.

FRONT SEAL

EOS-8820

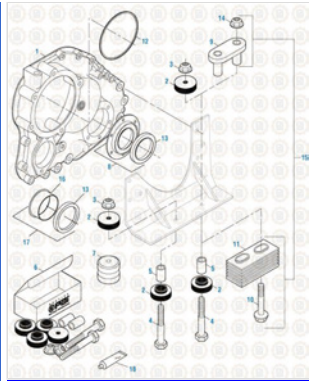

PAI Mack & Volvo Applications 2018
Aluminum Timing Cover - E6 Series



Drive Train 2016
Seals - Miscellaneous

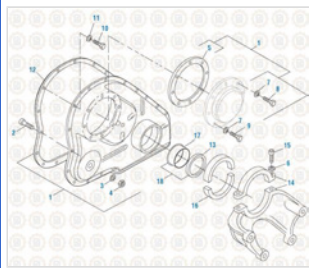

PAI Mack & Volvo Applications 2018
Steel Timing Cover - E6 Series

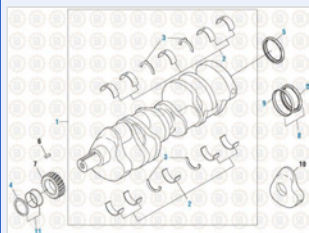

PAI Mack & Volvo Applications 2018
Crankshaft - V8 Series

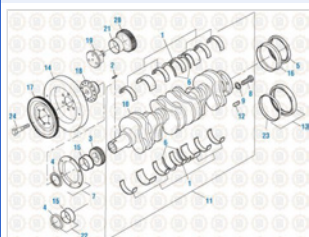

PAI Mack & Volvo Applications 2018
Crankshaft
E7, E-Tech, ASET - E7 Series

Copyright © 2020 PAI Industries, Inc.
All rights reserved. All content is property of PAI Industries, Inc. and may not be reproduced or redistributed in any form.

Any reference to OEM names or OEM product identification numbers/descriptions/model numbers is for identification only and does not indicate that it is an OEM part. PAI is not affiliated with Mack Truck, Inc.®, Volvo®, Fuller®, Cummins®, Eaton®, Rockwell®, Caterpillar®, Freightliner®, Hendrickson®, Kenworth®, Detroit Diesel®, International®, Peterbilt®, or Dana®. All Manufacturer's names, numbers, symbols and descriptions are used for reference only. It is not implied that any part listed is the product of these manufacturers.

FRONT SEAL

EOS-8820

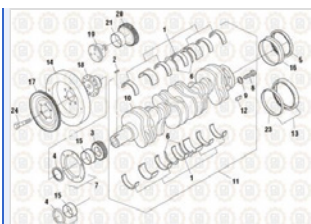

Volvo / Renault Engine Components 2015
Crankshaft - Renault / E-Tech

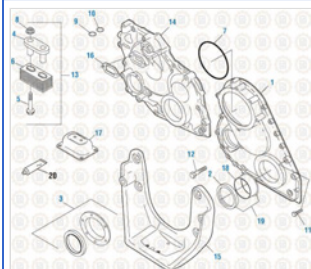

PAI Mack & Volvo Applications 2018
Timing Gear Cover and Components
E7, E-Tech, ASET - E7 Series

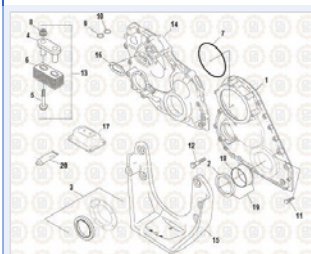

Volvo / Renault Engine Components 2015
Timing Gear Cover - Renault / E-Tech

Component Of:

SKU	Image	Description
EGS-3901		LOWER GASKET KIT
ECK-9059-100		CAMSHAFT INTALLATION KIT
831061		LOWER GASKET SET
836023		FRONT SEAL KIT

Cross Reference:

Manufacturer	OEM Number
MACK	4103-5200590535
MACK	446GC1115
MACK	446GC1116
MACK	1458-32347
MACK	446GC316

Copyright © 2020 PAI Industries, Inc.
All rights reserved. All content is property of PAI Industries, Inc. and may not be reproduced or redistributed in any form.

Any reference to OEM names or OEM product identification numbers/descriptions/model numbers is for identification only and does not indicate that it is an OEM part. PAI is not affiliated with Mack Truck, Inc.®, Volvo®, Fuller®, Cummins®, Eaton®, Rockwell®, Caterpillar®, Freightliner®, Hendrickson®, Kenworth®, Detroit Diesel®, International®, Peterbilt®, or Dana®. All Manufacturer's names, numbers, symbols and descriptions are used for reference only. It is not implied that any part listed is the product of these manufacturers.

FRONT SEAL

EOS-8820

DANA CORPORATION/PRIVATE BRAND SALE	47949
MACK	446GC335
MACK	4103-5000810989
RENAULT	5200590535

Copyright © 2020 PAI Industries, Inc.

All rights reserved. All content is property of PAI Industries, Inc, and may not be reproduced or redistributed in any form.

Any reference to OEM names or OEM product identification numbers/descriptions/model numbers is for identification only and does not indicate that it is an OEM part. PAI is not affiliated with Mack Truck, Inc.®, Volvo®, Fuller®, Cummins®, Eaton®, Rockwell®, Caterpillar®, Freightliner®, Hendrickson®, Kenworth®, Detroit Diesel®, International®, Peterbilt®, or Dana®. All Manufacturer's names, numbers, symbols and descriptions are used for reference only. It is not implied that any part listed is the product of these manufacturers.