

O-RING

EGA-2995

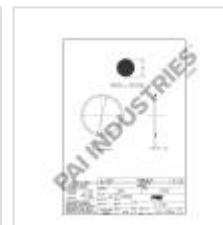

Description: O-RING
SKU: EGA-2995
OEM: 56AX283
Product Group: DIFFERENTIAL
Product Class: BEARING, SEAL & GASKET KITS
UPC Code: 193807200794
Sell Pack: 5 EA
 (Available to buy in increments of 5)
Weight: 0.06 LBS
Warranty: 2 Years



Details:

O-Ring
 0.21in C/S x 2.1in I.D.
 5.33mm C/S x 53.34mm I.D.
 Buna N
 70 Durometer
 Series # -330

E-Catalog Pages:

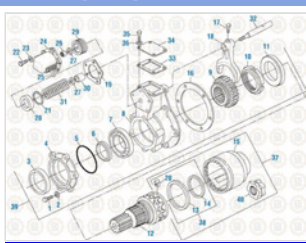
Catalog Page	Description
	<p>Drive Train 2016 CRDPC 92/112 With Lockout</p>

Copyright © 2020 PAI Industries, Inc.
 All rights reserved. All content is property of PAI Industries, Inc. and may not be reproduced or redistributed in any form.

Any reference to OEM names or OEM product identification numbers/descriptions/model numbers is for identification only and does not indicate that it is an OEM part. PAI is not affiliated with Mack Truck, Inc.®, Volvo®, Fuller®, Cummins®, Eaton®, Rockwell®, Caterpillar®, Freightliner®, Hendrickson®, Kenworth®, Detroit Diesel®, International®, Peterbilt®, or Dana®. All Manufacturer's names, numbers, symbols and descriptions are used for reference only. It is not implied that any part listed is the product of these manufacturers.

O-RING

EGA-2995

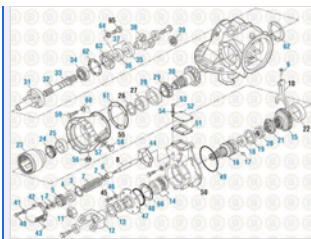

Drive Train 2016
CRDP 95 - Differential

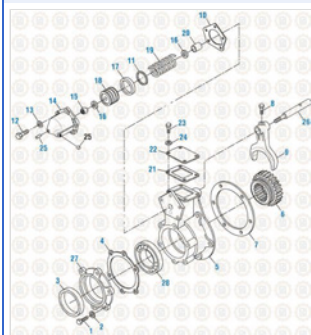

Drive Train 2016
CRD 150 w/ Lockout

O-Rings
AS568A



Component Of:		
SKU	Image	Description
331170	.	UPPER GASKET KIT
331226	.	INFRAME ENGINE OVERHAUL GASKET KIT
331229	.	UPPER GASKET KIT
331230	.	UPPER GASKET KIT
331231	.	UPPER GASKET KIT
331232	.	UPPER GASKET KIT
331233	.	UPPER GASKET KIT
331234-200		O-RING SUB KIT
331235	.	UPPER GASKET KIT
331237	.	UPPER GASKET KIT
331238	.	UPPER GASKET KIT
331239	.	UPPER GASKET KIT
331240	.	UPPER GASKET KIT
331241-154	.	VALVE COVER GASKET KIT

Copyright © 2020 PAI Industries, Inc.
All rights reserved. All content is property of PAI Industries, Inc. and may not be reproduced or redistributed in any form.

Any reference to OEM names or OEM product identification numbers/descriptions/model numbers is for identification only and does not indicate that it is an OEM part. PAI is not affiliated with Mack Truck, Inc.®, Volvo®, Fuller®, Cummins®, Eaton®, Rockwell®, Caterpillar®, Freightliner®, Hendrickson®, Kenworth®, Detroit Diesel®, International®, Peterbilt®, or Dana®. All Manufacturer's names, numbers, symbols and descriptions are used for reference only. It is not implied that any part listed is the product of these manufacturers.

O-RING

EGA-2995

EM71030		SEAL AND BEARING KIT
BLH-2162-100		LOCKOUT ASSEMBLY
BBK-7103		BEARING AND SEAL KIT
BBK-7125-200		O-RING KIT
806865		BEARING AND SEAL KIT

Cross Reference:	
Manufacturer	OEM Number
MACK	56AX283
CATERPILLAR	4F7390
CATERPILLAR	8T7201
CATERPILLAR	7F9893
CATERPILLAR	1076857
CATERPILLAR	107-6857
CATERPILLAR	078-5404
CATERPILLAR	0785404
MACK	25107630

Copyright © 2020 PAI Industries, Inc.
 All rights reserved. All content is property of PAI Industries, Inc, and may not be reproduced or redistributed in any form.

Any reference to OEM names or OEM product identification numbers/descriptions/model numbers is for identification only and does not indicate that it is an OEM part. PAI is not affiliated with Mack Truck, Inc.®, Volvo®, Fuller®, Cummins®, Eaton®, Rockwell®, Caterpillar®, Freightliner®, Hendrickson®, Kenworth®, Detroit Diesel®, International®, Peterbilt®, or Dana®. All Manufacturer's names, numbers, symbols and descriptions are used for reference only. It is not implied that any part listed is the product of these manufacturers.