

**2021**  
CATALOG

INSTALLATION SOLUTION

2021 CATALOG

**Pipeman's**  
**Installation**®  
**Solution**



# 11 YEARS OF SOLUTIONS

SINCE 2010 PIPEMAN'S INSTALLATION SOLUTION HAS BEEN PROVIDING ITS CUSTOMERS WITH A WIDE RANGE OF RELIABLE INSTALLATION HARDWARE AND ACCESSORY PRODUCTS. WHETHER YOU ARE A PROFESSIONAL INSTALLER, A TECHNICAL STUDENT, OR JUST NEED HELP WITH A DO-IT-YOURSELF PROJECT, OUR BROAD COLLECTION OF PRODUCTS IS SURE TO PROVIDE YOU WITH THE TOOL OR PART FOR YOUR PROJECT. OUR PRODUCTS INCLUDE BUT ARE NOT LIMITED TO; SOLDERING IRONS AND ACCESSORIES, DIGITAL MULTI-METERS, CIRCUIT BOARDS, TERMINALS, ADAPTERS, AND CONNECTORS, TOOLS, SWITCHES, FUSES, WIRING, POWER SUPPLY, POWER INVERTERS, VOLTAGE CONVERTERS, LED LIGHTING, AIR COMPRESSORS, AND MUCH, MUCH MORE.



# TABLE OF CONTENTS

SOLDERING PRODUCTS	03 - 14
METERING, TESTING, & TRAINING	15 - 26
POWER PRODUCTS	27 - 44
AIR COMPRESSORS, HORNS & SIRENS	45 - 52
CAR PRODUCTS & ACCESSORIES	53 - 78
LED PRODUCTS	79 - 88
SWITCHES	89 - 104
TERMINALS & CONNECTORS	105 - 118
FUSES & FUSE HOLDERS	119 - 124
TOOLS & ACCESSORIES	125 - 134
FASTENERS, SEALERS, & ADHESIVES	135 - 144
INSTALLATION HARDWARE & ACCESSORIES	145 - 148
CHEMICAL PRODUCTS	149 - 150
FABRICS & CLOTHS	151 - 152
ENCLOSURES	153 - 156
NOTES	157 - 158
INDEX	159 - 162



# SOLDERING PRODUCTS



## IS-SS7048-SIB **NEW**

### 2-IN-1 SOLDERING STATION

- Input voltage: 110V AC, 50Hz
- Output Power: 70W / 750W
- Heat Adjustment: 200-480°C / 100-480°C
- Temperature Stability: ± 1°C / ± 2°C
- Handle Operating voltage: 24V AC / 110V AC
- Nozzle to Ground Resistance: ≤ 2Ω
- Welding Nozzle to Ground Voltage: ≤ 2mV
- Air Flow: 120 L/min

**THIS 2-IN-1 REWORK AND SOLDERING STATION IS DESIGNED WITH DUAL DIGITAL LED DISPLAYS FOR RELIABLE ACCURACY. EASILY ADJUST TEMPERATURE WITH THE TOUCH OF A BUTTON. IT'S FAIL-DETECTING AND AUTO-SHUTOFF FUNCTIONS MAKE IT SAFE TO USE ANYWHERE. YOU WILL ENJOY THE VERSATILITY AND DURABILITY OF THIS SOLDERING STATION ANYWHERE!**



Replacement parts sold separately.

## IS-SS6045-SPT **NEW**

### REPLACEMENT SOLDER TIP



## IS-SS7048-FN **NEW**

### REPLACEMENT FAN FOR HOT AIR HANDLE



## IS-SS7048-EL **NEW**

### REPLACEMENT HEATING ELEMENT FOR HOT AIR HANDLE



## IS-SS7048-AH **NEW**

### REPLACEMENT HOT AIR HANDLE



## IS-SS6045-SH **NEW**

### REPLACEMENT SOLDER HANDLE





**IS-SS6045-SI** **NEW**

**SOLDERING REWORK STATION**

- Supply voltage: 110V AC, 50Hz
- Output voltage: 24V AC
- Power: 60 Watts
- Grounding resistance of the soldernig tip:  $\leq 2\Omega$
- Voltage to the ground of the welding nozzle:  $\leq 2mV$
- Heating element: SP31208602 long life metal heating core
- Temperature error:  $\pm 3^\circ C$  (static air:  $25^\circ C$  45%)
- Temperature range:  $180^\circ C \sim 450^\circ C$
- Dimensions (W x H x D): 4.53" x 3.54" x 5.51"
- Weight: 1.3KG/2.87Lbs (Excluding the handle)



**IS-SS6045-SPT** **NEW**

**REPLACEMENT SOLDERING TIP**



**IS-SS6045-SH** **NEW**

**PENCIL SOLDERING IRON**



**76D12-40W** **BEST SELLER**

**40 WATTS 12V PORTABLE SOLDER IRON**

- Ultra-Slim Textured Handle for Added Grip and Comfort
- 12V / 40 Watts



**A VERSATILE CONTROLLED TOOL FOR FIELD SERVICING. OPERATES FROM 12 VOLT BATTERIES OR LOW VOLTAGE POWER SOURCE. SOLDERING IRON COMES COMPLETE WITH BATTERY CLIPS AND 12 FEET FUSED CORD.**

**P-654**  
REPLACEMENT TIP AVAILABLE SEPARATELY

**76B40W-LED** **NEW**



**40 WATTS PENCIL SOLDERING IRON WITH LED ILLUMINATION**

- 40 Watts
- 110V
- 3 LED Lights / Application Illumination
- Superior Tip Positioning & Control
- Up to  $400^\circ C$

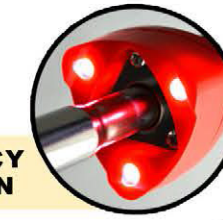

**3 LEDS FOR SUPERIOR ACCURACY AND APPLICATION ILLUMINATION**



**76B60W-ADJ** **NEW**

**60 WATTS ADJUSTABLE TEMPERATURE SOLDERING IRON**

- 60 Watts
- 110V
- Temperature:  $200-480^\circ$
- Stainless Steel Tube
- Copper Welding Head



**EASILY ADJUST UP TO FIVE DIFFERENT TEMPERATURES**



**P-796**  
REPLACEMENT TIP AVAILABLE SEPARATELY

**74B70-60W** **BEST SELLER**

**60 WATTS PENCIL SOLDERING IRON**

- 110V
- 60 Watts
- Works well on radio controls, small electrical parts, hobbies and crafts
- 4M Diameter



**C2-1**  
REPLACEMENT TIP AVAILABLE SEPARATELY

**71B30KT**

**30 WATTS PENCIL SOLDERING IRON KIT**

- For Welding a Wide Variety of Materials
- AC Operated
- 30 Watts / 110V
- For Electronics and Electrical Applications
- Base Includes Security for the Metallic End
- Included Accessories:
  - 1 Slotted Screwdriver
  - 1 Spare Tip
  - Welding Compound
  - Welding Grease



**74B30**

**30 WATTS PENCIL SOLDERING IRON**

- 30 Watts / 110V
- 4mm Diameter
- Slim Design
- Works well on radio controls, small electrical parts, hobbies and crafts





**78B40** (40 Watts)  
**78B60** (60 Watts)  
**78B80** (80 Watts)

**POPULAR  
 BEST SELLER**



**PENCIL SOLDERING IRON**

- 110V
- CE approved



**KD-KTB-3040  
 KD-KTB-60**  
 REPLACEMENT  
 TIP AVAILABLE  
 SEPARATELY

**79B65-30W** (30 Watts)  
**79B65-40W** (40 Watts)  
**79B65-60W** (60 Watts)

**POPULAR  
 NEW**

**PENCIL SOLDERING IRON**

- 110V
- Slim ergonomic design
- Works well on radio controls, small electrical parts, hobbies and crafts

**P-654 & P-656**  
 REPLACEMENT  
 TIP AVAILABLE  
 SEPARATELY



**SIMPLE AND RELIABLE SOLDERING IRON  
 WITH DURABLE LONG LASTING TIP**



**KTB-30W** (30 Watts)  
**KTB-40W** (40 Watts)  
**KTB-60W** (60 Watts)

**POPULAR  
 BEST SELLER**



**PENCIL SOLDERING IRON**

- 110V
- Works well on radio controls, small electrical parts, hobbies and crafts

**KD-KTD-3040  
 & KD-KTB-60**  
 REPLACEMENT  
 TIPS AVAILABLE  
 SEPARATELY



**KTB-60**

**74B55** **BEST SELLER**

**30 WATTS PENCIL  
 SOLDERING IRON**

- 30 Watts / 110V
- 4mm Diameter
- For Electronics and Electrical Applications

**KD-55**  
 REPLACEMENT  
 TIP AVAILABLE  
 SEPARATELY

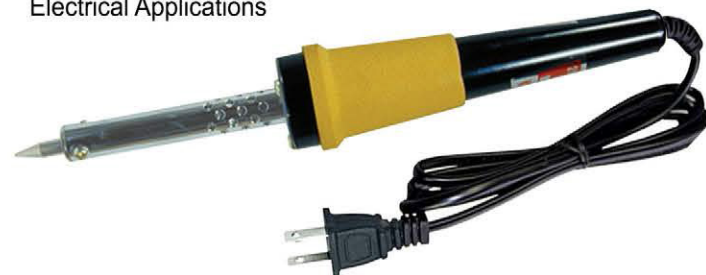

**74B70**

**40 WATTS PENCIL  
 SOLDERING IRON**

- 40 Watts / 110V
- 4mm Diameter
- Works well on radio controls, small electrical parts, hobbies and crafts

**KD-70**  
 REPLACEMENT  
 TIP AVAILABLE  
 SEPARATELY



**77B20-150W**

**150 WATTS COPPER CHISEL TIP SOLDERING IRON**

- 150 Watts
- 110V
- Lightweight and heat resistance wood handle provides comfortable grip for soldering work.
- Long Lasting Simple Replaceable Bent Copper Tip
- Works for Household Electrical Appliances
- This 150W Soldering Iron is Ideal for Soldering Copper and Steel



**IDEAL FOR SOLDERING  
 COPPER AND STEEL**

**79B20-200W**

**200 WATTS HEAVY DUTY CHISEL TIP  
 SOLDERING IRON**

- 110V
- 200 Watts
- Works for House Appliances
- Heavy-Duty
- ABS Handle



**77B20-30W** (30 Watts)  
**77B20-40W** (40 Watts)  
**77B20-60W** (60 Watts)

**NEW**

**PENCIL SOLDERING IRON**

- 110V
- Slim Design
- Lightweight and heat resistance wood handle provides comfortable grip for soldering work.
- Works well on radio controls, small electrical parts, hobbies and crafts

**NOW  
 AVAILABLE  
 IN 60W!**



**79B21-30W**

**30 WATTS HEAVY DUTY  
 SOLDERING IRON**

- 110V
- 30 Watts
- Works well on radio controls, small electrical parts, hobbies and crafts

**P-791**  
 REPLACEMENT  
 TIP AVAILABLE  
 SEPARATELY



**77B20-100W**

**100 WATTS HEAVY DUTY  
 SOLDERING IRON**

- 110V
- 100 Watts
- Industrial Soldering Iron Pen
- Lightweight and heat resistance wood handle provides comfortable grip for soldering work.

**P-720**  
 REPLACEMENT  
 TIP AVAILABLE  
 SEPARATELY





**74B23**

**100 WATTS HEAVY DUTY SOLDERING GUN**

- Uses the "Closed Loop" Method of Controlling Maximum Tip Temperature
- Portable Line Voltage Iron - No Base Station Required
- Stainless Steel Modular Plug-In Heater, Greater Efficiency & Versatility
- Temperature is Controlled by Tip (600° F, 700° F & 800° F Tips)
- Nominal Heat-Up Time with 700° F Tip is 110 Seconds



- **DESIGNED TO HELP TO GET YOUR JOB DONE RIGHT**
- **MANUFACTURED UTILIZING THE HIGHEST QUALITY MATERIALS**
- **BUILT TO PROVIDE EXCEPTIONAL LEVELS OF DURABILITY**

**79B100SS**

**100 WATTS SOLDERING IRON STATION**

- Adjustable Soldering Iron Station 110 Watts - 120V
- Variable Temperature Control 100°C-450°C
- Sturdy Compact Design
- On-Off Switch with Power-On Indicator Light
- Safety Guard Iron Holder



**KD-55**

**REPLACEMENT SOLDERING TIP**

- Replacement tip for 74B55 Soldering Iron



**KD-70**

**REPLACEMENT SOLDERING TIP**

- Replacement tip for 74B70 Soldering Iron



**KD-KTB-60**

**REPLACEMENT SOLDERING TIP**

- Replacement tip for KTB-60 Soldering Iron



**KD-KTB-3040**

**REPLACEMENT SOLDERING TIP**

- Replacement tip for KTB-30W and KTB-40W Soldering Iron



**KD-100SS**

**REPLACEMENT SOLDERING TIP**

- Replacement tip for 79B100SS, 74B70-30W, and 74B70-40W Soldering Irons
- 2.5"



**P-654**

**REPLACEMENT SOLDERING TIP**

- Replacement tip for 79B65-30W and 79B65-40W Soldering Irons
- 66mm



**P-656**

**BEST SELLER**

**REPLACEMENT SOLDERING TIP**

- Replacement tip for 79B65-60W Soldering Iron
- 68mm



**P-1**

**NEW**

**REPLACEMENT SOLDERING TIP**

- Replacement tip for 74B30 Soldering Iron



**P-720**

**NEW**

**REPLACEMENT SOLDERING TIP**

- Replacement tip for 77B20 Soldering Iron



**P-750**

**NEW**

**REPLACEMENT SOLDERING TIP**

- Replacement tip for 77B50 Soldering Iron



**P-791**

**NEW**

**REPLACEMENT SOLDERING TIP**

- Replacement tip for 79B21-30W Soldering Iron
- 2"
- 5 PCS per unit



**P-795**

**NEW**

**REPLACEMENT SOLDERING TIP**

- Replacement tip for 77B95 Soldering Iron



**KD-85**

**REPLACEMENT SOLDERING TIP**

- Replacement tip for NBW-85



**KD-200**

**REPLACEMENT SOLDERING TIP**

- Replacement tip for NWB-200



**KD-33**

**REPLACEMENT SOLDERING TIP**

- Replacement tip for 74B23 Soldering Iron



**KD-40**

**REPLACEMENT SOLDERING TIP**

- Replacement tip for NWB74



**KD-50**

**REPLACEMENT SOLDERING TIP**

- Replacement tip for NWB50





**HH-2**

**BEST SELLER**

**SOLDERING STAND**

- Acid-Free
- Non-Toxic Cellulose Tip Cleaning Sponge



**THIS LIGHT WEIGHT, STURDY SOLDERING STAND SAFELY KEEPS YOUR SOLDERING IRON HANDY AND ACCESSIBLE. THE SOLDERING IRON STAND INCLUDES A HEAT SHIELD THAT PROVIDES AN EXTRA LAYER PROTECTION. IT INCLUDES SOLDERING IRON TIP-CLEANING SPONGE AND ASSEMBLY HARDWARE.**

**HH-4DS**

**SOLDERING STAND & HOLDER WITH SOLDER FEEDER**

- Soldering Iron Stand and Holder
- With Solder Feeder and Sponge
- Safety Outer Metal Holder
- Holds up to 2 lb. Roll of Soldering Wire
- Tip Cleaning Special Sponge



**HH-3MG**

**THIRD HAND TOOL WITH SOLDER STAND**

- Adjustable joints for versatile movement in all directions
- Strong "Alligator clamps" hold work securely
- Heavy cast-iron base for added stability
- Distortion-free magnifying glass



**DESIGNED WITH THE HOBBYIST, ELECTRICIAN, JEWELER, AND EVERYDAY USER IN MIND. THIS HELPING HAND IS PERFECT FOR SOLDERING, DETAILED WORK, AND WORKING WITH SMALL PARTS.**

**HH-1**

**DUAL HELPING HANDS**

- Holds Work in any Position Leaving Hands-Free for Soldering



**SIX BALL JOINTS PERMIT MOVEMENT TO THE EXACT ANGLE REQUIRED FOR HANDS-FREE OPERATION. TIGHTENED (LOCKED IN PLACE) BY THUMB SCREW. ALLIGATOR CLIPS, ADJUSTABLE TO ANY POSITION, HOLD SMALL SHAPES SECURELY. HEAVY BASE PREVENTS TIPPING.**

**HH-TWEZ-6**

**6 PIECE ANTI-STATIC ESD TWEEZERS SET KIT**

- Resistive ESD coating helps protect electronics from static damage
- Durable stainless steel material; Only the tweezer's tips are non-magnetic
- These tweezers can be widely applied to PCB, repairing of watches, crafts, jewelry, electronics, laboratory work and so on
- Each tweezer comes with a protective plastic tip cover for safe handling
- Includes 1 pair of flat head tweezers, 1 pair of curved tips tweezers and 4 pairs of pointy tip tweezers



**6AS-WRST5**

**ANTI-STATIC WRIST STRAP**

- Anti-Static Wrist Strap
- Current Limiting Resistor 1MΩ ± 5%
- Electro-Scattering Time: 0.1 Sec
- Adjustable Grounding
- Suitable for Use in Electronic Repair Shops



**W-1**

**5FT DESOLDERING WIRE**

- 2.5mm Width
- 1.5M Length



**SP-10 (10 GRAMS)  
SP-50 (50 GRAMS)**

**SOLDER PASTE**

- In Plastic Case



**BEST SELLER**

**SP-15 (15 GRAMS)**

**SOLDER PASTE**

- In Plastic Case



**60-40 1/2LB**

**ROSIN CORE SOLDER WIRE**

- 60% Rosin / 40% Lead
- 1/2 LB Spool
- 0.8mm Diameter



**40-60 1LB (40% ROSIN/60% LEAD)  
60-40 1LB (60% ROSIN/40% LEAD)**

**ROSIN CORE SOLDER WIRE**

- 1 LB Spool
- 0.8mm Diameter

**MADE IN TAIWAN**



**40-60 PEN (40% ROSIN/60% LEAD)  
60-40 PEN (60% ROSIN/40% LEAD)**

**ROSIN CORE SOLDER WIRE**

**BEST SELLER**

- Pen Type
- 0.8mm Diameter
- 9.8 ft Length

**MADE IN TAIWAN**



**60-40 1.0MM**

**ROSIN CORE SOLDER WIRE**

- 60% Rosin Core
- 40% Lead
- Diameter: 1.0mm
- Net Weight: 1lb



**60-40-12 (60% ROSIN/40% LEAD)**

**ROSIN CORE SOLDER WIRE**

- Rosin Core Solder Wire
- 1 lb. Spool
- Ø 1.2 mm





**NBW-74**

**BEST SELLER**

**DESOLDERING SUCKER TOOL**

- Metal Desoldering Pump
- 7.5"
- Changeable Teflon Tip
- Durable Aluminum Housing

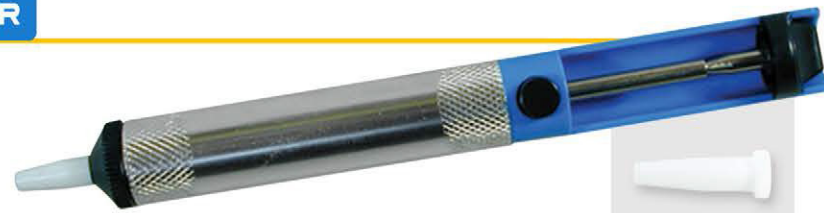

**KD-40**  
REPLACEMENT  
TIP AVAILABLE  
SEPARATELY

**POWERFUL SUCTION FOR SOLDER REMOVAL. SPRING LOADED PISTON DESIGN TO QUICKLY AND EFFECTIVELY REMOVE SOLDER FROM A CIRCUIT BOARD**

**NBW-50**

**DESOLDERING SUCKER TOOL**

- Plastic Desoldering Pump
- 7.5"
- Changeable Teflon Tip



**KD-50**  
REPLACEMENT  
TIP AVAILABLE  
SEPARATELY

**NBW-85**

**LARGE DESOLDERING SUCKER TOOL**

- Large Plastic Desoldering Pump
- 8"
- Changeable Teflon Tip

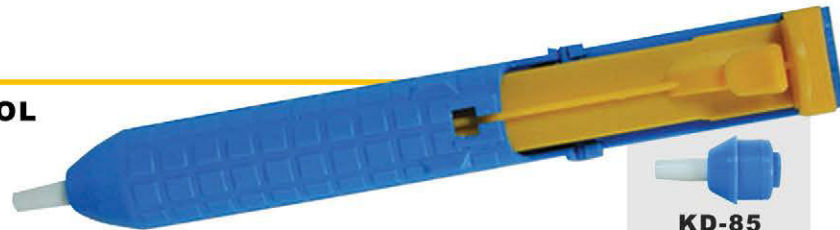

**KD-85**  
REPLACEMENT  
TIP AVAILABLE  
SEPARATELY

**NBW-100**

**LARGE DESOLDERING SUCKER TOOL**

- Large Plastic Desoldering Pump
- 10"
- Changeable Teflon Tip



**KD-100**  
REPLACEMENT  
TIP AVAILABLE  
SEPARATELY

**NBW-200**

**POPULAR**

**EXTRA LARGE DESOLDERING SUCKER TOOL**

- Large Plastic Desoldering Pump
- 13"
- Changeable Teflon Tip
- Anti-skid design makes it easy to hold and use.
- Quality material, high heat-resisting suction nozzle



**KD-200**  
REPLACEMENT  
TIP AVAILABLE  
SEPARATELY

**LARGE, LIGHTWEIGHT ANTISTATIC DESOLDERING VACUUM PUMP, WITH REPLACEABLE TEFLON TIP AND ANTI-CORROSIVE SPRING. IDEAL FOR REMOVING SOLDER FROM PRINTED CIRCUIT BOARDS. THE COMBINATION OF LIGHT WEIGHT, LIMITED RECOIL AND LARGE EXTRACTION VOLUME MAKE THIS A GREAT DESOLDERING TOOL.**

**HHML-6085-3D**

**60 SMD LED MAGNIFYING LAMP**

Replacement parts sold separately. BIFOCALS - This Me with bifocals 5" diameter lens with two parts with different focal lengths, the large lens for distant vision (5 diopter) and the small lens for near vision (20 diopter)

- 720 LUMENS BRIGHT - Super LED light provides 720 lumens for reading small print or working on your special projects. Our large 5-diopter (225%) lens and small 20-diopter (600%) produce a bright beam of vivid light without glare. This energy-saving desk lamp will last up to 100,000 hours and is great for reading, knitting, circuit boards, and soldering. And the best part is it doesn't get hot!

- DIMMABLE - Simply press the power button to adjust the brightness level by 25%, 50%, 75%, or 100%. This feature is a must-have if you are looking for the perfect lighting for various tasks and is a highly desired feature of many of our customers.

- MULTI-PURPOSE LED - You can either use this as an LED desk lamp or magnifying lamp by opening or closing the lens cover with the easily adjustable triple-joint arm.

- Voltage: AC 110-120V, 60Hz



**PREMIUM 2-IN-1 LIGHTING AND MAGNIFICATION LAMP WITH METAL G-CLAMP FOR DESKTOP USE. COMES WITH 5" ROUND GLASS LENS AND A HINGED, DUST-PROOF COVER. USES 80 ULTRA-EFFICIENT SMD LEDs WHICH OFFER GLARE-FREE LIGHT. ADJUSTABLE SWING ARM IS MADE OF METAL AND INCLUDES AN ARM COVER WHICH REDUCES POSSIBILITY OF HAND PINCHING OR INJURY. 2 PRONG UNGROUNDED PLUS. LENS CLEANING CLOTH INCLUDED.**





# METERING, TESTING, & TRAINING



## IS-9699-NCVHAR **NEW**

### 19999 COUNTS LCD DISPLAY DIGITAL MULTIMETER

#### General Specifications

- Display (LCD): 19999 counts
- Ranging: Auto/Manual
- Material: ABS
- Update Rate: 3 times/second
- Low Battery Indication
- True RMS
- Data Hold
- Backlight
- Relative Measurement
- MAX/MIN
- Auto Power Off

#### Mechanical Specifications

- Dimensions: 6.3" x 3.2" x 1.5"
- Weight: 0.44 Lbs
- Battery Type: 1.5V AA Battery x 2 (Included)

#### Environmental Specifications

- Operating Temperature: 0~40°C
- Operating Humidity: <75%
- Storage Temperature: -20~60°C
- Storage Humidity: <80%



ACCESSORIES INCLUDED



## IS-9609-SQWRMS **NEW**

### 9999 COUNTS LCD DISPLAY DIGITAL MULTIMETER

#### General Specifications

- Display (LCD): 9999 counts
- Ranging: Auto
- Material: ABS
- Update Rate: 3 times/second
- Low Battery Indication
- True RMS
- Data Hold
- Backlight
- Auto Power Off

#### Mechanical Specifications

- Dimensions: 5.1" x 2.6" x 1.3"
- Weight: 0.25 Lbs
- Battery Type: 1.5V AAA Battery x 2 (Included)

#### Environmental Specifications

- Operating Temperature: 0~40°C
- Operating Humidity: <75%
- Storage Temperature: -20~60°C
- Storage Humidity: <80%



ACCESSORIES INCLUDED

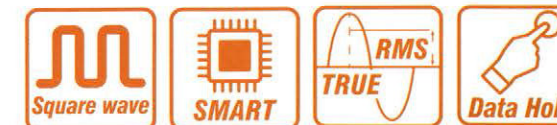



**IS-9606-TEMPLM** **NEW**

**6000 COUNTS LCD DISPLAY DIGITAL MULTIMETER**

**General Specifications**

- Display (LCD): 6000 counts
- Ranging: Auto
- Material: ABS
- Update Rate: 3 times/second
- Low Battery Indication
- True RMS
- Data Hold
- Backlight
- Auto Power Off

**Mechanical Specifications**

- Dimensions: 5.1" x 2.6" x 1.3"
- Weight: 0.25 Lbs
- Battery Type: 1.5V AAA Battery x 2 (Included)

**Environmental Specifications**

- Operating Temperature: 0~40°C
- Operating Humidity: <75%
- Storage Temperature: -20~60°C
- Storage Humidity: <80%



**ACCESSORIES INCLUDED**



**IS-9604-CMPSMT** **NEW**

**AC 600A CLAMP METER**

**General Specifications**

- Display (LCD): 4000 counts
- Ranging: Auto
- Material: ABS
- Update Rate: 3 times/second
- Low Battery Indication
- True RMS
- Data Hold
- Low Battery Indication
- Auto Power Off

**Mechanical Specifications**

- Dimensions: 6.8" x 2.5" x 1.3"
- Weight: 0.35 Lbs
- Battery Type: 1.5V AAA Battery x 2 (Included)

**Environmental Specifications**

- Operating Temperature: 0~40°C
- Operating Humidity: <75%
- Storage Temperature: -20~60°C
- Storage Humidity: <80%



**ACCESSORIES INCLUDED**



**IS-9604-NVECO** **NEW**

**4000 COUNTS LCD DISPLAY DIGITAL MULTIMETER**

**General Specifications**

- Display (LCD): 4000 counts
- Ranging: Auto
- Material: ABS
- Update Rate: 3 times/second
- Low Battery Indication
- True RMS
- Data Hold
- Backlight
- Flashlight
- Auto Power Off

**Mechanical Specifications**

- Dimensions: 4.7" x 2.4" x 1.1"
- Weight: 0.26 Lbs
- Battery Type: 1.5V AAA Battery x 2 (Included)

**Environmental Specifications**

- Operating Temperature: 0~40°C
- Operating Humidity: <75%
- Storage Temperature: -20~60°C
- Storage Humidity: <80%



**ACCESSORIES INCLUDED**

**REAR LED FLASHLIGHT**

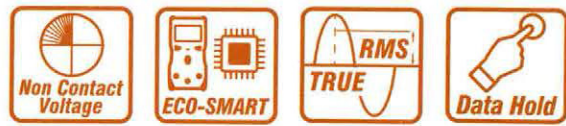

**IS-500-ANGPLM** **NEW**

**ANALOG MULTIMETER**

- Voltage DC: 10/50/250/500V
- Voltage AC: 10/50/250/500V
- Current DC: 10m/100m/250m/500m
- Current AC: 10m/100m/250m/500m
- DC: 10A
- Battery: 1.5V (AAA); 9V, 1.5V (button cell)
- Resistance: Rx10 / Rx100 / Rx1kΩ
- Continuity: Yes
- Operating Temperature: 0~50°C, <85% RH
- Storage Temperature: -5~50°C, <85% RH
- Dimensions: 6.2" x 3.1" x 2.2"
- Weight: 0.64 lbs (including batteries)
- Fits in the palm of your hand
- Full measurement range protection
- Molded rubber casting



**High Precision**



**IS-600-ANGTAB** **NEW**

**ANALOG MULTIMETER**

- Voltage DC: 2.5/10/50/250/600V
- Sensitivity: 20kΩ/V
- Voltage AC: 10/50/250/500V
- Frequency Response: 60~400Hz
- Sensitivity: 9kΩ/V
- Current DC: 10mA/250mA/500mA/10A
- Current AC: 10mA/250mA/500mA/10A
- Frequency Response: 60~400Hz
- Resistance: Rx10/Rx1kΩ
- Continuity: <30Ω
- AC/DC: 10A
- Battery: 1.5V (AAA)
- Operating Temperature: 0~50°C, <85% RH
- Storage Temperature: -5~50°C, <85% RH
- Dimensions: 6.8" x 4.4" x 1.7"
- Weight: 0.77 lbs (including batteries)



**High Precision**





**ST-4300CT**

**DIGITAL MULTIMETER AND CABLE TESTER**

- DCV: 200mV-1000mV ± (0.5%+1)
- ACV: 2V-750V ± (0.8%+3)
- DCA: 2mA-20A ± (1.0%+5)
- ACA: 200mA-20A ± (1.5%+5)
- OHM: 200W-20mW ± (0.8%+3)
- Continuity Buzzer
- Test for continuity: RJ11/RJ12/RJ45/USB
- Diode Test
- Transistor Test



**ST-4068CT**

**DIGITAL MULTIMETER AND CABLE TESTER**

- DCV: 200mV-500V ± (0.5% + 2)
- ACV: 200V-500V ± (1.2% + 10)
- DCA: 2000uA-10A ± (1% + 2)
- OHM: 200W-2mW ± (0.8% + 2)
- Continuity Buzzer
- Test for continuity:RJ-11/RJ-45
- Diode Test
- Data Hold for Easy Reading



**IS-HHM300**

**HANDHELD MULTIMETER**

- DCV: 2-500V± (0.5%+1)
- ACV: 2-500V± (1.2%+10)
- DCA: 0-200mA ± (2%+2)
- OHM: 2-2000 KΩ ± (1%+2)
- Continuity Beep
- Diode Test
- Power: 12V
- Dimensions: 2.8" x 4.7" x 0.7"
- Weight: Approx 0.24 lb (110 g included Battery)



**ST-5077**

**DIGITAL MULTIMETER**

- DCV: 200m-1000V
- ACV: 200-750-1000V
- DCA: 200uA-10A
- OHM: 200-2000K Ohms
- Battery: 9V



**IS-HHM53L**

**DIGITAL MULTIMETER**

- DCV: 200mV-2-20-200-600V
- ACV: 200-600V
- DCA: 200uA-2mA-20-200mA-10A
- Resistance: 200Ω-2k-20k-200k-2MΩ
- Transistor Test
- Diode Test
- Data Hold for Easy Reading
- Does Not Include Battery



**IS-HHM75**

**DIGITAL MULTIMETER**

- DCV: 200mV-2-20-200-1000V
- ACV: 200mV-2-20-200-700V
- DCA: 20u-200u-200m-20A
- ACA: 2m-20m-20m-200m-2-10A
- Resistance: 200-2k-20k-200k-2M-200MΩ
- Continuity Beep
- Auto Power OFF
- Automatic Over Range Indication
- Does Not Include Battery



**ST-5505**

**BEST SELLER**

**DIGITAL MULTIMETER**

- 6.2 x 3.3 cm LCD display
- Blue backlight
- Quick display; updated 2-3 reads per second
- Data hold function
- DC Voltage: 200 mV / 2000 mV / 20 V / 200 V / 1000 V ±(0.5%)
- DC Current: 20 mA / 200 mA / 20 A ±(1.8%)
- AC Voltage: 2 V / 20 V / 200 V / 750 V ±(1.5%)
- AC Current: 200 uA / 2 mA / 20 mA / 200 mA / 20 A ±(1%)
- Resistance: 200 Ω / 2 KΩ / 20 KΩ / 200 KΩ / 2 MΩ / 200 MΩ ±(1%)
- Transistor test hFE: 20 nF / 200 nF / 2 uF / 200 uF ±(1%)
- Diode test: Display shows the direct voltage of the diode
- Test continuity: A signal sounds if the conductance is less than 30 ± 20 Ω
- Battery test: 1.5 V / 9 V
- Pair of test leads included
- Dimensions : 6 x 22 cm
- Weight : 0.55kg



**IS-HHM-16DCL**

**DIGITAL MULTIMETER WITH AC CLAMP METER**

- DCV: 0-1000V ± (1%+1)
- ACV: 0-750V ± (2%+3)
- DCA: 0-200A ± (2%+3)
- ACA: 0-200A ± (2.5%+3)
- OHM: 0-40mΩ ± (1.5%+2)
- Continuity Beep
- Frequency Test
- Capacitance Test
- Diode Test



**IS-HHM26ACL**

**POPULAR**

**DIGITAL MULTIMETER WITH AC CLAMP METER**

- DCV: 0-1000V ± (1%+1)
- ACV: 0-750V ± (2%+3)
- DCA: 0-200A ± (2%+3)
- ACA: 0-200A ± (2.5%+3)
- OHM: 0-40mΩ ± (1.5%+2)
- Continuity Beep
- Frequency Test
- Capacitance Test
- Diode Test





**IS-ICTL-1224V**

**12/24V CIRCUIT TESTER**

- Ergonomic Grip Design with 6 Ft. Test Leads
- Bright White LED Illuminates Troubleshooting Area
- Transparent Handle Shows Bright LED's to Identify Connections
- Blue = Ground Present
- Red = Voltage Present
- Helps to Quickly Identify if there is Voltage Present on Wiring and Circuits



**ICT-112**

**POPULAR**

**HEAVY DUTY CIRCUIT TESTER**

- Checks 6, 12, & 24 Volt Circuits
- Supplied with 60" Cable



**ICT-115LED**

**BEST SELLER**

**LED CIRCUIT TESTER**

- Quickly checks all 6 & 12 Volts Systems
- Supplied with Long 47" /1.2M Cable
- Strong Alligator Lead Clip
- Test Short / Open Circuit
- With Red LED



WITH RED LED

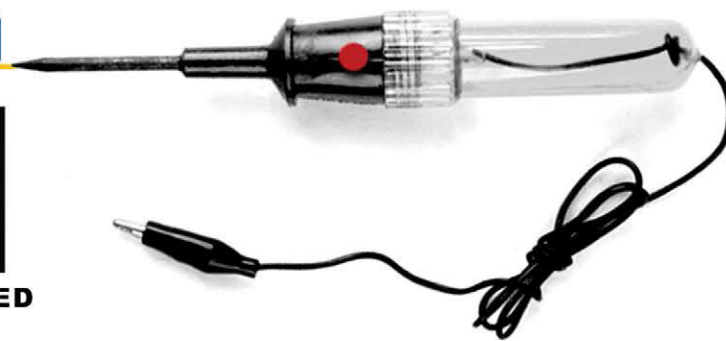

**MAT-7400**

**ANTI-STATIC TECHNICIANS REPAIR WORK MAT**

- The best protection against electrostatic discharge
- Ground yourself and your work surface to prevent damage from electrostatic discharge
- The perfect size for phone and small electronics repair
- Use the included coiled cord to keep you grounded



**IS-9013**

**TESTING CONSOLE WITH HDMI PORT**

- I/S testing console
- CB antenna cable & indicator light
- Left and right speaker
- RJ-11 phone jack
- 12V power supply
- Speaker spring connectors
- RCA jacks
- Coax connectors

Works well for:

- Telephone, fax, and answering machines
- Video games
- Camcorders
- Televisions
- VCR's
- CB radios
- Car radios/stereos



**NT-TONEG**

**TONE GENERATOR FOR TESTING SPEAKERS**

- This compact tone generator is great for general tests and troubleshooting of virtually any audio installation including automotive, residential and distributed commercial systems
- Line level audio output is high enough to drive home theatre, auto sound and pro sound inputs, and speaker level output delivers over 1W signal



**NT-PHASE**

**POLARITY/PHASE TESTER**

- This polarity/phase tester utilizes state of the art signal processing to accurately determine absolute polarity, which is unimpaired by passive crossovers or signal waveform distortions produced by the device under test
- It works with tweeters, midranges and woofers, subwoofer speakers and cabinets, plus equalizers, amplifiers and crossovers





**NB-409**

**TEST LEADS**

- Three foot cord with two pin prods on each end



**NB-413**

**TEST LEAD SET**

- Three foot set includes 10 wires and 20 clips in black, green, red, white, and yellow



**NB-414**

**TEST LEADS**

- Three foot cord with two pin prods to banana plugs

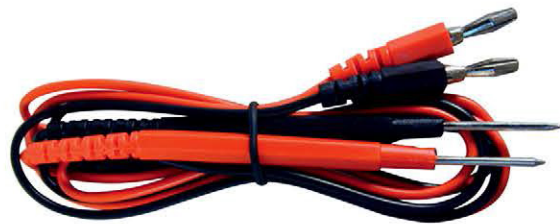

**NB-425**

**TEST LEAD WITH PROTECTOR**

- Four foot pin prods to right angle

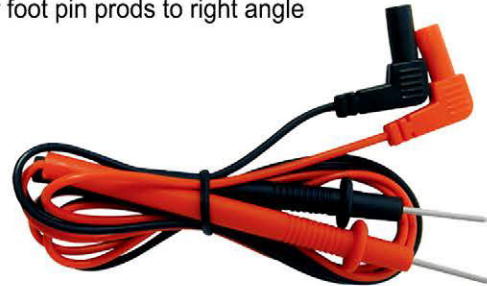

**NB-341 BLK  
NB-341 RED**

**ALLIGATOR CLIP**



**NB-437**

**POPULAR**

**TEST LEADS**

- Flexible cable with right angle DMM plugs
- 0.08" (2mm) diameter contact tips
- Max Test Voltage: 600V/1000V
- Max Test Current: 10A



- NB-343 BLK (1")**
- NB-343 RED (1")**
- NB-344 BLK (1.5")**
- NB-344 RED (1.5")**
- NB-345 BLK (2")**
- NB-345 RED (2")**



**ALLIGATOR CLIPS**

**ST-PC23-CPR**

**PROTOTYPING PCB  
PRINTED CIRCUIT BOARD**

- Material : FR-4
- Size of Board: 5X7.5cm (2X3")
- Thickness: 1.5mm
- 5 pcs per unit



**POPULAR FOR TECH STUDENTS**

**ST-PC46-CPR**

**PROTOTYPING PCB  
PRINTED CIRCUIT BOARD**

- Material : FR-4
- Size of Board: 10X15cm (4X6")
- Thickness: 1.5mm
- 5 pcs per unit



**POPULAR FOR TECH STUDENTS**

**ST-SB32-ABS**

**SOLDERLESS BREAD  
BOARD PROTOTYPE**

- Material: ABS
- 1pc Terminal Strip, Tie-Point 300
- 2pcs Distribution Strips, 50pcs each
- Binding Post: None
- Board: 8.3 x 5.5cm
- Thickness: 0.85cm
- Metal Plate: None

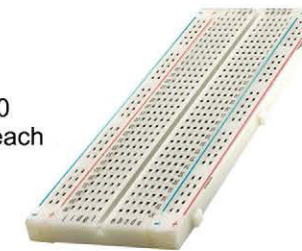

**POPULAR FOR TECH STUDENTS**

**ST-SB73-ABS**

**SOLDERLESS BREAD  
BOARD PROTOTYPE**

- Material: ABS
- 2pcs Terminal Strips, Tie-Point 1260
- 1pc Distribution Strip, Tie-Point 100
- 2pcs Binding Posts
- Board: 16.6\*7.95cm(7X3")
- Thickness: 0.85cm
- Metal Plate: 21.3 x 10.5 x 0.12cm



**POPULAR FOR TECH STUDENTS**

**EPB-64**

**SOLDERLESS BREAD  
BOARD PROTOTYPE**

- Material: ABS

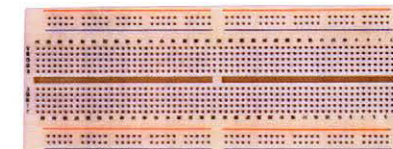

**POPULAR FOR TECH STUDENTS**

**ST-SB74-ABS**

**SOLDERLESS BREAD  
BOARD PROTOTYPE**

- Material: ABS
- 2pcs Terminal Strips, Tie-Point 1260
- 3pcs Distribution Strips, Tie-Point 300
- 3pc Binding Posts
- Size of Board: 16.6\*9.85 (7X4")
- Thickness: 0.85cm
- Metal Plate: 21.3\*13\*0.12cm

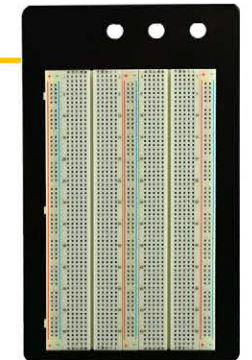

**POPULAR FOR TECH STUDENTS**

**ST-BB23-CPR**

**SOLDERABLE COPPER PCB BOARD**

- 504 points
- 0.042" hole diameter
- 0.1" spacing
- Copper clad
- Size: 2" wide x 3" long x 1/16" thick
- 5 pcs per unit



**POPULAR FOR TECH STUDENTS**

**ST-BB46-CPR**

**SOLDERABLE COPPER PCB BOARD**

- 2,204 points
- 0.042" hole diameter
- 0.1" spacing
- Copper clad
- Size: 4" wide x 6" long x 1/16" thick
- 5 pcs per unit

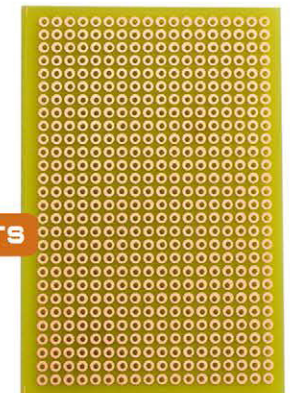

**POPULAR FOR TECH STUDENTS**



- LED-5M-B4K-3BR (BI-COLOR)
- LED-5M-3H-3BLU (BLUE)
- LED-5M-4K-3GRN (GREEN)
- LED-5M-2H-3RED (RED)
- LED-5M-4H-3YLW (YELLOW)
- LED-5M-14K-3WHT (WHITE)



**5MM LED LIGHT EMITTING DIODES BULB**

- 100 pcs per unit
- Head type: Round
- Max. Current: 20 mA
- Forward Voltage: R/ Y 2.0-2.2V; G/ W/ B 3.0-3.2V
- Bright and vivid: With high-quality Resin, our LEDs provide bright and beautiful lights with vivid colors. Each color of LEDs has 40 pcs
- For long term use: ROHS Standard, Silver Plating Corrosion-resistant Stands, high-quality lighting components. These LEDs should last much longer than you think
- Various usage: Perfect for light decorations, electronic devices, digital devices, traffic light indicators, lighting, car components and so on
- Durable design: Made of premium quality material with ISO Standard manufacturing process, these LEDs are super durable



**POPULAR FOR TECH STUDENTS**

**ST-JW65MM**

**140 PCS 22AWG SOLID WIRES**

- Pre-Cut, Pre-Stripped and Pre-Formed on Each End
- Various Colors
- Completely Reusable
- 14 Length / 10 Pcs Each (2.5/5.1/7.7/10.3/12.7/15.3/17.8/20.1/22.8/25.4/51.3/76.3/101.3/126.3mm)

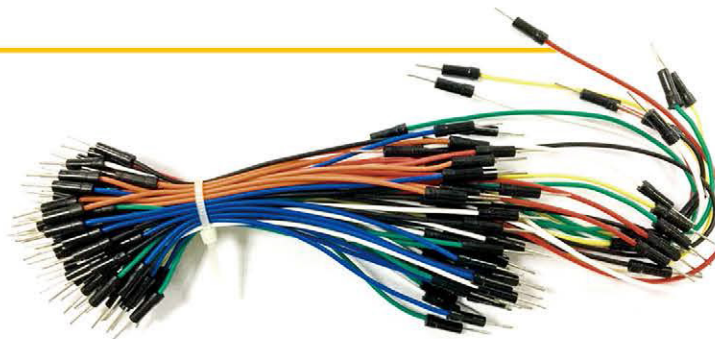

**POPULAR FOR TECH STUDENTS**

YCP-1.5	250V	1.5UF	± 5%
YCP-2.0	150V	2.0UF	± 5%
YCP-2.2	250V	2.2UF	± 5%
YCP-2.5	250V	2.5UF	± 5%
YCP-3.0	200V	3.0UF	± 5%
YCP-3.3	250V	3.3UF	± 5%
YCP-4.7	200V	4.7UF	± 5%
YCP-10	250V	10UF	± 5%
YCP-22	250V	22UF	± 35%

**MYLAR CAPACITORS (25 PCS PER UNIT)**



**MV-30V**

**DIGITAL VOLTMETER**

- Product Size: 48 x 29 x 21mm.
- Mounting Cutout: 45.5 x 26.5 mm.
- Voltage Test Range: 4.5 - 30V



**BUZ-324-85**

**ELECTRIC BUZZER WITH WIRE**

- Maximum input Voltage: 3-24VDC
- Operating Temperature Range: -20°C ~ +60°C
- Storage Temperature: -30°C ~ +70°C
- Sound Pressure Level: 82dB at 12VDC/30mm
- Resonant Frequency: 3.7 ± 0.5KHz
- Max Rated Current: 100mA at 12VDC
- Tone Nature: Continuous



**MVA-100V**

**VOLTAGE & AMP DUAL DISPLAY METER WITH CURRENT SHUNT**

- Size: 48mm x 29mm x 21mm
- Mounting Cutout: 45.5mm x 26.5mm
- Display Color: Red & Blue LED (Dual Display)
- Display: 0.28" LED Digital
- Operating Voltage: DC 4.5 ~ 30V
- Measure Voltage: DC 0 ~ 100V
- Minimum Resolution (V): 0.1V
- Refresh Rate: ≥500ms / times
- Measure Accuracy: 1% (± 1 Digit)
- Minimum Resolution (A): 0.01A
- Operating Current: <20mA
- Measure Current: 100A (with Current Shunt)
- Operating Temperature: -10 to 65°C
- Operating Humidity: 10 to 80% (Non-Condensing)



**MVT-230C**

**DIGITAL THERMOMETER (CELCIUS)**

- LCD Size: 1.4" x 0.6" (36x16mm)
- Power Source: 2 x LR44
- Cable Length: 3'/1M
- Meter Size: 1.9" x 1.1" x 0.6" (47.8 x 28.5 x 14.3mm)
- Mounting Cutout: 1.8" x 1.1" (46.2 x 26.7mm)
- Temperature Measurement Range: -5°C~110°C
- Operating Temperature: -5°C~50°C
- Extra Batteries Included



**MVT-230F**

**DIGITAL THERMOMETER (FAHRENHEIT)**

- LCD Size: 1.4" x 0.6" (36x16mm)
- Power Source: 2 x LR44
- Cable Length: 3'/1M
- Meter Size: 1.9" x 1.1" x 0.6" (47.8 x 28.5 x 14.3mm)
- Mounting Cutout: 1.8" x 1.1" (46.2 x 26.7mm)
- Temperature Measurement Range: -58°F~166°F
- Operating Temperature: 23°F~122°F
- Extra Batteries Included





# POWER PRODUCTS



## PIUB-1200-12X

**NEW**

### 1200 WATTS 12V DC TO 110V AC POWER INVERTER / BATTERY CHARGER

- Power: 1200W Max, 600W RMS
- DC input voltage: 12V
- Fuse: 25A x 3
- Output wave form: pure sine wave
- Output voltage: 110V ± 5%
- Output frequency: 60Hz ± 5%
- With DC input voltage protection, short circuit protection and temperature protection
- \* Backup times vary according to battery bank size and output consumption



The major advantage of a pure sine wave inverter is that all of the equipment which is sold on the market is designed for a pure sine wave. This guarantees that the equipment will work to its full specifications.

**WORKS AS A LARGE CAPACITY UPS GET UP TO 12 HOURS OF BACKUP FOR YOUR ELECTRONIC DEVICES! DOUBLES AS A BATTERY CHARGER WHEN PLUGGED INTO A POWER OUTLET.**



12V DC TO 110V AC **1200 WATTS**

## PIUB-3000-24X

**NEW**

### 3000 WATTS 24V DC TO 110V AC POWER INVERTER / BATTERY CHARGER

- Power: 3000W Max, 1500W RMS
- DC input voltage: 24V
- Fuse: 25A x 4
- Output wave form: pure sine wave
- Output voltage: 110V ± 5%
- Output frequency: 60Hz ± 5%
- With DC input voltage protection, short circuit protection and temperature protection
- \* Backup times vary according to battery bank size and output consumption



The major advantage of a pure sine wave inverter is that all of the equipment which is sold on the market is designed for a pure sine wave. This guarantees that the equipment will work to its full specifications.

**WORKS AS A LARGE CAPACITY UPS GET UP TO 12 HOURS OF BACKUP FOR YOUR ELECTRONIC DEVICES! DOUBLES AS A BATTERY CHARGER WHEN PLUGGED INTO A POWER OUTLET.**



12V DC TO 110V AC **3000 WATTS**



**PSW-3000C**

**3000 WATTS - 12V DC TO 120V AC  
PURE SINE WAVE POWER INVERTER**

**PERFECT FOR SOLAR PANELS! GET UP TO 12 HOURS OF BACKUP FOR YOUR ELECTRONIC DEVICES. DOUBLES AS A BATTERY CHARGER WHEN PLUGGED INTO A POWER OUTLET.**

- Max continuous power: 1500W
- Peak power: 3000W
- Input Voltage: 12V DC (10-15V)
- Output Voltage: 120V AC, 60Hz
- Waveform: Pure sine wave
- THD (Total Harmonic Distortion): Less than 4%
- USB Output: 5V DC, 2A Max
- Best efficiency: >85%
- Protection: Overload, Over Voltage, Low Voltage, Over temperature, Output short
- Output receptacle: Dual ETL Approval Sockets
- American standard receptacle
- Battery connecting cables: Red & Black 2ft length
- With ON/OFF wire remote control kit



12V DC TO 120V AC  
**3000 WATTS**



The major advantage of a pure sine wave inverter is that all of the equipment which is sold on the market is designed for a pure sine wave. This guarantees that the equipment will work to its full specifications.

**PSW-5000C**

**5000 WATTS - 12V DC TO 120V AC  
PURE SINE WAVE POWER INVERTER**

**PERFECT FOR SOLAR PANELS! GET UP TO 12 HOURS OF BACKUP FOR YOUR ELECTRONIC DEVICES. DOUBLES AS A BATTERY CHARGER WHEN PLUGGED INTO A POWER OUTLET.**

- Max continuous power: 2500W
- Peak power: 5000W
- Input Voltage: 12V DC (10-15V)
- Output Voltage: 120V AC, 60Hz
- Waveform: Pure sine wave
- THD (Total Harmonic Distortion): Less than 4%
- USB Output: 5V DC, 2A Max
- Best efficiency: >85%
- Protection: Overload, Over Voltage, Low Voltage, Over temperature, Output short
- Output receptacle: Dual ETL Approval Sockets
- American standard receptacle
- Battery connecting cables: Red & Black 2ft length
- With ON/OFF wire remote control kit



12V DC TO 120V AC  
**5000 WATTS**



The major advantage of a pure sine wave inverter is that all of the equipment which is sold on the market is designed for a pure sine wave. This guarantees that the equipment will work to its full specifications.

**PIB-300D**

**300 WATTS 12V DC TO 115V AC  
POWER INVERTER**

- Input: 10.0~15.0V DC
- Power: 300W RMS, 600W Max
- Output: 110~120V AC
- Dual USB Output: 5V, 2A
- Output Frequency: 60Hz ± 2Hz
- Input Over Voltage Shutdown
- Input Under Voltage Warning
- Input Under Voltage Shutdown
- Input Fuse Protection
- Over Temperature Shutdown
- Output Short Circuit Protection
- Over Load Protection
- Digital Display

12V DC TO 115V AC  
**300 WATTS**



**PIB-500D**

**POPULAR**

**500 WATTS 12V DC TO 115V AC  
POWER INVERTER**

- Input: 10.0~15.0V DC
- Power: 500W RMS, 1000W Max
- Output: 110~120V AC
- Dual USB Output: 5V, 2A
- Output Frequency: 60Hz ± 2Hz
- Input Over Voltage Shutdown
- Input Under Voltage Warning
- Input Under Voltage Shutdown
- Input Fuse Protection
- Over Temperature Shutdown
- Output Short Circuit Protection
- Over Load Protection
- Digital Display

12V DC TO 115V AC  
**500 WATTS**



**PIB-750D**

**750 WATTS 12V DC TO 115V AC  
POWER INVERTER**

- Input: 10.0~15.0V DC
- Power: 750W RMS, 1500W Max
- Output: 110~120V AC
- Dual USB Output: 5V, 2A
- Output Frequency: 60Hz ± 2Hz
- Input Over Voltage Shutdown
- Input Under Voltage Warning
- Input Under Voltage Shutdown
- Input Fuse Protection
- Over Temperature Shutdown
- Output Short Circuit Protection
- Over Load Protection
- Digital Display

12V DC TO 115V AC  
**750 WATTS**



**PIB-1000D**

**1000 WATTS 12V DC TO 115V AC  
POWER INVERTER**

- Input: 10.0~15.0V DC
- Power: 1000W RMS, 2000W Max
- Output: 110~120V AC
- Dual USB Output: 5V, 2A
- Output Frequency: 60Hz ± 2Hz
- Input Over Voltage Shutdown
- Input Under Voltage Warning
- Input Under Voltage Shutdown
- Input Fuse Protection
- Over Temperature Shutdown
- Output Short Circuit Protection
- Over Load Protection
- Digital Display

12V DC TO 115V AC  
**1000 WATTS**





**PI-75U**

**NEW**

**75 WATTS - 12V DC TO 120V AC MOBILE POWER INVERTER**

- Provides a maximum 75W of power, 140W of peak power, and 60W of continuous power.
- Maximum power: The first 5 minutes of power. After 5 minutes, the inverter can only supply continuous power.
- Peak power: For electronic appliances that have a motor, a quick surge of power is required to start it.
- Continuous power: The power that the inverter can support for as long as the battery has capacity.
- Audible alarm warns of low battery voltage.
- Auto shutdown protects against overload, short-circuit, over temperature and low and high battery condition.

**CONVERTS 12V DC BATTERY POWER TO 120V AC HOUSEHOLD ELECTRICAL POWER. FOR USE IN CARS, TRUCKS, BOATS, AND RVs.**



**PI-200A**

**200 WATTS**  
12V DC TO 110V AC

**200 WATTS - 12V DC TO 110V AC POWER INVERTER**

- Maximum Continuous Power: 200W
- Peak Load Power Rate: Up to 400W
- For Use with 12 Volt Systems
- No Load Current Draw: Up to 0.3 Amps
- Waveform: Modified Sine Wave
- Input DC Voltage Range: DC 11V-15V
- USB Output: 5V/2.4A
- Overload and Short-Circuit Protection
- (1) Replaceable External 20 Amp Fuse
- Built-In Cooling Fan
- (2) 110V AC 3 Prong Grounded Receptacles
- Overload Indicator
- 14 AWG 24" Cigarette Plug Cable
- Fin-type heat sink for more efficient heat dissipation



**PI-120U**

**NEW**

**120 WATTS - 12V DC TO 120V AC MOBILE POWER INVERTER**

- Fast charge USB2.0 (2.1A output) charge port for tablets and most mobile devices.
- Provides a maximum 120W of power, 200W of peak power, and 100W of continuous power.
- Maximum power: The first 5 minutes of power. After 5 minutes, the inverter can only supply continuous power.
- Peak power: For electronic appliances that have a motor, a quick surge of power is required to start it.
- Continuous power: The power that the inverter can support for as long as the battery has capacity.
- Auto shutdown protects against overload, short-circuit, over temperature and low and high battery condition.

**CONVERTS 12V DC BATTERY POWER TO 120V AC HOUSEHOLD ELECTRICAL POWER. FOR USE IN CARS, TRUCKS, BOATS, AND RVs.**



**PI-400A BEST SELLER**

**400 WATTS**  
12V DC TO 110V AC

**400 WATTS - 12V DC TO 110V AC POWER INVERTER**

- Max continuous power: 400W
- Peak load power rate: up to 800W
- For use with 12 Volt systems
- No load current draw: up to 0.5 Amps
- Waveform: modified sine wave
- Input DC voltage range: DC 10V-15V
- USB Output: 5V/2.4A
- Overload and short-circuit protection
- (1) Replaceable External 40 Amp fuse
- Built-in cooling fan
- (2) 110V AC 3 prong grounded receptacles
- Overload indicator
- 18 AWG 24" cigarette plug cable
- Fin-type heat sink for more efficient heat dissipation





**PI-800C**

**800 WATTS - 12V DC TO 120V AC POWER INVERTER**

- Max Continuous Power: 800W
- Peak Load Power Rate: up to 1600W
- For Use with 12V DC Voltage Systems
- No Load Current Draw: up to 0.9 Amps
- Waveform: Modified Sine Wave
- Input DC Voltage Range: 10V-15V DC
- USB Output: 5V/2.4A
- Overload and Short-Circuit Protection
- (1) Replaceable 30 Amp Fuse
- Built-In Cooling Fan
- (2) 120V AC Volt 3 Prong Grounded American Standard Receptacles
- Overload Indicator

12V DC  
TO  
120V AC  
**800  
WATTS**



**PI-1500C**

**1500 WATTS - 12V DC TO 120V AC POWER INVERTER**

- Max Continuous Power: 1500W
- Peak Load Power Rate: up to 3000W
- For use with 12V DC Voltage Systems
- No Load Current Draw: up to 0.9 Amps
- Waveform: Modified Sine Wave
- Input DC Voltage Range: 10V-15V DC
- USB Output: 5V/2.4A
- Overload and Short-Circuit Protection
- (1) Built-in 6 x 30 Amp Fuses
- Built-In Cooling Fan
- (2) 120V AC Volt 3 Prong Grounded American Standard Receptacles
- Overload Indicator

12V DC  
TO  
120V AC  
**1500  
WATTS**



**PI-1000R**

**1000 WATTS - 12V DC TO 120V AC POWER INVERTER**

- Continuous Power: 1000W
- Peak Load Power Rate: up to 2000W
- For use with 12V DC Voltage Systems
- No Load Current Draw: up to 0.9 Amps
- Waveform: Modified Sine Wave
- Input DC Voltage Range: 10V-15V DC
- USB Output: 5V/2.4A
- Overload and Short-Circuit Protection
- (1) Built-in 6 x 30 Amp Fuses
- Built-In Cooling Fan
- (2) 120V AC Volt 3 Prong Grounded American Standard Receptacles
- Overload Indicator

12V DC  
TO  
120V AC  
**1000  
WATTS**



**PI-1500R**

**1500 WATTS - 12V DC TO 120V AC POWER INVERTER**

- Nominal Input Voltage: 12.8-13.2V DC
- Nominal Output Voltage: 115±10%V AC
- Output Frequency: 60±3 Hz
- Operating Input Voltage: 10-15V DC
- Continuous Output Power: Up to 1500W
- Surge Output Power: 3000W
- Waveform: Modified Sine Wave
- Efficiency (Typical): 85%
- Input Overvoltage Shutdown: 15.5±0.5V DC
- Input Undervoltage Alarm: 10.5±0.5V DC
- Input Low Voltage Shutdown: 10.0±0.5V DC
- Output Power Overload Shutdown Level: 1800±300W
- Input Fuse: 6 x 30A
- USB Port: Two, 5V/2A

12V DC  
TO  
120V AC  
**1500  
WATTS**



**PI-DP-3000C** **NEW** **POPULAR**

**3000 WATTS - 12V DC TO 110V AC POWER INVERTER**

- Continuous Power: 1500W
- Peak Load Power Rate: up to 3000W
- Equivalent to standard household power
- Delivers high quality, clean power for superior performance
- Easy motor start-ups
- Reduced noise
- Reduced stress on circuitry
- Cost-effective
- High efficiency
- Light and portable
- Strong capatability with most devices
- Not compatible with induction load devices such as medical equipment

12V DC  
TO  
110V AC  
**3000  
WATTS**



**CONVERTS 12V DC BATTERY POWER TO 110V AC HOUSEHOLD ELECTRICAL POWER. FOR USE IN CARS, TRUCKS, BOATS, AND RVs.**





**PI-24110-400C**

**400 WATTS - 24V DC TO 110V AC POWER INVERTER**

- Max continuous power: 400W
- Peak load power rate: up to 800W
- For use with 24V DC voltage systems
- No load current draw: up to 0.2 Amps
- Waveform: modified sine wave
- Input DC voltage range: 20V - 30V DC
- USB Output: 5V/2.4A
- Overload and short-circuit protection
- (1) Replaceable 20 Amp fuse
- Built-in cooling fan
- (2) 120V AC Volt 3 prong grounded American standard receptacles
- Overload indicator

24V DC  
TO  
110V AC  
**400  
WATTS**



**PI-24110-800C**

**800 WATTS - 24V DC TO 110V AC POWER INVERTER**

- Max continuous power: 800W
- Peak load power rate: up to 1600W
- For use with 24V DC voltage systems
- No load current draw: up to 0.4 Amps
- Waveform: modified sine wave
- Input DC voltage range: 20V - 30V DC
- USB Output: 5V/2.4A
- Overload and short-circuit protection
- (1) Replaceable 20 Amp fuse
- Built-in cooling fan
- (2) 120V AC Volt 3 prong grounded American standard receptacles
- Overload indicator

24V DC  
TO  
110V AC  
**800  
WATTS**



**PI-24110-2000C**

**2000 WATTS - 24V DC TO 110V AC POWER INVERTER**

- DC 24V to AC 110V
- Frequency: 60Hz ± 5%
- Output Waveform: Modified sine wave
- Low Battery Voltage Alarm: 21 ± 1V
- Continuous Power: 2000W
- Surge Capability: 4000W
- Output Voltage: 110V
- Input Voltage: 24V DC
- Efficiency: >90%
- Static current: <1mA
- Output overloading protection: 2400W

24V DC  
TO  
110V AC  
**2000  
WATTS**



**PI-DCDC-2412-10**

**10A - 24V DC TO 12V DC CONVERTER**

- Output Power: 10Amp (Continuous) 15 Amp Max
- Standby Current: <0.02A
- Input Voltage: DC 20V~30V
- Output Voltage: DC 12V~13.8V
- Efficiency: >90%
- Cooling: By Air Convection
- Fuse: 10A x 1PC
- Dimensions (LxWxH): 110x87x42mm
- Net Weight: 0.45Kg

24V DC  
TO  
12V DC  
**10  
AMP** **MOST  
DEPENDABLE  
FOR CIRCUIT  
PROTECTION**



**PI-DCDC-2412-30**

**30A - 24V DC TO 12V DC CONVERTER**

- Output Power: 30Amp (Continuous) 45 Amp Max
- Standby Current: <0.08A
- Input Voltage: DC 20V~30V
- Output Voltage: DC 12V~13.8V
- Efficiency: 85~90%
- Over Load: Circuit Protection
- Input Fuse: 30A
- Dimensions (LxWxH): 222x115x62mm
- Net Weight: 0.95Kg

24V DC  
TO  
12V DC  
**30  
AMP** **MOST  
DEPENDABLE  
FOR CIRCUIT  
PROTECTION**



**PI-DCDC-2412-100**

**100A - 24V DC TO 12V DC CONVERTER**

- Output Power: 100 Amp (Continuous), 130 Amp Max
- Standby Current: ≤1.10A
- Input Voltage: DC 20V~30V
- Output Voltage: DC 12V~13.8V
- Efficiency: 85~90%
- Thermal Protection: 65°C +/- 5°C
- Input Polarity Reverse: Diode Protection
- Output Polarity Reverse: Circuit Protection
- Output Short: Circuit Protection
- Over Heating: Circuit Protection
- Over Load: Circuit Protection
- Input Fuse: 4x30A
- Dimensions (L x W x H): 365x165x79mm
- Net Weight: 3.03Kg

24V DC  
TO  
12V DC  
**100  
AMP** **MOST  
DEPENDABLE  
FOR CIRCUIT  
PROTECTION**





**DC12-2405**

**5A - 24V DC TO 12V DC VOLTAGE CONVERTER**

- Input Voltage: DC 24V
- Output Voltage: DC 12V
- Maximum Current: 5A
- Fuse: 5A

**5 AMP**

**INDUSTRY GRADE DC24V TO 12V STEP DOWN CONVERTER. WIDELY USED FOR AUTOMOTIVE, BUS, AND TRUCK APPLICATIONS. SAFELY INTEGRATES CAR AUDIO PRODUCTS, SECURITY SYSTEMS, LED VIDEO MONITORS, TELECOMMUNICATIONS AND OTHER 12V AFTER MARKET PRODUCTS.**



**DC12-2415**

**15A - 24V DC TO 12V DC VOLTAGE CONVERTER**

- Input Voltage: DC 24V
- Output Voltage: DC 12V
- Maximum Current: 15A
- Fuse: 15A

**24V DC TO 12V DC**

**15 AMP**



**DC12-2430**

**15A - 24V DC TO 12V DC VOLTAGE CONVERTER**

- Input Voltage: DC 24V
- Output Voltage: DC 12V
- Maximum Current: 30A
- Fuse: 30A

**24V DC TO 12V DC**

**30 AMP**



**FT230D**

**NEW**

**600 WATT HIGH PERFORMANCE AGM BATTERY**

- Weight: 13.89 lbs
- Dimensions: 7.13 x 3.03 x 6.57in
- Group Size: BT19BL-BS
- Voltage: 12 Volt
- Terminal Type: M6
- CCA: 180
- CA or MCA: 240
- HCA: 290
- PHCA: 500
- Capacity: @ 20hr Rate: 22
- Reserve Capacity @ 25 Amps: 22
- Watts: 600
- Internal Resistance: 17.0mΩ

**600 WATTS**



CYCLING CAPACITY		RESERVE CAPACITY	
20 Hour Rate	22 Amp Hours	Reserve @25 AMPS	28 Minutes
		Reserve @75 AMPS	5.5 Minutes
ELECTRICAL SPECIFICATIONS		MECHANICAL SPECIFICATIONS	
Nominal Voltage	12 Volt	Group Size	-
C100	24 AH	Terminal Type	M6
C20	22 AH	Terminal Torque	See reverse side
C5	18.7 AH	Height (w/ terminal)	6.57" 167 mm
Short Circuit Current	627 Amps	Height (case only)	6.57" 167 mm
CCA	210 Amps	Width	3.03" 77 mm
CA or MCA	275 Amps	Length	7.13" 181 mm
PHCA	550 Amps	Weight	13.31 lbs 6.05 kg
Internal Resistance	11 mΩ	Case Type	ABS Plastic - Flame Res. Rating UL94-HB

**ODYSSEY BATTERY**  
CROSS-REFERENCE  
**PC680**



**FT410**

**NEW**

**900 WATT HIGH PERFORMANCE AGM BATTERY**

- Weight: 23.15 lbs
- Dimensions: 6.5 x 6.93 x 5.67in
- Voltage: 12 Volt
- Terminal Type: M6 + TP26
- CCA: 410
- CA or MCA: 530
- HCA: 625
- PHCA: 925
- Capacity: @ 20hr Rate: 28
- Reserve Capacity @ 25 Amps: 48
- Reserve Capacity @ 75 Amps: 6
- Watts: 900
- Internal Resistance: 9.1mΩ

**900 WATTS**



CYCLING CAPACITY		RESERVE CAPACITY	
20 Hour Rate	28 Amp Hours	Reserve @25 AMPS	48 Minutes
		Reserve @75 AMPS	10.1 Minutes
ELECTRICAL SPECIFICATIONS		MECHANICAL SPECIFICATIONS	
Nominal Voltage	12 Volt	Group Size	-
C100	31 AH	Terminal Type	M6 + TP26 (SAE)
C20	28 AH	Terminal Torque	See reverse side
C5	23 AH	Height (w/ terminal)	5.64" 144 mm
Short Circuit Current	1382 Amps	Height (case only)	4.92" 125 mm
CCA	410 Amps	Width	6.93" 176 mm
CA or MCA	530 Amps	Length	6.50" 165 mm
PHCA	925 Amps	Weight	23.6 lbs 10.7 kg
Internal Resistance	6.6 mΩ	Case Type	ABS Plastic - Flame Res. Rating UL94-HB

**ODYSSEY BATTERY**  
CROSS-REFERENCE  
**PC925**





**FT560**

**NEW**

**1200 WATT HIGH PERFORMANCE AGM BATTERY**

- Weight: 33.29 lbs
- Dimensions: 7.8 x 6.54 x 7.09in
- Group Size: 26R
- Voltage: 12 Volt
- Terminal Type: M6 + TP26
- CCA: 560
- CA or MCA: 725
- HCA: 860
- PHCA: 1200
- Capacity: @ 20hr Rate: 44
- Reserve Capacity @ 25 Amps: 80
- Reserve Capacity @ 75 Amps: 14.2
- Watts: 1200
- Internal Resistance: 4.5mΩ

**1200 WATTS**



CYCLING CAPACITY		RESERVE CAPACITY	
20 Hour Rate	<b>44 Amp Hours</b>	Reserve @25 AMPS	<b>80 Minutes</b>
		Reserve @75 AMPS	<b>14.2 Minutes</b>

ELECTRICAL SPECIFICATIONS		MECHANICAL SPECIFICATIONS	
Nominal Voltage	<b>12 Volt</b>	Group Size	-
C100	<b>48 AH</b>	Terminal Type	<b>M6 + TP26 (SAE)</b>
C20	<b>44 AH</b>	Terminal Torque	<b>See reverse side</b>
C5	<b>35 AH</b>	Height (w/ terminal)	<b>7.08"</b>
Short Circuit Current	<b>2600 Amps</b>	Height (case only)	<b>6.69"</b>
CCA	<b>560 Amps</b>	Width	<b>6.54"</b>
CA or MCA	<b>725 Amps</b>	Length	<b>7.80"</b>
PHCA	<b>1200 Amps</b>	Weight	<b>33.3 lbs</b>
Internal Resistance	<b>2.7 mΩ</b>	Case Type	<b>ABS Plastic - Flame Res. Rating UL94-HB</b>

**ODYSSEY BATTERY**  
CROSS-REFERENCE  
**PC1200**



**FT825-34**

**NEW**

**2000 WATT HIGH PERFORMANCE AGM BATTERY**

- Weight: 46.08 lbs
- Dimensions: 10.28 x 6.77 x 8.19in
- Group Size: 34
- Voltage: 12 Volt
- Terminal Type: M8 + TP28
- CCA: 825
- CA or MCA: 1000
- HCA: 1200
- PHCA: 1500
- Capacity: @ 20hr Rate: 65
- Reserve Capacity @ 25 Amps: 135
- Reserve Capacity @ 75 Amps: 22
- Watts: 2000
- Internal Resistance: 5.1mΩ

**2000 WATTS**



CYCLING CAPACITY		RESERVE CAPACITY	
20 Hour Rate	<b>65 Amp Hours</b>	Reserve @25 AMPS	<b>135 Minutes</b>
		Reserve @75 AMPS	<b>22 Minutes</b>

ELECTRICAL SPECIFICATIONS		MECHANICAL SPECIFICATIONS	
Nominal Voltage	<b>12 Volt</b>	Group Size	<b>34 / 78</b>
C100	<b>72 AH</b>	Terminal Type	<b>M8 + TP28 (SAE)</b>
C20	<b>65 AH</b>	Terminal Torque	<b>See reverse side</b>
C5	<b>52 AH</b>	Height (w/ terminal)	<b>8.07"</b>
Short Circuit Current	<b>2138 Amps</b>	Height (case only)	<b>7.20"</b>
CCA	<b>825 Amps</b>	Width	<b>6.77"</b>
CA or MCA	<b>1000 Amps</b>	Length	<b>10.28"</b>
PHCA	<b>1500 Amps</b>	Weight	<b>45.9 lbs</b>
Internal Resistance	<b>2.5 mΩ</b>	Case Type	<b>ABS Plastic - Flame Res. Rating UL94-HB</b>

**ODYSSEY BATTERY**  
CROSS-REFERENCE  
**34-PC1500**

**OPTIMA BATTERIES**  
CROSS-REFERENCE  
**34 #8002-002**  
**D34 #8012-021**



**FT930-65**

**NEW**

**2400W HIGH PERFORMANCE AGM BATTERY**

- Weight: 54.90 lbs
- Dimensions: 11.81 x 7.17 x 7.24in
- Group Size: 65
- Voltage: 12 Volt
- Terminal Type: M8 + TP28
- CCA: 930
- CA or MCA: 1070
- HCA: 1350
- PHCA: 1750
- Capacity: @ 20hr Rate: 75
- Reserve Capacity @ 25 Amps: 168
- Reserve Capacity @ 75 Amps: 26.1
- Internal Resistance: 3.1mΩ

**2400 WATTS**



CYCLING CAPACITY		RESERVE CAPACITY	
20 Hour Rate	<b>75 Amp Hours</b>	Reserve @25 AMPS	<b>142 Minutes</b>
		Reserve @75 AMPS	<b>26.1 Minutes</b>

ELECTRICAL SPECIFICATIONS		MECHANICAL SPECIFICATIONS	
Nominal Voltage	<b>12 Volt</b>	Group Size	<b>65</b>
C100	<b>82 AH</b>	Terminal Type	<b>M8 + TP28 (SAE)</b>
C20	<b>75 AH</b>	Terminal Torque	<b>See reverse side</b>
C5	<b>60 AH</b>	Height (w/ terminal)	<b>7.36"</b>
Short Circuit Current	<b>4000 Amps</b>	Height (case only)	<b>6.69"</b>
CCA	<b>930 Amps</b>	Width	<b>7.17"</b>
CA or MCA	<b>1070 Amps</b>	Length	<b>11.81"</b>
PHCA	<b>1750 Amps</b>	Weight	<b>57.5 lbs</b>
Internal Resistance	<b>2.0 mΩ</b>	Case Type	<b>ABS Plastic - Flame Res. Rating UL94-HB</b>

**ODYSSEY BATTERY**  
CROSS-REFERENCE  
**65-PC1750**



**FT1100-31**

**NEW**

**4000W HIGH PERFORMANCE AGM BATTERY**

- Weight: 75.18 lbs
- Dimensions: 12.99 x 6.81 x 9.13in
- Group Size: 31
- Voltage: 12 Volt
- Terminal Type: M8 + TP28
- CCA: 1100
- CA or MCA: 1360
- HCA: 1560
- PHCA: 2200
- Capacity: @ 20hr Rate: 110
- Reserve Capacity @ 25 Amps: 230
- Reserve Capacity @ 75 Amps: 50
- Internal Resistance: 2.3mΩ

**4000 WATTS**



CYCLING CAPACITY		RESERVE CAPACITY	
20 Hour Rate	<b>110 Amp Hours</b>	Reserve @25 AMPS	<b>230 Minutes</b>
		Reserve @75 AMPS	<b>50 Minutes</b>

ELECTRICAL SPECIFICATIONS		MECHANICAL SPECIFICATIONS	
Nominal Voltage	<b>12 Volt</b>	Group Size	<b>31</b>
C100	<b>121 AH</b>	Terminal Type	<b>M8 + TP28</b>
C20	<b>110 AH</b>	Terminal Torque	<b>See reverse side</b>
C5	<b>91 AH</b>	Height (w/ terminal)	<b>9.13"</b>
Short Circuit Current	<b>5000 Amps</b>	Height (case only)	<b>8.43"</b>
CCA	<b>1150 Amps</b>	Width	<b>6.81"</b>
CA or MCA	<b>1360 Amps</b>	Length	<b>12.99"</b>
PHCA	<b>2200 Amps</b>	Weight	<b>77.4 lbs</b>
Internal Resistance	<b>2.2 mΩ</b>	Case Type	<b>ABS Plastic - Flame Res. Rating UL94-HB</b>

**ODYSSEY BATTERY**  
CROSS-REFERENCE  
**PC2150**

**OPTIMA BATTERIES**  
CROSS-REFERENCE  
**D31A #8051-160**





**LBCP-12-6**

**NEW**

**20 AMP POWER SUPPLY**

- Input voltage: AC 115V/60Hz
- Rated Power: 103W
- Output Voltage: 12V DC
- Rated Current: 4.2A
- Peak Current: 6A
- Battery Types: 12V DC (Lead-acid battery)
- Battery Capacity: 14-84Ah
- Plastic shell
- Overheating protection
- Short circuit protection

**12 6**  
VOLT AMP



**LBCH-612SW**

**6 AMP POWER SUPPLY**

- Intelligent charge technology, multi-stage 6/12V 6A charging for added precision, safety and battery life
- Blade Type Fuse
- Overload Protection
- Fast Charging
- Comes with 6ft power cord and 4ft DC output cords with alligator clips
- Shockproof and corrosion proof

**6/12 6**  
VOLT AMP



**LBCH-80M**

**20 AMP POWER SUPPLY**

- Thermal Overload Safety
- Electronic LED Display
- CE Approved
- For 12V Car, Motorcycle & Lawnmower Batteries
- 12V, 20 Amp
- Power supply mode provides stable power to maintain system voltage for use in a wide variety of applications
- This charger also has an 80 amp Engine Start charging capability
- Easily switch between trickle charge or heavy duty charge

**12 20**  
VOLT AMP



**EX-JUMP6-16**

**6 GA - 16FT JUMPER CABLE**

- 6Ga, 16 FT.
- Tangle Free Construction
- Phase Marked Clamps for Added Safety
- High/Low Temperature Construction
- Extra Flexible



**EX-JUMP4-20**

**4 GAUGE - 20FT JUMPER CABLE**

- 4Ga, 20 FT.
- Tangle Free Construction
- Phase Marked Clamps for Added Safety
- High/Low Temperature Construction
- Extra Flexible for Easy Use



**NB-770**

**POWER INVERTER BATTERY CABLE**

- 70A
- 10ft Length
- 12Ga
- Two alligator clamp on one end and two ring terminals on the other end



**NB-880**

**POWER INVERTER BATTERY CABLE**

- 80A
- 10ft Length
- 10Ga
- Two alligator clamp on one end and two ring terminals on the other end





**NB-440 BLK/RED (30 AMP)**  
**NB-550 BLK/RED (50 AMP)**  
**NB-660 BLK/RED (60 AMP)**



**BATTERY CLIPS**

**TRBM-12-125A**

**AUTOMATIC BATTERY MAINTAINER & FLOAT CHARGER**

- Switch - Mode Technology
- Input: 110V AC, 60Hz, 0.25A
- Output: 12V Nominal, 0.75A
- Standby Power Consumption: <0.5W
- Maximum Operating Temperature: (122°F (50°C))



**TRBM-1224-6A**

**INTELLEGT BATTERY CHARGER**

- Input Voltage: 110V AC, 60Hz or 230V AC, 50Hz
- Output Voltage: 12V & 24V (auto - select)
- Charging Voltage: 28.8V ± 0.25V, or 29.4V ± 0.25V or 14.4V ± 0.25V or 13.6V ± 0.25V or 16.5V ± 0.25V
- Charging Current: 6.0A ± 10% or 4.0A ± 10% or 3.0A ± 10% or 2.5A ± 10% or 1.5A ± 10%
- Ambient Temp: -20°C ~ +40°C / -4°F ~ 104°F, Reduced Output Power at Higher Temperature
- Battery Types: 12V & 24V Lead-Acid Batteries (WET, MF, AGM and GEL)



**IS-QFH18**

**FUSE CABLE**

- Vinyl Ring Tounge Terminal
- ATC 7.5 AMP Blade type Fuse Included
- Quick Disconnect Power Cable
- 2' Long

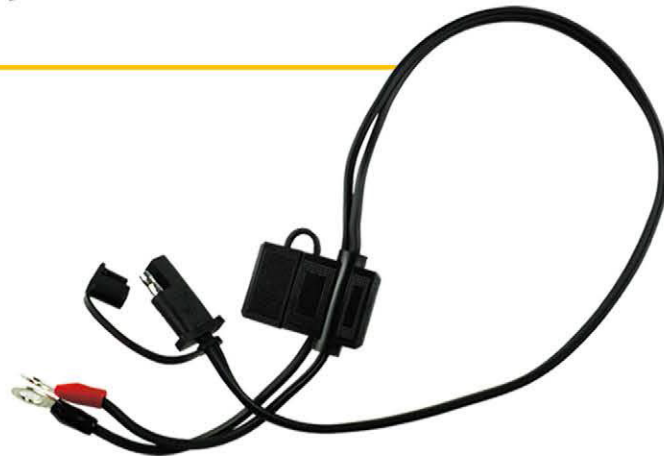

**TRMB-12-1.5A**

**AUTOMATIC BATTERY CHARGER**

- Input: 100-240V AC, 50/60Hz, 0.45A
- Output: 12V DC 1.5A
- LED Indicator: Red-Charging/Green-Charged
- Lead-acid battery charger, specifically used for lamps, toys, solar energy equipment, etc.



**IS-CLE12**

**12V - 12' CIGARETTE LIGHTER EXTENSION CABLE**

- 12' length
- Wire gauge: 18 AWG
- 100% copper wire
- High quality molded cable for strenght and durability
- Male plug is fitted with a 15A fuse to protect your vehicle and devices and has LED light indication of power on
- Female plug is fitted with a dust and water protective cap
- Pefect for your favorite 12 Volt devices, like car tire inflators, spot lamps, cell phones, cooking appliances, car TV, vacuum cleaner and more



**NP-210**

**CIGARETTE LIGHTER PLUG TO TWO FEMALE JACKS**

- 3' length
- 12V DC
- 1 male cigarette lighter plug to 2 female receptacles
- Allows VCR, Video light or TV monitor hookups
- Simultaneous CB and Radar operation





# AIR COMPRESSORS, HORNS, & SIRENS

## CMP-10012

NEW

### 12V DC PORTABLE AIR COMPRESSOR

- Voltage: 12-14V DC
- Amperage: 15 Amps
- Air Flow: 25 LPM@0 PSI
- Max. Pressure: 100 PSI
- For use on car tires, sports equipment & more
- Compact & powerful pump motor
- Built-in carry handle
- Nozzle adaptors included

**25 LPM  
AIR FLOW**

CONVENIENTLY PLUG DIRECTLY INTO CIGARETTE LIGHTER SOCKET OF YOUR VEHICLE. MULTIPLE USES: INFLATE TIRES ON CARS, BIKES, SEDAN AND MIDSIZE SUV. UNIVERSAL VALVE CONNECTOR FOR SCHRADER VALVE IS READY TO USE. ADDITIONAL ADAPTERS INCLUDE NEEDLES VALVE (FOR BASKETBALL, BALLS), SHORT CONE/LONG CONE ADAPTERS (FOR INFLATABLE KAYAK, SWIMMING POOL ACCESSORIES, ETC)



## CMP-15015-B

NEW

### 12V DC PORTABLE AIR COMPRESSOR

- Voltage: 12-14V DC
- Amperage: 15 Amps
- Air Flow: 30 LPM@0 PSI
- Max. Pressure: 150 PSI
- For use on car tires, sports equipment & more
- Compact & powerful pump motor
- Built-in carry handle
- Nozzle adaptors included
- Carry bag included

**30 LPM  
AIR FLOW**

CONVENIENTLY PLUG DIRECTLY INTO CIGARETTE LIGHTER SOCKET OF YOUR VEHICLE. MULTIPLE USES: INFLATE TIRES ON CARS, BIKES, SEDAN AND MIDSIZE SUV. UNIVERSAL VALVE CONNECTOR FOR SCHRADER VALVE IS READY TO USE. ADDITIONAL ADAPTERS INCLUDE NEEDLES VALVE (FOR BASKETBALL, BALLS), SHORT CONE/LONG CONE ADAPTERS (FOR INFLATABLE KAYAK, SWIMMING POOL ACCESSORIES, ETC)



**CARRY  
BAG  
INCLUDED**



**THSY-6075-CST** **NEW**

**1 GALLON TANK AIR COMPRESSOR KIT**

- This on-board system is designed for use with any high-pressure air horn that requires an on-board air system
- Comes with a 3.5 liter air tank, heavy duty compressor, fuse, hose, fittings, thread sealant, and mounting hardware
- Ideal for all vehicles with a 12V DC system
- Air hose: 5mm diameter, 330mm length
- Anti-corrosion coating
- Precision welded
- Tank dimensions: 13" x 5" x 5.5"

**MADE IN TAIWAN**



**12V DC 15A      3.5 LITER      1 GALLON**

**THSY-6150-CST** **NEW**

**1.5 GALLON TANK AIR COMPRESSOR KIT**

- This on-board system is designed for use with any high-pressure air horn that requires an on-board air system
- Comes with a 5.6 liter air tank, heavy duty compressor, fuse, hose, fittings, thread sealant, and mounting hardware
- Ideal for all vehicles with a 12V DC system
- Air hose: 6mm diameter, 330mm length
- Anti-corrosion coating
- Precision welded
- Tank dimensions: 19" x 5" x 5.5"
- Compressor dimensions: 6.5" x 6.5" x 4.5"

**MADE IN TAIWAN**



**12V DC 15A      5.6 LITER      1.5 GALLON**

**THSY-3075C**

**3 LITER TANK AIR COMPRESSOR**

- Pressure: 90~120 PSI
- Output: 12V DC
- Volume: 3L (0.79 Gal)



**THSY-5150C**

**6 LITER TANK AIR COMPRESSOR**

- Pressure: 90~120 PSI
- Output: 12V DC
- Volume: 6L (1.59 Gal)



**THSY-3075KIT**

**AIR COMPRESSOR MOTOR REPAIR KIT**

- Replacement for THSY-3075C air compressor



**THSY-5150KIT**

**AIR COMPRESSOR MOTOR REPAIR KIT**

- Replacement for THSY-5150C air compressor

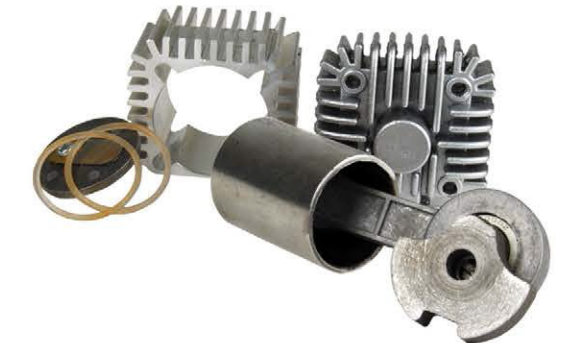

**THSY-GAUGE**

**AIR COMPRESSOR GAUGE**

- Replacement gauge for THSY-3075C and THSY-5150C

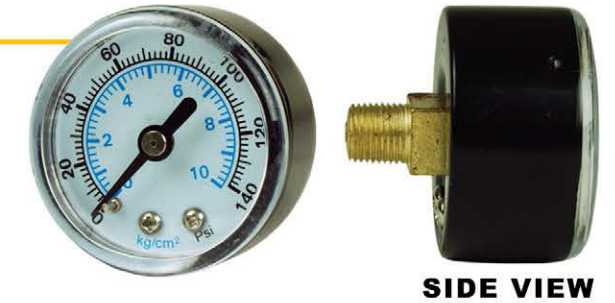

**SIDE VIEW**

**THSY-HOSE 25**

**AIR COMPRESSOR HOSE**

- Length: 25' (7.5M)
- 1/4" Ends Terminal made of Iron, GF High Pressure Resistant
- Compatible with THSY-3075C & THSY-5150C

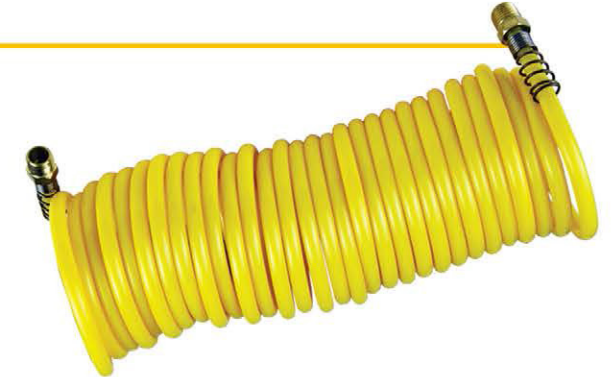

**THSY-HSE 7**

**AIR COMPRESSOR HOSE**

- 7'
- Compatible with: THSY-1075-HA, THSY-1075H, THSY-3075C, THSY-5150C



**THSY-HSOLE**

**REPLACEMENT HORN SOLENOID**

- Voltage: 12V/24V
- Current: 3.6A
- Power: 48W
- Air Pressure Range: 0.2~0.8 MPa





**THSY-2050-CH**

**NEW POPULAR**

**COMPACT AIR HORN COMPRESSOR SET**

- New Powerful High RPM Compressor
- Full Thermal Protection
- New Lubricating System
- Leak-Proof Nylon Hose
- Super Loud: 17 Decibels
- Use Air-Horn for Emergency Warning when on Highway, Mountain Road and Taking a Turn. Also Enriching Air for Car, Motorcycle, Ball, Yacht, Tire, Air-Free, Toys, etc.
- Small Size, Auto-Control Air Pressure, Excellent Very Loud Sound

**MADE IN TAIWAN**



**POWERFULL, LOUD SOUND IN A SMALL, COMPACT DESIGN**

**OUR ALL-INCLUSIVE COMPACT AIR HORN KIT IS PRIMED WITH EVERYTHING YOU NEED. THIS KIT IS READY FOR INSTALLATION RIGHT OUT OF THE BOX! OUR COMPRESSOR/TANK IS PRE-PLUMBED AND EVEN PRE-WIRED!**

**THSY-1615-CHET**

**NEW**

**3-WAY TRAIN HORN**

- Will give any 12/24V DC off road vehicle or truck the powerful sound of a train air horn.
- Engineered with the latest technology using reinforced ABS
- The horns are operated by a heavy-duty 12/24V DC electric solenoid valve
- Overall Dimensions: 16.5" x 14.5" x 11"
- Trumpet Sizes: 16" x 7.3"  
14.4" x 7.3"  
10.4" x 6.0"

**MADE IN TAIWAN**



**12V DC / 24V DC  
0.20A / 0.42A**

**THSY-1412-YH4T**

**NEW**

**4-WAY TRAIN HORN**

- Gives and 12/24V DC off-road vehicle or truck the powerful sound of a train air horn
- The horns are operated by a heavy-duty 12/24V DC electric solenoid valve
- The trumpets are finished with an attractive and durable high-quality zinc material
- Mounting hardware included
- Overall Dimensions: 6" x 6" x 14"
- Trumpet Sizes: 14.2" x 3.7"  
11.8" x 3.7"  
9.1" x 3.7"  
7.9" x 3.7"

**MADE IN TAIWAN**



**12V DC / 24V DC  
0.20A / 0.42A**

**THSY-1000**

**AIR COMPRESSOR & HORN KIT**

- DC 12V, 26.5A, 320W
- Material: Zinc Alloy Totally 2 Horns + Aluminum Base
- Size: 168 x Φ75mm, 207 x Φ76mm
- Weight: 0.95 Kgs
- 110 ± 5dB



**THSY-1075-H4**

**4-WAY TRAIN HORN**

- Material: Zinc Alloy Totally 4 Horns:
- 2 Small Horn: Length: 280mm, Diameter of the Mount 160mm
- 1 Media Horn: Length: 344mm, Diameter of the Mount 160mm
- 1 Large Horn: Length: 396mm, Diameter of the Mount 160mm
- 12V/24V, JGK-505VALVE (with Copper Coil)
- Weight: 6 Kgs
- 125 DB
- 290/421/548/648 HZ



**THSY-1075-EC**

**4-WAY TRAIN HORN**

- Material: Zinc Alloy totally Horns + Chromed Plastic Base,
- Smaller than THSY-1075H
- Size: 230\*93mm, 306\*96mm, 350\*96mm, 375\*96mm
- 12V/24V, JGK-505 Big VALVE (with Copper Coil)
- Weight: 1.5 Kgs
- 125 DB
- 290/421/548/648 HZ



**THSY-1075H**

**3-WAY TRAIN HORN**

- Air Pressure: 0.4~0.8MPa
- Current: 3.5-7.0A
- Voltage: 12-24V
- Sound Level: 125 ± 5dB



**THSY-1075-DH**

**2-WAY TRAIN HORN**

- Air Pressure: 0.4-0.8 MPa
- Current: 3.5-7.0A
- Voltage: 12V/24V
- Sound Level: 115 ± 5dB
- Weight: 0.93Kg / 2lbs
- Dimensions: 11.5" x 6.7" x 3.7"





**IS-DL-1254-REC**

**NEW**

**SNAIL HORN**

- Frequency: 400/500Hz
- Decibel: 105-118dB(A)
- Operating Voltage: 12V
- Two-tone fanfare horns
- 100% purecopper coil
- Strong Sound & Audible Safety: Always a strong and clear tone, even under tough conditions
- Long Life & Reliability: Membrane Filter Technology for increased performance and protection against corrosion, dirt & humidity
- OE Quality: Homologated according to ECE Standard and designed according to OE specifications
- For Passenger Cars
- Optimal performance in Urban & Overland Traffic



**MOST COMMON IN AMERICAN TYPE CARS**

**IS-DL-1254-SQR**

**NEW**

**SNAIL HORN**

- Frequency: 400/500Hz
- Decibel: 105-118dB(A)
- Operating Voltage: 12V
- Two-tone fanfare horns
- 100% purecopper coil
- Strong Sound
- Audible Safety: Always a strong and clear tone, even under tough conditions
- Long Life & Reliability: Membrane Filter Technology for increased performance and protection against corrosion, dirt & humidity
- OE Quality: Homologated according to ECE Standard and designed according to OE specifications
- For Passenger Cars
- Optimal performance in Urban & Overland Traffic



**MOST COMMON IN JAPANESE TYPE CARS**

**DL-1202LT**

**SNAIL HORN**

- Loud Factory Sounding Tone
- Easily Replaces OEM Horn
- Zinc Plating Avoids Corrosion
- Easy to Install



**DL-1222PHT**

**SNAIL HORN**

- Corrosion Resistant
- OEM Sound
- OEM Quality
- Easy to Install



**DL-1202HT**

**SNAIL HORN**

- Loud Factory Sounding Tone
- Easily Replaces OEM Horn
- Zinc Plating Avoids Corrosion
- Easy to Install



**NTX-5000G (GOLD PLASTIC)**

**NTX-5700ALG (GOLD ALUMINUM)**

**SIREN**

- Siren Output: 112 DB
- Size: Ø130 x 125
- Output Power: 250W (P.M.P.O)  
125W (P.M.P.O)
- Impedance: 8 Ohms
- Frequency Range: 1,800Hz ~ 20,000kHz



**NTX-5000CHR**

**SIREN**

- Siren Output: 112 DB
- Size: Ø130 x 125
- Output Power: 250W (P.M.P.O)  
125W (P.M.P.O)
- Impedance: 8 Ohms
- Frequency Range: 1,800Hz ~ 20,000kHz



**AV-1006**

**4" 6 TONE SIREN**

- Siren Output: 119 DB
- Operation Power: 12V, 35W
- Sensitivity: 119dB± 3db
- Impedance: 8 Ohms



**NL-HHKT-7**

**VINYL BRAIDED HORN WIRING HARNESS**

- Horn wiring harness for car horns,air car horns wiring harness connection diagram
- Easy and Simple installation, plug-in play style connection. Make the horns more durable.
- Compatible with many aftermarket vehicle accessories needing an on/off switch.
- 40 Amp
- The overall length of the harness: 2M / 6.6'
- Requires switch

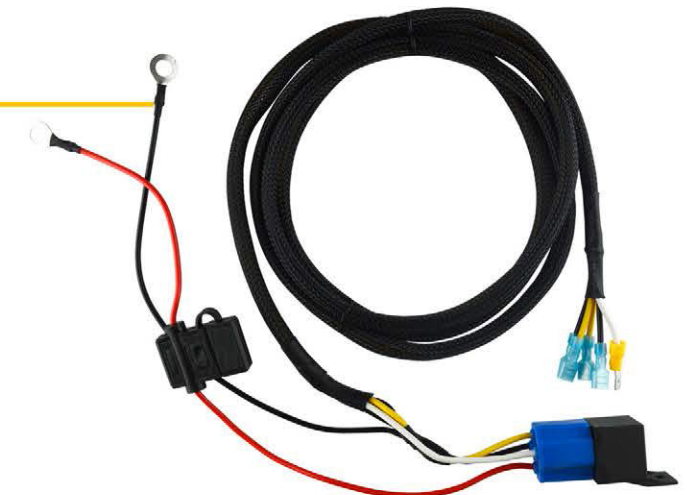



# CAR PRODUCTS & ACCESSORIES



## ISRS-350

### 3.5" DUAL CONE CAR SPEAKER

- Output Power: 45 Watts (P.M.P.O.)  
20Watts (R.M.S.)
- Frequency Response: 92Hz~15KHz
- Sensitivity: 88dB/W(1M)
- Impedance: 4 Ohm

PERFECT FACTORY REPLACEMENT



## ISRS-400

### 4" DUAL CONE CAR SPEAKER

- Output Power: 45 Watts (P.M.P.O.)  
20Watts (R.M.S.)
- Frequency Response: 92Hz~15KHz
- Sensitivity: 88dB/W(1M)
- Impedance: 4 Ohm

PERFECT FACTORY REPLACEMENT



## ISRS-460

### 4 x 6" DUAL CONE CAR SPEAKER

- Output Power: 75 Watts (P.M.P.O.)  
35Watts (R.M.S.)
- Frequency Response: 52Hz~2KHz
- Sensitivity: 88dB/W(1M)
- Impedance: 4 Ohm



## ISRS-500

### 5.25" DUAL CONE CAR SPEAKER

- Output Power: 65 Watts (P.M.P.O.)  
30Watts (R.M.S.)
- Frequency Response: 88Hz~15KHz
- Sensitivity: 88dB/W(1M)
- Impedance: 4 Ohm



## ISRS-600

### 6" DUAL CONE CAR SPEAKER

- Output Power: 75 Watts (P.M.P.O.)  
35 Watts (R.M.S.)
- Frequency Response: 88Hz~15KHz
- Sensitivity: 88dB/W(1M)
- Impedance: 4 Ohm



## ISRS-680

### 6 x 8" DUAL CONE CAR SPEAKER

- Output Power: 70 Watts (P.M.P.O.)  
35 Watts (R.M.S.)
- Frequency Response: 88Hz~15KHz
- Sensitivity: 89dB/W(1M)
- Impedance: 4 Ohm



## ISRS-690

### 6 x 9" DUAL CONE CAR SPEAKER

- Output Power: 75 Watts (P.M.P.O.)  
35 Watts (R.M.S.)
- Frequency Response: 52Hz~2KHz
- Sensitivity: 89dB/W(1M)
- Impedance: 4 Ohm





## SPEAKER PODS

**ISPOD-WD260-BLK**  
**ISPOD-WD260-TAN**  
**ISPOD-WD260-GREY**



### DUAL 6" DOOR WOOD SPEAKER POD

- Audiopipe aluminum logo badge
- Can be mounted on door panels or rear decks
- Inner cylinder provides a solid enclosure
- High grade vinyl wrap
- **SOLD INDIVIDUALLY**

**ISPOD-WD280-BLK**  
**ISPOD-WD280-TAN**  
**ISPOD-WD280-GREY**



### DUAL 8" DOOR WOOD SPEAKER POD

- Audiopipe aluminum logo badge
- Can be mounted on door panels or rear decks
- Inner cylinder provides a solid enclosure
- High grade vinyl wrap
- **SOLD INDIVIDUALLY**

**ISPOD-WD8T-BLK**  
**ISPOD-WD8T-TAN**  
**ISPOD-WD8T-GREY**



### 8" WOOD SPEAKER POD WITH TWEETER OPENING

- Audiopipe aluminum logo badge
- Can be mounted on door panels or rear decks
- Compatible with ATX-3725 tweeter
- Inner cylinder provides a solid enclosure
- High grade vinyl wrap
- **SOLD BY PAIRS**

**TUBO-6.5 (6.5")**  
**TUBO-8 (8")**  
**TUBO-10 (10")**  
**TUBO-12 (12")**



### PORTED SUBWOOFER ENCLOSURE

- Grade A
- 5/8" MDF Construction
- Ported Vent
- Charcoal Carpet Covering
- Solid Wood Construction
- Terminal Cup Connector
- Single Chamber Design
- Weight: 19 Lbs
- Dimensions: 18" L x 11" in diameter (including the vent slot)

## SPEAKER RINGS

**RING-06CBK (6")**  
**RING-065CBK (6.5")**  
**RING-69CBK (6x9")**  
**RING-08CBK (8")**



### SPEAKER RINGS

- MDF Speaker Rings with Black Carpet
- 3/4" Thickness
- Sold in Pairs

### RING-8CTW

### 8" SPEAKER RING WITH OPENING FOR TWEETER

- 8" Wood Rings with Curve (Pair)
- Each Ring Accommodates 8" Speakers and 1 ATR-3721 or ATQ-3725 Series Tweeter
- Provides a Custom Look to your Door Panel or Rear Deck and Acts like a Spacer
- Sold in Pairs



### RING-4545

#### MDF SPEAKER RING

- Inner Diameter: 3.3"
- Outer Diameter: 4.48"
- Sold in Pairs



### RING-5757

#### MDF SPEAKER RING

- Inner Diameter: 4.4"
- Outer Diameter: 5.65"
- Sold in Pairs



### RING-H537

**NEW**

#### MDF SPEAKER RING

- Inner Diameter: 5.37"
- Outer Diameter: 6.5"
- Sold in Pairs



**GREAT FOR FIBERGLASS, KICK PODS, AND BAFFLES. PLEASE NOTE THAT DUE TO THE PRESSED WOOD MATERIAL USED FOR THESE RINGS, THEY ARE VERY EASILY CUSTOMIZABLE FOR SPECIFIC SIZES. THESE RINGS CAN BE SHAVED OR FILED DOWN FOR AN IN-BETWEEN SIZE OR FOR A MORE CUSTOM FIT.**



**COMPATIBLE WITH THESE AUDIOPIPE HORNS:**  
**APH-5757**  
**APH-6556**  
**APH-9460**  
**APH-6030BO-H**  
**APH-6050BO-H**  
**APH-6250BO-H**  
**APH-6256**  
**APH-6278**



## SPEAKER RINGS

<b>RING-3.5R</b>	(3.5")
<b>RING-4R</b>	(4")
<b>RING-5.25R</b>	(5.25")
<b>RING-6.5R</b>	(6.5")
<b>RING-8R</b>	(8") <b>POPULAR</b>
<b>RING-10R</b>	(10")
<b>RING-12R</b>	(12")
<b>RING-15R</b>	(15")

THIS PRODUCT IS A REAL TIME AND FINGER SAVER. DON'T RISK IT. YOU CAN ROUTER OUT YOU OWN MDF SPEAKER RINGS BUT, YOU RISK LOOSING SOME SKIN OR WORSE. WE TOOK THE AVERAGE SIZE SPEAKER AND MADE THESE TO FIT MOST ALL SPEAKERS ON THE MARKET. GREAT FOR FIBERGLASS KICK PODS AND BAFFLES.



### MDF SPEAKER RINGS

- Sold in pairs

<b>RING-6.5BZ</b>	(6.5")
<b>RING-8BZ</b>	(8") <b>POPULAR</b>
<b>RING-10BZ</b>	(10")
<b>RING-12BZ</b>	(12")

### MDF SPEAKER RINGS WITH BEZEL

- Sold in pairs

<b>RING-6.5GR</b>	(6.5")
<b>RING-8GR</b>	(8")

### MDF SPEAKER RINGS WITH GRILL CUT-OUT

- Sold in pairs



### RING-3720

#### MDF TWEETER RING

- Sold in pairs



COMPATIBLE WITH THESE AUDIOPIPE TWEETERS:  
**ATR-3723B**  
**ATR-3723C**  
**ATR-3721**

<b>APMB-RING-6</b>	(6")
<b>APMB-RING-8</b>	(8")

### ABS PLASTIC SPEAKER RINGS

- Made From ABS Plastic
- Adds an Extra Half Inch to Available Mounting Depth
- One Pair of Adapters Included in Each Package



### 6" PVC RING

- Universal 1" Speaker Spacer Rings for Mounting 6.5" Speaker
- Inner Diameter: 5-7/8"
- Made From PVC Material
- 1-inch Allows Extra Mounting Depth
- Fits most 6.5 inch Speakers
- Oversized 6.5" Speakers will not work with these Spacers
- Sold in pairs



## SPEAKER BAFFLES

### APMB-RING-69 **NEW**

#### 6 X 9" PLASTIC SPEAKER DEPTH EXTENDER

- Inner Dimensions: 8.25 x 6.125"
- Outer Dimensions: 11.3125 x 7.5"
- Made from ABS Plastic
- Black Color
- Sold in pairs

**EXCLUSIVELY MADE TO FIT OUR APMB DIE CAST BASKET MODELS**



### IS-ACBAF-65

#### 6.5" SPEAKER BAFFLE

- Material: Silicone
- Front ring is foldable to guide the sound wave into vehicle
- Rear foldable ring fits different door depth and speaker heights. No need to trim.
- Rear foldable ring protects speaker and improves sound
- Silicone material is soft, allowing for best seal between speaker and door panel
- Silicone material is durable for harsh environment
- The sound wave foam installs behind the speaker to improve overall sound performance



### IS-ACBAF-8 **NEW**

#### 8" SPEAKER BAFFLE

- Material: Silicone
- Front ring is foldable to guide the sound wave into vehicle
- Rear foldable ring fits different door depth and speaker heights. No need to trim.
- Rear foldable ring protects speaker and improves sound
- Silicone material is soft, allowing for best seal between speaker and door panel
- Silicone material is durable for harsh environment
- The sound wave foam installs behind the speaker to improve overall sound performance



### IS-ACBAF-69 **NEW**

#### 6 X 9" SPEAKER BAFFLE

- Material: Silicone
- Front ring is foldable to guide the sound wave into vehicle
- Rear foldable ring fits different door depth and speaker heights. No need to trim.
- Rear foldable ring protects speaker and improves sound
- Silicone material is soft, allowing for best seal between speaker and door panel
- Silicone material is durable for harsh environment
- The sound wave foam installs behind the speaker to improve overall sound performance



**CREATES A TIGHT, ACOUSTIC SEAL BEHIND THE SPEAKER TO ENHANCE THE SOUND QUALITY**





## SPEAKER CABLES

- IS-SP-14-1000BR** (14 GAUGE)
- IS-SP-16-1000BR** (16 GAUGE)
- IS-SP-18-1000BR** (18 GAUGE)
- IS-SP-20-1000BR** (20 GAUGE)

### SPEAKER CABLES

• 1000 FT

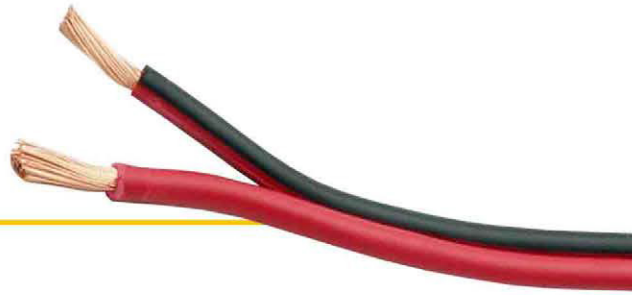

- IS-SP-10-500CL** (10 GAUGE)
- IS-SP-12-500CL** (12 GAUGE)

### SPEAKER CABLES

• 500 FT



- IS-SP-14-1000CL** (14 GAUGE)
- IS-SP-16-1000CL** (16 GAUGE)
- IS-SP-18-1000CL** (18 GAUGE)

### SPEAKER CABLES

• 1000 FT



## AMPLIFIER INSTALLATION KITS

### IS-K800

#### AMPLIFIER INSTALLATION KIT

- 17' 10GA Red Power Cable
- 3' 10GA Black Power Cable
- 15' 2-RCA to 2-RCA Plugs Cable with Signal Wire
- 3' Split Loom Tubing
- 10 AWG Fuse Holder
- 30A ATC Fuse
- 10 Pcs. Cable Ties
- Ring Terminal 1+1 Pcs
- 5 Spade Terminal
- 2 Butt Splices



### IS-K1700

**BEST SELLER**

#### AMPLIFIER INSTALLATION KIT

- 17' 8GA Red Power Cable
- 3' 8GA Black Power Cable
- 17' 2-RCA to 2-RCA Plugs Cable with Signal Wire
- 3' Split Loom Tubing
- AFC Fuse Holder
- 60A AFC Fuse
- 10 Pcs. Cable Ties
- Ring Terminal 1+1+1 Pcs
- 3 Spade Terminal
- 2 Butt Splices



### IS-K2500

#### AMPLIFIER INSTALLATION KIT

- 17' 4GA Red Power Cable
- 3' 4GA Black Power Cable
- 17' 2-RCA to 2-RCA Plugs Cable with Signal Wire
- 3' Split Loom Tubing
- AFC Fuse Holder
- 100A AFC Fuse
- 10 Pcs. Cable Ties
- Ring Terminal 1+1 Pcs
- Spade Terminal 2 Pcs
- Butt Splices 2 Pcs



### IS-K3500

#### AMPLIFIER INSTALLATION KIT

- 17' 0GA Red Power Cable
- 3' 0GA Black Power Cable
- 17' 2-RCA to 2-RCA Plugs Cable with Signal Wire
- 3' Split Loom Tubing
- ANL Fuse Holder
- 250A ANL Fuse
- 10 Pcs. Cable Ties
- Ring Terminal 1+1 Pcs
- Spade Terminal 2 Pcs
- Butt Splices 2 Pcs



### IS-K1700P

#### PLATINUM AMPLIFIER INSTALLATION KIT

- 17' 8GA Blue Power Cable
- 3' 8GA Silver Power Cable
- 17' 2-RCA to 2-RCA Plugs Cables with Signal Wire
- 3' Split Loom Tubing
- AFC Fuse Holder
- 60A AFC Fuse
- 10 Pcs Cable Ties
- Ring Terminal 1+1+1 Pcs
- Spade Terminal 3 Pcs
- Butt Splices 2 Pcs

**NOW INCLUDES:**  
60A AFC Holder & Fuse



### IS-K2500P

#### PLATINUM AMPLIFIER INSTALLATION KIT

- 17' 4GA Blue Power Cable
- 3' 4GA Silver Power Cable
- 17' 2-RCA to 2-RCA Plugs Cables with Signal Wire
- 3' Split Loom Tubing
- AFC Fuse Holder
- 100A AFC Fuse
- 10 Pcs Cable Ties
- Ring Terminal 1+1 Pcs
- Spade Terminal 2 Pcs
- Butt Splices 2 Pcs

**NOW INCLUDES:**  
100A AFC Holder & Fuse





**IS-RVDVR-43** **NEW**

**FRONT/ REAR VIEW CAMERA WITH 4.3" MONITOR AND DVR**

- HD camera, HD video
- Camera lens: 150 degree A+high resolution ultra wide angle lens
- Language: English, Spanish, Portuguese, Japanese, French, German, Chinese (Simplified).
- File format: AVI
- Video resolution: Maximum 720P
- Video format: M-JPEG
- Loop video: Seamless video
- Supports auto ignition startup
- Supports Mobile detection function
- Photographic mode: 500 pixels
- Photo format: JPEG
- Memory card: TF (maximum support 32GB)
- Built-in stereo
- Video format: PAL/NTSC
- Current frequency: 50/60Hz
- USB function: 1: USB-Disk. 2: PC camera
- Power supply interface: 5V 1A
- Built in battery
- Built-in Microphone



**4.3 IN SCREEN**

**IS-RVDVR-96** **NEW**

**FRONT/ REAR VIEW CAMERA WITH 9.6" MONITOR AND DVR**

- LCD: 9.6", IPS320 x 1280
- Camera lens: Front lens Angle: 160 °  
Rear lens Angle: 150 °
- Video compression standards: H.264
- Video sample rate: 30 fps
- Video resolution: 1080 x 1296
- Photographic resolution: 1080 x 1920
- Language: English, Spanish, Portuguese Japanese, French, Chinese (Simplified).
- Full screen capacitive touch
- Built-in echo cancelling microphone
- G-Sensor: Supports for triaxial force indu
- Working current: <2Ah
- Sleep Current: <3mA
- Operating voltage range: 4.8V-5.5V
- Operating temperature range: -30°C~+75°C (-86°F~+167°F)
- Power supply mode: +5V

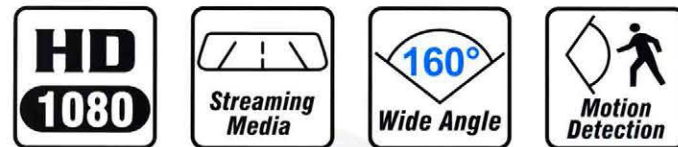

**9.6 IN SCREEN**

**IS-RVMR-43**

**REAR VIEW MIRROR MONITOR**

- 4.3" High Resolution Screen
- Power Input: 12V
- Display Format: 16:9
- The Brightness of the Screen will Adjust Automatically to its Environment's Lighting Conditions

**HD 4.3 IN SCREEN**



**IS-RLC-245G-BLK**

**CAR REAR VIEW CAMERA**

- High Resolution
- Super Low Illumination
- Weather-Proof: IP 65
- Anti-Fog Function
- Wide Angle (120-170°)
- Easy to Install
- 9"x6-3/4"

**2.4 GHZ WIRELESS CONNECTION**

**300M VIEW RANGE**



**IS-RVC-170MI**

**CAR REAR VIEW CAMERA**

- Working Voltage: 10-15V (12V in car)
- Working Temperature: -20 °C~70°C
- Video: NTSC
- Water-Proof: IP67-IP68
- Min-Illumination: 0.1 LUX
- Resolution (TV LINES): 480



**480 TV LINES (RESOLUTION)**



**IS-RVC-841TRJ**

**CAR REAR VIEW CAMERA**

- 4 LED Night Light
- Image Device: FPX8341 1/3 Color CMOS
- TV System: NTSC/PA can be Chosen
- Effective Pixel: 720 x 480
- IP Rating: IP67
- Definition: 600 TV Lines
- Reversing track dynamic lines



**4 LED NIGHT LIGHT FOR IMPROVED IMAGE QUALITY**

**600 TV LINES (RESOLUTION)**





**IS-RVC-360ROT**

**CAR REAR VIEW CAMERA**

- Water-Proof & dust-Proof
- High Definition
- Night Vision
- 120 Degree Wide Angle View
- Voltage: 8 - 15V
- Size: 22.5 x 25mm



**THIS REAR VIEW CAMERA IS THE PERFECT SOLUTION TO GET RID OF POOR REAR VIEW VISIBILITY ON YOUR CAR, BOAT, TRAILER, OR CAMPER**

**IS-RVC-803GL**

**BEST SELLER**

**CAR REAR VIEW CAMERA**

- Connects to a RCA input and a 12 volt power source.
- Included : Mounting bracket, Hole saw (20mm), 36" power wiring and 6m RCA cable.
- Water-Proof & Dust-proof
- High Definition
- Night Vision & Wide Angle
- Voltage: 8-15V
- Size: Φ20 x 30(H) mm



**IS-RVC-165GL**

**CAR REAR VIEW CAMERA**

- Water-Proof & Dust-Proof
- High Definition
- Night Vision & Wide Angle
- Voltage: 8-15V
- Size: Φ16.5 x 22(H) mm



**IS-RVC-258GL**

**CAR REAR VIEW CAMERA**

- Water-Proof & Dust-Proof
- High Definition
- Night Vision & Wide Angle
- Voltage: 8-15V
- Size: Φ18 x 20(H) mm



**IS-BUP400-BLK**

**INTELLIGENT PARKING ASSISTANCE SYSTEM**

- Automatically Works when Reversing
- Digital LED Display
- Four Step Beep Alarm
- Detect Distance is 0-2m
- 4 Sensors
- Voltage: 9~15V DC
- Includes 4 Sensors
- Rated Voltage: 12V DC
- Power Time: <0.5W
- Response Time: 0.3~2.0m
- Sensor Diameter: 22mm
- Sensor Angle: x y 60°
- Alarm Volume: 65 dB



**IS-MVA4**

**1-4 VIDEO SPLITTER**

- One RCA Video Input
- Four RCA Video Output
- Video Input Level: 2.0Vpp
- Output Impedance: 75 Ohm
- Independent Video Level Control

**A VERSATILE VIDEO SPLITTER FOR APPLICATIONS THAT REQUIRE VIDEO DISTRIBUTION TO MULTIPLE DISPLAYS OR LOCATION. TOTAL OF 4 REAL TIME DUPLICATED VIDEO OUTPUTS WITH NO LAGS.**



**IS-CF512**

**5" CROSS FLOW COOLING FAN**

- Compatible with all 12 volt systems
- Comes equipped with mounting tabs for simple installation
- Low profile cross flow design allows installation in tight fitting spaces
- Puts out 25 cubic feet of air flow per minute

**12V DC VOLTAGE**  
**5"**



**IS-CF812**

**8" CROSS FLOW COOLING FAN**

- Compatible with all 12 volt systems
- Comes equipped with mounting tabs for simple installation
- Low profile cross flow design allows installation in tight fitting spaces
- Puts out 40 cubic feet of air flow per minute

**12V DC VOLTAGE**  
**8"**



**BEST SELLER**

**POPULAR**

**FAN-33**

**COOLING FAN**

- 2 3/8" x 2 3/8" x 1"
- 28 Cubic Feet per Minute
- 12V 0.8A

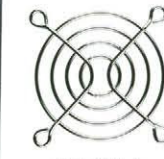

**GRILL INCLUDED**

**FAN-55**

**COOLING FAN**

- 4 6/8" x 4 6/8" x 1.5"
- 106 Cubic Feet per Minute
- 12V 1.0A



**GRILL INCLUDED**

**FAN-550HS**

**HIGH SPEED COOLING FAN**

- 4.7" (H) x 4.7" (W) x 1.5" (D)
- Current: 2A, Power: 24W, DC 12V
- Speed: 4350RPM
- Two speed options



**FAN-4712LERG**

**NEW**

**COOLING FAN WITH LED**

- Product Size: 120 x 120 x 25 mm (4.7" x 4.7" x 1")
- Rated Voltage: 12V ( for fan)
- Rated Current: 1A
- Airflow: 36CFM
- Fan Speed: 2000 (±10% RPM)
- Sound Level: 21-34 dB
- Bearing Type: Hydraulic Bearing
- Lifetime: 30000Hrs
- Dual ring LED circle (12 LED lights automatically change)



**HIGHLY OPTIMIZED LOW-NOISE DESIGN WITH OUTSTANDING STATIC PRESSURE AND AIRFLOW (CFM), IDEAL FOR CHASSIS VENTILATION**



**IS-DB91832**

**BEST SELLER**

**SOUND DAMPENING MAT BULK PACKAGE**

- Damping Mat Bulk Package
- Included Nine (9) / 18"x 32" sheets
- 2.2mm thick
- Pure butyl
- Handles 40lb / sq inch
- Forget about unwanted road noise and create a quiet environment in your ride. Pipeman's Dampening Mat is easy to install and will improve your bass.



**18" X 32"**

**IS-DD61224**

**SOUND DAMPENING MAT BULK PACKAGE DOOR KIT**

- Damping Mat Bulk Package
- Included Nine (9) / 12"x 24" sheets
- 2.2mm thick
- Pure butyl
- Handles 40lb / sq inch
- Forget about unwanted road noise and create a quiet environment in your ride. Pipeman's Dampening Mat is easy to install and will improve your bass.



**12" X 24"**

**PERFECT FOR DOORS**

**IS-DT101224**

**SOUND DAMPENING MAT BULK PACKAGE TRUNK KIT**

- Damping Mat Bulk Package
- Included Nine (10) / 12"x 24" sheets
- 2.2mm thick
- Pure butyl
- Handles 40lb / sq inch
- Forget about unwanted road noise and create a quiet environment in your ride. Pipeman's Dampening Mat is easy to install and will improve your bass.



**12" X 24"**

**PERFECT FOR TRUNKS**

**IS-DS21012**

**SOUND DAMPENING MAT BULK PACKAGE SPEAKER KIT**

- Damping Mat Bulk Package
- Included Nine (9) / 10"x 12" sheets
- 2.2mm thick
- Pure butyl
- Handles 40lb / sq inch
- Forget about unwanted road noise and create a quiet environment in your ride. Pipeman's Dampening Mat is easy to install and will improve your bass.



**10" X 12"**

**PERFECT FOR SPEAKERS**

**IS-160**

**16 AMP**

**GROUND LOOP ISOLATOR**

- Eliminate the electrical noise and hum caused by ground loops with this ground loop isolator. Gold plated connectors enhance performance and resist corrosion.
- 2-CH Signal Output
- Signal Noise Eliminator
- 16 Amp



**IS-210**

**21 AMP**

**GROUND LOOP ISOLATOR**

- Eliminate the electrical noise and hum caused by ground loops with this ground loop isolator. Gold plated connectors enhance performance and resist corrosion.
- 2-CH Signal Output
- Signal Noise Eliminator
- 21 Amp



**IS-NR35**

**LINE OUTPUT CONVERTER**

- When adding a amplifier to a OEM stereo the line out converter converts a speaker-level output signal into an RCA preamp-level signal that most amplifiers need.
- High/Low Level Converter
- Signal Noise Eliminator
- 2-CH Signal Outputs



**IS-NR100**

**LINE OUTPUT CONVERTER**

- When adding a amplifier to a OEM stereo the line out converter converts a speaker-level output signal into an RCA preamp-level signal that most amplifiers need.
- High/Low Level Converter
- Signal Noise Eliminator
- 2-CH Signal Outputs
- Output Level Adjustable



**IS-AKNOB-1**

**UNIVERSAL REMOTE RCA GAIN CONTROL**

- This remote amplifier level control is used to adjust an amplifier's power level from a dashboard location. It adds sub-woofer lever controls or balances a multiple amplifier installation. Range is +/- 8 dB. Mount it in or under the dash.



**IS-POP10**

**POP STOPPER**

- Time Delay Circuit Eliminates "Turn-On Pops"
- Time Delay Circuit Eliminates "Turn-Off Pops"



**IS-RM200**

**HI/LO CONVERTER W/ REMOTE TURN ON**

- Line Output Converter w/ Remote turn ON
- Gold Female RCA Output
- Adjustable Line Output Converter
- Converts from 10 to 25 Watts per Channel to Pre-Amp Output
- Remote Turn ON Circuit



**IS-NR12**

**NOISE SUPPRESSOR**

- 10 Amp
- Eliminates Engine & Alternator Noise
- Car Audio, Marine, CB and other 12V Applications
- This power line noise suppressor is designed to eliminate the noise in power line and let the car stereo or CB perform at its optimum





**PROW-2002**

**UNIVERSAL POWER WINDOW KIT (2 WINDOWS)**

- Complete Kit to Convert 2 Windows to Full Power
- Universal for All Automobiles
- Converts 2 Manual Windows to Power Window
- Perfectly Suited for any Type of Door, Front or Rear
- Power Window System is Installed Behind the Door Panel
- Does not Change the Exterior Design of the Door Panel
- Power Window Motors are Extremely Quiet
- Cuprum Bearing
- POM Plastic Gear Wheel



**PROW-4004**

**UNIVERSAL POWER WINDOW KIT (4 WINDOWS)**

- Complete Kit to Convert 4 Windows to Full Power
- Universal for All Automobiles
- Converts 4 Manual Windows to Power Window
- Perfectly Suited for any Type of Door, Front or Rear
- Power Window System is Installed Behind the Door Panel
- Does not Change the Exterior Design of the Door Panel
- Power Window Motors are Extremely Quiet
- Cuprum Bearing
- POM Plastic Gear Wheel



**EWD-151**

**ILLUMINATED CAR WINDOW SWITCH**

- 12V 24V
- 5A-15A
- Contact Resistance: 50 mΩ max
- Insulation Resistance: 500VDC 100mΩ min
- Dielectric Strength: 1500VAC, 1minute
- Operating Temperature: -25°C~ +85°C
- Electrical Life: 10000 Cycles
- 5 Pins

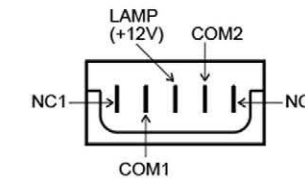

**EWD-153**

**ILLUMINATED CAR WINDOW SWITCH**

- 12V 24V
- 5A-15A
- Contact Resistance: 50 mΩ max
- Insulation Resistance: 500VDC 100mΩ min
- Dielectric Strength: 1500VAC, 1minute
- Operating Temperature: -25°C~ +85°C
- Electrical Life: 10000 Cycles
- 5 Pins

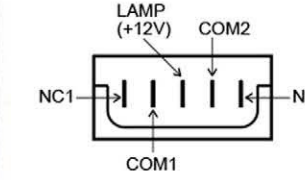

**EWD-155**

**CAR WINDOW SWITCH**

- 12V 24V
- 5A-15A
- Contact Resistance: 50 mΩ max
- Insulation Resistance: 500VDC 100mΩ min
- Dielectric Strength: 1500VAC, 1minute
- Operating Temperature: -25°C~ +85°C
- Electrical Life: 10000 Cycles
- 6 Pins

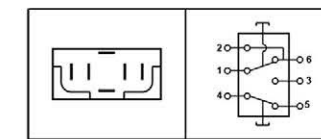

**EWD-157**

**CAR WINDOW SWITCH**

- 12V 24V
- 5A-15A
- Contact Resistance: 50 mΩ max
- Insulation Resistance: 500VDC 100mΩ min
- Dielectric Strength: 1500VAC, 1minute
- Operating Temperature: -25°C~ +85°C
- Electrical Life: 10000 Cycles
- 6 Pins

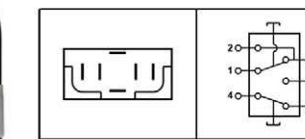

**IS-BARST-8**

**8 POLE CONNECTION BARRIER STRIP**

- Double row screw terminals with barriers
- Easy to connect screw terminals, wire 22-12 ga
- Tin-plated brass terminals, nickel-plated steel screws
- Used in for industrial, electrical, electronic, and automotive projects



**IS-BARST-12**

**12 POLE CONNECTION BARRIER STRIP**

- Double row screw terminals with barriers
- Easy to connect screw terminals, wire 22-12 ga
- Tin-plated brass terminals, nickel-plated steel screws
- Used in for industrial, electrical, electronic, and automotive projects





**IS-CDLS-05M**

**5 WIRE CAR DOOR CENTRAL LOCK**

- 5 Wire Gun Type Actuator
- 360-Degree Rotation Head for Easy Installation
- Working Force:  $\geq 2.5\text{Kg}$
- Working Stroke: 19mm
- Working Life > 100000 Times
- Strong Iron Back Strap
- Iron Fixed Block
- Pull Rod



**IS-CDLS-10R**

**2 WIRE CAR DOOR CENTRAL LOCK**

- 2 Wire Gun Type Actuator
- 360-Degree Rotation Head for Easy Installation
- Working Force  $\geq 2.5\text{Kg}$
- Working Stroke: 19mm
- Working Life > 100000 Times
- Strong Iron Back Strap
- Iron Fixed Block
- Pull Rod



**IS-CDLS-40R**

**CENTRAL DOOR LOCKING SYSTEM**

- Applicable for all Cars(4 Door) and can be Connected with Remote Controller and Alarm Security
- (1) 5 Wire Gun Type Actuator
- (3) 2 Wire Gun Type Actuator
- 360-Degree Rotation Head for Easy Installation
- Working Force  $\geq 2.5\text{Kg}$
- Working Stroke: 19mm
- Working Life > 100000 Times
- Strong Iron back Strap
- Iron Fixed Block
- Pull Rod



**12V, 10A**  
OPERATING VOLTAGE  
& CURRENT

**NA-1500**

**PILLAR SIDE MOUNT ANTENNA**

- 3 Sections
- Extends to 47.2"
- Cable: 50"
- Fits Most Nissan and Toyota Pick-Up Trucks
- Chrome Finish



**NA-1500B**

**PILLAR SIDE MOUNT ANTENNA**

- 3 Sections
- Extends to 48"
- Cable: 48"
- Fits Most Cars
- Black Finish



**NA-1517L**

**PILLAR SIDE MOUNT ANTENNA**

- 3 Sections
- Extends to 48"
- Cable: 48"
- Fits Toyota Corolla ('78-'83), Tercel ('80-'82), and Mazda GLC ('76-'80)
- Chrome Finish

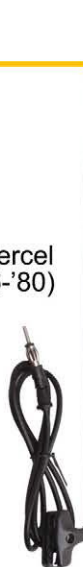

**NA-1517R**

**PILLAR RIGHT SIDE MOUNT ANTENNA**

- 3 Sections
- Extends to 48"
- Cable: 48"
- Fits Toyota Corolla ('78-'83), Tercel ('80-'82), and Mazda GLC ('76-'80)
- Chrome Finish



**NA-1518**

**PILLAR MOUNT ANTENNA**

- 2 Sections
- Extends to 31"
- Cable: 82"
- Fits Nissan/Datsun, GLC ('78-'80), 626 ('78-'87) Ford Festival ('87-'93)
- Chrome Finish



**NA-1599**

**UNIVERSAL SIDE MOUNT ANTENNA**

- Universal Side Mount
- Detachable Mast
- 1 Section
- Extends to 31"
- Cable: 72"
- Chrome Finish



**NA-1551**

**LEFT/RIGHT PILLAR MOUNT ANTENNA**

- 3 Sections
- Extends to 31"
- Cable: 82"
- Fits Daihatsu Charade G100, Honda Accord ('88)P prelude ('88), Mazda 323 4 door ('86), Suzuki Swift ('92), Toyota Corolla Seca ('88-'92)
- Chrome Finish



**NA-1502**

**FRONT/REAR FENDER/ROOF MOUNT ANTENNA**

- 3 Sections
- Extends to 47"
- Cable: 54"
- Fits Most Cars
- Flexible Spring and Deluxe Ball Base
- Chrome Finish



**NA-1514**

**NARROW FENDER MOUNT ANTENNA**

- 4 Sections
- Extends to 39"
- Cable: 48"
- Fits VW Beetle, Bus and Transporter Audi Auant, Citroen CX, Peugeot 104/204/304/404, Renault 12, Toyota Starlet
- 52° Fixed Angle
- Black Finish





**NA-1508**

**FRONT/REAR FENDER/ROOF MOUNT ANTENNA**

- 1 Section
- Extends to 17"
- Cable: 54"
- Fits Most Cars
- Swivel Ball Base 180° Adjustable Angle



**NA-1524**

**UNIVERSAL FRONT OR REAR DECK ANTENNA**

- 1 Section Spring Whip
- Extends to 31"
- Cable: 54"



**NA-1532**

**UNIVERSAL FRONT OR REAR DECK ANTENNA**

- 3 Sections
- Flexible Spring and Deluxe Ball Base
- Spring Base Booster Type
- Adjustable to 180° Angle
- Extends to 45"
- Cable: 54"



**NA-523**

**UNIVERSAL ROOF/REAR DECK MOUNT ANTENNA**

- 1 Section Black Fiberglass Mast
- Mast Length 510mm (20")
- Cable Length 2030mm (80")
- Alloy Ball Base Adjustable Angle 90°
- Side Mount

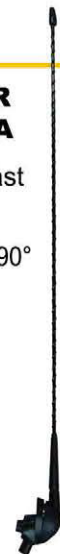

**NA-1533**

**UNIVERSAL ANTENNA**

- Fits Toyota Corolla ('93 & Up)
- 1 Section
- Extends to 31"
- Cable: 82"



**NA-1553**

**UNIVERSAL ANTENNA**

- Fits Nissan, Datsun Pick-Up ('89 & up)
- 1 Section
- Extends to 31"
- Cable: 54"



**NA-5000**

**UNIVERSAL STAINLESS STEEL ANTENNA**

- 4 Sections
- Side Key Lock
- 0 ~ 30° Mounting Angle Big Fit-Head
- Extends to 39.4"
- Cable: 50"



**NA-1549**

**AMPLIFIED WINDSCREEN CAR ANTENNA**

- High Sensitivity
- AM/FM Reception
- 1 Section
- 13.5" length
- Cable: 80"



**NA-1659**

**AMPLIFIED WINDSCREEN CAR ANTENNA**

- High Sensitivity
- AM/FM Reception
- 1 Section
- 11.5" length
- Cable: 80"



**IS-NE22**

**UNIVERSAL ROOF, FRONT, OR REAR MOUNT ANTENNA**

- 1 Section Flexible Rubber Mast
- Swivel Ball Base 180° Adjustable Angle
- Extends to 16"
- Cable: 54"



**NA-1560**

**STICK-ON ROOF MOUNT ANTENNA**

- 1 Section Fiberglass Mast
- Extends to 16"



**NA-25215**

**SINGLE MIRROR MOUNT ANTENNA**

- 1 Section Fiberglass Mount
- Extends to 48"
- Cable: 140"
- Frequency: 27MHz



**NA-26280**

**MAGNETIC MOUNT CAR ANTENNA**

- Base Loaded
- 1 Section
- Extends to 15"
- Cable: 120"
- Frequency: 27MHz

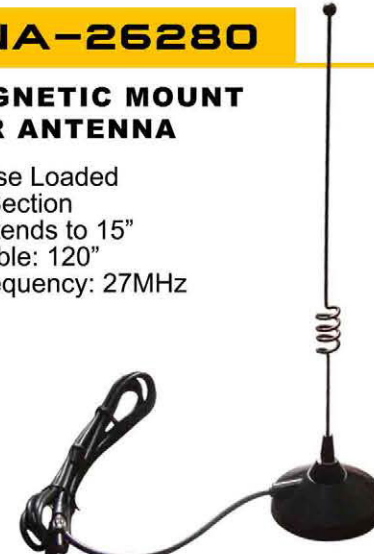

**NA-50FL**

**FENDER MOUNT ANTENNA**

- 5 Sections
- Material: SUS304
- Working Principle: PCB Control
- Coaxial Cable: 75 Ohms
- Length: 1500mm (59")
- Rod Length: 800mm (31.5")
- Connector: Motorola Plug
- 0-30° Adjustable Mounting Base



**NA-90FL**

**FENDER MOUNT ANTENNA**

- 5 Sections
- Material: SUS304
- Working Principle: PCB Control
- Coaxial Cable: 75 Ohms
- Length: 1500mm (59")
- Rod Length: 1000mm (39")
- Connector: Motorola Plug
- 0-30° Adjustable Mounting Base



**NA-1555UN**

**ALUMINUM ANTENNA MAST**

- Made of High Quality Light-Weight Aluminum Alloy
- Stylish Carbon Fiber Design
- Replaces most Stock Mast/Whip Antenna Styles
- 4.7" length



**NA-1546ER**

**ANTENNA WITH BUILT-IN ANTENNA**

- Roof Mount
- 5M Extension Cable
- Perfect Fit for European Models



**NA-1544RF**

**SHARK FIN ANTENNA WITH BUILT-IN AMPLIFIER**

- Roof Mount
- 5M Extension Cable
- Perfect Fit for European Models





- EA-1.5 (1.5")
- EA-3 (3")
- EA-6 (6")
- EA-12 (12")

**ANTENNA EXTENSION CORD**



**IS-CR16**

**ANTENNA ADAPTER FOR CHRYSLER**

- Simply plug and play installation, no cutting required
- Adapts factory antenna plug into aftermarket style
- Ideal for any aftermarket radio
- Direct OEM fit connection



**EU-22**

**ANTENNA ADAPTER FOR BMW AND VOLKSWAGEN**

- Antenna Adapter for BMW and Volkswagen 2002-2008
- Factory Radio to After-Market Antenna Adapters for European



**VW-16**

**FACTORY ANTENNA TO AFTER-MARKET RADIO ADAPTERS FOR VOLKSWAGEN**

- Simply plug and play installation, no cutting required
- Adapts factory antenna plug into aftermarket style
- Ideal for any aftermarket radio
- Direct OEM fit connection



**IS-GM16**

**FACTORY ANTENNA TO AFTER-MARKET RADIO ADAPTERS FOR GM**

- Simply plug and play installation, no cutting required
- Adapts factory antenna plug into aftermarket style
- Ideal for any aftermarket radio
- Direct OEM fit connection



**NA-SPAD-C**

**TRUCK SHOCK SPRING ANTENNA ADAPTER**

- The Semi-Flexible Mast Helps withstand Bracing Winds
- Sold Individually



**EA-1**

**STANDARD MALE ANTENNA PLUG**

- Extend, adapt or split your mast antenna lead with these adapters. These fit a standard Motorola car antenna connection.



**IS-VW-16P**

**ANTENNA ADAPTER PLUG FOR VOLKSWAGEN**



**IS-MUV40**

**ANTENNA ADAPTER FOR VOLKSWAGEN**



**IS-NI16**

**ANTENNA ADAPTER FOR NISSAN**

- This antenna adapter lets you connect an aftermarket receiver to the factory antenna cable in select 2006 and later Nissan models



**IS-TY11**

**ANTENNA ADAPTER FOR TOYOTA**

- This antenna adapter lets you connect an aftermarket receiver to the factory antenna cable in select 2009-up Toyota vehicles. The adapter has a standard male Motorola plug on one end and a female mox connector on the other

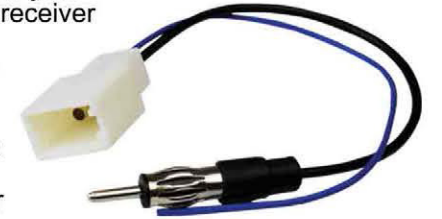

**IS-HD10**

**ANTENNA ADAPTER FOR HONDA MODELS 2010 AND LATER**

- This antenna adapter lets you connect an aftermarket receiver to the factory antenna cable in select 2015 Honda models



**IS-HD11**

**ANTENNA ADAPTER FOR 2015 HONDA MODELS**

- This antenna adapter lets you connect an aftermarket receiver to the factory antenna cable in select 2015 Honda models



**IS-SB10**

**ANTENNA ADAPTER FOR SUBARU MODELS**

- This antenna adapter lets you connect an aftermarket receiver to the factory antenna cable in select 2006-up Nissan vehicles. The adapter has a Subaru female plug on one end and a Motorola male plug on the other



**IS-EXP14-TYKT**

**14MHz BAND EXPANDER FOR 2014 AND LATER TOYOTA MODELS**

- Supplied with factory connector for a quick plug and play
- All our Band Expanders contain a by-pass within their circuitry which allows current to pass through the FM Band Expander to the antenna amplifier fitted at the base of antenna

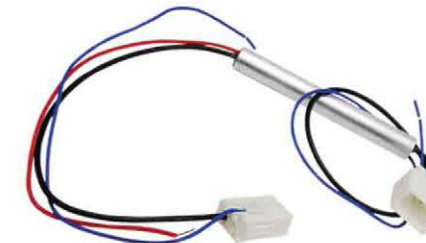

**IS-EXP105N**

**14MHz BAND EXPANDER FOR 2007 AND LATER NISSAN MODELS**

- Supplied with factory connector for a quick plug and play
- All our Band Expanders contain a by-pass within their circuitry which allows current to pass through the FM Band Expander to the antenna amplifier fitted at the base of antenna



**IS-EXP-MOT**

**NEW**

**FM BAND 88-108MHz CRYSTAL 19 MHz BAND EXPANDER**



**THIS RADIO BAND EXPANDER ENABLES THE ORIGINAL EQUIPMENT RADIO IN JAPANESE IMPORT CARS TO RECEIVE UNIVERSAL RADIO TRANSMISSIONS.**



617

**HEAVY DUTY ALARM SWITCH**

- Universal Pin Switch that Will Work for Most Brand of Car Alarms



618

**ADJUSTABLE METAL PIN SWITCH**

- Especially Good for Car Bonnets, this Heavy Duty Pin Switch is Nickel-Plated for Protection from Corrosion in Hostile Environments



621

**CUTTABLE PLASTIC PIN SWITCH**



AQK-P14FM

**MALE TO FEMALE TERMINAL**

- 14 Gauge
- 2'
- Security Lock



PRO-1000

**RELAY SOCKET**

- With Diode
- For Alarm Installations
- Starter Kill Prewired



PRO-1020

**RELAY SOCKET**

- Dual Sockets
- For Wiring Door Lock Actuators



BEST SELLER

30ARF

**RELAY**

- 30A ATC inline fuse
- 12V DC
- 30A/40A



40ARB

**RELAY**

- 40 A
- 25VDC
- DC 12V



80-ARB

**RELAY**

- 80 A/14V DC
- 60A/14VDC
- DC 12V



40AMP

**RELAY**

- 40A/14V DC
- 30A/14V DC
- DC 12V



40ISR

**RELAY**

- NO:40 A
- NC:30 A
- DC 12V



40ISR-24V **NEW**

**RELAY**

- Current 40A
- DC 24V
- 24 coil voltage
- 5 Pin
- This relay has a universal application and can be used in automotive setups, car sound systems, or security



IS-1005SK **NEW**

**5 WIRE RELAY SOCKET**

- Connection Type: Pigtail
- Length: 12"
- Gauge: 16
- Quantity: 10

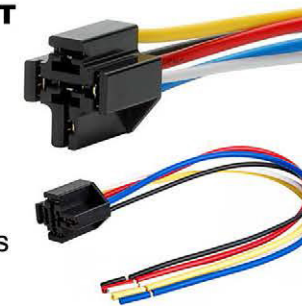

COMPATIBLE WITH 40ARB, 30ARF, 40AMP, 40ISR, 40ISR-240 RELAYS (NOT INCLUDED)

PRE-WIRED RELAY SOCKET FOR USE WITH 12V DC BOSCH TYPE FIVE TERMINAL RELAYS. SUITABLE FOR USE WITH HIGH POWER LED OFF ROAD BARS, AUX LIGHTS, WORK LIGHTS AND OTHER CUSTOM APPLICATIONS.

IS-1805SK **NEW**

**STACKABLE 5 WIRE RELAY SOCKET**

- Cable Length: 135mm/5.4"
- Rated Current: 80A
- Rated Voltage: DC 12V/24V
- Cable Dia.: 2.5mm/0.1", 5mm/0.2"
- Size (Not Including Wire): 1.4" x 1.4" x 1.1" (L\*W\*H)
- Pin: 5 Pins 5 Wires

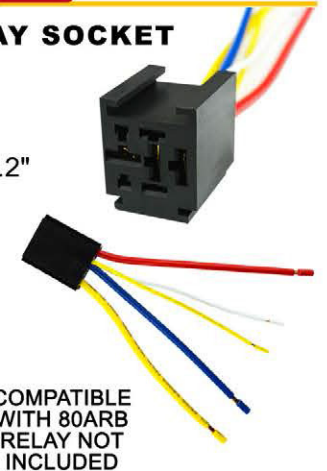

COMPATIBLE WITH 80ARB RELAY NOT INCLUDED

STACKABLE

HUNDREDS OF USES INCLUDE STARTER KILLS, DOMELIGHT SUPERVISION, TRUNK RELEASE, POLARITY CHANGE, POWER DOOR LOCK/ACTUATOR CONTROL, CHANGE A LOW CURRENT OUTPUT TO HIGH CURRENT, ADD IGNITION/ACCESSORY OUTPUTS, CONTROL MOTORS/OTHER ELECTRONICS. IT IS ALSO SUITABLE FOR AUTOMOBILES AND USED FOR CONTROL, ALARMS, HORN, HEADLIGHT AND MORE. LONG LIFE EXPENDENCY, MORE THAN 10,000 CYCLES.

40AWP-H **NEW**

**40A WATERPROOF 5 PIN RELAY SWITCH HARNESS SET**

- Waterproof: IP67
- Rated Load: 40A/14VDC
- Wire Length: 12 cm
- Contact Wire: AWG12

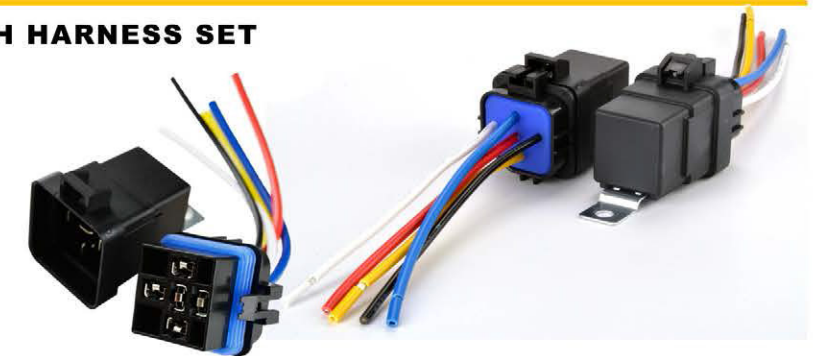

PRO-1205-CER **NEW**

**CERAMIC RELAY SOCKET**

- 16AWG wire suit for 4 pins relay ceramic relay socket, 5 pins auto relay holder
- Excellent heat corrosion resistance tin widing copper wires
- Easy DIY installation, no need tools
- Can be used to create extra light outlet
- Fit for Relay: 40A, 30ARF, 40AMP, 40ISR, and 40ISR-24V. 4 Pins/5 pins
- Length of cable: 14.5 cm / 5.7 inch
- Application temperature : 105° C / 221° F
- Voltage rated: 12-32V

CERAMIC MATERIAL SOCKET WITH EXTREMELY HIGH HEAT RESISTANT. PLUG AND WORK DIRECTLY, NO NEED TO CUT ANYTHING. GREAT FOR ADDING CAR STEREO, ALARM SYSTEM, REMOTE START, FOG LIGHTS, UNDERCAR LIGHTING, TURN ON DOMELIGHT, SHARED DOOR HANDLE, TRUCK RELEASE, REVERSE POLARITY, DOOR LOCKS AND MORE.

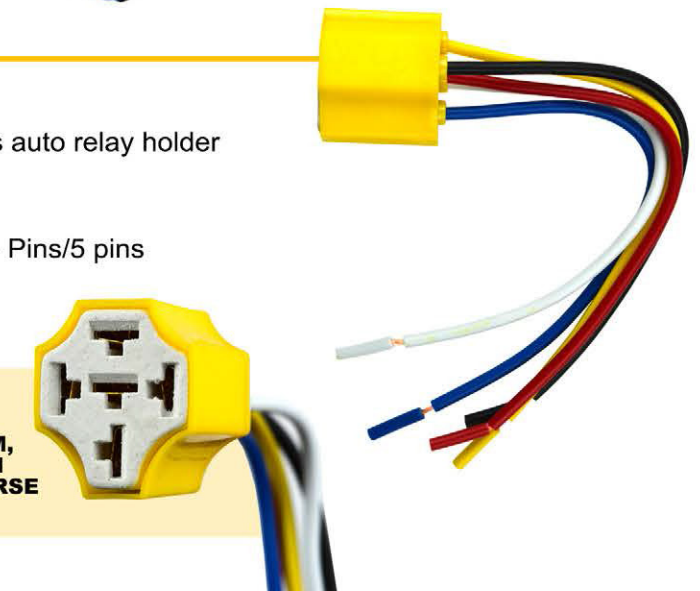



## WIRING HARNESSES

### WH-PIONEER01

**PIONEER RADIO  
REPLACEMENT WIRING  
HARNESS**

- 14 Gauge
- 2'
- Security Lock



### WH-PIONEER11

**PIONEER RADIO  
REPLACEMENT WIRING  
HARNESS**



### WH-SUB 9019

**WIRING HARNESS FOR  
SUBARU 1990 AND LATER  
MODELS**

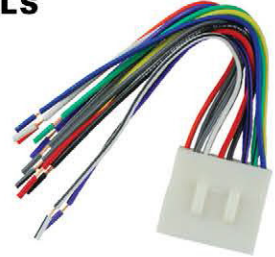

### WH-TOY 8486

**WIRING HARNESS FOR  
TOYOTA 1983-1986 MODELS  
AND DIAHATSU 1989-1992  
MODELS**



### WH-TOY 8702

**WIRING HARNESS FOR  
TOYOTA 1987-2002 MODELS**



### WH-VW8702

**WIRING HARNESS FOR  
VOLKSWAGEN 1987-2002  
MODELS**



### ISO-002

**WIRING HARNESS FOR  
VOLKSWAGEN MODELS**



### WH-ACU 9810

**WIRING HARNESS FOR  
HONDA AND ACURA 1998  
AND LATER MODELS**



### WH-HON 0208

**WIRING HARNESS FOR  
HONDA 2002 AND LATER  
MODELS**

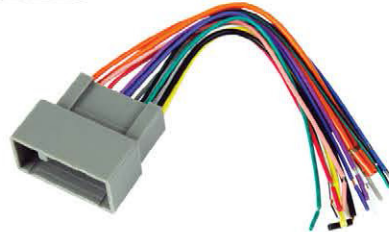

### WH-FORDAMP 9597

**WIRING HARNESS FOR  
FORD 1995-1997 MODELS**



### WH-GM 8802

**WIRING HARNESS FOR  
GM 1988-2002 MODELS**

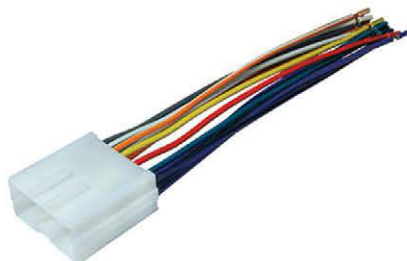

### WH-NIS 0210

**WIRING HARNESS FOR  
NISSAN 2002 AND LATER  
MODELS**

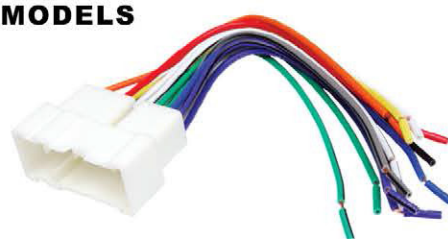

## WIRING HARNESSES

### WH-NIS 9502

**WIRING HARNESS FOR  
NISSAN 1995-2002  
MODELS**



### WH-NIS 8694

**WIRING HARNESS FOR  
NISSAN 1986-1994 MODELS**



### WH-NIS 0710

**WIRING HARNESS FOR  
NISSAN 2007 AND LATER  
MODELS**



### WH-HYN 0210

**WIRING HARNESS FOR  
HYUNDAI 2002 AND LATER  
MODELS**

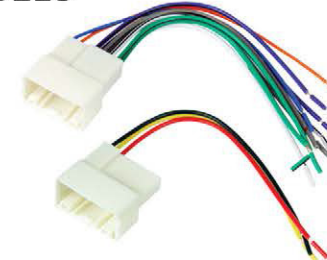

### WH-JVC09

**WIRING HARNESS FOR  
JVC MODELS**



### WH-JVC16P

**WIRING HARNESS FOR  
JVC MODELS**

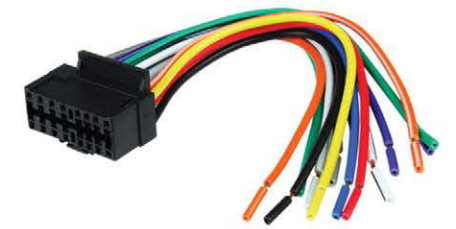

### WH-KENWOOD16P

**WIRING HARNESS FOR  
KENWOOD MODELS**



### WH-MAZ 0110

**WIRING HARNESS FOR  
MAZDA 2001 AND LATER  
MODELS**

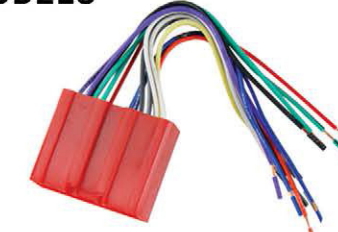

### WH-MAZ 8902

**WIRING HARNESS FOR  
MAZDA MODELS**



### WH-MIT 9410

**WIRING HARNESS FOR  
MITSUBISHI 1994 AND  
LATER MODELS**



### WH-VW-8602

**WIRING HARNESS FOR  
VOLKSWAGEN 1986-2002  
MODELS**



### VWS-1000

**WIRING HARNESS FOR  
VOLKSWAGEN 2000 AND  
LATER MODELS**





# LED PRODUCTS



## NL-LBC352

### 52" CURVED LED LIGHT BAR

- Beam: Spot-Flood Combo
- Operating Voltage: DC 10-30V
- Power: 288W (96 x 3W/pcs high intensity LEDs)
- Color Temperature: 6000K
- Lumen: 22000LM
- Lifespan: >30,000 hours
- Waterproof Rate: IP 67
- Lens Material: PC
- Housing Material: Diecast Aluminum
- Dimensions (LxWxH): 52" x 3.3" x 3"

52 IN

288  
WATTS

ALL NL-LBR LED LIGHT BARS INCLUDE MOUNTING & INSTALLATION HARDWARE

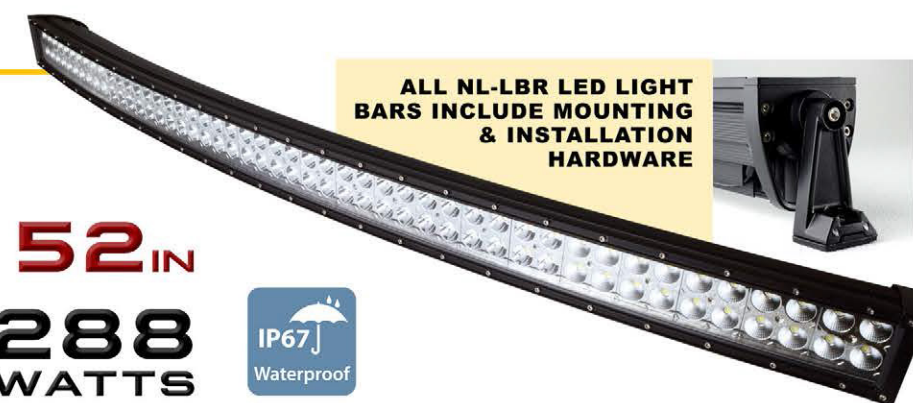

## NL-LBC354

### 54" CURVED LED LIGHT BAR

- Beam: Spot-Flood Combo
- Operating Voltage: DC 10-30V
- Power: 300W (100 x 3W/pcs high intensity LEDs)
- Color Temperature: 6000K
- Lumen: 22000LM
- Lifespan: >30,000 hours
- Waterproof Rate: IP 67
- Lens Material: PC
- Housing Material: Diecast Aluminum
- Dimensions (LxWxH): 54" x 3.3" x 3"

54 IN

300  
WATTS

WITH A CURVED LIGHT BAR, YOU WILL STILL BE ABLE TO GET THE SAME COMBO PATTERNS WITH THE SAME BASIC IDEA, HOWEVER, THIS WILL DISPERSE THE LIGHT EVEN WIDER. THE CURVED LIGHT BAR WILL GIVE YOU THE WIDEST FIELD OF VIEW, ALLOWING YOU TO ILLUMINATE THE LARGEST AREA POSSIBLE.

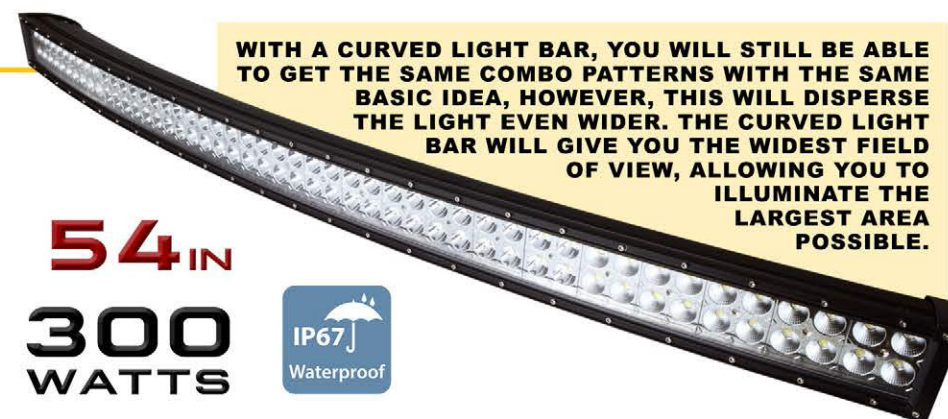

## NL-LBR353-288W

### 53" LED LIGHT BAR

- Beam: Spot-Flood Combo
- Operating Voltage: DC 10-30V
- Power: 288W (96 x 3W/pcs high intensity LEDs)
- Color Temperature: 6000K
- Lumen: 22000LM
- Lifespan: >30,000 hours
- Waterproof Rate: IP 67
- Lens Material: PC
- Housing Material: Diecast Aluminum
- Dimensions (LxWxH): 53" x 3.3" x 3"

53 IN

288  
WATTS

ALL OF OUR NL-LBR LED LIGHT BARS CAN BE USED ON ANY VEHICLE, ATV, BOAT, TRACTOR OR OTHER HEAVY EQUIPMENT. IT USES THE LATEST LED TECHNOLOGY, SUPPLYING SUPERIOR LIGHT OUTPUT AND OPTIMUM ENERGY EFFICIENCY



## NL-LBR355-300W

### 55" LED LIGHT BAR

- Beam: Spot-Flood Combo
- Operating Voltage: DC 10-30V
- Power: 300W (100 x 3W/pcs high intensity LEDs)
- Color Temperature: 6000K
- Lumen: 22000LM
- Lifespan: >30,000 hours
- Waterproof Rate: IP 67
- Lens Material: PC
- Housing Material: Diecast Aluminum
- Dimensions (LxWxH): 55" x 3.3" x 3"

55 IN

300  
WATTS



**NL-LBR333-180W**

**33" LED LIGHT BAR**

- Beam: Spot-Flood Combo
- Operating Voltage: DC 10-30V
- Power: 180W (60 x 3W/pcs high intensity LEDs)
- Color Temperature: 6000K
- Lumen: 22000LM
- Lifespan: >30,000 hours
- Waterproof Rate: IP 67
- Lens Material: PC
- Housing Material: Diecast Aluminum
- Dimensions (LxWxH): 33" x 3.3" x 3"

**33 IN**  
**180 WATTS**



**NL-LBR325-120W**

**25" LED LIGHT BAR**

- Beam: Spot-Flood Combo
- Operating Voltage: DC 10-30V
- Power: 120W (40 x 3W/pcs high intensity LEDs)
- Color Temperature: 6000K
- Lumen: 22000LM
- Lifespan: >30,000 hours
- Waterproof Rate: IP 67
- Lens Material: PC
- Housing Material: Diecast Aluminum
- Dimensions (LxWxH): 25" x 3.3" x 3"

**25 IN**  
**120 WATTS**



**NL-LBR317-72W**

**17" LED LIGHT BAR**

- Beam: Spot-Flood Combo
- Operating Voltage: DC 10-30V
- Power: 72W (24 x 3W/pcs high intensity LEDs)
- Color Temperature: 6000K
- Lumen: 22000LM
- Lifespan: >30,000 hours
- Waterproof Rate: IP 67
- Lens Material: PC
- Housing Material: Diecast Aluminum
- Dimensions (LxWxH): 17" x 3.3" x 3"

**17 IN**  
**72 WATTS**



**ALL NL-LBR LED LIGHT BARS INCLUDE MOUNTING AND INSTALLATION HARDWARE**

**NL-LBS326-72W**

**26" LED LIGHT BAR**

- Voltage: DC 10-30V
- Power: 72W (24pcs x 3W high intensity LEDs)
- Luminous Flux: 1530 LM
- Color Temperature: 6000K
- Service Life: 50000h
- Waterproof Rate: IP67
- Material: Aluminum alloy
- Dimensions (LxWxH): 26" x 1.8" x 1.2"
- Mounting Hardware Included

**26 IN**  
**72 WATTS**



**NL-LBMX382-25W**

**8" TRIPLE ROW 4D OFF-ROAD LED LIGHT**

- 8 inch, 25 W
- Voltage: 10 - 30V DC
- Waterproof: IP67
- LED Chips: 0.9W Epistar
- Color Temperature: 6000K
- Beam: Spot
- Material: Diecast Aluminum Housing
- Lens Material: PC Lens
- Mounting Bracket: Alu Firm Bracket and Stainless Steel Screws
- Span Life: >30,000 Hours
- Dimensions (LxWxH): 8" x 3.3" x 3"
- Mounting Hardware Included

**8 IN**  
**25 WATTS**



**NL-LBS36-18W**

**BEST SELLER**

**6" 18W LED MINI LIGHT BAR**

- Voltage: DC 10-30V
- Power: 18W
- 6 Pcs x 3W High Intensity LEDs
- Luminous Flux: 1530 LM
- Color Temperature: 6000K
- Service Life: 50000h
- Waterproof Rate: IP67
- Material: Aluminum Alloy
- Dimensions (LxWxH): 6" x 1.7" x 1.8"
- Mounting Hardware Included

**6 IN**  
**18 WATTS**



**THIS HIGH QUALITY MINI LIGHT BAR HAS 6 CREE LED BULBS WITH INTENSE BRIGHTNESS UP TO 1530 LUMENS AND IS HOUSED IN DIECAST ALUMINUM**

**NL-LBSQ-33-10W**

**10 WATTS**

**10W LED SPOT LIGHT**

- Power: 10W
- Voltage: 10-30W DC
- Waterproof Rate: IP 67
- LED Chips: 2.5W Cree
- Color Temperature: 6000K
- Lumen: 880 LM
- Beam: Spot / Flood
- Span Life: 50000 Hours
- Dimensions (LxWxH): 3.25" x 3" x 3"
- Mounting Hardware Included



**THIS SPOT LIGHT GIVES YOU WIDE-AREA COVERAGE. DESIGNED FOR RIGOROUS OFF-ROAD USE. THE WHOLE UNIT IS IP67 RATED TO BE DUST-TIGHT AND WITHSTAND BRIEF SUBMERSION. THE SPOT LIGHT IS EASY TO INSTALL WITH THE SUPPLIED BRACKET.**



**NL-LBSQ874D-10W**

**10 WATTS**

**10W LED SPOT LIGHT WITH 4D POLYCARBONATE LENS**

- Power: 10W
- Voltage: 10-30W DC
- Waterproof Rate: IP 67
- LED Chips: 2.5W Cree
- Color Temperature: 6000K
- Lumen: 880 LM
- Beam: Spot / Flood
- Span Life: 50000 Hours
- Dimensions (LxWxH): 3.25" x 3" x 3"
- Mounting Hardware Included



**THIS SPOT LIGHT USES A 4D PC LENS THAT CONCENTRATES THE LIGHT BEAMS AND CREATES AN EXTREMELY POWERFUL LIGHT VISIBLE IN DAYTIME**

**4D POLYCARBONATE LENS**





**NL-LBOV-43-20W**

**20W LED SPOT LIGHT**

- Power: 20W
- Voltage: 9-32V
- Waterproof Rate: IP 67
- Color temperature: 6500K
- Lumen: 1400LM
- Beam: Spot/Flood
- Dimensions (LxWxH): 4" x 3" x 2.5"
- Mounting Hardware Included

**20 WATTS**



**NL-LB303-18W**

**POPULAR**

**3" 12W CREE LED SPOT LIGHT**

- Description: Cree LED Light Bar
- Operation Voltage: 10-30V DC
- LED Module: 3W/pcs Cree LEDs
- LENS Material: Tempered Glass
- Beam: Spot, Flood, Combo
- Waterproof Level: IP67
- Color Temp.: 6000K~6500K
- Housing Material: Aluminum
- Life Span: >30,000 hours
- Dimensions (LxWxH): 3.7" x 2.6" x 3.1"
- Mounting Hardware Included

**3 IN  
12 WATTS**



**SUPER BRIGHT SPOT BEAM WITH HIGH QUALITY LED CHIPS EMIT BRIGHT CONCENTRATED WHITE LIGHT. THE POD CAN BE ADJUSTED TO ABOUT 45 DEGREES, WHICH MAKES CHANGING DIRECTION OF LIGHT BEAM EASIER. THIS PRODUCT IS UNIVERSAL AND WILL FIT ALL VEHICLES.**



**NL-LBRO-07-51W**

**51W LED FLOOD LIGHT**

- Power: 51W
- Voltage: 9-32V
- Color Temperature: 6500K
- Lumen: 4000LM
- Beam: Spot/Flood Epistar
- Dimensions (LxWxH): 7" x 2.5" x 7.5"
- Efficient cooling heat sink extends the lifespan of the work light
- Adjustable angle 180° range bracket
- Mounting Hardware Included

**51 WATTS**



**VERY BRIGHT RAYS FLOOD THE ROAD OR AREA MAKING IT PERFECT FOR OFF-ROADING OR AS A WORKLIGHT. WITH A TOUGH, ALUMINUM COVER, AND TOUGH SHATTERPROOF PC DURABLE TO WITHSTAND EXTREME CONDITION.**



**NL-LBSQ-14-27W**

**4" 27W LED FLOOD LIGHT**

- LED Light Color: White
- Voltage: 9V-36V
- Power: 27W (9pcs x 3W high intensity LEDs)
- Luminous Flux: 1980 LM
- Color temperature: 6000K
- Service Life: 30000h
- Material: Aluminum
- Bracket: Stainless steel bracket
- Waterproof Rate: IP67
- Dimensions (LxWxH): 4.3" x 4.3" x 1.4"
- Mounting Hardware Included

**4 IN  
27 WATTS**



**THE LED FLOOD WORK LIGHT IS COMPATIBLE WITH ALMOST ALL JEEPS, 4X4, TRUCKS, MOTORCYCLES, SUVs, ATVs, CARS, BOATS, ETC. MANY INDOOR AND OUTDOOR USES LIKE GARDEN LIGHTING, BACKYARD LIGHTING, BACK-UP LIGHT, OFF ROAD LIGHTING, CONSTRUCTION LIGHTING AND MORE**



**NL-LBSTRQ-15-27W**

**5" 27W LED FLOOD LIGHT**

- LED Light Color: White
- Voltage: 10V-30V
- Power: 27W (9pcs x 3W high intensity LEDs)
- Luminous Flux: 1800 LM
- Color temperature: 6000K
- Service Life: 30000h
- Material: Aluminum
- Bracket: Stainless steel bracket
- Waterproof Rate: IP67
- Dimensions (LxWxH): 5" x 5" x 1.4"
- Mounting Hardware Included

**5 IN  
27 WATTS**



**NOW MORE DURABLE THAN EVER WITH IT'S GROOVED HEAT SINK FINS EXTENDS COOLING SURFACE FOR QUICK HEAT ELIMINATION, EXTENDING THIS WORK LIGHT'S LIFESPAN OVER 30,000 HOURS! IT'S INSTANT START, SMART SYSTEM PROTECTS THIS LIGHT FROM DAMAGE EVEN IF IT IS CONNECTED TO THE WRONG POLARITY**



**NL-LBSQ-15-27W**

**5" 27W LED FLOOD LIGHT WITH STROBE**

- LED Light Color: White & Yellow (Flashing light)
- Voltage: DC 10-30V
- Power: 27W (9pcs x 3W high intensity LEDs)
- Luminous Flux: 1800 LM
- Color Temperature: 6000K
- Service Life: 30000h
- Material: Aluminum alloy
- Bracket: Stainless steel bracket
- Waterproof Rate: IP67
- Dimensions (LxWxH): 5" x 5" x 1.4"
- Mounting Hardware Included

**5 IN  
27 WATTS**



**With amber LED strobe effect!**



**NL-H-9005-36W**

**S1 LED HEADLIGHT-9005**

- Power: 36 Watts per piece
- Voltage: 9-32V (fits 12V/24V vehicles)
- Lumen: 3600 LM
- Ideal for High Beam Reflector headlights
- Easy one click Installation
- Secure temperature range up to 6500K
- With LED CSP beam
- Constant brightness output at all times



**NL-H-9006-36W**

**S1 LED HEADLIGHT-9006**

- Power: 36 Watts per piece
- Voltage: 9-32V (fits 12V/24V vehicles)
- Lumen: 3600 LM
- Enhanced light efficiency
- Easy one click Installation
- Secure temperature range up to 6500K
- With LED CSP beam





**NL-H-9007-36W**

**S1 LED HEADLIGHT-9007**

- Power: 36 Watts per piece
- Voltage: 9-32V (fits 12V/24V vehicles)
- Lumen: 3600 LM
- Easy one click Installation
- Secure temperature range up to 6500K
- With LED CSP beam



**NL-H-H1-36W**

**H1 LED HEADLIGHT**

- Power: L/36W, H/36W
- Voltage: 9V-32V DC
- Working Temperature: -40°C~ +85°C
- LED Type: CSP x 6 PCS (SINGLE BEAM), CSP x 12PCS(DOUBLE BEAM)
- Lumens: 4000LM
- Cooling System: Aviation Aluminum 6063
- Color Temperature: 6000K
- Waterproof: IP67
- Beam Angle: 360°
- Material: Aluminum Alloy
- Lifespan: 50,000hrs



**NL-H-H4-36W**

**H4 LED HEADLIGHT**

- Power: L/36W, H/36W
- Voltage: 9V-32V DC
- Working Temperature: -40°C~ +85°C
- LED Type: CSP x 6 PCS (SINGLE BEAM), CSP x 12PCS(DOUBLE BEAM)
- Lumens: 4000LM
- Cooling System: Aviation Aluminum 6063
- Color Temperature: 6000K
- Waterproof: IP67
- Beam Angle: 360°
- Material: Aluminum Alloy
- Lifespan: 50,000hrs



**NL-H-H7-36W**

**H5 LED HEADLIGHT**

- Power: L/36W, H/36W
- Voltage: 9V-32V DC
- Working Temperature: -40°C~ +85°C
- LED Type: CSP x 6 PCS (SINGLE BEAM), CSP x 12PCS(DOUBLE BEAM)
- Lumens: 4000LM
- Cooling System: Aviation Aluminum 6063
- Color Temperature: 6000K
- Waterproof: IP67
- Beam Angle: 360°
- Material: Aluminum Alloy
- Lifespan: 50,000hrs



**NL-H-H11-36W**

**H11 LED HEADLIGHT**

- Power: L/36W, H/36W
- Voltage: 9V-32V DC
- Working Temperature: -40°C~ +85°C
- LED Type: CSP x 6 PCS (SINGLE BEAM), CSP x 12PCS(DOUBLE BEAM)
- Lumens: 4000LM
- Cooling System: Aviation Aluminum 6063
- Color Temperature: 6000K
- Waterproof: IP67
- Beam Angle: 360°
- Material: Aluminum Alloy
- Lifespan: 50,000hrs



**NL-H-H13-36W**

**H13 LED HEADLIGHT**

- Power: L/36W, H/36W
- Voltage: 9V-32V DC
- Working Temperature: -40°C~ +85°C
- LED Type: CSP x 6 PCS (SINGLE BEAM), CSP x 12PCS(DOUBLE BEAM)
- Lumens: 4000LM
- Cooling System: Aviation Aluminum 6063
- Color Temperature: 6000K
- Waterproof: IP67
- Beam Angle: 360°
- Material: Aluminum Alloy
- Lifespan: 50,000hrs



**NL-CAN-H-H4** **NEW**

**LED HEADLIGHT WITH CANBUS**

- Power: L/36W, H/36W
- Voltage: 12V-24V DC
- Working Temperature: -40°C~ +85°C
- LED Type: CSP x 6 PCS (SINGLE BEAM), CSP x 12PCS
- Lumens: 4000LM
- Cooling System: Aviation Aluminum 6063
- Color Temperature: 6000K
- Waterproof: IP67
- Beam Angle: 360°
- Material: Aluminum Alloy
- Lifespan: 50,000hrs



**NL-CAN-H-H7** **NEW**

**LED HEADLIGHT WITH CANBUS**

- Power: L/36W, H/36W
- Voltage: 12V-24V DC
- Working Temperature: -40°C~ +85°C
- LED Type: CSP x 6 PCS (SINGLE BEAM), CSP x 12PCS
- Lumens: 4000LM
- Cooling System: Aviation Aluminum 6063
- Color Temperature: 6000K
- Waterproof: IP67
- Beam Angle: 360°
- Material: Aluminum Alloy
- Lifespan: 50,000hrs





**NL-CAN-H-H11 NEW**

**LED HEADLIGHT WITH CANBUS**

- Power: L/36W, H/36W
- Voltage: 12V-24V DC
- Working Temperature: -40°C~ +85°C
- LED Type: CSP x 6 PCS (SINGLE BEAM), CSP x 12PCS
- Lumens: 4000LM
- Cooling System: Aviation Aluminum 6063
- Color Temperature: 6000K
- Waterproof: IP67
- Beam Angle: 360°
- Material: Aluminum Alloy
- Lifespan: 50,000hrs



**NL-CAN-H-9005 NEW**

**LED HEADLIGHT WITH CANBUS**

- Power: L/36W, H/36W
- Voltage: 12V-24V DC
- Working Temperature: -40°C~ +85°C
- LED Type: CSP x 6 PCS (SINGLE BEAM), CSP x 12PCS
- Lumens: 4000LM
- Cooling System: Aviation Aluminum 6063
- Color Temperature: 6000K
- Waterproof: IP67
- Beam Angle: 360°
- Material: Aluminum Alloy
- Lifespan: 50,000hrs



**NL-CAN-H-9006 NEW**

**LED HEADLIGHT WITH CANBUS**

- Power: L/36W, H/36W
- Voltage: 12V-24V DC
- Working Temperature: -40°C~ +85°C
- LED Type: CSP x 6 PCS (SINGLE BEAM), CSP x 12PCS
- Lumens: 4000LM
- Cooling System: Aviation Aluminum 6063
- Color Temperature: 6000K
- Waterproof: IP67
- Beam Angle: 360°
- Material: Aluminum Alloy
- Lifespan: 50,000hrs



**NL-HL-7243-72W NEW**

**72W LED HEADLIGHT**

- Led Power: 72W
- LED Chip: 24PCS x 3W (hi/lo & DRL are Cree 3030)
- With (DRL) Daytime Running Lights
- Waterproof: IP67
- Lens: PMMA
- Beam: Flood \ Spotlight Combo
- Size: 195 x 140 x 70 mm (7.7" x 5.5" x 2.8")

**7 IN  
72 WATTS**

**WITH (DRL)  
DAYTIME  
RUNNING  
LIGHTS**



**NL-LBKT-10 NEW**

**LED LIGHT BAR WIRING KIT WITH SWITCH FUSE AND RELAY**

- Universal Wiring Harness Equipped with a Fuse, Relay, and Illuminated ON/OFF Switch.
- Easily Connects any Lighting Accessory to its Power Source by Tapping into the Battery Directly.
- This Wiring Kit is Compatible with any LED, HID, or Halogen Off-Road LightBar, Work Light or Auxiliary Lights
- Perfect for Fog Lights, Work Lights, Spot Lights, Off-Road Driving Light, etc.
- Voltage: 12V
- Current: 40A
- Fuse Ampere Rating: 30A



**UNIVERSAL WIRING HARNESS WITH A FUSE, RELAY, AND ILLUMINATED ON/OFF SWITCH. THIS KIT ALLOWS YOU TO HOOK UP YOUR LIGHTS DIRECTLY TO YOUR BATTERY AND CONTROL IT CONVENIENTLY FROM THE ON/OFF SWITCH.**

**Wire Harness Kit  
Wiring diagram**

**NL-LBKT-10**

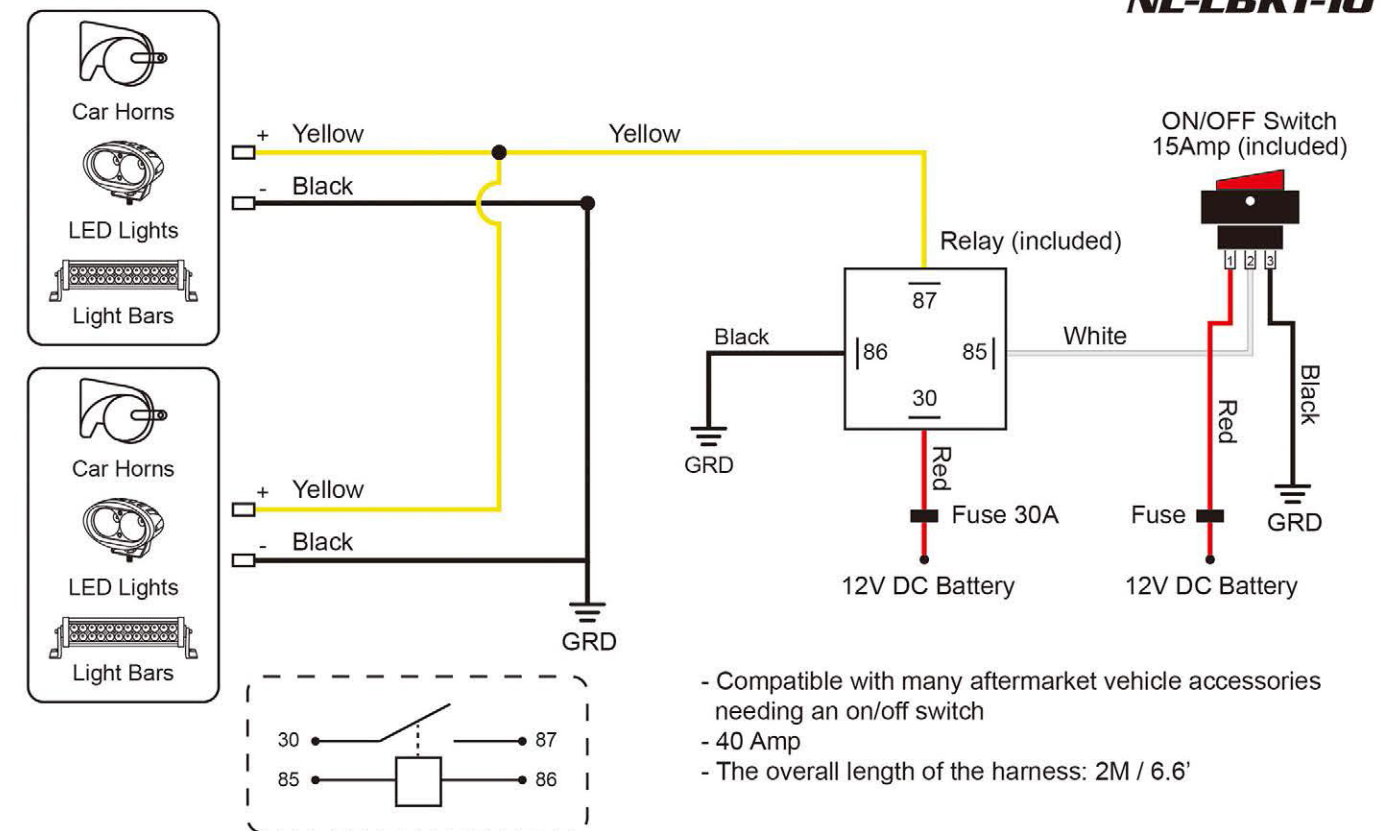

- Compatible with many aftermarket vehicle accessories needing an on/off switch
- 40 Amp
- The overall length of the harness: 2M / 6.6'



# SWITCHES



## FUNCTION KEY



**SPST**  
SINGLE POLE  
SINGLE THROW

A SINGLE POLE SINGLE THROW (SPST) SWITCH IS A SWITCH THAT ONLY HAS A SINGLE INPUT AND CAN CONNECT ONLY TO ONE OUTPUT. THIS MEANS IT ONLY HAS ONE INPUT TERMINAL AND ONLY ONE OUTPUT TERMINAL. A SINGLE POLE SINGLE THROW SWITCH SERVES IN CIRCUITS AS ON-OFF SWITCHES. WHEN THE SWITCH IS CLOSED, THE CIRCUIT IS ON.

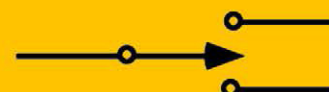

**SPDT**  
SINGLE POLE  
DOUBLE THROW

A SINGLE POLE DOUBLE THROW (SPDT) SWITCH IS A SWITCH THAT ONLY HAS A SINGLE INPUT AND CAN CONNECT TO AND SWITCH BETWEEN THE 2 OUTPUTS. THIS MEANS IT HAS ONE INPUT TERMINAL AND TWO OUTPUT TERMINALS. A SINGLE POLE DOUBLE THROW SWITCH CAN SERVE A VARIETY OF FUNCTIONS IN A CIRCUIT.

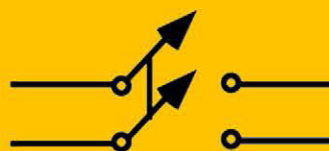

**DPST**  
DOUBLE POLE  
SINGLE THROW

A DOUBLE POLE SINGLE THROW (DPST) SWITCH IS A SWITCH THAT HAS 2 INPUTS AND 2 OUTPUTS; EACH INPUT HAS 1 CORRESPONDING OUTPUT. EACH OF THE TERMINALS OF A DOUBLE POLE SINGLE SWITCH CAN EITHER BE IN THE ON POSITION (CLOSED) OR IN THE OFF POSITION (OPEN).

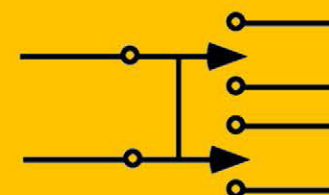

**DPDT**  
DOUBLE POLE  
DOUBLE THROW

A DOUBLE POLE DOUBLE THROW (DPDT) SWITCH IS A SWITCH THAT HAS 2 INPUTS AND 4 OUTPUTS; EACH INPUT HAS 2 CORRESPONDING OUTPUTS THAT IT CAN CONNECT TO. EACH OF THE TERMINALS OF A DOUBLE POLE DOUBLE SWITCH CAN EITHER BE IN 1 OF 2 POSITIONS. THIS MAKES THE THE DOUBLE POLE DOUBLE THROW SWITCH A VERY VERSATILE SWITCH.

### EC-PHPL10A12V NEW

#### SPST UNIVERSAL PUSH-PULL SWITCH

- Current Rating: 10A 12VDC; 6A 30VDC
- Contact resistance: < 50MΩ
- Insulation resistance: >500VDC 1000MΩ Minute
- Dielectric Strength: >1500VAC, 1 Minute
- Operating Temperature: -25°C~+85°C
- Mechanical life:>50000 CYCLES
- Electrical life: >10000 CYCLES
- Height: 17mm
- 2 Pins

**IDEAL FOR CONTROLLING THE HIGH AND LOW LIGHT ON YOUR AUTOMOBILE HEADLIGHTS. ALSO PERFECT FOR CONTROL OF BUS DOORS AND OTHER USES.**





## TOGGLE SWITCHES

**EPS-3015BK (BLACK)**  
**EPS-3015CB (CARBON)**  
**EPS-3015CH (CHROME)**  
**EPS-3015BL (BLUE)**  
**EPS-3015RD (RED)**



### ILLUMINATED PILOT SAFETY TOGGLE SWITCH

- Long lifespan: About 10,000 cycles
- Ergonomic design: Toggle switch with dustproof and waterproof black safety cover, and rocker with white LED light
- Rating: 12V-20A
- Body size: 1.1" x 0.6" x 2.7" (L\*W\*H)
- Mount Hole Size: 1/2 Inch

**CAN BE USED AS A SWITCH FOR VARIOUS ELECTRICAL APPLICATIONS INSIDE & OUTSIDE THE CAR. SUCH AS IGNITION BOOST, FANS, LIGHTS, WINCHES, NOS SYSTEMS, CLASS A AMP FANS, COMPUTER LED'S, AND MORE.**



### IS-EC-MT1220BLU

#### METAL TOGGLE SWITCH WITH BLUE LED AND 6" LEAD WIRE

- Current Rating: 20A, 12V
- 2 Pins
- Blue LED
- 6" Lead Wire
- Mount Hole Size: 1/2 Inch

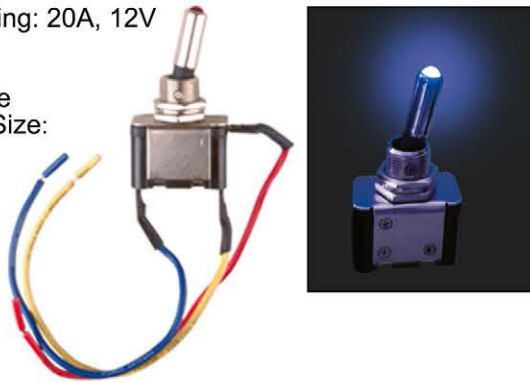

### IS-EC-MT1220RED

#### METAL TOGGLE SWITCH WITH RED LED AND 6" LEAD WIRE

- Current Rating: 20A, 12V
- 2 Pins
- Red LED
- 6" Lead Wire
- Mount Hole Size: 1/2 Inch

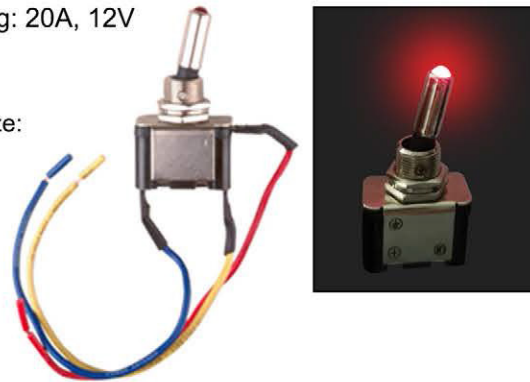

**BEST SELLER**

### IS-EC-W1210 CVR

#### HEAVY DUTY ON/OFF TOGGLE SWITCH WITH WATERPROOF BOOT CAP COVER

- Applicable for All 12-24 DC Volts Connections
- Heavy-Duty Toggle Switch Suitable for Marine, Industrial, or Automotive Applications
- Made from Sturdy Material that Ensures Long Lasting Durability, Facilitate Easy Installation
- Power: 10A 250VAC / 20A 125VAC
- Mount Hole Size: 1/2 Inch



**10/20A**

### IS-EC-W1220 CVR

#### HEAVY DUTY ON/OFF TOGGLE SWITCH WITH WATERPROOF BOOT CAP COVER

- Applicable for All 12-24 DC Volts Connections
- Heavy-Duty Toggle Switch Suitable for Marine, Industrial, or Automotive Applications
- Made from Sturdy Material that Ensures Long Lasting Durability, Facilitate Easy Installation
- Power: 20A 250VAC / 15A 125VAC
- Mount Hole Size: 1/2 Inch



**20/15A**

## TOGGLE SWITCHES

### IS-EC-W1215 CVR **15AMP**

#### SPST ON/OFF TOGGLE SWITCH WITH WATERPROOF BOOT CAP COVER

- Applicable for all 12-24 DC Volts Connections
- Heavy-Duty Toggle Switch Suitable for Marine, Industrial, or Automotive Applications
- Made from Sturdy Material that Ensures Long Lasting Durability, Facilitate Easy Installation
- Power: 15A 125VAC
- 2 Pins
- Mount Hole Dimensions: 1/2 Inch



### IS-EC-W1215MC **NEW 15AMP**

#### SPST WATERPROOF MOMENTARY ON TOGGLE SWITCH

- Applicable for all 12 DC volt connections
- Heavy-Duty toggle switch suitable for marine, industrial, or automotive applications
- Made from sturdy material that ensures long lasting durability, facilitate easy installation
- Power: 15A 125VAC
- 2 Pins
- Mount Hole Dimensions: 1/2 Inch



**FOR HORNS OR TEMPORARY LIGHTING. HEAVY-DUTY SPADE TYPE TERMINAL. 1/2" MOUNTING HOLE REQUIRED.**

### IS-EC-W1215DC **NEW 20AMP**

#### SPDT WATERPROOF DUAL PURPOSE (ON-OFF-ON) TOGGLE SWITCH

- Material: plastic and metal. Solid connection switch with waterproof rubber cap, more convenient to operate.
- Connector type: SPST, 3 terminal pin on/off.
- Power: 15A 250VAC/20A 125VAC, 2 pole (2 wire contacts to hook to) switch, red positive, the standard "hot" wire, black is negative
- Mechanical life: more than 50,000 cycles.
- Electrical life: more than 10,000 cycles
- Each of the terminals has a machine screw for quick connections, but also easy to be soldered
- Dimensions: 1.12" x 0.63" x 2.21"
- Mount Hole Size: 1/2 Inch



**IDEAL FOR INDUSTRIAL EQUIPMENT, AUTOMOTIVE OR EMERGENCY LIGHTING. 1/2" MOUNTING HOLE REQUIRED.**

### IS-EC-IT1220BLU

#### ILLUMINATED TOGGLE SWITCH WITH 6" LEAD WIRE

- Current Rating: 20A, 12V
- 3 Pins
- Blue Color
- 6" Lead Wire
- Mount Hole Size: 1/2 Inch

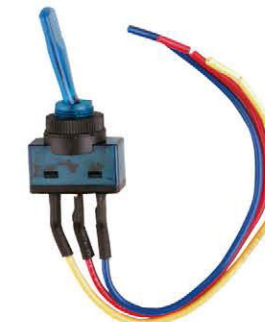

### IS-EC-IT1220RED

#### ILLUMINATED TOGGLE SWITCH WITH 6" LEAD WIRE

- Current Rating: 20A, 12V
- 3 Pins
- Blue Color
- 6" Lead Wire
- Mount Hole Size: 1/2 Inch

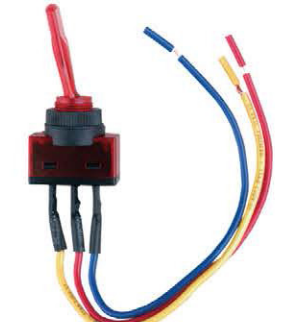



**EC-1521MM**

**DPDT MOMENTARY ON-OFF-ON TOGGLE SWITCH**

- Current Rating: 20A, 125V, 15A, 250V
- 6 Pins
- 117V AC
- Mounting Hole Size: 12/25 Inch



**20 AMP**

**EC-1522**

**BEST SELLER**

**SPST ON-OFF TOGGLE SWITCH**

- Current Rating: 20A, 125V, 10A, 250V
- 2 Pins
- 117V AC
- Mounting Hole Size: 12/25 Inch



**20 AMP**

**EC-1523**

**SPDT ON-OFF-ON TOGGLE SWITCH**

- Current Rating: 15A, 125V, 10A, 250V
- 6 Pins
- 117V AC
- Mounting Hole Size: 12/25 Inch



**15 AMP**

**EC-1524**

**SPDT ON-OFF-ON TOGGLE SWITCH**

- Current Rating: 15A, 125V, 10A, 250V
- 3 Pins
- 117V AC
- Mounting Hole Size: 12/25 Inch



**15 AMP**

**EC-2510**

**BEST SELLER**

**SPST ON-OFF MINI TOGGLE SWITCH**

- Current Rating: 6A, 125V, 3A, 250V
- 2 Pins
- Mounting Hole Size: 1/4 Inch



**6 AMP**

**EC-2530**

**SPDT ON-OFF-ON MINI TOGGLE SWITCH**

- Current Rating: 6A, 125V, 3A, 250V
- 3 Pins
- Mounting Hole Size: 1/4 Inch



**6 AMP**

**EC-2550**

**DPDT ON-OFF-ON MINI TOGGLE SWITCH**

- Current Rating: 6A, 125V, 3A, 250V
- 6 Pins
- Mounting Hole Size: 1/4 Inch



**6 AMP**

**EC-2533P**

**SPDT ON-OFF-ON CONNECTOR SWITCH**

- Current Rating: 6A, 125V, 3A, 250V
- 3 Pins
- Mounting Hole Size: 1/4 Inch



**6 AMP**

**EC-1500**

**DPDT CENTER-OFF TOGGLE SWITCH**

- Mounting Hole Size: 12/25 Inch
- 117V AC
- 6 AMP
- 6 Pins



**6 AMP**

**EC-1501**

**DPDT CENTER-OFF TOGGLE SWITCH**

- Mounting Hole Size: 12/25 Inch
- 117V AC
- 3 AMP
- 6 Pins



**3 AMP**

**EC-1502**

**DPDT CENTER-OFF TOGGLE SWITCH**

- Mounting Hole Size: 12/25 Inch
- 117V AC
- 4 AMP
- 4 Pins



**4 AMP**

**BEST SELLER**

**EC-1503**

**DPDT CENTER-OFF TOGGLE SWITCH**

- Mounting Hole Size: 12/25 Inch
- 117V AC
- Current Rating: 4A-125V, 2A-250V AC
- 3 AMP
- 2 Pins



**3 AMP**

**EC-1510**

**DPDT CENTER-OFF TOGGLE SWITCH**

- Mounting Hole Size: 12/25 Inch
- 117V AC
- Current Rating: 6A-250V, 10A-125V AC
- 10 AMP
- 6 Pins



**10 AMP**

**EC-1515**

**DPDT ON-OFF-ON TOGGLE SWITCH**

- Mounting Hole Size: 12/25 Inch
- 117V AC
- Current Rating: 10A-250V, 15A-125V AC
- 15 AMP
- 6 Pins



**15 AMP**

**EC-1512**

**SPST ON-OFF TOGGLE SWITCH**

- Mounting Hole Size: 12/25 Inch
- 117V AC
- Current Rating: 10A-250V, 15A-125V AC
- 15 AMP
- 2 Pins



**15 AMP**

**EC-1515P**

**SPDT ON-OFF-ON TOGGLE SWITCH**

- Mounting Hole Size: 12/25 Inch
- 117V AC
- Current Rating: 10A-250V, 15A-125V AC
- 15 AMP
- 3 Pins



**15 AMP**

**POPULAR**

**EC-1520**

**DPDT CENTER-OFF TOGGLE SWITCH**

- Mounting Hole Size: 12/25 Inch
- 117V AC
- Current Rating: 20A-126V, 10A-250V AC
- 20 AMP
- 6 Pins



**20 AMP**



## ROCKER SWITCHES

**IS-EC-WP1213BLACK**  
**IS-EC-WP1213BLUE**  
**IS-EC-WP1213RED**



**SPST LED ILLUMINATED ON/OFF ROCKER SWITCH**

- Current Rating: 10A 12V
- 3 Pins
- Waterproof
- Mounting Diameter: 3/4 Inch

**IS-EC-WP1216BLU**  
**IS-EC-WP1216GRN**  
**IS-EC-WP1216RED**



**SPST LED ILLUMINATED ON/OFF ROCKER SWITCH**

- Current Rating: 16A 12V
- 3 Pins
- Waterproof
- Mounting Diameter: 3/4 Inch

**EC-1103**

**SPST ON/OFF ROCKER SWITCH**

- Current Rating: 6A 250V, 10A 125V
- 3 Pins
- For 110V Applications
- Mounting Diameter: 3/4 Inch



**EC-1103ABL** **POPULAR**

**SPST ON/OFF ROCKER SWITCH WITH BLUE LED ON INDICATOR**

- Current Rating: 6.5A 250V, 13A 125V
- 3 Pins
- For 110V Applications
- Mounting Diameter: 3/4 Inch



**EC-1103ARD** **POPULAR**

**SPST ON/OFF ROCKER SWITCH WITH RED LED ON INDICATOR**

- Current Rating: 6.5A 250V, 13A 125V
- 3 Pins
- For 110V Applications
- Mounting Diameter: 3/4 Inch



**EC-1210SCR**

**SPST ON/OFF ROCKER SWITCH**

- Current Rating: 10A 125V, 6A 250V
- 2 Pins
- For 110V Applications
- Mounting Diameter: 3/4 Inch



**EC-1213 BLU**

**SPST ON/OFF ROCKER SWITCH WITH BLUE LED ON INDICATOR**

- 3 Pins
- Mounting Diameter: 3/4 Inch
- For 12V Applications



**EC-1213 RED**

**SPST ON/OFF ROCKER SWITCH WITH RED LED ON INDICATOR**

- 3 Pins
- Mounting Diameter: 3/4 Inch
- For 12V Applications



## ROCKER SWITCHES

**EC-1215**

**SPST LED ILLUMINATED ON/OFF ROCKER SWITCH**

- Current Rating: 10A 12V
- 3 Pins
- Red LED
- Mounting Diameter: 3/4 Inch



**EC-1217 BLU**

**SPST LED ILLUMINATED ON/OFF ROCKER SWITCH**

- Current Rating: 10A 12V
- 3 Pins
- Blue LED
- Mounting Diameter: 3/4 Inch



**EC-1213** **BEST SELLER**

**SPST ON/OFF ROCKER SWITCH**

- Current Rating: 10A 12V
- 2 Pins
- Mounting Diameter: 3/4 Inch



**IS-EC-RS12513**

**SPST ON/OFF MINI ROCKER SWITCH WITH 6" LEAD WIRE**

- Current Rating: 6.5A 250V, 13A 125V
- 2 Pins
- Mounting Diameter: 3/4 Inch



**IS-EC-RS1216RED**

**SPST ON/OFF MINI ROCKER SWITCH WITH RED LED INDICATOR AND 6" LEAD WIRE**

- Current Rating: 16A 12V
- 3 Pins
- Mounting Diameter: 3/4 Inch

**BEST SELLER**

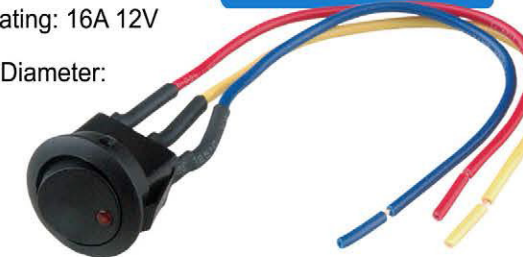

**IS-EC-RS1216BLU**

**SPST ON/OFF MINI ROCKER SWITCH WITH BLUE LED INDICATOR AND 6" LEAD WIRE**

- Current Rating: 16A 12V
- 3 Pins
- Mounting Diameter: 3/4 Inch

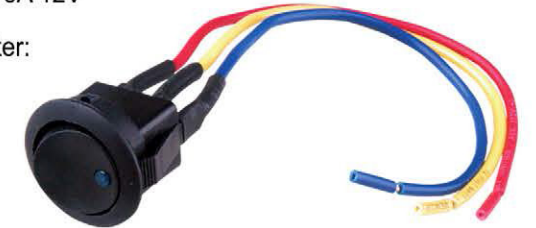

**IS-EC-IR1216RED**

**SPST LED ILLUMINATED ON/OFF MINI ROCKER SWITCH WITH 6" LEAD WIRE**

- Current Rating: 16A 12V
- 3 Pins
- Mounting Diameter: 3/4 Inch
- Red LED

**POPULAR**



**IS-EC-IR1216BLU**

**SPST LED ILLUMINATED ON/OFF MINI ROCKER SWITCH WITH 6" LEAD WIRE**

- Current Rating: 16A 12V
- 3 Pins
- Mounting Diameter: 3/4 Inch
- Blue LED

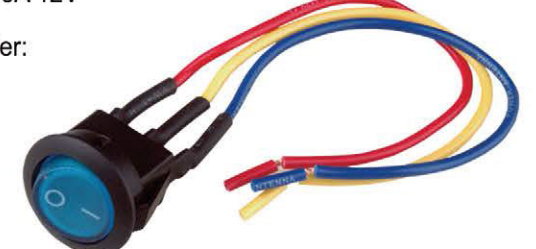



## ROCKER SWITCHES

### IS-EC-OVL12-BLU

#### LED ILLUMINATED ON/OFF OVAL SPST ROCKER SWITCH

- Easily Fits in 12mm Diameter Opening
- Designed to Connect and Disconnect an Electrical Circuit at will - Applicable for Car, Motorcycle, Boat, UTV, RV
- Lower LED is Independent and can be Wired to Separate Dash Light Circuit
- Material: ABS
- LED Light Color: Blue
- Current Rating: 20A 12V
- 3 Pins



### IS-EC-OVL12-RED

#### LED ILLUMINATED ON/OFF OVAL SPST ROCKER SWITCH

- Easily Fits in 12mm Diameter Opening
- Designed to Connect and Disconnect an Electrical Circuit at will - Applicable for Car, Motorcycle, Boat, UTV, RV
- Lower LED is Independent and can be Wired to Separate Dash Light Circuit
- Material: ABS
- LED Light Color: Red
- Current Rating: 20A 12V
- 3 Pins



### ECSW-RSOF-BLU

#### LED ILLUMINATED ON/OFF MARINE GRADE SPDT ROCKER SWITCH

- Marine grade
- 3 pins
- On-Off SPDT Rocker switch
- Blue led status indicator
- 12V 20A DC
- 24V 10A DC



### ECSW-RSOF-RED

#### LED ILLUMINATED ON/OFF MARINE GRADE SPDT ROCKER SWITCH

- Marine grade
- 3 pins
- On-Off SPDT Rocker switch
- Red led status indicator
- 12V 20A DC
- 24V 10A DC



### ECSW-RSOF-BLK

#### ON/OFF MARINE GRADE SPDT ROCKER SWITCH

- Marine grade
- 2 pins
- On-Off SPDT Rocker switch
- 12V 20A DC
- 24V 10A DC



### ECSW-MOU-SIN

#### MOUNTING PANEL FOR ROCKER SWITCH

- Marine grade
- Compatible with:  
ECSW-RSOF-RED  
ECSW-RSOF-BLU  
ECSW-RSOF



### ECSW-MOU-MID

#### MOUNTING PANEL MIDDLE PIECE

- Compatible with:  
ECSW-RSOF-RED  
ECSW-RSOF-BLU  
ECSW-RSOF



### ECSW-MOU-END

#### MOUNTING PANEL END PIECE

- Compatible with:  
ECSW-RSOF-RED  
ECSW-RSOF-BLU  
ECSW-RSOF



COMBINE PIECES TO CREATE YOUR OWN PERSONALIZED MARINE PANEL CONTROL CENTER

COMBINE PIECES TO CREATE YOUR OWN PERSONALIZED MARINE PANEL CONTROL CENTER

## ROCKER SWITCHES

POPULAR

### EC-1220 BLU

#### SPST LED ILLUMINATED ON/OFF MINI ROCKER SWITCH

- Mount Hole Dimensions: 1/2" x 3/4"
- Current Rating: 10A 12V
- LED Light Color: Blue
- 3 Pins
- Overall Dimensions: 1-1/16 x 1/2



POPULAR

### EC-1220 RED

#### SPST LED ILLUMINATED ON/OFF MINI ROCKER SWITCH

- Mount Hole Dimensions: 1/2" x 3/4"
- Current Rating: 10A 12V
- LED Light Color: Red
- 3 Pins
- Overall Dimensions: 1-1/16 x 1/2



BEST SELLER

### EC-1220 WHT

#### SPST LED ILLUMINATED ON/OFF MINI ROCKER SWITCH

- Mount Hole Dimensions: 1/2" x 3/4"
- Current Rating: 10A 12V
- LED Light Color: White
- 3 Pins
- Overall Dimensions: 1-1/16 x 1/2



### EC-2602

#### SPST ON/OFF ROCKER SWITCH

- Current Rating: 20A 125V AC
- 2 Pins
- Mount Hole Dimensions: 1 x 13/32



### EC-2604

#### DPDT ON/OFF ROCKER SWITCH

- Current Rating: 10A 125V AC
- 4 Pins
- Mount Hole Dimensions: 1 x 13/16



BEST SELLER

### EC-2606

#### DPDT ON/OFF ROCKER SWITCH

- Current Rating: 10A 125V AC
- 6 Pins
- Mount Hole Dimensions: 1 x 13/16



### EC-2636

#### DPDT ON/OFF ROCKER SWITCH

- Current Rating: 3A 125V AC
- 6 Pins
- Mount Hole Dimensions: 1" x 13/16"



### EC-315

#### SPST ILLUMINATED ON/OFF ROCKER SWITCH

- Current Rating: 15A 125V AC
- 3 Pins
- Mount Hole Dimensions: 1 x 1/2

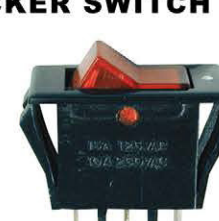

BEST SELLER

### EC-620

#### DPDT ILLUMINATED ON/OFF ROCKER SWITCH

- Current Rating: 20A 125V
- 6 Pins
- Mount Hole Dimensions: 1 x 13/16



### EC-623

#### DPDT ILLUMINATED ON/OFF ROCKER SWITCH

- Current Rating: 20A 125V
- 6 Pins
- Mount Hole Dimensions: 1 x 7/8



### EC-1115

#### SPST ON/OFF ROCKER SWITCH

- Current Rating: 3A 250V, 6A 125V
- 2 Pins
- Mount Hole Dimensions: 1/2 x 11/32



### EC-1115PP

#### SPST ON/OFF ROCKER SWITCH

- Current Rating: 3A 250V, 6A 125V
- 3 Pins
- Mount Hole Dimensions: 3/4 x 1/2





**IS-EP-WB123BLU** **NEW**

**LED ILLUMINATED PUSH BUTTON SWITCH**

- Mounting Diameter: 5/8 Inch
- Switch Rating: 3A/250AC
- Operation Type: Push it - ON, Push it again - OFF
- Power Symbol LED can be on all the time or only when the switch is on which depends on how you wire it
- Great for Electric Switch, Relay, Power Button Switch, Critical Lights, Chassis Lamp, Fog Lamps, Door Switch, Led Switch or any Circuit Controls on over 500,000 Cycles
- High-Quality Metal Material & IP65 Waterproof Protection, can be used in Wet or Dusty Environments



**IS-EP-WB123RED** **NEW**

**LED ILLUMINATED PUSH BUTTON SWITCH**

- Mounting Diameter: 5/8 Inch
- Switch Rating: 3A/250AC
- Operation Type: Push it - ON, Push it again - OFF
- Power Symbol LED can be on all the time or only when the switch is on which depends on how you wire it
- Great for Electric Switch, Relay, Power Button Switch, Critical Lights, Chassis Lamp, Fog Lamps, Door Switch, Led Switch or any Circuit Controls on over 500,000 Cycles
- High-Quality Metal Material & IP65 Waterproof Protection, can be used in Wet or Dusty Environments



**IS-EP-WS123BLU** **NEW**

**LED ILLUMINATED PUSH BUTTON SWITCH**

- Mounting Diameter: 5/8 Inch
- Switch Rating: 3A/250AC
- Operation Type: Push it - ON, Push it again - OFF
- Ring LED can be on all the time or only when switch is on which depends on how you wire it
- Great for Electric Switch, Relay, Power Button Switch, Critical Lights, Chassis Lamp, Fog Lamps, Door Switch, Led Switch or any Circuit Controls on Over 500,000 Cycles
- High-Quality Metal Material & IP65 Waterproof Protection, can be Used in Wet or Dusty Environments



**IS-EP-WS123RED** **NEW**

**LED ILLUMINATED PUSH BUTTON SWITCH**

- Mounting Diameter: 5/8 Inch
- Switch Rating: 3A/250AC
- Operation Type: Push it - ON, Push it again - OFF
- Ring LED can be on all the time or only when switch is on which depends on how you wire it
- Great for Electric Switch, Relay, Power Button Switch, Critical Lights, Chassis Lamp, Fog Lamps, Door Switch, Led Switch or any Circuit Controls on Over 500,000 Cycles
- High-Quality Metal Material & IP65 Waterproof Protection, can be Used in Wet or Dusty Environments



**NB-803M-RED**  
**NB-803M-BLK**  
**NB-803M-BLU**  
**NB-803M-WHT**  
**NB-803M-YLW**



**MOMENTARY PUSH SWITCH**

- 20A 125V
- 15A 250V
- 3 Pins
- Mounting Diameter: 1/2 Inch

**THIS SWITCH CAN BE USED IN COUNTLESS APPLICATIONS, FROM BASIC ON-OFF TO MULTIFUNCTION APPLICATIONS. MOST OF OUR ELECTRICAL SWITCHES ARE SUITABLE FOR MARINE, INDUSTRIAL, OR AUTOMOTIVE APPLICATIONS.**

**ECR-12615**

**MOMENTARY "PUSH TO ACTIVATE" SWITCH**

- 3A 30V DC
- 6A 12V DC
- Contact R: 50mΩ max
- Insulation R: 500V DC 100MΩ min
- Mounting Diameter: 2-1/4 Inch



**FOR BOAT HORNS, STARTER SWITCHES, DOORBELLS AND OTHER APPLICATIONS IN WHICH TEMPORARY ACTIVATION OF AN ELECTRICAL CIRCUIT IS DESIRED. OPERATION TYPE: MOMENTARY (ACTIVATES WHEN PRESSED, DEACTIVATES WHEN RELEASED)**

**NB-804PA**

**MOMENTARY "PUSH TO ACTIVATE" SWITCH**

- 4A 125V AC
- 2A 250V AC
- Mounting Diameter: 3/4 Inch



**FOR BOAT HORNS, STARTER SWITCHES, AND OTHER APPLICATIONS IN WHICH TEMPORARY DISACTIVATION OF AN ELECTRICAL CURRENT IS DESIRED. OPERATION TYPE: MOMENTARY**

**NB-804PD**

**MOMENTARY "PUSH TO DISACTIVATE" SWITCH**

- 4A 125V AC
- 2A 250V AC
- Mounting Diameter: 3/4 Inch



**FOR BOAT HORNS, STARTER SWITCHES, AND OTHER APPLICATIONS IN WHICH TEMPORARY DISACTIVATION OF AN ELECTRICAL CURRENT IS DESIRED. OPERATION TYPE: MOMENTARY**

**NB-602PA**

**MOMENTARY "PUSH TO ACTIVATE" SWITCH**

- Current Rating: 3A 125V AC
- 2 Pins
- Mounting Diameter: 1/4 Inch



**NB-602PD**

**MOMENTARY "PUSH TO DEACTIVATE" SWITCH**

- Current Rating: 3A 125V AC
- 2 Pins
- Mounting Diameter: 1/4 Inch





**EC-4112S**

**SURFACE MOUNT MINI PUSH SWITCH**

- 0.1A, 12V
- Dimension: 12x12mm
- Height of the button: 0.25mm
- Total height: 4.25mm



**EC-4112D**

**THRU MOUNT MINI PUSH SWITCH**

- 0.1A, 12V
- Dimension: 12x12mm
- Height of the button: 0.25mm
- Total height: 4.25mm



**NB-802**

**MOMENTARY ON-OFF SPST MINI PUSH SWITCH**

- Square
- Current Rating: 3A 125V AC
- 2 Pins



**NB-805**

**MOMENTARY PUSH SWITCH**

- Current Rating: 3A 125V AC
- 2 Pins



POPULAR

BEST SELLER

**IS-EC-PB1216RED**

**MOMENTARY PUSH SWITCH WITH 40" LEAD WIRE**

- Current Rating: 16A, 12V
- Mount Hole: 1/4"
- 2 Pins



**IS-EC138-ALM**

**VALET SWITCH WITH 36" LEAD WIRE**

- Life: 100,000 Times
- 2 Cables/BLACK, GREY



**EQ-CON-12V**

**REPLACEMENT MOLEX TYPE POWER CONNECTOR**

- For EQ, Crossover and other audio processors



**EC-1210 BEST SELLER**

**SPST MINI ON-OFF ROCKER SWITCH**

- Mount Hole: 1/2" x 3/4"
- Current Rating: 10A 12V
- 2 Pins
- 3/4 x 1/2



**AR-110**

**SPDT ON-ON MINI SLIDE SWITCH**

- Current Rating: 3A 125V AC
- 3 Pins

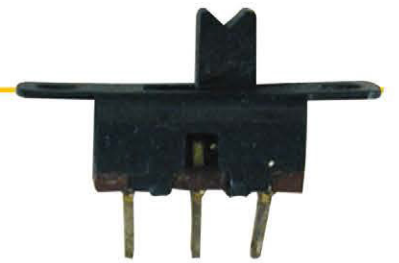

**AR-210**

**DPDT ON-ON MINI SLIDE SWITCH**

- Current Rating: 3A 125V AC
- 6 Pins

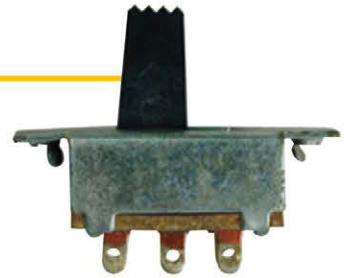

**EC-126 POPULAR**

**SPST ON-OFF TOGGLE SWITCH WITH 24" LEAD WIRE**

- Pre-Wired 2" Long
- Current Rating: 6A 125V
- 2 Pins



**VS-1122**

**SPDT VOLTAGE SWITCH**

- 3 Pins
- 110/220 V



**EC-284**

**SPDT ON-ON MICRO SWITCH**

- Current Rating: 10A 125V AC
- 2 Pins



**EC-285**

**SPDT ON-ON MICRO SWITCH**

- Current Rating: 3A 125V AC
- 3 Pins





**IS-LD-AVMS-12**

**DUAL AMP/VOLTAGE DISPLAY**

- Input 12-24V, 5A
- Blue LED Display
- Material: High Quality Nylon Plastic Socket Body
- Fitment: Universal Fits for 12-24V Vehicle, Motorcycle, ATV, Boat, Car or Marine



**IS-LD-DVS-12**

**DIGITAL VOLTAGE DISPLAY**

- Blue LED Display
- Material: High Quality Nylon Plastic Socket Body
- Fitment: Universal Fits for 12-24V Vehicle, Motorcycle, ATV, Boat, Car or Marine



**IS-LD-USBVS-12**

**DIGITAL VOLTAGE DISPLAY WITH USB FAST CHARGER**

- Blue LED Display
- Material: High Quality Nylon Plastic Socket Body
- Fitment: Universal Fits for 12-24V Vehicle, Motorcycle, ATV, Boat, Car or Marine



**IS-EC-12MT-BLU**

**SPST ROCKER SWITCH WITH BLUE LED ON INDICATOR AND SWITCH HOUSING**

- Easy Setup. All you Need is a 3/4" Hole and the Switch will Sit in Nicely
- Frames are Nylon, Terminals are Silver Plated Brass
- Illumination: DOT Styled, 12V LED Light
- Type: 3 Pins with LED SPST: ON-OFF
- Rating: 12V / DC, 20A
- LED Color: Blue
- Size: 37x29mm



**IS-EC-PRSM1-1**

**SINGLE CAR CHARGER OUTLET DASHBOARD MOUNT ADAPTER**

- Easily installed in any car, motorcycle, ATV, boat, riding mower, et
- Color: Black
- Material: ABS
- Fire retardant
- Size: 53x49x78mm
- Fits all of our voltage display models



**IS-EC-PRSM1-2**

**DOUBLE CAR CHARGER OUTLET DASHBOARD MOUNT ADAPTER**

- Easily installed in any car, motorcycle, ATV, boat, riding mower, etc.
- Color: Black
- Material: ABS
- Fire retardant
- Size: 96x49x78x71mm
- Fits all of our voltage display models



**IS-ALD-2UV-BLK**

**DIGITAL VOLTAGE DISPLAY WITH DUAL FAST USB CHARGER**

- Product (hole) Size: 37x49x28.8mm
- 36g
- 7075 Aluminum
- Input Voltage: 12-24V
- Output Voltage: 5V
- Blue LED display
- Body color: Black



**IS-ALD-2UV-BLU**

**DIGITAL VOLTAGE DISPLAY WITH DUAL FAST USB CHARGER**

- Product (hole) Size: 37x49x28.8mm
- 36g
- 7075 Aluminum
- Input Voltage: 12-24V
- Output Voltage: 5V
- Blue LED display
- Body color: Blue



**IS-ALD-2UB-BLK**

**DIGITAL VOLTAGE AND AMP DISPLAY WITH DUAL FAST USB CHARGER**

- Product(hole) Size: 37x49x28.8mm
- 32g
- 7075 Aluminum
- Input Voltage: 12-24V
- Output Voltage: 5V
- Output Current: 2.1A+2.1A
- Blue LED display
- Body color : Black

**DUAL USB CHARGER SOCKET HAS TWO FAST CHARGING PORTS. VERY USEFUL FOR CAR, BOAT, SUV, ATV, RV CAR, CAMPERS AND MOTORCYCLES, ETC. IT IS COMPATIBLE WITH MOST VEHICLES WITH A VOLTAGE OF DC 12-24V CONNECTIONS.**



**IS-ALD-UVA-BLK**

**DIGITAL VOLTAGE AND AMP DISPLAY WITH FAST USB CHARGER**

- Product(hole) Size: 37x49x28.8mm
- 27g
- 7075 Aluminum
- Input Voltage: 12-24V
- Output Voltage: 5V
- Blue LED display
- Body color: Black

**USB CHARGER SOCKET HAS A FAST CHARGING PORT, WHICH IS 4X FASTER THAN CONVENTIONAL CHARGERS AND AN LED VOLTAGE AND CURRENT DISPLAY THAT CAN SHOW THE VOLTAGE AND AMP STATUS OF CAR BATTERY IN REAL TIME. VERY USEFUL FOR CAR, BOAT, SUV, ATV, RV CAR, CAMPERS AND MOTORCYCLES, ETC. IT IS COMPATIBLE WITH MOST VEHICLES WITH A VOLTAGE OF DC 12-24V CONNECTIONS.**





# TERMINALS & CONNECTORS

**IS-PTRC-0-8**

**CRIMP TYPE**

**CRIMP TYPE COPPER RING TERMINAL LUG**

**0 GAUGE**  
**1/4" STUD**

- 0 Gauge
- Stud Size #1/4"
- Insulated - Pure Copper Allows Maximum Conductivity
- Black heat shrink included
- Heavy duty construction for enhanced high temperature durability.
- Perfect for cable ends that connect to the battery terminals or corresponding battery switch installation
- Widely used for car, vehicle, RV, boat, also solar panels, home applications, electrical equipment etc.



**IS-PTRC-0-10**

**CRIMP TYPE**

**CRIMP TYPE COPPER RING TERMINAL LUG**

**0 GAUGE**  
**5/16" STUD**

- 0 Gauge
- Stud Size #5/16"
- Insulated - Pure Copper Allows Maximum Conductivity
- Black heat shrink included
- Heavy duty construction for enhanced high temperature durability.
- Perfect for cable ends that connect to the battery terminals or corresponding battery switch installation
- Widely used for car, vehicle, RV, boat, also solar panels, home applications, electrical equipment etc.



**IS-PTRC-4-8**

**CRIMP TYPE**

**CRIMP TYPE COPPER RING TERMINAL LUG**

**4 GAUGE**  
**1/4" STUD**

- 4 Gauge
- Stud Size #1/4"
- Insulated - Pure Copper Allows Maximum Conductivity
- Black heat shrink included
- Heavy duty construction for enhanced high temperature durability.
- Perfect for cable ends that connect to the battery terminals or corresponding battery switch installation
- Widely used for car, vehicle, RV, boat, also solar panels, home applications, electrical equipment etc.



**IS-PTRC-4-10**

**CRIMP TYPE**

**CRIMP TYPE COPPER RING TERMINAL LUG**

**4 GAUGE**  
**5/16" STUD**

- 4 Gauge
- Stud Size #5/16"
- Insulated - Pure Copper Allows Maximum Conductivity
- Black heat shrink included
- Heavy duty construction for enhanced high temperature durability.
- Perfect for cable ends that connect to the battery terminals or corresponding battery switch installation
- Widely used for car, vehicle, RV, boat, also solar panels, home applications, electrical equipment etc.



**IS-PTRC-8-8**

**CRIMP TYPE**

**CRIMP TYPE COPPER RING TERMINAL LUG**

**8 GAUGE**  
**1/4" STUD**

- 8 Gauge
- Stud Size #1/4"
- Insulated - Pure Copper Allows Maximum Conductivity
- Black heat shrink included
- Heavy duty construction for enhanced high temperature durability.
- Perfect for cable ends that connect to the battery terminals or corresponding battery switch installation
- Widely used for car, vehicle, RV, boat, also solar panels, home applications, electrical equipment etc.





**IS-PTRCST-008** **SOLDER TYPE**

**SOLDER TYPE COPPER RING TERMINAL LUG**

- 0 Gauge
- Stud Size #1/4"
- Insulated - Pure Copper Allows Maximum Conductivity
- Black heat shrink included
- Heavy duty construction for enhanced high temperature durability.
- Perfect for cable ends that connect to the battery terminals or corresponding battery switch installation
- Widely used for car, vehicle, RV, boat, also solar panels, home applications, electrical equipment etc.

**0 GAUGE**  
**1/4" STUD**



**IS-PTRCST-010** **SOLDER TYPE**

**SOLDER TYPE COPPER RING TERMINAL LUG**

- 0 Gauge
- Stud Size #5/16"
- Insulated - Pure Copper Allows Maximum Conductivity
- Black heat shrink included
- Heavy duty construction for enhanced high temperature durability.
- Perfect for cable ends that connect to the battery terminals or corresponding battery switch installation
- Widely used for car, vehicle, RV, boat, also solar panels, home applications, electrical equipment etc.

**0 GAUGE**  
**5/16" STUD**



**IS-PTRCST-408** **SOLDER TYPE**

**SOLDER TYPE COPPER RING TERMINAL LUG**

- 4 Gauge
- Stud Size #1/4"
- Insulated - Pure Copper Allows Maximum Conductivity
- Black heat shrink included
- Heavy duty construction for enhanced high temperature durability.
- Perfect for cable ends that connect to the battery terminals or corresponding battery switch installation
- Widely used for car, vehicle, RV, boat, also solar panels, home applications, electrical equipment etc.

**4 GAUGE**  
**1/4" STUD**



**IS-PTRCST-410** **SOLDER TYPE**

**SOLDER TYPE COPPER RING TERMINAL LUG**

- 4 Gauge
- Stud Size #5/16"
- Insulated - Pure Copper Allows Maximum Conductivity
- Black heat shrink included
- Heavy duty construction for enhanced high temperature durability.
- Perfect for cable ends that connect to the battery terminals or corresponding battery switch installation
- Widely used for car, vehicle, RV, boat, also solar panels, home applications, electrical equipment etc.

**4 GAUGE**  
**5/16" STUD**



**IS-PTRCST-808** **SOLDER TYPE**

**SOLDER TYPE COPPER RING TERMINAL LUG**

- 8 Gauge
- Stud Size #1/4"
- Insulated - Pure Copper Allows Maximum Conductivity
- Black heat shrink included
- Heavy duty construction for enhanced high temperature durability.
- Perfect for cable ends that connect to the battery terminals or corresponding battery switch installation
- Widely used for car, vehicle, RV, boat, also solar panels, home applications, electrical equipment etc.

**8 GAUGE**  
**1/4" STUD**



**IS-RT-HDO-3/8** **SOLDER TYPE**

**SOLDER TYPE RING TERMINAL LUG**

- 0 Gauge
- Stud Size #3/8"
- Nickel plated copper
- Heavy duty construction for enhanced high temperature durability.
- Perfect for cable ends that connect to the battery terminals or corresponding battery switch installation
- Pack of 50

**0 GAUGE**  
**3/8" STUD**



**IS-RT-HD4-5/16** **SOLDER TYPE**

**SOLDER TYPE RING TERMINAL LUG**

- 4 Gauge
- Stud Size #5/16"
- Nickel plated copper
- Heavy duty construction for enhanced high temperature durability.
- Perfect for cable ends that connect to the battery terminals or corresponding battery switch installation
- Pack of 50

**4 GAUGE**  
**5/16" STUD**



**PBTR-0** **0AWG**

**0 AWG GOLD PLATED RING TERMINALS**

- 24 Kt. Gold Plated Terminals
- 1 Positive (Red) & 1 Negative (Black)
- Crimp Style
- PVC Insulator
- Blister Pack
- 0 AWG
- 3/8" Stud



**PBTR-4** **4AWG**

**4 AWG GOLD PLATED RING TERMINALS**

- 24 Kt. Gold Plated Terminals
- 2 Positive (Red) & 2 Negative (Black)
- Crimp Style
- PVC Insulator
- Blister Pack
- 4 AWG
- 3/8" Stud



**PBTR-8** **8AWG**

**8 AWG GOLD PLATED RING TERMINALS**

- 24 Kt. Gold Plated Terminals
- 4 Positive (Red) & 4 Negative (Black)
- Crimp Style
- PVC Insulator
- Blister Pack
- 8 AWG
- 3/8" Stud



**PBTR-10** **10AWG**

**10 AWG GOLD PLATED RING TERMINALS**

- 24 Kt. Gold Plated Terminals
- 8 Positive (Red) & 8 Negative (Black)
- Crimp Style
- PVC Insulator
- Blister Pack
- 10 AWG
- 3/8" Stud



**PTR-OT-RED** **0AWG**

**0 AWG GOLD PLATED RING TERMINALS**

- 0 AWG
- 1/2" Stud
- 24 Kt. Gold Plated Terminals
- Crimp Style
- Red PVC Insulator
- 50 Pieces per bag



**PTR-OT-BLK** **0AWG**

**0 AWG GOLD PLATED RING TERMINALS**

- 0 AWG
- 1/2" Stud
- 24 Kt. Gold Plated Terminals
- Crimp Style
- Black PVC Insulator
- 50 Pieces per bag





## RING TERMINALS

**PTR-0 RED**

**0AWG**

**PTR-0 BLK**

**0AWG**

**0 AWG RING TERMINAL - BULK PACK**

- 0 AWG
- 3/8" Stud
- Crimp Style
- PVC Insulator
- 50 Piece Bag



**0 AWG RING TERMINAL - BULK PACK**

- 0 AWG
- 3/8" Stud
- Crimp Style
- PVC Insulator
- 50 Piece Bag



**PTR-4 RED**

**4AWG**

**PTR-4 BLK**

**4AWG**

**4 AWG RING TERMINAL - BULK PACK**

- 4 AWG
- 3/8" Stud
- Crimp Style
- PVC Insulator
- 50 Piece Bag



**4 AWG RING TERMINAL - BULK PACK**

- 4 AWG
- 3/8" Stud
- Crimp Style
- PVC Insulator
- 50 Piece Bag



**PTR-6 RED**

**6AWG**

**PTR-6 BLK**

**6AWG**

**6 AWG RING TERMINAL - BULK PACK**

- 6 AWG
- 3/8" Stud
- Crimp Style
- PVC Insulator
- 50 Piece Bag



**6 AWG RING TERMINAL - BULK PACK**

- 6 AWG
- 3/8" Stud
- Crimp Style
- PVC Insulator
- 50 Piece Bag



**PTR-8 RED**

**8AWG**

**PTR-8 BLK**

**8AWG**

**8 AWG RING TERMINAL - BULK PACK**

- 8 AWG
- 3/8" Stud
- Crimp Style
- PVC Insulator
- 50 Piece Bag



**8 AWG RING TERMINAL - BULK PACK**

- 8 AWG
- 3/8" Stud
- Crimp Style
- PVC Insulator
- 50 Piece Bag



**PTR-10 RED**

**10AWG**

**PTR-10 BLK**

**10AWG**

**10 AWG RING TERMINAL - BULK PACK**

- 10 AWG
- 3/8" Stud
- Crimp Style
- PVC Insulator
- 50 Piece Bag



**10 AWG RING TERMINAL - BULK PACK**

- 10 AWG
- 3/8" Stud
- Crimp Style
- PVC Insulator
- 50 Piece Bag



## RING TERMINALS

**IS-RT-1210-10**

**VINYL INSULATED RING TERMINAL**

- 12 - 10 Gauge
- 1/8" Stud
- Vinyl Insulator
- Pack of 100



**12-10 GAUGE**

**IS-RT-1210-5/16**

**VINYL INSULATED RING TERMINAL**

- 12 - 10 Gauge
- 5/16" Stud
- Vinyl Insulator
- Pack of 100



**12-10 GAUGE**

**IS-RT-1210-3/8**

**VINYL INSULATED RING TERMINAL**

- 12 - 10 Gauge
- 3/8" Stud
- Vinyl Insulator
- Pack of 100



**12-10 GAUGE**

**IS-RT-1210-1/4**

**VINYL INSULATED RING TERMINAL**

- 12 - 10 Gauge
- 1/4" Stud
- Vinyl Insulator
- Pack of 100



**12-10 GAUGE**

**IS-RT-1614-10**

**VINYL INSULATED RING TERMINAL**

- 16 - 14 Gauge
- 1/8" Stud
- Vinyl Insulator
- Pack of 100



**16-14 GAUGE**

**IS-RT-1614-5/16**

**VINYL INSULATED RING TERMINAL**

- 16 - 14 Gauge
- 5/16" Stud
- Vinyl Insulator
- Pack of 100



**16-14 GAUGE**

**IS-RT-1614-3/8**

**VINYL INSULATED RING TERMINAL**

- 16 - 14 Gauge
- 3/8" Stud
- Vinyl Insulator
- Pack of 100



**16-14 GAUGE**

**IS-RT-1614-1/4**

**VINYL INSULATED RING TERMINAL**

- 16 - 14 Gauge
- 1/4" Stud
- Vinyl Insulator
- Pack of 100



**16-14 GAUGE**

**IS-RT-2218-10**

**VINYL INSULATED RING TERMINAL**

- 22 - 18 Gauge
- 1/8" Stud
- Vinyl Insulator
- Pack of 100



**22-18 GAUGE**

**IS-RT-2218-1/4**

**VINYL INSULATED RING TERMINAL**

- 22 - 18 Gauge
- 1/4" Stud
- Vinyl Insulator
- Pack of 100



**22-18 GAUGE**



**MRT-1210-8HS**

**MARINE HEAT SHRINK RING TERMINAL**

- 12-10 Gauge
- Yellow
- Translucent Vinyl Insulator
- Package of 100

**12-10 GAUGE**



**MRT-1614-6HS**

**MARINE HEAT SHRINK RING TERMINAL**

- 16-14 Gauge
- Blue
- Translucent Vinyl Insulator
- Package of 100

**16-14 GAUGE**



**MRT-2218-4HS**

**MARINE HEAT SHRINK RING TERMINAL**

- 22-18 Gauge
- Red
- Translucent Vinyl Insulator
- Package of 100

**22-18 GAUGE**



**MBT-1210-HS**

**MARINE HEAT SHRINK BUTT CONNECTOR**

- 12-10 Gauge
- Yellow
- Translucent Vinyl Insulator
- Package of 100

**12-10 GAUGE**



**MBT-1614-HS**

**MARINE HEAT SHRINK BUTT CONNECTOR**

- 16-14 Gauge
- Blue
- Translucent Vinyl Insulator
- Package of 100

**16-14 GAUGE**



**MBT-2218-HS**

**MARINE HEAT SHRINK BUTT CONNECTOR**

- 22-18 Gauge
- Red
- Translucent Vinyl Insulator
- Package of 100

**22-18 GAUGE**



**MQD-1210-250HS**

**MARINE HEAT SHRINK BUTT DISCONNECT CONNECTOR**

- 12-10 Gauge
- Yellow
- Translucent Vinyl Insulator
- Package of 100

**12-10 GAUGE**



**MQD-1614-250HS**

**MARINE HEAT SHRINK BUTT DISCONNECT CONNECTOR**

- 16-14 Gauge
- Blue
- Translucent Vinyl Insulator
- Package of 100

**16-14 GAUGE**



**MQD-2218-250HS**

**MARINE HEAT SHRINK BUTT DISCONNECT CONNECTOR**

- 22-18 Gauge
- Red
- Translucent Vinyl Insulator
- Package of 100

**22-18 GAUGE**



**IS-BT-1210**

**VINYL BUTT CONNECTOR**

- 12-10 Gauge
- Yellow
- Full Insulation
- Package of 100

**12-10 GAUGE**



**IS-BT-1614**

**VINYL BUTT CONNECTOR**

- 16-14 Gauge
- Blue
- Full Insulation
- Package of 100

**16-14 GAUGE**



**IS-BT-2218**

**VINYL BUTT CONNECTOR**

- 22-18 Gauge
- Red
- Translucent Vinyl Insulator
- Package of 100

**22-18 GAUGE**



**IS-BT-8**

**BUTT CONNECTOR**

- 8 Gauge
- Red
- Full Insulation
- Package of 100

**8 GAUGE**



**IS-BT-1614NL**

**NYLON BUTT CONNECTOR**

- 16-14 Gauge
- Blue
- Full Insulation
- Package of 100

**16-14 GAUGE**



**IS-BT-2218NL**

**NYLON BUTT CONNECTOR**

- 22-18 Gauge
- Red
- Full Insulation
- Package of 100

**22-18 GAUGE**



**IS-SP-1614-10**

**VINYL SPADE TERMINAL**

- 16-14 Gauge
- #10 Stud Size
- Red
- Full Insulation
- Package of 100



**16-14 GAUGE**

**IS-SP-2218-10**

**VINYL SPADE TERMINAL**

- 22-18 Gauge
- #10 Stud Size
- Red
- Full Insulation
- Package of 100



**22-18 GAUGE**

**IS-SP-2218-6**

**VINYL SPADE TERMINAL**

- 22-18 Gauge
- #6 Stud Size
- Red
- Full Insulation
- Package of 100



**22-18 GAUGE**

**IS-SP-1210-10**

**VINYL SPADE TERMINAL**

- 12-10 Gauge
- #12 Stud Size
- Yellow
- Full Insulation
- Package of 100



**12-10 GAUGE**



## SPADE TERMINALS

### PTS-14 BLK

#### SPADE TERMINAL

- 14 Gauge
- #8 Stud Size
- Black
- Full Insulation
- Package of 50



**14 GAUGE**

### PTS-14 RED

#### SPADE TERMINAL

- 14 Gauge
- #8 Stud Size
- Red
- Full Insulation
- Package of 50



**14 GAUGE**

### PTS-10 BLK

#### SPADE TERMINAL

- 10 Gauge
- #8 Stud Size
- Black
- Full Insulation
- Package of 50



**10 GAUGE**

### PTS-10 RED

#### SPADE TERMINAL

- 10 Gauge
- #8 Stud Size
- Red
- Full Insulation
- Package of 50



**10 GAUGE**

### PTS-8 BLK

#### SPADE TERMINAL

- 8 Gauge
- #8 Stud Size
- Black
- Full Insulation
- Package of 50



**8 GAUGE**

### PTS-8 RED

#### SPADE TERMINAL

- 8 Gauge
- #8 Stud Size
- Red
- Full Insulation
- Package of 50



**8 GAUGE**

### PTS-6 BLK

#### SPADE TERMINAL

- 6 Gauge
- #10 Stud Size
- Black
- Full Insulation
- Package of 50



**6 GAUGE**

### PTS-6 RED

#### SPADE TERMINAL

- 6 Gauge
- #10 Stud Size
- Red
- Full Insulation
- Package of 50



**6 GAUGE**

### PTS-4 BLK

#### SPADE TERMINAL

- 4 Gauge
- #10 Stud Size
- Black
- Full Insulation
- Package of 50



**4 GAUGE**

### PTS-4 RED

#### SPADE TERMINAL

- 4 Gauge
- #10 Stud Size
- Red
- Full Insulation
- Package of 50



**4 GAUGE**

## SPADE TERMINALS/FEMALE QUICK DISCONNECT

### PBTS-8 BLK

#### SPADE TERMINAL

- 8 Gauge
- #8 Stud Size
- Black
- Full Insulation
- Blister pack of 8



**8 GAUGE**

### PBTS-8 RED

#### SPADE TERMINAL

- 8 Gauge
- #8 Stud Size
- Red
- Full Insulation
- Blister pack of 8



**8 GAUGE**

### PBTS-4 BLK

#### SPADE TERMINAL

- 4 Gauge
- #10 Stud Size
- Black
- Full Insulation
- Blister pack of 4



**4 GAUGE**

### PBTS-4 RED

#### SPADE TERMINAL

- 4 Gauge
- #10 Stud Size
- Red
- Full Insulation
- Blister pack of 4



**4 GAUGE**

### PTD-18 BLK

#### FEMALE QUICK DISCONNECT TERMINAL

- 18 Gauge
- Black
- Full Insulation
- Package of 50



**18 GAUGE**

### PTD-18 RED

#### FEMALE QUICK DISCONNECT TERMINAL

- 18 Gauge
- Red
- Full Insulation
- Package of 50



**18 GAUGE**

### PTD-16 BLK

#### FEMALE QUICK DISCONNECT TERMINAL

- 16 Gauge
- Black
- Full Insulation
- Package of 50



**16 GAUGE**

### PTD-16 RED

#### FEMALE QUICK DISCONNECT TERMINAL

- 16 Gauge
- Red
- Full Insulation
- Package of 50



**16 GAUGE**

### PTD-10 BLK

#### FEMALE QUICK DISCONNECT TERMINAL

- 10 Gauge
- Black
- Full Insulation
- Package of 50



**10 GAUGE**

### PTD-10 RED

#### FEMALE QUICK DISCONNECT TERMINAL

- 10 Gauge
- Red
- Full Insulation
- Package of 50



**10 GAUGE**



**IS-QD-2216-110**

**FEMALE QUICK DISCONNECT TERMINAL**

- Pack of 100
- 22-16 Gauge
- Insulated: 110
- Red



**22-16 GAUGE**

**IS-QD-2216-187**

**FEMALE QUICK DISCONNECT TERMINAL**

- Pack of 100
- 22-16 Gauge
- Insulated: 187
- Red



**22-16 GAUGE**

**IS-QD-2216-250**

**FEMALE QUICK DISCONNECT TERMINAL**

- Pack of 100
- 22-16 Gauge
- Insulated: 250
- Red



**22-16 GAUGE**

**IS-QD-1614**

**FEMALE QUICK DISCONNECT TERMINAL**

- Pack of 100
- 22-18 Gauge
- Insulated: 187
- Blue



**22-18 GAUGE**

**IS-IQF-1614**

**FEMALE QUICK DISCONNECT TERMINAL**

- Pack of 100
- 16-14 Gauge
- Non-insulated Nylon
- Blue



**16-14 GAUGE**

**IS-IQF-1210**

**FEMALE QUICK DISCONNECT TERMINAL**

- Pack of 100
- 12-10 Gauge
- Non-insulated Nylon
- Yellow



**12-10 GAUGE**

**IS-IQF-2218NL**

**NYLON FEMALE QUICK DISCONNECT TERMINAL**

- 22-18 Gauge
- Pack of 100
- Fully Insulated .250
- Quick Disconnect
- Red

**22-18 GAUGE**



**IS-IQF-1614NL**

**NYLON FEMALE QUICK DISCONNECT TERMINAL**

- 16-14 Gauge
- Pack of 100
- Fully Insulated .250
- Quick Disconnect
- Blue

**16-14 GAUGE**



**IS-IQF-1210NL**

**NYLON FEMALE QUICK DISCONNECT TERMINAL**

- 12-10 Gauge
- Pack of 100
- Fully Insulated .250
- Quick Disconnect
- Yellow

**12-10 GAUGE**



**IS-IQM-2218NL**

**NYLON MALE FULLY INSULATED TAB CONNECTOR**

- 22-18 Gauge
- Pack of 100
- Fully Insulated .250
- Quick Disconnect
- Red

**22-18 GAUGE**



**IS-IQM-1614NL**

**NYLON MALE FULLY INSULATED TAB CONNECTOR**

- 16-14 Gauge
- Pack of 100
- Fully Insulated .250
- Quick Disconnect
- Blue

**16-14 GAUGE**



**IS-IQM-1210NL**

**NYLON MALE FULLY INSULATED TAB CONNECTOR**

- 12-10 Gauge
- Pack of 100
- Fully Insulated .250
- Quick Disconnect
- Yellow

**12-10 GAUGE**



**IS-TB-2218**

**MALE SPADE CRIMP CONNECTOR**

- Male crimp connectors suitable for 12-10AWG wires. The connectors feature vinyl insulation and form a reliable electrical connection.
- Color: Blue
- Size : 6.3mm x 0.8mm
- Material: Insulation: Vinyl, Terminal Body: Brass, Metallic Sleeve: Copper, Plating: Tin
- Pack of 100

**22-18 GAUGE**



**IS-TB-1614**

**MALE SPADE CRIMP CONNECTOR**

- Male crimp connectors suitable for 16-14AWG wires. The connectors feature vinyl insulation and form a reliable electrical connection.
- Color: Blue
- Size : 6.3mm x 0.8mm
- Material: Insulation: Vinyl, Terminal Body: Brass, Metallic Sleeve: Copper, Plating: Tin
- Pack of 100

**16-14 GAUGE**



**IS-TB-1210**

**MALE SPADE CRIMP CONNECTOR**

- Male crimp connectors suitable for 10-12AWG wires. The connectors feature vinyl insulation and form a reliable electrical connection.
- Color: Yellow
- Size : 6.3mm x 0.8mm
- Material: Insulation: Vinyl, Terminal Body: Brass, Metallic Sleeve: Copper, Plating: Tin
- Pack of 100

**12-10 GAUGE**



**MBLM-1614HS**

**MARINE HEAT SHRINK MALE BULLET CONNECTOR**

- 16-14 Gauge
- Color: Blue
- Translucent Vinyl Insulator
- Pack of 100

**16-14 GAUGE**



**IS-BLM-1614**

**VINYL MALE BULLET CONNECTOR**

- 16-14 Gauge
- Color: Blue
- Insulated
- Pack of 100

**16-14 GAUGE**



**IS-BLF-1614**

**VINYL FEMALE BULLET CONNECTOR**

- 16-14 Gauge
- Color: Blue
- Insulated: 156
- Pack of 100

**16-14 GAUGE**





**BMS-AM1**

**AMPLIFIER DRESS UP KIT**

- (1) Black Gold Ring Terminal
- (1) Red Gold Plated Spade Terminal
- (1) Black Gold Plated Spade Terminal
- (5) Red Gold Plated Speaker Terminals
- (4) Black Gold Plated Speaker Terminals
- (6) Assorted Cable Ties



**GRK-110**

**175 PIECE TERMINAL KIT**

- Solderless Terminals and Connectors Kit
- Includes: Spade Terminals, Ring Terminals, Male Push-On, Female Push-On, Bullet, Hook, Butt Connector



**IS-119-5G**

**RCA FEMALE-TO-FEMALE CONNECTOR - GOLD**

- 5 Red & 5 Black Pcs



**IS-120-5G**

**RCA MALE-TO-MALE CONNECTOR - GOLD**

- 5 Red & 5 Black Pcs



**MLX-8040**

**ANDERSON TYPE DC PLUG**

- 350 Amps
- 0-4 Gauge
- 2 Pole
- Each plug is a mirror of the other and are simple to assemble. There is no Male & Female. One simply connects into another of the same amperage. The plugs push together to form a very solid and reliable connection.



**IS-GRK-270**

**270 PCS ASSORTED WIRING TERMINAL AND CRIMP CONNECTOR KIT**

- Red/Blue/Yellow Butt Splice Connector
- Red/Blue/Yellow Insulated Spade terminal
- Red/Blue/Yellow Insulated Ring terminal
- Red/Blue Male Insulated Quick Disconnect Terminal
- Red/Blue Female Insulated Quick Disconnect Terminal



**IS-119-5SL**

**RCA FEMALE-TO-FEMALE CONNECTOR - SILVER**

- 5 Red & 5 Black Pcs



**IS-120-5SL**

**RCA MALE-TO-MALE CONNECTOR - SILVER**

- 5 Red & 5 Black Pcs



**IS-CC2214B**

**NYLON CRIMP CAP**

- 22-14 Gauge
- Long Barrel
- Black
- Pack of 100



**22-14 GAUGE**

**IS-CC2214N**

**NYLON CRIMP CAP**

- 22-14 Gauge
- Long Barrel
- White
- Pack of 100



**22-14 GAUGE**

**IS-CC1416**

**NYLON CRIMP CAP**

- 16-14 Gauge
- Long Barrel
- White
- Pack of 100



**16-14 GAUGE**

**IS-QS-2218**

**QUICK SPLICE ADAPTER**

- 22-18 Gauge
- Red
- Pack of 100



**22-18 GAUGE**

**IS-QS-1614**

**QUICK SPLICE ADAPTER**

- 16-14 Gauge
- Blue
- Pack of 100



**16-14 GAUGE**

**IS-QS-1210**

**QUICK SPLICE ADAPTER**

- 12-10 Gauge
- Yellow
- Pack of 100



**12-10 GAUGE**

**IS-TT-2218**

**T-TAP SPLICE CONNECTOR**

- 22-18 Gauge
- Red
- Pack of 100



**22-18 GAUGE**

**IS-TT-1614**

**T-TAP SPLICE CONNECTOR**

- 16-14 Gauge
- Blue
- Pack of 100



**16-14 GAUGE**

**IS-TT-1210**

**T-TAP SPLICE CONNECTOR**

- 12-10 Gauge
- Yellow
- Pack of 100



**12-10 GAUGE**

**CC-5 BLK**

**CABLE NAIL-IN CLIP**

- Secures coaxial cables to floors, baseboards or walls
- Corrosion and UV resistant clips
- For indoor or outdoor use
- Black
- Pack of 100



**CC-6 BLK**

**CABLE NAIL-IN CLIP**

- Secures coaxial cables to floors, baseboards or walls
- Corrosion and UV resistant clips
- For indoor or outdoor use
- Black
- Pack of 100





# FUSES & FUSE HOLDERS

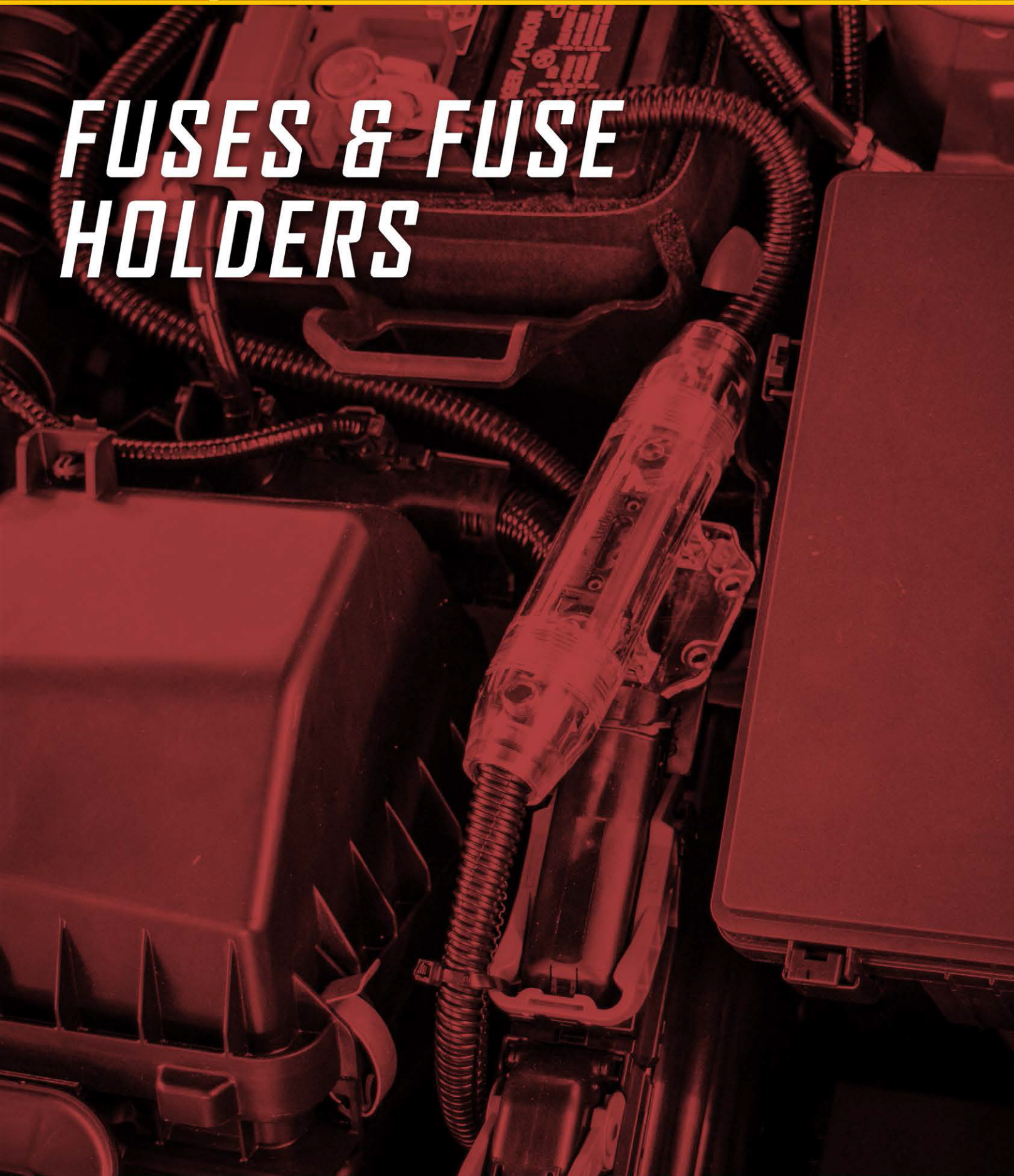

IS-ATO-3	(3 AMP)
IS-ATO-4	(4 AMP)
IS-ATO-5	(5 AMP)
IS-ATO-7.5	(7.5 AMP)
IS-ATO-10	(10 AMP)
IS-ATO-15	(15 AMP)
IS-ATO-20	(20 AMP)
IS-ATO-25	(25 AMP)
IS-ATO-30	(30 AMP)
IS-ATO-40	(40 AMP)



**BLADE TYPE TERMINAL CAR FUSE**

- 25 Pack
- Designed to fit regular AMP APM/ATM fuse holders
- High-temperature, impact-resistant plastic casings
- See-through windows allow for easy inspection
- Ultimate circuit protection and high conductivity plating
- Voltage Rating: 10 Volt - 32 Volt
- Fuse Dimension: 19.1 × 5.1 × 18.5 mm

**THESE TERMINAL CAR FUSES ARE SPECIFICALLY DESIGNED FOR CARS, TRUCKS, SUVs, ATVs, UTVs, CAMPER RV, MOTORCYCLES, FLEET, GOLF CAR, BOAT, SNOWMOBILES, AND MOST GENERAL DC APPLICATIONS ETC., COVERING SUCH COMPONENTS AS RADIO, LIGHT, TURN SIGNALS, ETC.**

ATM-LPM-10	(10 AMP)
ATM-LPM-15	(15 AMP)
ATM-LPM-20	(20 AMP)
ATM-LPM-25	(25 AMP)
ATM-LPM-30	(30 AMP)



**LOW PROFILE BLADE TYPE MINI FUSES**

- 25 Pack
- High-temperature, impact-resistant plastic casings
- See-through windows allow for easy inspection
- Ultimate circuit protection and high conductivity plating
- Voltage Rating: 10 Volt - 32 Volt
- Fuse Dimension: 10.9 × 3.6 × 16.3 mm

**TIN-PLATED ZINC TERMINALS FOR CORROSION RESISTANCE AND ENHANCED CONDUCTIVITY - A MUST HAVE ITEM TO PROTECT YOUR VEHICLES AND ELECTRICAL DEVICES FROM A SHORT CIRCUIT AND OVERLOAD - PACKED IN A MOLDED CASE TO PROTECT BLADE FUSES, AND FOR EASY TRANSPORT AND STORAGE.**

IS-ATM-LP-10	(10 AMP)
IS-ATM-LP-20	(20 AMP)



**LOW PROFILE BLADE TYPE MINI ATM FUSES**

- 25 Pack
- High-temperature, impact-resistant plastic casings
- See-through windows allow for easy inspection
- Ultimate circuit protection and high conductivity plating
- Nickel Plated Blade, Polycarbonate Housing
- Voltage Rating: 10 Volt - 32 Volt
- Fuse Dimension: 10.9 × 3.6 × 16.3 mm



## BLADE TYPE/ANL/AFC FUSES

IS-AST-3A	(3 AMP)
IS-AST-7.5A	(7.5 AMP)
IS-AST-10A	(10 AMP)
IS-AST-15A	(15 AMP)
IS-AST-20A	(20 AMP)
IS-AST-25A	(25 AMP)
IS-AST-30A	(30 AMP)



### MINI BLADE TYPE AST TERMINAL CAR FUSE

- 25 Pack
- High-temperature, impact-resistant plastic casings
- See-through windows allow for easy inspection
- Ultimate circuit protection and high conductivity plating
- Voltage Rating: 10 Volt - 32 Volt
- Fuse Dimension: 19.1 x 5.1 x 18.5 mm

ANL-60A	(60 AMP)
ANL-80A	(80 AMP)
ANL-100A	(100 AMP)
ANL-150A	(150 AMP)
ANL-175A	(175 AMP)
ANL-200A	(200 AMP)
ANL-225A	(225 AMP)
ANL-250A	(250 AMP)
ANL-300A	(300 AMP)

### ANL FUSES

- 2 Pack ANL Fuses
- Gold Plated
- ANL fuse will protect your controller, wire, and battery from overcurrent.
- Voltage Rating: no more than 32 Volts
- Easy Installation for Multiuse Combinations



AFC-30	(30 AMP)
AFC-40	(40 AMP)
AFC-50	(50 AMP)
AFC-60	(60 AMP)
AFC-80	(80 AMP)
AFC-120	(120 AMP)
AFC-150	(150 AMP)

### AFC FUSES

- 5 Pack AFC Fuses
- Nickel Plated
- Voltage 32 Volts
- These high-amp fuses are the best way to protect the investment you have in your sound system.



## AGU FUSES

AGU-40A	(40 AMP)
AGU-50A	(50 AMP)
AGU-60A	(60 AMP)
AGU-70A	(70 AMP)
AGU-80A	(80 AMP)
AGU-100A	(100 AMP)



### GOLD PLATED MIDGET CAR FUSE

- 5 Piece Blister Pack
- 10.3 x 38.10mm (13/32 x 1-1/2 inch)
- Voltage Rating: 32 V/125 V/250 V
- Replaces AGU and 4AG Fuses

FGMAC-1	(1 AMP)
FGMAC-2	(2 AMP)
FGMAC-3	(3 AMP)
FGMAC-4	(4 AMP)
FGMAC-6.3	(6.3 AMP)
FGMAC-8	(8 AMP)



### CERAMIC FUSE

- 10 Piece Blister Pack
- 6 x 30mm Ceramic Tube
- A type of low resistance resistor that acts as a sacrificial device to provide overcurrent protection, of either the load or source circuit. Widely used for electric equipment, home appliance, and so on.

FC-10A	(10 AMP)
FC-12A	(12 AMP)
FC-15A	(15 AMP)
FC-20A	(20 AMP)
FC-25A	(25 AMP)
FC-30A	(30 AMP)



### CERAMIC FUSE

- 10 Piece Blister Pack
- 5 x 20mm Ceramic Tube
- A type of low resistance resistor that acts as a sacrificial device to provide overcurrent protection, of either the load or source circuit. Widely used for electric equipment, home appliance, and so on.



<b>FM.25</b>	(.25 AMP)	<b>FM4</b>	(4 AMP)
<b>FM.5</b>	(.5 AMP)	<b>FM5</b>	(5 AMP)
<b>FM1</b>	(1 AMP)	<b>FM6</b>	(6 AMP)
<b>FM1.5</b>	(1.5 AMP)	<b>FM6.3</b>	(6.3 AMP)
<b>FM2</b>	(2 AMP)	<b>FM7</b>	(7 AMP)
<b>FM2.5</b>	(2.5 AMP)	<b>FM8</b>	(8 AMP)
<b>FM3</b>	(3 AMP)	<b>FM9</b>	(9 AMP)
<b>FM3.15</b>	(3.15 AMP)	<b>FM10</b>	(10 AMP)
<b>FM3.5</b>	(3.5 AMP)	<b>FM15</b>	(15 AMP)



**MINI GLASS FUSES**

- 100 Pieces per pack
- A type of low resistance resistor that acts as a sacrificial device to provide overcurrent protection, of either the load or source circuit. Widely used for electric equipment, home appliance, and so on.
- Voltage Rating: 250V
- Fuse Dimension: 5 x 20mm glass tube

<b>FN.5</b>	(.5 AMP)	<b>FM5</b>	(5 AMP)
<b>FN1</b>	(1 AMP)	<b>FM6</b>	(6 AMP)
<b>FM1.5</b>	(1.5 AMP)	<b>FM7</b>	(7 AMP)
<b>FM2</b>	(2 AMP)	<b>FM10</b>	(10 AMP)
<b>FM2.5</b>	(2.5 AMP)	<b>FM15</b>	(15 AMP)
<b>FM3</b>	(3 AMP)	<b>FM20</b>	(20 AMP)
<b>FM3.5</b>	(3.5 AMP)	<b>FM25</b>	(25 AMP)
<b>FM4</b>	(4 AMP)	<b>FM30</b>	(30 AMP)



**GLASS FUSES**

- 100 Pieces per pack
- A type of low resistance resistor that acts as a sacrificial device to provide overcurrent protection, of either the load or source circuit. Widely used for electric equipment, home appliance, and so on.
- Glass tube construction
- Fast acting - non-time delay
- Voltage Rating: 250V
- Fuse Dimension: 6 x 30mm glass tube

**HD-013**

**IN-LINE FUSE HOLDER FOR CAR STEREO**

- Standard 1-1/4" fuseholder
- Overall length 2-1/4" with 18 gauge wires



**FS-1  
FS-2**

**SCREW CAP CHASSIS MOUNT FUSE HOLDER**

- Maximum Voltage: AC 250V
- Maximum Rated Current: 10A
- Suitable For Fuse Size:  
5mm x 20mm (FS-1)  
6mm x 30mm (FS-2)
- Cap: Screw type



**IS-ANL-2310 BEST SELLER**

**HEAVY DUTY ANL FUSE HOLDER**

- Clear Housing with Mounting Base
- All Metal Parts are 24kt Gold finish
- Includes a 150A ANE (ANL) fuse
- Accepts 0 to 4 Gauge Cable Wire
- Perfect Contact for Power Cable
- Set Screw Design
- No Crimping required
- Water Resistant



**IS-N2C POPULAR**

**IN-LINE AGU FUSE HOLDER**

- Clear Housing with Mounting Base
- 24Kt Finish Fuse Holder
- Perfect Fit for 8 or 4 Gauge Power Cable
- Accepts AGU fuse up to 80 Amps
- Connect Base is Precision Machined
- Water Resistant



**CQ-ADCTC-16**

**ATC FUSE HOLDER**

- 10 Pcs per bag



**CQ-ADCTC-16**

**ATM FUSE HOLDER**

- 10 Pcs per bag



**IS-ANLF-9310 POPULAR**

**IN-LINE ANL FUSE HOLDER**

- Clear Housing with Mounting Base
- 24Kt Finish Fuse Holder
- Includes 1pc 100A fuse
- Accepts 0 to 4 Gauge Cable Wire
- 1 FT (0.3M) 0Ga Red Power Cable
- Connect Base is Precision Machined
- Water Resistant



**IS-FBG-4328**

**2 POSITION AGU FUSE HOLDER**

- 24Kt Finish Fuse Holder
- One 2 Gauge or two 4GA Input and two 8 Gauge Outputs
- Inner Steps Ensure perfect recessed fits Cable into Block
- Base is Precision machined
- Includes two 60A fuses



**IS-1020**

**POWER DISTRIBUTION BLOCK**

- One 0GA or 2GA Input, Two 4GA & Two 8GA Output
- Platinum Finish









**IS-FWS-66**

**FLUSH WIRE CUTTER/STRIPPER**

- Body: 50# steel, HRC42-50, PVC handle
- Wire stripping range: 10 - 20AWG / 0.8-2.6mm
- Multifunctional: This tool can be used as wire stripper also works as a wire cutter
- This flush-cut wire stripper/cutter is durable, and easy to use with its ergonomic grip handle that reduces hand fatigue.
- Length: 6-3/4"



**IS-ST1022**

**3-IN-1 WIRE STRIPPER, CRIMPER, AND CUTTER TOOL**

- Cut and strip 10-22 AWG solid and stranded wire.
- Crimp 10-22AWG insulated and non-insulated terminals.
- Comfortable soft grip handle.
- Crimp coaxial connectors.
- Shear and thread common size electrical screws.
- Hole in the side of jaw for looping solid wire.
- Use pliers nose to tighten or loosen small nuts.
- Length: 8-1/4"



**IS-IST-166A**

**DUAL WIRE STRIPPER/CUTTER FOR SOLID WIRE**

- Body: 50# steel, HRC42-50, Mango TPR
- Wire stripping range: 10-20AWG / 0.8 - 2.6mm
- Multifunctional: This tool can be used as wire stripper also works as a wire cutter
- This dual wire stripper/cutter is durable, and easy to use with its ergonomic grip handle that reduces hand fatigue. Strips two wires with one single motion and is perfect for professional or home use and can be used to cut many different materials.
- Length: 6-1/2"



**IST-106A**

**SELF-ADJUSTING INSULATION WIRE STRIPPER/CUTTER**

- Cuts 0 AWG Copper and Aluminum cable
- Dropped-forged, high carbon steel construction
- Wire stripping range: 20 - 10AWG
- Length: 6-1/8"

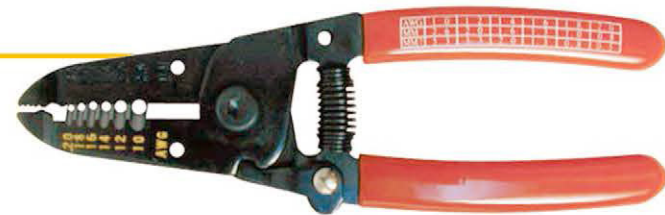

**IS-NTK-400**

**SELF-ADJUSTING INSULATION WIRE STRIPPER WITH CUTTER AND CRIMPER**

- Zinc alloy head, Cr12MoV, HRC52-60°, PP & TPR handle, GS
- Wire stripping range: 24 - 10AWG / 0.2 - 6mm
- Non-insulated terminal: 12 - 10AWG / 4 - 6mm
- Non-insulated terminal: 16 - 14 AWG / 1.5 - 2.5mm
- Non-insulated terminal: 22 - 18 AWG / 0.5 - 1mm
- The jaws clamp down and automatically selects the right tension to the wire avoiding damage to the strands
- Adjustable arm can be preset to a given size so it continuously strips equally amongst multiple cables
- Length: 8"



**IS-NTK-370**

**SELF-ADJUSTING INSULATION WIRE STRIPPER WITH CUTTER AND CRIMPER**

- Zinc alloy head, Cr12MoV, HRC52-60°, PVC handle
- Wire stripping range: 24-10AWG / 0.2 - 6mm
- Insulation terminal: 22-10AWG / 0.5 - 6mm
- Non-insulated terminal: 12-10AWG / 4-6mm
- Non-insulated terminal: 22-14AWG / 0.5-2.5mm
- Ignition terminal: 7-8mm
- Stripping force adjustment knob can adjust pressure accordingly as to not damage wire strands. The jaws clamp down and automatically selects the right tension
- Length: 8-1/4"



**IS-KIT-130**

**INSULATED 3-IN-1 WIRE STRIPPER, CUTTER, AND CRIMPER**

- 50 Pcs assorted wiring terminals & connectors kit
- Length: 8"

**INCLUDES THE FOLLOWING:**

- RV1-4S (Red): Insulated copper ring terminals 22 - 16AWG x 5 pcs
- RV2-4S (Blue): Insulated copper ring terminals 16 - 14AWG x 5 pcs
- SV1-4S (Red): Insulated copper spade terminals 22 - 16AWG x 5 pcs
- SV2-4S (Blue): Insulated copper spade terminals 16 - 14AWG x 5 pcs
- 2-250 (Red): Male insulated quick disconnectors 16 - 14AWG x 5 pcs
- 2-250 (Blue): Male insulated quick disconnectors 16 - 14AWG x 5 pcs
- 2-250 (Red): Female insulated quick disconnectors 16 - 14AWG x 5 pcs
- 2-250 (Blue): Female insulated quick disconnectors 16 - 14AWG x 5 pcs
- BV1 (Red): Butt splice connectors x 5 pcs
- BV2 (Blue): Butt splice connectors x 5 pcs





**NTK-59**

**CRIMPING TOOL FOR RG-58/59**

- Designed for RG6/58/59 connectors. Allows easy connection of any connector with crimp style pin and sleeve
- This crimping tool is used for crimping network cables. Designed for professional use with cable television, home-theater, and security systems
- Steel construction with grips for comfort and accuracy
- Easy to use
- Length: 8-1/4"

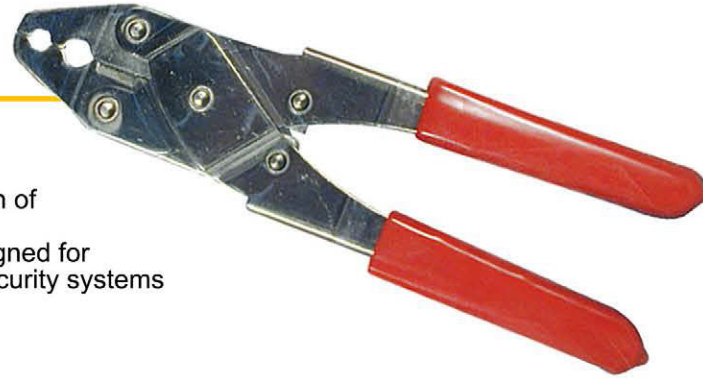

**NTK-56CMP**

**WATERPROOF COMPRESSION CRIMPING TOOL**

- Profession Waterproof Connectors Crimping Tool
- The use of high-quality steel production, Exquisite workmanship, strong and durable
- Crimp range, Professional suppression RG59, 58, 6 coaxial cable F, BNC, RCA connector to ensure the quality of the suppression while showing a beautiful appearance
- Quality blade, blade sharp and easy to cut, High-quality wear-resistant blade, long life, to ensure that the cut out of the port formation, no glitches
- Convenient latch design, Save time and effort, easy to suppress, incorporating simple
- The use of high-quality plastic handle, Professional ergonomic concept, so you feel more comfortable when used
- Length: 8-3/4"

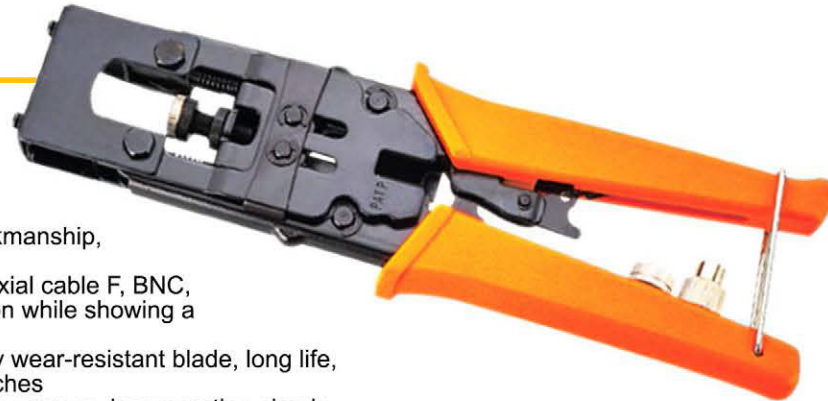

**NTK-56LCM**

**L-SHAPED COMPRESSION CRIMPING TOOL**

- The use of high-quality steel production, Exquisite workmanship, strong and durable
- Crimp range, Professional suppression RG59, 58, 6 coaxial cable F, BNC, RCA connector to ensure the quality of the suppression while showing a beautiful appearance
- Quality blade, blade sharp and easy to cut, High-quality wear-resistant blade, long life, to ensure that the cut out of the port formation, no glitches
- Length: 7-3/4"



**TTK-725**

**COMPRESSION CRIMPING TOOL**

- Professional waterproof connectors crimping tool with adjustments for crimping different lengths of "F", "BNC", and "RCA" connectors.
- Length: 5-1/2"



**KR-219S**

**MODULAR CRIMPING TOOL FOR 4P/6P/8P**

- For crimping Ethernet modular plugs 8P8C/RJ45, 6P6C/RJ-12, 6P4C/RJ-11, 4P4C and 4P2C
- Easy and efficient cutting and stripping wire with one operation
- Round cable stripper
- Lightweight, durable and compact
- Material: Middle carbon steel
- Length: 8"



**TTK-69**

**ECONOMY NETWORK LAN CABLE CRIMPER**

- 15.4" 6 to 1/0 AWG heavy duty HEX LUG / Terminal Crimper
- Length: 15.4"
- Weight: 2.9 Lbs
- Capacity: 6-50mm<sup>2</sup>
- Range of application: BS standard type terminals
- Length: 8"



**TTK-061**

**WIRE STRIPPING TOOL**

- Stripper for wire diameter 3 - 6.2mm
- Top end 110/88
- Dimensions: 90mm x 29mm x 5.4mm



**GHT-323**

**UNIVERSAL STRIPPING TOOL**

- Use on coaxial cable RG58, RG59, and RG6
- For round cable, stranded wire
- Multi-conductor cable & irregular out shape cable
- Stripping Length: This stripper can strip cable in four lengths 4, 6, 8, and 12mm. The stripping length is preset to 6mm. If you want to strip other lengths, you just need to adjust the blade's position.
- Blade's Depth: You may use the hex wrench, which is installed on the bottom of the tool to adjust the blades' depth.
- Dimensions: 98.5mm x 33.5mm x 20.7mm



**GHT-325**

**UNIVERSAL COAXIAL WIRE STRIPPING TOOL**

- Use on coaxial cable RG59, RG6, RG7 and RG11 round networking cable and telephone cable.
- Block is reversible, one side is available for RG59 and RG6, the other side is for RG7/11.
- Dimensions: 123mm x 71mm x 23.5mm





**TTK-756**

**COAX COMPRESSION CRIMPING TOOL**

- Adjustable compression tool with comfortable grip
- For use on RG59 RG6 RG11 cable F-Connector
- The tool is made of high hardness and precision material, which is light and easy to carry, durable and has a long service life;
- The handle is made of special soft rubber material, which is non-slip, comfortable to use and strong in hand feeling;
- Designed with the principle of leverage, saving effort and making the crimping press to the end;
- Length: 6-3/4"



**TTK-3756**

**PROFESSIONAL COMPRESSION TOOL**

- Adjustable compression tool with comfortable grip
- For use on RG59, RG6, RG11, BNC, and RG11 cable F-Connector
- The tool is made of high hardness and precision material, which is light and easy to carry, durable and has a long service life;
- The handle is made of special soft rubber material, which is non-slip, comfortable to use and strong in hand feeling;
- Designed with the principle of leverage, saving effort and making the crimping press to the end;
- Length: 6-3/4"



**TTK-021**

**IMPACT PUNCH TOOL**

- Uses 110 Blade
- Adjustable Impact Wheel
- For termination of telephone and high-speed network data cables
- Insert and cut cable terminations effortlessly
- Impact-absorbing cushioned grip reduces operator stress for high volume installers
- Storage compartment with unique locking device provides convenient storage for spare blades
- Durable Punch Tool, makes network installation all that easy



**TTK-021-RB57**

**REPLACEMENT BLADES FOR TTK-021**

- Replacement Blades for an Impact Punch Down Tool
- The Blade for Punch Down Tools is Durable and made to Last
- Easy and Simple Installation
- Fits all Standard Punch Down and Impact Tools
- Perfect for Everyday use, as a Spare, or Replacement
- Includes two replacement blades



**IHPM-307**

**METRIC FOLDING HEX KEY SET**

- 7 Piece folding hex key set
- 1.5mm, 2mm, 2.5mm, 3mm, 4mm, 5mm, 6mm Sizes



**IHPS-307**

**STANDARD FOLDING HEX KEY SET**

- 7 Piece folding hex key set
- 1/16", 5/64", 3/32", 1/8", 5/32", 3/16", 7/32" Sizes



**PJ-06**

**6 PIECE PRECISION SCREWDRIVER SET**

- Screwdriver Set featuring 6 different sized heads
- Includes Phillips #1 and #0 along with Flat-head 1.4mm, 2.0mm, 2.4mm, and 3.0mm
- Set includes convenient carry case



**PJ-11**

**11 PIECE PRECISION SCREWDRIVER SET**

- Screwdriver Set featuring 6 different sized heads
- Includes Phillips #1 and #0 along with Flat-head 1.4mm, 2.0mm, 2.4mm, and 3.0mm
- Set includes convenient carry case





**IUPH-700**

**7 PIECE UPHOLSTERY REMOVAL TOOL KIT**

- Easily and safely to remove radio panel, trim, molding, door panels, and dashboards.
- Great for automotive snap on trim panel and molding removal.
- Reduce the concave and protruding scars left by using screw knife or other non-efficient tools.
- High quality rugged design that made of durable plastic.
- Work on interior and exterior trim, wide edge remover, handle remover or upholstery clip remover.



**IS-PK-14**

**4 PIECE MINI PICK AND HOOK TOOL KIT**

- Material: 45# carbon steel and PP handle
- Straight hook x1
- 90 degree hook x1
- Full hook x1
- Offset 45 hook x1
- Ideal for use on car keys, O-rings, snap rings and washers



**IS-WW3848**

**4 FOOT WIRE FEEDER**

- 3/8" X 4'
- Specialized tool to assist routing wires under the dash cavity, under carpeting, above headliners or through the vehicle's firewall.
- Made of Nylon that is rigid enough to follow a line, yet flexible enough to turn corners without collapsing.
- Will not scratch or cut your vehicle's interior or wiring



**GSD-140**

**11 PIECE 105 DEGREE ANGLE DRIVER BIT SET**

- Gears are mounted in a die-cast with 3 durable ball bearings
- Strong built-in magnetic socket holds standard hex drilling and drive bits; prevents falling
- 105-degree designs for tight spaces
- Hex bit holder socket extends the power of a cordless screwdriver
- Handy tool for hard-to-reach areas
- This screwdriver bit holder can connect a hand drill and manual wrench
- Includes 7 drill bits



**IS-IUB-016**

**HSS TIN STEP DRILL BIT**

- Drill Size: 3/16"-1/2"
- Perfect for cutting through multiple sheets of soft metals, plastic, veneer and thin steel.
- Titanium nitride (Tin) coating lengthens tool life by conducting heat away from the cutting edge.
- Self-starting punch-style tip.
- Drill faster with less effort.
- Sturdy HSS construction.



**3/16" - 1/2" DRILL SIZE**

**IS-IUB-018**

**HSS TIN STEP DRILL BIT**

- Drill Size: 1/8"-1/2"
- Perfect for cutting through multiple sheets of soft metals, plastic, veneer and thin steel.
- Titanium nitride (Tin) coating lengthens tool life by conducting heat away from the cutting edge.
- Self-starting punch-style tip.
- Drill faster with less effort.
- Sturdy HSS construction.



**1/8" - 1/2" DRILL SIZE**

**IS-IUB-020**

**HSS TIN STEP DRILL BIT**

- Drill Size: 1/4"-3/4"
- Perfect for cutting through multiple sheets of soft metals, plastic, veneer and thin steel.
- Titanium nitride (Tin) coating lengthens tool life by conducting heat away from the cutting edge.
- Self-starting punch-style tip.
- Drill faster with less effort.
- Sturdy HSS construction.



**1/4" - 3/4" DRILL SIZE**

**IS-KEY9**

**9 PIECE OEM RADIO REMOVAL KEY KIT**

- Includes 9 different pairs of key
- Storage bag conveniently stores the keys
- Kit includes 18 specially designed tools and keys that are a must for removing stereos and cd players flawlessly.
- Never attempt to remove a car audio system with everyday tools, auto manufacturers use special tools to prevent stereo theft. Without these special tools, damage can occur to the head unit or surrounding area of the dashboard.
- Engineered with durable stainless steel construction to prevent cracking, stripping and undue wear and tear.



**TNT-BAG**

**TOOL BELT**

- 1" Web belt with quick release buckle for easy fit
- Front pocket easily fits most tapes
- Designed for tool storage
- 12 pockets
- Made of durable material





# FASTENERS, SEALERS, & ADHESIVES



<b>HTSK-0200-RL100</b>	(02-00 GAUGE)
<b>HTSK-0400-RL100</b>	(04-00 GAUGE)
<b>HTSK-1612-RL100</b>	(16-22 GAUGE)
<b>HTSK-2018-RL100</b>	(20-18 GAUGE)
<b>HTSK-2422-RL100</b>	(24-22 GAUGE)
<b>HTSK-2826-RL100</b>	(28-26 GAUGE)



**POLYOLEFIN HEAT SHRINK TUBING - 100 FOOT ROLL**

- 2:1 Shrink Ratio
- Flame Retardant, VW-1
- Shrink Temp: 70°C (158°F)
- Operating Temp: -55°C thru 125°C (-67°F thru 257°F)

THIS THIN WALL, HEAT SHRINK TUBING IS MADE FROM A SPECIALLY FORMULATED, CROSS-LINKED POLYOLEFIN. THIS TOUGH, FLEXIBLE, FLAME RETARDANT TUBING CAN BE USED FOR ELECTRICAL INSULATION, WIRE BUNDLING, COLOR CODING, LIGHTWEIGHT HARNESSING, WIRE STRAIN RELIEF, AND WIRE IDENTIFICATION PURPOSES IN A VARIETY OF HOME, COMMERCIAL, INDUSTRIAL AND MILITARY APPLICATIONS. 2:1 HEAT SHRINK TUBING SLIDES EASILY OVER SMALL INLINE SPLICES AND CONNECTORS, AND SHRINK DOWN TO 50% OF ITS ORIGINAL DIAMETER TO FIT SNUGLY OVER ANY WIRE, HOSE OR CABLE MANAGEMENT PROJECT.

<b>HTSK-0200</b>	(02-00 GAUGE)
<b>HTSK-0400</b>	(04-00 GAUGE)
<b>HTSK-1612</b>	(16-22 GAUGE)
<b>HTSK-2018</b>	(20-18 GAUGE)
<b>HTSK-2422</b>	(24-22 GAUGE)
<b>HTSK-2826</b>	(28-26 GAUGE)



**POLYOLEFIN HEAT SHRINK TUBING - 8 PIECES**

- 2:1 Shrink Ratio
- Flame Retardant, VW-1
- Shrink Temp: 70°C (158°F)
- Operating Temp: -55°C thru 125°C (-67°F thru 257°F)
- Tube Length: 6"

**HTSK-100CL**

**POLYOLEFIN HEAT SHRINK TUBING VALUE PACK**

- 2:1 Shrink Ratio
- Flame Retardant, VW-1
- Shrink Temp: 70°C (158°F)
- Operating Temp: -55°C thru 125°C (-67°F thru 257°F)
- 02-00 Gauge (White): 4 Quantity
- 04-00 Gauge (Blue): 6 Quantity
- 16-12 Gauge (Green): 10 Quantity
- 20-18 Gauge (Red): 20 Quantity
- 24-22 Gauge (Yellow): 30 Quantity
- 28-26 Gauge (Black): 30 Quantity
- Tube Length: 6"





## CABLE LOOMS



<b>LM-14-100 BLK</b>	<b>1/4" DIAMETER</b>	<b>100 FEET</b>
<b>LM-38-100 BLK</b>	<b>3/8" DIAMETER</b>	<b>100 FEET</b>
<b>LM-1-20 BLK</b>	<b>1/2" DIAMETER</b>	<b>20 FEET</b>
<b>LM-12-100 BLK</b>	<b>1/2" DIAMETER</b>	<b>100 FEET</b>
<b>LM-34-100 BLK</b>	<b>3/4" DIAMETER</b>	<b>100 FEET</b>
<b>LM-1-100 BLK</b>	<b>1" DIAMETER</b>	<b>100 FEET</b>
<b>LM-115-100 BLK</b>	<b>1 1/2" DIAMETER</b>	<b>100 FEET</b>

### BLACK POLYETHYLENE SPLIT LOOM TUBING

- Color: Black
- Material: High quality Polyethylene
- Split design flexible ribbed tube design for clean and easy install
- Used to protect electrical wiring in automotive, marine, hydraulic, home office and other applications
- Resistant to abrasions, gasoline, oil, and other harmful chemicals



<b>SBL-12-50-BLK</b>	<b>1/2" DIAMETER</b>	<b>50 FEET</b>
<b>SBL-34-50-BLK</b>	<b>3/4" DIAMETER</b>	<b>50 FEET</b>
<b>SBL-1-50-BLK</b>	<b>1" DIAMETER</b>	<b>50 FEET</b>

### SELF-WRAPPING BRAIDED SPLIT LOOM

- Length: 50 Feet
- Color: Black
- Material: Semi rigid braided construction
- The wire sleeve is made with a flexible split design and easy to load wires. A perfect choice for cable management
- Once loaded, our cable sleeve will close on itself and perfectly wrap cables
- Protects and prolongs the life of wires. Economical and easy to install

## CABLE SLEEVES

**IS-BR6M-100BLK**  
**IS-BR6M-100BLU**  
**IS-BR6M-100RD**



### EXPANDABLE BRAIDED CABLE SLEEVE

- Diameter: 1/4"
- Length: 100 Feet
- Material: PET
- Diameter expands up to 150%
- Cable sleeving protects and prolongs the life of wires
- Operating temp (degree F): 103 - 257
- Melt temp (degree F): 446



**1/4"**  
**DIAMETER**

**IS-BR10M-100BLK**  
**IS-BR10M-100BLU**  
**IS-BR10M-100RD**



### EXPANDABLE BRAIDED CABLE SLEEVE

- Diameter: 3/8"
- Length: 100 Feet
- Material: PET
- Diameter expands up to 150%
- Cable sleeving protects and prolongs the life of wires
- Operating temp (degree F): 103 - 257
- Melt temp (degree F): 446



**3/8"**  
**DIAMETER**

**IS-BR19M-100BLK**  
**IS-BR19M-100BLU**  
**IS-BR19M-100RD**  
**IS-BR19M-100GR**



### EXPANDABLE BRAIDED CABLE SLEEVE

- Diameter: 3/4"
- Length: 100 Feet
- Material: PET
- Diameter expands up to 150%
- Cable sleeving protects and prolongs the life of wires
- Operating temp (degree F): 103 - 257
- Melt temp (degree F): 446



**3/4"**  
**DIAMETER**





## CABLE TIES

<b>IS-CT-4</b>	<b>4"</b>	<b>18 LBS</b>
<b>IS-CT-6</b>	<b>6"</b>	<b>18 LBS</b>
<b>IS-CT-8</b>	<b>8"</b>	<b>40 LBS</b>
<b>IS-CT-10</b>	<b>10"</b>	<b>40 LBS</b>
<b>IS-CT-12</b>	<b>12"</b>	<b>50 LBS</b>
<b>IS-CT-14</b>	<b>14"</b>	<b>50 LBS</b>
<b>IS-CT-16</b>	<b>16"</b>	<b>50 LBS</b>
<b>IS-CT-18</b>	<b>18"</b>	<b>50 LBS</b>



### WHITE NYLON CABLE TIES

- Color: White
- 5mm Width
- Material: Nylon
- Self-locking
- High tensile strength and a high degree of flexibility
- Wide use, perfect for home, office, garage, garden, or whenever you need sort out your different wires, zippers and other accessories
- 100 Piece bag

<b>US-CT-4BUV</b>	<b>4"</b>	<b>18 LBS</b>
<b>US-CT-6BUV</b>	<b>6"</b>	<b>18 LBS</b>
<b>US-CT-7BUV</b>	<b>7"</b>	<b>40 LBS</b>
<b>US-CT-8BUV</b>	<b>8"</b>	<b>50 LBS</b>
<b>US-CT-11BUV</b>	<b>11"</b>	<b>50 LBS</b>
<b>US-CT-14BUV</b>	<b>14"</b>	<b>50 LBS</b>



### BLACK UV RESISTANT NYLON CABLE TIES

**NEW**

- Color: Black
- Material: UV Stabilized Nylon 6-6 Material
- Operating Temperature Range -40°F to +185°F
- High Resistance To Sun & Outdoor Exposure
- Self Locking Design, Saves Hands From Abrasion
- High tensile strength and a high degree of flexibility
- Wide use, perfect for home, office, garage, garden, or whenever you need sort out your different wires, zippers and other accessories
- 100 Piece bag



### US-CTR-8BUV **NEW**

### BLACK UV RESISTANT CABLE TIES WITH MOUNTING RING

- Length: 8"
- Tensile Strength: 40 lbs
- Color: Black
- 5mm Width
- Material: UV Stabilized Nylon 6-6 Material
- High Resistance To Sun & Outdoor Exposure
- Self Locking Design, Saves Hands From Abrasion
- Wide range of uses, good for keeping all kinds of cords cables well organized and tidy in place
- 100 Piece bag



## CABLE TIES/SCREWS

<b>IS-CT-518RU</b>	<b>5-3/4"</b>
<b>IS-CT-718RU</b>	<b>7"</b>

### REUSABLE NYLON ZIP TIES

- Color: Black
- Self locking design, saves hands from abrasion
- High tensile strength and a high degree of flexibility
- Beads lock and release through keyhole slots allowing for multiple uses
- 100 Piece bag



### IS-VLR6BLK

### ADJUSTABLE VELCRO CABLE TIE

- Length: 6"
- Color: Black
- Reusable, durable, flexible fabric material
- Detachable design is convenient to use
- High tensile strength and a high degree of flexibility
- Great for computer, appliance, and electronics wire management
- 10 Piece bag



<b>NST-012B</b>	<b>1/2"</b>
<b>NST-034B</b>	<b>3/4"</b>

### #8 SELF-TAP TRUSS HEAD SCREW

- 1000 Piece bag
- Color: Black



<b>NSCP-012</b>	<b>1/2"</b>
<b>NSCP-01</b>	<b>1"</b>

### #8 MEDIUM THREAD PAN HEAD SCREW

- 100 Piece bag
- Color: Black



<b>NSCW-012</b>	<b>1/2"</b>
<b>NSCW-01</b>	<b>1"</b>

### #8 DEEP THREAD WAFER HEAD SCREW

- 1000 Piece bag
- Color: Black



### NSCO-014

### #8 MEDIUM COUNTERSINK HEAD SCREW

- Length: 1/2"
- 100 Piece bag
- Color: Black





**GG-833F**

**MINI HOT GLUE GUN**

- 10 Watts
- 110V, 60Hz
- Built-in safety features such as an insulated nozzle and a fuse for peace of mind while the stand makes it easy to work with and stand up on your table when not in use.
- Great for all DIY, arts/crafts, home projects, home repair, Electronics, Dioramas, Models, Toy Repair, Wood Bonding and more
- Uses 1/4" diameter glue stick



**GG-839F**

**HOT GLUE GUN**

- 80 Watts
- 120V, 60Hz
- Built-in safety features such as an insulated nozzle and a fuse for peace of mind while the stand makes it easy to work with and stand up on your table when not in use.
- Great for all DIY, arts/crafts, home projects, home repair, Electronics, Dioramas, Models, Toy Repair, Wood Bonding and more
- Uses 1/2" diameter glue stick



**GS-675**

**HOT GLUE STICKS**

- For GG-833F glue gun
- 135 Pieces
- Diameter: 1/4"
- Length: 4"



**GS-610**

**HOT GLUE STICKS**

- For GG-839F glue gun
- 48 Pieces
- Diameter: 1/2"
- Length: 4"



**GS-720BL**

**HOT GLUE STICKS**

- For GG-833F glue gun
- 6 Pieces
- Diameter: 1/4"
- Length: 4"



**GS-1120BL**

**HOT GLUE STICKS**

- For GG-839F glue gun
- 6 Pieces
- Diameter: 1/2"
- Length: 4"



**GS-1051-10**

**NEW**

**10" HOT GLUE STICKS**

- For GG-839F glue gun
- 10 Pieces
- Diameter: 1/2"
- Length: 10"



**GS-1110BLK**

**10" HOT GLUE STICKS**

- 10 Pieces
- Diameter: 1/2"
- Length: 10"
- Black Color



**SA-8012**

**FOAM & FABRIC SPRAY ADHESIVE**

- Wide Web Spray Pattern
- Temporary or Permanent Bonds
- No CFC's or Ozone Depleters
- No Chlorinated Solvents
- Professional and Industrial Use
- 12 Oz (340 grams)



**IS-SPGT-25G**

**EPOXY ADHESIVE (BLACK)**

- 3-5 minute handling time
- 8-10 minute set time
- 1 hour cure time
- Net volume: 0.85 Fl. Oz. (25ml)
- A two part, black color, rapid curing general purpose epoxy. Better on more rigid materials. Useful in repairing metals, wood, plastic, tile, ceramic, fiberglass, PVC, concrete and more. May also be used as a metal filler and to restore rotten wood. You can add color pigment to epoxy after thoroughly mixing.



**IS-EPXY-20G**

**EPOXY ADHESIVE (BLACK)**

- 3-5 minute handling time
- 8-10 minute set time
- 1 hour cure time
- Volume: 0.35 Oz (10g) - Hardener  
0.35 Oz (10g) - Resin  
0.70 Oz (20g) - Total
- Epoxy adhesive quickly bonds and repairs metals, wood, plastic, tile, ceramic, fiberglass, PVC, concrete and more!



**TGP-450-20G**

**THERMAL GREASE (WHITE)**

- 2.15w/m-k 20g
- Quick cooling
- Non-toxic, environmental protection
- Good heat dissipation
- Stable performance
- High temperature resistance
- Thermal grease, also called thermal paste or thermal compound, is a substance used to promote better heat conduction between two surfaces and is commonly used between a microprocessor and a heatsink.



**TGPH-550-20G**

**THERMAL GREASE (GREY)**

- 2.7w/m-k 20g tube packing with OEM label
- Quick cooling
- Non-toxic, environmental protection
- Good heat dissipation
- Stable performance
- High temperature resistance
- Thermal grease, also called thermal paste or thermal compound, is a substance used to promote better heat conduction between two surfaces and is commonly used between a microprocessor and a heatsink.





## ELECTRICAL TAPE

ET-12	(BLUE)	
ET-13	(RED)	
ET-14	(GREEN)	
ET-15	(YELLOW)	
ET-16	(BROWN)	
ET-17	(GREY)	
ET-18	(WHITE)	
ET-19	(ORANGE)	



### 7 MIL VINYL ELECTRICAL TAPE

- 3/4" x 60 Feet
- Rugged construction premium quality vinyl 7 mil thickness provides superior adhesion while insulating and protecting
- Resistant to sun, oil, acids, alkalis, and corrosive chemicals
- Suitable for use at no more than 600 volts as primary insulation and not more than 80°C (176°F); UL and CSA listed for consumer confidence adding peace of mind to safety and quality concerns

### ET-5

### 7 MIL VINYL ELECTRICAL TAPE

- 3/4" x 12 Feet
- Resistant to sun, oil, acids, alkalis, and corrosive chemicals
- Suitable for use at no more than 600 volts as primary insulation and not more than 80°C (176°F); UL and CSA listed for consumer confidence adding peace of mind to safety and quality concerns
- Black



### ET-11

### 7 MIL VINYL ELECTRICAL TAPE

- 3/4" x 60 Feet
- Rugged construction premium quality vinyl 7 mil thickness provides superior adhesion while insulating and protecting
- Resistant to sun, oil, acids, alkalis, and corrosive chemicals
- Suitable for use at no more than 600 volts as primary insulation and not more than 80°C (176°F); UL and CSA listed for consumer confidence adding peace of mind to safety and quality concerns



### ET-20 MULTI



### 7 MIL VINYL ELECTRICAL TAPE

- 3/4" x 60 Feet
- Rugged construction premium quality vinyl 7 mil thickness provides superior adhesion while insulating and protecting
- Resistant to sun, oil, acids, alkalis, and corrosive chemicals
- Suitable for use at no more than 600 volts as primary insulation and not more than 80°C (176°F); UL and CSA listed for consumer confidence adding peace of mind to safety and quality concerns



## DOUBLE SIDED TAPE/HOOK AND LOOP

### ET-1060-DST

#### 1" DOUBLE SIDED FOAM TAPE

- 1" x 60"
- Works on many surfaces including metal, glass and plastic
- Holds up to 5 lbs. One inch holds a quarter pound four inches hold one pound
- Weather resistant and highly conformable
- Great for indoor and outdoor use



### ET-1260-DST

#### 1/2" DOUBLE SIDED FOAM TAPE

- 1/2" x 60"
- Works on many surfaces including metal, glass and plastic
- Holds up to 5 lbs. One inch holds a quarter pound four inches hold one pound
- Weather resistant and highly conformable
- Great for indoor and outdoor use



### ET-0834-DSF

#### 3/4" x 8' WEATHER STRIPPING TAPE

- Ideal for home, auto, marine and various other applications
- Self-adhesive, waterproof and stops vibrations
- 0.75" Wide x 8' Long (19 x 2400mm)



### IS-FAST1

#### 1" HOOK AND LOOP FASTENING SYSTEM

- Nylon hooks mesh with pliable loops for fast, secure closure.
- Maximum convenience - just press to close and peel to open.
- Adhesive backing adheres instantly to many surfaces
- Black color
- Self adhering
- 1" wide



### IS-FAST2

#### 2" HOOK AND LOOP FASTENING SYSTEM

- Nylon hooks mesh with pliable loops for fast, secure closure.
- Maximum convenience - just press to close and peel to open.
- Adhesive backing adheres instantly to many surfaces
- Black color
- Self adhering
- 2" wide





# INSTALLATION HARDWARE & ACCESSORIES



## TNT-SQ35MAH

### 5" PRO HANDLE SQUEEGE

- Removes over 95 percent of standing water
- With non-slip comfortable embowed grip handle
- Ergonomic soft edge handle with medical grade silicone blade will not scratch
- 5 inch flexible silicone blade
- Perfect for windows, mirrors, and large flat surfaces



## TNT-SQ35SF

### 3.75" SILICONE BLADE SQUEEGEE

- Removes over 95 percent of standing water
- Durable hard plastic handle with medical grade silicone blade will not scratch
- 3.75 inch flexible silicone blade
- Perfect for windows, mirrors, and large flat surfaces



## TNT-SQ35H

### 5.5" SILICONE BLADE SQUEEGEE

- Removes over 95 percent of standing water
- Durable hard plastic handle with medical grade silicone blade will not scratch
- 3.5 inch flexible silicone blade
- Perfect for windows, mirrors, and large flat surfaces



## TNT-SQ55

### 5.5" SILICONE BLADE SQUEEGEE

- Removes over 95 percent of standing water
- Durable hard plastic handle with medical grade silicone blade will not scratch
- 5.5 inch flexible silicone blade
- Perfect for windows, mirrors, and large flat surfaces

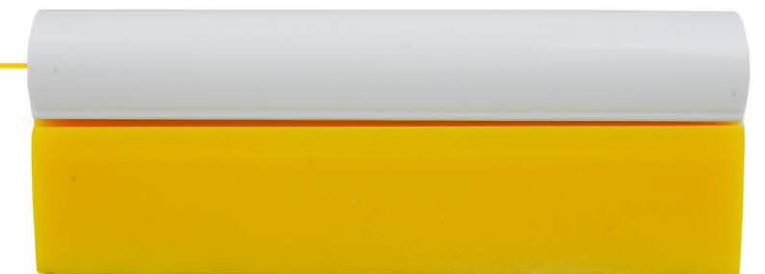



**TNT-SQ29M**

**HARD MINI SQUEEGEE**

- The TNT-SQ29M is used by window film installers, tinters, to get the water out of tight spots
- It's a tough & hard little squeegee, hard card. It's a must have tool for any tinter
- Great for scraping and installation/removal of vinyl wraps
- Endless uses: Smooth Caulking and Putty, Auto Detailing, Signs & Scrapbooks
- Great for lifting photo pieces off the cutting mat instead of using your finger nail



**THIS IS THE BEST VINYL FILM INSTALLATION TOOL EVER! THEY ARE RAZOR THIN ALONG THE EDGES, ALLOWING YOU TO SAFELY LIFT, SCRAPE AND REMOVE VINYL FILM WITHOUT SCRATCHING A VARIETY OF SURFACES. USED BY: AUTO DETAILERS, PAINTERS, SIGN SHOPS, WAREHOUSES, BODY SHOPS, SCRAP-BOOKERS AND MORE**

**TNT-SQ11M**

**HARD CREDIT CARD SQUEEGEE**

- Blue Color
- This vinyl squeegee tool can be widely used as window tint squeegee, window tint scraper, car wrap squeegee, vinyl sticker & decal applicator, window film install kit
- This window tinting squeegee is a tough & hard little squeegee, hard card. It is perfect for all vinyl applications and will not scratch during installation
- Endless uses: Smooth Caulking and Putty, Auto Detailing, Signs & Scrapbooks Great for lifting photo pieces off the cutting mat instead of using your finger nail
- Used by: Auto detailers, painters, sign shops, warehouses, body shops, scrap-bookers and MORE

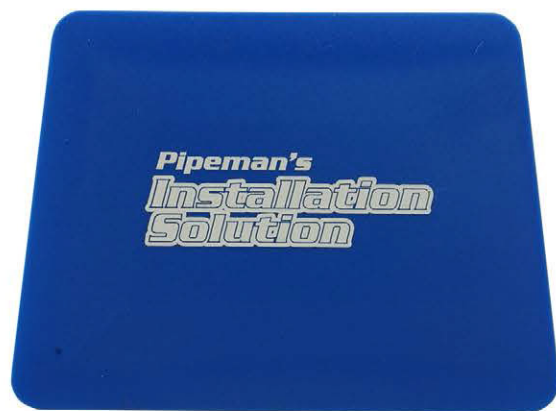

**TNT-SQ22S**

**PRO AUTO APPLICATION TOOL**

- The squeegee has a rubber edge designed to remove application fluid and clean prior to application
- Three in one squeegee that aides in installation of precut and tint film rolls.
- Soft Squeegee Blade Along 1 Edge & Point Hard-card Tips On the Ends
- This is an installation tool recommended for DIY installers to achieve professional results.



**GTD-1200**

**NEW**

**HEAT GUN**

- Power: 750/1500W
- Voltage: 110V AC
- Frequency: 60 Hz
- Perfect for applying window tint film, stripping paint, varnish, thawing metal pipes, drying paint plaster, heating shrink tubing, shaping, and bonding plastic and pipe connections
- Lightweight and compact design for ease of use and handling



**TNT-SPP42**

**42 OZ PRESSURIZED WATER PUMP SPRAYER**

- Multi-funktional compression sprayer for indoor and outdoor use. This sturdy sprayer is suitable for lawn and garden. Additional applications include car cleaning and maintenance. This product is suitable for spraying water up to 131°F
- Adjustable brass nozzle, ergonomic locking handle and pressure release valve
- Use for plant, flower, garden and lawn care, auto wheels, windows and exterior body



**TNT-SC10**

**HEAVY DUTY SCRAPER**

- Contour design for comfort ability
- Brass carrier with three positions for multi purpose use
- Safe scrapping stop for safety
- Rust resistant
- Effectively removes stickers, adhesives, labels and glue from cars, metal and plastic surfaces, tile, mirror glass shop windows and other hard surfaces
- Convenient Removal Tool to use as paint scraper and decal remover



**TNT-SC10010-SB**  
100 PIECE REPLACEMENT  
BLADES AVAILABLE  
SEPARATELY



**TNT-KN09**

**AUTO LOCK UTILITY KNIFE**

- Sleek, light weight stainless steel handle
- Slide lock for convenient one hand operation
- 9mm wide blade
- Safety auto lock feature
- With built-in blade snapper and pocket clip
- Designed for right and left handed use
- This stylish slim knife is ideal for free hand precision trimming jobs such as vinyl sign cutting. Great tool for manually debarring edges for a clean finish. Rust resistant, high grade stainless steel holder will extend the life of your snap off blade knife even in damp conditions



**TNT-KN1210-SB**  
10 PIECE REPLACEMENT  
BLADES AVAILABLE  
SEPARATELY



# CHEMICAL PRODUCTS



## 402A-285G

### CHEMICAL DUSTER FOR ELECTRONICS

- 10 Oz. super duster
- Removes microscopic dust, lint and foreign particles
- Cleans computers and keyboards, photographic and audio-video equipment, coin counters, printers timing devices, cash machines, optical equipment, fax machines and other electro mechanical instruments
- High rate of flow delivery systems for increased performance
- ROHS compliant



## 409B-140G

### ZERO RESIDUE ELECTROSOLVE CONTACT CLEANER

- MG Chemical's MGC-409B Electrosolve Contact Cleaner is a powerful and effective cleaning tool that rapidly penetrates and dissolves many types of soil. This is the perfect cleaner when zero residue contact is required for clear connections. This product is flammable and so caution must be used.
- Easy to use, degreases quickly, removes grease, tar, adhesives and fluxes
- Enhances equipment performance by removing contaminants
- Great for cleaning connectors, contacts, LED's, PCB's, circuit breakers, tuners and microprocessors
- The variable rate of speed valve allows the user to control the amount of spray used



## 824-450G

NEW

### ISOPROPYL ALCOHOL AEROSOL ELECTRONICS CLEANER

- An economical safe on plastics electronics cleaner and flux remover, it is safe on plastics, has a moderate evaporation rate, and is non-corrosive.
- Dissolves light oils and residues on electronic devices and equipment
- Zero residue
- Food safe – Registered with NSF for use in and around food processing establishments
- Perfect for cleaning de-energized electronics components and equipment, connectors and contacts, printed circuit boards, switches and relays, semi-conductors, magnetic heads, laser lenses in optical drives and office medical equipment
- Removes greases, oils, inks, rosin flux residues, and organic contaminants



## 824-500ML

NEW

### ISOPROPYL ALCOHOL LIQUID SPRAY ELECTRONICS CLEANER

- An economical safe on plastics electronics cleaner and flux remover, it is safe on plastics, has a moderate evaporation rate, and is non-corrosive.
- Dissolves light oils and residues on electronic devices and equipment
- Zero residue
- Food safe – Registered with NSF for use in and around food processing establishments
- Perfect for cleaning de-energized electronics components and equipment, connectors and contacts, printed circuit boards, switches and relays, semi-conductors, magnetic heads, laser lenses in optical drives and office medical equipment
- Removes greases, oils, inks, rosin flux residues, and organic contaminants





# FABRICS & CLOTHS



**CPT-150 GRY**  
**CPT-150 BLK**  
**CPT-150 BLU**  
**CPT-150 PL (PLATNUM)**  
**CPT-150 RED**



**TRUNK & SPEAKER BOX LINER**

- 4 x 150 foot roll
- Good sound insulation material for low frequency and high frequency sound and can effectively inhibit the propagation of various vibrations
- Used as sound insulation material in cars, theaters, concert halls, museums, exhibition halls, library, interrogation room, gallery, auction hall, gymnasium, lecture hall, multipurpose hall, hotel lobby, conference room, studio, recording room, KTV rooms, bars, industrial plants, room, and in the home



**CPT-450 GRY**  
**CPT-450 BLK**  
**CPT-450 PL (PLATNUM)**



**TRUNK & SPEAKER BOX LINER**

- 4 x 15 foot roll
- Good sound insulation material for low frequency and high frequency sound and can effectively inhibit the propagation of various vibrations
- Used as sound insulation material in cars, theaters, concert halls, museums, exhibition halls, library, gallery, auction hall, gymnasium, lecture hall, multipurpose hall, hotel lobby, conference room, studio, recording room, KTV rooms, bars, industrial plants, room, and in the home



**CPT-650 GRY**  
**CPT-650 BLK**  
**CPT-650 PL (PLATNUM)**



**TRUNK & SPEAKER BOX LINER**

- 6 x 150 foot roll
- Good sound insulation material for low frequency and high frequency sound and can effectively inhibit the propagation of various vibrations
- Used as sound insulation material in cars, theaters, concert halls, museums, exhibition halls, library, interrogation room, gallery, auction hall, gymnasium, lecture hall, multipurpose hall, hotel lobby, conference room, studio, recording room, KTV rooms, bars, industrial plants, room, and in the home



**CPT-FLE 145**

**FLEECE BACKING FOR FIBERGLASS**

- 4 x 15 Feet
- Blue



**GCF-6036 BLK**  
**GCF-6036 TAN**  
**GCF-6036 WIN**



**SPEAKER GRILL CLOTH**

- 3 x 5 Feet
- Open weave grill cloth is virtually 100% acoustically transparent. Will not muffle or color sound





## ENCLOSURES

**BVE-112C****SINGLE 12" VENTED ENCLOSURE**

- Dark Grey MDF Carpeting Material
- Face MDF Thickness: 3/4"
- Overall MDF Thickness: 5/8"
- Speaker Mounting Depth: 15-1/2"
- Speaker Hole Diameter: 11"
- Tuning Frequency: 41 Hz
- Gross Cubic FT per side: 2 ft<sup>3</sup>
- Vent Dimensions (LxWxH): 2" x 14" x 13-1/4"
- Dimensions (LxWxH): 18" x 16" x 13-1/4"

**BVHD-112C****SINGLE 12" VENTED HEAVY DUTY ENCLOSURE**

- Dark Grey MDF Carpeting Material
- Face MDF Thickness: 3/4"
- Overall MDF Thickness: 5/8"
- Speaker Mounting Depth: 12"
- Speaker Hole Diameter: 11"
- Tuning Frequency: 41 Hz
- Gross Cubic FT per side: 2 ft<sup>3</sup>
- Vent Dimensions (LxWxH): 2-1/4" x 12-3/4" x 13-1/4"
- Dimensions (LxWxH): 18" x 16" x 13-1/4"





**BVE-210C**

**NEW**

**DUAL 10" VENTED ENCLOSURE**

- Dark Grey MDF Carpeting Material
- Face MDF Thickness: 3/4"
- Overall MDF Thickness: 5/8"
- Speaker Mounting Depth: 14-11/16"
- Speaker Hole Diameter: 9-1/8"
- Tuning Frequency: 41 Hz
- Gross Cubic FT per side: 1.2 ft<sup>3</sup>
- Vent Dimensions (LxWxH): 2.5" x 11-1/4" x 11-3/4"
- Dimensions (LxWxH): 29-3/4" x 15 x 11-3/4"



**BVE-212C**

**NEW**

**DUAL 12" VENTED ENCLOSURE**

- Dark Grey MDF Carpeting Material
- Face MDF Thickness: 3/4"
- Overall MDF Thickness: 5/8"
- Speaker Mounting Depth: 15-15/16"
- Speaker Hole Diameter: 11-1/32"
- Tuning Frequency: 41 Hz
- Gross Cubic FT per side: 1.4 ft<sup>3</sup>
- Vent Dimensions (LxWxH): 2.5" x 13-1/2" x 13-1/2"
- Dimensions (LxWxH): 30-1/8" x 17-3/8" x 13-5/8"



**BVE-215C**

**NEW**

**DUAL 15" VENTED ENCLOSURE**

- Dark Grey MDF Carpeting Material
- Face MDF Thickness: 3/4"
- Overall MDF Thickness: 5/8"
- Speaker Mounting Depth: 16-15/16"
- Speaker Hole Diameter: 13-15/16"
- Tuning Frequency: 41 Hz
- Gross Cubic FT per side: 1.5 ft<sup>3</sup>
- Vent Dimensions (LxWxH): 2.5" x 11-1/4" x 11-3/4"
- Dimensions (LxWxH): 35-3/8" x 16-3/8" x 15-7/8"



**BVHD-210C**

**NEW**

**HEAVY DUTY DUAL 10" "L" VENTED ENCLOSURE WITH 1" FACE**

- Dark Grey MDF Carpeting Material
- Face MDF Thickness: 1"
- Overall MDF Thickness: 3/4"
- Speaker Mounting Depth: 13-5/8"
- Speaker Hole Diameter: 9-1/8"
- Tuning Frequency: 42 Hz
- Gross Cubic FT per side: 1.3 ft<sup>3</sup>
- Vent Dimensions (LxWxH): 2.5" x 10-3/8" x 11-7/8"
- Dimensions (LxWxH): 31-7/8" x 14-1/8" x 11-3/4"



**BVHD-212C**

**NEW**

**HEAVY DUTY DUAL 12" "L" VENTED ENCLOSURE WITH 1" FACE**

- Dark Grey MDF Carpeting Material
- Face MDF Thickness: 1"
- Overall MDF Thickness: 3/4"
- Speaker Mounting Depth: 15-5/8"
- Speaker Hole Diameter: 11-1/32"
- Tuning Frequency: 42 Hz
- Gross Cubic FT per side: 1.5 ft<sup>3</sup>
- Vent Dimensions (LxWxH): 3" x 11-7/8" x 13-1/16"
- Dimensions (LxWxH): 35-7/8" x 16-1/8" x 13-1/8"



**BVHD-215C**

**NEW**

**HEAVY DUTY DUAL 15" "L" VENTED ENCLOSURE WITH 1" FACE**

- Dark Grey MDF Carpeting Material
- Face MDF Thickness: 1"
- Overall MDF Thickness: 3/4"
- Speaker Mounting Depth: 17-1/2"
- Speaker Hole Diameter: 13-15/16"
- Tuning Frequency: 42 Hz
- Gross Cubic FT per side: 1.75 ft<sup>3</sup>
- Vent Dimensions (LxWxH): 2.5" x 11-1/4" x 11-3/4"
- Dimensions (LxWxH): 37-7/8" x 17-7/8" x 16-1/8"





# INDEX

617	75	CC-5 BLK	118	EPS-3018RD	91	FT560	39	IS-ATO-20	120	IS-EC-WP1216BLU	95	IS-PTRCST-408	107	KD-40	10	NB-423	23	P-750	10
618	75	CC-6 BLK	118	EQ-CON-12V	101	FT825-34	39	IS-ATO-25	120	IS-EC-WP1216GRN	95	IS-PTRCST-410	107	KD-50	10	NB-437	23	P-791	10
621	75	CMP-10012	46	ESCW-MOU-END	97	FT930-65	40	IS-ATO-3	120	IS-EC-WP1216RED	95	IS-PTRCST-808	107	KD-55	9	NB-440 BLK	43	P-795	10
30ARF	75	CMP-15015-B	46	ESCW-MOU-MID	97	GCF-6036 BLK	152	IS-ATO-30	120	IS-EP-WB123BLU	99	IS-QD-1614	115	KD-70	9	NB-440 RED	43	PBTR-0	108
402A-285G	150	CPT-150 BLK	152	ESCW-MOU-SIN	97	GCF-6036 TAN	152	IS-ATO-4	120	IS-EP-WB123RED	99	IS-QD-2216	115	KD-85	10	NB-550 BLK	43	PBTR-10	108
40-601LB	12	CPT-150 BLU	152	ESCW-RSOF-BLK	97	GCF-6036 WIN	152	IS-ATO-40	120	IS-EP-WB123BLU	99	IS-QD-2216-110	115	KD-KTB-3040	9	NB-550 RED	43	PBTR-4	108
40-60PEN	12	CPT-150 GRY	152	ESCW-RSOF-RED	97	GG-833F	141	IS-ATO-5	120	IS-EP-WS123RED	99	IS-QD-2216-187	115	KD-KTB-60	9	NB-602PA	100	PBTR-8	108
409B-140G	150	CPT-150 PL	152	ESCW-RSPF-BLU	97	GG-839F	141	IS-ATO-7.5	120	IS-EPXY-20G	142	IS-QS-1210	118	KR-219S	130	NB-602PD	100	PBTS-4BLK	114
40AMP	75	CPT-150 RED	152	ET-0834-DSF	144	GHT-323	130	IS-BLF-1614	117	IS-EXP105N	74	IS-QS-1614	118	KTB-30W	7	NB-660 BLK	43	PBTS-4RED	114
40ARM	75	CPT-450 BLK	152	ET-1060-DST	144	GHT-325	130	IS-BLM-1614	116	IS-EXP14-TYKT	74	IS-QS-2218	118	KTB-40W	7	NB-660 RED	43	PBTS-8BLK	114
40ISR	75	CPT-450 GRY	152	ET-11	143	GRK-110	117	IS-BR10M-100BLK	138	IS-EXP-MOT	74	IS-RLC-245G-BLK	62	KTB-60W	7	NB-770	42	PBTS-8RED	114
40ISR-24V	75	CPT-450 PL	152	ET-12	143	GS-1051-10	141	IS-BR10M-100BLU	138	IS-FAST1	144	IS-RM200	66	LBCH-612SW	41	NB-802	101	PI-1000R	33
60-401.0MM	12	CPT-650 BLK	152	ET-1260-DST	144	GS-1120BL	141	IS-BR10M-100RD	138	IS-FAST2	144	ISRS-350	54	LBCH-80M	41	NB-803M-BLK	100	PI-120U	32
60-401/2LB	12	CPT-650 GRY	152	ET-13	143	GS-610	141	IS-BR19M-100BLK	138	IS-FBG-4328	124	ISRS-400	54	LBPC-12-6	41	NB-803M-BLU	100	PI-1500A	32
60-40-12	12	CPT-650 PL	152	ET-14	143	GS-675	141	IS-BR19M-100BLU	138	IS-FWS-33	126	ISRS-460	54	LED-5M-14K-3WHT	25	NB-803M-RED	100	PI-1500C	33
60-401LB	12	CPT-FLE 145	152	ET-15	143	GS-720BL	141	IS-BR19M-100GR	138	IS-FWS-66	127	ISRS-500	54	LED-5M-2H-3RED	25	NB-803M-WHT	100	PI-1500R	34
60-40PEN	12	DC12-2405	37	ET-16	143	GSD-140	133	IS-BR19M-100RD	138	IS-GM16	73	ISRS-600	54	LED-5M-3H-3BLU	25	NB-803M-YLW	100	PI-200A	31
6AS-WRST5	12	DC12-2415	37	ET-17	143	GTD-1200	148	IS-BR6M-100BLK	138	IS-GRK-270	117	ISRS-680	54	LED-5M-4H-3YLW	25	NB-804PA	100	PI-24110-2000C	35
71B30KT	6	DC12-2430	37	ET-18	143	HD-013	123	IS-BR6M-100BLU	138	IS-HD10	74	ISRS-690	54	LED-5M-4K-3GRN	25	NB-804PD	100	PI-24110-400C	35
74B23	9	DL-1202HT	51	ET-19	143	HH-1	11	IS-BR6M-100RD	138	IS-HD11	74	IS-RT-1210-1/4	110	LED-5M-B4K-3BR	25	NB-805	101	PI-24110-800C	35
74B30	6	DL-1202LT	51	ET-20 MULTI	143	HH-2	11	IS-BT-1210	112	IS-HHM-16DCL	20	IS-RT-1210-10	110	LM-1-100 BLK	137	NB-880	42	PI-400A	31
74B55	7	DL-1222PHT	51	ET-5	143	HH-3MG	11	IS-BT-1614	112	IS-HHM26ACL	20	IS-RT-1210-3/8	110	LM-115-100 BLK	137	NL-CAN-H-9005	87	PI-75U	32
74B70	7	EA-1	73	EU-22	73	HH-4DS	11	IS-BT-1614NL	112	IS-HHM53L	19	IS-RT-1210-5/16	110	LM-1-20 BLK	137	NL-CAN-H-9006	87	PI-800A	31
74B70-60W	6	EA-1.5	73	EX-JUMP4-20	42	HHML-6085-3D	14	IS-BT-2218	112	IS-HHM75	19	IS-RT-1210-1/4	110	LM-12-100 BLK	137	NL-CAN-H-H11	87	PI-800C	33
76B40W-LED	6	EA-12	73	EX-JUMP6-16	42	HTSK-0200	136	IS-BT-2218NL	112	IS-HM300	19	IS-RT-1614-10	110	LM-14-100 BLK	137	NL-CAN-H-H4	86	PIB-1000D	30
76B60W-ADJ	6	EA-3	73	FAN-33	64	HTSK-0200-RL100	136	IS-BT-8	112	IS-ICR1555LG	126	IS-RT-1614-3/8	110	LM-34-100 BLK	137	NL-CAN-H-H7	86	PIB-300D	30
76D12-40W	5	EA-6	73	FAN-4712LERG	64	HTSK-0400	136	IS-BUP400-BLK	63	IS-ICTL-1224V	21	IS-RT-1614-5/16	110	LM-38-100 BLK	137	NL-H-9005-36W	84	PIB-500D	30
77B20-100W	8	EC-1103	95	FAN-55	64	HTSK-0400-RL100	136	IS-CC1416	118	IS-IQF-1210	115	IS-RT-2218-1/4	110	MAT-7400	21	NL-H-9006-36W	84	PIB-750D	30
77B20-150W	8	EC-1103ABL	95	FAN-550HS	64	HTSK-100CL	136	IS-CC-2214B	118	IS-IQF-1210NL	115	IS-RT-2218-1/10	110	MBLM-1614HS	116	NL-H-9007-36W	85	PI-DCDC-2412-10	36
77B20-30W	8	EC-1103ARD	95	FC-10A	122	HTSK-1612	136	IS-CC2214N	118	IS-IQF-1614	115	IS-RT-HDO-3/8	108	MBT-1210-HS	111	NL-H-H11-36W	86	PI-DCDC-2412-100	36
77B20-40W	8	EC-1115	98	FC-12A	122	HTSK-1612-RL100	136	IS-CDLS-05M	69	IS-IQF-1614NL	115	IS-RT-HDO-5/16	108	MBT-1614-HS	111	NL-H-H13-36W	86	PI-DCDC-2412-30	36
77B20-60W	8	EC-1115PP	98	FC-15A	122	HTSK-2018	136	IS-CDLS-10R	69	IS-IQF-2218NL	115	IS-RVC-165GL	63	MBT-2218-HS	111	NL-H-H1-36W	85	PI-DP-3000C	34
78B40	7	EC-1210	101	FC-20A	122	HTSK-2018-RL100	136	IS-CDLS-40R	69	IS-IQM-1210	116	IS-RVC-170MI	62	MQD-1210-250HS	111	NL-H-H4-36W	85	PIUB-1200-12X	28
78B60	7	EC-1210SCR	95	FC-25A	122	HTSK-2422	136	IS-CF512	64	IS-IQM-1210NL	116	IS-RVC-258GL	63	MQD-1614-250HS	111	NL-H-H7-36W	85	PIUB-3000-24X	28
78B80	7	EC-1213	96	FC-30A	122	HTSK-2422-RL100	136	IS-CF812	64	IS-IQM-1614NL	116	IS-RVC-360ROT	63	MQD-2218-250HS	111	NL-HL-7243-72W	87	PJ-06	132
79B100SS	9	EC-1213BLU	95	FGMAC-1	122	HTSK-2826	136	IS-CLE12	44	IS-IQM-2218NL	116	IS-RVDV-43	61	MRT-1210-8HS	111	NL-LB303-18W	83	PJ-11	132
79B20-200W	8	EC-1213RED	95	FGMAC-2	122	HTSK-2826-RL100	136	IS-CR1005	126	IS-IST-166A	127	IS-RVC-841TRJ	62	MRT-1614-6HS	111	NL-LBC352	80	PRO-1000	75
79B21-30W	8	EC-1215	96	FGMAC-3	122	ICR-010	126	IS-CR16	73	IS-IUB-016	134	IS-RVDV-96	61	MRT-2218-4HS	111	NL-LBC354	80	PRO-1020	75
79B65-30W	7	EC-1217BLU	96	FGMAC-4	122	ICT-112	21	IS-CT-10	139	IS-IUB-018	134	IS-RVDM-96	61	MV-30V	26	NL-LBKT-10	88	PRO-1205-CER	76
79B65-40W	7	EC-1220BLU	98	FGMAC-6.3	122	ICT-115LED	21	IS-CT-12	139	IS-IUB-020	134	IS-RVMR-43	62	MVA-100V	26	NL-LBMX382-25W	82	PROW-2002	67
79B65-60W	7	EC-1220RED	98	FGMAC-8	122	IHPM-307	132	IS-CT-14	139	IS-K1700	60	IS-SB10	74	MVT-230C	26	NL-LBOV-43-20W	83	PROW-4004	67
80-ARB	75	EC-1220WHT	98	FM.25	123	IHPS-307	131	IS-CT-16	139	IS-K1700P	60	IS-SP-10-500CL	59	MVT-230F	26	NL-LBR317-72W	81	PSW-3000C	29
824-450G	150	EC-126	102	FM.5	123	IS-1005SK	76	IS-CT-18	139	IS-K2500	60	IS-SP-1210-10	112	NA-1500	70	NL-LBR325-120W	81	PSW-5000C	29
824-500ML	150	EC-1500	94	FM1	123	IS-1020	124	IS-CT-4	139	IS-K2500P	60	IS-SP-12-500CL	59	NA-1500B	70	NL-LBR333-180W	81	PTD-10BLK	114
AFC-120	121	EC-1501	94	FM1.5	123	IS-119-5G	117	IS-CT-518RU	140	IS-K3500	60	IS-SP14-1000BR	59	NA-1502	70	NL-LBR353-288W	80	PTD-10RED	114
AFC-150	121	EC-1502	94	FM10	123	IS-119-5SL	117	IS-CT-6	139	IS-K800	60	IS-SP-14-1000CL	59	NA-1508	71	NL-LBR355-288W	80	PTD-16BLK	114
AFC-30	121	EC-1503	94	FM15	123	IS-120-5G	117	IS-CT-718RU	140	IS-KEY9	134	IS-SP16-1000BR	59	NA-1514	70	NL-LBRO-07-51W	83	PTD-16RED	114
AFC-40	121	EC-1510	94	FM2	123	IS-120-5SL	117	IS-CT-8	139	IS-KIT-130	128	IS-SP-16-1000CL	59	NA-1517L	70	NL-LBS326-72W	81	PTD-18 BLK	114
AFC-50	121	EC-1512	94	FM2.5	123	IS-160	66	IS-CTR-8BUV	139	IS-LD-AVMS-12	103	IS-SP-1614-10	112	NA-1517R	70	NL-LBS36-18W	82	PTD-18RED	114
AFC-60	121	EC-1515	94	FM3	123	IS-1805SK	76	IS-CXC0208	126	IS-LD-DVS-12	103	IS-SP18-1000BR	59	NA-1518	70	NL-LBSQ-14-27W	83	PTR-0 BLK	109
AFC-80	121	EC-1515P	94	FM3.15	123	IS-210	66	IS-DB91832	65	IS-LD-USBVS-12	103	IS-SP-18-1000CL	59	NA-1524	71	NL-LBSQ-15-27W	84	PTR-0 RED	109
AGU-100A	122	EC-1520	94	FM3.5	123	IS-500-ANGPLM	18	IS-DD61224	65	IS-MUV40	73	IS-SP20-1000BR	59	NA-1532	71	NL-LBSQ-33-10W	82	PTR-10 BLK	109
AGU-40A	122	EC-1521MM	93	FM4	123	IS-600-ANGTAB	18	IS-DL-1254-REC	51	IS-MVA4	63	IS-SP-2218-10	112	NA-1533	71	NL-LBSQ874D-10W	82	PTR-10 RED	109
AGU-50A	122	EC-1522	93	FM5	123	IS-9013	22	IS-DL-1254-SQR	51	IS-N2C	124	IS-SP-2218-6	112	NA-1544RF	72	NL-LBSTRQ-15-27W	84	PTR-4 BLK	109
AGU-60A	122	EC-1523	93	FM6	123	IS-9604-CMPSMT	18	IS-DS21012	65	IS-NE22	72	IS-SPGT-25G	142	NA-1546ER	72	NP-210	44	PTR-4 RED	109
AGU-70A	122	EC-1524	93	FM6.3	123	IS-9604-NVECO	17	IS-DT101224	65	IS-NI16	74	IS-SS6045-SH	4	NA-1549	71	NSCO-014	140	PTR-6 BLK	109
AGU-80A	122	EC-2510	93	FM7	123	IS-9606-TEMPPLM	17	IS-EC12MT-BLU	103	IS-NR100	66	IS-SS6045-SH	5	NA-1551	70	NSCP-01	140	PTR-6 RED	109
ANL-100A	121	EC-2530	93	FM8	123	IS-9609-SQWRMS	16	IS-EC138-ALM	101	IS-NR12	66	IS-SS6045-SI	5	NA-1553	71	NSCP-012	140	PTR-8 BLK	109
ANL-150A	121	EC-2533P	93	FM9	123	IS-9699-NCVHAR	16	IS-EC-IR1216BLU	96	IS-NR35	66	IS-SS6045-SPT	4	NA-1555UN	72	NSCW-01	140	PTR-8 RED	109
ANL-175A	121	EC-2550	93	FN.5	123	IS-ACBAF-65	58	IS-EC-IR1216RED	96	IS-NTK-370	128	IS-SS6045-SPT	5	NA-1560	72	NSCW-012	140	PTR-OT-BLK	108
ANL-200A	121	EC-2602	98	FN1	123	IS-ACBAF-69	58	ISEC-IT1220BLU	92	IS-NTK-400	128	IS-SS7048-AH	4	NA-1599	70	NST-012B	140	PTR-OT-RED	108
ANL-225A	121	EC-2604	98	FN1.5	123	IS-ACBAF-8	58	IS-EC-IT1220RED	92										



# INDEX

RING-3720	57	US-CT-4BUV	139
RING-4545	56	US-CT-6BUV	139
RING-4R	57	US-CT-7BUV	139
RING-5.25R	57	US-CT-8BUV	139
RING-5757	56	VS-1122	102
RING-6.5BZ	57	VW-16	73
RING-6.5GR	57	VWS-1000	78
RING-6.5R	57	W-1	12
RING-69CBK	56	WH-ACU9810	77
RING-8BZ	57	WH-FORMAMP9597	77
RING-8CTW	56	WH-GM8802	77
RING-8GR	57	WH-HON0208	77
RING-8R	57	WH-HYN0210	78
RING-H537	56	WH-JVC09	78
RING-PVC 6	57	WH-JVC16P	78
SBL-12-50-BLK	137	WH-KENWOOD16P	78
SBL-1-50-BLK	137	WH-MAZ0110	78
SBL-34-50-BLK	137	WH-MAZ8902	78
SP-10	12	WH-MIT9410	78
SP-15	12	WH-NIS0210	77
SP-50	12	WH-NIS0710	78
ST-4068CT	19	WH-NIS8694	78
ST-4300CT	19	WH-NIS9502	78
ST-5077	19	WH-PIONEER01	77
ST-5505	20	WH-PIONEER11	77
ST-BB23-CPR	24	WH-SUB 9019	77
STBB46-CPR	24	WH-TOY8702	77
ST-JW65MM	25	WH-VW8602	78
ST-PC23-CPR	24	WH-VW8702	77
ST-PC46-CPR	24		
ST-SB32-ABS	24		
ST-SB73-ABS	24		
ST-SB74-ABS	24		
TGP-450-20G	142		
TGP-550-20G	142		
THSY-1000	50		
THSY-1075-DH	50		
THSY-1075-EC	50		
THSY-1075H	50		
THSY-1075-H4	50		
THSY-1412-YH4T	49		
THSY-1615-CHET	49		
THSY-2050-CH	49		
THSY-3075C	47		
THSY-3075KIT	48		
THSY-5150C	47		
THSY-5150KIT	48		
THSY-6075-CST	47		
THSY-6150-CST	47		
THSY-GAUGE	48		
THSY-HOSE 25	48		
THSY-HSE 7	48		
THSY-HSOLE	48		
TNT-BAG	134		
TNT-KN09	148		
TNT-KN1210-SB	148		
TNT-SC10	148		
TNT-SC10010-SB	148		
TNT-SPP42	148		
TNT-SQ11M	147		
TNT-SQ22S	147		
TNT-SQ29M	147		
TNT-SQ35H	146		
TNT-SQ35MAH	146		
TNT-SQ35SF	146		
TNT-SQ55	146		
TRMB-12-1.5A	44		
TTK-021	131		
TTK-021-RB57	131		
TTK-061	130		
TTK-3756	131		
TTK-69	130		
TTK-725	129		
TTK-756	131		
TUBO-10	55		
TUBO-12	55		
TUBO-6.5	55		
TUBO-8	55		
US-CT-11BUV	139		
US-CT-14BUV	139		