

# USER'S MANUAL



## Planet Audio®

**MOSFET MONOBLOCK POWER AMPLIFIER**

**PL2500.1M • PL2000.1M • PL1500.1M**

with Remote Subwoofer Control

**2 CHANNEL MOSFET POWER AMPLIFIER**

**PL3000.2 • PL1600.2 • PL1200.2**

with Remote Subwoofer Control

**4 CHANNEL MOSFET POWER AMPLIFIER**

**PL2400.4 • PL1600.4**

with Remote Subwoofer Control



Planet Audio®

**PL1200.2** *Two Channel  
MOSFET Car Audio  
Amplifiers*  
**PL1600.2**  
**PL3000.2**

---

**PL1600.4** *Four Channel  
MOSFET Car Audio  
Amplifiers*  
**PL2400.4**

---

**PL1500.1M** *Monoblock  
MOSFET Car Audio  
Amplifiers*  
**PL2000.1M**  
**PL2500.1M**

**Congratulations on your  
purchase of a  Planet Audio  
PULSE Amplifier.**

It has been designed, engineered  
and manufactured to bring you  
the highest level of performance  
and quality, and will afford you  
years of listening pleasure.

Thank you for making  Planet Audio  
your choice for car audio  
entertainment!

## Introduction

With the  **PULSE MOSFET** amplifier series, we are introducing eight new amplifiers, all designed in the USA. This new series includes three monoblock amps, three 2-channel, two 4-channel amplifiers.

All **PULSE** models feature variable low pass and high pass **(except monoblock amps)** crossovers and variable input gain controls.

For further flexibility in the use of a subwoofer, 0-+18dB( **PL1500.1M: 0/18dB ; PL2000.1M and PL2500.1M:0-12dB**)

Bass Boost control has been included on **all** amplifiers. You can control the subwoofer level with the remote level control module.

 understands that amplifiers are placed in many different kinds of installations, so we incorporated a very flexible system of controls in these amplifiers in order to help you integrate the amp into your system regardless of the nature of your input source.

## What is included?

When first unpacking your new amplifier, please check first that the package contains **all** of the items below. If something is missing, contact the store where you purchased the amplifier.

- **PULSE amplifier**
- **Remote subwoofer control**
- **High input cable with connector**
- **Four (4) mounting screws**

## Features

Your new **PULSE amplifier** features the following:

- **Class A/B Topology**
- **Bridgeable outputs**  
(Except PL1500.1M , PL2000.1M and PL2500.1M)
- **MOSFET PWM (Pulse Width Modulated) Power Supply**
- **2  $\Omega$  stable stereo operation with output power increase**
- **Thermal and speaker short protection**
- **Soft turn-on circuit**
- **Remote turn-on/turn-off circuit**
- **Variable input gain control**
- **Variable low pass filter**
- **Fixed high pass filter**  
(Except PL1500.1M , PL2000.1M and PL2500.1M)
- **Variable 0 to +18dB Bass Boost**  
( PL1500.1M: 0/18dB ; PL2000.1M and PL2500.1M:0-12dB)
- **Nickel-plated RCA low level and high level inputs**
- **LED power and protection indicators**
- **Black anodized heatsink**
- **Remote subwoofer control**

## About 2 $\Omega$ operation

Your **PULSE amplifier** has been designed to operate efficiently at loads down to 2  $\Omega$ .

When operating at 2  $\Omega$ , the amplifiers will increase their output power by approximately 50%. *The current draw will also increase by about the same amount, so be sure you have enough current to run the amplifiers into a 2  $\Omega$  load.*

*Before installing any electrical accessories to your vehicle, always make sure the vehicles electric system is equipped to handle the extra electrical load.*

## General precautions

***Before installing and using your new PULSE amplifier, please become familiar with all the information contained in this manual.***

***Please keep this manual in a safe place for future reference.***

- Do not open or attempt to repair this unit yourself. Dangerous high voltages are present which may result in electric shock. Refer any repairs to a qualified service technician.
- To avoid risk of electronic shock or damage to the amplifier, do not permit any of this equipment to become damp or wet from water or drinks. If this does occur, immediately unplug the power wires and send the amplifier to your local dealer or service center as soon as possible.

## Installation precautions

Before you drill or cut any holes, investigate your car's layout very carefully. Take special care when you work near the gas tank, fuel lines, hydraulic lines and electrical wiring.

Never operate the amplifier when it is unmounted. Attach all audio system components securely to prevent damage, especially in an accident.

Before making or breaking power connections in your system, disconnect the vehicle battery. Confirm that your head unit or other equipment is turned off while connecting the power and/or speaker(s).

If you need to replace the power fuse, replace it only with a fuse identical to that supplied with the amplifier. Using a fuse of a different type or rating may result in damage to your audio system or your amplifier which is not covered by the manufacturer's warranty.

## Mounting the amplifier

1. Find a suitable location in the vehicle in which to mount the amplifier.
2. Make sure there is sufficient air circulation around the intended mounting location.
3. Mark the location for the mounting hole screws by positioning the amplifier where you wish to install it. Use a scribe or mounting screw, inserted through each of the amp's mounting holes, to mark the mounting surface. If the mounting surface is carpeted, measure the hole centers and mark with a felt tip pen.
4. Drill pilot holes in the mounting surface for the mounting screws. Place the amplifier in position, and attach the amplifier to the mounting surface securely using screws.

**SHOCK HAZARD!** Do not open the case of this product. There are dangerous voltages present within the unit. There are no user-serviceable parts within the unit.

## Connecting the amplifier

Before doing any wiring, look through this manual and identify the diagrams to follow for power, input and speaker connections for your particular installation. Be sure you understand all the connections before you proceed.

1. Connect the power ground terminal to the closest point on the chassis of the car. Keep this ground wire to less than 39" (100 cm) in length. Use the same size gauge wire as the power wire.
2. Connect the remote terminal to the remote output of the head unit using 16 gauge (or larger ) wire.
3. Connect an empty fuse holder within 18" (45 cm) of the car battery, and run 4 gauge cable from this fuse to the amplifier location.
4. Check that the fuse holder is empty. Then connect the fuse holder to the "BATT+" connection on the amplifier.
5. If multiple amplifiers are being used in your system, either:
  - Run a separate pair of cables from the battery and a chassis ground point to each amplifier. Each (+) cable must have its own inline fuse.

-or-

  - Run a #4 cable from the fuse holder at the battery to a distribution block at or near the amplifier's location. Then run separate cables from the amplifier to this distribution block and to independent chassis ground points.
6. Connect all line inputs and outputs (if used) using high-quality cables. Connect all speakers, following the diagrams in this manual. Be sure to observe proper polarity to avoid audio phase problems.

7. Insert fuse(s) into the battery fuse holder(s).
8. Recheck all connections before powering up the amplifier.
9. Set all level controls to minimum position, and set all crossover controls/switches to the desired frequency points.
10. Power up the head unit and the amplifier. Then set the volume control on the head unit to about 3/4 volume, and adjust the amplifier's input level control(s) to just below the level of distortion.
11. Further fine tuning of the various controls may be necessary to obtain best results.

### **Don't misuse the level control!**

Do not mistake the input level control for a volume control! It is designed ONLY to match the output level of your audio source to the input level of your amplifier.

Do not adjust this input level to maximum unless your input level requires it.

Ignoring these instructions will result in an input overload to the amplifier, and excessive audio distortion. It can also cause the protection circuit to engage.

## Low Level Input Wiring

Low-level (RCA) input wiring is preferred for best audio performance. Always use a high-quality RCA cable for best audio performance.

**NOTE: Do not connect BOTH the high level and low level inputs from your receiver to your amplifier at the same time!**

## 2-Channel Amplifiers

PL1200.2, PL1600.2 and PL3000.2

Remote Subwoofer Control

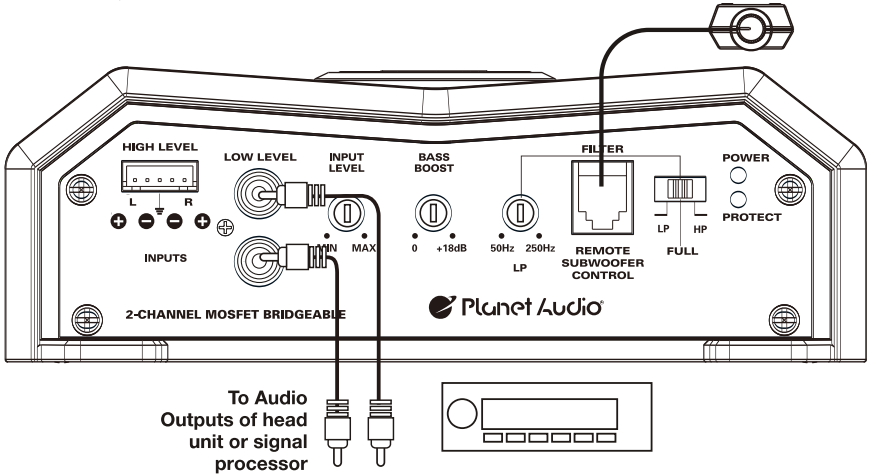

## 4-Channel Amplifiers

PL1600.4 and PL2400.4

Remote Subwoofer Control

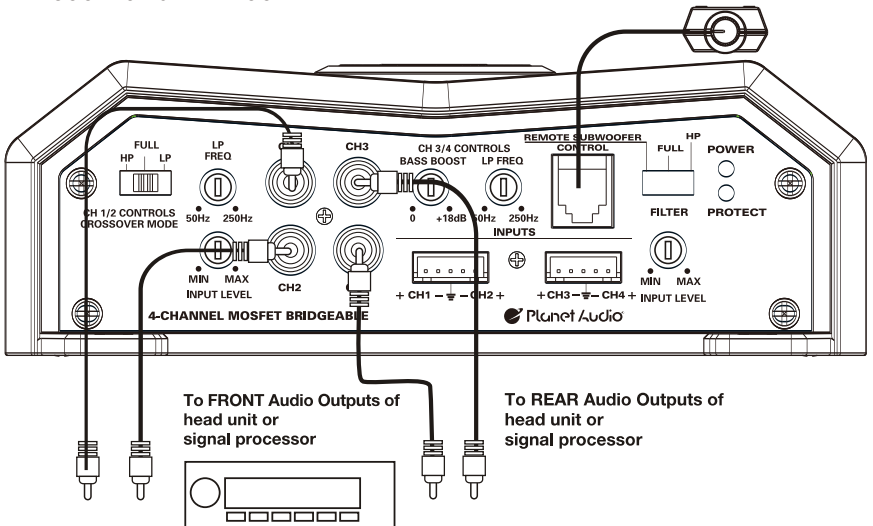



## Low Level Input Wiring

Low-level (RCA) input wiring is preferred for best audio performance. Always use a high-quality RCA cable for best audio performance.

**NOTE: Do not connect BOTH the high level and low level inputs from your receiver to your amplifier at the same time!**

## Monoblock Amplifier

PL1500.1M

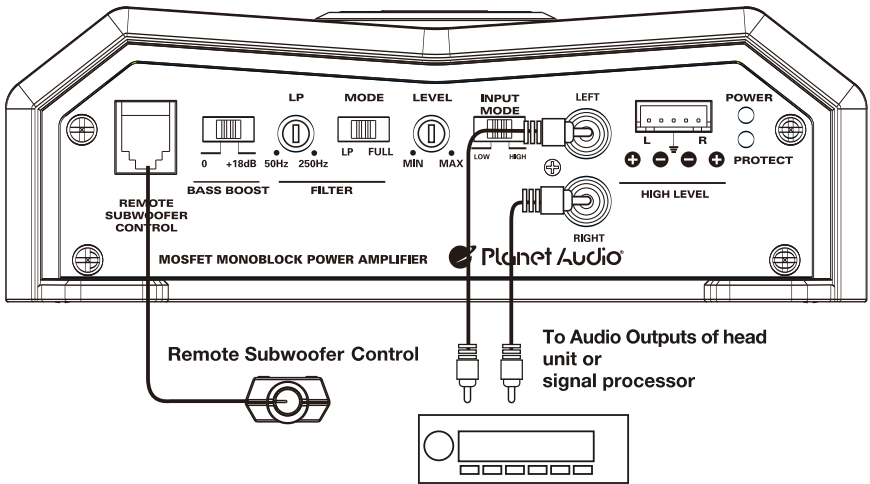

## Monoblock Amplifiers

PL2000.1M and PL2500.1M

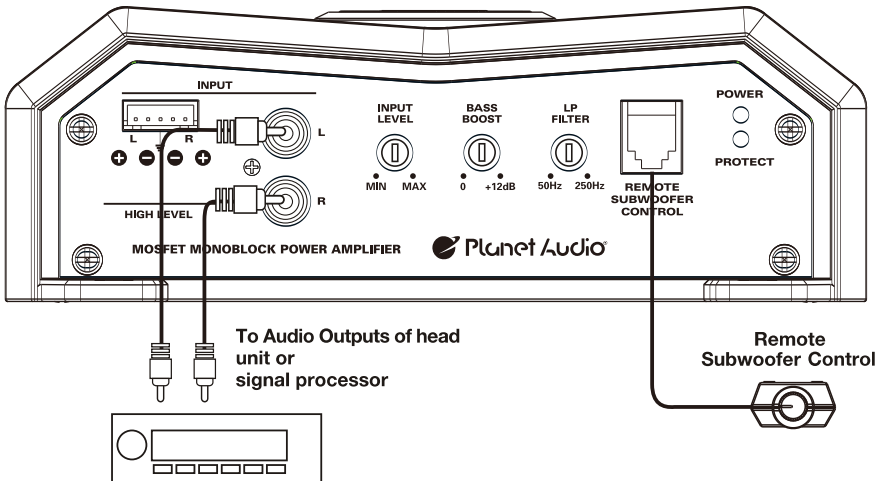



## High Level Input Wiring

The high level input(s) should only be used when your head unit lacks RCA outputs. If the RCA outputs are not present, connect the speaker outputs from the receiver to the high level input connector of the amplifier. Be sure to observe polarity to avoid audio phase problems.

**NOTE: Do not connect BOTH the high level and low level inputs from your receiver to your amplifier at the same time!**

## 2 Channel Amplifiers

PL1200.2, PL1600.2 and PL3000.2

Remote Subwoofer Control

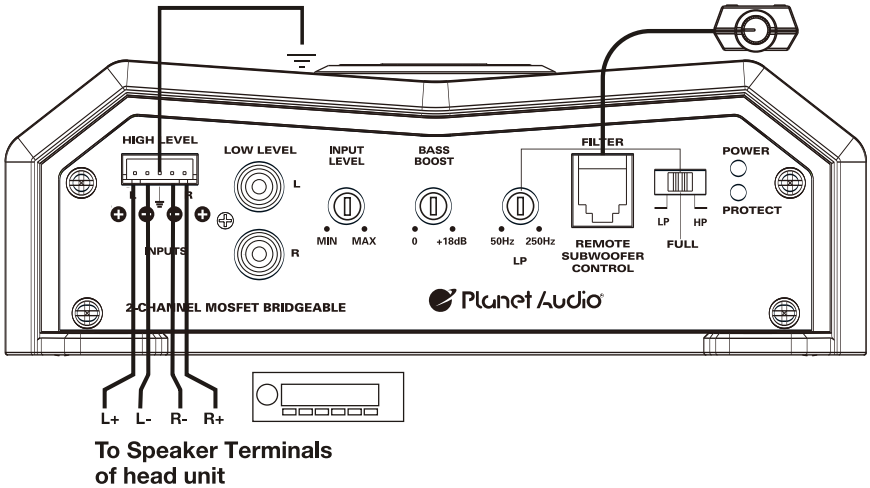

To Speaker Terminals of head unit

## 4-Channel Amplifiers

PL1600.4 and PL2400.4

Remote Subwoofer Control

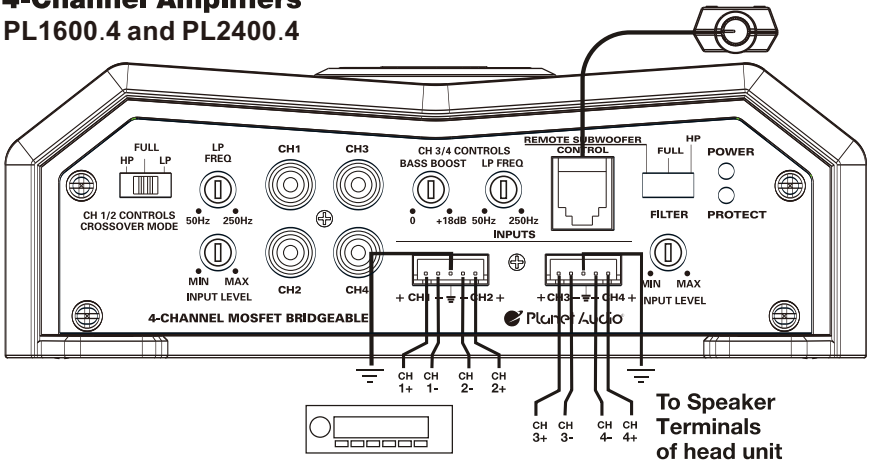

To Speaker Terminals of head unit

## High Level Input Wiring

The high level input(s) should only be used when your head unit lacks RCA outputs. If the RCA outputs are not present, connect the speaker outputs from the receiver to the high level input connector of the amplifier. Be sure to observe polarity to avoid audio phase problems.

**NOTE: Do not connect BOTH the high level and low level inputs from your receiver to your amplifier at the same time!**

## Mono block Amplifiers

### PL1500.1M

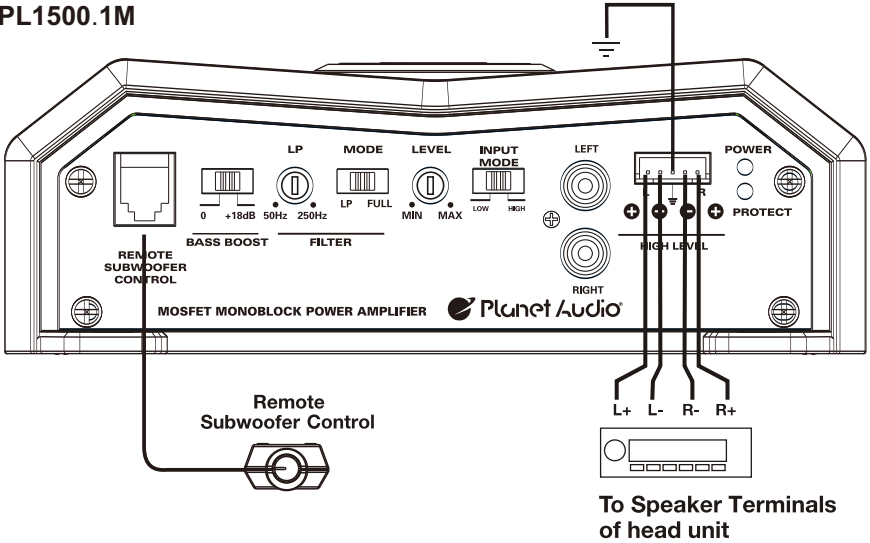

## Mono block Amplifiers

### PL2000.1M and PL2500.1M

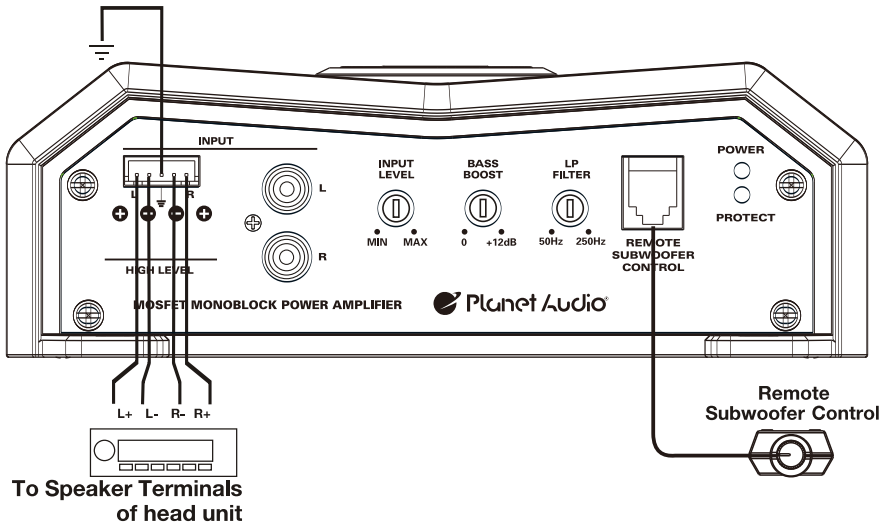

# Power and Speaker Wiring

## 2 Channel and Bridged Modes

**2-Channel Amplifiers**  
PL1200.2, PL1600.2 and PL3000.2

### Two Channel Mode

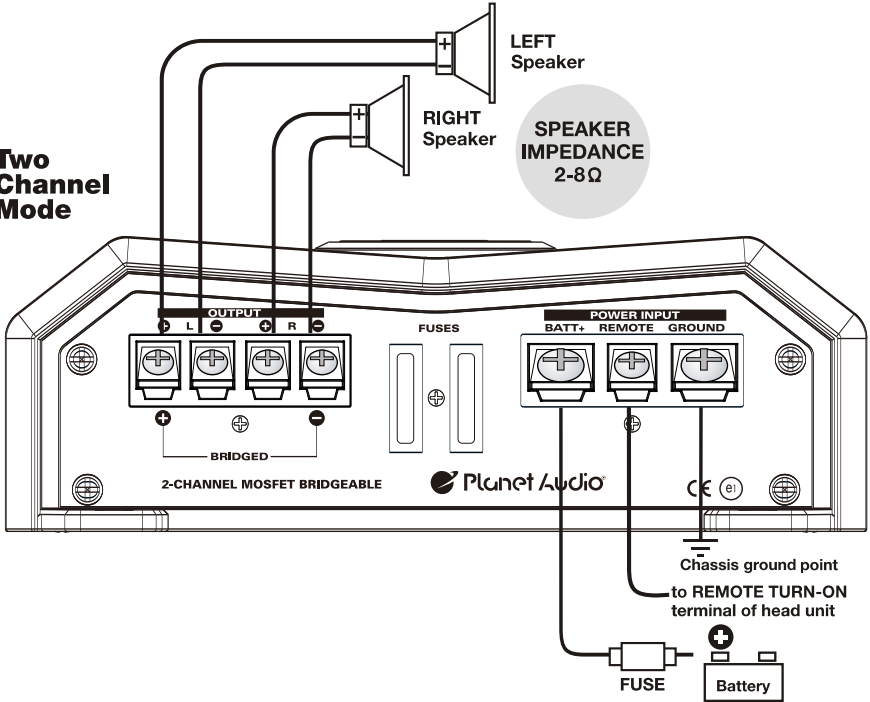

### Bridged Mode

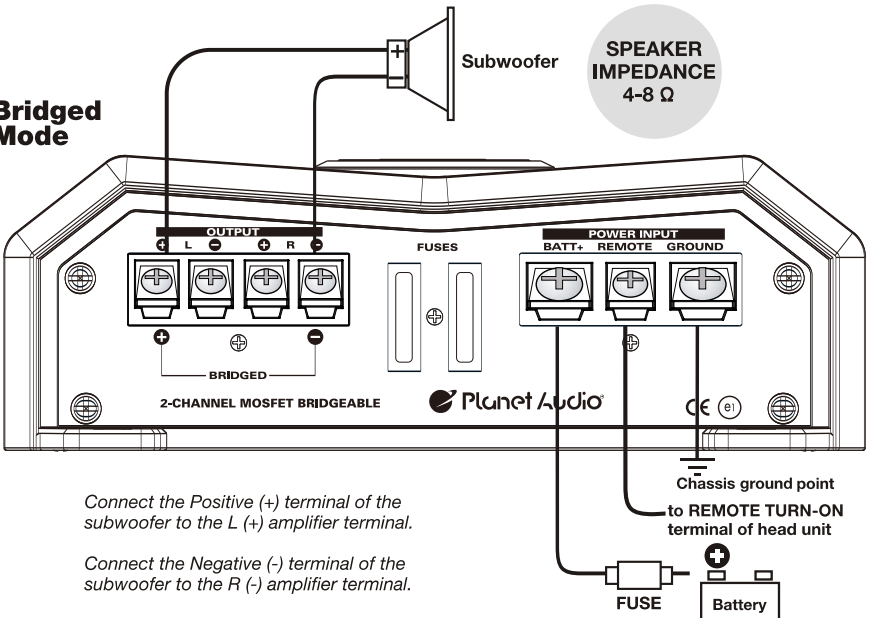

# Power and Speaker Wiring

## 4 Channel and Bridged Modes

# 4-Channel Amplifiers

## PL1600.4 and PL2400.4

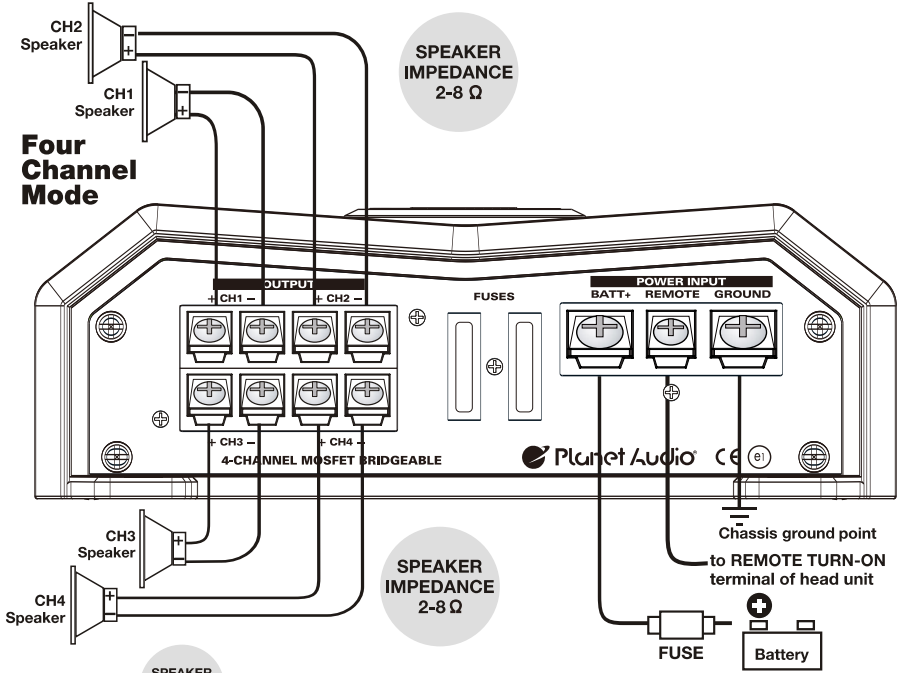

Connect the Negative (-) terminal of the LEFT subwoofer to the CH2 (-) amplifier terminal.

Connect the Positive (+) terminal of the LEFT subwoofer to the CH1 (+) amplifier terminal.

# Bridged Mode

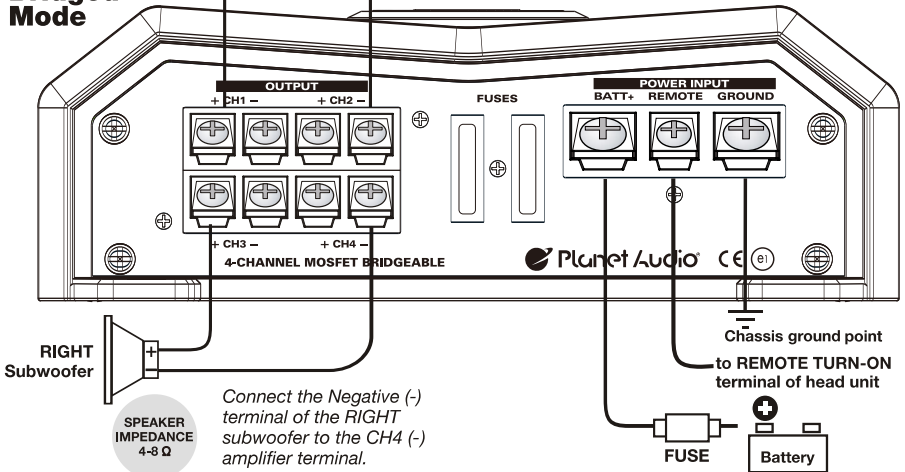

Connect the Negative (-) terminal of the RIGHT subwoofer to the CH4 (-) amplifier terminal.

Connect the Positive (+) terminal of the RIGHT subwoofer to the CH3 (+) amplifier terminal.

# Power and Speaker Wiring

Monoblock Mode

# Monoblock Amplifiers

PL2000.1M and PL2500.1M

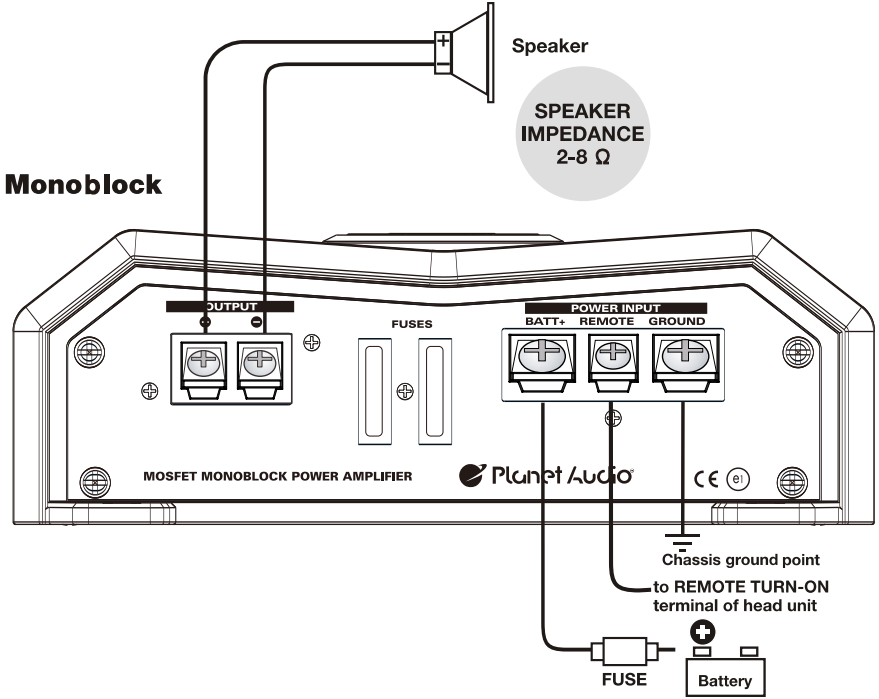

## Troubleshooting

If you experience operation or performance problems with this product, compare your installation with the electrical wiring diagram on the previous pages. If problems persist, read the following troubleshooting tips which may help eliminate the problems.

<b>SYMPTOM</b>	<b>POSSIBLE REMEDY</b>
<b>Amplifier will not power up.</b>	<p>Check to make sure you have a good ground connection.</p> <p>Check that the Remote Input (Turn-On) has at least 3VDC.</p> <p>Check that there is battery power on the (+) terminal.</p> <p>Check that there is at least 12v.</p> <p>Check all fuses, replace if necessary.</p> <p>Make sure that the Protection LED is not illuminated. If it is lit, shut off the amplifier briefly, and then repower it.</p>
<b>Protection LED comes on when amplifier is powered up.</b>	<p>Check for short circuits on speaker leads.</p> <p>Turn down the volume control on the head unit to prevent overdriving.</p> <p>Remove speaker leads, and reset the amplifier. If the Protection LED still comes on, then the amplifier is faulty and needs servicing.</p>
<b>No output.</b>	<p>Check that all fuses are OK.</p> <p>Check that amplifier is properly grounded.</p> <p>Check that the Remote Input (Turn-On) has at least 3VDC.</p> <p>Check that the RCA audio cables are plugged into the proper inputs.</p> <p>Check all speaker wiring.</p>
<b>Low output.</b>	<p>Reset the Level Control.</p> <p>Check the filter Control settings.</p>
<b>Audio present in only one channel.</b>	<p>Check the RCA interconnect cables.</p> <p>Check all speaker wiring.</p>
<b>High hiss in the speakers.</b>	<p>Disconnect all RCA inputs to the amplifiers. If the hiss disappears, then plug in the component driving the amplifier and unplug its inputs. If the hiss disappears at this point, go on until the faulty/noisy component is found.</p> <p>It is best to set the amplifier's input level control as low as possible. The best subjective signal-to-noise ratio is achieved in this manner. Try to set the head unit as high as possible (without distortion) and the amp input level as low as possible.</p>
<b>Squealing noise from speakers.</b>	<p>Check for improperly grounded RCA interconnects.</p>
<b>Distorted sound.</b>	<p>Check that the Input Level Control is set to match the signal level of the head unit. Always try to set the Input Level as low as possible.</p> <p>Check that all crossover frequencies are properly set.</p> <p>Check for short circuits on the speaker leads.</p>
<b>Amplifier gets very hot.</b>	<p>Check that the minimum speaker impedance for the amp model is correct.</p> <p>Check that there is good air circulation around the amp. In some applications, it may be necessary to add external cooling fan(s).</p>
<b>Engine noise (static type)</b>	<p>This is usually caused by poor quality RCA cables, which can pick up radiated noise. Use only the best quality cables, and route them away from power cables.</p>
<b>Engine noise (alternator whine)</b>	<p>Check that speaker leads are not shorted to the vehicle chassis.</p> <p>Check that the RCA grounds are not shorted to the vehicle chassis.</p> <p>Check that the head unit is properly grounded.</p>

# Specifications



## 2-Channel MOSFET Amplifiers

MODEL	PL1200.2	PL1600.2	PL3000.2
<b>MAX Power into 2 Ω</b>	600 W x 2	800 W x 2	1500 W x 2
<b>Bridged Power into 4 Ω</b>	1200 W x 1	1600 W x 1	3000 W x 1
<b>Min. Speaker Impedance</b>	2 Ω Stereo 4 Ω Mono Bridged		
<b>THD + N</b>	≤ 0.01 %		
<b>Frequency Response</b>	9 Hz - 50 KHz		
<b>S/N Ratio</b>	103 dB		
<b>Channel Separation</b>	90 dB		
<b>Low Pass Filter</b>	50Hz - 250Hz		
<b>High Pass Filter</b>	Fixed, 80 Hz		
<b>Bass Boost</b>	Variable 0 - +18 dB		
<b>Fuse Rating</b>	35 A	25 A x 2	40 A x 2
<b>Dimensions (Length) : (W x H) (7.00" x 2.39")</b>	9.96"(L)	12.72"(L)	18.22"(L)

## 4-Channel MOSFET Amplifiers

## Monoblock MOSFET Amplifiers

MODEL	PL1600.4	PL2400.4	PL1500.1M	PL2000.1M	PL2500.1M
<b>MAX Power into 2 Ω</b>	400 W x 4	600 W x 4	1500 W x 1	2000 W x 1	2500 W x 1
<b>Bridged Power into 4 Ω</b>	800 W x 2	1200 W x 2	n/a	n/a	n/a
<b>Min. Speaker Impedance</b>	2 Ω Stereo 4 Ω Mono Bridged		2 Ω	2 Ω	2 Ω
<b>THD + N</b>	≤ 0.01 %				
<b>Frequency Response</b>	9 Hz - 50 KHz			9 Hz - 250 Hz	9 Hz - 250 Hz
<b>S/N Ratio</b>	103 dB				
<b>Channel Separation</b>	90 dB		n/a	n/a	n/a
<b>Low Pass Filter</b>	50Hz - 250Hz				
<b>High Pass Filter</b>	Fixed, 80 Hz		n/a	n/a	n/a
<b>Bass Boost</b>	0 - +18 dB Variable	0 - +18 dB Variable	0 / +18 dB Switchable	0 - +12dB Variable	0 - +12dB Variable
<b>Input Mode Selector</b>	n/a		n/a	n/a	n/a
<b>Fuse Rating</b>	25 A x 2	35 A x 2	30 A	25 A x 2	30 A x 2
<b>Dimensions (Length) : (W x H) (7.00" x 2.39")</b>	11.93"(L)	15.87"(L)	9.96"(L)	12.72"(L)	15.87"(L)

All specifications subject to change without notice.