

POWER ACOUSTIK

Operation Instruction Manual

CPAA-70D10F



Content

1. Appearance.....	3
2. Accessories and Installation	3
3. Wiring Connection	5
4. Front panel Description.....	7
5. Remoto Control	8
6. Main Menu	9
7. Settings	9
8. Apple CarPlay & Android auto	11
9. Radio	12
10. USB	13
11. Disc	13
12. BT Audio.....	14
13. BT Phone.....	15
14. Specification.....	17
15. AV IN	18
FCC Notes	19

1. Appearance

Appearance

Main Menu



Carplay Menu

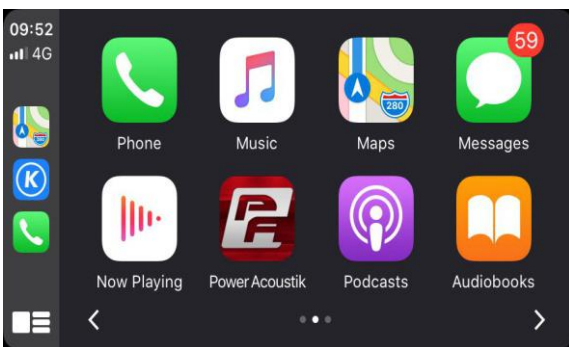

Android Auto Menu

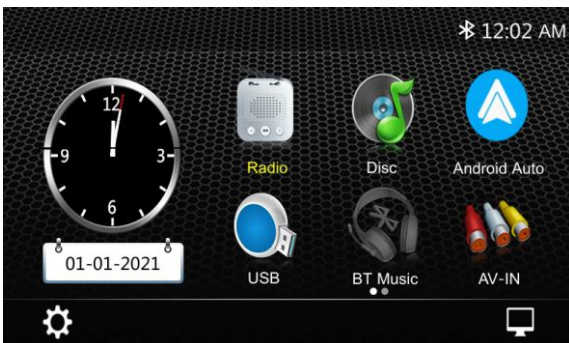

2. Accessories & Installation

Accessories & Installation

Package contains the following accessories for installation and operation of the unit.

(1) Mounting bracket	2	
(2) Screw	8	
(3) Remote	1	
(4) Trim Ring	1	
(5) User Manual	1	
(8) Warranty Card	1	
(9) ISO Cable	2	
(10) Harness cable	1	
(11) USB cable	1	

2. Accessories & Installation

Installation

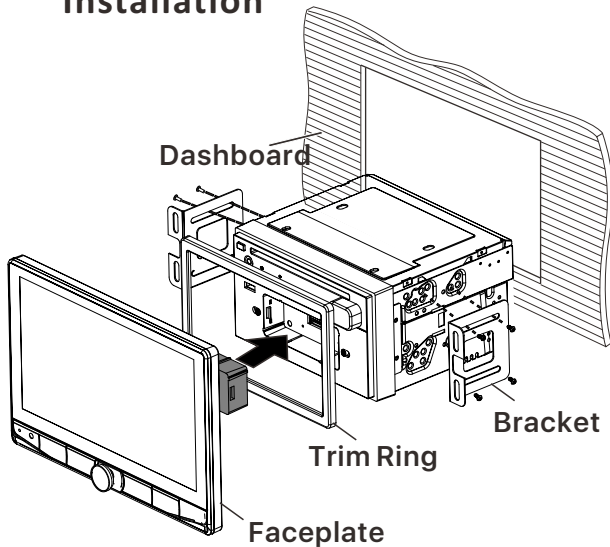

Installation

1. Put the 2 brackets to the left and right side of the headunit.
2. Use screws to fix the brackets to the unit.
3. Install the body chassis into the dashboard via the 2 brackets.
4. Install the trim ring to the body chassis.
5. Install the faceplate.

Note: Please note this faceplate is not designed for detachable.

Disconnect / Connect the screen connector ONLY for installation in the vehicle.

Note:

1. Make sure the ignition is turned off, and disconnect the cable from the vehicle battery's negative (-) terminal.
You never want electricity running when you install this 2-DIN car receiver.
2. Before installation, disconnect the wire harness and the antenna.
3. Attach the brackets on the both sides of the car receiver with screws as shown as the installation drawing. Please buy from your dealer according to the drilling of holes size.

4. Consult with your nearest dealer if installation requires the drilling of holes or other modification of the vehicle.
5. Install the car receiver in the dashboard.
6. Connect the wire harness & antenna to the car receiver being carefully not to pinch any wires or cables.
7. Install the plastic outer trim ring onto the car receiver.
8. Reconnect the battery and run through all of the options on this car receiver to ensure that everything is working correctly.
9. Particulars will vary widely depending upon the kind of your car and the car you intend to install it in. Please choose the correct installation method according to the actual situation of your car. Always contact the car dealer or manufacturer if you have any questions.

Faceplate Adjustable Position

1. Vertical

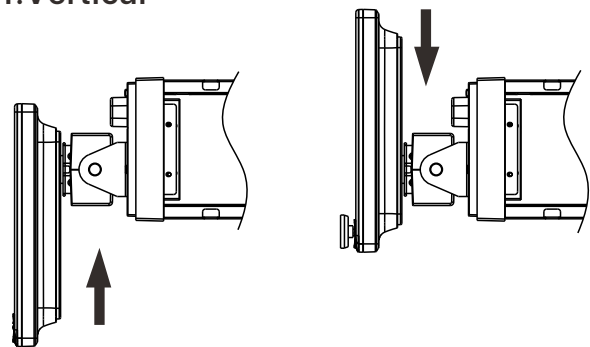

2. Tilt

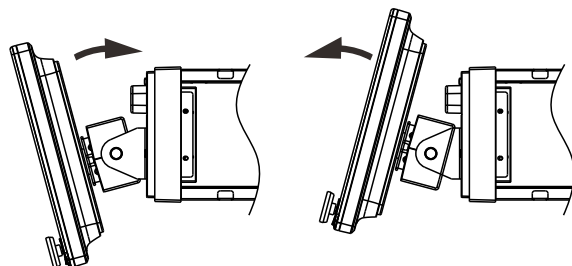

2. Accessories & Installation 3. Wiring

3. Swivel

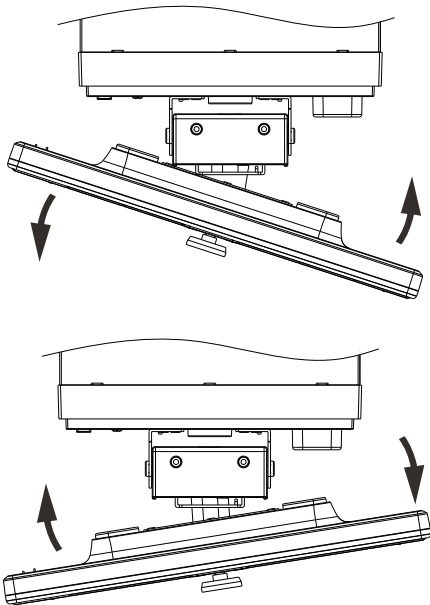

Un-Installation

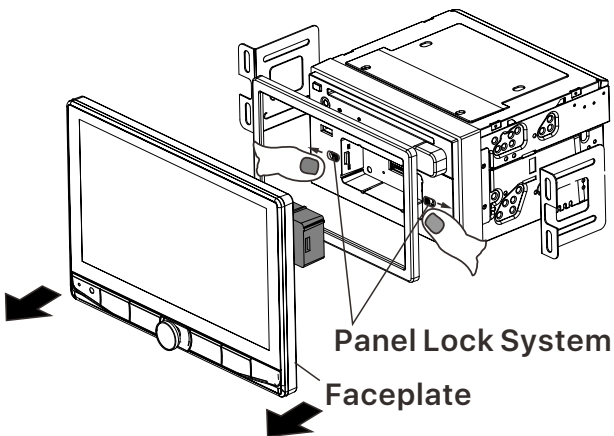

1. Pull and release the panel lock system.
2. Pull out the faceplate.

Note: Please note this faceplate is not designed for detachable. Disconnect / Connect the screen connector **ONLY** for installation in the vehicle.

Parking wire

Note: The parking wire is connected with brake signal; for safety, the programs can be seen on the monitor after braking the car..

Note: To watch video the parking wire should be connected to brake signal.

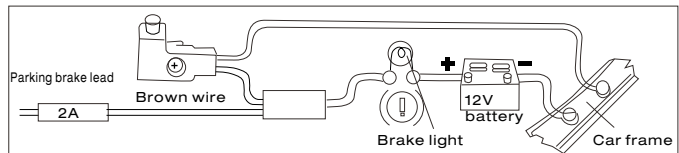

Connecting the reversing line to taillight on the car

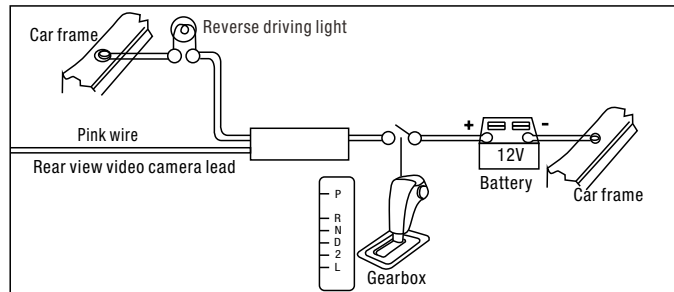

After connecting, when you start up the reverse gear, the unit will receive the picture from car rear view camera.

Speaker Connection

Connect the speakers according the following diagram, incorrect connections will damage the unit or your loudspeakers

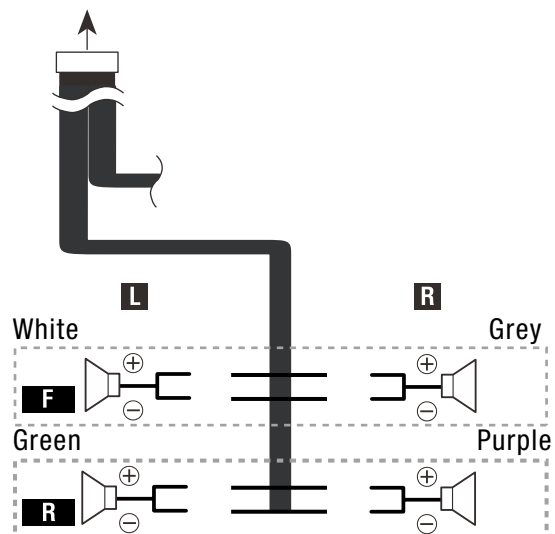

3. Wiring

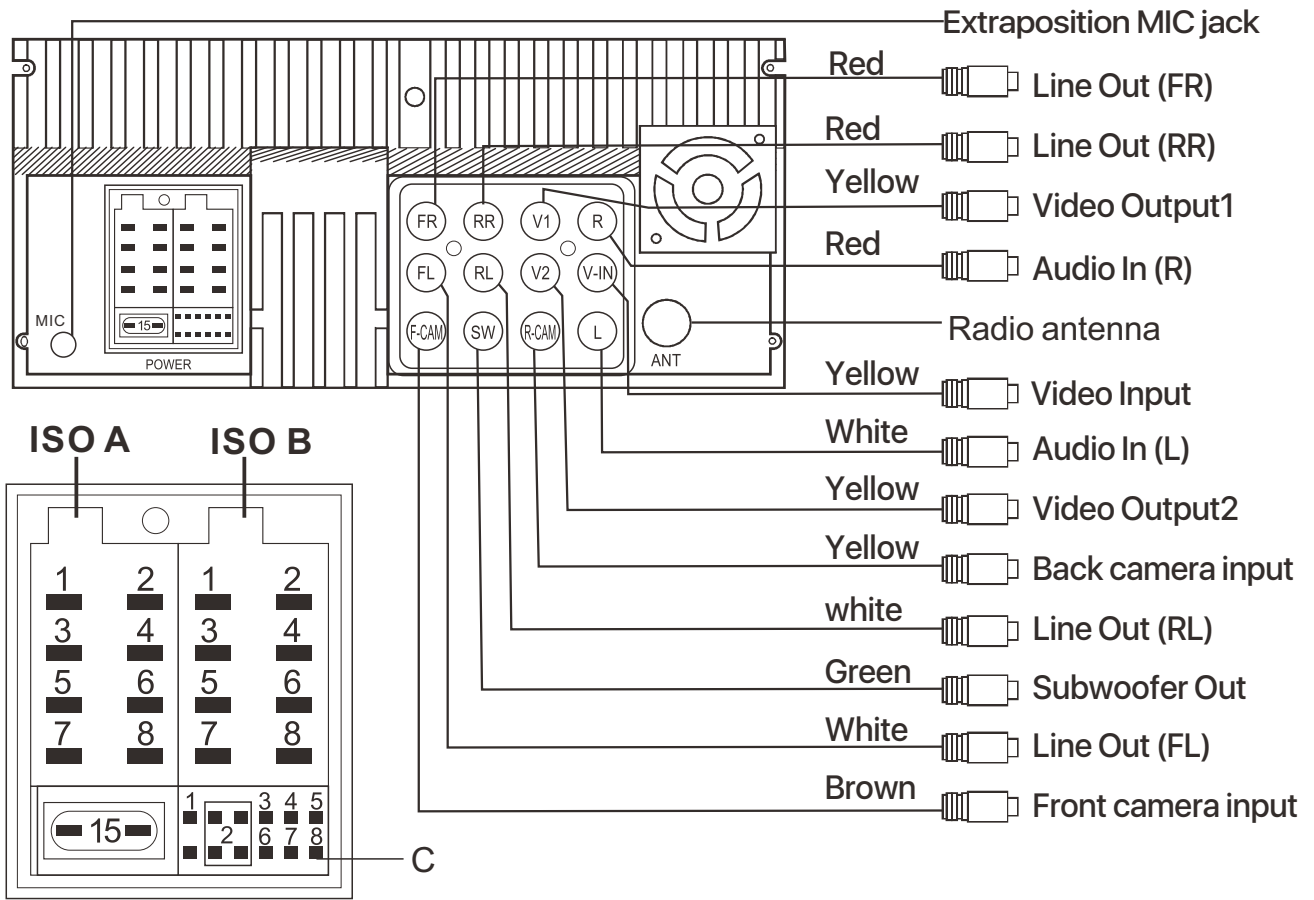

Portion		Colour	Connection
ISO A	A3	Yellow	Battery B+
	A5	Orange	ILL B+
	A6	Blue	Antenna
	A7	Black	Ground
	A8	Red	ACC B+
ISO B	B2	Purple	Rear right speaker(+)
	B1	Purple / Black	Rear right speaker(-)
	B4	Grey	Front right speaker(+)
	B3	Grey / Black	Front right speaker(-)
	B6	White	Front left speaker(+)
	B5	White / Black	Front left speaker(-)
	B8	Green	Rear left speaker(+)
B7	Green / Black	Rear left speaker(-)	
8 Pin connector	C1	Blue / White	Amplifier control(B+)
	C3	Brown	Brake detect (Ground)
	C4	Pink	Back car control(Back camera B+)
	C5	Pink / Black	Front camera(B+)
	C6	Black	Ground
	C7	Green	Steering Wheel 2
	C8	Grey	Steering Wheel 1

4. Front panel Description

Front panel

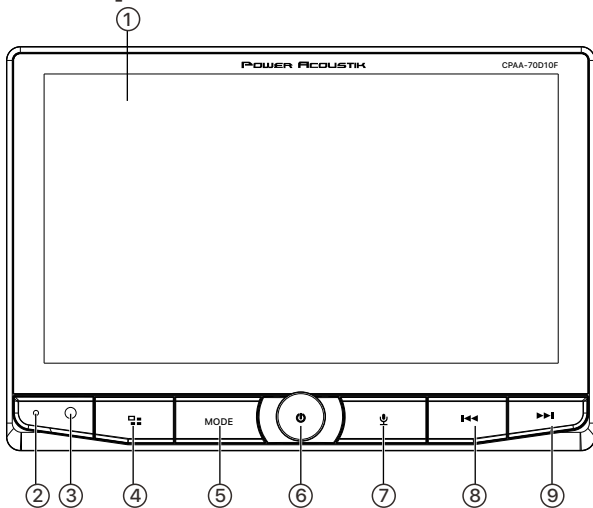

- ① 10.6 inch TFT LCD

- ② Mic
Build in Microphone.

- ③ IR Sensor of Remote
IR remote control signal receiving window.

- ④ MENU button
Press to back to Main menu.

- ⑤ MODE button
Press to select desired mode.

- Rotary Control
On/Off button
Short press to switch On the source unit.
Long press to switch Off the source unit.

- ⑥ In operation, short press to Mute the sound system, press again to Un-Mute.
In operation, rotate to adjust the sound output level.

- ⑦ Siri button
When Apple CarPlay or Android Auto available, hold Siri button to start the voice control function.

- ⑧ ◀▶ button
- ⑨ [Radio] Press repeatedly to fine tune the radio frequency upward or downward.

Press and hold to tune the radio frequency to the upward or downward station for broadcasting.

[Disc/USB/SD Music] Press repeatedly to shift track previous or next for playback. Press and hold to active various fast rewind or fast forward speeds for playback.
[Bluetooth Music] Press repeatedly to shift track previous or next for playback.

Base:

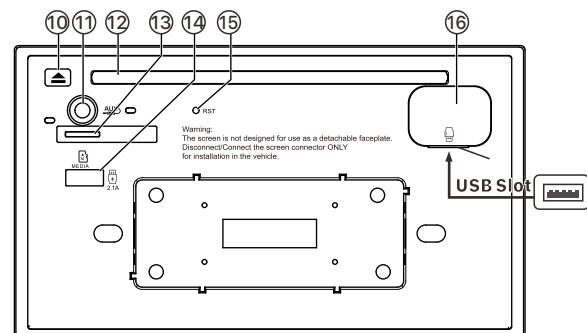

- ⑩ Eject Button
Press to eject the disc.

- ⑪ AUX in jack
Insert an external device to this port in order to have sound output of that external device through the unit.

- ⑫ Slot-in
Insert or eject the the disc.

- ⑬ Micro SD slot
Insert micro SD for playback.

- ⑭ Fast charging USB port
Support fast charge USB port.

- ⑮ Reset button
Press to default factory settings.

- ⑯ USB port
Connect USB for digital playback. Connect your iPhone for Apple CarPlay.
Connect your Android Phone for Android Auto.

5.REMOTE CONTROL

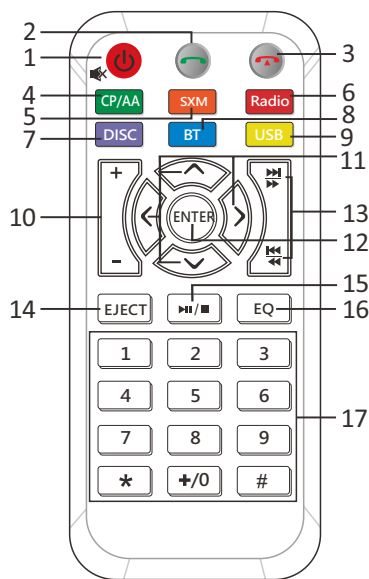



1.  Press and hold to power it on or off. Short press this button mute the volume output when unit turn on. Long press is Power OFF function when unit turn on.

2.  [Bluetooth]: Press it to make a call after inputted a phone number or answer an incoming call.

3.  [Bluetooth]: Press it to reject a coming call or hangup while calling

4.  Press it to switch to CarPlay or Android Auto mode; Head Unit will show string "invalid operation" when CP/AA is not plugged in Head Unit.

5.  Press it to switch to SXM mode.

6.  Press it to switch to RADIO mode.

7.  Press it to switch to DVD mode.

8.  Press it to switch to Bluetooth mode.

9.  Press it to switch to USB mode.

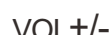
10.  Press it to increase or decrease the volume level.

11.  It is UP /Down/Left/Right Arrow, use this button to select the menu item, the title track or to show next frame.

12.  Press it to confirm selection.

13.  [DVD/USB/SD]: short press it to skip to the next track or previous functions.
long press to activate fast forward or fast review in a track.
[Bluetooth Music]: short press it to skip to the next track or previous functions.



14.  Press it to eject the disc.

15.  [DVD/USB/SD]: short press it to switch play or pause.

16.  Press it to Equalizer functions .

17.  0-9
*

[Radio]: Select 1-6 desired preset station.
[DVD/SUB/SD]:Input 0-9 for selecting track number.
[BT Phone]:Input 0-9*/# for desired phone number.

Note: 1. SXM just for include SiriusXM function models.
2. * #   these functions for Bluetooth.

6.MAIN MENU

CPAA-70D10F is a 2-DIN car audio with following functions:

Apple CarPlay, Google Android Auto, Radio, Disc, Bluetooth, USB, SD.

The Mode icon in gray means the corresponding function is not ready or proper device have not been connected.

Touch the corresponding Mode icon to enter playing mode.



without Apple CarPlay



with Apple CarPlay



with Android Auto

 Setup, to enter the Settings Menu.

 Turn off TFT display.
TFT enter black mode touch any zone return to TFT on.

7.Settings

Touch the  icon to enter the Setup menu.

The Setup menu is included Time Settings, Audio Settings, Disc settings, General Settings, Wallpaper Settings.

Time Settings

The Time Settings allow the user to set Date & Time.

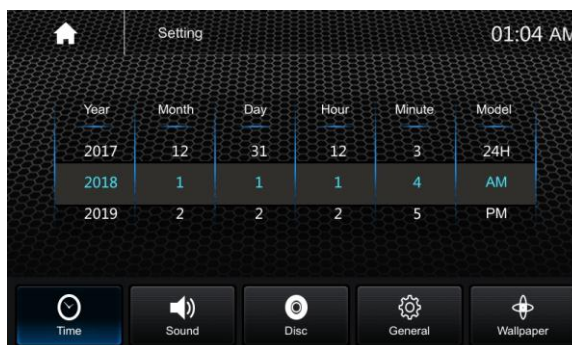

Audio Settings

Below shown is the Audio Setting Menu.

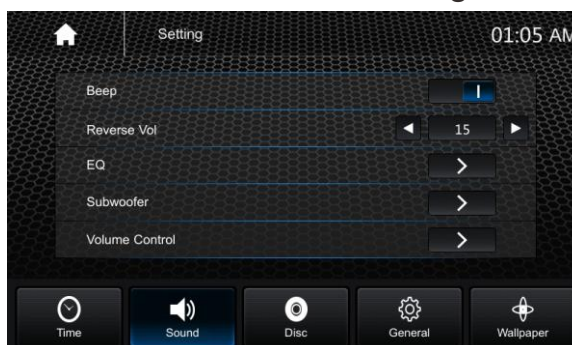

EQ Settings

Balance/Fader:

Touch the "+" or "-" of Balance /Fader to tune for the driver and passenger preference.

The value of Balance (Left15-Right 15) and Fader (Front 15- Rear 15).

Touch Reset to set both Balance and Fader to 0.

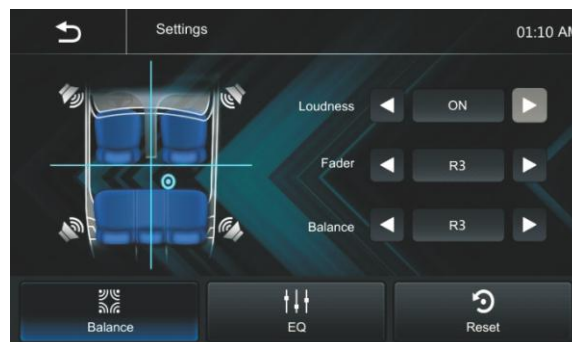

7.Settings

10-Band Equalizer:

10 band of EQ tuning, slide the EQ bar to tune each band frequency level according to user preference.

Touch Reset to set all Band to 0 .



Disc settings:





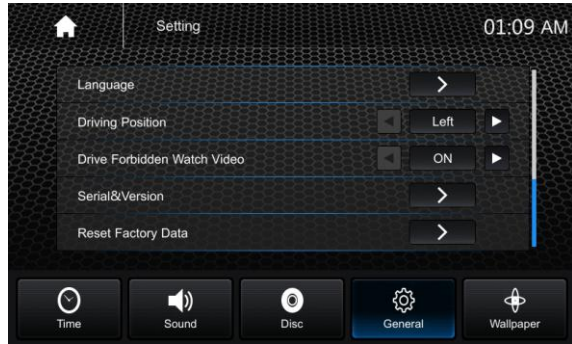
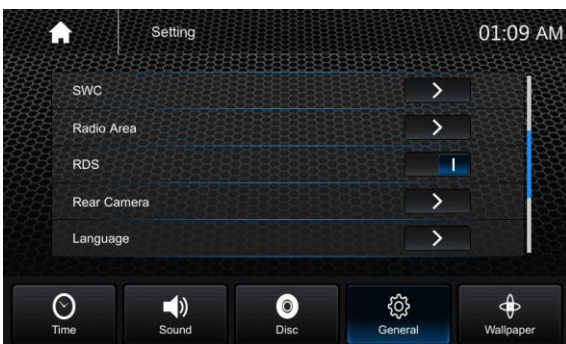
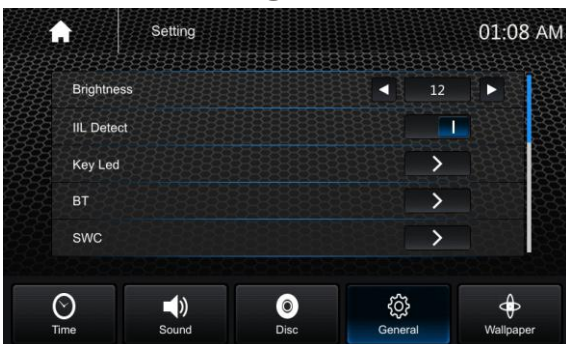

General settings:

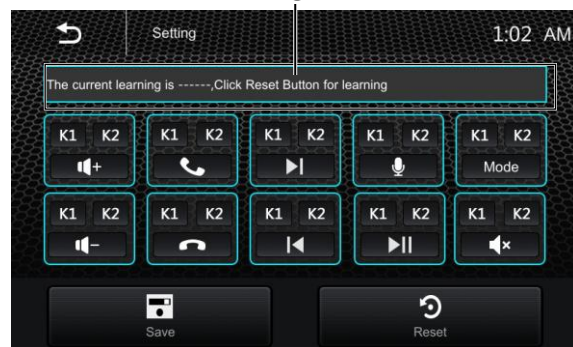
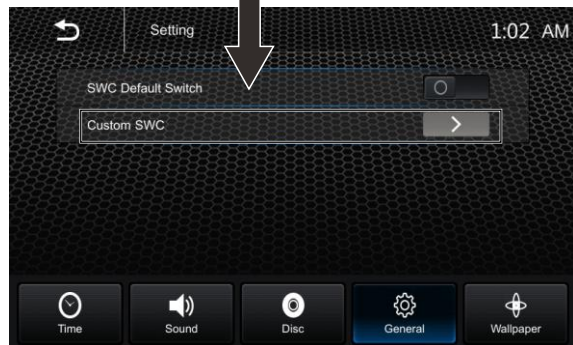
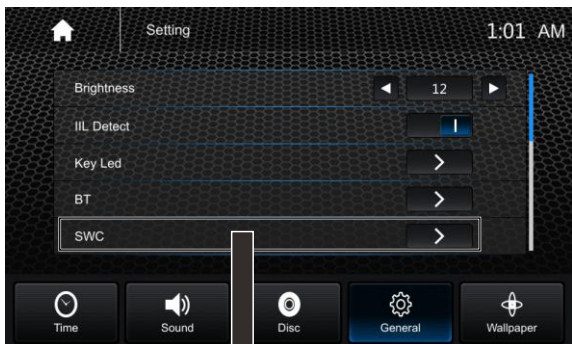

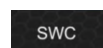
Steering Wheel Control Settings

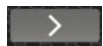

-  Touch SWC for steering wheel control setting.
-  Click SWC Default Switch to be "on" status.
-  Click Custom SWC to SWC study mode.
-  Press the steering wheel control button of the car first and then touch the corresponding button on player screen for learning and setting.

7.Settings



Touch Save to confirm the setting



Touch Reset to erase and reset the setting

Radio Area:

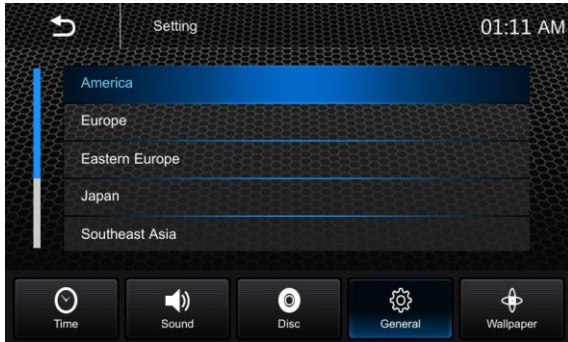

Serial & Version:

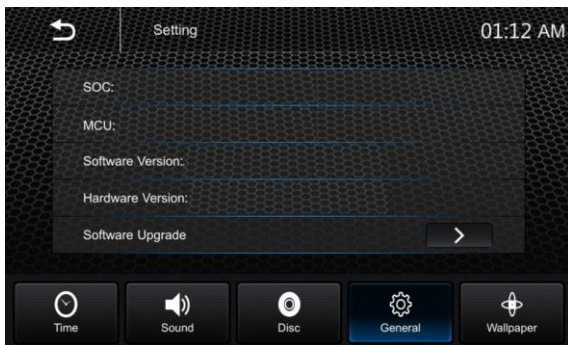

Wallpaper:

User can select the preset wallpaper.

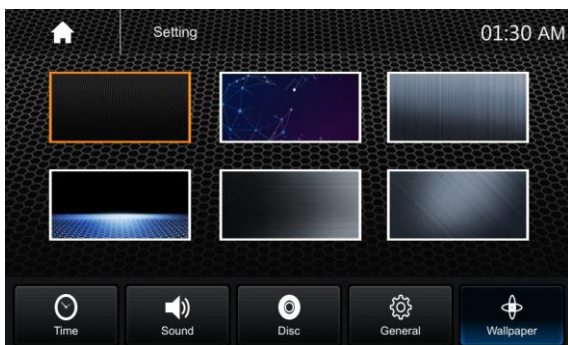

Touch the corresponding picture to select the prefer background.

8.CarPlay & Android Auto

8.1 Apple Carplay

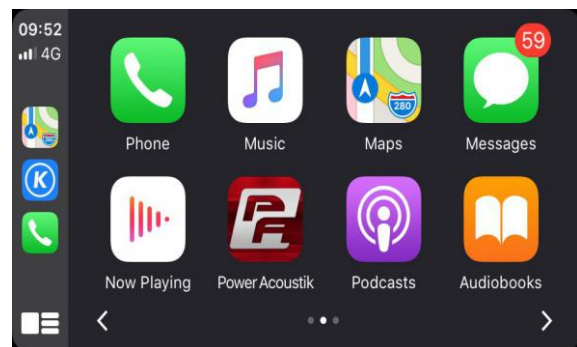

Plug the iPhone (iPhone 5 or latter models, and IOS 7.1 or above) through the lightening cable to the USB port of the source unit. The iPhone will be shown the "CarPlay". The source unit will enter the CarPlay interface, the APP that support the CarPlay feature will be displayed on the source unit as shown below. Touch the corresponding

APP can operate, touch  button to go back the CarPlay interface.



Siri

In Carplay mode, user can talk to SIRI to

control the CarPlay functions. Press  to start the SIRI function, or touch the  button for 2 seconds or the HOME button of iPhone. Now you can talk to Siri for playing music, I am going....

Note: For SIRI function in the source unit, the Micriphone has to be connected.

In CarPlay mode, touc"Home" button or

 icon to go back the main menu of source unit.

8.2 Android auto Operations

Android Auto enables you to use functions of your Android device convenient for driving. You can easily access route guidance, make calls, listen to music, etc. For details about Android Auto, visit <https://www.android.com/auto> or <https://support.google.com/androidauto>.

Compatible Android devices

You can use Android Auto with Android devices of Android version 5.0 or later.

Note: Android Auto may not be available on all devices and is not available in all countries or regions.

Operations:

1. Connect an Android device via USB terminal. To use the hands-free function, connect the Android device via Bluetooth. When an Android device compatible with Android Auto is connected to USB terminal, the device is connected via Bluetooth automatically, and the Bluetooth smartphone currently connected is disconnected.
2. Unlock your Android device
3. To enter Android Auto mode, touch Android Auto icon in the head unit screen. You can perform the operations of the Apps of the connected Android device.
4. In Android Auto model, touch "Home" to the head unit main menu.

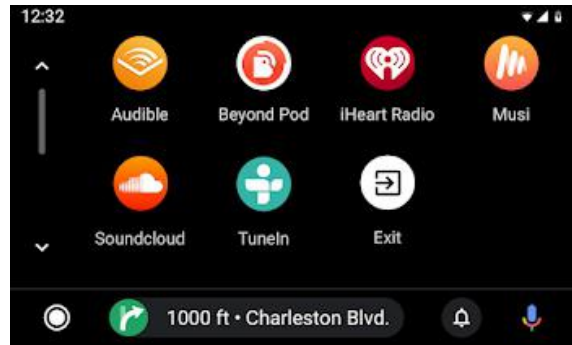

Radio mode

Touch the Radio mode icon to enter Radio.



- FM1** Touch FM1 to select FM1 Band.
- AM1** Touch AM1 to select AM1 Band.
- BAND** Touch to select Band, FM1>FM2 >FM3>AM1>AM2
- AS/PS** Touch to auto scan searching.
- EQ** Touch to enter EQ settings.
- LOC(DX)** Touch to switch LOCAL or DX.
- GOTO** Touch to input tune directly.
- Seek-** Short touch to Tune-, long touch for Seek-
- Seek+** Short touch to Tune+, long touch for Seek+
- 87.50MHz** Preset station, 6 preset store and recall station for each band.

10.USB







Store a Station

1. Tune radio to desired station.
2. Touch and hold the one of the preset station for more than 3 seconds, then the preset button will be highlighted on the screen, and the preset station will be stored.

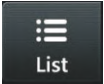
USB

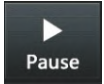
Plug the USB, the USB icon will be colorful. Touch the USB icon to enter the USB playback mode. The source unit default the play the Audio in the USB device.

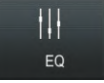

-  Press to list Audio, Video, Picture files in USB.
-  Short press to skip previous track, Long press to fast reverse.
-  Play or pause button.
-  Short press to skip next track, Long press to fast forward.
-  Press to switch Random is On or Off.
-  Press to select Repeat All > Repeat 1> Repeat folder> Repeat Off.
-  Press to select Audio setting or set the prefer EQ of each band in custom mode.



11.DISC

File List browsing

Touch  to browse the folder and file list of the USB device.

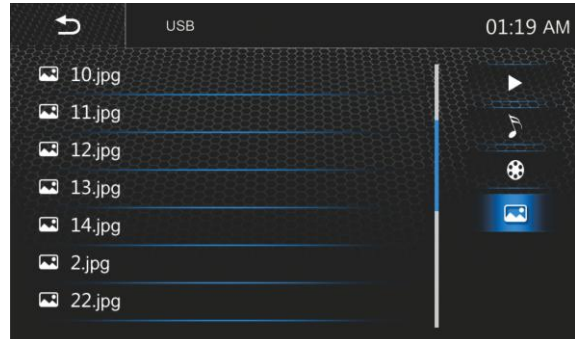

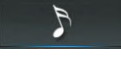
You can select the multi-media type.

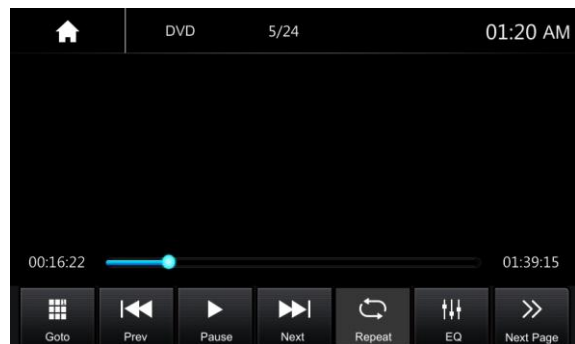

-  Return to playing previous file.
-  Select Audio or Music files.
-  Select Movie or Video files.
-  Select Picture files.

DISC

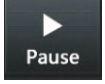
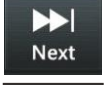
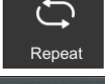
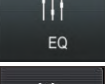
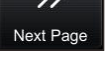

-  Touch to handle goto selecting.
-  Touch to select previous chapter.
-  Play or pause button.
-  Touch to select next chapter.
-  Press to select Repeat All > Repeat 1> Repeat folder> Repeat Off.
-  Press to select Audio setting or set the prefer EQ of each band in custom mode.
-  Touch to select second page buttons.

12. Bluetooth Audio

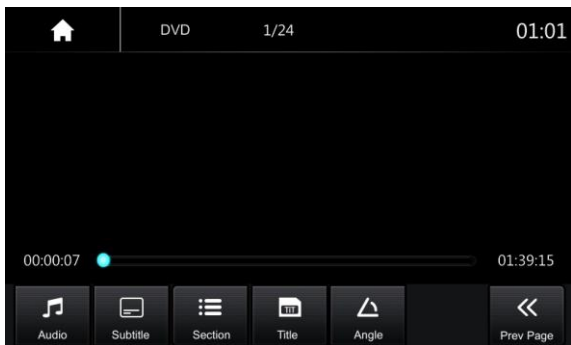

Touch to select audio language.

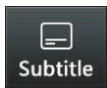

Touch to select subtitle language.

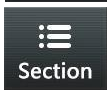

Touch to select section.

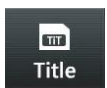

Touch to show title menu.

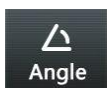

Touch to adjust angle.

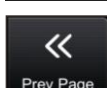

Touch to select the first page of the keypad.



Press to skip previous track

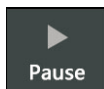

Play or pause button.



Press to skip next track.



Press to switch Random is On or Off.



Press to select Repeat All > Repeat 1> Repeat folder> Repeat Off.

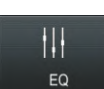

Press to select Audio setting or set the prefer EQ of each band in custom mode.

Bluetooth Connect

If the Bluetooth is not connected, press Re-connect the paired phone or pairing to pair the new device.

Bluetooth Audio

Touch the BT Audio icon to enter Bluetooth Audio playing mode. If the Bluetooth is connected, the music will be playing as following shown;



Bluetooth Audio Playback

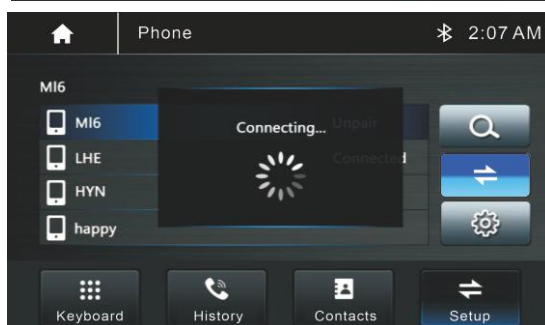
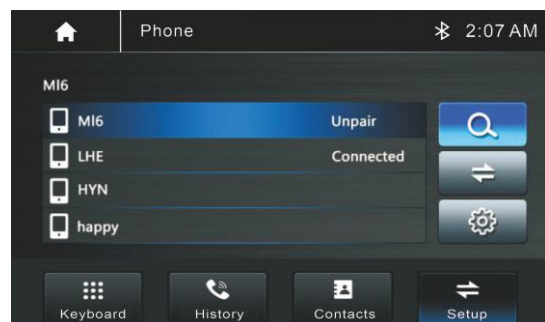
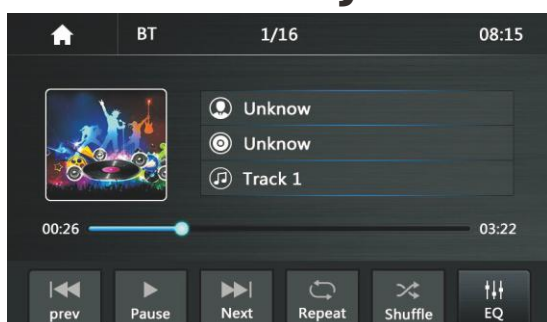

13. Bluetooth Phone

Bluetooth Pairing

Pairing mode screen will be shown as below:

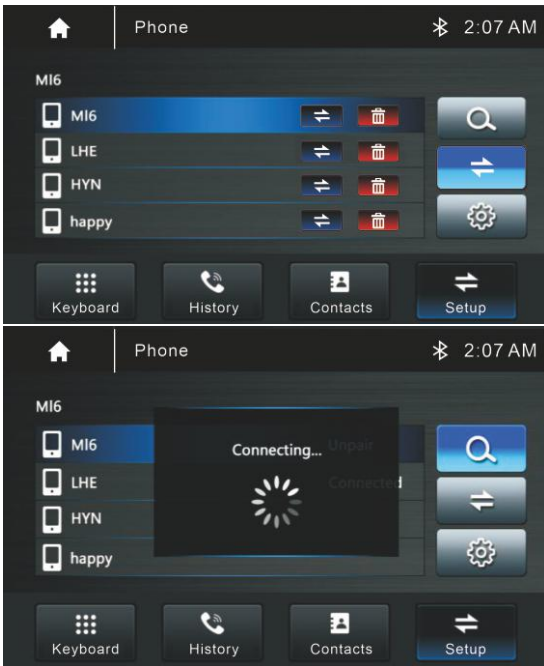





Turn On the Bluetooth of the mobile phone or Bluetooth device, you can see the CPAA-70D10F, select the CPAA-70D10F for pairing and connection.

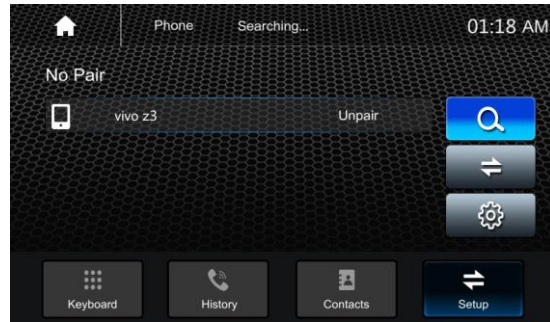

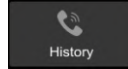
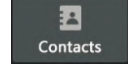
Bluetooth Phone

Touch the Phone icon in main menu to go to Phone mode. After the mobile phone is connected with the source unit via Bluetooth (HFP), user can through the source unit to make a phone call. Please note it needs to connect the microphone for phone call.



-  Dial Pad. tap it to enter call mode.
-  Call logs, to show the call record, missed, received and dialed calls
-  Contact, tap to show the phonebook connected phone.
-  Show the usable devices.
-  BT Setup, tap t set auto answer and load phonebook.
-  Search the available devices.
-  Manage the connected device.

Make a Call

1. Touch the  icon to enter below screen.
2. Using the keypad, touch 0-9,*,#, enter the phone number you wish to dial. If you input an incorrect number, touch the  icon on the keypad to delete the incorrect number.
3. Once the correct number appears on the screen, touch the  icon. To go to dialing interface.



13. Bluetooth Phone

4. To end the call, touch the icon  on the screen.



Receive an incoming call

If the Phone is connected with the source unit via Bluetooth, when an incoming call, below screen will be shown:

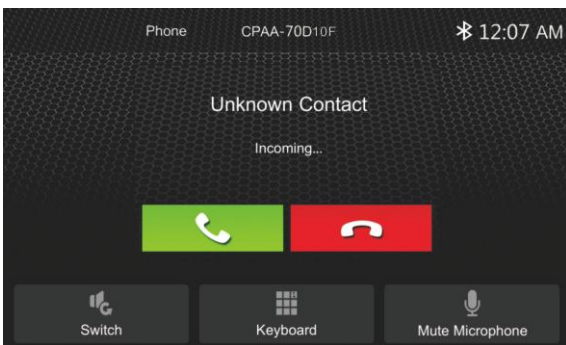

Press  to answer the incoming call.

Press  to reject the incoming call.

Call Logs

Touch the icon  to display the Call combined list.

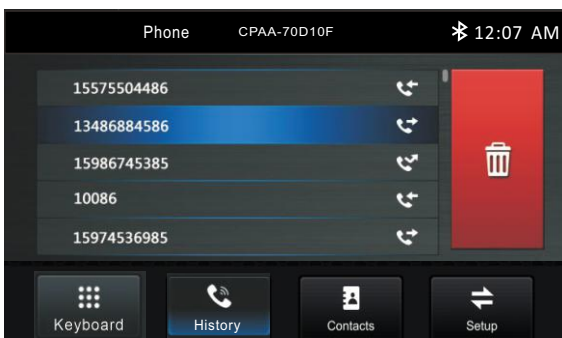

Slide the bar at right side up and down to display a call logs up to 20 records.

Contacts

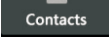
Touch the icon  to access the phone book of the connected mobile phone. To make a call from the phonebook, simply touch the contact name.

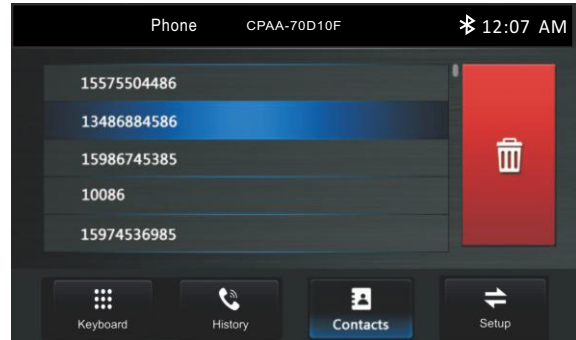

BT Setup

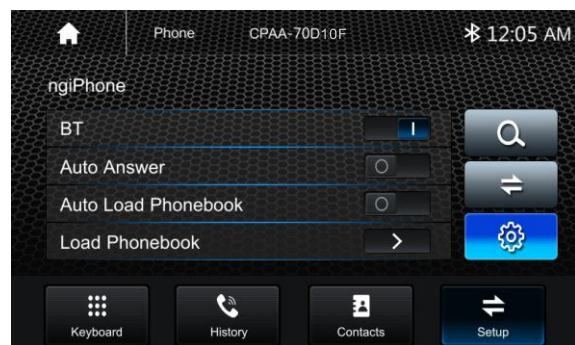

BT On /OFF, Power On or Off BT function.

Auto Answer On /OFF, incoming call auto answer.

Auto Loadpbk, On /OFF, when connectphone auto load phonebook on or off.

Loadpbk, Manually load phone book.

14. Specification

General

Power Supply	DC10~16Volts
Grounding System	Negative Ground
Current Drain	15A(Max.)
Max Power Output	4x75W/channel
RMS Power Output	4x25w/channel
Speaker Impedance	4~8ohms per channel
Frequency Response.....	20Hz~20KHz
Operating Temperature	-20~+60°C
Dimensions	255mm(W)x250mm(D)x175.1mm(H)

TFT Display

TFT Screen size.....	10.6inch
Resolution.....	1024x600 pixels

FM Radio

Frequency Range (USA)	87.5~107.9MHz
Frequency Range (Europe)	87.5~108MHz
Usable Sensitivity (S/N=30dB).....	≤15dB
S/N Ratio.....	≥55dB
Stereo Separation.....	≥30dB

AM

Frequency Range (USA)	530~1710KHz
Frequency Range (Europe)	522~1620KHz
Usable Sensitivity(S/N=20dB).....	≤40dB
S/N Ratio.....	≥45dB

DVD/CD

S/N Ratio.....	≥60dB
Channel Separation	>50dB

Line-Out/Subwoofer Output

Maximum Output Level (10K ohms load).....	≥4Vrms
Subwoofer Time Align.....	0~18ms

15.AV IN

The Audio/Video source with RCA cable can through the source unit to play the Audio/Video. Plug the RCA to the corresponding A/Vsocket.

Touch the icon  to view the playing Audio /Video.



The Audi and Video will via the RCA cable to the source unit.

WARNING! Changes or modifications to this unit not expressly approved by the party responsible for compliance could void the user's authority to operate the equipment. NOTE: This equipment has been tested and found to comply with the limits for a Class B digital device, pursuant to Part 15 of the FCC Rules. These limits are designed to provide reasonable protection against harmful interference in a residential installation.

This equipment generates, uses and can radiate radio frequency energy and, if not installed and used in accordance with the instructions, may cause harmful interference to radio communications.

However, there is no guarantee that interference will not occur in a particular installation. If this equipment does cause harmful interference to radio or television reception, which can be determined by turning the equipment off and on, the user is encouraged to try to correct the interference by one or more of the following measures:

- Reorient or relocate the receiving antenna.
- Increase the separation between the equipment and receiver.
- Connect the equipment into an outlet on a circuit different from that to which the receiver is connected.
- Consult the dealer or an experienced radio/ TV technician for help.