

POWER ACOUSTIK®

PD-651B

2Din 7" Monitor

Touch Screen

DVD/CD/MP3/MP4/USB

AM/FM Radio

With Android Phone Link

With Bluetooth



Owner's Manual

Take the time to read through this owner's manual.

Familiarity with installation and operation procedures will help you obtain the best Performance from your new DVD-receiver.

IMPORTANT NOTICE & PRECAUTIONS

Thank you for using our company multi-media player! To operate the unit correctly, please read the operation manual carefully before using. Keep this operation manual for further reference.

The unit is designed only for DC 12V negative ground operation system. Make sure your vehicle is connected to DC 12V negative ground electrical system. Be sure to connect the speaker (-) leads to the speaker (-) terminal. Never connect the left and right channel speaker wires together or to the vehicle body.

The normal temperature for operation is between -20 and +60 degree Celsius. Do not work in extreme high or low temperature and block vents or radiator panels of the unit, blocking them will cause heat to build up inside the unit and may cause damage or fire.

This unit can play the following discs (12 cm) and media files: DVD±R/RW / MPEG 4 / DivX / AVI / SVCD / VCD / MP3 / WMA / CD-R/RW / JPEG.

This operation manual shows the full version of this unit. GPS navigation system; analog TV tuner; AM radio; mobile phone mirror linking, external microphone connection & external steering wheel control connection are the optional features of the software and may not be included in this unit. Referred to the exact functions & features that equipped with this unit for operation.

INSTALLATION

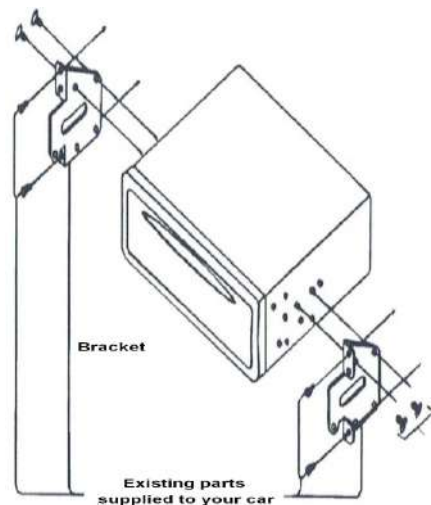

Notes:

- Installation varies on type of cars and supplied parts
- Store small articles in places not accessible to children
- Install only with the supplied screws
- Installation of unit by professional technician is strongly recommended

Remarks:

Mounting brackets and screws are the parts that supplied in your car and not provided in this unit.

Note: Specification and design; functions and features; unit illumination; colour and display segment are subject to change without prior notice. Photos and drawings on gift box or operation manual might be varied from the exact unit. Depends on the input devices, operation might be varied from the operation manual described.

SIMPLE TROUBLE SHOOTING

PROBLEMS, CAUSES & SOLUTIONS

No power

- Check and make sure the connecting wires are connected correctly
- Check whether the fuse is blown. Replace with the proper value fuse if necessary.

No sound

- Check and make sure the speaker wires are connected correctly.

No picture

- Check whether the video wire is connected to the video device.

Unit hang-up

- Press the RESET button to reset the unit to its default stage.

No function when pressing the buttons or TFT screen

- Press the RESET button to reset the unit to its default stage.

Poor effect or unable to receive radio / TV

- Check whether the radio/ TV antenna is inserted or properly connected.
- Antenna may not be the proper length. Make sure the antenna is fully extended.
- Antenna may be poorly grounded. Check and make sure the antenna is properly grounded.

Stereo cannot be received under radio mode

- Tune the radio frequency accurately.
- The broadcasting signal is too weak, set the mode to MONO.

Disc inserted but cannot play

- Check whether the disc inserted upside down.
- Check whether the disc is dirty or badly cracked.
- Lens is dirty. Clean lens by using the lens clean disc.

Abnormal moving, skipping or sound during playback

- The disc is dirty or damaged. Wipe the disc with a dry soft cloth or replace a new disc.

Remote handset does not work

- Replace new battery of the remote handset.
- Point the remote handset directly at the remote sensor of the main unit.
- Clean the surface of the remote sensor.

Bluetooth not operated

- check the devices are linked up correctly.

Picture without colour or no sound under disc / TV mode

- Improper setting of colour system at TV mode. Set again to "PAL"; "SECAM" or "NTSC"

GPS not operated

- check micro SD card with navigation software (map) has been inserted into SD card port for GPS.
- check GPS antenna connected properly.

Note

After the above efforts, if the unit still cannot be worked normally, consult your service dealer. Never attempt to disassemble the unit by yourself. No service part inside the unit.

IMPORTATION NOTICE FOR ON SCREEN OPERATION

Interfaces, photos, images, icons & location as shown in this part of operation manual may be varied from the exact unit. However, all of them come with similar outlook of the same type and with the same operation method.

SPECIFICATION

GENERAL

Power Requirement:	DC 12 Volts, negative ground
Load Impedance:	4 Ohms
Maximum Power Output:	40 watts x 4 (RMS)
Tone Control – Bass (at 100 Hz)	+/- 8 dB
Treble (at 10 KHz)	+/- 8 dB

AM RADIO SECTION

Frequency Range	530 – 1710 KHz (America)
	530 – 1710 KHz (Latin America)
	522 – 1620 KHz Asia
	522 – 1710 KHz (Australia)
	522 – 1620 KHz (Europe)
	522 – 1629 KHz (Japan)
	522 – 1620 KHz (Middle East)
	522 – 1620 KHz (Oirt)

FM RADIO SECTION

Frequency Range	87.5 – 108 MHz (Asia)
	87.5 – 108 MHz (Australia)
	87.5 – 108 MHz (Europe)
	76 – 90 MHz (Japan)
	87.5 – 108 MHz (Middle East)
	65 – 74 MHz (Oirt)
	87.5 – 107.9 (America)
	87.5 – 108 MHz (Latin America)
Signal to Noise Ratio	60 dB
Stereo Separation (at 1 KHz)	30 dB

DISC SECTION

Disc Play:	DVD / VCD / MP3 / CD
Mounting Angle:	+/- 30 degree

VIDEO & TV SECTION

Video System:	NTSC
Video Output Level:	1.0Vp-p 75 Ohms
Horizontal Resolution:	500
TV System	NTSC / PAL / SECAM

BLUETOOTH SECTION

Communication type:	V4.0
Maximum Distance:	5 meters

AUDIO SECTION

Maximum Output Level:	2 Vrms (+/-3 dB)
Frequency Response:	20 Hz to 20 KHz
Signal to Noise Ratio:	85 dB
Channel Separation:	80 dB

WIRING CONNECTION

POWER ACUSTIK® CD/DVD/Bluetooth/MP3/AM/FM-Stereo

PD-651B Designed and Engineered in U.S.A., Made in China

CAUTION: + 12V DC Negative Ground FM: 87.5-107.9MHz AM: 530-1710KHz

Please remove the screws before installation

1. Brown : Brake (B-) 11. Pink : Back Sight (B+)

2. Green : Steering Wheel Control (2) 12. Grey : Steering Wheel Control (1)

3. Black/Fine : Steering Wheel Control (Ground) 13. Pink/Black : Front Camera (B+)

4. Orange : Headlamp Detection 14. Blue : Amplifier Control (B+)

(Connect to on/off control of car headlamp) 15. Yellow : Memory Back Up (B+)

5. Blue/White : Auto Antenna (B+) 16. Black/Coarse : Ground (B-)

6. Red : Ignition Switch (B+) 17. Purple/Black : Rear Right Speaker (-)

7. White/Black : Front Left Speaker (-) 18. Purple : Rear Right Speaker (+)

8. White : Front Left Speaker (+) 19. Green/Black : Rear Left Speaker (-)

9. Grey/Black : Front Right Speaker (-) 20. Green : Rear Left Speaker (+)

10. Grey : Front Right Speaker (+)







SW: (Green) Sub-woofer output
V1: (Yellow) Video output
V2: (Yellow) Video output
FL: (White) Front left speaker output
RL: (White) Rear left speaker output
F-CAM: (Brown) Front camera input
RR: (Red) Rear right speaker output
FR: (Red) Front right speaker output
R-CAM: (Yellow) Back sight camera input
G: (GPS) GPS antenna input
MIC: (MIC) Extraposition MIC(optional)
TV: (TV) TV antenna (optional)
ANT: (ANT) Radio antenna
W/R: (W/R) Steering wheel control input(optional)

MAIN UNIT OPERATION

Symbol / Function

Operations & Controls

RES / RST	Press with a pointed object (such as a ballpoint) to reset the unit to its initial setting by the factory (default stage).
/ POWER	When the unit is turned off, press to turn on the unit. When the unit is turned on, press & hold shortly to turn off the unit.
MODE / MOD / SRC	Press repeatedly to select the desired mode for operation.
M/N / MENU	Press to shift screen between MAIN MENU or GPS MAIN MENU (for unit equipped with GPS navigation system) & current operation mode.
VOL / VOL+ / VOL- / VOLUME	For rotary control version, rotate to adjust sound output level. For keys control version, press repeatedly to adjust sound output level.
MUTE /	Press to turn on or off of sound mute control.
EQ	Press repeatedly to select the desired preset equalization mode.
LOUD	Press to turn on or off of loudness control.
IR	Remote control sensor for signal reception from remote handset.
AUX	Insert an external device to this jack in order to have sound output of that external device through the unit.
USB	Insert USB device to this slot for digital files playback.

MICRO SD / SD / MINI SD / 	Insert micro SD card to this port for digital files playback.
GPS / MAP / 	Insert micro SD card installed with navigation software to this port for operation under GPS mode (available for unit with GPS navigation system).
BT	Press to shift the current operation mode to Bluetooth mode.
MIC	For voice reception under Bluetooth operation.
DVD	Press to shift the current operation mode to disc operation mode (when a disc has been inserted).
DISC SLOT	Insert or remove disc from this disc slot (when a disc has been inserted).
 / EJECT	Press to eject disc from the disc slot (when a disc has been inserted).
	At disc / USB / SD card input & Bluetooth mode, press to start, pause or resume playback.
BND / BAND	At radio mode, press repeatedly to select radio band for broadcasting. (Note: When the unit is under other operation mode, press to shift current operation mode to radio mode)
	<u>Radio Mode</u> Press repeatedly to fine tune the radio frequency upward or downward. Press & hold shortly to tune the radio frequency to the upward or downward station for broadcasting.
	<u>Disc / USB / SD Input Mode / Bluetooth Mode</u> Press repeatedly to shift track upward or downward for playback. Each time press & hold shortly to activate various fast forward/rewind speeds for playback. (Note: Fast forward or fast rewind is not available at Bluetooth mode & picture playback mode)
	<u>TV Mode</u> Press to tune TV channel upward or downward for broadcasting. Press & hold shortly to tune the TV frequency upward or downward and stop for broadcasting when a TV channel received.
-TUN+ / ENT	<u>Radio Mode</u> Rotate to turn the radio frequency to the upward or downward preset station for broadcasting. <u>DVD Mode</u> At DVD menu/title display mode, rotate to select the desired setting/setup and press to confirm/enter. (Note: Depends on the input DVD, this function may not be available for operation) <u>Folder / Playlist Mode</u> During folder/playlist display at media playback mode, rotate to shift up or down on playlist, press to confirm/enter. (Note: Depends on the input media, these function may not be available for operation)
TFT SCREEN	It shows the status of operation on the unit. This screen is also a touch display – soft touch the screen for different operations of unit (refer to other parts of this manual for operation details).

Note

The above mentioned symbols / functions / operations & controls show the operations for various versions of the unit and may not be equipped or available for control in this unit. Printings and symbols on the above may be varied from the exact main unit. Referred to the main unit for exact functions and features that applied. User is highly recommended to use the touch screen control to operate. Most of the operations of this unit cannot be controlled by the main unit.

- Touch to shift to **USB DEBUG MENU** and follow the information to have USB debug on the mobile phone before connecting again.
- Touch to return to **SETUP MENU**.
- Touch to exit mobile phone linking operation and shift to previous operation mode.
- Touch to shift to **MAIN MENU** for various operation and setup.
- Touch to shift to Bluetooth mode for operation (available when a mobile phone connected).
- Touch to activate audio & visual setting for various audio & visual setup (refer to ON SCREEN – AUDIO & VISUAL SETTING for details).
- Touch to turn off the screen. When the screen turned off, touch any portion of the screen to turn on the screen.

Important notice on mobile phone linking operation on Android devices:

- This head unit supports Android phone up to version 6.0 with USB mirror linking function only.
- USB cable should be used to connect the phone to the front USB slot of the head unit.
- In case connecting failed, **CONNECT FAILURE MENU** appeared on screen. Refer to its detail and **USB DEBUG MENU**, follow the step in order to have set up of the phone (USB debug).
- Phone set up will be varied from different phones. Refer to the operation method of the phone for detail (usually at setting mode → developer options → USB debugging).
- Depends on the connected smart phone, operation & setting may be varied.

Floating dock operation under mobile phone linking:

During mobile phone linking and when this floating dock icon appeared on screen, touch to activate **FLOATING DOCK MENU** on screen for various functions and controls of the unit. This menu will be closed when no operation for a while. Touch any blank portion on screen will also close this menu.

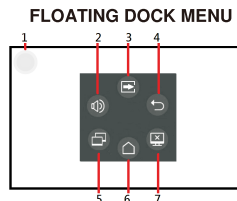

- Touch to activate **FLOATING DOCK MENU** on screen for various functions and controls of the unit. Hold & slide can move this icon to other desired position on the screen.
- Touch to activate audio & visual setting for various audio & visual setup (refer to ON SCREEN – AUDIO & VISUAL SETTING for details) of the car unit.
- Touch to shift screen to the **MAIN MENU** of the car unit.
- Touch to shift screen to previous page of the connected phone.
- Touch to shift horizontal / vertical viewing of the connected phone.
- Touch to shift screen to the main menu of the connected phone.
- Touch to turn off the screen. When the screen turned off, touch any portion of the screen to turn on the screen.

	<u>TV Mode</u> Press directly to input the channel number for broadcasting
ZOOM	<u>Disc / USB / SD Input Mode</u> At video & photo playback, each time press & hold shortly to select various zoom in and zoom out of screen for viewing.
Q	<u>Radio Mode</u> Press to start scanning all the preset stations on memory and stop for a few seconds for broadcasting. Press & hold shortly to start searching the frequency and storing the strongest signal stations into the preset memory stations number 1-6. After storing the stations, the unit starts scanning all the preset stations on memory and stop for a few seconds for broadcasting.
BND	<u>Radio Mode</u> Press repeatedly to select the desired radio band for broadcasting.
■	<u>Disc / USB / SD Input Mode</u> At playback mode, press to stop playback and shift to playlist for playback selection (depended on the input device, playlist may not be available). Note: Not available for control at music playback mode
☎	<u>Bluetooth Mode</u> Press to hang up or refuse an incoming call.
RDM	At disc / USB / SD input playback mode, press & hold shortly to turn on or off of random playback of the input device. (Note: Not available at photo playback mode)
INT	At music playback mode, press & hold shortly to turn on or off of intro playback of the input device. (Note: Not available at Bluetooth mode)
▶	At disc / USB / SD / input & Bluetooth mode, press to pause, resume or start playback.
▲/▼/▶/◀	<u>DVD Mode</u> At DVD menu/title display mode, press to select the desired setting/setup and press ENT to confirm/enter.
◀	Long press the button to adjust the view angle
▶	Long press the button to open or close the panel
	<u>Folder / Playlist Mode</u> During folder/playlist display at media playback mode, press repeatedly to select track for playback. Once selected, press ENT to confirm.
	<u>Photo Playback Mode</u> Press to rotate photo position or show up-down, left-right mirror image.
ENT	<u>DVD Mode / Folder/Playlist Mode</u> At DVD menu/title display mode as well as folder/playlist display at media playback mode, press ▲/▼/▶/◀ to select the desired setting/setup and press ENT to confirm/enter.

~ The following shows the control option:



1. Radio band selection
2. Adjust the volume up or down
3. Adjust the EQ selections
4. Selection of operation mode
5. Mute function
6. Upward operation
7. Playback/pause control
8. Downward operation
9. Back to homepage
10. Setting

Remarks: The operation under this application is limited to some modes & controls only.

ON SCREEN – AUXILIARY INPUT OPERATION



At **MAIN MENU**, touch to shift to auxiliary input operation (provided an auxiliary video device had been connected). At auxiliary input operation, touch any portion of screen to activate **AV INPUT MENU** for operation.

AV INPUT MENU



1. Touch to turn off the screen. When the screen turned off, touch any portion of the screen to turn on the screen.
2. Touch to activate audio & visual setting for various audio & visual setup (refer to **ON SCREEN – AUDIO & VISUAL SETTING** for details).
3. Touch to shift to Bluetooth mode for operation (available when a mobile one connected).
4. Touch to shift screen to **MAIN MENU**.

7. Touch to delete the linked up device.
8. Touch to input the phone number for dial out.
9. Touch to erase the digit input by error.
10. Touch to dial out after input the phone number or redial when no phone number input.
11. Touch to hang up or refuse an incoming call.
12. Touch to shift conversation between mobile phone & Bluetooth of the unit.
13. Touch to turn on or off of sound muting of the microphone.
14. Touch to input digit (for conversation that needs data input).
15. Touch to hang up or refuse an incoming call.
16. Touch to pick up an incoming call.
17. Touch to download/update incoming calls / dial out numbers / missing calls of the connected mobile phone.
18. Touch to show list of missing calls.
19. Touch to show list of incoming calls.
20. Touch to show list of dial out numbers.
21. Touch to shift page up or down.
22. Touch to download/update phone book of the mobile phone to the unit.
23. Touch to start / pause / resume music playback transmitted from the mobile phone.
24. Touch to select upward or downward track for playback.
25. Touch to turn off the screen. When the screen turned off, touch any portion of the screen to turn on the screen.
26. Touch to activate audio & visual setting for various audio & visual setup (refer to ON SCREEN – AUDIO & VISUAL SETTING for details).
27. Touch to shift screen to **MAIN MENU**.

Remarks: Depends on the system language set on the unit, list of phone book / incoming call / dial out call / missing call will not be display correctly.

APPLICATION TO CONTROL THE UNIT VIA BLUETOOTH OF MOBILE PHONE

(Andorid support only)

User can download the following application to the mobile phone in order to have control of the main unit by the mobile phone via Bluetooth. Take your phone and follow the steps:

~ for Android device, search "iCon" from Google Store and after searched, download & install:



~ After installation, open application:



~ The following menu appeared in the mobile phone and you can start control the car unit with this menu (Bluetooth must be connected):



Radio Mode

Press repeatedly to fine tune radio frequency upward or downward.
Press & hold shortly to tune radio frequency upward or downward and stop for broadcasting when a station received.

Disc / USB / SD Input Mode (Playback Mode)

Press repeatedly to shift track upward or downward for playback.
Each time press & hold shortly to activate various speed of fast forward or fast rewind mode. (Note: Not available for operate at photo playback mode)

Bluetooth Mode

Press to shift track upward or downward for playback.

TV Mode

Press repeatedly to shift upward or downward for playback.
Press & hold shortly to turn frequency upward or downward and stop for broadcasting when a channel received.

REP At playback mode under disc / USB / SD input, each time press & hold shortly to activate various repeat playback setting.

ANGLE At video playback mode, each time press & hold shortly to view angle changes in sequential order (available on media files recorded with this features).

TITLE DVD Mode
Press & hold shortly to display on screen the title of the disc for setting/setup.

SUB-T Video Playback Mode
Each time press & hold shortly to select different sub-titles that recoded in the input device or media files.

SLOW At DVD playback mode, press repeatedly to select different speeds on slow motion playback.

VOL + / VOL - Press repeatedly or press & hold to adjust sound output level.

MENU / PBC DVD Mode
Press & hold shortly to display on screen the menu of the entire disc for setting/setup.

VCD Mode
Press & hold shortly to turn on or off of PBC playback.

SETUP During unit operation, press & hold shortly to activate setup menu on screen for various setup of the unit. Press & hold shortly again to return to previous operation mode. (Note: Setup of unit cannot be operated by remote handset. Setup of unit can only be operated by touch screen – refer to ON SCREEN OPERATION for details)



Bluetooth Mode

Press to pick up an incoming call; dial out after input a phone number; redial last dial out number.

⇄ / PHONE

Bluetooth Conversation Mode

Press & hold shortly to shift conversation between main unit and mobile phone.

Remarks: Depends on the input devices & playback media files, operation may be varied or not available for operation.

ON SCREEN – MAIN MENU OPERATION

 During unit operation and when this icon appeared on screen, touch to shift screen to **MAIN MENU** for various operation and setup.



At **MAIN MENU**, touch the icon of the desired mode on screen and the unit will then enter into the mode that selected for operation. If no selection has been made for a while, the unit will shift back to the previous operation mode.

At **MAIN MENU**, touch & hold on the operation icon and slide to left or right will shift screen to another **MAIN MENU** for operation selection.

1. Touch to start radio operation (when the radio antenna connected).
2. Touch to start disc input operation (when a disc inserted).
3. Touch to start mobile phone mirror linking operation (when the mobile phone connected to the front USB port).
4. Touch to start USB input operation (when an USB device inserted).
5. Touch to start Bluetooth operation (when the mobile phone connected)
6. Touch to start auxiliary input operation (when an auxiliary device inserted).
7. Touch to start viewing front camera (when connected to front camera and pink/black wire).
8. Touch repeatedly to select the desired background (wallpaper) of the unit.
9. Touch to activate **SYSTEM SETUP MENU** on screen to have various setup of the unit.
10. Touch to shift back to previous operation mode.
11. Touch repeatedly to select brightness of screen or turn off the screen. Turn off of screen is available under headlamp detection at OFF mode. When the screen is off, touch any portion of the screen to turn it on again. Following preset brightness modes can be selected.



At this mode, brightness of screen is set by the user (user setting). Refer to **ILLUMINATION BACKLIGHT SETUP** under **ON SCREEN – SETUP OPERATION** for details.



12. Touch to activate audio & visual setting for various audio & visual setup (refer to **ON-SCREEN – AUDIO & VISUAL SETTING** for details).
13. Touch to eject the disc from the unit (when a disc has been inserted).

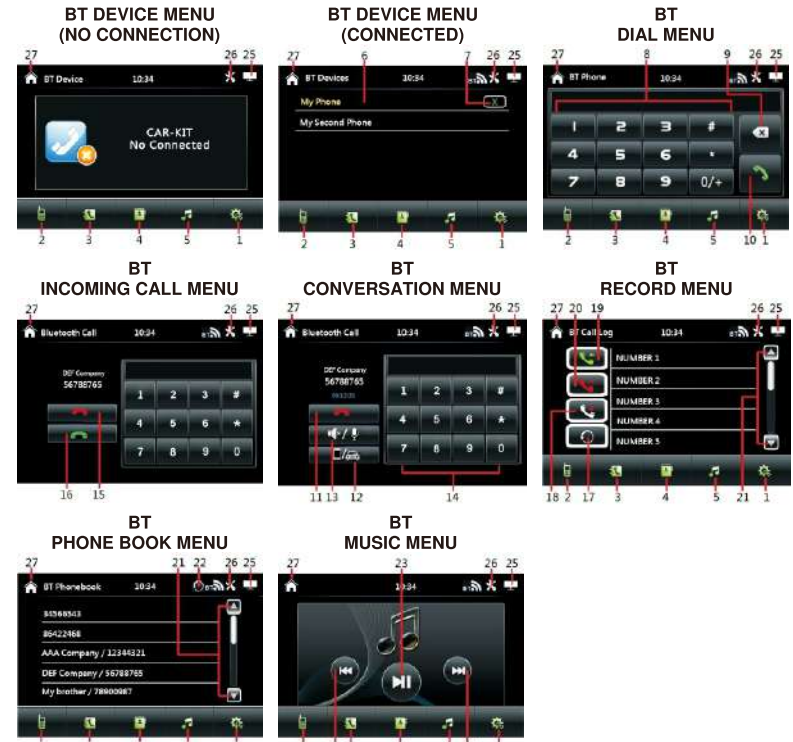

1. Touch to shift to **BT DEVICE MENU** to show the current status on connection.
2. Touch to shift to **BT DIAL MENU** for dial out of phone.
3. Touch to shift to **BT RECORD MENU** to show the record on incoming calls / dial out numbers / missing calls of the connected mobile phone.
(Note: When "Auto Loading Records" set at "ON", loading of record will start automatically when the unit linked up with the mobile phone & shift to **BT RECORD MENU** at the first time – refer to **BLUETOOTH SETUP** section of **ON SCREEN – SETUP OPERATION** for details)
4. Touch to shift to **BT PHONE BOOK MENU** to show the phone book of the connected mobile phone.
(Note: When "Auto Loading Phonebooks" set at "ON", loading of phonebooks will start automatically when the unit linked up with the mobile phone & shift to **BT PHONE BOOK MENU** at the first time – refer to **BLUETOOTH SETUP** section of **ON SCREEN – SETUP OPERATION** for details)
5. Touch to shift to **BT MUSIC MENU** for transmission of music playback from the connected mobile phone.
6. Touch to select the linked up device.

15. At video playback mode, hold & slide to select the position (time) for playback.
16. At music playback mode, hold & slide to select the position (time) for playback.
17. Touch to select music playback at **FOLDER PLAYLIST / PLAYLIST** provided the playback device recorded with music files.
18. Touch to select photo playback at **FOLDER PLAYLIST / PLAYLIST** provided the playback device recorded with photo files.
19. Touch to select video playback at **FOLDER PLAYLIST / PLAYLIST** provided the playback device recorded with video files.
20. Touch to shift to **FOLDER PLAYLIST** or **PLAYLIST** to select desired folder or file for playback. To start playback, touch twice on the selected track.
21. Touch to shift to previous **FOLDER PLAYLIST / PLAYLIST** or beginning of the folder list / playlist.
22. Touch to shift page up or down.
23. Touch to erase the digit input by error.
24. Touch to confirm after input the number of track for playback.
25. This shows the current input device for playback (DISC / USB / CARD).
26. Touch to shift back to PLAYBACK MENU.
27. Touch to turn off the screen. When the screen turned off, touch any portion of the screen to turn on the screen.
28. Touch to activate audio & visual setting for various audio & visual setup (refer to ON SCREEN – AUDIO & VISUAL SETTING for details).
29. Touch to shift to Bluetooth mode for operation (available when a mobile phone connected).
30. Touch to shift screen to **MAIN MENU**.

Note: Depends on the input device and playback media, not all the mentioned operations are available for control.

ON SCREEN – BLUETOOTH OPERATION



At **MAIN MENU**, touch on screen to shift to Bluetooth operation.



During unit operation, touch on screen to shift to Bluetooth operation.

LINK UP WITH MOBILE PHONE

To linkup Bluetooth connection with the mobile phone, take your phone and follow the steps:

- set the mobile phone to Bluetooth state
- start to search new device
- after searched, new device (CAR-KIT or similar) searched out, confirm the search
- in case of need, input default code "0000" or "8888" in the mobile phone
- at the same time, Bluetooth icon & **BT DEVICES MENU** appeared on screen
- connection succeeded and you can start using Bluetooth function

ON SCREEN – AUDIO & VISUAL SETTING



During unit operation and when this icon appeared on screen, touch to activate audio & visual setting for various audio & visual setup.



Volume Control

1. Touch to shift to Volume Control Menu.
2. Hold & slide to adjust sound output level.
3. Touch to turn on or off of sound mute control.

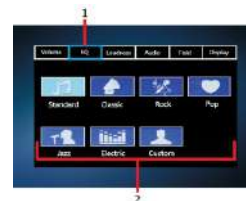

Preset Equalization Control

1. Touch to shift to Preset Equalization Control.
2. Touch to select the desired preset equalization mode. At Custom mode, it is set by the user (refer to AUDIO SETUP under ON-SCREEN – SETUP OPERATION for details).



Loudness Control

1. Touch to shift to Loudness Control.
2. Touch to turn on or off of loudness.

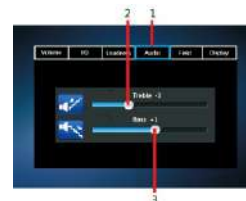

Audio Control

1. Touch to shift to Audio Control.
2. Hold & slide to adjust output level on treble.
3. Hold & slide to adjust output level on bass.

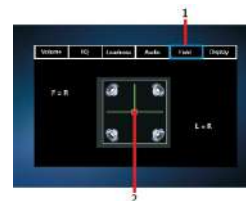

Field Control

1. Touch to shift to Field Control.
2. Hold & slide to set for the output level on left / right / front / rear speaker.



Visual Control

1. Touch to shift to Display Control.
2. Touch to select the desired setting mode on brightness, contrast, hue, saturation and sharpness.
3. At the desired setting mode, hold & slide to adjust the level.

ON SCREEN – SETUP OPERATION



At **MAIN MENU**, touch to shift screen to **SETUP MENU** for various setup selection of the unit.

UNIT SETUP

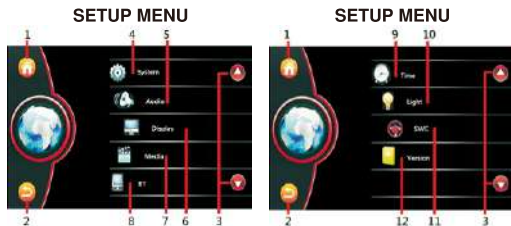

1. Touch to shift screen to **MAIN MENU**.
2. Touch to shift to previous menu or operation mode.
3. Touch to shift page up or down.
4. Touch to shift to **SYSTEM SETUP MENU** for various system setting (Refer to SYSTEM SETUP).
5. Touch to shift to **AUDIO SETUP MENU** for various audio setting (Refer to AUDIO SETUP).
6. Touch to shift to **VISUAL SETUP MENU** for various visual setting (Refer to VISUAL SETUP).
7. Touch to shift to **MEDIA SETUP MENU** for various media setting (Refer to MEDIA SETUP).
8. Touch to shift to **BLUETOOTH SETUP MENU** for various Bluetooth setting (Refer to BLUETOOTH SETUP).
9. Touch to shift to **CALENDAR SETUP MENU** for calendar & clock setting (Refer to CALENDAR & CLOCK SETUP).
10. Touch to shift to **LIGHT SETUP MENU** for various illumination backlight setting (Refer to ILLUMINATION BACKLIGHT SETUP).
11. Touch to shift to **SWC SETUP MENU** for steering wheel control setting (Refer to STEERING WHEEL CONTROL SETUP).
12. Touch to shift to **VERSION MENU** to show details of the unit (Refer to VERSION OF UNIT).

MUSIC PLAYBACK MENU



PHOTO PLAYBACK MENU



PHOTO PLAYBACK MENU



FOLDER PLAYLIST



PLAYLIST



KEYBOARD MENU



1. Hold & slide to show the hidden operation icons for operation.
2. At DVD playback mode, touch to show the title of DVD on screen. (Note: Depended on the DVD, this function may not be operated)
At VCD playback mode, touch to shift PBC on or off. At PBC on mode, touch to start playback at the beginning in sequence order.
At media playback mode, touch to activate **PLAYLIST / FOLDER PLAYLIST** (available for input device recorded with folder) to select folder / track for playback.
3. Touch to shift to next or previous track for playback.
At video playback mode, touch & hold shortly to activate fast forward or fast rewind mode. At this mode, touch repeatedly to select various speed on fast forward or fast rewind.
4. Touch to start, pause or resume playback.
5. At video playback mode under disc input, touch to stop playback.
At music / photo playback mode under disc input and playback mode under USB / SD card input, touch to stop playback temporary and will shift to playlist for playback selection. Touch twice on the selected track for playback or normal playback will resume after a while.
6. Touch repeatedly to select repeat playback mode.
7. Touch to turn on or off of random playback of the input device.
8. At DVD video playback mode, touch repeatedly to view the angle changes in sequential order (available for video recorded with multi-angle senses).
9. At video & photo playback mode, touch repeatedly to zoom in and zoom out of screen for viewing.
10. Touch repeatedly to select the audio output channels that recorded in the playback device.
11. Touch repeatedly to select different sub-titles that recorded in the playback device.
12. At video playback mode, touch repeatedly to select different speeds of slow motion playback.
13. At DVD playback mode, touch to show on screen the menu of the disc
At VCD playback mode, touch to shift PBC on or off. At PBC on mode, touch to start the playback at the beginning in sequence order.
14. Touch to activate **KEYBOARD MENU** to input track number directly for playback.

6. Touch to turn frequency upward or downward and stop for broadcasting when a station received.
Touch & hold repeatedly to fine tune radio frequency upward or downward.
7. Touch, hold & slide to the desired frequency, release for broadcasting.
8. Touch repeatedly to select radio band for broadcasting.
9. Touch to start searching the radio frequency & storing the strongest signal stations into memory. After one cycle searched, the unit starts into broadcasting of the preset memory stations for a few seconds.
10. Touch to select stereo (ST) or mono mode at FM radio band. When stereo signal received, stereo indicator will be appeared on screen and this is no indicator for mono signal.
11. Touch to select local (LOC) setting for reception of strong signal stations and a distant setting for reception of weak stations at FM radio band. When local (LOC) setting is selected, LOC will be appeared on screen and this is no indication for distant setting.
12. Touch to start into broadcasting of the preset memory stations for a few seconds. Touch again to stop this intro broadcasting.
13. This shows the preset memory stations.
Touch any one of the preset memory station to have broadcasting of relative station.
Touch & hold shortly on any one of the preset memory station, the current broadcasting station/frequency will be stored in the respective preset memory station.

ON SCREEN – DISC / USB / SD CARD INPUT OPERATION



At **MAIN MENU**, touch to shift to multi-media playback mode and playback will start automatically. Depends on the input device and playback media, touch on screen (at music playback, touch repeatedly on screen) to show various playback menus for operation.



SYSTEM SETUP

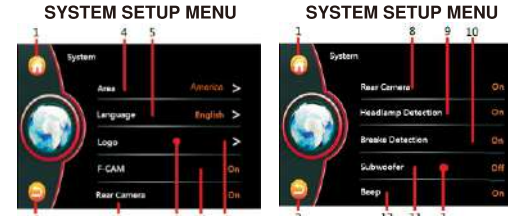

1. Touch to shift screen to **MAIN MENU**.
2. Touch to shift to previous menu or operation mode.
3. Hold & slide to show the hidden setting modes.
4. Touch to activate **AREA INTERFACE** to select the country or area located (for the radio frequency that suits the country or area that located).
5. Touch to activate **LANGUAGE INTERFACE** to select the desired system language on screen.
6. Touch to activate **PASSWORD INTERFACE** to input password for opening scene logo setting.
Remarks: This setting is for ex-factory setting and not available for user setup
7. Touch to turn on or off of front camera input (when front camera and the pink/black wire connected):
~ when the front camera input is turn on and the car is shifted from backward mode to forward mode, front camera input will be display for 10 seconds
~ the default setting after first installation is off and at this moment, no front camera input will be display when the car is shifted from backward mode to forward mode
8. Touch to turn on or off of rear camera input (when rear camera and the pink wire connected).
9. Touch to turn on or off of headlamp detection of the car (when the orange wire connected with the on/off of car headlamp).
ON mode: When the headlamp of the car turned on, brightness of screen will shift to the default setting by user. User can also adjust the brightness of screen at this mode (refer to **ILLUMINATION BACKLIGHT SETUP** for details)
OFF mode: When the headlamp of the car turned on, brightness of screen will not be affected
Remark: Backlight illumination of the unit will only be activated when the headlamp detection is turn on and the orange wire connected
10. Touch to turn on or off of allowing watching video during driving (when the brake – brown wire has not been connected).
11. Touch to turn on or off of sub-woofer output.
12. Touch to turn on or off of beep sound when touching on screen for control.

AUDIO SETUP

AUDIO SETUP MENU

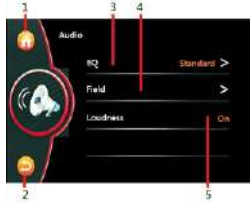

EQ MENU

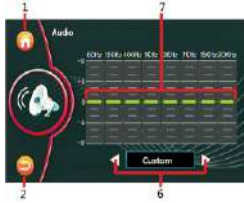

FIELD MENU

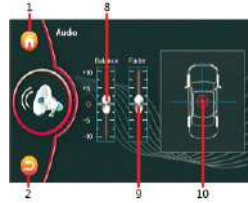

1. Touch to shift screen to **MAIN MENU**.
2. Touch to shift to previous menu or operation mode.
3. Touch to activate **EQ MENU** for equalization setting.
4. Touch to activate **FIELD MENU** for sound output setting on balance & fader.
5. Touch to turn on or off of loudness control.
6. Touch repeatedly to select the desired preset equalization mode.
7. At "Custom" control mode, hold & slide to set for your desired frequency level.
8. Hold & slide to adjust the output level between left & right speaker.
9. Hold & slide to adjust the output level between front & rear speaker.
10. Hold & slide to set for the desired output level between left & right speaker as well as front & rear speaker.

VISUAL SETUP

VISUAL SETUP MENU

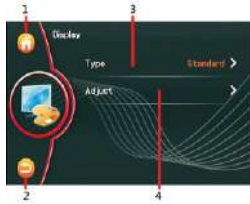

PRESET VISUAL MENU

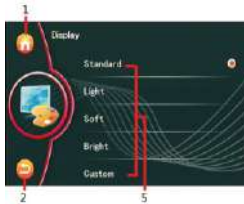

CUSTOM VISUAL MENU

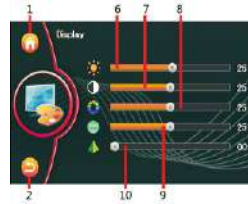

1. Touch to shift screen to **MAIN MENU**.
2. Touch to shift to previous menu or operation mode.
3. Touch to activate **PRESET VISUAL MENU** for preset visual setting.
4. Touch to activate **CUSTOM VISUAL MENU** for visual setting.
5. Touch to select the desired preset visual mode of screen.
(Note: At "Custom" mode, visual setting on brightness, contrast, hue, saturation & sharpness are made by user under **CUSTOM VISUAL MENU**)
6. Hold & slide to adjust brightness of screen.
7. Hold & slide to adjust contrast of screen.
8. Hold & slide to adjust hue of screen.
9. Hold & slide to adjust saturation of screen.
10. Hold & slide to adjust sharpness of screen.

3. Touch to turn on or off of steering wheel control (when the steering wheel control wires – grey & green as well as the ground wire connected).
4. Touch to activate **SW STUDY MENU** for steering wheel control learning & setting.
Steps for learning & setting:
~ touch any control key "5" on screen
~ press & hold the respective control of the steering wheel of the car
~ the unit starts learning and once completed, indicator appears on screen
~ follow the above steps to set for all other controls
~ when completed, press "7" to confirm the setting
~ press "6" to cancel the setting
5. These show items available for setting.
6. Touch to cancel the setting.
7. When study & setting completed, touch to confirm the setting.

VERSION OF UNIT

VERSION OF UNIT



1. Touch to shift screen to **MAIN MENU**.
 2. Touch to shift to previous menu or operation mode.
 3. These show the software version of unit.
- Note: The **VERSION OF UNIT** is used to show the details of unit. This is not available for setting.

ON SCREEN – RADIO OPERATION



At **MAIN MENU**, touch to shift screen to **RADIO MENU** for radio operation.

RADIO MENU





RADIO MENU

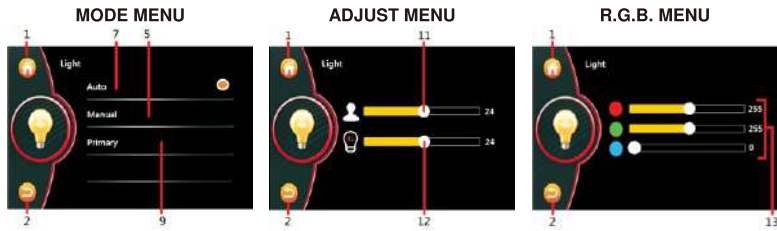

1. Touch to shift to **MAIN MENU** for selection of various operation and setup.
2. Touch to shift to Bluetooth operation.
(Note: Bluetooth icon will be highlighted when the unit linked up with the mobile phone)
3. Touch to activate audio & visual setting for various audio & visual setup (refer to ON-SCREEN – AUDIO & VISUAL SETTING for details).
4. Touch to turn off the screen. When the screen turned off, touch any portion of the screen to turn on the screen.
5. Touch to fine tune radio frequency upward or downward.



1. Touch to shift screen to **MAIN MENU**.
2. Touch to shift to previous menu or operation mode.
3. Touch to activate **ADJUST MENU** to adjust backlight illumination.
4. Touch to activate **MODE MENU** to select illumination mode (auto / manual / primary).
5. Touch to select **MANUAL MODE** for R.G.B. colour setting.
6. When **AUTO MODE** selected, touch to activate **AUTO CYCLE TIME INTERFACE** to select the time for automatic backlight change.
7. Touch to select **AUTO MODE** for automatic backlight change (cycle change).
8. When **MANUAL MODE** selected, touch to activate **R.G.B. MENU** for R/G/B adjustment.
9. Touch to select **PRIMARY MODE** to select a single colour illumination.
10. When **PRIMARY MODE** selected, touch to activate **COLOUR INTERFACE** to select a single colour for illumination.
11. Hold & slide to set brightness of screen when brightness of screen is set at **USER MODE** (refer to ON SCREEN – MAIN MENU OPERATION):

12. Hold & slide to set brightness of screen when brightness of screen is set at **USER SETTING MODE** under headlamp detection at ON mode (refer to ON SCREEN – MAIN MENU OPERATION):

13. At **R.G.B. MENU**, hold & slide to adjust the desired R / G / B colour.

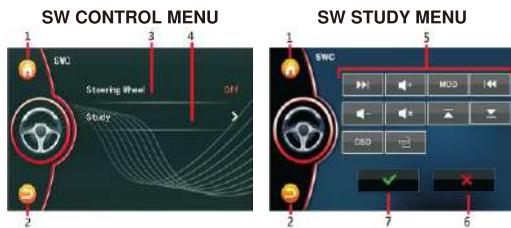
Note: Backlight illumination is synced with the on/off of the car lamp. Orange wire should be connected to the on/off of car lamp

STEERING WHEEL CONTROL SETUP



1. Touch to shift screen to **MAIN MENU**.
2. Touch to shift to previous menu or operation mode.

MEDIA SETUP

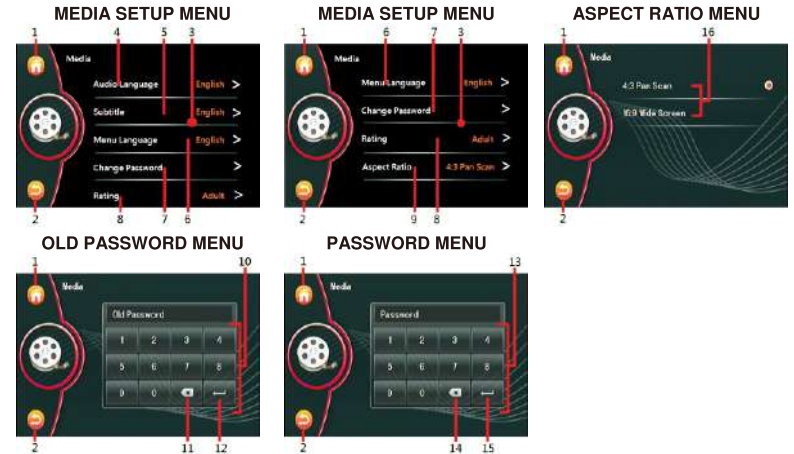

1. Touch to shift screen to **MAIN MENU**.
2. Touch to shift to previous menu or operation mode.
3. Hold & slide to show the hidden media setup modes.
4. Touch to activate **LANGUAGE INTERFACE** to set for the desired audio language for DVD playback provided the DVD recorded with relative language.
5. Touch to activate **LANGUAGE INTERFACE** to set for the desired subtitle for DVD playback provided the DVD recorded with relative subtitle.
6. Touch to activate **LANGUAGE INTERFACE** to set for the desired menu language of the DVD provided the DVD recorded with relative menu language.
7. Touch to activate **OLD PASSWORD MENU** for password changing.
8. Touch to activate **PASSWORD MENU** to input password and enter to the **RATING INTERFACE** to set for the rating of video playback.
9. Touch to activate **ASPECT RATIO MENU** to select aspect ratio of screen for viewing.
10. Touch to input the old password number.
11. Touch to erase the digit input by error.
12. Touch to confirm the number input.
13. Touch to input the password number or input the new password number.
14. Touch to erase the digit input by error.
15. Touch to confirm the number input.
16. Touch to select the desired aspect ratio of screen for viewing.

Note:

- ~ During DVD playback mode, new setting on "Audio Language", "Subtitle" & "Menu Language" cannot be activated. It is recommended to make relative setting before inserting a DVD for playback.
- ~ Default password "0000" or "8888".

BLUETOOTH SETUP

BLUETOOTH SETUP MENU



BLUETOOTH SETUP MENU



KEYBOARD MENU



PIN CODE MENU

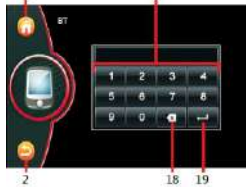

1. Touch to shift screen to **MAIN MENU**.
2. Touch to shift to previous menu or operation mode.
3. Hold & slide to show the hidden Bluetooth setup modes.
4. Touch to turn on or off of Bluetooth operation mode.
5. Touch to activate **KEYBOARD MENU** for renaming the device (default name "CAR-KIT").
6. Touch to activate **PIN CODE MENU** for changing the pin code of the device.
(Note: Default pin code "0000" or "8888").
7. Touch to turn on or off of auto linking between the car unit and mobile phone when the car unit turned on again after power off.
8. Touch to turn on or off of auto answer when receiving incoming call.
9. Touch to turn on or off of automatic loading record of incoming calls / dial out numbers / missing calls of the mobile phone to the car unit.
(Note: Loading of record will start automatically when the unit linked up with the mobile phone & shift to **BT RECORD MENU** at the first time – refer to ON SCREEN – BLUETOOTH OPERATION for details)
10. Touch to turn on or off of automatic loading phone book of the mobile phone to the car unit.
(Note: Loading of phone book will start automatically when the unit linked up with the mobile phone & shift to **BT PHONE BOOK MENU** at the first time – refer to ON SCREEN – BLUETOOTH OPERATION for details)
11. Touch to turn on or off of the default volume level during Bluetooth conversation.
ON mode: volume level at Bluetooth conversation is shifted to the default volume level
OFF mode: volume level at Bluetooth conversation is the same level at current volume level
Note: Volume level can be adjusted at any time during Bluetooth conversation
12. Touch to input the new name of the device.
13. Touch to shift between capital letter & small letter.
14. Touch to erase the digit / letter input by error.
15. Touch for spacing.

[13]

16. Touch to confirm the input.
17. Touch to input the new pin code of the device.
18. Touch to erase the digit input by error.
19. Touch to confirm the input.

CALENDAR & CLOCK SETUP

CALENDAR SETUP MENU



CALENDAR FORMAT MENU

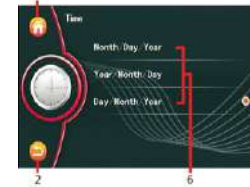

CLOCK FORMAT MENU

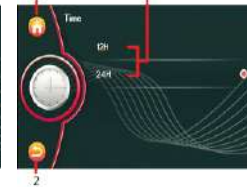

SETTING MENU



1. Touch to shift screen to **MAIN MENU**.
2. Touch to shift to previous menu or operation mode.
3. Touch to activate **CALENDAR FORMAT MENU** for date / month / year format setting.
4. Touch to activate **CLOCK FORMAT MENU** for 12H / 24H display format setting.
5. Touch to activate **SETTING MENU** for calendar & clock setting.
6. Touch to select calendar display format.
7. Touch to select clock display format.
8. Touch repeatedly to set for calendar & clock.

ILLUMINATION BACKLIGHT SETUP

LIGHT (AUTO) SETUP MENU

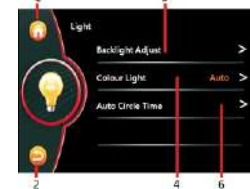

LIGHT (MANUAL) SETUP MENU

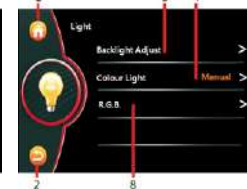

LIGHT (PRIMARY) SETUP MENU

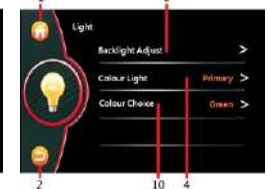

[14]