

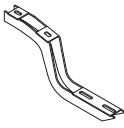

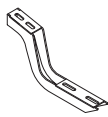

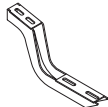





BRACKET KIT INSTALLATION

SKU# RB-0402-BK

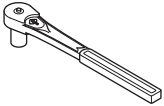
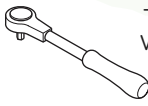

COMPONENTS		HARDWARE	
<p>DRIVER SIDE</p> <p>Qty: 1 Front Bracket</p>  <p>Qty: 1 Center Bracket</p>  <p>Qty: 1 Rear Bracket</p> 	<p>PASSENGER SIDE</p> <p>Qty: 1 Front Bracket</p>  <p>Qty: 1 Center Bracket</p>  <p>Qty: 1 Rear Bracket</p> 	 <p>Qty: 12 M8 x 30MM Hex Head Bolts</p>  <p>Qty: 26 M8 Flat Washers</p>  <p>Qty: 12 Nylon Nuts</p>  <p>Qty: 14 M8 Lock Washers</p>	
TOOLS REQUIRED		INSTALLATION NOTES	
<p>METRIC/STANDARD RATCHET</p>  <p>TORQUE WRENCH</p>  <p>13MM SOCKET</p>  <p>13MM WRENCH</p> 	<p>TORQUE NOTE: Bolts and nuts should be torqued to 15-20 ft lbs.</p> <p>NOTE: Hardware for Board Installation is included.</p> <p>NOTE: Some spare hardware is included.</p>		

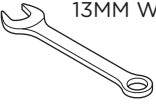
Remove all contents from the package and check brackets for any damage. Also, verify that all components and hardware listed above are included before you begin installation.

Read through entire installation manual and installation drawings to ensure that you understand all of the components and hardware before proceeding with installation.

NOTE: When installing the brackets, all hardware must be left loose until all of the items are attached.

Locate factory hole locations in three (3) places per side on the body mount.

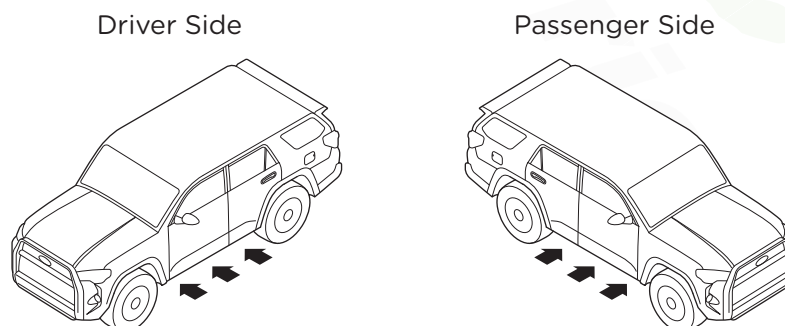

BRACKET ORIENTATION

DRIVER SIDE

Raptor
Series

1. Begin installation on driver side. Position the Front Bracket, the Center Brackets and the Rear Bracket as shown in diagram.

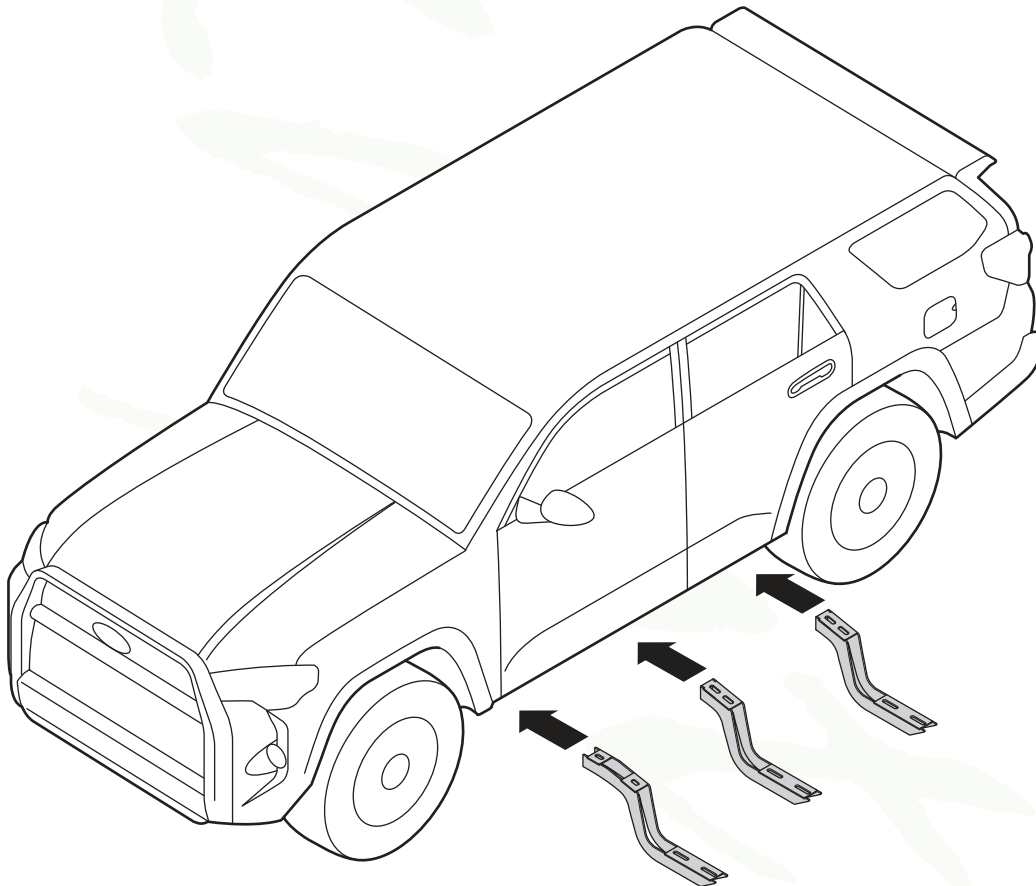

BRACKET INSTALLATION

DRIVER SIDE

Raptor
Series

- 2.** Fasten the top portion of the Driver Side Front Bracket by using (2) M8 x 30MM Hex Head Bolts, (2) M8 Flat Washers and (2) M8 Lock Washers.

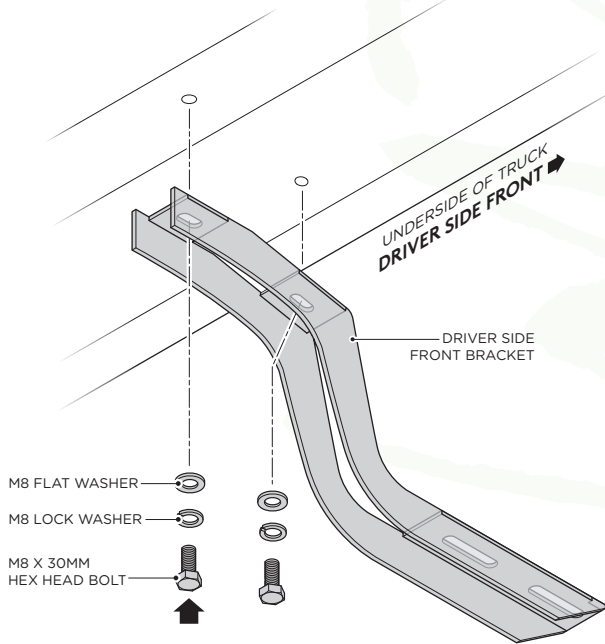

- 3.** Fasten the top portion of the Driver Side Center Bracket by using (2) M8 x 30MM Hex Head Bolts, (2) M8 Flat Washers and (2) M8 Lock Washers.

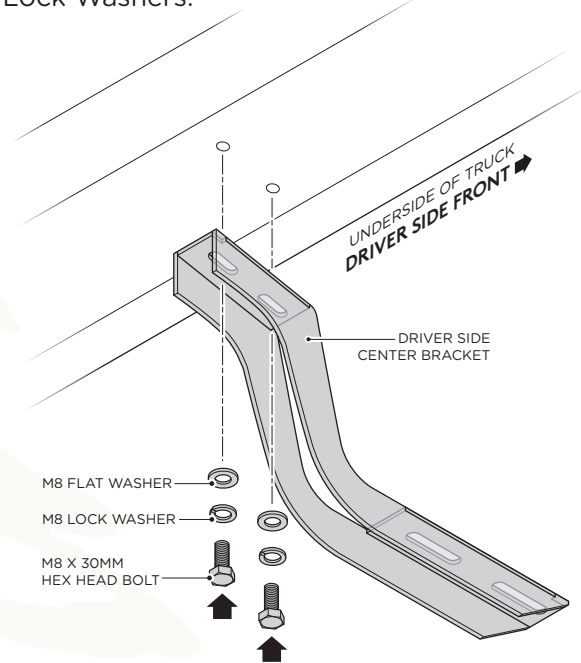

- 4.** Fasten the top portion of the Driver Side Rear Bracket by using (2) M8 x 30MM Hex Head Bolts, (2) M8 Flat Washers and (2) M8 Lock Washers.

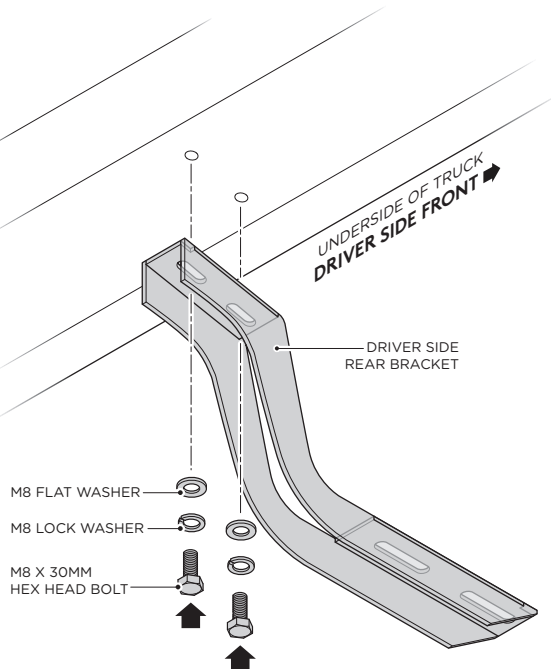

RUNNING BOARD INSTALLATION

DRIVER SIDE

Raptor
Series

5. Fasten the Running Board to the Driver Side Front Bracket cradle by using (2) M8 Flat Washers, (2) M8 Lock Washers and (2) M8 Nylon Nuts.

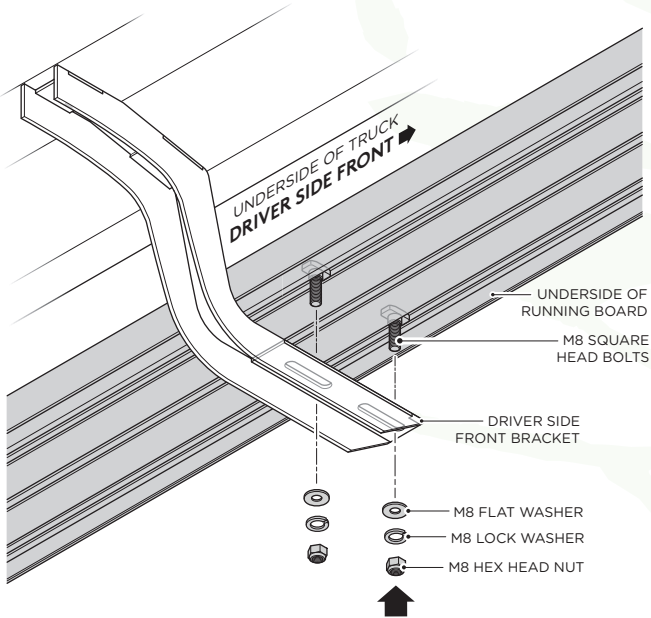

6. Fasten the Running Board to the first Driver Side Center Bracket cradle by using (2) M8 Flat Washers, (2) M8 Lock Washers and (2) M8 Nylon Nuts.

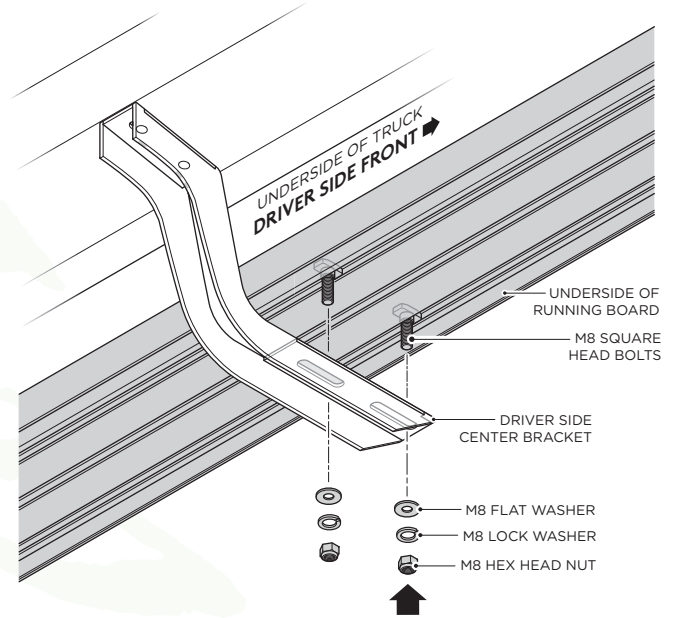

7. Fasten the Running Board to the Driver Side Rear Bracket cradle by using (2) M8 Flat Washers, (2) M8 Lock Washers and (2) M8 Nylon Nuts.

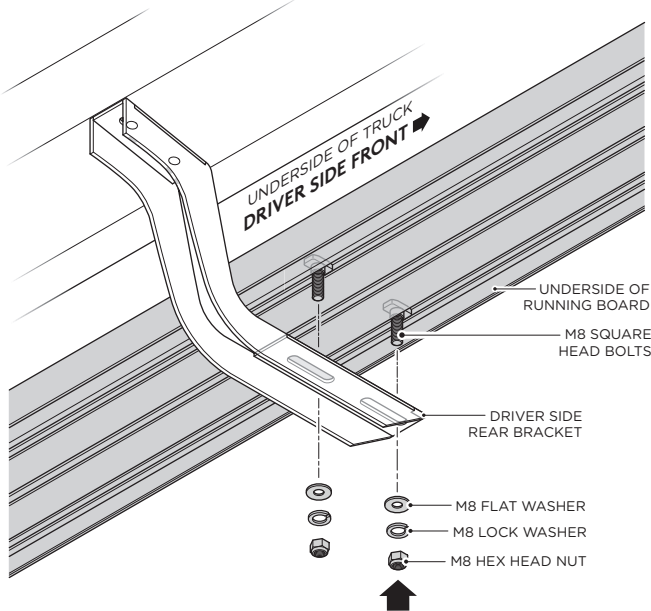

BRACKET ORIENTATION

PASSENGER SIDE

Raptor
Series

1. Begin installation on passenger side. Position the Front Bracket, the Center Brackets and the Rear Bracket as shown in diagram.

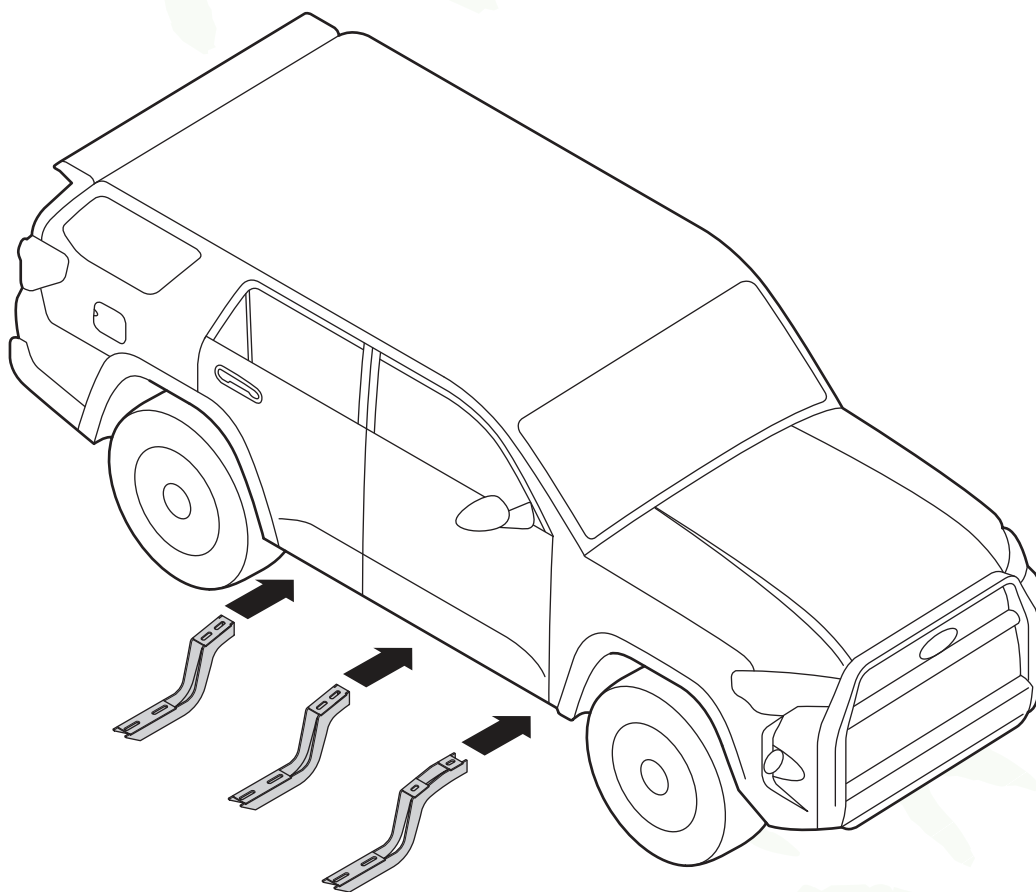

BRACKET INSTALLATION

PASSENGER SIDE

Raptor
Series

2. Fasten the top portion of the Passenger Side Front Bracket by using (2) M8 x 30MM Hex Head Bolts, (2) M8 Flat Washers and (2) M8 Lock Washers.

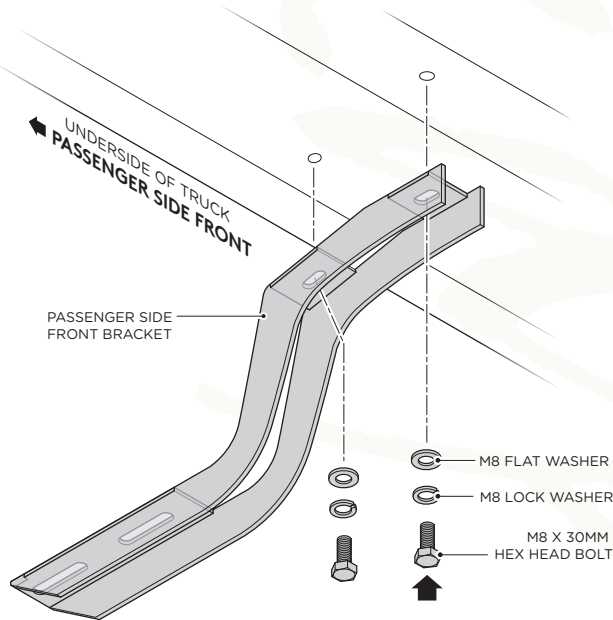

3. Fasten the top portion of the Passenger Side Center Bracket by using (2) M8 x 30MM Hex Head Bolts, (2) M8 Flat Washers and (2) M8 Lock Washers.

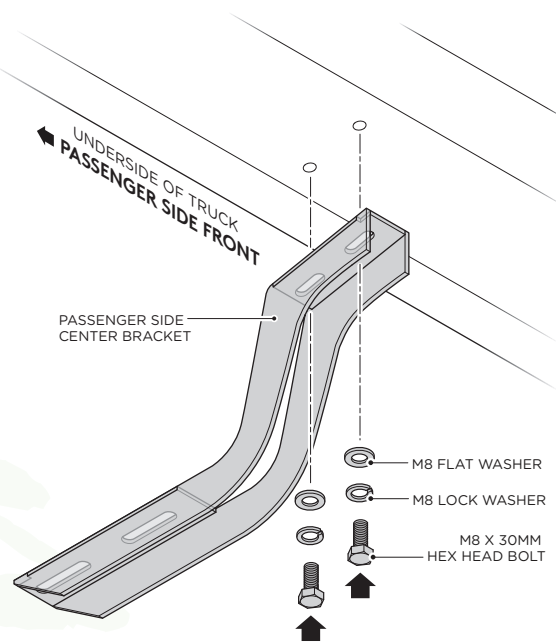

4. Fasten the top portion of the Passenger Side Rear Bracket by using (2) M8 x 30MM Hex Head Bolts, (2) M8 Flat Washers and (2) M8 Lock Washers.

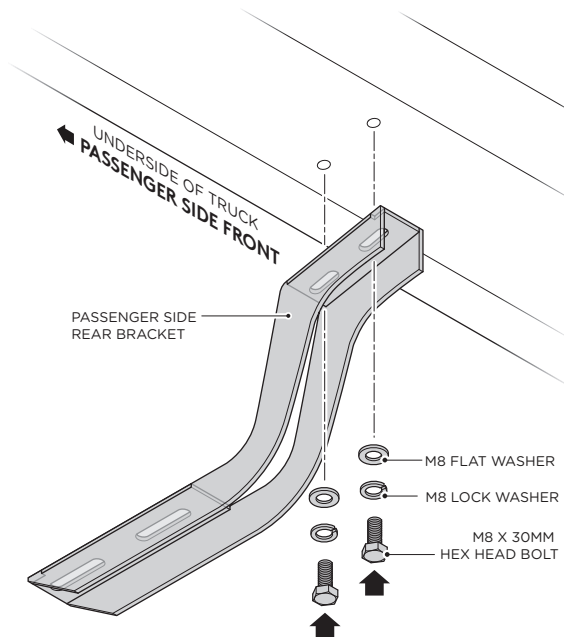

RUNNING BOARD INSTALLATION

PASSENGER SIDE



5. Fasten the Running Board to the Passenger Side Front Bracket cradle by using (2) M8 Flat Washers, (2) M8 Lock Washers and (2) M8 Nylon Nuts.

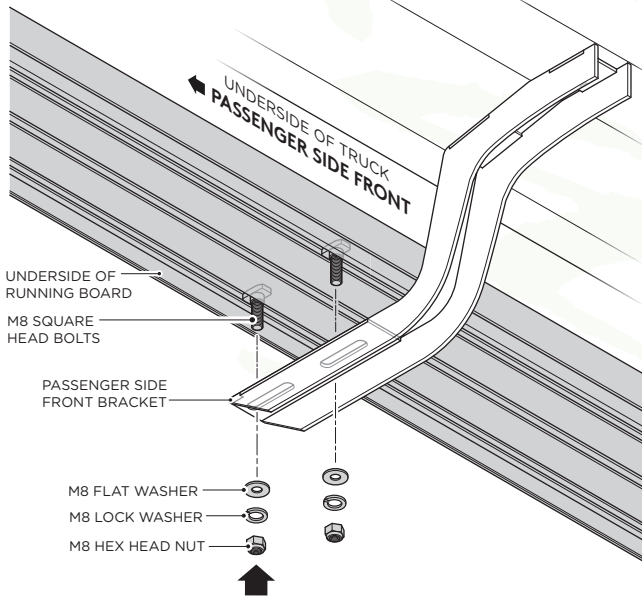

6. Fasten the Running Board to the Passenger Side Center Bracket cradle by using (2) M8 Flat Washers, (2) M8 Lock Washers and (2) M8 Nylon Nuts.

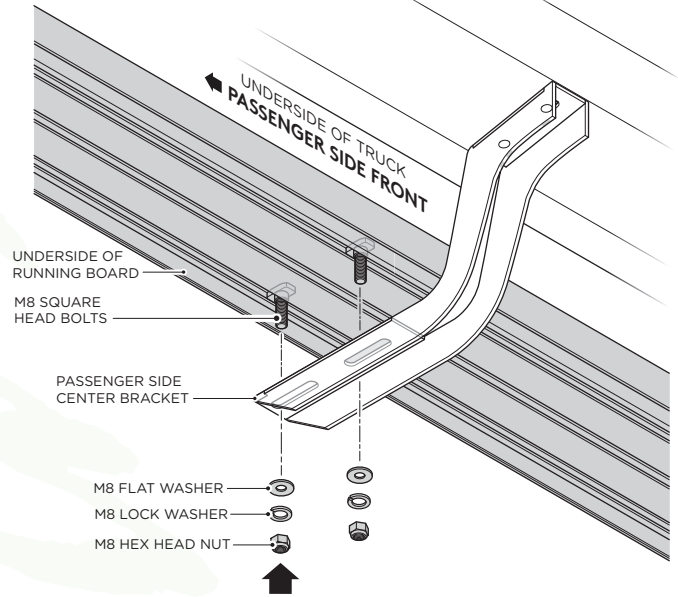

7. Fasten the Running Board to the Passenger Side Rear Bracket cradle by using (2) M8 Flat Washers, (2) M8 Lock Washers and (2) M8 Nylon Nuts.

