



## Catalog

Race-inspired, American-Made  
Billet Aluminum Accessories and Stainless Steel Trim

## 2010 World Champion Chicago Blackhawks Chevy Camaro



The award-winning Project Vehicle Team at Gurnee, IL based RealWheels Corporation started with a bright-red, 2010 Chevy Camaro LT2, and in less than two weeks transformed it into this awesome “Blackhawk” Edition performance car. Like the team it represents, this beast is fast, eye-catching, and powerful.

### Custom Billet Accessories

The car features many new products that have just become available for the 2010 Camaro. This includes an assortment of precision-machined, solid billet aluminum parts manufactured by RealWheels Corporation. The custom fuel door is enhanced with a machined Blackhawk logo. Race inspired billet pedals were installed, and a sport-style race shifter was added.

### Stainless Steel Trim Accessories

The team at RealWheels installed their new stainless grille design to provide the car with an aggressive front-end appearance. They added side vent trim and a rear fascia trim piece to provide balance to the design.



**Give your organization the attention and media exposure it deserves!**

**A. S.S. Upper Grille Replacement**

Model: RW100-1-C

**B. S.S. V8 Lower Grille Replacement**

Model: RW101-1-C

**C. S.S. V6 Lower Grille Replacement**

Model: RW101-2-C

This aggressive Grille kit is a direct replacement to the factory plastic grille and it became an instant hit with America's professional restylers at the huge SEMA show. Created from mirror-finish stainless steel construction, it is guaranteed to NEVER rust or corrode.

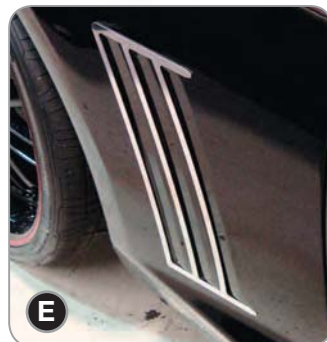
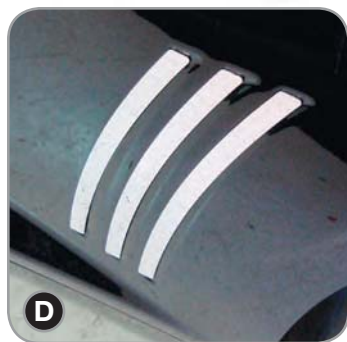

**D. S.S. Rear Side Vents**

Model: RW118-1-C

**E. S.S. Rear Side Vent Surrounds**

Model: RW118-2-C

Laser-cut from mirror finish stainless steel, they accent the vehicle's molded rear fender, create visual depth, and the illusion of an actual working vent. Installs in seconds for a lifetime of good looks.



**F. S.S. Front Marker Light Covers**

Model: RW128-1-C

**G. S.S. Rear Marker Light Covers**

Model: RW124-1-C

**H. S.S. Reverse Light Covers**

Model: RW157-1-C

Make those marker lights look like custom replacements! Designed exclusively for the Camaro, each light cover is precision laser-cut from mirror-finish stainless.



Installation is easy, secure, and takes only seconds.



**S.S. Camaro Logo Surround**

Model: RW126-1-C

A perfect way to frame your new Camaro emblem. The surround is laser-cut from stainless steel to enhance the vehicle's logo, and will never rust, pit, or corrode.



**S.S. Front Bumper Scoop Bottom Plate**

Model: RW102-2-C

This is a bold way to add style to the front mail-slot vent that comes with the V8 version of the car. Each panel is precision laser-cut from mirror-finish stainless steel.



**I. S.S. Rear Bumper Fascia Trim**

Model: RW106-1-C

This rear trim accessory is precision laser-cut from mirror-finish stainless steel and provides a stylish cover over the plastic insert.

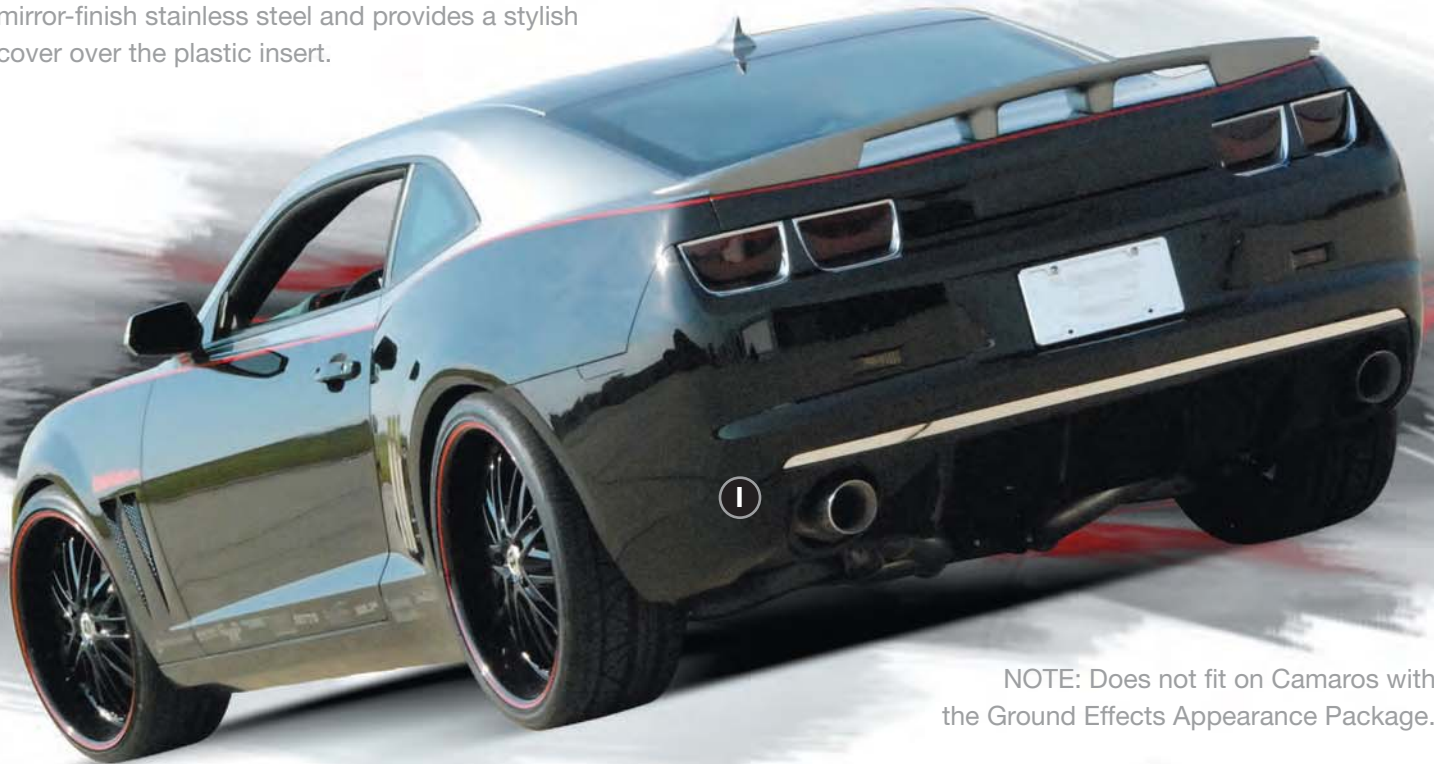

NOTE: Does not fit on Camaros with the Ground Effects Appearance Package.



**S.S. Exhaust Surrounds**

Model: RW153-1-C

Enhance the way those exhaust tips look with these stainless surrounds. Designed exclusively for the Camaro, each of these attractive surrounds are precision laser-cut from mirror-finish stainless steel for a lifetime of good looks.



**S.S. License Plate Panel**

Model: RW109-1-C

This popular accessory fills the empty cavity directly behind your rear license plate. Designed exclusively for the Camaro, each panel is precision laser-cut from mirror-finish stainless steel for a lifetime of stylish good looks.



**J. Billet Manual Pedal Set w/Dead Pedal**

Model: RW235-3-C    Black: RW235-3BP-C

**K. Billet Manual Pedal Set**

Model: RW235-1-C    Black: RW235-1BP-C

**L. Billet Automatic Pedal Set**

Model: RW235-2-C    Black: RW235-2BP-C

These brightly polished, race-inspired pedals dramatically set your vehicle apart from the rest. The aggressive texture combines with luxurious styling to create one of the best accessories available for your new Camaro. You WILL notice the difference, whether you're on the track, or cruising the highway. Installation is quick, easy, and secure.

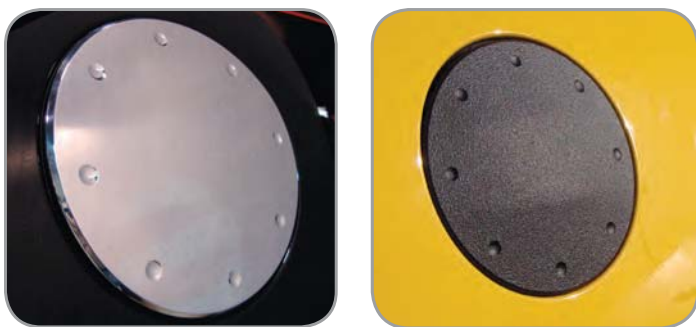

**Billet Fuel Door**

Model: RW202-1-C    Black: RW202-1BP-C

This solid billet fuel door was designed to add luxury and performance styling to the new Camaro. Installation is quick, easy and secure.



Power-grip rubber rings were then added for the ultimate in performance driving.

### Billet Manual Gear Shift Knob

**Model:** RW223-1-C    **Black:** RW223-1BP-C

Feel the power of the new Camaro in your hand with this shift knob that should have come with the car. This solid billet accessory was designed to add luxury and performance styling. Installation is quick, easy and secure.



### S.S. Interior Door Panel Inserts

**Model:** RW152-1-C

Enhance the way the Camaro's interior looks with these stainless inserts. Designed exclusively for the Camaro, each of these attractive inserts are precision laser-cut from mirror-finish stainless steel.

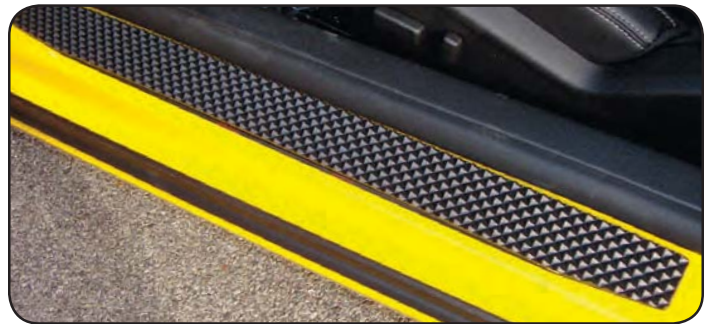
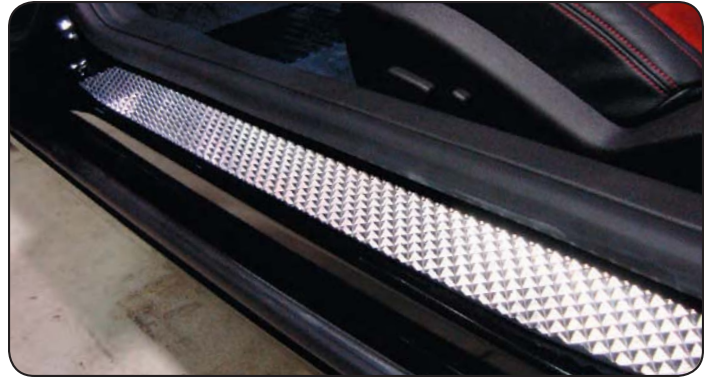

### Billet Door Sills

**Model:** RW237-1-C    **Black:** RW237-1BP-C

### Billet Diamond-Cut Door Sills

**Model:** RW237-2-C    **Black:** RW237-2BP-C

From the aggressive texture to the bold styling, these custom door sills scream quality. Installation is quick, easy, and secure.



## Fire and EMS Vehicle Accessory Catalog



**We Don't Make Your Vehicles...  
We Make Your Vehicles Look and Perform Better!**



## RealWheels® and the Fire/EMS Industry...an All-American Winning Team.

American firefighters demand the finest, most reliable equipment available with minimum maintenance. That's why fire departments prefer RealWheels®, the only American manufacturer of Wheels Simulators and Axle Covers.

RealWheels is also the choice of American manufacturers for fire trucks and emergency vehicles. RealWheels produces the highest quality simulators, axle covers, fenderettes, grilles and door handles available anywhere. We use only heavy-gauge 304L stainless steel, aluminum and high-impact plastics. In fact, our mirror-shine finish stainless steel is guaranteed for life. Plus our patented mounting systems simplify installation and is D.O.T. approved.

We are proud to work closely with the American firefighting industry, and together we extend our appreciation to all firefighters for the work they willingly do in all the communities of our country.



**Contract Manufacturing**

On The Cover:  
 Concept Fire Truck designed by the RealWheels IDEA team. This vehicle incorporates stock and custom products demonstrating our design and engineering capabilities.





LED AirGuard® Set & Go



Valve Stem Stabilizers



22.5" to 24.5" Simulators



Universal Simulators



Sprinter Simulators



Super Single Simulators



19.5" Simulators



16" to 17" Simulators



Axle Covers



LugCheck™



Lug Nut Covers



Grille Covers

Flagpole Holder



Air Valve Extensions



2015 Ford Transit  
Stainless Steel  
Accessories

**NEW!**



Ford Transit Accessories



**RWG7100-CTR15** 4pc S.S. Grille Overlay (Only)

**RWG7100-DTRV15** 4pc S.S. Grille Overlay and  
2pc S.S. Hood Vent Overlays



**RWG7101-TRHV15**  
2pc S.S. Hood Vent  
Overlays (Only)

Overlays securely  
adhere with heavy-  
duty 3M tape.

**Transit Single Wheels**

Cut-Out Patterns Match Factory Wheels

**RW1604-TAK** —16" single

- All high quality, heavy-gauge stainless steel.
- Covers install easily — no lug nuts to remove.



**RW1606-12TAK**

2015+ Transit 16" dual wheels with 12 round cut-outs



# LED AirGuard®

**SET & GO** Tire Pressure Monitoring System

## Low Tire Pressure Is Dangerous!

Complies with the NFPA 1901 and 1917 Standards.

### The Easiest TPMS to Install, Calibrate & Re-Calibrate

- Safety – Improper tire pressure has a detrimental effect on handling, braking and control.
- Longer Tire Life – According to the D.O.T., 95% of all premature tire wear is caused by underinflation.
- Self-calibrating – LED AirGuard Set & Go memorizes pressure when initially installed and can be easily recalibrated by simply removing and reinstalling.
- Improved Fuel Economy – Proper tire inflation can save an estimated 3% to 5% in fuel costs.
- The Set & Go can be used on any tire pressure between 10psi and 200psi.
- Battery standby time is warranted for 2 years from the date stamped on the LED AirGuard.
- Ultra-bright LED allows for visual checks of each tire, even in daylight!



**DANGER**

**SAFE**

LED AirGuard Set & Go starts flashing RED if the tire pressure drops 5 to 10 psi.

#### RW-PPK-0402

LED AirGuard Set & Go (4-Pack)

#### RW-PPK-0403

LED AirGuard Set & Go (6-Pack)

#### RWTG1235

LED AirGuard Set & Go (Each)

POP Packaging & Display Available!

No tools required for installation.



**1. Check Tire Pressure**



**2. Thread On**



**3. Monitors Pressure**

Starts flashing RED if tire pressure drops 5 to 10 psi.



### Set & Go Anti-theft Locking System



The use of the Locking Nut to tighten against the Set & Go on the valve stem helps prevent theft.





## Tire Pressure Monitoring Kit



Includes: AirGuard™ Valve Caps, Inner and Outer Air Valve Extensions, plus Air Valve Extension Stabilizers.

For 19.5", 22.5" & 24.5" Aluminum Wheels w/ Round Holes and 22.5" & 24.5" Standard Steel Wheels w/ Oval Holes

### 6 Wheel Kit

Kit Fits

RWTG1235-62	for 2" round holes
RWTG1235-65	for 2.5" round holes
RWTG1235-68	for 2.8" round holes
RWTG1235-63	for oval holes (steel)

### 10 Wheel Kit

Kit Fits

RWTG1235-12	for 2" round holes
RWTG1235-15	for 2.5" round holes
RWTG1235-18	for 2.8" round holes
RWTG1235-13	for oval holes (steel)

## Valve Stem Stabilizers



These Valve Stem Stabilizers help prevent damage to extensions caused by the rubbing of the extension against the wheel. A worn extension may lead to air leakage and result in tire damage. Easy installation: simply align the rubber stabilizer with the valve extension and push into the wheel hole.

## Valve Stem Wear Is Dangerous

Centrifugal force of a rotating wheel (photo 1) will cause the valve stem to rub against the wheel and result in wear and eventual failure of the valve stem (photo 2).





American Road Series (shown)



RW1173-24AK Fits 22.5" Fronts

RWWLH2003-AXK Fits 22.5" Rears

22.5" to 24.5" Stainless Steel Simulators offer a front profile and deep rear inset that simulates the look of aluminum wheels.

Classic Series (shown)



Pop-In Centers for easy oil cap viewing.



RW1173-24CK Fits 22.5" Fronts

RWWLH2003-CXK Fits 22.5" Rears



## Why Fire OEMs and Fire Departments Choose RealWheels Simulators.

1. Dollar for dollar, RWC Simulators are the best value in the market.
2. RWC is the only American wheel simulator manufacturer.
3. All our simulators are made from heavy-gauge 304L stainless steel.
4. The only simulators that look like aluminum wheels.
5. They all have patented, over-the-lug style mounting, which does not require the removal of lug nuts.
6. They have more universal features and require fewer part numbers to fit a variety of wheel sizes.
7. RealWheels guarantees the durability of each simulator and its mirror-shine.
8. All parts can be ordered individually.
9. 22.5" & 24.5" rear simulators come standard with our American-made, high-quality, stainless steel braided valve extensions for easy air pressure monitoring and access.



Specifying steel wheels with RWC's American-made stainless steel simulators, instead of aluminum wheels, will not only save your department money now, but you'll also benefit from reduced maintenance cost due to our lifetime mirror-shine finish. Your fire truck's wheels will always look good. Guaranteed.

### RWC has over 30 years' experience developing mounting systems. Our innovative designs have been awarded numerous patents.

- Fits 20/22.5 x 7.50/8.25/9.00 and 22/24.5 x 8.25 wheels.
- For standard hub piloted, stud piloted and cast spoke wheels.
- Rear simulators fit wide-base wheels.
- High-quality, non-magnetic 304L stainless steel—will not rust, pit, corrode or turn yellow.
- Engineered to fit securely to steel disc or aluminum wheels with our patented over-the-lug mounting systems.
- The hook mount systems do not require excess stud.
- These systems do not disturb the torque of the lug nuts.

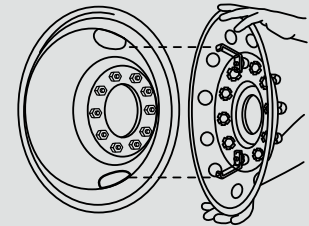

**Front Hook Mount**



**Wedge Lock Mount**



Universal  
Simulators  
Premounted Lug  
Nut Covers (shown)

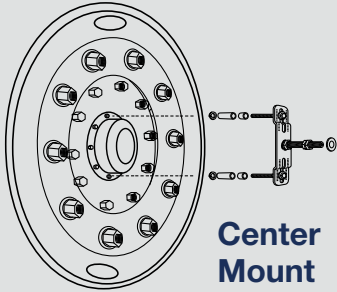

**Center  
Mount**



**RW1121LK-34C**  
Fits 20" & 22.5" Fronts

**RW1021LK-UC**  
Fits 20" & 22.5" Rears

Whether you have an early model truck with cast spoke (Dayton) wheels or a brand new truck with steel disc wheels, these covers fit them all.

**Universal Simulator Features**

- Available in sizes to fit 20" & 22.5" and 22" & 24.5".
- High-quality 304L stainless steel will not rust, pit, corrode or turn yellow.
- Universal Simulators are for cast spoke (Dayton) or steel disc wheels. Truly Universal for any wheel. Center mount system makes installation simple and D.O.T. inspections easy.
- Easy care and low maintenance for years to come.

Universal Simulators Integrated Lug Nut Covers (shown)



**RW1121BK-34C**  
Fits 20" & 22.5" Fronts

**RW1021BK-UC**  
Fits 20" & 22.5" Rears



Optional  
Wing Nut  
Center  
Available



2012+ 3500  
Sprinter-EZ  
Dual Wheels  
(shown)

**RW1602-18SAK**

2012+ 3500  
Sprinter-EZ 16"  
dual wheels with  
18 round holes

**RW1602-18SAXK**

2012+ 3500  
Sprinter-EZ 16" dual  
wheels with 18 round  
holes and includes  
valve extensions



Covers also available for 2004 - 2011 Sprinter models.

Sprinter simulator design is patterned with the same number of cutouts as the factory wheel and is approved by Daimler Commercial.

- We've designed our EZ line of wheel simulators so they are EZ to install, EZ to clean and EZ to maintain. Plus they are offered at a lower price, which makes them EZ to purchase.
- Rear simulators have a new, extremely low center cap design that eliminates obstructions when servicing and creates the easiest wheel simulators to maintain and clean.
- High quality, heavy-gauge stainless steel.
- Patented mounting system — no lug nuts to remove.
- Sprinter & custom emblems available.



**Sprinter Single Wheels**

Cut-Out Patterns Match Factory Wheels for Improved Air Flow!

2007 & Up 2500 Sprinter-SL

**RW1603-SAK\***

16" single, fits on 2007 & Up

\*Integrated lug nut cover design prevents curbing damage, eliminates missing lug nut covers, and provides easy maintenance.





**RW1130** 22.5" x 12.25"



**RW1134** 22.5" x 13"



**RW1133** 22.5" x 13"



**RW1160-BK** 20"/22.5" x 12.25"/13"

Integrated Lug Nut Covers— Offers the styling of lug nuts, without the hassle of cleaning around lug nuts.



20" and 22.5" Super Single Simulators for heavy duty front axles offer the only flush profile in the industry. This flush profile is crucial to maintain mandatory width offsets.



### Super Single Features

- High-quality, non-magnetic 304L stainless steel—will not rust, pit, corrode or turn yellow.
- For super single front hub piloted and stud piloted wheels.
- Fits 20/22.5 x 12.25 and 13.00 wheels.
- Simplified over-the-lug, patented mounting system.
- For heavy rated front axles.
- Easy D.O.T. Inspection.



Our simulators install easily on most super single wheels.

### Custom Sizes Available

RealWheels Super Single Covers can be designed to fit any super single wheel, even airport ARFF units.



Pop-In Centers for easy oil cap viewing.



19.5"  
American  
Road Series  
(shown)

**RW1901-AOK**  
8-Lug



RealWheels 16", 17" and 19.5" Stainless Steel Simulators offer a front profile and deep rear inset that simulates the look of aluminum wheels.

**16", 17" and 19.5" Simulators Features**

- High-quality, non-magnetic 304L stainless steel — will not rust, pit, corrode or turn yellow.
- The hook mount systems do not require excess stud.
- These systems do not disturb the torque of the lug nuts.

**Front & Rear Hook Mount**

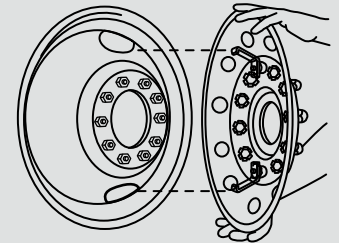

19.5", 10-Lug  
For Ford, Chevy  
& Dodge Wheels  
4x4 open center

**RW1902-AOK**  
**RW1902-AOK4**  
LKO Mounting





16"-17"  
American  
Road Series  
(shown)

**RW1600-223AK**

16" G-Series For GMC  
& Ford E-450 (shown)

G-Series also available for  
17" & 19.5" wheels.



16" & 17" Simulators  
For Ford, Chevy  
& Dodge Wheels

Shown with  
open center for  
manual lockouts.

# The Only American-Made Universal Front Axle Covers

“Universal”...Fits All Wheels

**RW6215U2**

Dia: 8.812”  
Height: 2¾”



All 304L  
Stainless  
Steel

**RW6215U2 NEL**



## Fits Them All!

Fits All Front Wheels with 4, 5 or 6 Pilots – Hub or Stud Piloted – Aluminum or Steel Wheels.

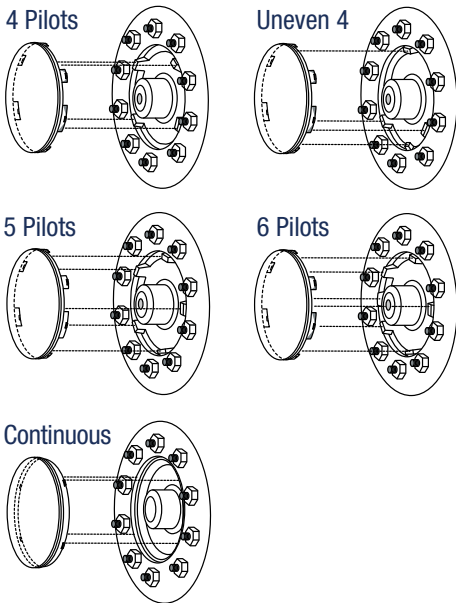

## The Last One You'll Ever Need To Buy!

- Built to last with heavy gauge 304L stainless steel—up to 91% heavier than the imports.
- Installation is quick, easy and secure!



Available with cutout for oil cap viewing.

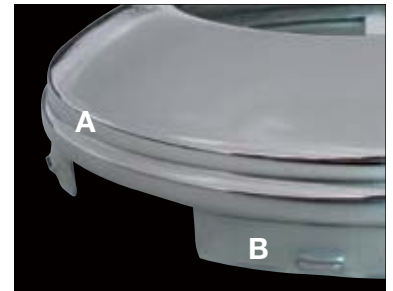

- A: Reinforcing bead adds extra strength and covers pilots.
- B: Integrated locking tabs require no separate clips.

## Axle Cover Trim Kits

Four Wheel Kit – 2 Baby Moons, 2 High Hats & 40 Lug Nut Covers.

**RW8122** (With Center Logo)

**RW8122NEL** (No Logo)

Six Wheel Kit – 2 Baby Moons, 4 High Hats & 60 Lug Nut Covers.

**RW8122-2** (With Center Logo)

**RW8122-2NEL** (No Logo)





All 304L  
Stainless  
Steel

## The Only American-Made Rear High Hats

- Wheel manufacturers do not recommend under-the-lug mounting systems. That's why RealWheels Patented High Hat Mounting Systems make so much sense!
- They do not disturb wheel balance.
- High Hats fit all steel disc or aluminum wheels whether 8 or 10 lug, hub piloted or stud piloted.



**RW7715**  
Dia: 9"  
Height: 9"

**RW7715 NEL**

## Improved Band Mount Spring Clip High Hat Patented Installation



**1**  
Slide ring over axle onto hub & tighten securely.



**2**  
Push the high hat into place.

## Rear Baby Moons



- Inexpensive solution for rear axles.
- Simply snaps on over axle studs.
- High quality stainless steel.
- Available with or without embossed logo.



**RW7070**  
Axles with 5/8" Studs

**RW7270**  
Axles with 3/4" Studs

**RW6016**  
Trailer Axles with bracket.

22.5/24.5"  
 Axle Covers



**RW1013HFK** (Hub piloted.)



**RW1015HRK** (Hub piloted.)

These low profile “Cover-Up” Hub Covers are the only system that covers the axle and the lug nuts and features the patented “Wedge Lock” bracket.

Covering the hub and lug nuts helps streamline your front wheels to reduce drag and improve aerodynamics. Makes cleaning wheels easy — no lug nuts to wash around.

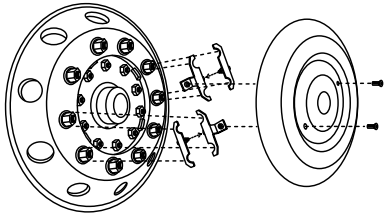

Patented  
 “Wedge Lock” Bracket

Installation is quick, easy and secure!

- Low profile design.
- Fits 10 lug wheels.
- For steel or aluminum wheels.
- Will not crack like plastic when removing.
- Made from high-quality, non-magnetic 304L stainless steel—will not rust, pit, corrode or turn yellow.
- Integrated Lug Nut Cover design.

19.5” Axle Covers w/ Integrated Lug Nut Covers



**Chevy/GMC**

Front:  
**RW1095HFK**  
 Rear:  
**RW1096HRK**



**Dodge**

Front:  
**RW1091FSBK**  
 Rear:  
**RW1092RSBK**

**Freightliner/  
 International**

Front:  
**RW1097HFK**  
 Rear:  
**RW1098HRK**



**RW1010SK\***



**RW1011SK\***

**Wing Nut Center Mount**

Solid Stainless Steel! For steel or aluminum wheels. Easy to install. Mounting brackets fit any axle, front or rear. No need to remove lug nuts.



# Cover-Up Hub Covers Designed for 2005- up Ford F450/F550 & International TerraStar

Front/Rear Kit:  
**RW1093SOK**

Front/Rear Kit 4WD:  
**RW1093SOK4**



Bold Styling  
and Streamlined Design



Easy and secure installation  
with our over-the-lug  
mounting brackets.



Ford/Int: **RW1091FSOK**

Ford 4WD: **RW1091FSOK4**  
Open center for manual lock out



Ford/Int: **RW1092RSOK**

## Gear Nut Axle Covers

- This Geomechanical Stainless Steel Axle Cover offers easy, secure installation.
- New universal mounting system provides quick, easy access and confident, secure reinstallation during vehicle service.
- Gear-Nut Mounting Device is precision-machined, enhanced with a color logo and features our anti-rotation technology for additional secure mounting.

**RW1011-2GN\***

**RW1010-2GN\***



**RW2GNT**

**Wrench Included**

Available for even  
easier servicing

**\*NOTE:** Axle, hub and wheel information required when ordering.





The only lug nut cover that provides safety, good looks, and a universal fit.

### The first 32/33mm Universal Lug Nut Cover with optional Loose Lug Nut Indicator.

- Universal Design—Fits both 32mm and 33mm lug nuts.
- Lug nut cover is designed to accommodate our optional LugCheck Loose Lug Nut Cover Indicators—Allows for quick and easy visual inspection.
- High-quality, chrome plated ABS.
- Optional reflective inserts available.



Vibration and bolt fatigue are the leading causes of self-loosening wheel lug nuts and joint failure. Visual inspections by trained mechanics can detect a loosened wheel lug nut, however to an untrained eye, a loose wheel lug nut looks tight. That's why RealWheels has developed the LugCheck Loose Lug Nut Indicator. It's the only cover that combines the safety of a visual Loose Lug Nut Indicator with the beauty of a chrome plated lug nut cover.



Personalized domed logos or reflective inserts for added safety are available.

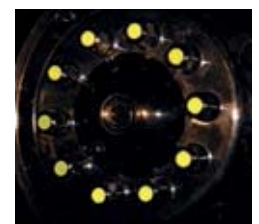

Optional reflectors dramatically increase visibility.

Loose Lug Nut Indicator:  
 Black: **RW1270** Yellow: **RW1270Y**

Lug Nut Cover w/ Indicator:  
 Black: **RW5809I** Yellow: **RW5809IY**

LugCheck  
 10-Pack  
 Black:  
**RW5809I-K**



Lug Nut Covers are available for most popular lug nut sizes and shapes.

Chrome Plastic



**RW5802 ▲**  
33mm with 2" flange  
chrome plastic  
Height: 2½"



**RW5801 ▲**  
1½" with 2¾" flange  
chrome plastic  
Height: 2¾"



**RW5805 ▲**  
33mm w/ 2" flange  
chrome plastic  
Height: 3⅛"



**RW5510**

Adjustable Lug Nut Pullers

Adjusts from 1/2" to 1-3/4". These Pullers help remove lug nut covers without scratches or denting.



**RW5804 ▲**  
1¼" chrome plastic  
Height: 2"



**RW5800 ▲**  
1½" chrome plastic  
Height: 2¼"



**RW5809 ▲**  
32/33mm universal  
w/ 2" flange  
chrome plastic  
(works with  
LugCheck  
see p.18)  
Height: 2¾"

Stainless Steel



**RW5605 ▲**  
1" with skirt  
stainless steel  
Height: 1¼"



**RW5610 ▲**  
1½" stainless steel  
Height: 1⅝"



**RW5612 ▲**  
1½" with skirt  
stainless steel  
Height: 2"



**RW5615 ▲**  
1½" stainless steel  
Height: 2"



**RW5630 ▲**  
41mm with skirt  
stainless steel  
Height: 1⅞"



**RW5696 ▲**  
33mm w/ 2" flange  
stainless steel  
Height: 2⅞"



**RW5625 ▲**  
33mm w/ 2" flange  
stainless steel  
Height: 2"



**RW5600 ▲**  
Ford, 1⅞" with 1¼"  
flange stainless steel  
Height: 1¾"



**RW5618 ▲**  
30mm with 1⅞"  
flange stainless steel  
Height: 2"



**RW5620 ▲**  
32mm with 2" flange  
stainless steel  
Height: 1¼"



Freightliner Stainless Steel Grille Covers add style and beauty to your Freightliner 108SD and 114SD truck.

- Made from High-Grade, 304L stainless steel.
- Will never rust, corrode, pit or lose their shine.
- Formed to fit perfectly over your existing grille. No disassembly required.
- Easy Installation. No tools required.



**RWG108**

6 slats for 108SD trucks

**RWG114**

5 slats for 114SD trucks

**RWG108W**

6 slats with cutouts for winter cover for 108SD trucks

**RWG114W**

5 slats with cutouts for winter cover for 114SD trucks

Custom and Deluxe Grille Covers



- Made from high-grade 304L stainless steel that will not rust, pit, corrode or lose its shine.
- Many other styles and custom grilles are available.



Ford 350/450/550 (2011 to 2015)

4pc Grille Overlay (Only): **RWG7000-C15**  
 4pc Grille Overlay and 2pc Bumper Vent Overlays: **RWG7000-D15** (Shown)  
 2pc Bumper Vent Overlays (Only): **RWG7001-BV15**



Chevy Deluxe: **RWG6500C**



International Deluxe: **RWG4000D**  
 Custom: **RWG4000C** (grille slats only)





## "Liberty" Vehicle Flag Pole System

The heaviest-duty 304 stainless steel system on the market! It's made from heavy gauge 304 stainless construction with CNC precision machined billet aluminum components, including top ball.



**RW521-1**  
"Liberty" Kit with  
American Flag

**RW522-1**  
"Liberty" Kit  
(No Flag)



## Air Valve Extensions

Custom valve extensions are made in various lengths to accommodate the requirements of any wheel cover or simulator. This makes checking air pressure a breeze. They're easy to install. Braided styles are made of stainless steel, the most rugged and trouble-free extension available.

### Braided Stainless Steel

- A. **RW1258H** 15" Hooked
- B. **RW1258-1S** 14" Straight
- C. **RW1258-1H** 14" Hooked
- D. **RW1258S** 15" Straight
- E. **RW1259B** 5" with Clamp

### Solid Styles

- F. **RW1263** 45° angle
- G. **RW1262** 2" Solid
- H. **RW1260** 3" Solid
- I. **RW1259S** 6" Solid
- J. **RW1261** Dbl. end air valve caps
- K. **RW1266** 180° angle



**RWPSI**

## Crossfire Dual Tire Pressure Equalizing System

Allow air to flow between the two tires and equalize pressure with the Crossfire Tire Pressure Equalizing and Monitoring System. This helps reduce wear and tear on tires, and simplifies tire maintenance, saving you time and money. Fits all types of wheels.

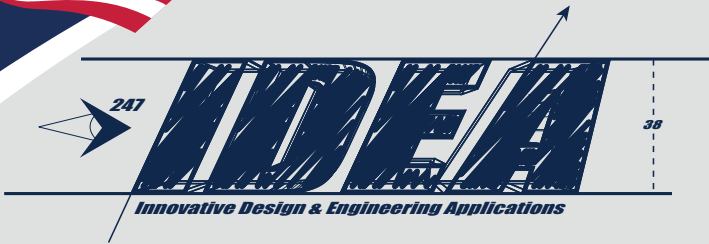

**RealWheels Corporation's in-house capabilities and services include:**

- Design Services
- Laser Cutting
- Vertical CNC Milling
- CNC Turning
- Welding
- Tube Bending
- Metal Spinning
- Stamping
- Forming
- Polishing & Buffing
- Plastic Molding
- Injection Molding
- Thermoforming



Complete Contract Manufacturing Serving Truck OEMs, Body Builders and Upfitters.



Sutphen Stainless Steel Grille & Light Housings

The I.D.E.A. division (Innovative Design & Engineering Applications) is the branch of RealWheels Corporation that assists your organization with various levels of design, engineering, and fabrication. This exciting division has effectively helped customers with tasks as simple as basic parts manufacturing, or as detailed as complete new product concepts and development.

We are passionate problem solvers, consistently dedicated to finding the best design and manufacturing solutions for our clients.

Our fabricating abilities allow flexibility to meet your technology and delivery requirements while staying within your budget constraints.



Meets NFPA Standards  
Custom stainless steel diamond pattern steps with non-slip extrusions.



Light Housing Wing Pocket Thermoformed and Chrome-Plated.



Bending, forming and welding of tubular stainless steel.



Chrome plated billet door handles for major OEM.



RealWheels is your source for custom sized Stainless Steel Fenderettes.



Rosenbauer Stainless Steel Grille & Light Housings



RealWheels is your source for custom sized Stainless Steel Fenderettes. We've built our reputation providing quality stainless fabrication and carry this expertise into every fenderette we manufacture. Rolled from 304 stainless steel then polished to either a standard, bright or mirror shine. Length, gauge, radius and hole placement to your specifications. Send us your specs for a free estimate.

We have effectively helped customers with tasks as simple as basic parts manufacturing, or as detailed as complete new product concepts and development.



Custom Brush-Finished Stainless Steel ARFF Cover



A leading heavy equipment manufacturer was preparing to unveil a new Airport Rescue Vehicle. They enlisted the help of the RealWheels IDEA team to design and engineer a protective stainless wheel cover. No cover had ever been developed for such a large wheel size, and a completely new mounting system had to be engineered. The team created a very industrial design with a machined-finish. The protective cover performs extremely well, greatly enhances the vehicle's appearance, and has become a popular option on new orders.



# Proudly Serving the Fire & EMS Industry for Over 35 Years!

**1978**

First wheel cover created to fit a cast spoke wheel.

**1987**

First super single front wheel cover for fire trucks.

**1994**

Patents the first ever adjustable rear wheel liner.

**2003**

First stainless Grille Overlay Covers for fire trucks.

**2009**

New LED TPMS designed to meet the NFPA 1901 standards.

**2015**

More new and exciting products to come!



**1984**

RealWheels opens 2,500 sq.ft. manufacturing facility.

**1991**

Patents the first universal front axle cover to fit front wheel with 4, 5, and 6 locators.

**1997**

Patents clamp and hook mount system to mount wheel covers/simulators to wheels.

**2006**

Contract manufacturing begins making custom aluminum door handles for fire trucks.

**2012-14**

Manufacturing complete stainless grilles, light housings and fenderettes.

## RealWheels is a Proud Sponsor of the Combat Challenge



RealWheels (RWC) has proudly produced the unique custom award plaques received by the winners of the Combat Challenge. To date we have manufactured over 2300 Combat Challenge plaques that have been awarded. RWC has been a proud sponsor of the Combat Challenge since the beginning of the event. It's our great pleasure to be a part of the Combat Challenge and to help recognize all these amazing firefighters.



**PRESORTED  
STANDARD**  
US POSTAGE PAID  
GURNEE, IL  
PERMIT NO.72



*REALWHEELS CORPORATION*

**RWC**<sup>TM</sup>

AMERICAN MADE ACCESSORIES FOR THE TOYOTA FJ CRUISER



# The Ultimate Upgrade!



**Above:** The RealWheels FJ Beach Patrol Project Vehicle shown before and after its amazing transformation.

Depend on RealWheels to turn your FJ into the Ultimate On-Road or Off-Road Vehicle.

## Why Real...?

Do you demand the best? All RealWheels "Mirror-Shine" brush guards, side steps, and tail light guards are made in America from the highest quality, 304 stainless steel available. Inherently, all guard and step accessories will eventually encounter flying road debris, salt, off-road brush, or other obstacles. So, you can be certain that RealWheels' stainless products will perform to the highest standards, and never rust, tarnish or corrode. Each is built in the USA, and comes with a manufacturer's lifetime warranty.

Looking for great products, at a great price? The "Black-Finish" line of quality brush guards, tail light guards and side steps feature heavy, .065 gauge steel construction. Then, a durable powder-coated finish is applied and baked-on to resist chips or corrosion. Each is built in the USA, and comes with a 4 year warranty.

When it comes to billet accessories, the Engineers at RealWheels meticulously design each product to improve on, and enhance the vehicle's existing features. Every billet product begins as a solid block of T6061 aircraft quality aluminum. Each part is precision machined, and then polished and buffed to a mirror shine. To finish each item, they are either coated with a durable black powder-coated finish, or chromed with the industry's finest multiple-step plating process.

**Billet or Stainless, Bright or Black... Quality to the CORE!**



## THERE ARE VARIOUS TYPES OF FJ OWNERS

Some of you strive to expand on the Cruiser's strong off-road heritage that dates back to the 50's. The RealWheels design team remains committed towards developing products that live up to the Cruiser's passionate off-road legacy. Whether you choose a bright or black finish, quality and durability are never compromised.

Some desire to turn heads with a stunning street version FJ. RealWheels' custom chromed billet aluminum accessories, and stainless steel trim parts will definitely get the job done. RealWheels has designed an array of stylish accessories that will quickly set your FJ apart from others on the street.



## S.S. 3 PC GRILLE SET RW102-4-T0202 (3pc Set)

Precision laser-cut from 304 stainless steel, these grille inserts are the perfect way to give your FJ a custom look. Each installs over factory grille in minutes and offers a lifetime of style. Install as a set, or purchase individually.

- A. S.S. TOP HOOD GRILLE  
RW102-1-T0202
- B. S.S. MAIN FRONT GRILLE  
RW102-2-T0202
- C. S.S. LOWER BUMPER GRILLE  
RW102-3-T0202



## S.S. HOOD TRIM RW140-1-T0202 (2pc Set)

This trim accessory helps emphasize an important design feature found on Land Cruisers from 1955 – 1984. The parts are easily installed in minutes, and add character to the simple hood design. Each is precision laser-cut from mirror-shine, 304 stainless steel.

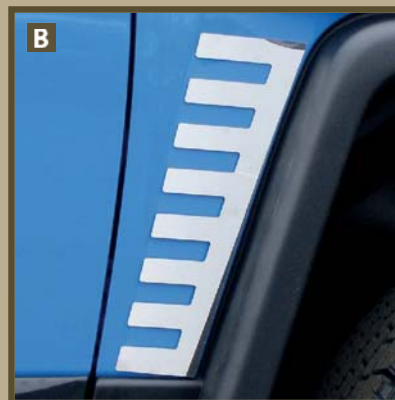
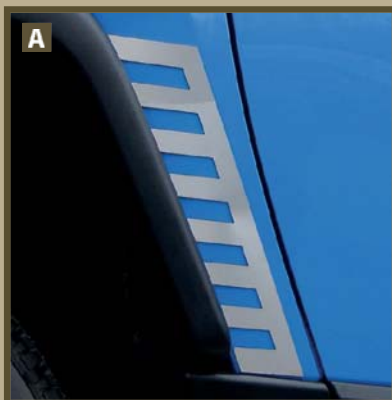

## S.S. LOGO SURROUNDS RW126-1-T0202

A perfect way to frame your new FJ emblems. Each is laser-cut from stainless steel to enhance the vehicle logos, and will never rust, pit, or corrode.



## S.S. LOWER ACCENT TRIM A. REAR: RW120-2-T0202 B. FRONT: RW120-1-T0202

Add these innovative louver-style design features to the opening of each fender. This trim design provides a sporty feature that looks like it should have come from the factory. Precision laser-cut stainless steel polished to a mirror-shine.





### S.S. TAIL LIGHT GUARDS RW306-1-T0202

The modern tail lights of the new FJ offer unique styling to the vehicle, but need some protection. Whether you're interested in function or appearance, these guards offer both. Constructed from stainless steel tubing, they install easily and securely.



### BENT S.S. TUBE WITH STEP-UP KIT RW401-5-T0202

The winning combination of stainless steel construction and the RealWheels popular Step-Up Kit create the perfect FJ side step. Built from 3" diameter 304 stainless steel, each tube is then assembled with a stainless steel cap that provides durable, non-slip footing for entering and exiting the vehicle. This exclusive system from the designers at RealWheels provides a vast improvement over the typical plastic step inserts that are found on most side steps.



## S.S. ROCKER PANELS

**Diamond-Plate: RW116-1DP-T0202**

**Mirror Shine: RW116-1-T0202**

Give the side profile of your Cruiser an instant custom look with laser-cut stainless steel side rocker panels. Installs directly over factory panels in minutes, and is guaranteed to never rust, pit or corrode.



## S.S. WINDSHIELD VENT COVERS

**RW131-1-T0202**

Precision laser-cut vent covers are a perfect way to customize your vehicle. Installs in minutes over factory vents.

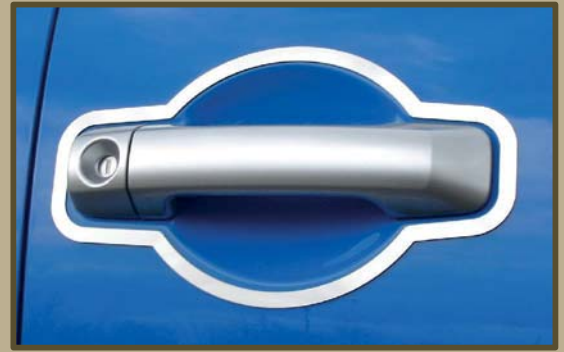

## S.S. HANDLE SURROUNDS

**RW122-1-T0202**

These attractive surrounds are precision laser-cut from mirror-finished stainless steel. Door handle surrounds provide a subtle, but stylish enhancement to the FJ, complimenting the silver tones of the wheels and bumpers.



## S.S. EXHAUST TIP

**RW308-1-T0202**

This 304 stainless steel tip will completely outlast any chrome tip. Polished to a mirror-shine, they are installed in seconds for a lifetime of good looks.

## S.S. WINDOW TRIM

**RW139-1-T0202**

Give the side profile of your Cruiser an instant custom look with laser-cut stainless steel trim. Installs in minutes and is guaranteed to never rust, pit, or corrode.



# RealBillet™

MIRROR FINISH BILLET ALUMINUM

Billet Aluminum Accessories are precision machined from solid blocks of billet aluminum, hand polished to a mirror-shine, then coated with the industry's finest chrome plating for the ultimate in quality.



## BILLET GEAR SHIFTERS

**RW223-1-T0202 (Large Knob)**

**RW223-2-T0202 (Small Knob)**

**RW223-3-T0202 (Combo)**



Precision machined from solid blocks of billet aluminum, these Shifter Knobs feature rubber rings for sure grip. Each are polished by hand to a mirror shine, and then plated with the

industry's finest chrome process. For FJs with automatic transmission. Installation is easy—simply screw on.



## BILLET MARKER LIGHT

**RW222-1-T0202**

The FJ's designers are proud that the small indicator lamps, which are part of the side mirrors, made it to production. RealWheels used their precision machining process to enhance these lamps with solid billet louvers.



## BILLET GAUGE CLUSTER BEZEL

**RW224-1-T0202**

Precision machined from solid blocks of billet aluminum, this Gauge Cluster Bezel is the perfect addition to the interior of your FJ. Polished by hand to a mirror shine, and then plated with the industry's finest chrome process. Installs easily.



## BILLET GRAB HANDLE

**RW216-1-T0202**

These interior grab handles are a "must have". The RealWheels team of engineers meticulously added ergonomic finger grips and design grooves that clearly illustrate their thick billet construction.



## FJ CRUISER BLACK SERIES

For those that demand the rugged and powerful appearance of black accessories, this series provides vehicle owners with proven functionality and unmatched durability.



### TAIL LIGHT GUARDS RW306-1BP-T0202

Whether you're interested in function or appearance, these guards offer both. Constructed from heavy gauge tubing and laser-cut guards. Install easily and securely.



### S.S. BLACK HOOD TRIM RW140-1BP-T0202 (2pc Set)

This trim accessory helps emphasize an important design feature found on Land Cruisers from 1955 – 1984. The parts are easily installed in minutes, and add character to the simple hood design. Each is precision laser-cut from 304 stainless steel then coated with a durable black finish.





## **RealBillet™**

BLACK FINISH BILLET ALUMINUM

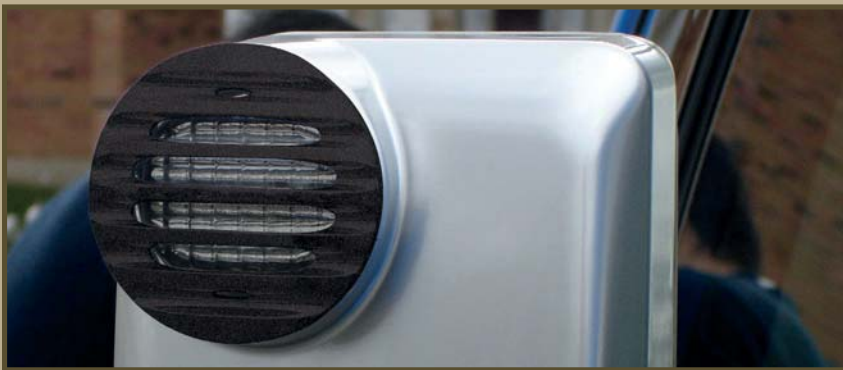

### **BILLET MARKER LIGHT** **RW222-1BP-T0202**

The FJ's designers are proud that the small indicator lamps, which are part of the side mirrors, made it to production. RealWheels used their precision machining process to enhance these lamps with solid billet louvers. Each are finished with a durable black powder-coat.



### **BILLET GRAB HANDLE** **RW216-1BP-T0202**

Precision machined from solid blocks of billet aluminum, these interior grab handles are a "must have". The RealWheels team of engineers meticulously added ergonomic finger grips and design grooves that clearly illustrate their thick billet construction.



## BENT TUBE WITH S.S. STEP-UP KIT RW401-5BP-T0202

The winning combination of black powder coated tube construction and the RealWheels popular stainless steel Step-Up Kit create the perfect FJ side step. Built from 3" diameter tubing and assembled with an extra wide stainless steel step that provides durable, non-slip footing for entering and exiting the vehicle. This exclusive system from the designers at RealWheels provides a vast improvement over the typical plastic step inserts that are found on most side steps.



## S.S. LOWER ACCENT TRIM

**A. REAR: RW120-2BP-T0202**

**B. FRONT: RW120-1BP-T0202**

Add these innovative louver-style design features to the opening of each fender. This trim design provides a sporty feature that looks like it should have come from the factory. Choose front trim, rear trim, or both. Precision laser-cut stainless steel with a durable black finish.



## S.S. LOGO SURROUNDS RW126-1BP-T0202

These attractive surrounds are precision laser-cut from stainless steel and then coated with a durable black finish. Logo surrounds are a perfect way to frame your new FJ emblems.



## S.S. HANDLE SURROUNDS RW122-1BP-T0202

These attractive surrounds are precision laser-cut from stainless steel and then coated with a durable black finish. Door handle surrounds provide a more balanced appearance to the FJ, complementing the many black features of the vehicle's lower half.







Easily tilts forward with pneumatic cylinder assistance



## FJ CRUISER BRUSH GUARDS

All RealWheels "Mirror-Shine" brush guards are made in America from highest quality, 304 stainless steel available. Inherently, all guards will eventually encounter flying road debris, salt, off-road brush, or other obstacles. So, you can be certain that RealWheels' stainless products will perform to the highest standards, and never rust, tarnish or corrode. Each is built in the USA, and comes with a manufacturer's lifetime warranty.

Looking for great products, at a great price? The "Black-Finish" line of quality brush guards feature heavy, .065 gauge steel construction. Then, a durable powder-coated finish is applied and baked-on to resist chips or scratches. Each is built in the USA, and comes with a 4 year warranty.

### OVER-THE-TOP BRUSH GUARD **Shown Above**

**Stainless Steel: RW304-2-T0202**

**(Without Inserts: RW304-1-T0202)**

**Black: RW304-2BP-T0202**

**(Without Inserts: RW304-1BP-T0202)**



The most aggressive brush guard available for your FJ. RealWheels provides a more appropriate look for the FJ by using significantly larger diameter stainless tubing to produce these impressive guards, with a custom wrap-around styling. Available with or without horizontal inserts.

### FRONT BULL BAR **Shown Above**

**Black: RW311-1BP-T0202**

**Stainless Steel: RW311-1-T0202**

This Bull Bar adds extra front-end protection and is a great finishing addition to your FJ. Bull Bars are manufactured from 2.5" diameter tubing. Choose from mirror-shine stainless steel or black powder coated steel tubing.

REALWHEELS CORPORATION





RW302-1-T0202



RW300-2-T0202

## S.S. Double-Tier Brush Guard:

**RW302-1-T0202**  
(With Inserts: RW302-2-T0202)

This Wrap Around Guard adds a second tier for more protection and aggressive appearance.

## S.S. Wrap Around Brush Guard:

**RW300-2-T0202**  
(Without Inserts: RW300-1-T0202)



RW310-3-T0202



RW310-1-T0202

## S.S. Custom Brush Guard

**RW310-1-T0202**  
With Extensions:  
**RW310-3-T0202**

Available with extensions for a more aggressive appearance.

KC Lights Sold Separately.





RW302-2BP-T0202



RW300-2BP-T0202



**Double-Tier Brush Guard:**

**RW302-2BP-T0202**  
(Without Inserts: RW302-1BP-T0202)

This Wrap Around Guard adds a second tier for more protection and aggressive appearance.

**Wrap Around Brush Guard:**

**RW300-2BP-T0202**  
(Without Inserts: RW300-1BP-T0202)

REALWHEELS CORPORATION



RW310-3BP-T0202



RW310-1BP-T0202

**Custom Brush Guard  
RW310-1BP-T0202  
With Extensions:  
RW310-3BP-T0202**

Available with extensions for a more aggressive appearance.  
KC Lights Sold Separately.



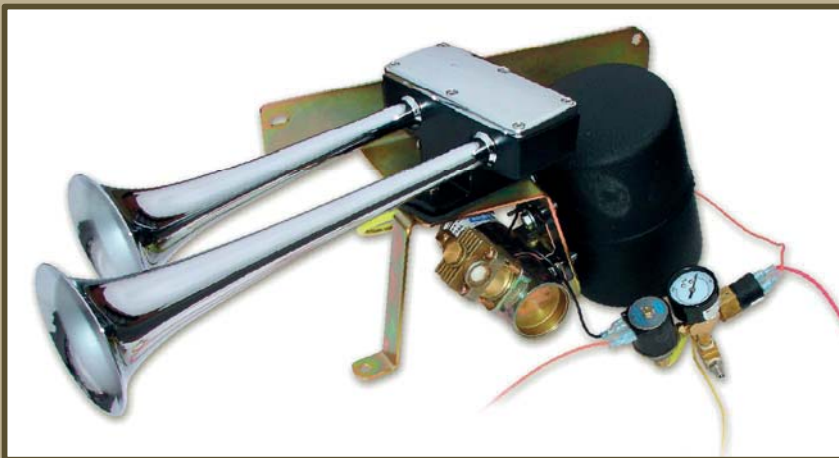

## AIR HORN SYSTEM **RW502-1-T0202**

Over 135 decibels of powerful dual horns provide a freight train-like announcement of your arrival. Features a compressor for adding air to your tires in a remote location, or inflating those rafts and toys at the beach. The horns have an exclusive sound chamber design, rugged die-cast construction, stainless steel diaphragm, and are chrome plated. This Easy-to-Install system bolts right into existing space under the hood with NO Drilling. Connect the system two ways: Full time – Blows the air horn every time you hit the steering wheel horn switch; Or... Part time – Allows you to simply switch off the air horn whenever there might be a need to be discreet.



## FJ WHEELS

### **RW508-3-T0202**

17x8 Chrome Wheel  
(Use with factory tire)

### **RW508-1-T0202**

18x8.5 Chrome Wheel with  
285/60/R18 Tire

### **RW508-2-T0202**

18x8.5 Chrome Wheel with  
325/60/R18 Tire for lifted  
trucks only



### **RW508-3BP-T0202**

17x8 Black Wheel  
(Use with factory tire)

### **RW508-1BP-T0202**

18x8.5 Black Wheel with  
285/60/R18 Tire

### **RW508-2BP-T0202**

18x8.5 Black Wheel with  
325/60/R18 Tire for lifted  
trucks only



## ROUGH COUNTRY 3" LIFT KIT **RW760S-1-T0202**

- Fits 285/70 R17 tires with no rubbing or trimming of the fender well
- Runs factory wheels with 285/70 R17 tires.
- Easy Install - No strut compressor is required.
- Rear shocks manufactured with recoil cut-off construction.

### INCLUDES:

Front strut extensions, rear luxury ride coil springs, and rear RC Nitro 9000 shocks with jounce bumpers.

REALWHEELS CORPORATION





## LIGHT BAR

### **RW604-1BP-T0202**

Whether you plan to turn night into day with multiple roof-mounted lights, or just need an extra mounting location for getting that canoe to the water, this light bar is the perfect accessory. The bar installs securely and easily in minutes, and the black powder-coated finish complements the vehicle's design. Includes welded mounting tabs for up to 4 lights. *KC Lights Sold Separately.*

## KC SLIMLITE® DRIVING KITS (100 Watt)

### **RW509-1-A0102 (Chrome)**

### **RW509-2-A0102 (Black)**

KC SlimLites feature a unique 6" round housing with a sleek, flat profile that allows them to fit where others won't. Optical quality glass lens, halogen bulb, and precision polished reflectors combine to generate a "super-bright" and specially focused beam of light. Available in chrome and black powder coated finishes. Kit includes 2 KC SlimLites, 2 protective stone guards, and pre-terminated relay wiring harness. (Long Range and Fog Light Kits also available.)

**RW509-2-A0202**



**RW509-1-A0202**



**REALWHEELS**  
*Accessories*



Accessories for the Hummer H1, H2, SUT & H3



**REALWHEELS**  
CRISS ANGEL  
**MINDFREAK**  
**PROJECT**



## It's dark, extremely loud, completely customized, and a little bizarre...



Picture this... it's Halloween in Las Vegas. Award-winning Illusionist Criss Angel is ready to reveal a mysterious magic-themed, custom vehicle. Over 100,000 aftermarket industry professionals share in the excitement as the star of the A&E television series "MindFreak" unveils the "MindFreak H2".

Known in the industry for its highly customized show vehicles, RealWheels Accessories faces the annual challenge of creating a vehicle that will top their

previous projects. Vice President Jhan Dolphin comments, "I've always been a big fan of magic. With SEMA 2006 opening on Halloween, we were presented with the perfect opportunity to create something very unusual. When I shared our vision with Criss, he was thrilled to be part of the project." And so, with the help of over 25 vehicle sponsors, RealWheels Accessories spent endless summer days creating the "MindFreak H2" that was presented by Criss Angel at SEMA Show 2006.

Built in the spirit of Criss Angel's A&E series "Mindfreak", the more one looks at this vehicle, the more interesting and unusual things one will find.

### **MindFreak Project Vehicle Sponsors**

- ACE Alloy
- AutoLoc
- Belanger Headers
- BF Goodrich
- CORSA
- Custom Painted Vehicles
- DMH Performance
- Drive Soft
- Extreme Finish & Trim
- Fabulous Graphics
- Farenheit USA
- FAZE Gauge
- Ground Force
- KC HiLites
- Magic Castle
- Magical Industries
- Martinka Magic
- Maxxsonics, USA
- Monster Cable Products
- Ohio Generator
- Optima
- ProCharger
- RealWheels Accessories
- Showtime Audio
- StreetGlow
- TCI Automotive
- Yonaka Motorsports

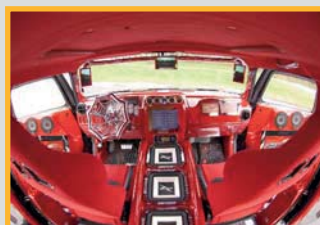



**H2****CHROME PLATED BILLET ALUMINUM**

# RealBillet™

**MIRROR FINISH BILLET ALUMINUM**

## **H2 OVERSIZED CHROME PLATED BILLET ALUMINUM**

Part of what attracts us to the H2 is its impressive size and dominating stature. So, why settle for the small, plastic factory parts? Go large with the wide variety of RealWheels Oversized Chrome Billet Aluminum accessories. Each part is precision machined from solid blocks of billet aluminum, hand polished to a mirror shine, and plated with the industry's finest chrome process for the ultimate in quality. The RealWheels team has meticulously added grooved design features to intensify the light-reflective qualities of each part and reinforce the appearance of thick billet construction. Because when you've decided to add style-enhancing accessories to your H2, size does matter.



*Factory plastic trim shown next to RealWheels Custom Oversized Billet Aluminum Trim*



- A. Hood Latches With Stainless Steel Surround Piece  
MODEL: RW201-1-A0102
- B. Side Vents  
2004 & UP MODEL: RW203-2-A0102  
2003 MODEL: RW203-1-A0102
- C. Front or Rear Upper Marker Light Covers  
MODEL: RW208-1-A0102
- D. Grooved Seat Control Panel  
MODEL: RW214-1-A0102
- E. Rear Grooved Pull Handle With Interior Finger Grips  
MODEL: RW213-1-A0102
- F. Grooved End Caps & Cross Bar Knobs  
CAPS: RW212-1-A0102  
KNOBS: RW211-1-A0102  
*One Minute Installation!*
- G. Rear Upper Louvers  
MODEL: RW210-1-A0102
- H. Grooved Interior Grab Handles  
MODEL: RW216-1-A0102



For those who enjoy the powerful look of black accessories, or put their skills to the test off-road, we offer all of our oversized billet aluminum parts in a durable electrostatic, black powder coated finish. See price list for model numbers and pricing.

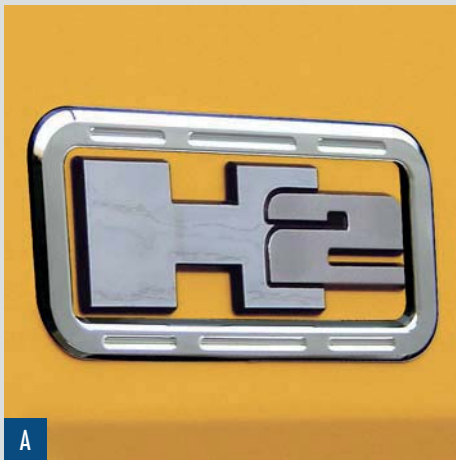

A

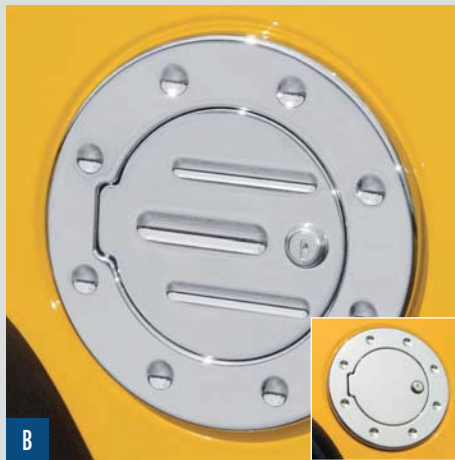

B



C



D



E



F



G



H



I

A. H2 Logo Surround  
MODEL: RW220-1-A0102

B. Locking Fuel Door\*  
GROOVED: RW202-2-A0102  
SMOOTH: RW202-1-A0102

C. Non-Locking Fuel Door\*  
SMOOTH: RW202-1-NA0102  
GROOVED: RW202-2-NA0102

D. Grooved Door Handle Surrounds\*  
SURROUNDS: RW204-4-A0102  
PULL HANDLE: RW205-2-A0102  
(Pulls sold separately)

E. Grooved Hood Handles  
MODEL: RW200-2-A0102

F. Smooth Hood Handles  
MODEL: RW200-1-A0102

G. Smooth Door Handle Surrounds\*  
(shown with factory pull handle)  
MODEL: RW204-3-A0102

H. Billet Aluminum Door Handle Overlays\*  
MODEL: RW215-2-A0102  
*Installs In Minutes! No Need To Remove  
Factory Door Handle.*

I. Side Marker Light Covers  
MODEL: RW207-1-A0102

*\*New Universal Design fits all models including 2006 and up!*

# *RealStainless*<sup>TM</sup>

MIRROR FINISH STAINLESS STEEL



## **H2 STAINLESS STEEL TRIM**

RealWheels Stainless Steel Accessories are made from heavy-gauge, high quality 304L stainless steel that is absolutely guaranteed not to rust, pit, corrode, or ever lose its shine. Installation is so easy that within minutes you'll transform your H2 into one that breaks away from the crowd!



### MIRROR SHINE OR DIAMOND PLATE— THE CHOICE IS YOURS!

RealWheels Stainless Steel Accessories are available in two great finishes for you to choose from. Our Classic Mirror Shine finish casts a brilliant reflection that will make your vehicle outshine the rest. The Diamond Plate products, textured with a diamond pattern, offer a rugged off-road look that screams adventure!



A. Top Side Trim  
MODEL: RW115-1-A0102\*

B. Side Rocker Panels  
MODEL: RW116-1-A0102\*

C. Slotted Top Side Trim  
MODEL: RW115-2-A0102\*<sup>50</sup>

D. Slotted Side Rocker Panels  
MODEL: RW116-2-A0102\*<sup>50</sup>

E. Upper Rear Louver Covers  
MODEL: RW118-1-A0102\*

F. Door Panel Inserts  
MODEL: RW117-1-A0102\*

\*Model numbers reflect a Mirror-Shine Finish. See price list for Diamond Plate Finish <sup>50</sup> model numbers.

<sup>50</sup> Special order items may take 4-8 weeks to deliver.



A. Hood Latch Surrounds  
MODEL: RW119-1-A0102\*

B. Side Vent Covers  
2003: RW120-1-A0102\*  
2004-2006: RW120-2-A0102\*

C. Side Mirror Bezels  
MODEL: RW121-1-A0102\*

D. Fuel Tank Bezels  
MODEL: RW125-1-A0102\*

E. Side Marker Light Bezels  
MODEL: RW123-1-A0102\*

F. Door Handle Bezels  
MODEL: RW122-1-A0102\*

G. Logo Surround Bezels  
MODEL: RW126-1-A0102\*

H. Rear Upper Marker Light Bezels  
MODEL: RW124-1-A0102\*

I. Head Light Surrounds  
MODEL: RW128-1-A0102\*

J. Back Mirror Plates  
MODEL: RW132-1-A0102\*



\*Model numbers reflect a Mirror-Shine Finish. See price list for Diamond Plate Finish<sup>50</sup> model numbers.

<sup>50</sup> Special order items may take 4-8 weeks to deliver.



*RealStainless*™  
MIRROR FINISH STAINLESS STEEL



A



B



C



D



E



F

A. Door Sill Letter Overlays  
MODEL: RW113-1-A0102\*

B. Windshield Vent Cover  
MODEL: RW131-1-A0102\*

C. Lower Grille Overlay  
MODEL: RW102-1-A0102\*

D. Large Rear Bumper Letter Inserts  
MODEL: RW110-1-A0102\*

E. Rear License Plate Surround  
MODEL: RW109-1-A0102\*

F. Roof Rack Crossbar Letters & Panel Kit  
PACKAGE: RW112-1-A0102\*  
LETTERS ONLY: RW111-1-A0102\*

\*Model numbers reflect a Mirror-Shine Finish. See price list for Diamond Plate Finish <sup>50</sup> model numbers.

<sup>50</sup> Special order items may take 4-8 weeks to deliver.



SAVE ON THE COMPLETE SET!

A. Rear Upper & Lower Bumper Overlay Kit  
STANDARD: RW108-1-A0102\*  
SLOTTED: RW108-2-A0102\*<sup>50</sup>  
(Letters & Tow Hooks Sold Separately)



SAVE ON THE COMPLETE SET!

B. Front Upper & Lower Bumper Overlay Kit  
STANDARD: RW105-1-A0102\*  
SLOTTED: RW105-2-A0102\*<sup>50</sup>



C. Rear Upper Bumper Overlay Kit  
MODEL: RW106-1-A0102\*  
(Letter Inserts Sold Separately)

E. Slotted Rear Upper Bumper Overlay Kit  
MODEL: RW106-2-A0102\*<sup>50</sup>  
(Letter Inserts Sold Separately)

G. Rear Lower Bumper Overlay Kit  
MODEL: RW107-1-A0102\*  
(Letters & Tow Hooks Sold Separately)

D. Front Upper Bumper Overlay Kit  
MODEL: RW103-1-A0102\*

F. Slotted Front Upper Bumper Overlay Kit  
MODEL: RW103-2-A0102\*<sup>50</sup>

H. Front Lower Bumper Overlay Kit  
MODEL: RW104-1-A0102\*

\*Model numbers reflect a Mirror-Shine Finish. See price list for Diamond Plate Finish model numbers.

<sup>50</sup> Special order items may take 4-8 weeks to deliver.





**RealStainless™**  
BLACK FINISH STAINLESS STEEL

## H2 BRUSH & TAIL LIGHT GUARDS

Customizing your H2 is half the fun of owning it. From “mild to wild”, only RealWheels offers such an impressive selection of brush guards to adorn your vehicle. Unlike the common 1” diameter factory brush guards, these heavy-duty styles are produced from a combination of 1 $\frac{5}{8}$ ” and 2” diameter polished stainless steel that won’t rust, pit, corrode, or lose its shine. And, like all RealWheels products, these parts are easy to install and come with step-by-step instructions.





A

KC Slimlites are available for all brush guards. See page 22 for details.



B



C



D

Shown with black powder coated finish.\*



E



F

A. Stainless Steel, Standard Brush Guard With Inserts  
MODEL: RW300-2-A0102

B. Stainless Steel, Standard Brush Guard Without Inserts  
MODEL: RW300-1-A0102

C. Stainless Steel, Single-Tier, Wrap Around Brush Guard Without Inserts<sup>50</sup>  
MODEL: RW301-1-A0102

D. Black Powder Coated, Stainless Steel, Single-Tier, Wrap Around Brush Guard With Inserts  
MODEL: RW301-2BP-A0102<sup>50</sup>

E. Stainless Steel, Rear Tail Light Guards  
MODEL: RW306-1-A0102

F. Black Powder Coated Rear Tail Light Guards  
MODEL: RW306-1BP-A0102

<sup>50</sup> Special order items may take 4-8 weeks to deliver.

\*All stainless steel brush guards are available with a mirror or black powder coated finish. See price list for a complete list of model numbers and pricing.



A. Stainless Steel, Double-Tier, Wrap Around Brush Guard With Inserts  
MODEL: RW302-2-A0102

B. Stainless Steel, Double-Tier, Wrap Around Brush Guard Without Inserts  
MODEL: RW302-1-A0102

C. Stainless Steel, Over-The-Hood, Wrap Around Brush Guard With Inserts  
*Includes grooved billet hood handles!*  
MODEL: RW304-2-A0102<sup>50</sup>

D. Stainless Steel, Over-The-Hood, Wrap Around Brush Guard Without Inserts  
*Includes grooved billet hood handles!*  
MODEL: RW304-1-A0102<sup>50</sup>

E. Black Powder Coated, Double-Tier, Wrap Around Brush Guard With Inserts  
MODEL: RW302-2BP-A0102

F. Black Powder Coated, Double-Tier, Wrap Around Brush Guard Without Inserts  
MODEL: RW302-1BP-A0102

G. Black Powder Coated, Over-The-Hood, Wrap Around Brush Guard With Inserts  
*Includes grooved black powder coated hood handles!*  
MODEL: RW304-2BP-A0102<sup>50</sup>

H. Black Powder Coated, Over-The-Hood, Wrap Around Brush Guard Without Inserts  
*Includes grooved black powder coated hood handles!*  
MODEL: RW304-1BP-A0102<sup>50</sup>

<sup>50</sup> Special order items may take 4-8 weeks to deliver.

# RealStainless™

MIRROR FINISH STAINLESS STEEL



## H2 SIDE STEPS

For those who appreciate "show truck" styling, RealWheels offers the ultimate eyecatchers with its diverse selection of side steps! All tubes are produced from the highest quality, hand polished, 304 stainless steel. Each extra-wide step is produced from polished stainless steel for lasting shine and durability. Or, for the ultimate in class and style, upgrade your steps with Solid Billet Aluminum Steps.



*All stainless steel side steps are available with a black powder coated finish. See price list for model numbers and pricing.*

**A**

- A. Exhaust Bar Tube with S.S. Step and S.S. Upper Tube Facade  
**LED LIGHTED BACK PLATES: RW404-6-A0102**  
**PLAIN BACK PLATES: RW404-5-A0102<sup>50</sup>**  
**WITHOUT BACK PLATES: RW404-4-A0102**  
 Note: Tube only simulates the look of an exhaust pipe. It does not connect to or function as an exhaust system.
- B. Replacement S.S. Step. Same Extra Wide Step used on our tubes can be easily installed on your factory tube.  
**REPLACEMENT STEP: RW420-2-A**  
**LED LIGHT KIT: RW420-2L-A (sold separately)**
- C. Upper Side Step Facade Only  
**MODEL: RW400-1-A0102**

**B****C**

<sup>50</sup> Special order items may take 4-8 weeks to deliver.



A

LED Lighted Back Plates



Plain Back Plates



Without Back Plates



B

LED Lighted Back Plates



Plain Back Plates



Without Back Plates



C

LED Lighted Back Plates



Plain Back Plates



Without Back Plates

A. Bent S.S. Tube with S.S. Step  
and S.S. Upper Tube Facade  
LED LIGHTED BACK PLATES: RW401-6-A0102  
PLAIN BACK PLATES: RW401-5-A0102<sup>50</sup>  
WITHOUT BACK PLATES: RW401-4-A0102

B. Straight S.S. Tube with S.S. Step  
and S.S. Upper Tube Facade  
LED LIGHTED BACK PLATES: RW402-6-A0102  
PLAIN BACK PLATES: RW402-5-A0102<sup>50</sup>  
WITHOUT BACK PLATES: RW402-4-A0102

C. Torpedo S.S. Tube with S.S. Step  
and S.S. Upper Tube Facade  
LED LIGHTED BACK PLATES: RW403-6-A0102  
PLAIN BACK PLATES: RW403-5-A0102<sup>50</sup>  
WITHOUT BACK PLATES: RW403-4-A0102

<sup>50</sup> Special order items may take 4-8 weeks to deliver.



## **H2 TOP GRILLES & HOOD HANDLES**

No one comes close to RealWheels' variety and quality of top grilles. Our Stainless Steel models are available in Classic Mirror Shine and Diamond Plate Off-Road Series finishes and are made from high-quality 304 stainless steel. Or, go all the way with a Billet Aluminum Top Grille that is precision machined from a solid block of billet aluminum.

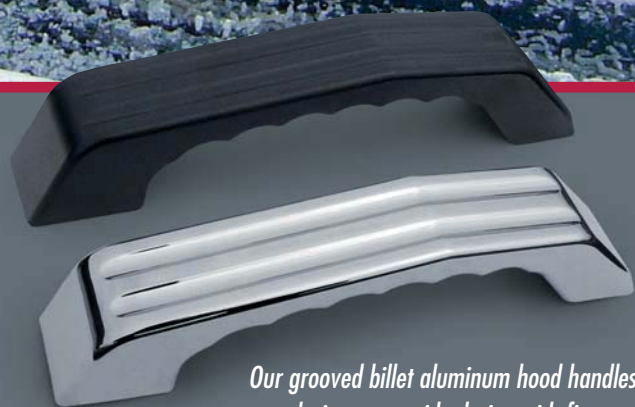

*Our grooved billet aluminum hood handles feature an exclusive extra-wide design with finger grips and are available in a chrome plated or black powder coated finish.*

### 1-PC STAINLESS TOP GRILLE WITH BILLET ALUMINUM HANDLES

This one-piece stainless steel grille replaces the black plastic grille, and is further enhanced with RealBillet hood handles.

MODEL: RW101-5-A0102

**New!**

*RealStainless™*



### OVER-THE-POCKET, BILLET ALUMINUM

A. Over-The-Pocket, 6 Vertical Slats Top Grille With Grooved Billet Aluminum Hood Handles MODEL: RW209-3-A0102

B. Over-The-Pocket, 5-Louver Top Grille With Grooved Billet Aluminum Hood Handles MODEL: RW209-1-A0102





**A****OVER-THE-POCKET, STAINLESS STEEL OVERLAY**

A. Over-The-Pocket, 7-Louver Top Grille With Grooved Billet Aluminum Hood Handles & Louvers Under Handles  
**MODEL: RW101-2-A0102\***

**Before****B****POCKETED, STAINLESS STEEL OVERLAY**

B. Pocketed, 7-Louver Top Grille Overlay With Inserts & Smooth Or Grooved Billet Aluminum Hood Handles  
**SMOOTH HANDLES: RW100-3-A0102\***  
**GROOVED HANDLES: RW100-4-A0102\***

**C**

C. Pocketed, 7-Louver Top Grille Overlay  
**GRILLE OVERLAY ONLY: RW100-1-A0102\***

\*Model numbers reflect a Mirror-Shine Finish. See price list for Diamond Plate model numbers.



## DEEP, BIG RIG SOUND!

**Improved  
Design**

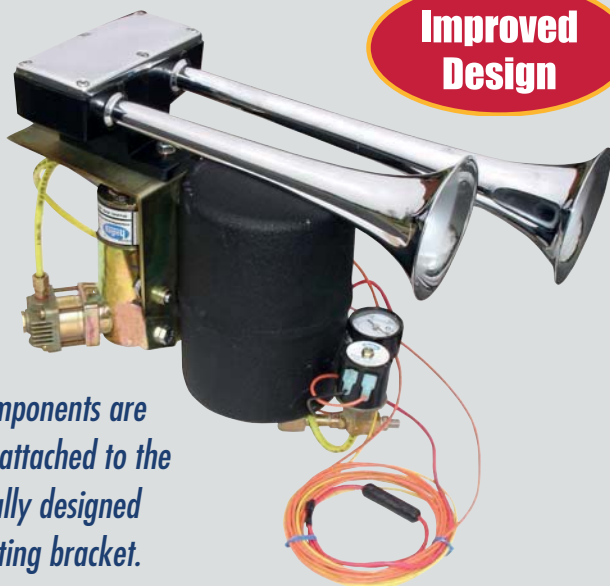

*All components are already attached to the specially designed mounting bracket.*

Roof Mount



Under Hood Mount



### NEW & IMPROVED AIR HORN

With full tank pressure up to 135 psi, this on board air system will not only blow you away with the sound of it's horns, but can also pump up anything else you need. Horn has an exclusive sound chamber, rugged die-cast construction, stainless steel diaphragm, and chrome plating. Doubles as an on board air compressor for external use. Entire unit mounts under the hood with the option of mounting the air horns on the top of the vehicle. Fully assembled for easy installation. Includes everything needed: Dual horns, electric compressor, air tank, hoses, fittings, mounting brackets, extension, and coiled air hose.

Horn Measurement: 15¼"L x 7"W x 3¾"H; Decibels: 135 db  
MODEL: RW502-1-A0102



### LED LIGHTED BILLET ALUMINUM AND STAINLESS STEEL



Placed behind parts such as the rear billet upper louvers and side vents, these LED's reflect from various angles creating a jewel-like appearance.

LED LIGHTED LOUVERS: RW700-1-A0102  
 FRONT & REAR CROSS BAR: RW701-3-A0102  
 FRONT CROSS BAR ONLY: RW701-2-A0102  
 REAR CROSS BAR ONLY: RW701-1-A0102

*Note: Includes lights only. Louvers & cross bars sold separately. LED's only work with RW210-1-A0102*



Front



Rear

### CUSTOM LED LIGHT PACKAGE

These Custom LED Lights come complete with chrome bezels and stainless steel inserts. Easy installation with heavy duty 3M tape. Three small drill holes required. Ready to wire into Marker Lights.

MODEL: RW503-1-A0102



### STAINLESS STEEL ROOF RACK

This innovative roof rack provides both, secure storage and rugged style. The design nicely complements the vehicle's contours, and offers the durability of stainless steel construction. The unassembled rack ships easily to your location, and installs in minutes.

STAINLESS STEEL (SHOWN ABOVE): RW309-1-A0102

BLACK POWDER COATED S.S. (SEE PAGE 32): RW309-1BP-A0102



### KC SLIMLITE® DRIVING KITS (100 WATT)

KC SlimLites feature a unique 6" round housing with a sleek, flat profile that allows them to fit where others won't. Optical quality glass lens, halogen bulb, and precision polished reflectors combine to generate a "super-bright" and specially focused beam of light. Available in chrome and black powder coated finishes. Kit includes 2 KC SlimLites, 2 protective stone guards, and pre-terminated relay wiring harness. (Long Range and Fog Light Kits also available.)

CHROME: RW509-1-A0102; BLACK: RW509-2-A0102



**STAINLESS STEEL TOW HOOKS**

- FRONT & REAR TOW HOOKS WITH BOLT COVERS: RW506-3-A0102
- FRONT & REAR TOW HOOKS WITHOUT BOLT COVERS: RW506-2-A0102
- FRONT TOW HOOKS: RW504-1-A0102
- REAR TOW HOOKS WITH BOLT COVERS: RW505-1-A0102
- REAR TOW HOOKS WITHOUT BOLT COVERS: RW505-2-A0102
- REAR BOLT COVERS ONLY: RW506-1-A0102

**Pull tested to 18,000 lbs!**

These stainless steel tow hooks can withstand the heaviest loads. Manufactured from high quality stainless steel, tow hooks will not rust like black or chrome plated tow hooks. Easy to install.

**CHROME PLATED PLASTIC AIR CLEANER COVERS**

These rugged, form fitted, chrome plated plastic air cleaner covers simply install over your existing body colored air cleaner covers, transforming them into a distinctive feature. **MODEL: RW501-1-A0102**



**CHROME PLATED FRONT SKID PLATE**

Give your existing Front Skid Plate a mirror shine finish! Send in your Skid Plate and we will polish it by hand and chrome plate it for the ultimate shine. Exchange program available. Also available in black. **MODEL: RW500-1-A0102**

**CORSA RSC SPORT PERFORMANCE EXHAUST SYSTEM**

This exhaust system offers a quiet and comfortable sound when cruising, but pounce on the throttle and hear this powerful system come alive! Dyno-proven 10 plus horsepower/6 ft lbs of torque gain; Dual Pro-series 4" polished exhaust tips; Made of 100% 304L stainless steel; Direct bolt-on installation; 50-state emissions legal; Guaranteed by CORSA for as long as you own your H2 (See CORSA's Limited Warranty for details.) **MODEL: RW510-1-A0102**



**DRASTICALLY INCREASE YOUR HUMMER'S PERFORMANCE!**

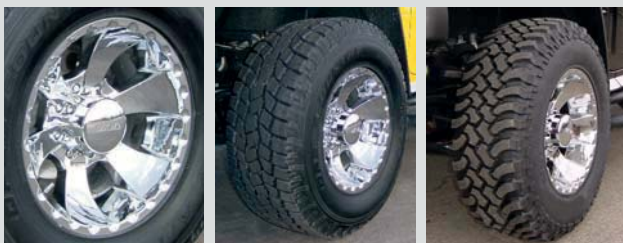

**Chrome Wheel**

**All Terrain Tire**

**Mud Tire**

**CHROME WHEELS & ALL TERRAIN OR MUD TIRES**

The Chrome Wheels with All Terrain Tires provide a smooth ride without heavy road noise. Or, choose the Mud Terrain Tires for an off-road look and traction. Chrome Wheels have a 3-year warranty.

- 18" CHROME WHEELS WITH ALL TERRAIN TIRES: RW508-1-A0102
- 18" CHROME WHEELS WITH MUD TIRES: RW508-2-A0102
- 17" CHROME WHEELS ONLY: RW508-3-A0102 (For Use With Factory Tires)

**BELANGER HEADERS**

Belanger has over 50 years experience building the best headers in the business. These super long tube, full size headers add measurable horsepower and impressive 40 ft. lbs. of torque. Laser-cut flanges; Emissions compliant, utilizing factory catalytic converters; High temp ceramic nickel chrome coating; Does not trigger "check engine" light; Includes headers, gaskets, hardware, hookups, and instructions. **MODEL: RW511-1-A0102**



*RealStainless*<sup>™</sup>  
MIRROR FINISH STAINLESS STEEL

**STAINLESS STEEL ROLL BARS**

Made from 3" diameter polished or black powder coated stainless steel, RealWheels Roll Bars won't rust, pit, corrode, or lose their shine. No drilling necessary. Three part assembly bolts together and on in minutes. Note: Cannot be installed with Tonneau Covers.

A. Mirror Finish, Slant Back Roll Bar

MODEL: RW603-1-A0102 <sup>50</sup>

B. Black, Powder Coated, Slant Back Roll Bar

MODEL: RW603-1BP-A0102 <sup>50</sup>

C. Optional Light Rack Package (Lights sold separately) MODEL: RW604-1-A0102

D. Billet Aluminum Fuel Door — *New Universal Design fits all models including 2006 and up!*

LOCKING: RW202-3-A0102

NON-LOCKING: RW202-3-NA0102



A



C



B



D

<sup>50</sup> Special order items may take 4-8 weeks to deliver.



## Show Off Your Rear End!



- A. Tail Light Guards (Designed to fit the SUT. Also available in Black Powder Coated as shown on page 13.)  
**MODEL: RW605-1-A0102**  
**BLACK POWDER COATED MODEL: RW605-1BP-A0102**
- B. SUT Stainless Steel Letters (SUT letters only)  
**ONE SET: RW601-1-A0102**  
**MULTIPLE SETS: Special Pricing Available**

### C. TIRE CARRIER ELIMINATOR KIT

The SUT Wheel Carrier looks great, but it's not always convenient. Our Tire Carrier Eliminator Kit consists of Stainless Steel Rear Tow Hooks and a Stainless Steel License Plate Holder with an awesome LED Light. This gives you the option of removing the Wheel Carrier while retaining a finished appearance by covering the carrier bolt holes.

Without Bolt Covers **MODEL: RW600-1-A0102**  
 With Bolt Covers **MODEL: RW600-2-A0102**

# H3

## CHROME PLATED BILLET ALUMINUM



# RealBillet™

MIRROR FINISH BILLET ALUMINUM

## H3 CHROME PLATED BILLET ALUMINUM

Transform your H3 into a Hummer that demands attention with these oversized accessories! RealWheels Billet Aluminum Accessories are precision machined from solid blocks of billet aluminum, hand polished to a mirror shine, and finished using the industry's finest 6-step chrome process.



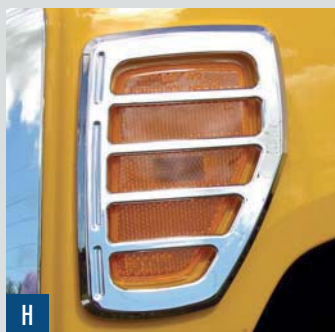

A. Seat Recline Handle  
MODEL: RW221-1-A0103

B. Stainless Steel Control Panel Surround  
MODEL: RW133-1-A0103

C. Logo Surrounds  
MODEL: RW220-1-A0103

D. Interior Grab Handle  
MODEL: RW216-1-A0103

E. Door Handle Surrounds  
MODEL: RW204-1-A0103

F. Locking Fuel Doors  
GROOVED: RW202-2-A0103  
SMOOTH: RW202-1-A0103

G. Non-Locking Fuel Doors  
GROOVED: RW202-2-NA0103  
SMOOTH: RW202-1-NA0103

H. Front Marker Light Surrounds  
MODEL: RW207-1-A0103

I. Antenna Cover  
MODEL: RW219-1-A0103

J. Top Grille with Billet Handles  
This solid aluminum grille replaces the plastic factory grille and features six 2" louvers that have been incorporated into the hood handle design.  
MODEL: RW209-3-A0102



## H3 OFF-ROAD SERIES

Great news for those who demand the rugged and powerful appearance of black accessories! RealWheels now offers the H3 Off-Road Series that includes a complete line of stainless steel accessories, billet aluminum trim parts, and unique restyling products in a durable black finish.



A. Black Textured Louvers  
MODEL: RW513-1BP-A0103

B. Billet Front Marker Light Surrounds  
MODEL: RW207-1BP-A0103

C. Non-Locking Billet Fuel Doors  
SMOOTH: RW202-1BP-NA0103  
GROOVED: RW202-2BP-NA0103

D. Locking Billet Fuel Doors  
GROOVED: RW202-2BP-A0103  
SMOOTH: RW202-1BP-A0103

E. Billet Door Handle Surrounds  
MODEL: RW204-1BP-A0103

F. Billet Antenna Cover  
MODEL: RW219-1BP-A0103

G. Billet Logo Surrounds  
MODEL: RW220-1BP-A0103

H. S.S. Step-Up Kit  
MODEL: RW420-1BP-A0103

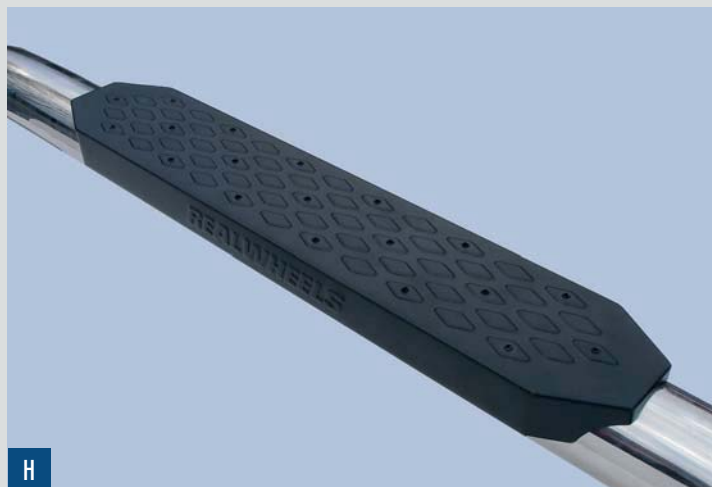

# RealStainless™

MIRROR FINISH STAINLESS STEEL



## H3 STAINLESS STEEL TRIM

Hummerize your H3 with RealWheels stainless steel accessories! Made from heavy-gauge, high quality 304L stainless steel, RealWheels stainless steel accessories are guaranteed not to rust, pit, corrode, or lose their shine. Installation is so easy that you'll transform your H3 into a Hummer that demands attention in a matter of minutes.



**A****B****C****D****E****F - G**

A. Front Bumper Overlay Kit\*  
MODEL: RW103-1-A0103

B. S.S. Rear Louvers  
MODEL: RW118-1-A0103

C. Lower Grille Overlay\*  
MODEL: RW102-1-A0103

D. Cross Bar Panel Kit  
MODEL: RW112-1-A0103

E. Top Side Trim  
MODEL: RW115-1-A0103

F. Door Panel Inserts  
MODEL: RW117-1-A0103

G. Side Sport Rails  
MODEL: RW116-1-A0103

H. Rear Door Sill  
MODEL: RW113-1-A0103

\*Letters and tow hooks sold separately.

**H**

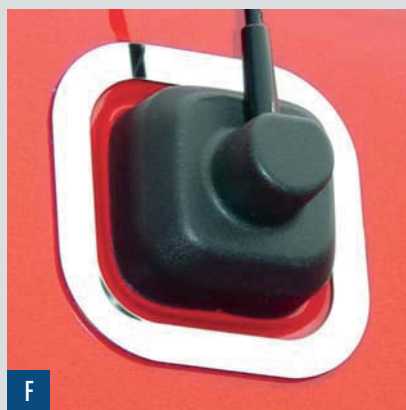

- A. Door Handle Surrounds MODEL: RW122-1-A0103
- B. Door Handle Accent Piece MODEL: RW122-3-A0103
- C. Oversized Door Handle Surrounds MODEL: RW122-2-A0103
- D. H3 Logo Surrounds MODEL: RW126-1-A0103
- E. Side Mirror Bezels MODEL: RW121-1-A0103
- F. Antenna Surround Bezel MODEL: RW134-1-A0103
- G. Fuel Tank Bezel MODEL: RW125-1-A0103
- H. Front Marker Light Surrounds MODEL: RW123-1-A0103
- I. Bumper Hummer Letters MODEL: RW110-2-A0103



**DIAMOND PLATE SERIES**

Textured with a diamond pattern, the Diamond Plate Series<sup>50</sup> offers a rugged off-road look that screams adventure! Available with all stainless steel accessories. See price list for model numbers.

<sup>50</sup> Special order items may take 4-8 weeks to deliver.

### H3 BRUSH & TAIL LIGHT GUARDS

Whether you have accessorized your H3 with off-road gear or stylish products for the city streets, RealWheels brush guards will add the finishing touch that will set your H3 apart from the rest. Constructed from large diameter, 304 stainless steel, RealWheels brush guards will not rust, pit, corrode, or lose their shine and mount quickly and securely to existing bolt locations.



Black Powder Coated, Over-The-Hood, Wrap Around S.S. Brush Guard With Inserts



A



C



B

Before



D

- A. Stainless Steel Light Bar (Includes mounting tabs for 4 lights. Lights sold separately)  
**STAINLESS STEEL (NOT SHOWN): RW604-1-A0103**  
**BLACK POWDER COATED S.S. (SHOWN): RW604-1BP-A0103**
- B. Tail Light Guards *Patent Pending*  
**STAINLESS STEEL: RW306-1-A0103**  
**BLACK POWDER COATED: RW306-1BP-A0103**
- C. Stainless Steel Roof Rack  
**POLISHED STAINLESS STEEL (SEE PAGE 22): RW309-1-A0103**  
**BLACK POWDER COATED S.S. (SHOWN ABOVE): RW309-1BP-A0103**

- D. Over-The-Hood, Wrap Around Brush Guard With Billet Aluminum Top Grille and Hood Handles. Easily tilts forward with pneumatic cylinder assistance.  
**STAINLESS STEEL WITH INSERTS: RW304-2-A0103<sup>50</sup>**  
**STAINLESS STEEL WITHOUT INSERTS: RW304-1-A0103<sup>50</sup>**  
**BLACK POWDER COATED S.S. WITH INSERTS: RW304-2BP-A0103<sup>50</sup>**  
**BLACK POWDER COATED S.S. WITHOUT INSERTS: RW304-1BP-A0103<sup>50</sup>**

<sup>50</sup> Special order items may take 4-8 weeks to deliver.



A

KC Slimlites are available for all brush guards. See page 36 for details.



E



F



B



G



H



C



D

- A. Stainless Steel, Standard Brush Guard, With Inserts  
MODEL: RW300-2-A0103
- B. Stainless Steel, Double-Tier Brush Guard, With Inserts  
MODEL: RW302-2-A0103
- C. Black Powder Coated, Stainless Steel, Standard  
Brush Guard With Inserts  
MODEL: RW300-2BP-A0103
- D. Black Powder Coated, Stainless Steel, Double-Tier  
Brush Guard With Inserts  
MODEL: RW302-2BP-A0103
- E. Stainless Steel, Standard Brush Guard,  
Without Inserts  
MODEL: RW300-1-A0103
- F. Stainless Steel, Double-Tier Brush Guard  
Without Inserts  
MODEL: RW302-1-A0103
- G. Black Powder Coated, Stainless Steel, Standard  
Brush Guard Without Inserts  
MODEL: RW300-1BP-A0103
- H. Black Powder Coated, Stainless Steel, Double-Tier  
Brush Guard Without Inserts  
MODEL: RW302-1BP-A0103

# EXHAUST BAR™

## SIDE STEPS

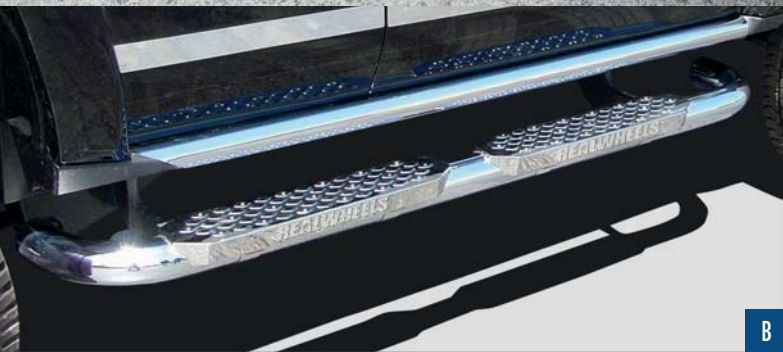

### H3 SIDE STEPS

These nerf bars are produced from the highest quality, hand polished, 304 stainless steel. Each extra-wide step is produced from polished stainless steel for lasting shine and durability. Optional sport rails add the finishing touch.

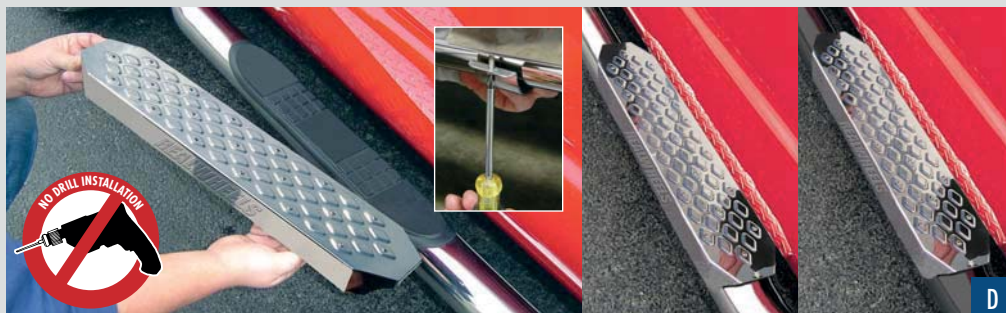

Mounts easily in moments. Features RealGrip non-slip surface. Looks great on factory stainless steel or black tubes.

- A. Exhaust Bar Tube with S.S. Step  
**WITH SPORT RAILS: RW404-4-A0103**  
**WITHOUT SPORT RAILS: RW404-5-A0103**  
 Tube only simulates the look of an exhaust pipe. It does not connect to or function as an exhaust system.
- B. Bent Tube with S.S. Step  
**WITH SPORT RAILS: RW401-4-A0103**  
**WITHOUT SPORT RAILS: RW401-5-A0103**
- C. Side Sport Rails Only  
**MODEL: RW116-1-A0103**
- D. Replacement S.S. Step. Same Extra Wide Step used on our tubes can be easily installed on your factory tube.  
**MODEL: RW420-1-A0103**



### 7-PC STAINLESS TOP GRILLE OVERLAY WITH BILLET HANDLES

Ideal for those who like the contrast of the black factory grille between each stainless steel louver.

WITH HOOD HANDLES: RW100-3-A0103

WITHOUT HOOD HANDLES: RW100-1-A0103



### CHROMED ABS TOP GRILLE OVERLAY WITH BILLET HANDLES

ABS cap completely covers the factory grille and offers your vehicle the impressive profile of RealBillet hood handles.

WITH HOOD HANDLES: RW512-2-A0103

WITHOUT HOOD HANDLES: RW512-1-A0103



### REALBILLET TOP GRILLE WITH BILLET HANDLES

This solid aluminum grille replaces the plastic factory grille and features six 2" louvers that have been incorporated into the hood handle design.

MODEL: RW209-3-A0103



### 1-PC STAINLESS TOP GRILLE WITH BILLET HANDLES

This one-piece stainless steel grille replaces the black plastic grille, and is further enhanced with RealBillet hood handles.

WITH HOOD HANDLES: RW101-5-A0103

WITHOUT HOOD HANDLES: RW101-4-A0103

## H3 TOP GRILLES & HOOD HANDLES

RealWheels offers a remarkable selection of top grilles to dramatically enhance the vehicle's appearance. Choose a classic stainless steel top grille or overlay, the impressive RealBillet grille, or the budget conscious ABS style. Each design can be crowned with a pair of distinctive RealBillet hood handles. These handles are the best in the business, with light reflecting grooves and ergonomic finger grips precision machined into each.



RealBillet Hood Handles feature light reflecting grooves and ergonomic finger grips. MODEL: RW200-2-A0103





**BEAUTY,  
STRENGTH  
AND EASY  
INSTALLATION!**

### THE STRONGEST TOW HOOKS AVAILABLE!

**Only RealWheels H3 Tow Hooks have been pull tested to an incredible 22,000 lbs.** Manufactured from the highest quality 17-4 stainless steel (even stronger than 304 stainless), they perform as great as they look. Don't make the mistake of installing unusable billet tow hooks. (Billet tow hooks are designed to look good only, but can be extremely dangerous if put into a situation where strength is important.) RealWheels Stainless hooks are guaranteed not to rust, unlike painted steel or chrome-plated tow hooks. The cover plate and bolt covers are made from chrome plated ABS. This design does not require the removal of the front bumper to install. Complete instructions make installation quick and easy for a lifetime of good looks and powerful functionality.

**EASY-TO-INSTALL TOW HOOKS: RW506-4-A0103**

**CLASSIC TOW HOOKS: RW506-3-A0103 (see page 23)**



### CORSA CAT-BACK STAINLESS STEEL EXHAUST

Straight-through, 2.5" nonrestrictive design specifically tuned for the vehicle. Flow bench-tested 20.2% gain in exhaust flow vs. stock muffler. All 304L stainless steel construction, crafted with pride and precision in the USA. Patented CORSA Reflective Sound Cancellation™ (RSC™) Technology. Dual rear exit with handcrafted Pro-Series 4.0" tips for enhanced vehicle appearance. No welding required; Bolt-on installation. Includes hardware and illustrated installation guide. 50-state emissions legal. Complies with 95 dB requirement when tested in accordance with SAE test procedure, J1169 (May 1998). Limited lifetime warranty for as long as you own your vehicle. **MODEL: RW510-1-A0103**



### KC SLIMLITE® DRIVING KITS (100 WATT)

KC SlimLites feature a unique 6" round housing with a sleek, flat profile that allows them to fit where others won't. Optical quality glass lens, halogen bulb, and precision polished reflectors combine to generate a "super-bright" and specially focused beam of light. Available in chrome and black powder coated finishes. Kit includes 2 KC SlimLites, 2 protective stone guards, and pre-terminated relay wiring harness. (Long Range and Fog Light Kits also available.)

**CHROME: RW509-1-A0102**

**BLACK: RW509-2-A0102**



### CHROME WHEELS & ALL TERRAIN TIRES

20" Chrome Wheels with BFGoodrich 32.5" All Terrain Tires provide a smooth ride without heavy road noise. Chrome Wheels have a 3-year warranty. **MODEL: RW508-1-A0103**



### CHROME PLATED AIR CLEANER COVERS

Rugged, form fitted, chrome plated ABS air cleaner covers simply install over your existing body colored air cleaner covers, transforming them into a distinctive feature. **MODEL: RW501-1-A0103**



### REAR BUMPER CORNER OVERLAYS

Looking for the ultimate in street-style accessories for your H3? These ABS Bumper Corner Overlays have been plated with the industry's finest chrome process, and install in minutes. **MODEL: RW514-1-A0103**



### CHROME PLATED OR BLACK LOUVERS

These louvers offer an aggressive and enhanced style to the rear and side views of the vehicle. The bold styling of these rear louvers balance the vehicle's overall stance and appearance.

**CHROME PLATED: RW513-1-A0103**

**BLACK TEXTURED: RW513-1BP-A0103**



- A. Front Bumper Cover  
AM GENERAL MODEL: 05745079
- B. Lower Guard  
AM GENERAL MODEL: 05745071

**GENUINE**

**H1 STAINLESS STEEL ACCESSORIES**

All H1 accessories are made from heavy-gauge, high quality 304L stainless steel that will not rust, pit, corrode or lose its shine. RealWheels Hummer H1 accessories are available through an AM General Hummer Dealer near you.



STAINLESS STEEL SIDE STEP



- A. Top Grille Cover  
AM GENERAL MODEL: 05745020
- B. Front Windshield Trim Kit  
AM GENERAL MODEL: 05745622
- C. Front Marker Light Trim  
AM GENERAL MODEL: 05745623



- D. Front Hood Corner Trim  
AM GENERAL MODEL: 05745627
- E. Front Winch Cover  
AM GENERAL MODEL: 05745070
- F. Turn Signal Visors  
AM GENERAL MODEL: 05745621



- A. Rear Tailgate Surround  
AM GENERAL MODEL: 05745637
- B. Rear Logo Surround  
AM GENERAL MODEL: 05745645
- C. Rear Marker Light Trim  
AM GENERAL MODEL: 05745636
- D. Tailgate Hinge Covers  
AM GENERAL MODEL: 05745643
- E. Rear Side Marker Light Bezels  
AM GENERAL MODEL: 05745630
- F. Hood Latch Cover  
AM GENERAL MODEL: 05745628
- G. Tail Light Bezel  
AM GENERAL MODEL: 05745635
- H. Bolt Cover Package  
AM GENERAL MODEL: 05745640
- I. Rear Splash Guard  
AM GENERAL MODEL: 05745641
- J. Window Rain Guards  
AM GENERAL MODEL: 05745631
- K. Rear Bumper Cover  
AM GENERAL MODEL: 05745115
- L. Lower Tow Bar Cover  
AM GENERAL MODEL: 05745632
- M. Side Rocker Panel  
*Decal of HUMMER letters sold separately.*  
AM GENERAL MODEL: 05745096

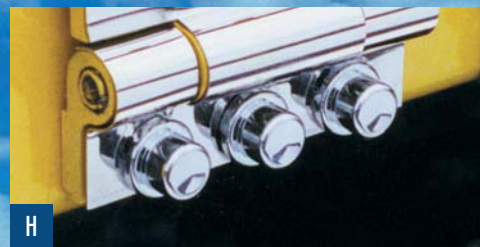



**A**



**B**

Advantage Series

American Road Series

Classic Series



**C**



**D**



**E**



**F**



**G**



**H**

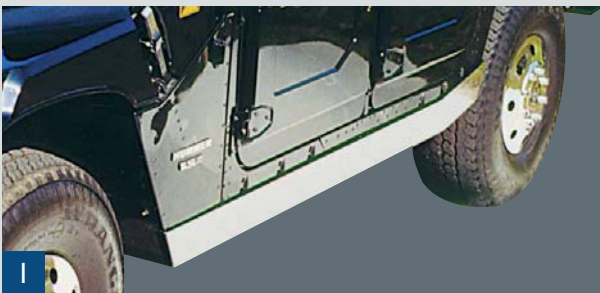

**I**



**J**



**K**

A. Air Horn (See page 21 for model & description. Bracket not included.)

B. Wheel Covers  
(4 pc set. Includes mounting brackets & lug nut covers)  
ADVANTAGE: 05745328  
AMERICAN ROAD: 05745053  
CLASSIC: 05744658

C. Head Light Bezel  
AM GENERAL MODEL: 05745626

D. Door Handle Kit  
4 DOOR: 05745102  
6 DOOR: 05745101

E. Auxiliary Fuel Tank Bezel & Insert  
AM GENERAL MODEL: 05745638

F. Main Fuel Tank Bezel & Insert  
AM GENERAL MODEL: 05745639

G. Body Panel Insert Kit (10 pc set. Includes Side Logo Surround, Door & Rear Panel Inserts)  
AM GENERAL MODEL: 05745644

H. Front Grille Cover  
AM GENERAL MODEL: 05745069

I. Side Rocker Panel  
AM GENERAL MODEL: 05745096

J. Air Intake Cover  
AM GENERAL MODEL: 05745624

K. Side Door Hinge  
AM GENERAL MODEL: 05745642

REALWHEELS CORPORATION



American-Made Jeep Wrangler Accessories





**All 304  
Stainless Steel**

## Stainless Steel Grille Guards

All RealWheels Grille Guards Feature:

- All black powder coated and mirror-finish grille guards are made from 1-5/8" 304 Stainless Steel. Guaranteed not to rust, pit or corrode.
- Aggressive styling and front-end vehicle protection.
- No need to replace whole bumper like most full guards on the market.
- Built-in light tabs for accessory lights. (Accessory lights sold separately.)
- Easy installation. No drilling required.
- Made in the USA.
- Fits all Wrangler JKs 2007 to current.

## Easy Installation



## Stainless Steel “Enforcer” Grille Guard

For Jeep fans looking for more than just a typical Jeep Accessory. This Grille Guard provides the ultimate in aggressive styling and front-end vehicle protection. Available in a durable black powder coating or polished mirror finish.

### Mirror-Finish “Enforcer” Grille Guard

RW300-3-J

### Black “Enforcer” Grille Guard

RW300-3BP-J



## Stainless Steel “Over-The-Hood” Grille Guard

Give your Wrangler that “Take No Prisoners” attitude with the boldest guard available from RealWheels Accessories. The Over-The-Hood attractive styling also makes a bold statement from the vehicle’s side profile, as this extreme guard extends 8” back over the vehicle’s hood. Durable black powder coating.

Access under the hood is achieved quickly without tools, using quick-release bolts. Installation of this powerful new guard is extremely easy, using factory mounting locations, with NO DRILLING required. Built-in light tabs provide a perfect location for your favorite accessory lights.

### Black “Over-The-Hood” Grill Guard

RW304-1BP-J



Shown with TagLites. Sold separately. See page 5.

Installation of Over-The-Hood Bar and access under the hood is achieved quickly without tools, using quick-release bolts.



All 304  
Stainless Steel



Taglights Kit

All black powder coated and mirror-finish pre-runner bars are made from 304 Stainless Steel

NEW!



### Stainless Steel 2.5" Pre-Runner Bar

- This new bar is 54% larger than our standard Pre-Runner Bar and is an ideal way to enhance the JK's tough front-end design.
- 2.5" Stainless Steel will not rust, pit or corrode.
- Available in a durable black powder coating or polished mirror finish.
- Built-in light tabs for accessory lights. (Accessory lights sold separately.)
- Installation is easy and secure. NO DRILLING required.
- Made in the U.S.A. • Fits all Wrangler JKs 2007 to current.

Mirror-Finish Stainless Steel:  
RW310-25-J

Black Powder-Coated Stainless Steel:  
RW310-25BP-J

### Stainless Steel 1-5/8" Pre-Runner Bar

The Pre-Runner Bar adds style to your JK, while enhancing its tough front-end design features. Installation is easy and secure, with NO DRILLING required. Accessory light mounting locations have been provided for a true Baja inspired appearance. (Accessory lights sold separately.) Made in the U.S.A.



Mirror-Finish Stainless Steel:  
RW310-1-J



Black Powder-Coated Stainless Steel:  
RW310-1BP-J



# Light Bar w/Light Tabs

If you plan to turn night into day with multiple roof-mounted lights, this light bar is the perfect accessory. The stainless steel bar installs securely and easily in minutes and compliments the vehicle's design. Includes welded mounting tabs for up to 4 lights. (Accessory lights sold separately.) Made in the U.S.A.

## Mirror-Finish Stainless Steel Light Bar

Stainless bar and stainless side supports  
RW604-1-J

## Black Light Bar

Stainless bar and steel side supports  
RW604-1BP-J



Mirror-Finish Stainless Steel:  
RW604-2-J

## Windshield Light Mounts

Not just a bracket but a statement. Unique design enhances the distinguishing features of your Jeep Wrangler. Perfect compliment to our Light Bar. Includes rubber mounting pads to protect your paint. (Accessory lights sold separately.) Made in the U.S.A.

Black Powder-Coated:  
RW604-2BP-J

# License Plate TagLites™

The Easiest Way To Add Lights To Your Vehicle.  
Fits Under ANY Front License Plate!



This sturdy universal mount requires no drilling. Simply attach into existing license plate threaded holes. TagLites™ can go on almost any vehicle (big truck, pickup truck, SUV, crossover or car) as long as the vehicle has a front license plate mounting area. Imported product.

- Fits metal or plastic bumpers
- Works with a variety of lights
- Patent Pending

## TagLites Kit (Mount, Lights, Wiring)

Black: RW604-3LBP-U  
Stainless: RW604-3L-U

## Universal Mount Only

Black: RW604-3BP-U  
Stainless: RW604-3-U



## Billet Accessories

Billet aluminum accessories are precision-machined from solid blocks of aircraft quality aluminum, and then polished to a mirror-finish or electrostatically powder coated for a great look and lasting durability. All easily and securely install in seconds with heavy-duty 3M tape. All made in the U.S.A.



**Billet Driving Light Surrounds**  
Black: RW227-1BP-J



**Billet Driving Light Surrounds**  
Mirror-Finish: RW227-1-J



**Billet Front Marker Light Surrounds**

Mirror-Finish: RW208-1-J  
Black: RW208-1BP-J



**Billet Side Marker Light Surrounds**

Mirror-Finish: RW207-1-J  
Black: RW207-1BP-J



**Billet Trail Rated Logo Surrounds**

Mirror-Finish: RW220-1-J  
Black: RW220-1BP-J



**Billet Antenna Surround**

Mirror-Finish: RW219-1-J  
Black: RW219-1BP-J



**Mirror-Finish Locking Fuel Door**  
RW202-2L-J



**Black Locking Fuel Door**  
RW202-2BPL-J



**Non-Locking Fuel Door**

Mirror-Finish: RW202-2-J  
Black: RW202-2BP-J

## Billet Fuel Doors

Innovative design features ensure quick, easy installation of this attractive billet design. Locking and non-locking models available. All made in the U.S.A.





## Billet Seat Handles

When you open the door of your new JK, these stylish billet levers will make it look like you ordered custom seats. Made in the U.S.A.

### Large Adjustable Seat Handle

Mirror-Finish: RW221-2-J

Black: RW221-2BP-J

### Small Adjustable Seat Handle

Mirror-Finish: RW221-1-J

Black: RW221-1BP-J

## Billet Side Foot Rests

When the doors come off, these side foot rests easily attach to the door hinge mounts for the ultimate open-air experience.

### All RealWheels Foot Rests Feature:

- Aircraft quality billet aluminum
- Available in a durable black powder coating or mirror-finish.
- Installation is easy and secure with stainless steel mounting post.
- Fits all Wrangler JKs 2007 to current
- All made in the U.S.A.

### Original Side Foot Rest



#### Black

Driver Side: RW236-1BP-J

Passenger: RW236-2BP-J



#### Mirror-Finish

Driver Side: RW236-1-J

Passenger: RW236-2-J



### Side Foot Rest XL

New larger design precision machined with deep diamond-cut pattern for the ultimate non-slip surface.



### New Larger Design: 6" x 3 3/8"



#### Black

Driver Side: RW236-3BP-J

Passenger: RW236-4BP-J



#### Mirror-Finish

Driver Side: RW236-3-J

Passenger: RW236-4-J



## Stainless Steel Rear Door Hinge Covers

Make a statement in style with these attractive hinge accessories. Brighter than chrome, each is precision laser-cut from high quality, mirror-finished stainless steel. Installs in minutes with heavy-duty 3M tape. Made in the U.S.A.

Mirror-Finish: RW143-4-J

## Tail Light Armor

Functional protection and rugged appearance.

- Heavy-gauge stainless plate or steel plate for the ultimate protection.
- Installation is easy and secure.
- Made in the U.S.A.
- Available in a durable black powder coating or polished mirror-finished stainless steel.
- Fits all Wrangler JKs 2007 to current.



Mirror-Finish Stainless: RW306-1-J



Black Powder-Coated: RW306-1BP-J



# AMERICAN-MADE COMMERCIAL VEHICLE SOLUTIONS





In 1978, I owned and operated a Kenworth truck and dump trailer, hauling sand and gravel. Consequently, keeping the truck clean was a constant chore. Nevertheless, I believed having a clean truck was a top priority and, like many drivers, I devoted a lot of time and energy to keeping the truck shining.

One day, I made the decision to tackle the challenge of dressing up the ugly cast-spoke wheels on my Kenworth. I grabbed some sheet metal, headed to my shop, and cut and formed some wheel covers and had them chrome-plated. I have to admit that they were pretty crude, but they greatly enhanced the appearance of my truck. In fact, the change was so dramatic that other truckers and operators quickly began asking where they could get a set. I applied for my first patent and kept showing other drivers my new wheels.

Not long after, my wife Sherri and I began manufacturing them out of our home. I hauled during the day and made wheel covers into the night. The demand began to grow beyond our in-home capabilities and we soon moved into a 2,500 sq. ft. industrial building. With the help of my Wife and my Father, the business flourished and the product line expanded.

Today, I am proud to say that RealWheels is the only U.S. manufacturer of these products and we've been awarded over a dozen U.S. patents for our innovative designs. We now operate from a 40,000 sq.ft. facility, offering hundreds of products, reaching into a variety of markets. Our primary focus remains consistent – to offer high-quality products at an affordable price. Our products now reach worldwide, and 99% are manufactured right here in America!

Drive safely, and thank you for your continued support.



# New Products at RealWheels



## TWIST & LOCK™ **AERO** COVERS

Twist & Lock Aero Covers provide you with a great appearance, fuel savings, plus easy-on install and easy-off removal.

## New Peterbilt and Kenworth Billet Pedals

No other pedals on the market come close to these Custom High-Quality Heavy Truck Pedals!



## LED AirGuard®

**SET & GO** Tire Pressure Monitoring System

*New and Improved.* The Easiest TPMS to Install, Calibrate & Re-Calibrate.



## EZ-Access Air Valve Extension Kit

EZ-Access Kit makes it easy to check tire pressure. Braided stainless steel extensions mount securely to the EZ-Access Air Valve Tabs.



Patent  
Pending

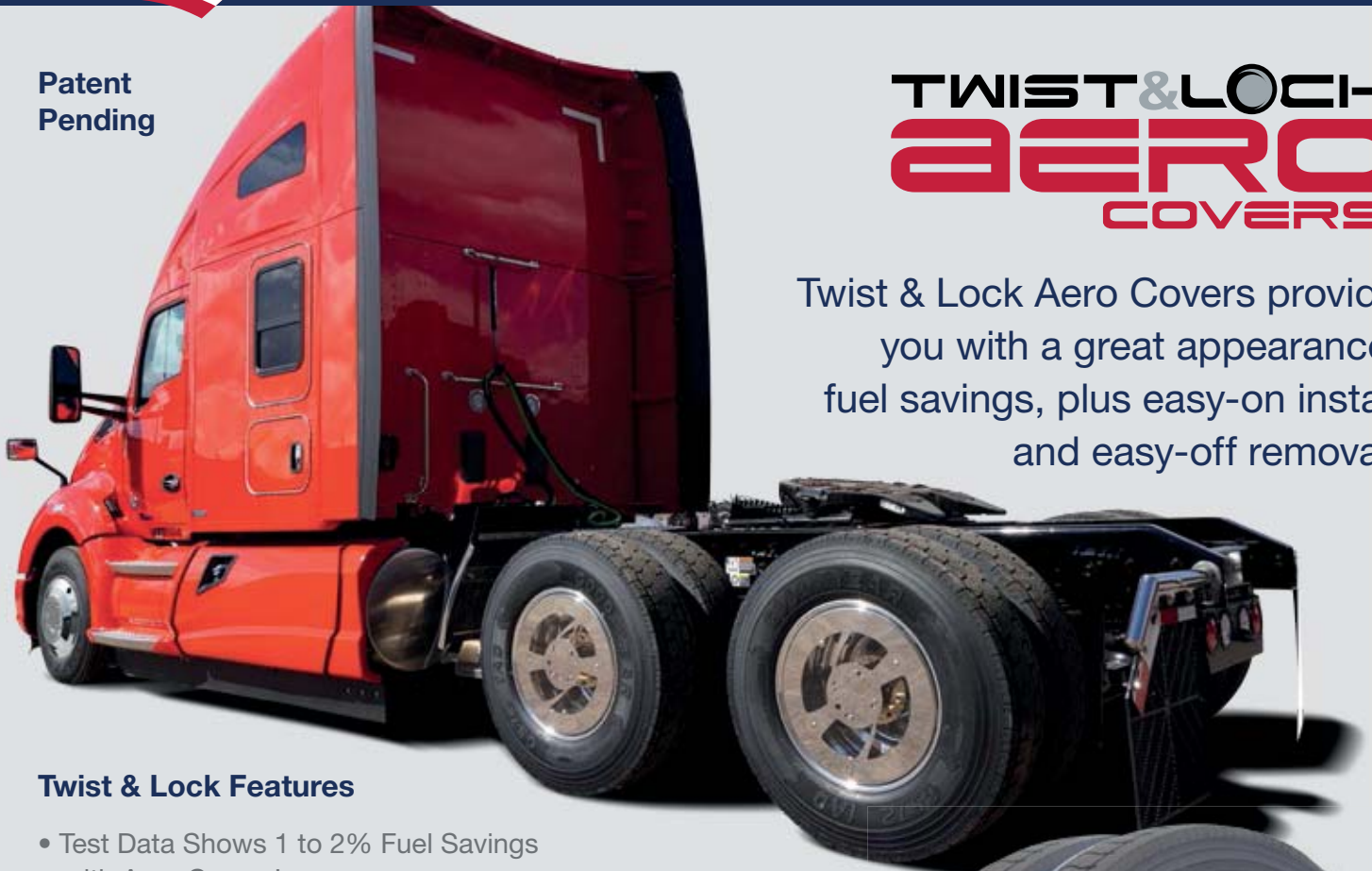

**TWIST&LOCK™**  
**AERO**  
COVERS

Twist & Lock Aero Covers provide you with a great appearance, fuel savings, plus easy-on install and easy-off removal.

**Twist & Lock Features**

- Test Data Shows 1 to 2% Fuel Savings with Aero Covers!
- No tools required to install and remove covers

**Available For**

- All tractors and trailers
- 22.5" and 24.5" wheels
- 6x2 or 6x4 tractors
- Dual aluminum and steel wheels
- Wide base single wheels, including zero offset

The cover attaches to the bracket and completely floats — it does not make contact with the lip of the rim or wheel in any way.



Easy Installation and Removal—Simply Twist and Remove or Twist and Install!



Push in Black Button

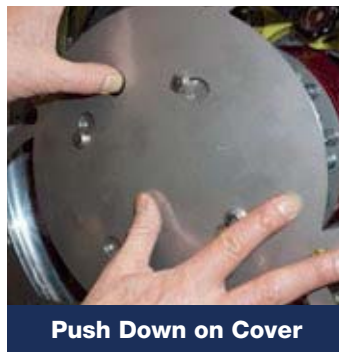

Push Down on Cover

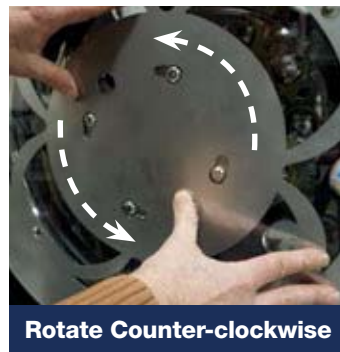

Rotate Counter-clockwise



Easily Remove Cover





## Test Data Shows 1 to 2% Fuel Savings! For Dual Wheel Covers



**Best  
ROI**

### **Aero Mirror Stainless with Window: RW1043\***

The best of both worlds: a lightweight stainless Aero Cover with high-impact, clear polycarbonate viewing window. Polished to a mirror shine, this cover allows for easy viewing of axle and lug nuts.

### **Aero Mirror Stainless RW1042\***

This lightweight stainless cover is polished to a mirror shine. The Aero Stainless Mirror is an attractive option for the trucker looking to set their rig apart.

### **Aero Clear RW1050\***

No need to cover up your wheels to get aerodynamic fuel savings, with Aero Clear you see the entire wheel and all the components. Made of crystal clear high impact UV protected polycarbonate, it's like looking at your wheels under glass.

### **Aero Black RW1052\***

One of the best ROI's in the industry, this no-nonsense, high-impact ABS plastic Aero Cover provides vehicles with an aggressive and strong appearance and offers all the Aero benefits.

\*See price list for correct bracket model for your truck or trailer.

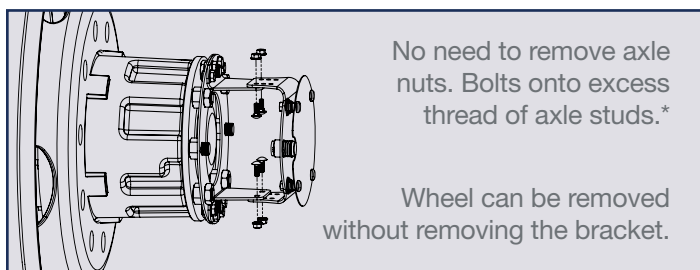

### **Anti-theft Locking With Key Available On All Covers**

#### **4-Pack Lock Set: RWTLOCK-4PK**



All covers come laser scored for installation of lock.



Cover shown with lock installed.

### **Front Aero Covers**

Covering the front wheel hub and lug nuts helps streamline the front wheels, reducing turbulence and increasing fuel efficiency.

**With our Front Aero Covers you'll save even more!**



**Aero Stainless Front Mirror: RW1129K**  
**Satin: RW1124SK**

**Aero Stainless Clear Mirror: RW1138SK**  
**Satin: RW1136SK**



**For 1" & 2" Outset Wide Base Tractor  
 And Trailer Wheels**



**Aero Mirror Stainless  
 with Window: RW1043\***



**Aero Mirror Stainless  
 RW1042\***



**Aero Clear  
 RW1050\***



**Aero Black  
 RW1052\***

**Best  
 ROI**

**For 0" Offset (ZO) Wide Base  
 Tractor Wheels**



**Aero ZO Mirror Stainless  
 with Window: RW1043Z\***



**Aero ZO Satin Stainless  
 with Window: RW1041Z\***



**Aero ZO Mirror Stainless  
 RW1042Z\***



**Aero ZO Satin Stainless  
 RW1040Z\***



# TWIST&LOCK™ AERO Plus PACKAGE

## Dual Wheel Truck Package:

- (4) Twist & Lock Black ABS Covers
- (10) LED Set&Go AirGuards
- (4) Air Valve Extensions

## Wide Base Wheel Truck Package:

- (4) Twist & Lock ABS Black Covers
- (6) LED Set&Go AirGuards



For even greater fuel savings, the AeroPlus Package combines our Aero Covers, Extensions and AirGuards at a reduced package price.



AeroPlus Twist & Lock Package Savings Examples		
Product	Truck Only	Truck & Trailer
Aero Covers	1%	2%
LED AirGuard*	1.5%	3%
<b>AeroPlus Fuel Savings</b>	<b>2.5%</b>	<b>5%</b>
Fuel Savings**	\$1,443	\$2,817
Maintenance Savings***	\$686	\$1,372
<b>Total Annual Savings</b>	<b>\$2,199</b>	<b>\$4,189</b>
Dual Wheel ROI	2 to 3 months	
Wide Base Wheel ROI	1 to 2 months	

\*Tire Inflation Pressure—Every 10 psi of underinflation represents approximately 1% penalty in fuel economy. Estimates of 1.5% and 3% shown are for illustrative purposes and show an improvement in fuel economy by maintaining proper tire pressure versus driving on underinflated tires.

\*\*Fuel Savings Example based on running 130,000 miles per year at 6.50mpg, consuming 20,000 gallons of fuel at \$3/gal. When using AeroPlus, the minimum average is 6.66mpg, the maximum average is 6.82mpg.

\*\*\*Maintenance Savings Example based on a labor rate of \$40 per hour and 10 to 20 minutes per pressure check. Maintenance dollars saved would be \$6.60 to \$13.20 per air pressure check. Pressure is checked twice a week. If more than two pressure checks per week are required, this amount would also increase.

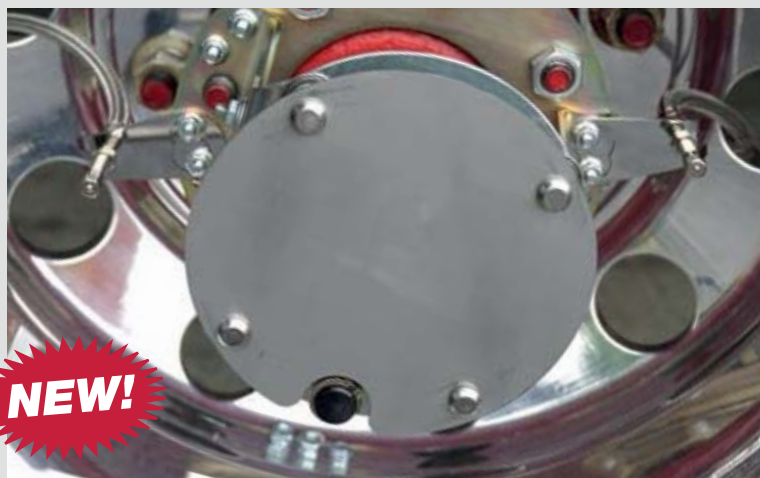

Easy & quick installation. Braided stainless extensions mount securely to the EZ-Access Air Valve Tabs.

## EZ-Access Air Valve Extension Kit for Twist & Lock Aero Covers RW1258-6K

Since Twist & Lock Aero Covers are easy to install and remove, air valve extensions are not required. However, this optional kit allows for even easier and more convenient access to air valves when checking tire pressure.

### EZ-Access Kit Includes

- One 16" Straight Extension
- One 14" 180° Hooked Extension
- Two EZ-Access Air Valve Tabs

# LED AirGuard<sup>®</sup>

**SET & GO** Tire Pressure Monitoring System

**Complies with the NFPA 1901 & 1917 Standards**

For ambulances and fire trucks

## Low Tire Pressure Is Dangerous!

The Easiest TPMS to Install, Calibrate & Re-Calibrate

- Safety – Improper tire pressure has a detrimental effect on handling, braking and control.
- Longer Tire Life – According to the D.O.T., 95% of all premature tire wear is caused by underinflation.
- Self-calibrating – LED AirGuard Set & Go memorizes pressure when initially installed and can be easily recalibrated by simply removing and reinstalling.
- Improved Fuel Economy – Proper tire inflation can save an estimated 3% to 5% in fuel costs.
- The Set & Go can be used on any tire pressure between 10psi and 200psi.
- Battery standby time is warranted for 2 years from date stamped on the AirGuard. Batteries are non-replaceable.
- Ultra-bright LED allows for visual checks of each tire, even in daylight!
- Truckers & Fleets – Helps keep you CSA compliant.



LED AirGuard Set & Go starts flashing RED if the tire pressure drops 5 to 10 psi.

### Set & Go Anti-theft Locking System



The use of the Locking Nut to tighten against the Set & Go on the valve stem helps prevent theft.

### AirGuard Set & Go

Set & Go Model #	Amount
RW-PPK-0402	4-Pack
RW-PPK-0403	6-pack
RWTG1235	Single

Imported

No tools required for installation.



**1. Check Tire Pressure**



**2. Thread On**



**3. Monitors Pressure**

Starts flashing RED if tire pressure drops 5 to 10 psi.



LED AirGuard Set & Go is designed to fit Trucks, Fire Trucks Semis, Trailers, Buses, Motorhomes, Cars, ATVs, Motorcycles and more!

# For Commercial Trucks with 19.5", 22.5" & 24.5" Aluminum Wheels with Round Holes and 22.5" & 24.5" Standard Steel Wheels with Oval Holes



## Tire Pressure Monitoring Kit

Includes: LED AirGuard® Set & Go, Inner and Outer Air Valve Extensions, plus Air Valve Extension Stabilizers.

6 Wheel Kit	
Set & Go Model #	Kit Fits Round Holes
RWTG1236-62	2"
RWTG1236-65	2.5"
RWTG1236-68	2.8"
RWTG1236-63	Oval Holes

10 Wheel Kit	
Set & Go Model #	Kit Fits Round Holes
RWTG1236-12	2"
RWTG1236-15	2.5"
RWTG1236-18	2.8"
RWTG1236-13	Oval Holes

## POP Packaging & Displays Available!



Clamshell Package  
4 or 6 packs  
(5" x 8")



Counter Display Box  
(11" x 7.5" x 7")

Tire Pressure Monitoring Kit

6-Wheel  
(5" x 14.5")

8 and 10-Wheel  
(7" x 19.5")



Counter Easel Card  
(8.5" x 11")



## Valve Stem Stabilizers



Aluminum Wheels



Steel Wheels

These Valve Stem Stabilizers help prevent damage to extensions caused by the rubbing of the extension against the wheel. A worn extension may lead to air leakage and result in tire damage. Easy installation: simply align the rubber stabilizer with the valve extension and push into the wheel hole.

## Valve Stem Stabilizers

Model #	Stabilizer Type
RW0020VSB	2" Round for Aluminum Wheels
RW0025VSB	2.5" Round for Aluminum Wheels
RW0028VSB	2.8" Round for Aluminum Wheels
RW0030VSB	3" x 4.75" Oval for Steel Wheels

Imported

## Valve Stem Wear Is Dangerous

Centrifugal force of a rotating wheel (photo 1) will cause the valve stem to rub against the wheel and result in wear and eventual failure of the valve stem (photo 2).



PHOTO 1



PHOTO 2

American  
Road  
Series  
(shown)



**RW1173-24AK** Fits 22.5" Fronts

**RWWLH2003-AXK** Fits 22.5" Rears



### Why RealWheels Simulators?

1. Dollar for dollar, RWC Simulators are the best value in the market.
2. RWC is the only American wheel simulator manufacturer.
3. All our simulators are made from heavy-gauge 304L stainless steel.
4. The only simulators that look like aluminum wheels.
5. They all have patented, over-the-lug style mounting, which does not require the removal of lug nuts.
6. They have more universal features and require fewer part numbers to fit a variety of wheel sizes.
7. RealWheels guarantees the durability of each simulator and its mirror-shine.
8. All parts can be ordered individually.
9. 22.5" & 24.5" rear simulators come standard with our American-made, high-quality, stainless steel braided valve extensions for easy air pressure monitoring and access.



Classic Series (shown)



**RW1173-24CK** Fits 22.5" Fronts



**RWLH2003-CXK** Fits 22.5" Rears

22.5" to 24.5" Stainless Steel Simulators offer a front profile and deep rear inset that simulates the look of aluminum wheels.

### Front and Rear Simulators

- Fits 20/22.5 x 7.50/8.25/9.00 and 22/24.5 x 8.25 wheels.
- For standard hub piloted and stud piloted wheels.
- Rear simulators fit wide-base wheels.
- High-quality, non-magnetic 304L stainless steel — will not rust, pit, corrode or turn yellow.



Pop-In Centers for easy oil cap viewing.

### Trailer Simulators

- Match your trailer wheels to your truck wheels with RealWheels simulators.

RealWheels has over 30 years' experience developing mounting systems for wheel simulators. Our innovative designs have been awarded numerous patents.

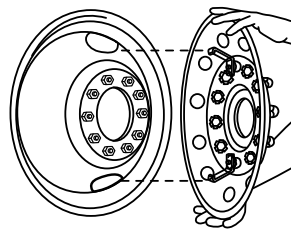

**Front Hook Mount**



**Wedge Lock Mount**

- Engineered to fit securely to steel disc or aluminum wheels with our patented over-the-lug mounting systems.
- The hook mount systems do not require excess stud.
- These systems do not disturb the torque of the lug nuts.



Whether you have an early model truck with cast spoke (Dayton) wheels or a brand new truck with steel disc wheels, these covers fit them all.



Cast Spoke  
Wheels  
Before and  
After

Premounted Lug Nut Covers (shown)



**RW1121LK-34C**  
Fits 20" & 22.5" Fronts

**RW1021LK-UC**  
Fits 20" & 22.5" Rears

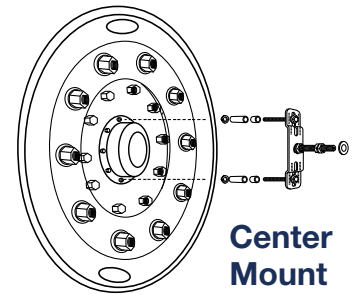

Universal Simulators are for cast spoke (Dayton) or steel disc wheels. Truly Universal for any wheel. Center mount system makes installation simple and D.O.T. inspections easy.





### Universal Simulator Features

- Available in sizes to fit 20" & 22.5" and 22" & 24.5".
- High-quality 304L stainless steel will not rust, pit, corrode or turn yellow.
- Easy care and low maintenance for years to come.

Integrated Lug Nut Covers (shown)

Optional Wing Nut Center Piece Available



**RW1121BK-34C**  
Fits 20" & 22.5" Fronts

**RW1021BK-UC**  
Fits 20" & 22.5" Rears

**RW1148BK-34W**

With our Integrated Lug Nut Cover Design, you get the styling of lug nuts, yet cleaning is a snap since you don't have the full lug nut cover to wash around.



**RW1130** 22.5" x 12.25"



**RW1134** 22.5" x 13"

### Integrated Lug Nut Covers

Offers the styling of lug nuts, without the hassle of cleaning around lug nuts.



**RW1133** 22.5" x 13"



**RW1160-BK** 20"/22.5" x 12.25"/13"



20" and 22.5" Super Single Simulators for heavy duty front axles offer the only flush profile in the industry. This flush profile is crucial to maintain mandatory width offsets.



### Super Single Features

- High-quality, non-magnetic 304L stainless steel—will not rust, pit, corrode or turn yellow.
- For super single front hub piloted and stud piloted wheels.
- Fits 20/22.5 x 12.25 and 13.00 wheels.
- Simplified over-the-lug, patented mounting system.
- For heavy rated front axles.
- Easy D.O.T. Inspection.

BEFORE



AFTER



Our simulators install easily on most super single wheels.

### Custom Sizes Available

RealWheels Super Single Covers can be designed to fit any super single wheel, even airport ARFF units.



Pop-In Centers for easy oil cap viewing.



19.5"  
American  
Road Series  
(shown)

**RW1901-AOK**

RealWheels 16", 17.5" and 19.5" Stainless Steel Simulators offer a front profile and deep rear inset that simulates the look of aluminum wheels.

#### 16", 17.5" and 19.5" Simulators Features

- High-quality, non-magnetic 304L stainless steel — will not rust, pit, corrode or turn yellow.
- The hook mount systems do not require excess stud.
- These systems do not disturb the torque of the lug nuts.



#### Front & Rear Hook Mount

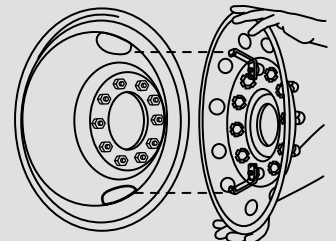



16"-17.5"  
American  
Road Series  
(shown)

**RW1600-223AK**

16" G-Series  
For GMC &  
Ford E-450  
(shown)

G-Series also  
available for 17.5"  
& 19.5" wheels.



16" Simulators  
For Ford, Chevy &  
Dodge Wheels

Shown with  
open center for  
manual lockouts.





19.5"  
EZ Style  
Simulators  
(shown)

**RW1960-JEZK**

RealWheels offers simulators designed for your imported vehicles. It's the easiest way to get the look of aluminum wheels. Easy installation!

16"–17.5" EZ Style Simulators (shown)

### **EZ Style Features**

- New EZ Design Available  
We've designed our EZ line of wheel simulators so they are EZ to install, EZ to clean and EZ to maintain. Plus they are offered at a lower price, which makes them EZ to purchase.
- High-quality, non-magnetic 304L stainless steel—will not rust, pit, corrode or turn yellow.
- Patented Over-the-Lug, Hook-Mount systems.



**17.5": RW1760JEZK / 16": RW1660-JEZK**



A Perfect  
Fit For Your  
Imported Truck

Available For

Hino  
Mitsubishi Fuso  
Isuzu  
Nissan  
UD

All simulator styles  
available for 16", 17.5"  
and 19.5" Wheels



RealWheels Stainless Steel Simulators offer a front profile and deep rear inset that simulates the look of aluminum wheels.

16"–17.5" American Road Simulators (shown)

#### American Road Features

- High-quality, non-magnetic 304L stainless steel—will not rust, pit, corrode or turn yellow.
- The hook mount systems do not require excess stud.
- These systems do not disturb the torque of the lug nuts.



16": RW1600-3JAK

2012+ 3500  
Sprinter-EZ  
Dual Wheels  
(shown)

**RW1602-18SAK**

2012+ 3500  
Sprinter-EZ 16"  
dual wheels with  
18 round holes

**RW1602-18SAXK**

2012+ 3500  
Sprinter-EZ 16" dual  
wheels with 18 round  
holes and includes  
valve extensions



Covers also available for 2004 - 2011 Sprinter models.

Sprinter simulator design is patterned with the same number of cutouts as the factory wheel and is approved by Daimler Commercial.

- We've designed our EZ line of wheel simulators so they are EZ to install, EZ to clean and EZ to maintain. Plus they are offered at a lower price, which makes them EZ to purchase.
- Rear simulators have a new, extremely low center cap design that eliminates obstructions when servicing and creates the easiest wheel simulators to maintain and clean.
- High quality, heavy-gauge stainless steel.
- Patented mounting system — no lug nuts to remove.
- Sprinter & custom emblems available.



**Sprinter Single Wheels**

Cut-Out Patterns Match Factory Wheels for Improved Air Flow!

2007 & Up 2500 Sprinter-SL

**RW1603-SAK\***

16" single, fits on 2007 & Up

\*Integrated lug nut cover design prevents curbing damage, eliminates missing lug nut covers, and provides easy maintenance.





## 2015 Ford Transit Stainless Steel Accessories



### Transit Single Wheels

Cut-Out Patterns Match Factory Wheels

**RW1604-TAK** —16" single

- All high quality, heavy-gauge stainless steel.
- Covers install easily — no lug nuts to remove.



**RWG7100-CTR15** 4pc S.S. Grille Overlay (Only)

**RWG7100-DTRV15** 4pc S.S. Grille Overlay and  
2pc S.S. Hood Vent Overlays



**RWG7101-TRHV15**  
2pc S.S. Hood Vent  
Overlays (Only)

Overlays securely  
adhere with heavy-  
duty 3M tape.



**RW1606-12TAK**

2015+ Transit 16" dual wheels with 12 round cut-outs

## 16" & 17.5" Trailer Wheels

Get the look and style of aluminum wheels  
without the expense or maintenance hassle.  
Made from 304L non-magnetic stainless steel,  
they'll shine forever.



Trailer Covers available in both deep  
and shallow inset.

**RW6215U2**

Dia: 8.812"  
Height: 2<sup>3</sup>/<sub>4</sub>"



The Only American-Made  
Universal Front Axle Covers

"Universal"...Fits All Wheels

**RW6215U2 NEL**



All 304L  
Stainless  
Steel

The Last One You'll  
Ever Need To Buy!

- Built to last with heavy gauge 304L stainless steel—up to 91% heavier than the imports.
- Installation is quick, easy and secure!

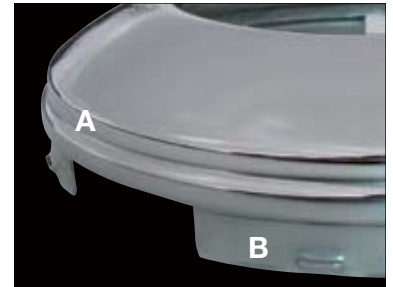

- A: Reinforcing bead adds extra strength and covers pilots.
- B: Integrated locking tabs require no separate clips.

**Fits Them All!**

Fits All Front Wheels with 4, 5 or 6 Pilots – Hub or Stud Piloted – Aluminum or Steel Wheels.

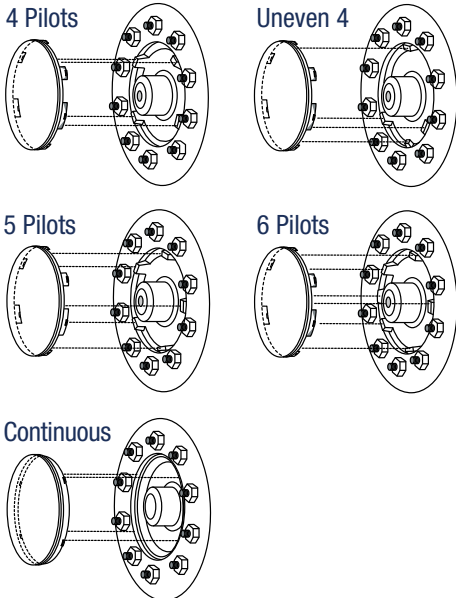

Available with cutout for oil cap viewing.

**Axle Cover Trim Kits**

Four Wheel Kit – 2 Baby Moons, 2 High Hats & 40 Lug Nut Covers.

**RW8122** (With Center Logo)

**RW8122NEL** (No Logo)

Six Wheel Kit – 2 Baby Moons, 4 High Hats & 60 Lug Nut Covers.

**RW8122-2** (With Center Logo)

**RW8122-2NEL** (No Logo)





All 304L Stainless Steel

## The Only American-Made Rear High Hats

- Wheel manufacturers do not recommend under-the-lug mounting systems. That's why RealWheels Patented High Hat Mounting Systems make so much sense!
- They do not disturb wheel balance.
- High Hats fit all steel disc or aluminum wheels whether 8 or 10 lug, hub piloted or stud piloted.



**RW7715**

Dia: 9"  
Height: 9"



**RW7715 NEL**

## Improved Band Mount Spring Clip High Hat Patented Installation



**1**  
Slide ring over axle onto hub & tighten securely.



**2**  
Push the high hat into place.

## Rear Baby Moons



- Inexpensive solution for rear axles.
- Simply snaps on over axle studs.
- High quality stainless steel.
- Available with or without embossed logo.
- Imported.



**RW7070**  
Axles with 5/8" Studs

**RW7270**  
Axles with 3/4" Studs

**RW6016**  
Trailer Axles with bracket.

### European Axle Covers



Our Super Sized Axle Covers are designed to fit the larger European Bus, Fire Engine and Truck Axles.

### Luxury Motorcoach Stainless Steel Trim

This Van Hool Coach features a custom RealWheels Trim Package. See page 31 for more info.

You'll be impressed by their unique look and craftsmanship.

- Made from 304L non-magnetic stainless steel, they'll shine forever.
- The front cover has a flat profile with a beveled edge.
- The rear high hat uses our Band Mount Spring Clip System.



**RW1010SK\***



**RW1011SK\***

### Wing Nut Center Mount

Solid Stainless Steel! For steel or aluminum wheels. Easy to install. Mounting brackets fit any axle, front or rear. No need to remove lug nuts.



## Gear Nut Axle Covers

- This Geometrical Stainless Steel Axle Cover offers easy, secure installation.
- New universal mounting system provides quick, easy access and confident, secure reinstallation during vehicle service.
- Gear-Nut Mounting Device is precision-machined, enhanced with a color logo and features our anti-rotation technology for additional secure mounting.

RW1011-2GN\*

RW1010-2GN\*



# GO NUTS!

**NEW!**  
Universal Bracket  
for mounting



RW2GNT

Wrench Included

Available for even easier servicing

**\*NOTE:** Axle, hub and wheel information required when ordering.

STAINLESS STEEL

# REALMAG™ HUB COVERS

This second generation RealMag is fabricated from solid stainless steel. Installation is easy and secure with our center mount Gear-nut System. The RealMag is proudly made in America and backed by our Lifetime and Mirror Shine Finish Guarantees.



## Classic American Muscle For Your Truck

22.5":  
RW1002-SSMR  
24.5":  
RW1004-SSMR

Wrench Included



RealMag Hub Covers are attractively packaged



These low profile “Cover-Up” Hub Covers are the only system that covers the axle and the lug nuts and features the patented “Wedge Lock” bracket.

Covering the hub and lug nuts helps streamline your front wheels to reduce drag and improve aerodynamics. Makes cleaning wheels easy — no lug nuts to wash around.



22.5/24.5” Axle Covers



**RW1013HFK** (Hub piloted.)



**RW1015HRK** (Hub piloted.)

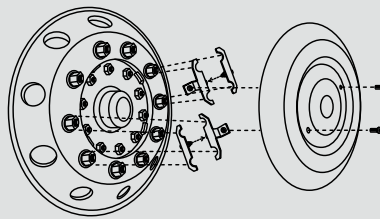

Patented  
“Wedge Lock” Bracket

Installation is quick, easy and secure!

19.5” Axle Covers w/ Integrated Lug Nut Covers



Chevy/GMC

Front: **RW1095HFK**  
Rear: **RW1096HRK**

Dodge

Front: **RW1091FSBK**  
Rear: **RW1092RSBK**



Freightliner/International

Front: **RW1097HFK** Rear: **RW1098HRK**



Cover-Up Hub  
Covers Designed  
for 2005-up  
Ford F450/F550  
& International  
TerraStar

Front/Rear Kit:  
**RW1093SOK**

Front/Rear Kit 4WD:  
**RW1093SOK4**



Bold  
Styling and  
Streamlined  
Design



Ford/Int: **RW1091FSOK**

Ford 4WD: **RW1091FSOK4**  
Open center for manual lock out



Ford/Int: **RW1092RSOK**

**Features**

- Low profile design.
- Fits 10 lug wheels.
- For steel or aluminum wheels.
- Will not crack like plastic when removing.
- Made from high-quality, non-magnetic 304L stainless steel—will not rust, pit, corrode or turn yellow.
- Integrated Lug Nut Cover design.



Easy and secure installation  
with our over-the-lug  
mounting brackets.

# Lug Nut Cover Solutions



The only lug nut cover that provides safety, good looks, and a universal fit.

## Introducing the first 32/33mm Universal Lug Nut Cover with optional Loose Lug Nut Indicator.

- Universal Design—Fits both 32mm and 33mm lug nuts.
- Lug nut cover is designed to accommodate our optional LugCheck Loose Lug Nut Cover Indicators—Allows for quick and easy visual inspection.
- High-quality, chrome plated ABS.



Vibration and bolt fatigue are the leading causes of self-loosening wheel lug nuts and joint failure. Visual inspections by trained mechanics can detect a loosened wheel lug nut, however to an untrained eye, a loose wheel lug nut looks tight. Additionally, many truck, trailer, bus and RV owners dress up their wheels with lug nut covers, so using a Loose Lug Nut Indicator that only fits the bare lug nut is not an option. That's why RealWheels has developed the LugCheck Loose Lug Nut Indicator. It's the only cover that combines the safety of a visual Loose Lug Nut Indicator with the beauty of a chrome plated lug nut cover.

Personalized domed logos or reflective inserts for added safety are available.



Optional Reflectors Dramatically Increase Visibility.



Attractively Packaged. Includes 10 Lug Nut Covers and 10 Loose Lug Nut Indicators.

Lug Nut Cover:  
**RW5809**

Loose Lug Nut Indicator:  
Black: **RW1270**  
Yellow: **RW1270Y**

Lug Nut Cover w/ Indicator:  
Black: **RW5809I**  
Yellow: **RW5809IY**



Lug Nut Covers are available for most popular lug nut sizes and shapes.



**Adjustable Lug Nut Pullers**

Adjusts from 1/2" to 1-3/4". These Pullers help remove lug nut covers without scratches or denting.



**RW5802 ▲**  
33mm with 2" flange  
chrome plastic  
Height: 2 1/2"



**RW5801 ▲**  
1 1/2" with 2 3/16" flange  
chrome plastic  
Height: 2 3/4"



**RW5805 ▲**  
33mm w/ flange  
chrome plastic  
3" long  
Height: 3 1/8"



**RW5804 ▲**  
1 1/4" chrome plastic  
Height: 2"



**RW5800 ▲**  
1 1/4" chrome plastic  
Height: 2"



**RW5809 ▲**  
32/33mm  
universal chrome plastic (works with LugCheck see p.26)  
Height: 2 3/16"

**Stainless Steel**



**RW5605 ▲**  
1" with skirt  
stainless steel  
Height: 1 1/4"



**RW5610 ▲**  
1 1/2" stainless steel  
Height: 1 5/8"



**RW5612 ▲**  
1 1/2" with skirt  
stainless steel  
Height: 2"



**RW5615 ▲**  
1 1/2" stainless steel  
Height: 2"



**RW5630 ▲**  
41mm with skirt  
stainless steel  
Height: 1 7/8"



**RW5696 ▲**  
33mm w/flange  
2 3/16" tall stainless steel  
Height: 2 3/16"



**RW5625 ▲**  
33mm w/ flange  
stainless steel  
Height: 2"



**RW5600 ▲**  
Ford, 1 3/16" with  
flange stainless steel  
Height: 1 3/4"



**RW5618 ▲**  
30mm with flange  
stainless steel  
Height: 2"



**RW5620 ▲**  
32mm with flange  
stainless steel  
Height: 1 3/4"



**Peterbilt (2014 – Current)**

Fits 567, 579 & 587

**Raised Diamond Cut:** RW235-3-PETE

**Flat Diamond Cut:** RW235-3FD-PETE

**Black Flat Diamond Cut:** RW235-3BP-FL

**The Ultimate Pedal Upgrade!**

No other pedals on the market come close to these Custom High-Quality Heavy Truck Pedals!

- Machined from solid blocks of billet aluminum
- Includes: 1 Clutch, 1 Brake and 1 Gas Pedal
- Installs easily
- **Polished:** Pyramid-cut diamond pattern reflects light in all directions and offers an unbelievable non-slip surface.
- **Black:** Durable black anodized finish with pyramid-cut diamond pattern polished highlights.

**Three Styles Available!**

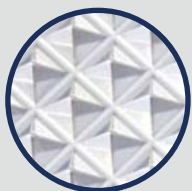

Raised Diamond



Flat Diamond



Black Diamond



**Peterbilt (2001 – Current)**

Fits 379, 386, 388, 389



**Raised Diamond Cut:** RW235-1-PETE

**Flat Diamond Cut:** RW235-1FD-PETE

**Black Flat Diamond Cut:** RW235-1BP-PETE

1994 – 2000

**Raised Diamond Cut:** RW235-2-PETE

**Black Flat Diamond Cut:** RW235-2BP-PETE



**Kenworth (2014 – Current)**

Fits T660, T680, T880

**Raised Diamond Cut:** RW235-4-KW

**Flat Diamond Cut:** RW235-4FD-KW

**Black Flat Diamond Cut:** RW235-4BP-KW



**Kenworth  
(2007 – 2013)**

Fits T680, T660, T700,  
T800, W900, T440, T470



**Raised Diamond  
Cut:** RW235-2-KW  
**Flat Diamond Cut:**  
RW235-2FD-KW  
**Black Flat  
Diamond Cut:**  
RW235-2BP-KW



**Freightliner**

Fits Coronado, Cascade,  
Business Class, M2



**Raised Diamond Cut:**  
RW235-1-FL  
**Black Flat Diamond  
Cut:** RW235-1BP-FL



**Kenworth  
(2001 – 2006)**

Fits T700, T800,  
W900, T440 & T470

**Raised Diamond Cut:** RW235-1-KW  
**Flat Diamond Cut:** RW235-1FD-KW  
**Black Flat Diamond Cut:** RW235-1BP-KW



1994 – 2000  
**Raised Diamond Cut:**  
RW235-3-KW  
**Black Flat Diamond  
Cut:** RW235-3BP-KW



Freightliner Stainless Steel Grille Covers add style and beauty to your Freightliner 108SD and 114SD truck.

- Made from High-Grade, 304L stainless steel.
- Will never rust, corrode, pit or lose their shine.
- Formed to fit perfectly over your existing grille. No disassembly required.
- Easy Installation. No tools required.



**RWG108**

6 slats for 108SD trucks

**RWG114**

5 slats for 114SD trucks

**RWG108W**

6 slats with cutouts for winter cover for 108SD trucks

**RWG114W**

5 slats with cutouts for winter cover for 114SD trucks

Custom and Deluxe Grille Covers

- Made from high-grade 304L stainless steel that will not rust, pit, corrode or lose its shine.
- Many other styles and custom grilles are available.



Ford 350/450/550 (2011 to 2015)

4pc Grille Overlay (Only): **RWG7000-C15**  
 4pc Grille Overlay and 2pc Bumper Vent Overlays: **RWG7000-D15** (Shown)  
 2pc Bumper Vent Overlays (Only): **RWG7001-BV15**



Chevy Deluxe: **RWG6500C**



International Deluxe: **RWG4000D**  
 Custom: **RWG4000C** (grille slats only)



## EZ-Access Air Valve Extension Kit



- No need to remove axle nuts—provided jam nuts secure onto excess thread.
- Allows for convenient air pressure check and inflation.
- Universal design for 5/8" and 3/4" axle studs
- Proudly Made in the USA!



Jam Nuts for 5/8" Studs



EZ-Access Air Valve Tabs

16" Straight Extension



Braided stainless steel extensions mount securely to the EZ-Access Air Valve Tabs.

14" 180° Hooked Extension



Can be used with rear baby moons



## Air Valve Extensions

Custom valve extensions are made in various lengths to accommodate the requirements of any wheel cover or simulator. This makes checking air pressure a breeze. They're easy to install. Braided styles are made of stainless steel, the most rugged and trouble-free extension available.

### Braided Stainless Steel

- A. **RW1258H** 15" Hooked
- B. **RW1258-1S** 14" Straight
- C. **RW1258-1H** 14" Hooked
- D. **RW1258S** 16" Straight
- E. **RW1259B** 5" with Clamp

### Solid Styles (Imported)

- F. **RW1263** 45° angle
- G. **RW1262** 2" Solid
- H. **RW1260** 3" Solid
- I. **RW1259S** 6" Solid
- J. **RW1261** Dbl. end air valve caps
- K. **RW1266** 180° angle
- L. **RW1267** 90° angle



RWPSI

## Crossfire Dual Tire Pressure Equalizing System

Allow air to flow between the two tires and equalize pressure with the Crossfire Tire Pressure Equalizing and Monitoring System. This helps reduce wear and tear on tires, and simplifies tire maintenance, saving you time and money. Fits all types of wheels.

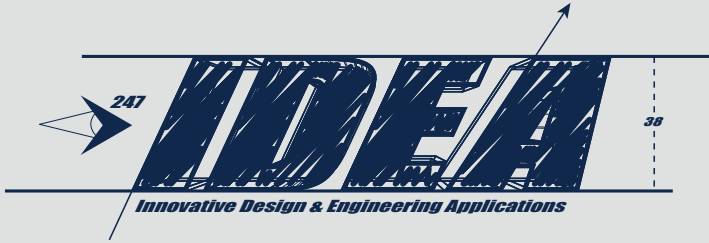

Complete Contract Manufacturing Serving Truck OEMs, Body Builders and Upfitters.

**RealWheels Corporation's in-house capabilities and services include:**

- Design Services
- Laser Cutting
- Vertical CNC Milling
- CNC Turning
- Welding
- Tube Bending
- Metal Spinning
- Stamping
- Forming
- Polishing & Buffing
- Plastic Molding
- Injection Molding
- Thermoforming



Sutphen Stainless Steel Grille & Light Housings

The I.D.E.A. division (Innovative Design & Engineering Applications) is the branch of RealWheels Corporation that assists your organization with various levels of design, engineering, and fabrication. This exciting division has effectively helped customers with tasks as simple as basic parts manufacturing, or as detailed as complete new product concepts and development.

We are passionate problem solvers, consistently dedicated to finding the best design and manufacturing solutions for our clients.

Our fabricating abilities allow flexibility to meet your technology and delivery requirements while staying within your budget constraints.



Meets NFPA Standards  
Custom stainless steel diamond pattern steps with non-slip extrusions.



Light Housing Wing Pocket Thermoformed and Chrome-Plated.



Custom honeycomb grille for van conversion company



Chrome plated billet door handles for major OEM.



We have effectively helped customers with tasks as simple as basic parts manufacturing, or as detailed as complete new product concepts and development.



### Interior Hand Railings

A leading Specialty Vehicle manufacturer needed a better design for interior hand railings. The challenge was to produce a better quality product, while lowering their costs. The project team exceeded expectations, and now the parts are used on hundreds of vehicles. Additional vehicle parts using bent tubular stainless steel have since been developed for many of their high-profile projects.

### Luxury Motorcoach Stainless Trim

A luxury motorcoach builder asked RealWheels to quote on a variety of component parts used in their high-end vehicles. The IDEA team was able to provide cabinetry brackets, air vent louvers, stainless enhancement trim and other supplies at a fraction of the cost they were paying to another supplier. RealWheels continues to work with them on additional parts and innovations.



### Custom Brush-Finished Stainless Steel ARFF Cover



A leading heavy equipment manufacturer was preparing to unveil a new Airport Rescue Vehicle. They enlisted the help of the RealWheels IDEA team to design and engineer a protective stainless wheel cover. No cover had ever been developed for such a large wheel size, and a completely new mounting system had to be engineered. The team created a very industrial design with a machined-finish. The protective cover performs extremely well, greatly enhances the vehicle's appearance, and has become a popular option on new orders.



## “Liberty” Vehicle Flag Pole System

The heaviest-duty 304 stainless steel system on the market! It’s made from heavy gauge 304 stainless construction with CNC precision machined billet aluminum components, including top ball.



**RW521-1**  
“Liberty” Kit with  
American Flag

**RW522-1**  
“Liberty” Kit  
(No Flag)



## RealWheels is Your Source for Stock and Custom Stainless Steel Fenderettes

- We’ve built our reputation providing quality stainless fabrication and carry this expertise into every fenderette we manufacture.
- Rolled from high quality 14 gauge 304 stainless steel then polished and buffed to a mirror-shine finish.
- Three stock profiles. Custom profiles available.
- Radiuses from 17.5” thru 29.”  
Designed to fit around tire sizes of 16” thru 17.5”, 19.5”, & 22.5” thru 24.5”
- Length, radius and hole placement to your specifications. Contact us for a free estimate.



Shown with RealWheels stainless steel front axle covers and lug nut covers.



Shown with RealWheels stainless steel high hats and lug nut covers.