

**1**



**Terminals and Connections?**

H<sup>2</sup>O and baking soda



Corroded

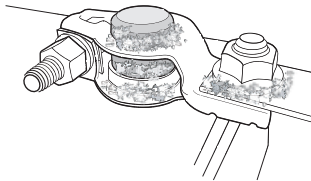

Clean

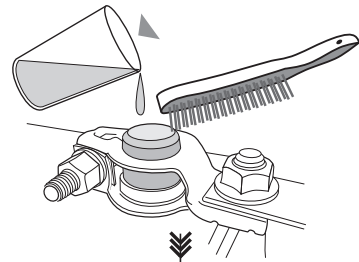

Loose

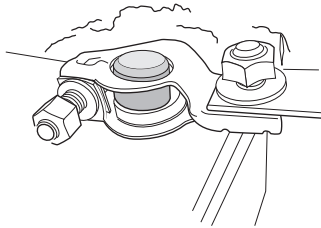

Tight

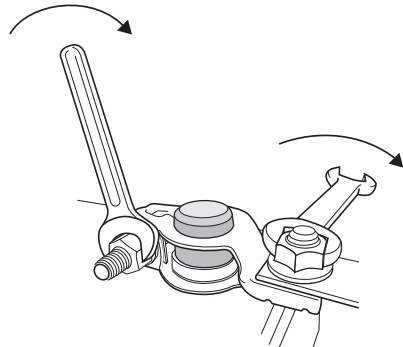

**2**



**Battery Good or Bad?**



Low charge

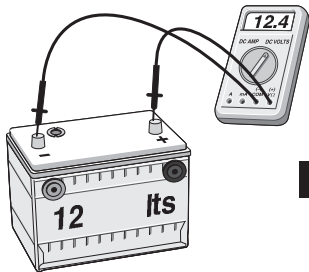

Good Charge

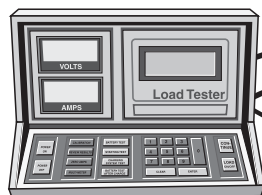
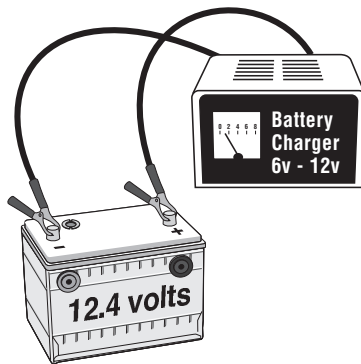

Test at parts store



Battery good



Replace battery

# 3



## Starter Problem?

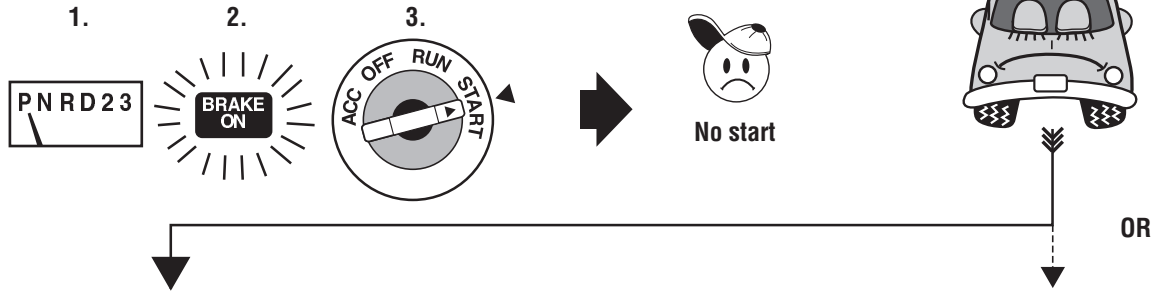

### Ignition By-pass

Remote switch

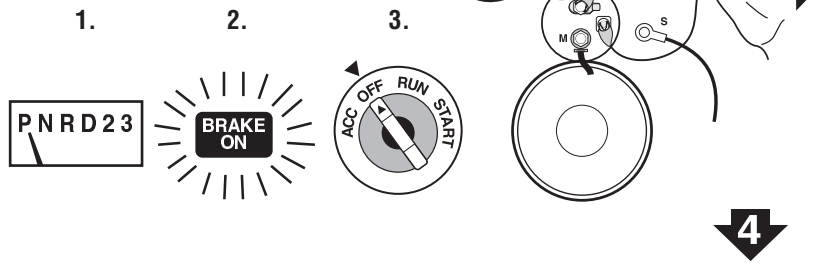

Possible starter replacement

Starter good. Go to step 4

# 4



## Typical Starting System Checks

