

INSTALLATION MANUAL

207800

Level of Difficulty

Easy

Parts List

1	Milestone™ bumper guard
1	Driver / left mounting bracket
1	Passenger / right mounting bracket
2	Tow hook mounting bar
2	Mounting bracket spacer
2	Adjustable mounting bracket
12	Hex bolt, M16
8	Nylock nut, M16
18	Flat washer, M16
4	Lock washer, M16

Tools Required

Ratchet	Torque wrench, 24mm
Socket, 24mm	--

Torque Specifications

Metric	Bolt	Torque
	M6 bolt	8 ft-lbs.
	M8 bolt	19 ft-lbs.
	M10 bolt	37 ft-lbs.
	M12 bolt	65 ft-lbs.
	M16 bolt	160 ft-lbs.

Use above torque setting unless otherwise noted

Product Photo



Brackets and Hardware



Passenger / right mounting bracket

Driver / left mounting bracket

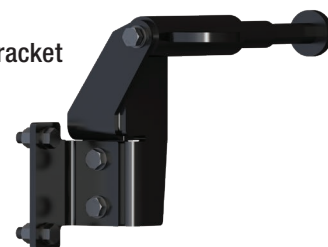

NOTICE

Before you begin installation, read all instructions thoroughly.

Proper tools will improve the quality of installation and reduce the time required.

To help prevent damage to the product or vehicle, refer to the specified torque specifications when securing hardware during the installation process.

Maintenance

To protect the product, wax after installing. Regular waxing is recommended to add a protective layer over the finish. Do not use any type of polish or wax that may contain abrasives that could damage the finish.

For polished, gloss and other smooth finishes, polish may be used to clear small scratches and scuffs on the finish.

Mild automotive detergent may be used to clean the product. Do not use dish detergent, abrasive cleaners, abrasive pads, wire brushes or other similar products that may damage the finish.

Parts List

Item	Qty	Description
1	1	Bumper guard
2	1	Driver / left mounting bracket
3	1	Passenger / right mounting bracket
4	2	Tow hook mounting bar
5	2	Mounting bracket spacer
6	2	Adjustable mounting bracket
7	12	Hex bolt, M16
8	8	Nylock nut, M16
9	18	Flat washer, M16
10	4	Lock washer, M16

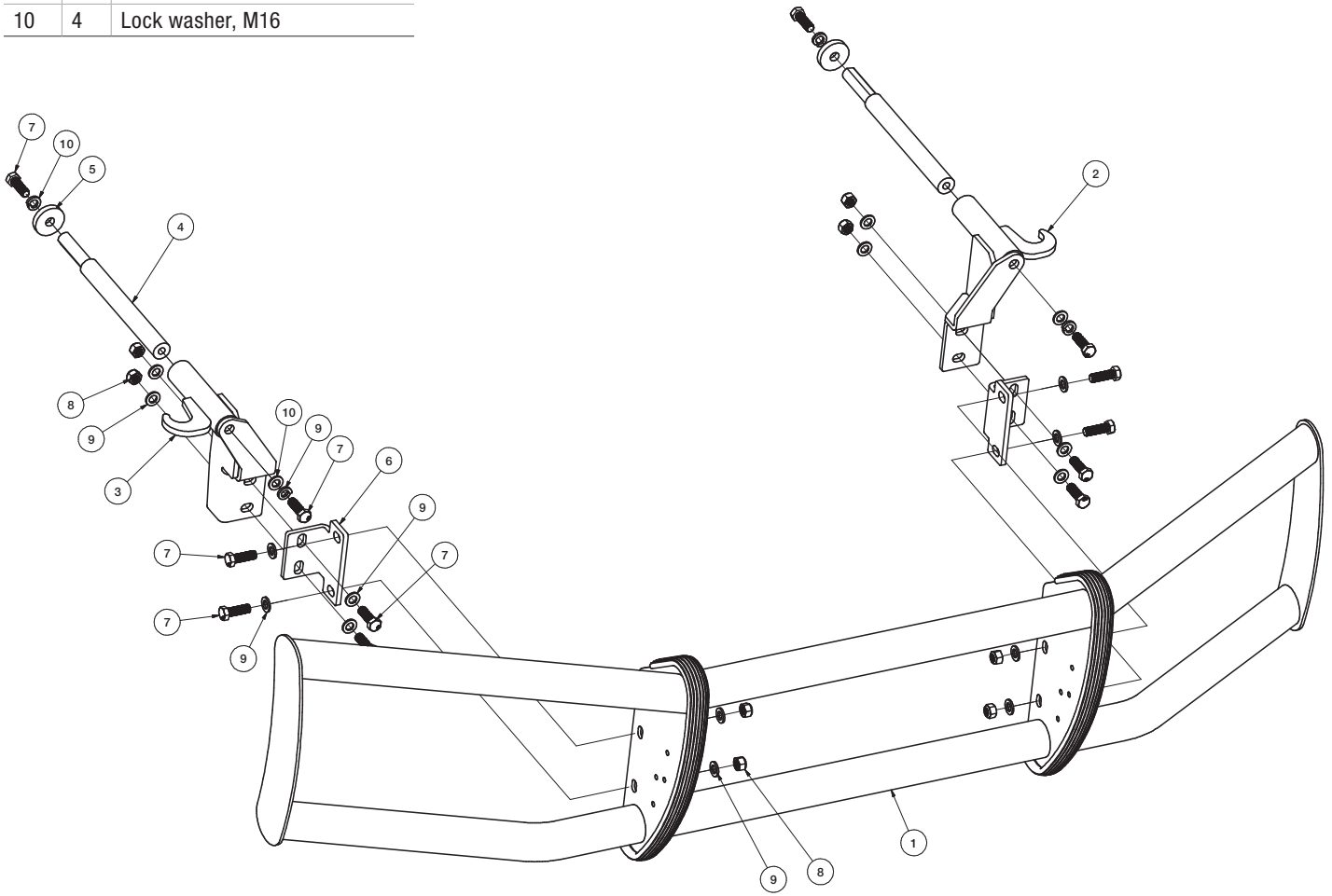

Step 1

Insert the tow hook mounting bar into the tow hook opening. Secure with a mounting bracket spacer, M16 lock washer and bolt.

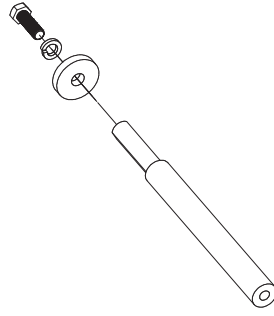

Step 2

Slide a mounting bracket over each tow hook mounting bar and secure with an M16 bolt, lock washer and flat washer into the tow hook mounting bar.

Snug the hardware, but do not fully tighten.

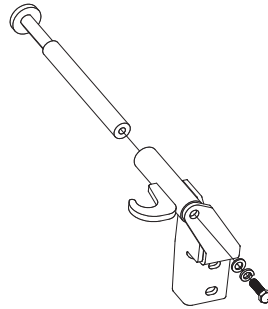

Step 3

Secure an adjustable mounting bracket to each mounting bracket using M16 bolts, flat washers and nylock nuts.

Snug the hardware, but do not fully tighten.

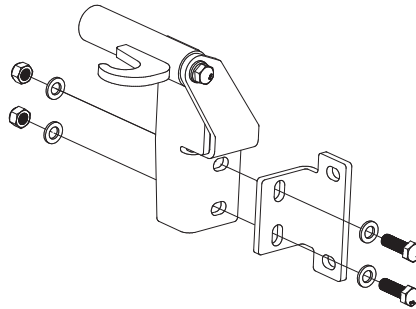

Step 4

Install the guard onto the adjustable mounting brackets with M16 bolts, flat washers and nylock nuts.

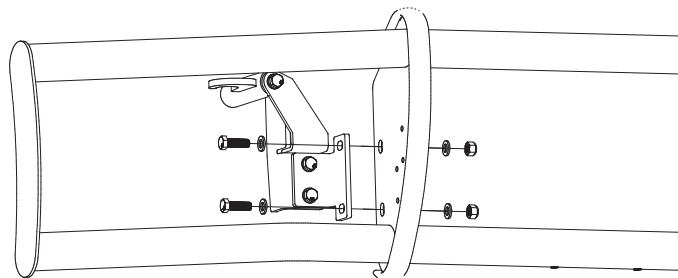

Step 5

Tighten all M16 hardware to the recommended torque specifications listed in the table on page one.

Keep the mounting brackets parallel when tightening.

Step 6

Adjust the guard as needed to center on the truck while tightening the remaining bolts.

Note: Recommended guard location is to be as close to the truck as the brackets allow and as high up as brackets allow without contacting the hood when open.

Step 7

Congratulations on the installation of your new RETRAC Milestone™ bumper guard.

With the bumper guard installed, periodic inspections should be performed to ensure all mounting hardware remains tight.

To protect your investment, see the 'Notes and Maintenance' section on the first page of this installation manual.



Representative photo,
actual finish may vary