



# Assembly Instructions House Style Greenhouse 12 x 12 x 8

## ASSEMBLY INSTRUCTIONS HOUSE STYLE GREENHOUSE 12Wx12Lx8H

### Congratulations!

Congratulations on your purchase of a House Style Greenhouse by Rhino Shelter. With proper installation, use, and maintenance, your new unit will provide many years of good and suitable service. Your new Rhino Shelter portable enclosure is a combination of excellent engineering and well thought out design. The unit is comprised of a rigid tubular frame, covered with a long life polyethylene cover and double access ends.

The multiple part tubular frame assembly is pre-drilled for easy insertion of hardware to assemble. The tubing is made from high-grade galvanized steel tubing, to resist moisture and oxidation over the life of the shelter. The fabric components are made from ASTM-5 approved polyethylene materials. The cover is also UV protected for continual exposure to the sunlight.

It is suggested that you read the assembly instructions completely before you begin. This will help attain the best results for your installation the first time.

### **SAFETY WARNING**

**The installation of this unit must conform to the requirements of all authorities having jurisdiction in your specific local area. In the absence of such requirements, the installation must conform to the provided assembly and installation instructions. MDM Products LLC will not be responsible for failure to comply with any requirements in a given local area. Consequential damages or injuries caused by improper installation, alteration, or improper use are strictly that of the user. Unit MUST be cleared of All Snow Accumulation immediately to avoid overload. Unit is not to be used for occupancy for any length of time. No running internal combustion engines, open flames, or contact with heated surfaces are allowed.**

Cartons should be inspected upon delivery from carrier, and any evident damages should be noted on the bill of lading before signing. If upon opening the cartons hidden damage is noted, contact carrier or its agent immediately. Claims for shipping damage MUST be made with the shipping company. An inspection of the goods will most likely be required. Do not discard

packing or any components before the freight company's inspection. All claims for freight damage must be made with 15 days of receipt of the goods in accordance with ICC regulations.

### ASSEMBLY PROCEDURE

The proper sequence and steps to install this unit will produce a proper and good installation. Failure to read and follow these guidelines may result in an improper installation and will void all warranty and protection the owner is entitled to with the product. The steps to be undertaken are:

1. Perform an inventory check before beginning to be certain all components are available for installation.
2. Prepare location and place both unit boxes near location sight.
3. Assemble four (4) arches of unit
4. Assemble unit end arch, first interior arch, and wind braces with first top ridge, base cross rail, and side cross rail sections.
5. Add additional arch assemblies with each section of top ridge rail, base cross rails and side cross rails.
6. Place frame into desired position and **level** frame both end-to-end and side-to-side. Measure interior of frame feet across opposite corners and square as needed.
7. Anchor frame assembly to ground with provided anchors, u-bolts and drive rod provided.
8. Install two(2) doors on both ends of frame assembly.
9. Install main cover over frame assembly.

### TOOLS REQUIRED

The following hand tools are suggested for proper installation of your new Rhino Shelter unit:

- 9/16" Open End Wrench**
- 9/16" Socket or Box Wrench**
- Large Flat Tip Screwdriver**
- Maul or Sledgehammer**
- 2-foot Level**
- 6-Foot Step Ladder**

### INVENTORY CHECK

Start installation procedure by removing all components from packaging and ensure all components are present

Qty	Part Number	Description
1	MUC-8000	Main Unit Cover
1	DZD-5002	End Panel Door with Zippers
1	DZD-5003	End Panel with Zippered Manway Door



# Assembly Instructions House Style Greenhouse 12 x 12 x 8

4	EUL-2002	End Upright w/Foot A & B
8	BTSC-2006	Bent Tube Side Crest
4	TC-2000	Top Crest Tube
4	CSU-2001	Center Straight Uprights
2	CW-2005	Corner Wind Brace
10	SCR-2004	Swedged Cross Rails M/F
5	ECR-2003	End Cross Rails F/F
8	TB-3004	Turnbuckles
20	CBN-3005-3	Carriage Bolts – 3 1/4"
10	CBN-3005-2	Carriage Bolts – 2 1/8"
30	CBN-3005-N	3/8" Nuts
30	CBN-3005-W	Washers – 3/8" Curved
2	R-3003	3/16" Rope
4	BC-36	Bungee Cord Hold Ups
4	DBA-3000	Earth Cable Anchors
4	UB-3002	U Bolts with Nuts
1	DR-3001	36" Drive Rod
4	EP-1000	1-5/8" Plastic End Plugs
10	EP-1001	1" Plastic End Plugs

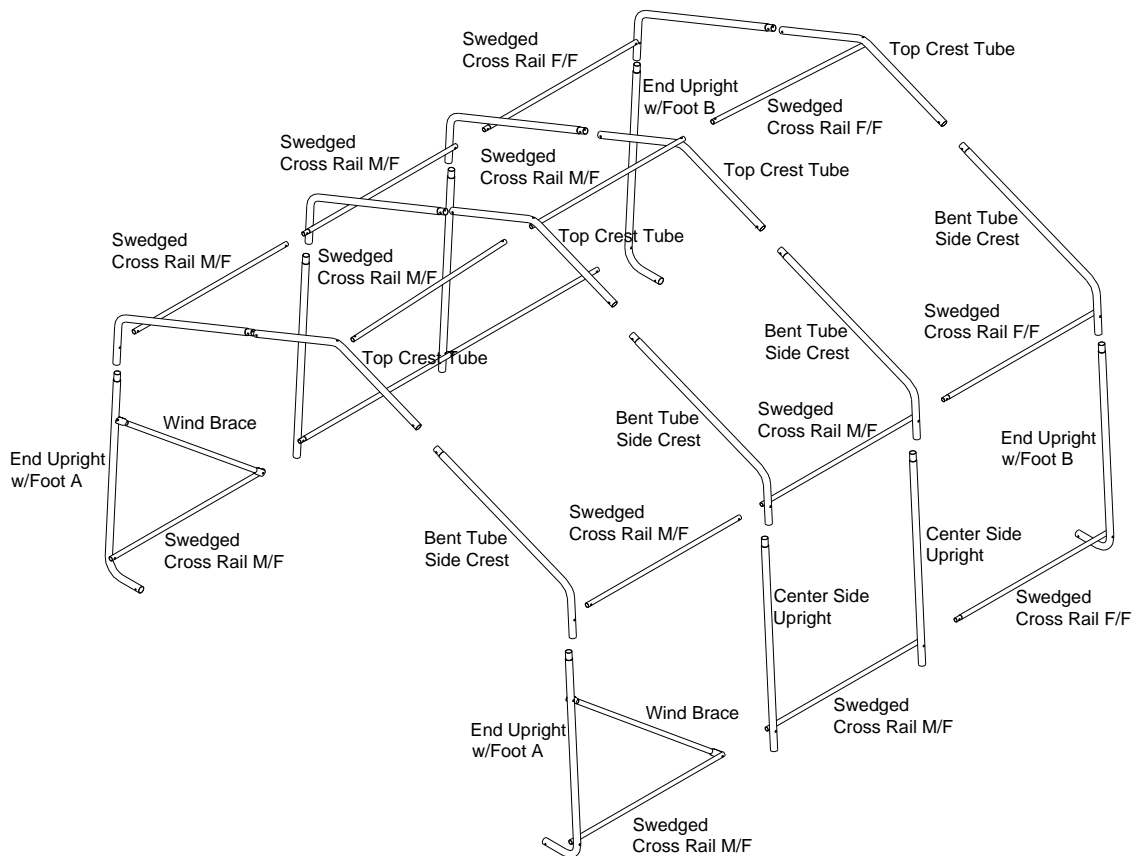

## SITE PREPARATION

Select a level or as close to level as practical location for your Rhino Shelter unit. The unit should be placed on a base of materials suitable for the storage load to be

protected. The unit should not be located under trees, which will shed hard fruit such as apples, walnuts, or heavy pine cones. The cover of your unit will protect against normally leaves and light debris, however large



# Assembly Instructions House Style Greenhouse 12 x 12 x 8

branches or other falling items may cause puncture or tears in the cover material.

Take notice of drainage around your intended location. Water draining from the surrounding terrain should be planned so that it does not run into the unit. As well, rain or melting snow that comes off the unit should be drained away rather than accumulate and pool around the unit.

Check to be certain that adequate clearance is allowed for entry and exit from ends of unit. As unit has different door openings on each end, ideally contents can be inserted or removed from either end.

## FRAME ASSEMBLY

**Step 1.** Assemble the Front and Rear End Arches(2) using (1) Top Crest #TC-2000, (2) Bent Tube Side Crest #BTSC-2006 and (2) End Upright w/Foot #EUL-2002 for each one. Use (4) #CBN-3005-2 carriage bolts with nuts and washers through pre-drilled holes in frame members.

Be certain to insert carriage bolts from the outer edge into the interior of the unit, with the washers and nuts on the inside of the arches. This will avoid tearing the fabric on doors and main cover when installed. Do not tighten the nuts completely until the frame is completed and set in place.

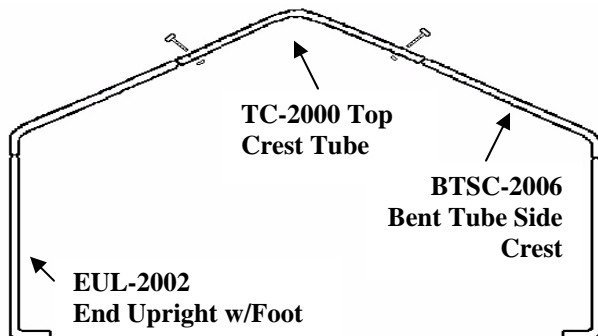

**Step 2.** Assemble the (2) Corner Wind Braces #CW-2005 to the End Upright w/Foot #EUL-2002 to the first of the End Arch assemblies. Use a #CBN-3005-2 Carriage Bolt with Washer and Nut to secure the braces loosely to the Upright. Do not tighten completely.

**Step 3.** Assemble the remaining two interior arches using (1) Top Crest Tube #TC-2000, (2) Bent Tube Side Crest #BTSC-2006, and (2) Center Straight Upright #CSU-2001 for each of the arches. Use CBN-3000-2 carriage bolts with washers and nuts in the pre-drilled holes, aligned to form the arch.

**Step 4.** Support the End Arch with Wind Braces temporarily in the vertical position. Connect (4) SCR-2004

Swedged Cross Rails to the End Arch with (4) CBN-3005-3 carriage bolts, washers, and nuts through the pre-drilled holes in the arch members. The Swedged end of the Cross Rails should face the interior of the unit to accept the next cross rail. The Cross Rails should be put into the bottom and side hole of the arch upright. Again, don't tighten the hardware until the next arch and cross rails are assembled. It is very important to make certain all nuts are on the inside of the unit to avoid damaging the cover when put on.

Stand an interior arch assembly up vertically into position, so the cross rails align with the holes in the interior arch. Using (4) Carriage Bolts #CBN-3000-3 with nuts and washers, connect the cross rails between the end arch and the first interior arch assemblies. Connect the (2) Wind Braces #CW-2005 diagonally across the end and interior arch as shown in the frame illustration.

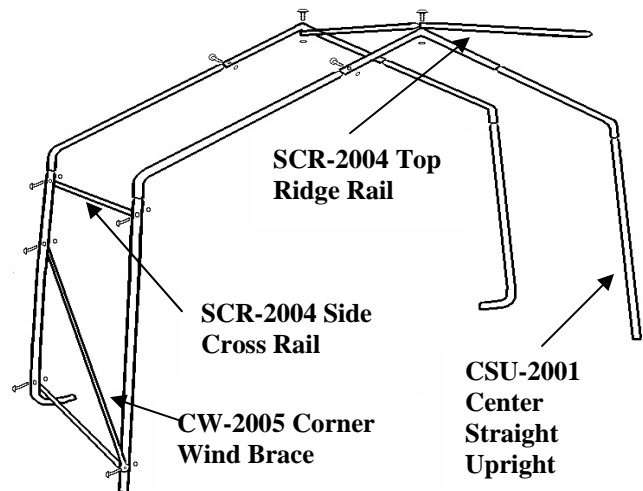

**Step 5.** Begin the Top Ridge Rail by placing a Swedged Cross Rail underneath the End Top Crest Tube. Secure the Cross Rail loosely with a Carriage Bolt#CBN-3000-3 with washer and nut facing the interior of the unit.

**Step 6.** Add remaining 3 middle arches and rear end arch in the same fashion. Note that the Plain end of Swedged Cross Rail should fasten under the End Top Crest Arch and the Swedged End above middle Top Crest arch.

**NOTE:** Do not completely tighten bolts that connect the Cross Rails to the End Arches. They must be removed for proper for End Panel Zippered Door installation

**Step 7.** Move the frame assembly into its final installation location. This should be done with at least one person lifting each side or corner to avoid bending or stressing any frame members. Frame should now be squared up in position. Measure from diagonally from inside corner to



## Assembly Instructions House Style Greenhouse 12 x 12 x 8

inside corner. Adjust frame and support as necessary to bring frame into square. **Failure to square frame of unit will result in poor cover fit and reduced strength and rigidity.** If end or interior upright ends are placed on soft material that will not support weight, recess small patio blocks or bricks under leg ends. This will also allow better setting of frame before securing to ground.

### ANCHORING FRAME TO GROUND

Once frame is square and properly supported, tighten carriage bolts on all frame members, except for End Arch members to Cross Rails along base, side, and top. Do not over tighten or oval tubing. After hardware is tightened, insert plastic end plugs #14 (2 3/8") & #15 (1 1/8") into all open ends of frame members.

**NOTE: Frame must be anchored before installing any doors or cover.**

Each Rhino Shelter 12x12x8 building comes with 4 EARTH CABLE ANCHORS with U-bolts and nuts. These versatile anchors allow the frame to be secured to almost any surface. In addition you have also been provided with a 36" Drive Rod used to drive the anchor heads into the earth.

If the location where you are placing the building has very hard ground or any rock in it, pre-drill the holes before inserting anchors. Hammer drills can be rented at most home improvement or rent-all centers. Hitting the anchors into rock will cause the drive rod end to mushroom inside the anchor head, and prevent the drive rod from coming out of the hole.

Anchor placement should be made inside the frame at the interior corners of the unit, and midway along the sides of the frames. Anchors secure the building to the ground, as well as prevent spread of the frame over time.

**Step 8.** Once frame is square and properly supported, tighten carriage bolts on all frame members, except for End Arch members to Cross Rails along base, side, and top. After hardware is tightened, insert plastic end plugs #EP-1000 (1 5/8") & EP-1001 (1") into all open ends of frame members.



*Pre-Drill Holes if there is Any Rock In Ground*



*Drive Rod inserts into Anchor Head*



# Assembly Instructions House Style Greenhouse 12 x 12 x 8

## ANCHOR STEP 1

**Step 1.** Place the drive rod provided into the cup of the anchor. Using a heavy hammer drive the anchor into the soil until 6-8 inches of cable remains above the earth. Remove drive rod.

## ANCHOR STEP 2

Place the Drive Rod through the loop in the anchor lanyard. Pull upward to set anchor head into the ground.



## ANCHOR STEP 3

Slip one side of the U-bolt through the eyelet at the end of the anchor cable. Attach the cable to the Arch leg upright with the U-bolt and tighten. Do not attach to base cross rails. Ensure there is no slack in the cable. Slack can be removed by wrapping the cable around the tie-down rail.



## END PANEL INSTALLATION

**Note: Both End Panels MUST be installed before installing Main Cover onto frame.**

Note that one door has a Full Width opening and the other a Manway opening. Plan location of each before installing door ends.

**Step1.** Remove Carriage bolts from the Top Crest Rail and the two Upper Cross Rails. Install End Panel Door w/Zipper #DZD-5002 and End Panel with Manway #DZD-5003 on desired ends of the Frame assembly.

**Step 2.** Place the end panel over the first arch and wrap the material around the arch bringing the slits in the end panel to the inside of the frame arch. End Door Panels have pre-cut slits that allow frame members to pass through so rope pocket is inside unit. Place the top ridge cross rail pole and the side cross rails through the material slits and replace the carriage bolts and tighten. The door end will also require removal of the wind brace bolts and placement of the wind braces through slits in the ends panel. Reconnect wind braces with carriage bolts once end panel is put into place.

Door assembly is drawn over frame by tightening rope and securing to turnbuckles at the arch foot. Frame must be secured in position so it does not move as end doors and main cover are tightened over frame. This step is key to good fit and to prevent door movement in wind.



## Assembly Instructions House Style Greenhouse 12 x 12 x 8



The rope channels should be located inside the unit, with the frame members passing through the pre-cut slits in the end panel/door. Replace and tighten the carriage bolts after putting the end panel into position.

When putting on the doors, adjust the length to make certain the doors do not drape onto the ground. Adjust by pulling more or less material over end arch. If pulling them up puts too much stress on the slit where it goes over the wind brace, use a sharp knife to cut slit another inch or two to relieve it. The PE fabric is rip-stop weave and will only separate where cut.

**Step 3.** Tie off one end of the rope coming out of the end panel to a turnbuckle. Turnbuckle should be loosened all the way and the open hook end attached to the hole in the inside of the end arch. Hold the end of the unsecured rope and apply pressure downward with a foot to remove excess. Re-adjust gathered material evenly along door rope. This step is key to getting a good door fit. Tie off the end off the rope to a second turnbuckle attached to a hole in the foot of the end arch on the opposite side. The end panel can be adjusted further by tightening the turnbuckles.

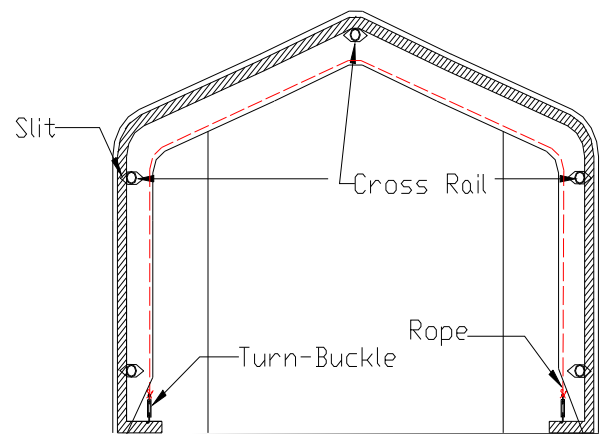

**Note: Adjust/Snug the end panel by turning the turnbuckles or repeating step 3 on a regular basis**



### MAIN COVER INSTALLATION

**Step 1.** To elongate the life of Main Cover, put a small square of duct tape (field supplied) over each bolt head



## Assembly Instructions House Style Greenhouse 12 x 12 x 8

on frame that comes in contact with cover. The tape acts as a cushion to avoid rubbing damage to the cover over years.

Unpack the Main Cover #MUC-5000 from the protective plastic packaging. The line of grommets on the inside (white) of the cover on the tie down Flap run parallel to the sides of the frame assembly for positioning. Once cover is oriented properly to the Frame Assembly, pull Main Cover over frame assembly from the side, being careful not to snag the cover on any member, bolt, or other obstruction. Center the Main Cover over the Frame Assembly with the Main Cover colored side showing from the outside of the unit.

**Step 2.** Loosen the 4 remaining turnbuckles completely. Place the turnbuckles into outer hole in the foot of each end arch. Tie off the rope coming out of the Main Cover rope slot on either side to the turnbuckles. After securing one end of the rope in the Main Cover, gently pull the excess slack out of the rope and cover to tighten. Hold the end of the unsecured rope and apply pressure downward with a foot to remove excess. Temporarily tie the end of the rope to the turnbuckle. Go over the entire outer edge of the cover and adjust the excess material around the end so it is not bunched up. Spread excess material evenly along the outer edge. Once cover is pulled tight and even, tie off the rope end to the turnbuckle. All slack should be out of the rope at this time. Repeat this step on both ends of the cover. Tighten the turnbuckle to tighten the cover. This step may need to be repeated to ensure a snug and centered fit.

**Step 3.** When the cover is completely aligned secure the cover to the bottom tie-down cross rail using the rope provided. Start at one end and tie off the rope to the cross rail. Lace the rope through the grommets in the cover and back under the tie-down cross rail. Repeat this on the opposite side

Pay close attention to how tight the cover is put onto the frame. It should be tight enough so it does not flap around in the wind, but not so tight that it tears the material cover. The fabric backed PE fabric of Rhino Shelter units does not stretch. If you pull it so tight that the fabric is stretched, a small amount of additional stress from wind or contact can cause premature tears and material failure. Only tighten cover enough to remove valleys between arch assemblies. Do Not over tighten.

**Step 4.** Retighten the turnbuckles on both the cover and end panels. Retighten the rope holding the main cover

to the bottom cross rail. **Both the cover and the end panels should be checked and tightened on a monthly basis.**



### DOOR HOLD UPS

All Rhino Shelter doors are manufactured with a pocket on the bottom edge along the width axis. A ½" to 1" plastic or metal tube can be inserted into the pocket and trimmed to fit width. Weight will reduce door movement in wind. Four(4) bungee straps are provided to retain the door up. Roll the door from the bottom and secure the door roll with a bungee through the upper door grommet as shown.





# Assembly Instructions House Style Greenhouse 12 x 12 x 8

## **MAINTENANCE AND CARE**

Annually or more often, the unit should be completely inspected internally and externally to make certain the unit remains properly installed and secured. Particular attention should be paid to:

**Hardware** – check all carriage bolts and hardware connectors to be certain they are in place and tightened.

**Anchors** – during normal weather trends, the unit will strain against the anchors under windy conditions. Anchor hardware connection to frame members should be maintained tight and depth of anchors should be checked to be certain they remain deeply and firmly set.

**Snow Accumulation** – all snow accumulation on the main cover should be removed as soon as practical. The days following the snowfall when the snow melts are when most snow damage can occur. Unit is not designed for any amount of accumulated snow or ice. Tap the main cover from the inside with a broom end to knock off any accumulated snow.

**Main Cover Lacing** – the poly rope that secures the main cover to the bottom rail of the frame assembly should be checked, and adjusted as needed. The tension on the main cover should be uniform from end to end and side to side. Rope ends must be tied off onto the frame members at the ends on each side.

**Turnbuckle Adjustment** – during normal wind conditions and load, the doors and main cover adjustment points at the turnbuckle should be checked and tightened as necessary. The turnbuckles should be neither completely extended nor taken up, so that turnbuckle should be tight when in the mid range of overall adjustment. If necessary, readjust rope tie off on turnbuckle as needed to tighten or loosen as needed.

**Cleaning** – cover and doors can be cleaned with a mixture of light detergent and water. A soft bristle brush with the mixture can be used to loosen any hard dirt, mold, or buildup on the cover. After cleansing, the cover should be rinsed thoroughly to avoid any chemical reaction from residual detergent. Allowing dirt and debris to sit on cover over an extended time will damage cover irreparably.

**Severe Weather** – in preparation for inclement weather, completely secure the doors on both ends of your Rhino Shelter shelter/garage. Allowing wind to enter either end lifts the building and puts undue stress on the anchoring

system. This also shortens the life of the doors, zippers, and main cover.

## **CUSTOMER SERVICE OR INSTALLATION**

Care and attention to a proper installation will add many years of life and function to your Rhino Shelter unit.

Please retain purchase documentation for your Rhino Shelter unit. All warranty claims must include purchase documentation for verification. All parts on your Rhino Shelter unit are available for replacement as needed. Protect your purchase by completing warranty registration card and mail/fax as soon as practical after installing your unit.





# Assembly Instructions House Style Greenhouse 12 x 20 x 8

## ASSEMBLY INSTRUCTIONS HOUSE STYLE GREENHOUSE 12Wx20Lx8H

### Congratulations!

Congratulations on your purchase of a House Style Greenhouse by Rhino Shelter. With proper installation, use, and maintenance, your new unit will provide many years of good and suitable service. Your new Rhino Shelter instant garage is a combination of excellent engineering and well thought out design. The unit is comprised of a rigid tubular frame, covered with a long life polyethylene cover and double door ends.

The multiple part frame assembly is pre-drilled for easy insertion of hardware to assemble. The tubing is made from high-grade galvanized steel tubing, to resist moisture and oxidation over the life of the shelter. The fabric parts are made from ASTM-5 approved polyethylene materials. The cover is also UV protected for continual exposure to the sunlight.

It is suggested that you read the assembly instructions completely before you begin. This will help attain the best results for your installation.

### **SAFETY WARNING**

**The installation of this unit must conform to the requirements of all authorities having jurisdiction in your specific local area. In the absence of such requirements, the installation must conform to the provided assembly and installation instructions. MDM Products LLC will not be responsible for failure to comply with any requirements in a given local area. Consequential damages or injuries caused by improper installation, alteration, or improper use are strictly that of the user. Unit MUST be cleared of All Snow Accumulation immediately to avoid overload. Unit is not to be used for occupancy for any length of time. No running internal combustion engines, open flames, or contact with heated surfaces are allowed.**

Cartons should be inspected upon delivery from carrier, and any evident damages should be noted on the bill of lading before signing. If upon opening the cartons hidden damage is noted, contact carrier or its agent immediately. Claims for shipping damage **MUST** be made with the shipping company. An inspection of the goods will most likely be required. Do not discard

packing or any components before the freight company's inspection. All claims for freight damage must be made with 15 days of receipt of the goods in accordance with ICC regulations.

### ASSEMBLY PROCEDURE

The proper sequence and steps to install this unit will produce a proper and good installation. Failure to read and follow these instructions may result in an improper installation and will void all warranty and protection the owner is entitled to with the product. The steps to be undertaken are:

1. Perform an inventory check before beginning to be certain all components are available for installation.
2. Prepare location and place both unit boxes near location sight.
3. Assemble six (6) arches of unit
4. Assemble unit end arch, first interior arch, and wind braces with first base rails and side rail sections.
5. Add additional arch assemblies with each section of base Rails and side rails.
6. Place frame into desired position and level frame both end-to-end and side-to-side. Measure interior of frame feet across opposite corners and square as needed.
7. Anchor frame assembly to ground with provided anchors, u-bolts and drive rod provided.
8. Install two(2) doors on both ends of frame assembly.
9. Install main cover over frame assembly.

### TOOLS REQUIRED

The following hand tools are suggested for proper installation of your new Rhino Shelter unit:

- 9/16" Open End Wrench**
- 9/16" Socket or Box Wrench**
- Large Flat Tip Screwdriver**
- Maul or Sledgehammer**
- 2-foot Level**
- 6-Foot Step Ladder**

### INVENTORY CHECK

Start installation procedure by removing all components from packaging and ensure all components are present

Qty	Part Number	Description
1	MUC-5000	Main Unit Cover
2	DZD-5002	End Panel Door with Zippers
4	EUL-2002	End Upright w/Foot
12	BTSC-2006	Bent Tube Side Crest



# Assembly Instructions House Style Greenhouse 12 x 20 x 8

6	TC-2000	Top Crest Tube
8	CSU-2001	Center Straight Uprights
2	CW-2005	Corner Wind Brace
20	SCR-2004	Swedged Cross Rails
5	ECR-2003	End Cross Rails – Plain End
8	TB-3004	Turnbuckles
30	CBN-3005-3	Carriage Bolts – 3 1/4"
2	CBN-3005-2	Carriage Bolts – 2 1/4"
32	CBN-3005-N	9/16" Nuts
32	CBN-3005-W	Washers – 9/16" Cupped
2	R-3003	3/16" Rope
4	BC-36	Bungee Cord Hold Ups
6	DBA-3000	Earth Cable Anchors
6	UB-3002	U Bolts with Nuts
1	DR-3001	36" Drive Rod
4	EP-1000	1-5/8" Plastic End Plugs
10	EP-1001	1" Plastic End Plugs

**Note: All Side and Base Ridge Poles MUST be on Inside of Arch Frame Members. Top Ridge Poles MUST be on Outside of Arch Frame members, except at Ends. See Frame Assembly Step 5.**

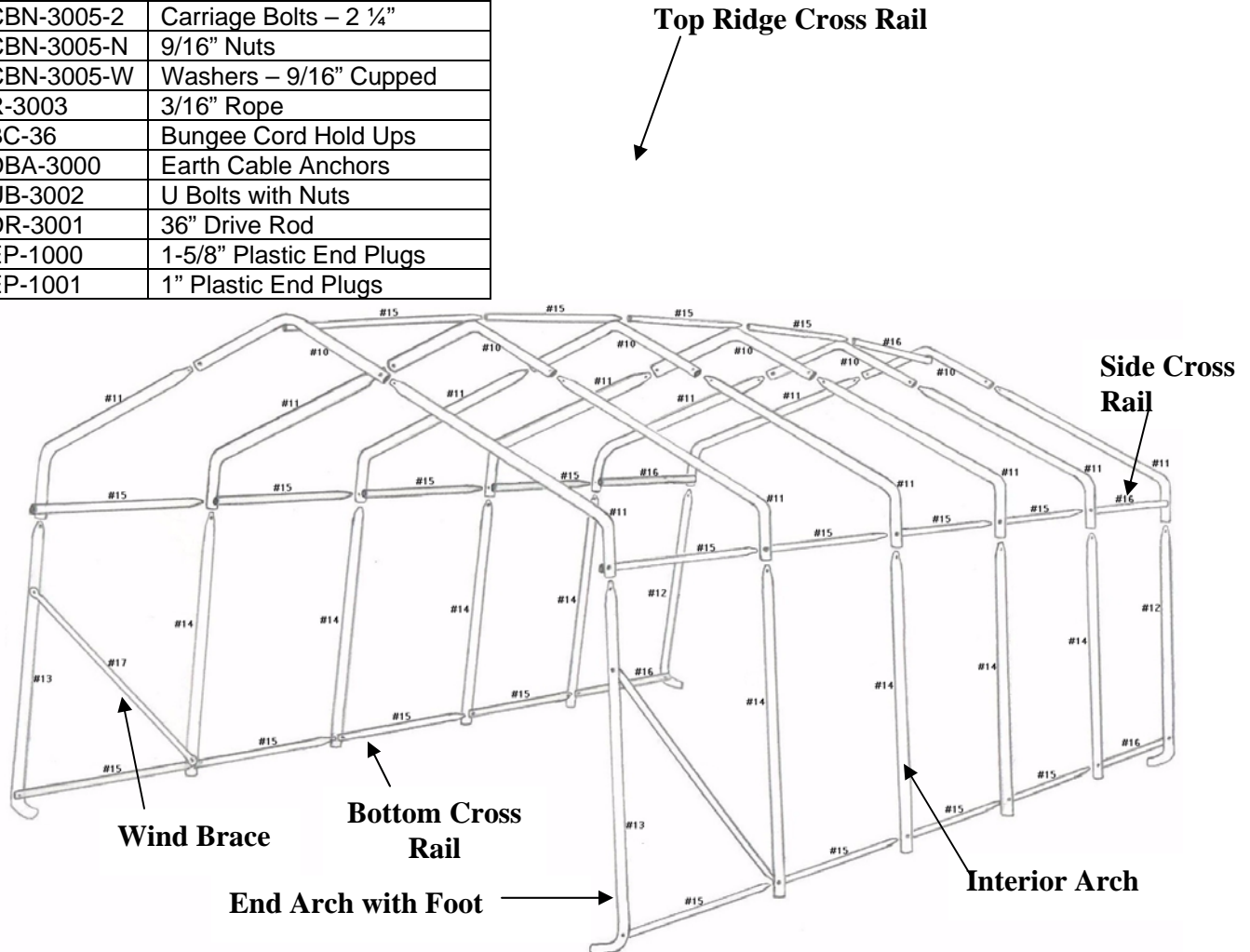

## **SITE PREPARATION**

Select a level or as close to level as practical location for your Rhino Shelter unit. The unit should be placed on a base of materials suitable for the storage load to be protected. The unit should not be located under trees, which will shed hard fruit such as apples, walnuts, or heavy pine cones. The cover of your unit will protect against normally leaves and light debris, however large branches or other falling items may cause puncture or tears in the cover material.

Take notice of drainage around your intended location. Water draining from the surrounding terrain should be planned so that it does not run into the unit. As well, rain or melting snow that comes off the unit should be drained away rather than accumulate and pool around the unit.

Check to be certain that adequate clearance is allowed for entry and exit from ends of unit. As unit has doors on both ends, ideally vehicle or contents can be inserted or removed from either end.



# Assembly Instructions House Style Greenhouse 12 x 20 x 8

## FRAME ASSEMBLY

**Step 1.** Assemble the Front and Rear End Arch Assemblies. Each will consist of (1) Top Crest (TC-2000), (2) Bent Tube Side Crest (BTSC-2006) and (2) End Upright w/Foot (EUL-2002) for each one. Use (4) CBN-3005-2 carriage bolts with nuts and washers through pre-drilled holes in frame members.

Be certain to insert carriage bolts from the outer edge into the interior of the unit, with the washers and nuts on the inside of the arches. This will avoid tearing the fabric on doors and main cover when installed. Do not tighten the nuts completely until the frame is completed and set in place.

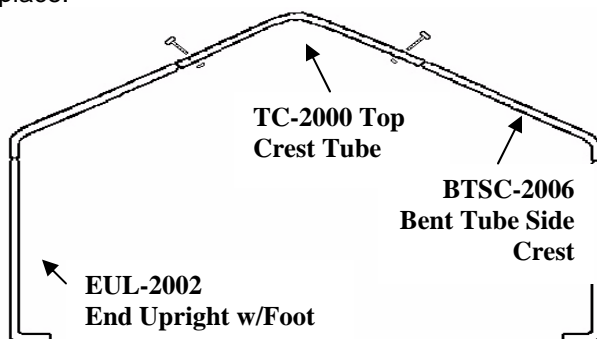

**Step 2.** Assemble the (2) Corner Wind Braces (CW-2005) to the End Upright w/Foot (EUL-2002) to the first of the End Arch assemblies. Use a CBN-3005-3 Carriage Bolt with Washer and Nut to secure the braces loosely to the Upright. Do not tighten completely.

**Step 3.** Assemble the Four Interior Arch Assemblies. Each will consist of (1) TC-2000 Top Crest TuU-2001 Center Straight Upright for each of the arches. Use CBN-3000-2 carriage bolts with washers and nuts in the pre-drilled holes, aligned to form the arch.

**Step 4.** Support an End Arch Assembly with Wind Braces temporarily in the vertical position. Connect (4) SCR-2003 Plain End Cross Rails to the End Arch with (4) CBN-3005-3 carriage bolts, washers, and nuts through the pre-drilled holes in the arch members. The Cross Rails should be put into the bottom and side hole of the arch upright on each side. These will form the Base Cross Rails and the Side Cross Rails as the arches and additional cross rails are added. The Base and Side Cross Rails must all be inside the arch assembly. Again, don't tighten the hardware until the next arch and cross rails are assembled.

Stand an Interior Arch Assembly up vertically about 48" from the End Arch Assembly. Align the cross rails holes with the holes in the interior arch. Using (4) Carriage

Bolts CBN-3000-3 with nuts and washers, connect all four of the cross rails between the end arch and the first interior arch assemblies. Connect the (2) Wind Braces #CW-2005 diagonally across the end and interior arch as shown in the frame illustration. **Caution** - The assembly will not be self-supporting until the Wind Braces are put into place, so have someone else hold the assembly up while the bolts are inserted.

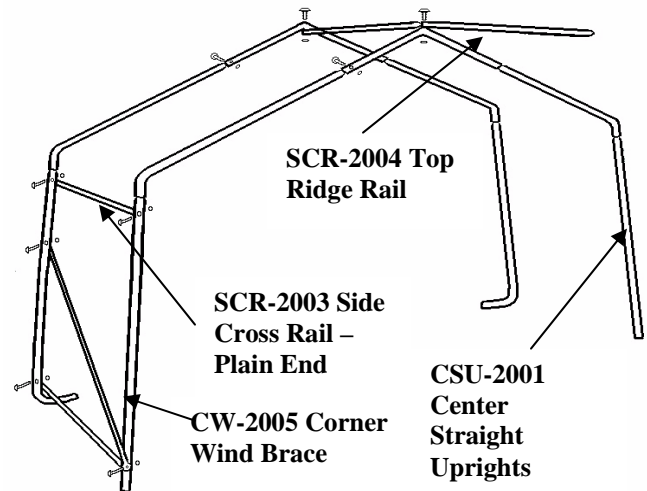

**Step 5.** Begin the Top Ridge Rail by placing the last SCR-2003 Plain End Cross Rail underneath the End Top Crest Tube, but above the first interior arch crest tube. Secure the Cross Rail loosely with a Carriage Bolt CBN-3000-2 with washer and nut facing the interior of the unit.



**Step 6.** Add remaining 3 middle arches and rear end arch in the same fashion. Use SCR-2004 Cross Rails for each connecting base, ridge, and top rails. The swaged end of the cross rails should be inserted into the prior end rail at all arches. Note that the Ridge Crest



## Assembly Instructions House Style Greenhouse 12 x 20 x 8

Rail should fasten under the End Top Crest Arches but above middle Top Crest tubes.

**NOTE:** Do not completely tighten bolts that connect the Cross Rails to the End Arches. They must be removed for proper for End Panel Zippered Door installation

**Step 7.** Move the frame assembly into its final installation location. This should be done with at least one person lifting each side or corner to avoid bending or stressing any frame members. Frame **must** then be aligned and squared up in position. Use a straight line string to align all frame members on the first side into position. Then measure and adjust each arch end to the proper base width of 12' to align the other side. Finally measure diagonally from inside corner to inside corner of frame. Both diagonal measurements should match. Measure at each end across base of arches. Do not expand arch width beyond 12' wide. This will severely reduce strength of arch assembly and cause fabric misfit.

Adjust frame and support as necessary to bring frame into square. **Failure to square frame of unit will result in poor main cover fit and reduced strength and rigidity.**



Align each Arch with string to make edge of Frame STRAIGHT before securing

**Step 8.** Once frame is square and properly supported, tighten carriage bolts on all frame members, except for End Arch members to Cross Rails along base, side, and top. After hardware is tightened, insert plastic end plugs EP-1000 (1 5/8") & EP-1001 (1") into all open ends of frame members.

### **ANCHORING FRAME TO GROUND**

Once frame is square and properly supported, tighten carriage bolts on all frame members, except for End Arch members to Cross Rails along base, side, and top. Do not over tighten or oval tubing. After hardware is tightened, insert plastic end plugs #14 (1 5/8") & #15 (1 1/8") into all open ends of frame members.

**NOTE: Frame must be anchored before installing any doors or cover.**

Each Rhino Shelter 12x20x8 building comes with 6 EARTH CABLE ANCHORS with U-bolts and nuts. These versatile anchors allow the frame to be secured to almost any surface. In addition you have also been provided with a 36" Drive Rod used to drive the anchor heads into the earth.

If the location where you are placing the building has very hard ground or any rock in it, pre-drill the holes before inserting anchors. Hammer drills can be rented at most home improvement or rent-all centers. Hitting the anchors into rock will cause the drive rod end to mushroom inside the anchor head, and prevent the drive rod from coming out of the hole.

Anchor placement should be made inside the frame at the interior corners of the unit, and midway along the sides of the frames. Anchors secure the building to the ground, as well as prevent spread of the frame over time.



*Pre-Drill Holes if there is Any Rock In Ground*



## Assembly Instructions House Style Greenhouse 12 x 20 x 8



Drive Rod inserts into Anchor Head

### ANCHOR STEP 1

**Step 1.** Place the drive rod provided into the cup of the anchor. Using a heavy hammer drive the anchor into the soil until 6-8 inches of cable remains above the earth. Remove drive rod.

### ANCHOR STEP 2

Place the Drive Rod through the loop in the anchor lanyard. Pull upward to set anchor head into the ground.



### ANCHOR STEP 3

Slip one side of the U-bolt through the eyelet at the end of the anchor cable. Attach the cable to the Arch leg upright with the U-bolt and tighten. Do not attach to base cross rails. Ensure there is no slack in the cable. Slack can be removed by wrapping the cable around the tie-down rail.



### END DOOR PANEL INSTALLATION

**Note: Both End Panels MUST be installed before installing Main Cover onto frame.**

**Step1.** Remove Carriage bolts from the Top Crest Rail and the two Upper Cross Rails. Install one End Panel Door w/Zipper (DZD-5002) at a time to the Frame assembly.

**Step 2.** Place the end panel over the first arch and wrap the material around the arch bringing the slits in the end panel to the inside of the frame arch. Place the top ridge pole and the side cross rails through the material slits and replace the carriage bolts and tighten. The door end will also require removal of the wind brace bolts and placement of the wind braces through slits in the ends panel. Reconnect wind braces with carriage bolts once end panel is put into place.



## Assembly Instructions House Style Greenhouse 12 x 20 x 8

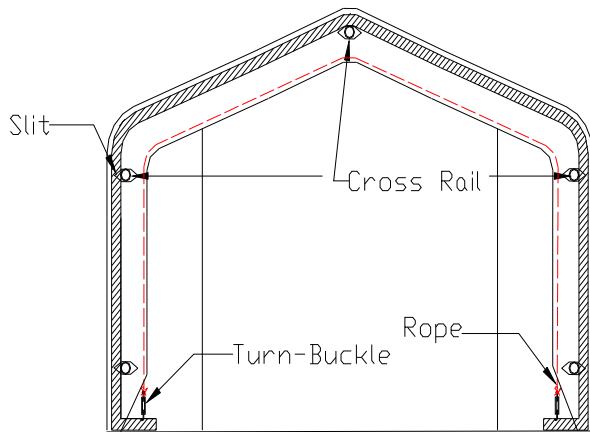

The rope channels should be located inside the unit, with the frame members passing through the pre-cut slits in the end panel/door. End Door Panels have pre-cut slits that allow frame members to pass through so rope pocket is inside unit. Replace and tighten the carriage bolts after putting the end panel into position.

When putting on the doors, adjust the length to make certain the doors do not drape onto the ground. Adjust by pulling more or less material over end arch. If pulling them up puts too much stress on the slit where it goes over the wind brace, use a sharp knife to cut slit another inch or two to relieve it. The PE fabric is rip-stop weave and will only separate where cut.

**Step 3.** Tie off one end of the rope coming out of the end panel to a turnbuckle. Turnbuckle should be loosened all the way and the open hook end attached to the hole in the inside of the end arch. Hold the end of the unsecured rope and apply pressure downward with a foot to remove excess. Re-adjust gathered material evenly along door rope. This step is key to getting a good door fit. Tie off the end off the rope to a second turnbuckle attached to a hole in the foot of the end arch on the opposite side. The end panel can be adjusted further by tightening the turnbuckles.



Door assembly is drawn over frame by tightening rope and securing to turnbuckles at the arch foot. Turnbuckle connects to hole on inside of arch foot as shown in illustration. Frame must be secured in position so it does not move as end doors and main cover are tightened over frame. This step is key to good fit and to prevent door movement in wind.



## Assembly Instructions House Style Greenhouse 12 x 20 x 8



*Note: Snug the end panel by turning the turnbuckles or repeating step 3 on a regular basis*



Unpack the Main Cover #MUC-5000 from the protective plastic packaging. The line of grommets on the inside (white) of the cover on the tie down Flap run parallel to the sides of the frame assembly for positioning.



### **MAIN COVER INSTALLATION**

**Step 1.** To elongate the life of Main Cover, put a small square of duct tape (field supplied) over each bolt head on frame that comes in contact with cover. The tape acts as a cushion to avoid rubbing damage to the cover over years.

Once cover is oriented properly to the Frame Assembly, pull Main Cover over frame assembly from the side, being careful not to snag the cover on any member, bolt, or other obstruction. Center the Main Cover over the Frame Assembly with the Main Cover colored side showing from the outside of the unit.

**Step 2.** Loosen the 4 remaining turnbuckles completely. Place the turnbuckles into outer hole in the foot of each end arch. Tie off the rope coming out of the Main Cover rope slot on either side to the turnbuckles. After securing one end of the rope in the Main Cover, pull the excess slack out of the rope and cover to tighten. Hold the end of the unsecured rope and apply pressure



## Assembly Instructions House Style Greenhouse 12 x 20 x 8

downward with a foot to remove excess. Temporarily tie the end of the rope to the turnbuckle. Go over the entire outer edge of the cover and adjust the excess material around the end so it is not bunched up. Spread excess material evenly along the outer edge. Once cover is pulled snug and even, tie off the rope end to the turnbuckle. All slack should be out of the rope at this time. Repeat this step on both ends of the cover. Tighten the turnbuckle to tighten the cover. This step may need to be repeated to ensure a snug and centered fit.



**Step 3.** When the cover is completely aligned secure the cover to the bottom tie-down cross rail using the rope provided. Start at one end and tie off the rope to the cross rail. Lace the rope through the grommets in the cover and back under the tie-down cross rail. Repeat this on the opposite side



Pay close attention to how tight the cover is put onto the frame. It should be tight enough so it does not flap around in the wind, but not so tight that it tears the material cover. The fabric backed PE fabric of Rhino Shelter units does not stretch. If you pull it so tight that the fabric is stretched, a small amount of additional stress from wind or contact can cause premature tears and failure. Only tighten cover enough to remove valleys between arch assemblies. Do Not over tighten.

**Step 4.** Retighten the turnbuckles on both the cover and end panels. Retighten the rope holding the main cover to the bottom cross rail. **Both the cover and the end panels should be checked and tightened on a monthly basis.**

### DOOR HOLD UPS

All Rhino Shelter doors are manufactured with a pocket on the bottom edge along the width axis. A ½" to 1" plastic or metal tube can be inserted into the pocket and trimmed to fit width. Weight will reduce door movement in wind. Four(4) bungee straps are provided to retain the door up. Roll the door from the bottom and secure the door roll with a bungee through the upper door grommet as shown.

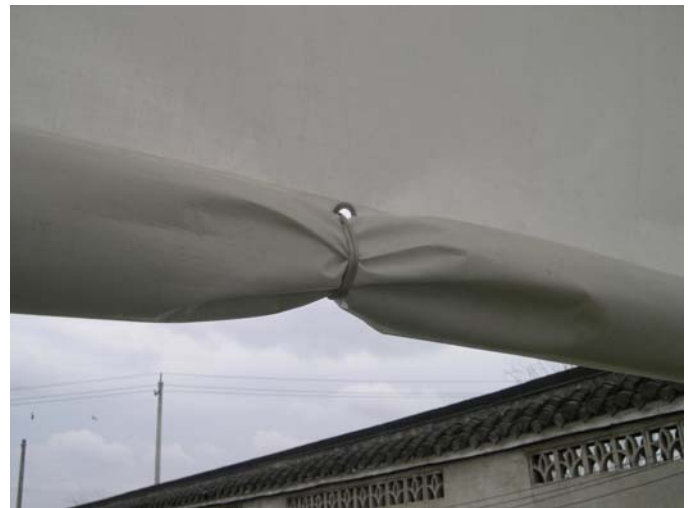

### MAINTENANCE AND CARE

Annually or more often, the unit should be completely inspected internally and externally to make certain the unit remains properly installed and secured. Particular attention should be paid to:

Hardware – check all carriage bolts and hardware connectors to be certain they are in place and tightened.





## Assembly Instructions House Style Greenhouse 12 x 20 x 8

---

Anchors – during normal weather trends, the unit will strain against the anchors under windy conditions. Anchor hardware connection to frame members should be maintained tight and depth of anchors should be checked to be certain they remain deeply and firmly set.

Snow Accumulation – all snow accumulation on the main cover should be removed as soon as practical. The most damage from snow weight can occur the days following a snowfall when the snow melts. Unit is not designed for any amount of accumulated snow or ice. Tap the main cover from the inside with a broom end to knock off any accumulated snow.

Main Cover Lacing – the poly rope that secures the main cover to the bottom rail of the frame assembly should be checked, and adjusted as needed. The tension on the main cover should be uniform from end to end and side to side. Rope ends must be tied off onto the frame members at the ends on each side.

Turnbuckle Adjustment – during normal wind conditions and load, the doors and main cover adjustment points at the turnbuckle should be checked and tightened as necessary. The turnbuckles should be neither completely extended nor taken up, so that turnbuckle should be tight when in the mid range of overall adjustment. If necessary, readjust rope tie off on turnbuckle as needed to tighten or loosen as needed.

Cleaning – cover and doors can be cleaned with a mixture of light detergent and water. A soft bristle brush with the mixture can be used to loosen any hard dirt, mold, or buildup on the cover. After cleansing, the cover should be rinsed thoroughly to avoid any chemical reaction from residual detergent. Allowing dirt and debris to sit on cover over an extended time will damage cover irreparably.

Severe Weather – in preparation for inclement weather, completely secure the doors on both ends of your Rhino Shelter garage. Allowing wind to enter either end lifts the building and puts undue stress on the anchoring system. This also shortens the life of the doors, zippers, and main cover.

### Customer Service or Installation Assistance

Care and attention to a proper installation will add many years of life and function to your Rhino Shelter unit.

Please retain purchase documentation for your Rhino Shelter unit. All warranty claims must include purchase documentation for verification. All parts on your Rhino Shelter unit are available for replacement as needed. Protect your purchase by completing warranty registration card and mail/fax as soon as practical after installing your unit.



# Assembly Instructions Round Style Greenhouse 12 x 20 x 8

## ASSEMBLY INSTRUCTIONS ROUND STYLE GREENHOUSE 12Wx20Lx8H

### Congratulations!

Congratulations on your purchase of a Round Style Greenhouse by Rhino Shelter. With proper installation, use, and maintenance, your new unit will provide many years of good and suitable service. Your new Rhino Shelter portable enclosure is a combination of excellent engineering and well thought out design. The unit is comprised of a rigid tubular frame, covered with a long life polyethylene cover and double door ends.

The multiple part frame is pre-drilled for easy insertion of hardware to assemble. The tubing is made from high-grade galvanized steel tubing, to resist moisture and oxidation over the life of the shelter. The covering membrane is made from ASTM-5 approved polyethylene materials. The cover is UV protected for continual exposure to the sunlight.

It is suggested that you read the assembly instructions completely before you begin. This will help attain the best results for your installation the first time.

### **SAFETY WARNING**

**The installation of this unit must conform to the requirements of all authorities having jurisdiction in your specific local area. In the absence of such requirements, the installation must conform to the provided assembly and installation instructions. MDM Products LLC will not be responsible for failure to comply with any requirements in a given local area. Consequential damages or injuries caused by improper installation, alteration, or improper use are strictly that of the user. Unit MUST be cleared of All Snow Accumulation immediately to avoid overload. Unit is not to be used for occupancy for any length of time. No running internal combustion engines, open flames, or contact with heated surfaces are allowed.**

Cartons should be inspected upon delivery from carrier, and any evident damages should be noted on the bill of lading before signing. If upon opening the cartons hidden damage is noted, contact carrier or its agent immediately. Claims for shipping damage MUST be made with the shipping company. An inspection of the goods will most likely be required. Do not discard

packing or any components before the freight company's inspection. All claims for freight damage must be made with 15 days of receipt of the goods in accordance with ICC regulations.

### ASSEMBLY PROCEDURE

The proper sequence and steps to install this unit will produce a proper and good installation. Failure to read and follow these guidelines may result in an improper installation and will void all warranty and protection the owner is entitled to with the product. The steps to be undertaken are:

1. Perform an inventory check before beginning to be certain all components are available for installation.
2. Prepare location and place both unit boxes near location sight.
3. Assemble six(6) arches of unit
4. Assemble unit end arch, first interior arch, and Wind Braces with first base rails and side rail sections.
5. Add additional arch assemblies with each section of base rails and side rails.
6. Place frame into desired position and level frame both end-to-end and side-to-side. Measure interior of frame feet across opposite corners and square
7. Anchor frame assembly to ground with provided anchors, u-bolts and drive rod provided.
8. Install two(2) doors on both ends of frame assembly.
9. Install main cover over frame assembly.

### TOOLS REQUIRED

The following hand tools will be needed for proper installation of your new Rhino Shelter unit:

- 9/16" Open End Wrench**
- 9/16" Socket or Box Wrench**
- Large Flat Tip Screwdriver**
- Maul or Sledgehammer**
- 2 foot Level**
- 6-Foot Step Ladder**

### Inventory Check

Start installation procedure by removing all components from packaging and ensure all components are present

Qty	Ltr	Part Number	Description
1		RUC-5000	Main Unit Cover
2		DZD-5002	End Panel Door with Zippers
4	G	EUL-4021	End Upright w/Foot
6	B	RC-3020	Right Side Crest Tube
6	A	LC-3021	Left Side Crest Tube - swedged



# Assembly Instructions Round Style Greenhouse 12 x 20 x 8

8	E	CSU-4020	Center Straight Uprights
2	H	CW-1800	Corner Wind Brace
20	C	SCR-2030	Swedged Cross Ridge Poles
5	D	ECR-2031	End Cross Poles – plain ends
8		TB-3004	Turnbuckles
30		CBN-3005-3	Carriage Bolts – 3 1/4"
2		CBN-3005-2	Carriage Bolts – 2 1/4"
32		CBN-3005-N	9/16" Nuts
32		CBN-3005-W	Washers – 9/16" Cupped
2		R-3003	3/16" Rope
4		BC-36	Bungee Cord Hold Ups
6		DBA-3000	Earth Cable Anchors
6		UB-3002	U Bolts with Nuts
1		DR-3001	36" Drive Rod
4		EP-1000	1-5/8" Plastic End Plugs
10		EP-1001	1" Plastic End Plugs

Note: All Side and Base Ridge Poles MUST be on Inside of Arch Frame Members. Top Ridge Poles MUST be on Outside of Arch Frame members, except at Ends. See Frame Assembly Step 5.

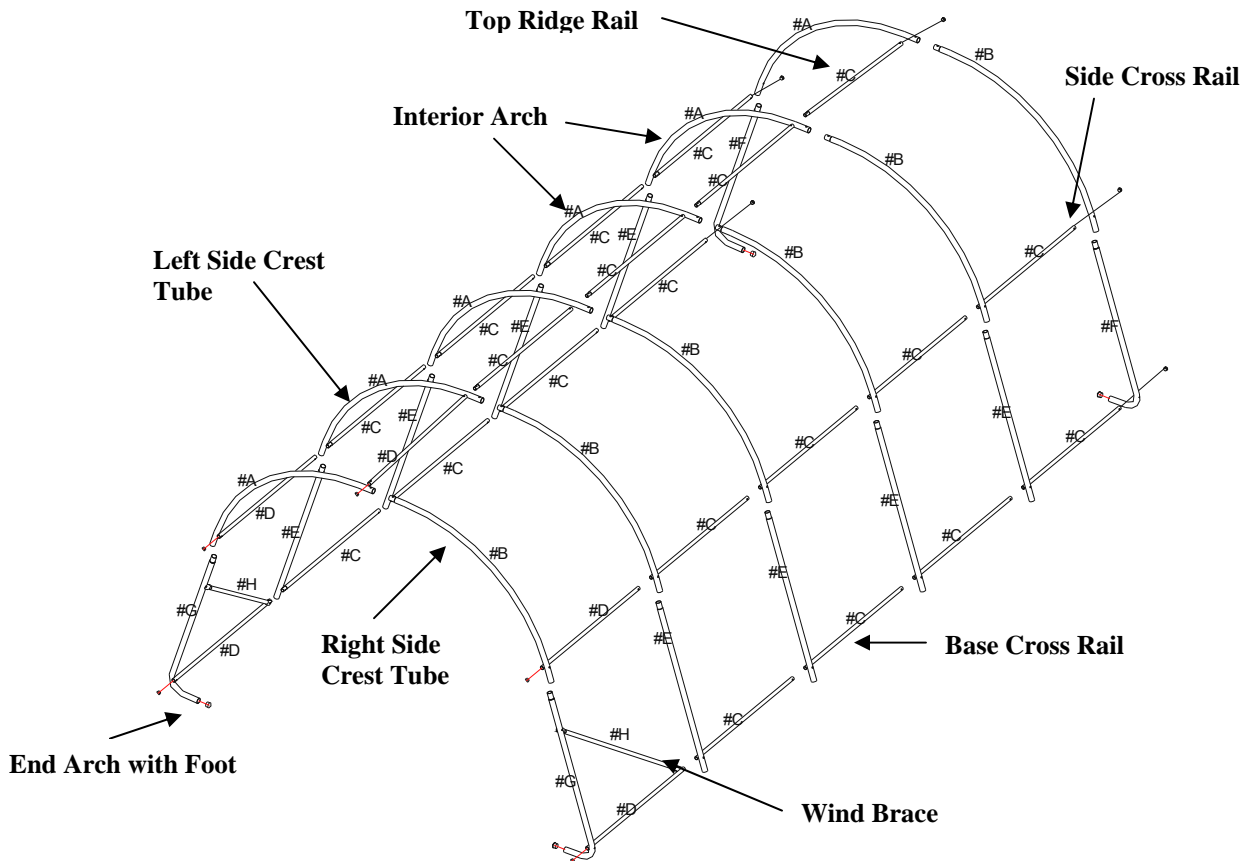

## SITE PREPERATION

Select a level or as close to level as practical location for your Rhino Shelter unit. The unit should be placed on a base of materials suitable for the storage load to be

protected. The unit should not be located under trees, which will shed hard fruit such as apples, walnuts, or heavy pine cones. The cover of your unit will protect against normally leaves and light debris, however large



# Assembly Instructions Round Style Greenhouse 12 x 20 x 8

branches or other falling items may cause puncture or tears in the cover material.

Take notice of drainage around your intended location. Water draining from the surrounding terrain should be planned so that it does not run into the unit. As well, rain or melting snow that comes off the unit should be drained away rather than accumulate and pool around the unit.

Check to be certain that adequate clearance is allowed for entry and exit from ends of unit. As unit has doors on both ends, ideally vehicle or equipment can be inserted or removed from either end.

## FRAME ASSEMBLY

**Step 1.** Assemble the two End Arch Assemblies. Each consists of (1) Right Side Crest Tube RC-3020, (1) Left Side Crest Tube LC-3021 and (2) End Upright w/Foot EUL-4021 for each one. Assemble as shown below. The swedged ends slip into the plain end pipe. Use (2) CBN-3005-2 carriage bolts with nuts and washers through pre-drilled holes in frame members.

Be certain to insert carriage bolts from the outer edge into the interior of the unit, with the washers and nuts on the inside of the arches. This will avoid tearing the fabric on doors and main cover when installed. Do not tighten the nuts completely until the frame is completed and set in place.

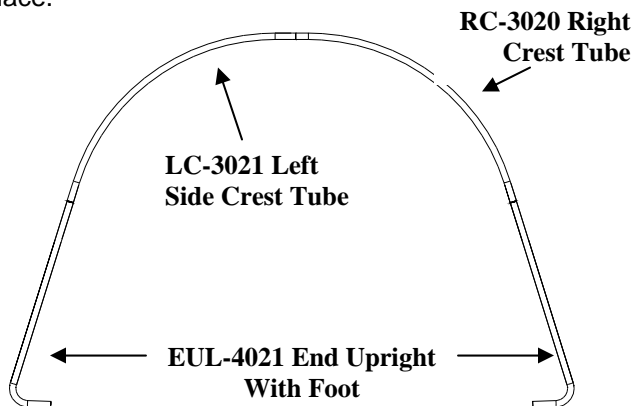

**Step 2.** Attach the (2) Corner Wind Braces CW-1800 to the End Upright w/Foot EUL-4021 to the first of the End Arch assemblies. Use a CBN-3005-3 Carriage Bolt with Washer and Nut to secure the braces loosely to the Upright. Do not tighten completely.

**Step 3.** Assemble the Four Interior Arch Assemblies using (1) Right Crest Tube RC-3020, (1) Left Crest Tube LC-3021, and (2) Center Straight Upright CSU-4020 for

each. Use CBN-3005-3 carriage bolts with washers and nuts in the pre-drilled holes, aligned to form the arch.

**Step 4.** Support an End Arch with Wind Braces CW-1800 temporarily in the vertical position. Connect (4) ECR-2031 Plain End Cross Rails to the End Arch with (4) CBN-3005-3 carriage bolts, washers, and nuts through the pre-drilled holes in the arch members. The Cross Rails should be put into the bottom and side hole of the arch upright. These will begin the Base Cross Rails and Side Cross Rails on each side of the frame assembly. Again, don't tighten the hardware until the next arch and cross rails are assembled.

Stand an Interior Arch Assembly up vertically approximately 48" from the End Arch Assembly. Align the cross rails from the End Arch with the holes in the Interior Arch. Using (4) Carriage Bolts CBN-3005-3 with nuts and washers, connect the cross rails between the End Arch and the first Interior Arch. Connect the (2) Wind Braces #CW-2005 diagonally across the end and interior arch as shown in the frame illustration.

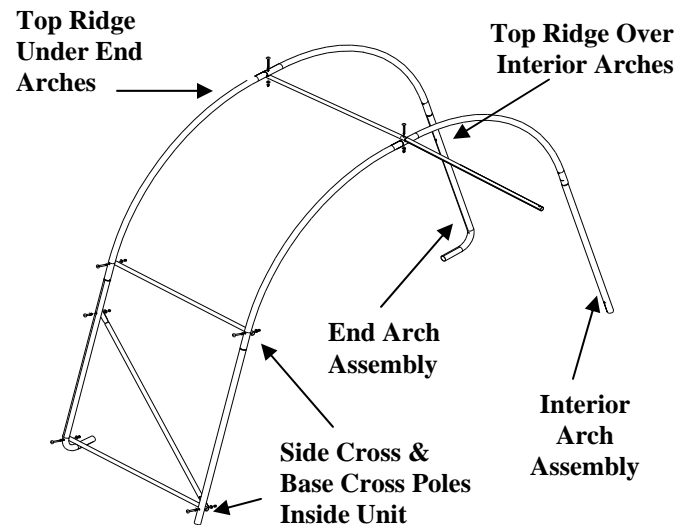



## Assembly Instructions Round Style Greenhouse 12 x 20 x 8



**Step 5.** Begin the Top Ridge Rail by placing the final ECR-2031 Plain End Cross Rail underneath the End Arch Tube. Secure the Cross Rail loosely with a Carriage Bolt CBN-3005-3 with washer and nut facing the interior of the unit. This begins the Top Ridge Rail. The other end of the Cross Rail goes on to of the Interior Arch as shown in the illustration above.

**Step 6.** Add the next Interior Arch by placing a Swedged Cross Rail into each of the Base, Side, and Top Ridge Cross Rails, and then attaching Arch Assembly. The swedged end of each cross rail slips into the plain end of the cross rail before it. Secure each Arch Assembly onto the frame by carriage bolts at each cross rail. Add Interior Arches and second End Arch in the same fashion. Note that the Plain end of Swedged Cross Rail should fasten under the End Top Crest Arch at the End arch.

**NOTE:** Do not completely tighten bolts that connect the Cross Rails to the End Arches. They must be removed for proper for End Panel Zippered Door installation

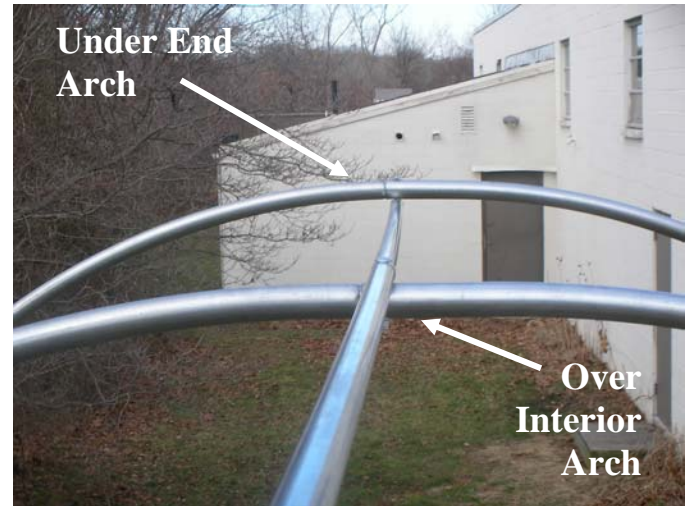

**Step 7.** Move the frame assembly into its final installation location. This should be done with at least one person lifting each side or corner to avoid bending or stressing any frame members. Frame must be squared up in position. Measure from diagonally from inside corner to inside corner of frame. Both diagonal measurements should match. Adjust frame and support as necessary to bring frame into square. **Failure to square frame of unit properly will result in poor cover fit and reduced strength and rigidity.**



**Step 8.** Once frame is square and properly supported, tighten carriage bolts on all frame members, except for End Arch members to Cross Rails along base, side, and top. Support End Arch feet with patio blocks or bricks as needed if ground is soft and will not support weight. After hardware is tightened, insert plastic end plugs #EP-1000 (1 5/8") & EP-1001 (1") into all open ends of frame members.



# Assembly Instructions Round Style Greenhouse 12 x 20 x 8

## ANCHORING FRAME TO THE GROUND

Once frame is square and properly supported, tighten carriage bolts on all frame members, except for End Arch members to Cross Rails along base, side, and top. Do not over tighten or oval tubing. After hardware is tightened, insert plastic end plugs #14 (1 5/8") & #15 (1 1/8") into all open ends of frame members.

**NOTE: Frame must be anchored before installing any doors or cover.**

Each Rhino Shelter 12x20x8 building comes with 6 EARTH CABLE ANCHORS with U-bolts and nuts. These versatile anchors allow the frame to be secured to almost any surface. In addition you have also been provided with a 36" Drive Rod used to drive the anchor heads into the earth.

If the location where you are placing the building has very hard ground or any rock in it, pre-drill the holes before inserting anchors. Hammer drills can be rented at most home improvement or rent-all centers. Hitting the anchors into rock will cause the drive rod end to mushroom inside the anchor head, and prevent the drive rod from coming out of the hole.

Anchor placement should be made inside the frame at the interior corners of the unit, and midway along the sides of the frames. Anchors secure the building to the ground, as well as prevent spread of the frame over time.



*Drive Rod inserts into Anchor Head*

### **ANCHOR STEP 1**

**Step 1.** Place the drive rod provided into the cup of the anchor. Using a heavy hammer drive the anchor into the soil until 6-8 inches of cable remains above the earth. Remove drive rod.

### **ANCHOR STEP 2**

Place the Drive Rod through the loop in the anchor lanyard. Pull upward to set anchor head into the ground.



### **ANCHOR STEP 3**

Slip one side of the U-bolt through the eyelet at the end of the anchor cable. Attach the cable to the Arch leg



*Pre-Drill Holes if there is Any Rock In Ground*



## Assembly Instructions Round Style Greenhouse 12 x 20 x 8

upright with the U-bolt and tighten. Do not attach to base cross rails. Ensure there is no slack in the cable. Slack can be removed by wrapping the cable around the tie-down rail.

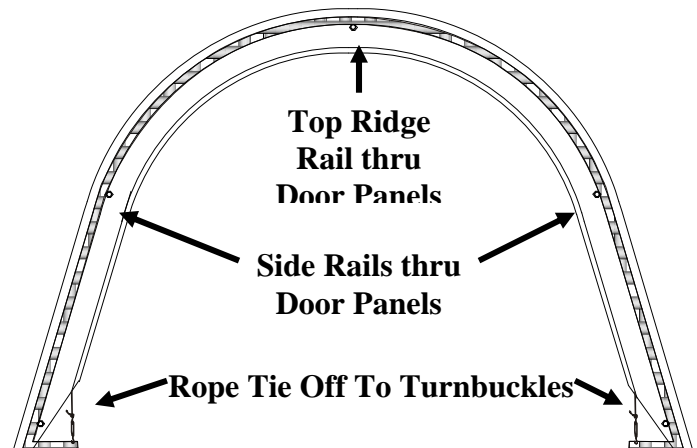

### END PANEL INSTALLATION

**Note:** End panels **MUST** be installed before installing Main Cover onto frame.

**Step 1.** Remove Carriage bolts from the Top Crest Rail and the two Upper Cross Rails. Install one End Panel Door w/Zipper #DZD-5002 at a time to the Frame assembly. Carefully align the door material over the arch to make an even fit.

**Step 2.** Place the end panel over the first arch and wrap the material over the End Arch bringing the slits in the end panel to the inside of the frame. End Door Panels have pre-cut slots that allow frame members to pass through so rope pocket is inside unit. Place the top ridge rail pole and the side cross rail poles through the material slits and replace the carriage bolts and tighten. Each door end will also require removal of the wind brace bolts and placement of the wind braces through slits in the ends panel. Reconnect wind braces with carriage bolts once end panel is put into place.



The rope slot should be located inside the unit, with the frame members passing through the pre-cut slots in the end panel/door. Replace the carriage bolts after putting the end panels into position.





# Assembly Instructions Round Style Greenhouse 12 x 20 x 8

When putting on the doors, adjust the length to make certain the doors do not drape onto the ground. If pulling them up puts too much stress on the slit where it goes over the wind brace, use a sharp knife to cut slit another inch or two to relieve it. The PE fabric is rip-stop weave, and can easily be cut to relieve stress at the frame members.

**Step 3.** Tie off one end of the rope coming out of the end panel to a turnbuckle (turn-buckle should be loosened all the way) and attach the turnbuckle to the hole in the foot of the end arch. Hold the end of the unsecured rope and apply downward pressure with a foot to remove excess slack. Re-adjust gathered material evenly along inside edge of door rope slot. This step is key to getting a good door fit. Tie off the end of the rope to a second turnbuckle (fully opened) attached to a hole in the foot of the end arch on the opposite side. The end panel can then be tightened further by adjusting each turnbuckle.



*Note: Adjust the end door panel by turning the turnbuckles or repeating step 3 on a regular basis*

## MAIN COVER INSTALLATION

**Step 1.** To elongate the life of Main Cover, put a small square of duct tape (field supplied) over each bolt head on frame that comes in contact with cover. The tape acts as a cushion to avoid rubbing damage to the cover over years.



After covering bolt heads with tape, unpack the Main Cover #RUC-5000 from the protective plastic packaging. The line of grommets on the inside (white) of the cover on the tie Down Flap run parallel to the sides of the frame assembly for positioning. Once cover is oriented properly to the Frame Assembly, pull Main Cover over top of frame assembly from the side, being careful not to snag the cover on any member, bolt, or other obstruction. Center the Main Cover over the Frame Assembly with the Main Cover colored side showing from the outside of the unit.

**Step 2.** Loosen the 4 remaining turnbuckles completely. Place the turnbuckles into hole in the foot of the end arches on the outside of the end panel. Tie off the rope coming out of the Main Cover rope slot on either side to the turnbuckles. After tying off one end of the rope in the Main Cover, pull the excess slack out of the rope and cover. Hold the end of the rope and push directly down with a foot onto the excess rope. Temporarily tie the other end of the rope to the turnbuckle. Go over the entire edge of the cover and adjust the excess folds of material around the end so it is evenly distributed around rope slot. Once the rope is pulled tight and the cover is adjusted evenly over frame, tie off the rope end to the turnbuckle. All slack should be out of the rope at this time. Tighten the turnbuckle to further tighten the cover if necessary. Ensure the cover is centered. (this step





## Assembly Instructions Round Style Greenhouse 12 x 20 x 8

may need to be repeated to ensure a snug and centered fit)

**Step 3.** When the cover is completely aligned secure each side of the cover to the bottom cross rail using the ropes provided. Start at one end and tie off the rope to the cross rail. Lace the rope through the grommets in the cover and back under the tie-down cross rail. Repeat this on the opposite side. Cover edge flap should be on the outside of unit to repel rain or snow.

Pay close attention to how tight the cover is put onto the frame. It should be tight enough so it does not flap around in the wind, but not so tight that it tears the material cover. The fabric backed PE fabric of Rhino Shelter units does not stretch. If you pull it so tight that the fabric is stretched, a small amount of additional stress from wind or contact can cause premature tears and failure. Only tighten cover enough to remove valleys between arch assemblies. Do Not over tighten.



**Step 4.** Retighten or readjust the turnbuckles on both the cover and end panels as needed. Retighten the rope holding the main cover to the bottom cross rail. **Both the cover and the end panels should be checked and tightened on a monthly basis.**

### DOOR HOLD UPS

All Rhino Shelter doors are manufactured with a pocket on the bottom edge along the width axis. A ½" - 1" plastic or metal tube can be inserted into the pocket and trimmed to fit door width. Weight will reduce door movement in wind. Four (4) bungee straps are provided to retain the door in the up position. Roll the door from the bottom and secure the door roll with a bungee through the upper door grommet as shown.

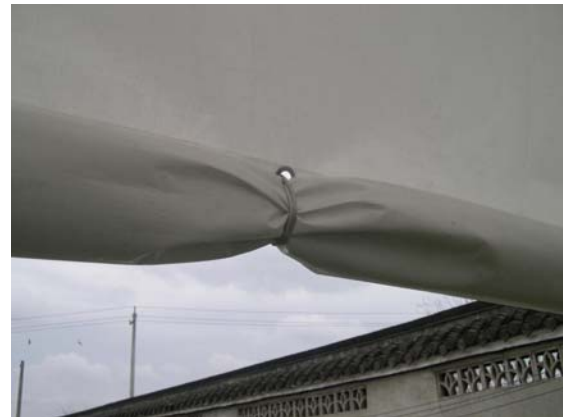

### MAINTENANCE AND CARE

Annually or more often, the unit should be completely inspected internally and externally to make certain the unit remains properly installed and secured. Particular attention should be paid to:

Hardware – check all carriage bolts and hardware connectors to be certain they are in place and tightened.

Anchors – during normal weather trends, the unit will strain against the anchors under windy conditions. Anchor hardware connection to frame members should be maintained tight and depth of anchors should be checked to be certain they remain deeply and firmly set.

Snow Accumulation – all snow accumulation on the main cover should be removed as soon as practical. The days following a snowfall when snow melts are when the most damage can occur. Unit is not designed for any amount of accumulated snow or ice. Tap the main cover from the inside with a broom end to knock off any accumulated snow.

Main Cover Lacing – the poly rope that secures the main cover to the bottom rail of the frame assembly should be checked, and adjusted as needed. The tension on the main cover should be uniform from end to end and side to side. Rope ends must be tied off onto the frame members at the ends on each side.

Turnbuckle Adjustment – during normal wind conditions and load, the doors and main cover adjustment points at the turnbuckle should be checked and tightened as necessary. The turnbuckles should be neither completely extended nor taken up, so that turnbuckle should be tight when in the mid range of overall adjustment. If necessary, readjust rope tie off on turnbuckle as needed to tighten or loosen as needed.



## Assembly Instructions Round Style Greenhouse 12 x 20 x 8

---

Cleaning – cover and doors can be cleaned with a mixture of light detergent and water. A soft bristle brush with the mixture can be used to loosen any hard dirt, mold, or buildup on the cover. After cleansing, the cover should be rinsed thoroughly to avoid any chemical reaction from residual detergent. Allowing dirt and debris to sit on cover over an extended time will damage cover irreparably.

Severe Weather – in preparation for inclement weather, completely secure the doors on both ends of your Rhino Shelter garage. Allowing wind to enter either end lifts the building and puts undue stress on the anchoring system. This also shortens the life of the doors, zippers, and main cover.

### **CUSTOMER SERVICE OR INSTALLATION**

Care and attention to a proper installation will add many years of life and function to your Rhino Shelter unit.

Please retain purchase documentation for your Rhino Shelter unit. All warranty claims must include purchase documentation for verification. All parts on your Rhino Shelter unit are available for replacement as needed. Protect your purchase by completing warranty registration card and mail/fax as soon as practical after installing your unit.