

RIGHT WEIGH



Installation Manual

AIR LINE AND ELECTRICAL INSTALLATION KIT

FOR 201 SERIES | 201-SK

RIGHT WEIGH



PP-003-0008 Revision C
December 2019

PARTS INCLUDED

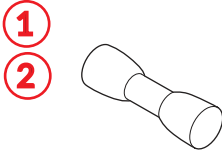

4 Heat Shrink
Wire Connectors

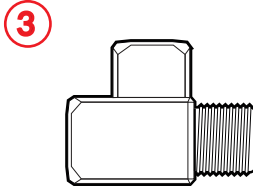

1/4" NPT Street
Tee Fitting

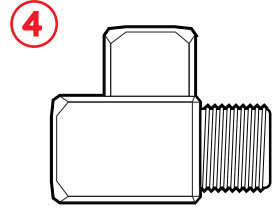

3/8" NPT Street
Tee Fitting

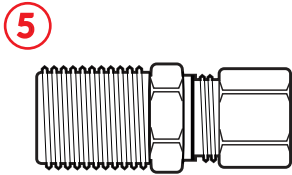

1/4" NPT Male
Straight Fitting

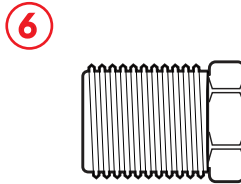

3/8" NPT to 1/4"
NPT Reducer
Fitting

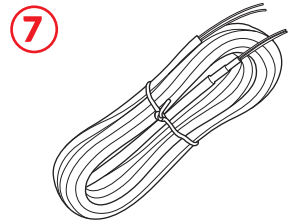

Power and
Ground Extension
Cable

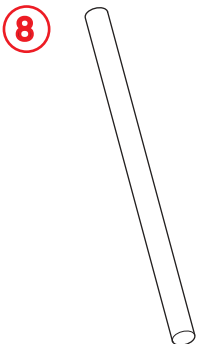

2 Heat Shrink
Tubes

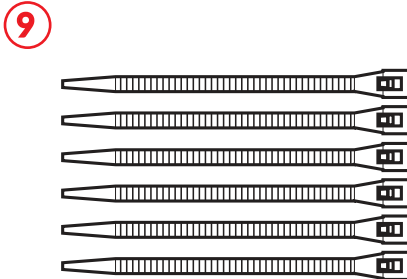

30 Zip Ties

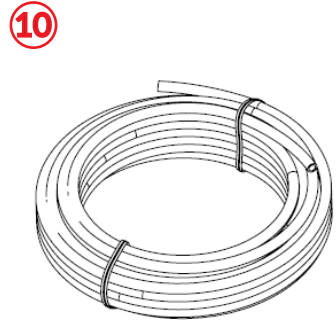

1/4 Inch Air Line

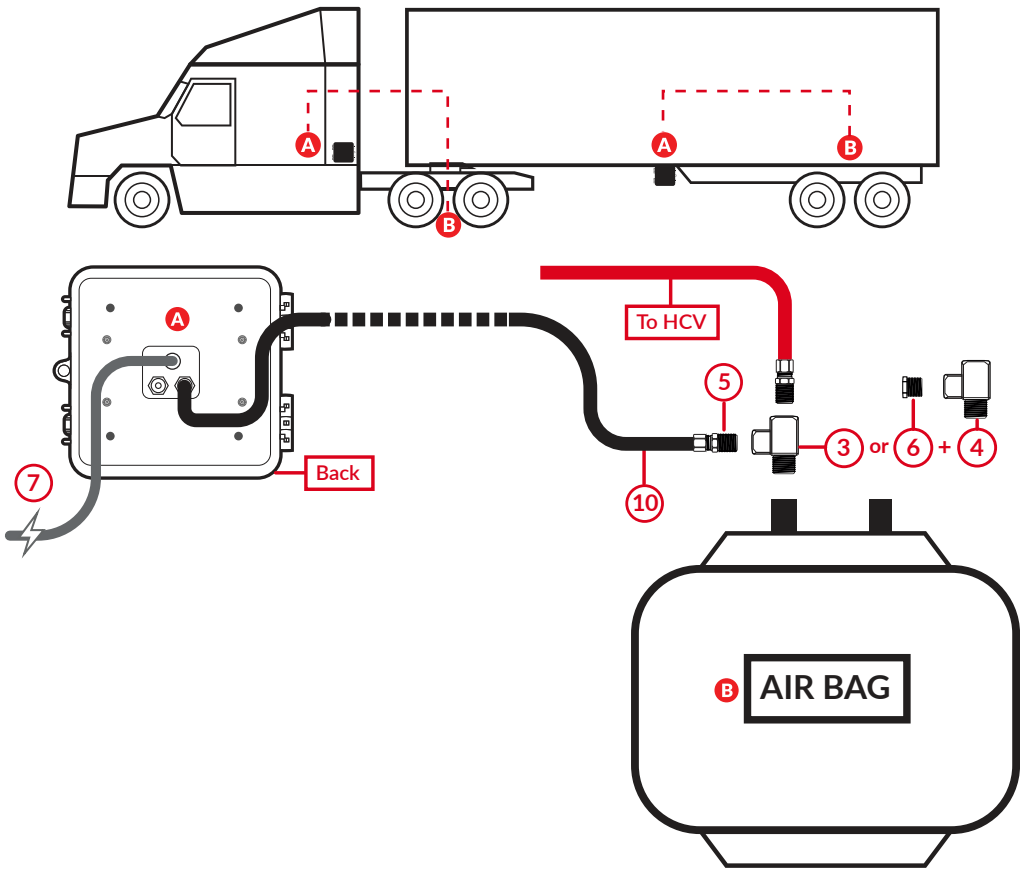

WATER PROOF HEAT SHRINK WIRE CONNECTION

Crimp each end of the wire into the connector with a wire crimp tool (tool not provided).

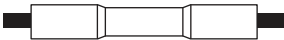

With a heat gun or heat torch, heat the connector until it shrinks completely around each wire end. Make sure you do not burn the wire jacket.



After all connections have been made, heat shrink the entire group of splices so that it seals on the outer jacket of both cables.

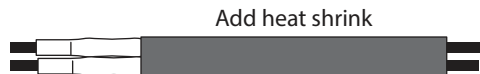

After heat shrinking

