

Right Weigh Load Scales

Interior Digital Load Scale 202-DDG-04



Installation and Operation Manual

Please read carefully before installation

Specifications:

Operating Temperature: -20°C to $+85^{\circ}\text{C}$ (-4°F to $+185^{\circ}\text{F}$)

Storage Temperature: -20°C to $+85^{\circ}\text{C}$ (-4°F to $+185^{\circ}\text{F}$)

Power Supply: 9 VDC to 32 VDC

Units: Pounds (LBS) or Kilograms (KG)

Housing: ABS

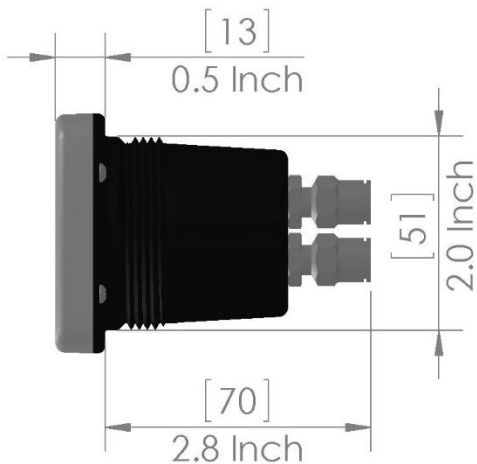
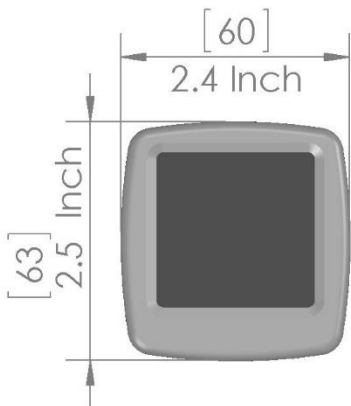

1.0 Installation and Set-up Overview

The Right Weigh 202-DDG-04 digital dash gauge is a self-contained monitoring device that has four internal pressure sensors. It is designed to monitor one or more air suspension axle groups. The number of axle groups that can be monitored depends on the number of Height Control Valves (HCV) per axle group. An axle group that has one HCV needs only one pressure sensor to monitor the air pressure in one air spring connected to the HCV. An axle group that has two HCVs needs two sensors to monitor the air pressure in one air spring connected to each HCV.

An axle group can consist of one, two, or three axles with air springs that are managed by the same HCV system. Each axle group can have one or two Height Control Valve (HCV)s.

Note: Because they are not managed by a height control valve, independent (manually regulated) lift axles cannot be considered part of an axle group.

Warning! This gauge must be mounted inside the vehicles cabin, it is not for use outdoors.

202-DDG-04 Application Options:

2 separate axle groups with 2 HCVs for each axle group.

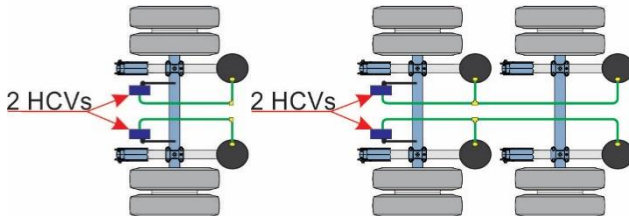

1 axle group with 2 HCVs AND 2 separate axle groups with 1 HCV for each axle group.

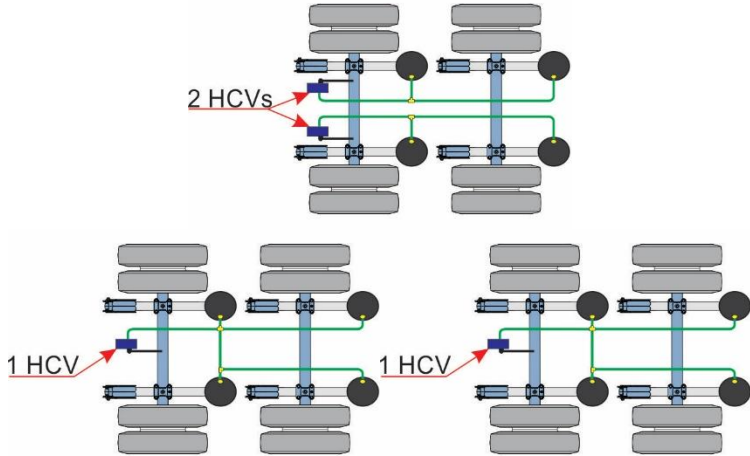

4 separate axle groups with 1 HCV for each group

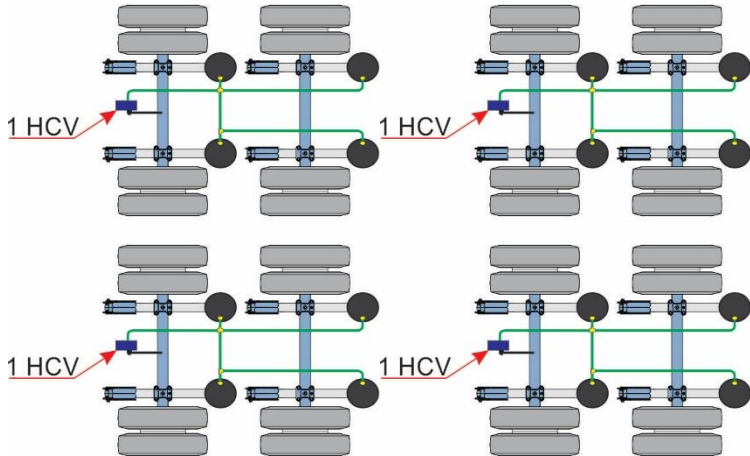

Installing and setting up the Right Weigh digital gauge involves four major steps.

1. Gauge installation and electrical connection: Mount the gauge into the vehicle's dash panel or other appropriate location within the vehicles cab.
2. Air line installation and routing: Install a new air line that runs from the air suspension axle group to the gauge mounting location.
3. Gauge configuration and feature set-up
4. Enter calibration values: Gather and enter empty and loaded weight values for each axle group being monitored.

2.0 Gauge Installation and Electrical Connection

The 202-DDG-04 digital dash gauge is designed to be panel mounted and can be installed in many different locations within the vehicles cabin.

Step 1:

Choose a location to mount the gauge.

Note: If you choose to mount the gauge in the dash panel, you will need at least 3 inches (76 mm) of clearance on the inside of the dash to allow for electrical and air line connections. Remove the dash panel and confirm the available space before proceeding. If needed, refer to the vehicle owner's manual or a qualified technician for detailed instructions on dash panel assembly for your vehicle.

Note: In some cases, the construction of the vehicles dash panel will not allow installation of aftermarket gauges. Therefore, the gauge must be mounted using an aftermarket gauge pod or bracket.

Location options:

- a) Any available factory 2-1/16" (52 mm) gauge hole.



- b) Remove and replace a factory installed drive axle air suspension pressure gauge.



- c) Cut a new hole in the dash panel using a 2-1/16" (52 mm) hole saw.

DO NOT cut into the dash panel without first checking behind it to ensure internal dash components will not be damaged!



d) Aftermarket gauge pod or bracket.

Use this option if the vehicles dash panel cannot accept aftermarket gauges.

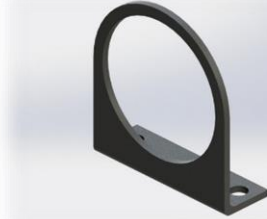

Step 2:

Insert the Right Weigh digital dash gauge into the mounting hole.

Hold the gauge in position so the display appears level on the dash panel or gauge pod/bracket.

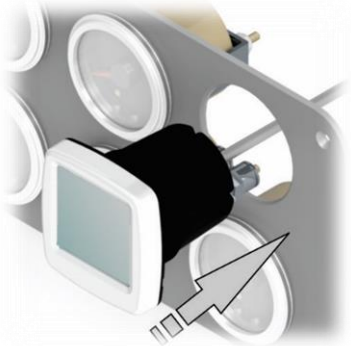

Note: The thickest portion of the gauge bezel indicates the bottom of the display face.



Step 3:

Screw the gauge nut onto the back of the gauge until it is tight, and firmly holds the gauge in position.

DO NOT OVER TIGHTEN!

This could cause problems with the display and touchscreen.

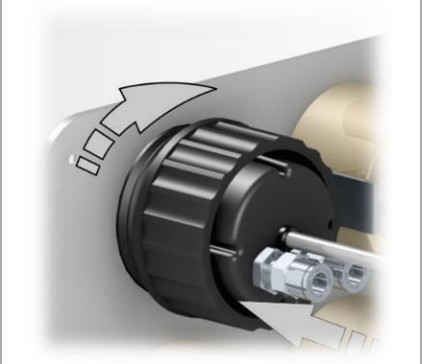

Step 4:

Locate a switched electrical power and ground circuit that is controlled by the ignition switch. Attach the **RED** wire to a positive (+) power source and the **BLACK** wire to a chassis ground (-) source.

Note: The required supply voltage must be between 9 VDC and 32 VDC.

DO NOT connect the gauge power to the headlight dimmer / dash light circuit.

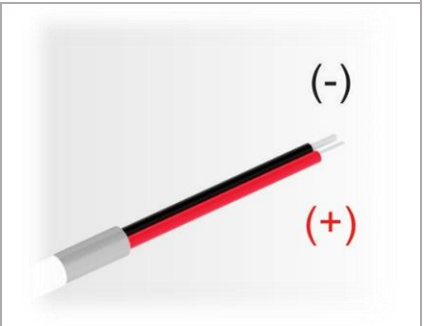

3.0 Air line Installation and Routing

An auxiliary air line must be installed to connect the gauge to one air spring from each axle group being monitored.

Note: An axle group that has two Height Control Valves (HCVs) will need two auxiliary air lines. One air line from one air spring connected to each HCV.

Note: For a list of required parts that are not included with the Right Weight digital gauge, please see Appendix A.

Step 1:

Insert a street tee fitting (not included) into the top of the most easily accessible air spring for each axle group.

Remember: An axle group with two HCVs will need two air lines; an air line from one of the air springs connected to each HCV.

Dump the air from the suspension system and remove the suspension air line and fitting.



Insert the street tee fitting into the top of the air spring and then reattach the suspension air line into the street tee.

Note: Fitting types and thread sizes will vary between vehicle makes and models. Make sure to use matching thread sizes. Additional fittings may be required.



Step 2:

Using approved fittings that match the thread size of the street tee, connect a ¼” air line (not included) to the street tee.

Note: Make sure the air line is long enough to reach the mounting location of the gauge.



Step 3:

Route the new air line up into the cab where the gauge is mounted.

Make sure to avoid sharp edges and engine components that could become hot.

Secure the air line with zip-ties along the way.

Note: When installing an air line on a trailer axle group, it is best to use a quick-disconnect fitting and coiled air line between the truck and trailer

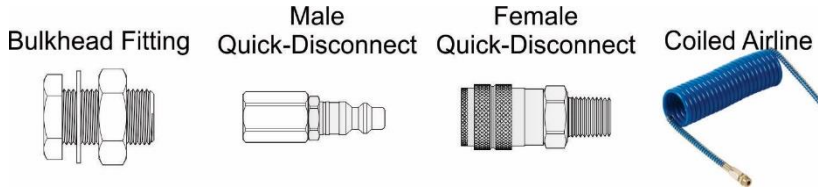

connection.

For a complete list of suggested parts needed, see Appendix B.

Step 4:

Label the gauge end of each air line with the name of the axle group it is connected to.

Note: You will have 4 air lines routed up to the gauge mounting location. It is very important that you label each air line so you know which suspension group it is connected to.



Step 5:

Insert the new air lines into the push-to-connect sensor fittings on the back of the gauge.

Example: If the air line marked "Axle Group 1" is attached to the drive axles and it is inserted into sensor fitting #1, then write down Sensor #1 = Drive Axles.

Note: If you have two air lines from one axle group with two height control valves, Those air lines **MUST** be inserted into sensor fittings 1 & 2, or into 3 & 4.



Step 6:

After all the air lines are connected to the sensor fittings, air-up the suspension systems and check all fitting connections for air leaks.

Step 7:

Installation is now complete. Carefully re-assemble the dash panel if needed.

The following diagram shows a basic air line schematic.

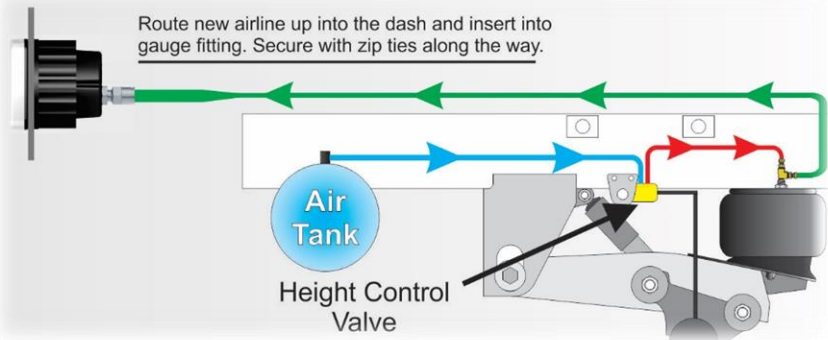

4.0 System Settings Overview

Before calibrating the gauge, it must be set-up and configured for its intended use. The following is a list of each of the settings and feature options. Review each one and configure the gauge as needed.

4.1 Change Air Sensor Configuration

The 202-DDG-04 gauge has four (4) internal air pressure sensors. In order for the gauge to provide the correct weight values for each axle group the air sensors must be configured correctly.

Note: This is especially important for any axle group that has two Height Control Valves (HCVs).

To change the air sensor configuration, follow these steps:

Step 1:

From the HOME screen, navigate to the “Sensor Mode” screen

Press  then select “Settings”.

Press  to advance the screen to “Sensor Mode”

Step 2:

If you have one axle group that has four HCVs, the air lines from that axle group should be averaged together. This will provide one weight value for the one axle group. In this rare case, set the radio button to “Average All”

If you have separate axle groups (more common), set the radio button to “User Config” and continue to step 3 below, otherwise, skip to section 4.2.

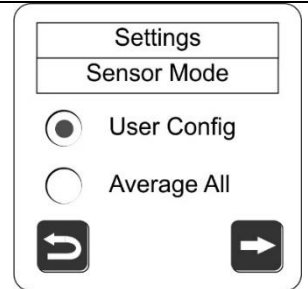



Step 3: Press  once, and select “Config Inputs”

Using the information written down during the air line installation and routing process, determine which air sensors should be averaged together and which ones should be independent from each other.

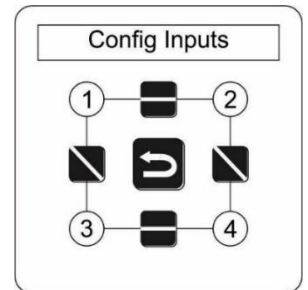
For example, if you have an axle group that has two HCVs, the air lines from that axle group should be averaged together. This will provide one weight value for the axle group.





 = Averaged. Two air lines connected with this symbol will be averaged together to provide one weight value for the axle group.

 = Independent. Two air lines connected with this symbol will provide an axle group weight for two separate axle groups that have one HCV each.

Press the button to switch between “Average” or “Independent”.

Step 4:

To confirm the air sensor configuration, press  once. To return to the HOME screen, press  once and  once.

4.2 Change Air Sensor Names

Once the air sensor configuration has been set (see 4.1 Change Air Sensor Configuration), you must confirm the name of each sensor (or pair of sensors) so the gauge will display the correct name for each axle group that is being monitored.

To confirm or change the air sensor names, follow these steps:

Step 1:

From the HOME screen, navigate to the “Config Names”.

Press  then select “Settings”.

Press  twice to advance the screen until “Config Names” appears.

Select “Config Names”.





The “Config Names” screen will display each sensor and its corresponding name in the form of a button.

Step 2:

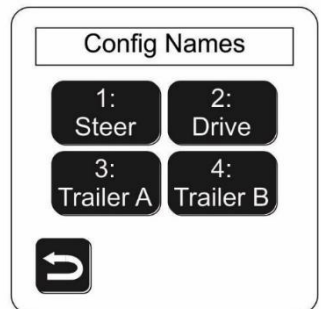
Press one of the available buttons to change the air sensor name.

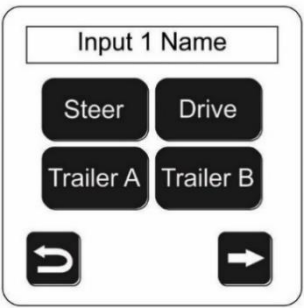

Note: If any air sensors are configured to be “Averaged” together, then only one button will appear for those air sensors. If all the air sensors are configured to be “Independent” from each other, then there will be a button for each air sensor.





<p>Step 3: Select an appropriate name from the list of options.</p> <p>Press  for more options.</p>	
<p>Step 4: To confirm and select another air sensor to rename, press  once. Then repeat steps 2 and 3.</p>	
<p>Step 5: To confirm and return to the HOME screen, press  twice and  once.</p>	

4.3 Enable Estimated Steer Axle

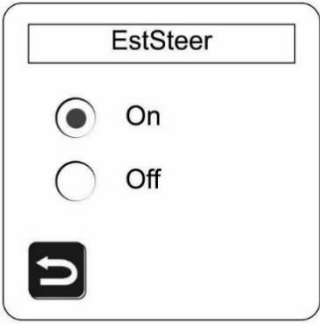

The Estimated Steer feature will estimate the steer axle weight based on the drive axle weight. To enable the estimated steer axle feature, at least one of the air sensors must be connected to the vehicles drive axle suspension and that sensor must be named “Drive”. Please refer to sections 4.1 Change Air Sensor Configuration and 4.2 Change Air Sensor Names to set up and configure the air sensor inputs and names.

<p>To turn on the Estimated Steer axle weight feature, follow these screen steps:</p>
<p>Step 1: From the HOME screen, navigate to the “Est. Steer” screen.</p> <p>Press  then select “Settings”</p> <p>Press  twice then select “Est.Steer”.</p>

<p>Step 2: On the Est. Steer screen, press the “On” indicator.</p> <p>Note: If one of the air sensors has been named “Steer” you will not be able to turn the Estimated Steer feature on.</p>	
<p>Step 3: To confirm and return to the HOME screen, press  twice and  once.</p>	

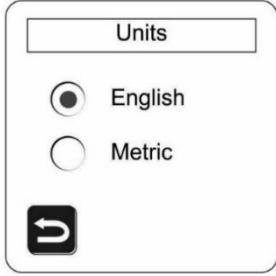

4.4 Change Units (LBS or KG)

By default, the gauge will be set to display weight in pounds (LBS). To change the system units, follow these screen steps:

<p>Step 1: From the HOME screen, navigate to the “Units” screen.</p> <p>Press  then select “Settings”.</p>	
<p>Step 2: Select “Units”, then select “English” for LBS or “Metric” for KG.</p>	
<p>Step 3: To confirm and return to the HOME screen, press the  twice and  once.</p>	

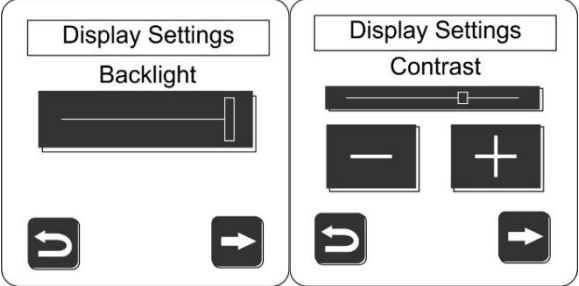

4.5 Adjust Backlight and Screen Contrast

To adjust the backlight brightness and/or the screen contrast, follow these steps:

<p>Step 1: From the HOME screen, navigate to the “Display Settings” screen. Press  then select “Settings”. Press “Display Settings”.</p>	
<p>Step 2: Press the right arrow to toggle between brightness and contrast screens. Use the slider for the backlight, and +/- buttons for contrast.</p>	
<p>Step 3:</p>	<p>To confirm and return to the HOME screen, press the  twice and  once.</p>

4.6 Set Calibration Security PIN Code (Optional)

To protect calibration data from unwanted changes, you can set a security PIN code. This code will be required in order to get into the Calibration screens. To set a PIN code, follow these steps:

<p>Step 1: From the Home screen, navigate to the “Set PIN” screen. Press  then select “Calibration”. Press  until the “Set PIN” option appears. Select “Set PIN”.</p>

Step 2:

Then enter a unique PIN code (up to six digits)

Note: If a PIN code is forgotten or lost, you will need to contact Right Weigh support for instruction to reset the PIN code. (See section 8.0 Additional Support for contact details.)

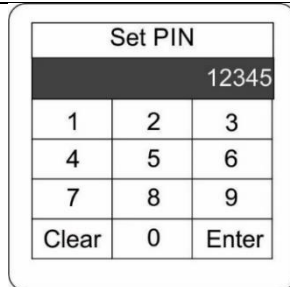





Step 3: Press “Enter” to confirm. Press  twice and  once to return to the HOME screen.

4.7 Reset Calibration Data to Factory Default Values

In a few rare cases, it might be necessary to reset the calibration data back to the original factory default values.

To reset the calibration data to the default values, follow these steps:

From the Home screen, press  then select “Calibration”. Enter the PIN code if required. Press  until the “Reset Cal Data” option appears. Select “Reset Cal Data”. Press “YES” to confirm or “NO” to cancel, then press  twice and  once to return to the HOME screen.

5.0 Calibration Overview

To correctly calibrate the Right Weigh digital scale, you will need to enter both an empty weight and a maximum legal loaded weight value for each axle group being monitored. It does not matter which values you enter first (empty or loaded). However, when a calibration value is entered the gauge will associate that value with the current air pressure in the suspension system at that moment. Therefore, it is required that the empty values are entered into the gauge when the vehicle is empty, and the loaded weight values are entered when the vehicle is loaded.

Note: When using the Estimated Steer feature, make sure the 5th wheel is in an ideal position to maximize weight distribution between the drive axle(s) and steer axle. Find that position and mark it before entering calibration data for the steer axle. The estimated weight for the steer axle will be reasonably accurate only when the 5th wheel is in the marked location.

5.1 Gather and Enter Calibration Data

Use the following steps to gather and enter the empty or loaded axle group calibration weight values.

Note: For best results, make sure the vehicle is full of fuel during the calibration process.

Step 1:
Using a certified in-ground scale, obtain a weight value for each axle group attached to the Right Weigh load scale. If the estimated steer axle feature is on, get a separate weight value for the steer axle as well.
Step 2:
Park on a level surface. Shift the transmission to neutral and set the parking brakes. If you can stay on the in-ground scale, that is ideal.
Step 3:
Chock the wheels to prevent unexpected vehicle movement, then release the parking brakes.
Step 4:
Make sure the Height Control Valve (HCV) has fully inflated the air bags. If needed, briefly dump the air from the suspension and allow the HCV to refill the system. (This may take several minutes depending on the type of HCV.)

Step 5:

From the “Home” screen, press  then select “Calibration”. If required, enter the PIN code and press “Enter”.

Step 6:

Select the first axle group.

Step 7:

Press the “Empty” or “Loaded” button depending on which value you are entering. You will be asked if you want to enter new calibration data. Press “YES” to continue.



Step 8:

Using the keypad displayed, enter the certified weight for the axle group and press “Enter”. You will be asked to confirm the weight. If correct, press “YES” to continue.

Step 9:

Repeat steps 6 to 8 to enter weight values for the other axle groups.

Step 10:

After you have entered the calibration data for each axle group, press the  button once and the  button once to return to the HOME screen.

6.0 Operating and Weighing Instructions

In order for the 202-DDG-04 digital gauge to provide the most accurate weight values, you must take care to position the vehicle correctly. For best results, follow these steps.

Step 1:

Park on a level surface. Shift the transmission to neutral and set the parking brakes.

Step 2:

Chock the wheels to prevent unexpected vehicle movement, then release the parking brakes.

Step 3:

Make sure the Height Control Valve (HCV) has fully inflated the air bags. If needed, briefly dump the air from the suspension and allow the HCV to refill the system. (This may take several minutes depending on the type of HCV.)

Step 4:

From the HOME screen, press the  button to view the suspension weight values.

Note: You can select different screen views by pressing the  button.

The “Net” weight screen allows you to save a zero point of the total weight of the scale. This can be useful to track how much your total monitored axles have changed since you last pressed “Zero”

Pressing “Zero” does not affect calibration, and can be pressed anytime. When the gauge is capturing the entire truck (est. steer, drive, and trailer), this feature can be used to gauge the weight of your product.

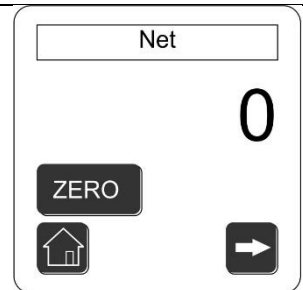

Step 5: Press the  button to return to the HOME screen.

7.0 Troubleshooting

Erratic or inaccurate readings could result from the following:

- 1) The vehicle is NOT parked on a level surface; parking on a sloped or banked surface will cause the vehicle weight distribution to shift between the axle groups.
- 2) The vehicle's brakes are on; when the vehicle brakes are set they could apply additional pressure or torque on the suspension air bags. This will cause the suspension to have a different air pressure than what is actually needed to hold up the given weight.
- 3) The vehicle is parked on an uneven or rough surface: If one or more of the vehicle's wheels are in a pothole, that could result in additional pressure or torque on the suspension air bags. This will cause the suspension to have a different air pressure than what is actually needed to hold up the given weight.
- 4) The height control valve (HCV) is malfunctioning and/or broken: if the HCV is not functioning correctly, then the air pressure applied to the suspension system could be inconsistent and/or erratic. To test for a HCV problem, follow steps 1 to 5 of the operating instructions (the vehicle should be loaded). Write down the weight reading from the load scale. Then, drive the vehicle around the block and return to the same location. Follow steps 1 to 5 of the operating instructions again to get a second reading for the load scale. If the two readings are significantly different than the HCV might be malfunctioning and/or broken.
- 5) There is a significant air leak in the suspension system: if there is an air leak within the suspension system, this could cause the HCV to refill the suspension at regular intervals to maintain the vehicle's ride height. If there is a significant leak, the gauge display will slowly decrease in value and then quickly increase in value when the HCV refills the suspension system.
- 6) The buttons on the touchscreen do not work: if the buttons on the touchscreen become inactive, or difficult to use, you will need to re-calibrate the touchscreen. To do this, follow these steps: 1) Turn the vehicle off. 2) Press your finger on the face of the touchscreen and hold it there. 3) Turn the vehicle back on. 4) Follow the screen prompts to re-calibrate the touch-panel. For best results, use a rubber eraser from a standard pencil.

Appendix A

The following is a list of additional parts needed for air line installation. This list is just a suggestion and may not be all the parts needed for your specific vehicle. Check with your Right Weigh dealer for optional installation kits.

1. Approximately 20 to 30 feet (6 to 9 meters) or more of 1/4" tubing.
2. Street Tee fittings. The thread size should match the air bag fittings. (1/4" NPT or 3/8 inch NPT)
3. Male Straight Air line fittings for 1/4" tubing, with a thread size to match the Street Tee fittings.
4. 10 or more zip ties.

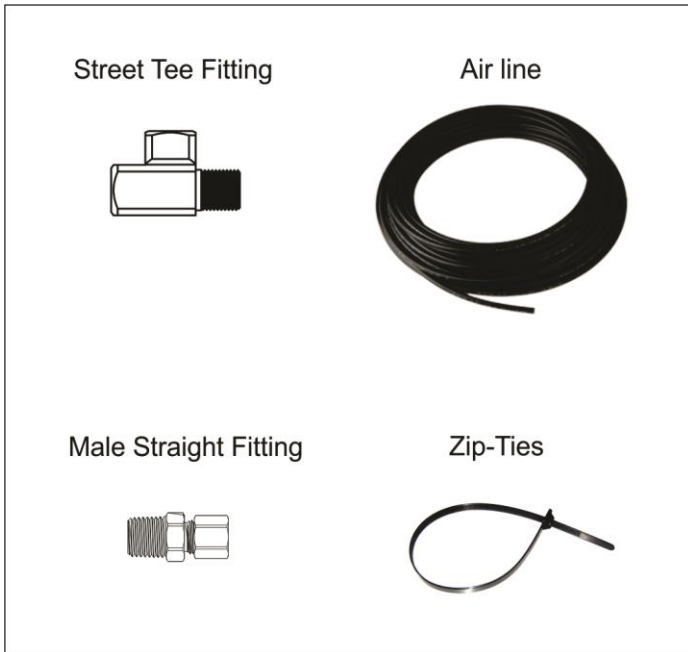

Appendix B

The following is a list of additional parts needed for air line installation when connecting from a trailer to a truck. This list is just a suggestion and may not be all the parts needed for your specific vehicle. Check with your Right Weigh dealer for optional installation kits.

- 1) Approximately 120 feet (36 meters) of 1/4 inch tubing.
- 2) Two Street Tee fittings. The thread size should match the air bag fittings.
- 3) Four Male Straight Air line fittings for 1/4 inch tubing, with a thread size to match the Street Tee fittings.
- 4) Two Bulkhead fittings.
- 5) Male and Female quick-disconnect coupling.
- 6) 20 foot (9 meter) coiled tubing with a matching male quick-disconnect coupling.
- 7) 50 or more zip ties.

