



Time Tested • Time Proven

Falcon 2 & BlackHawk
replacement Autowlok button assembly

part number 910003-80

Installation Instructions

Note: to replace an Autowlok button only, it is not necessary to disassemble the tow bar. See "To replace an Autowlok button" on page three.

To replace an entire Autowlok assembly...

1. First remove the 1-1/8" bolt and nut (Figure 1) which connects the two tow bar arms. Note the location of each of the four white bushings for reassembly.
2. Work on one tow bar arm at a time. At the end of one of the outer arms (Figure 1), remove the square black dust cap (Figure 1).
3. Unbolt the shoulder bolt (Figures 1 and 2) and remove the collar (Figure 2). Save the two white bushings (between the collar nut and the collar ears) for reassembly.

Next, unscrew the collar nut (Figures 1 and 2) from the end of the inner arm and remove it.

4. Hold a piece of cloth over the end of the outer arm that was covered by the square black dust cap. Press the Autowlok button (Figure 2) down and push the inner arm (Figure 2) out, through the end of the outer tubing that was covered by the square black dust cap.



CAUTION

The spring inside the Autowlok assembly is under pressure. It will eject a pin when the spring and pin clear the outer arm, and the pressure is released.

To avoid injury, hold a cloth over the end of the outer arm and stand to one side, clear of the pin and spring, as the Autowlok assembly clears the outer arm.

Push the inner arm completely out.

5. Clean the interior of the outer arm with a water-soluble cleaner such as Voom RV (part number 9911) – spray a liberal amount of cleaner inside the arm, then push a piece of cloth through the other side. Repeat, if necessary, until the interior of the outer arm is clean.

CAUTION

Do not use petroleum-based products to clean the tow bar. Petroleum will attract dirt and dust, which will impede the operation of the inner arms and/or other components. Certain petroleum products may also corrode non-metallic components.

6. Rinse the interior of the outer arm to remove all of the cleaner, then dry the interior of the outer arm completely, by repeatedly pushing a piece of cloth through the interior of the outer arm.

7. Now, fit one of the included flat white bushings (Figure 3) onto the raised lip at the end of the inner arm (Figure 3). Then, test the fit – slide the inner arm into the outer arm.

Note: if the flat white bushing is too wide to fit, use a grinder to trim a small amount from the edges touching the inside of the outer arm. Trim an equal amount from each side, test-fit the inner arm and trim more, if necessary, until the inner arm slides in and out easily.

continued on next page

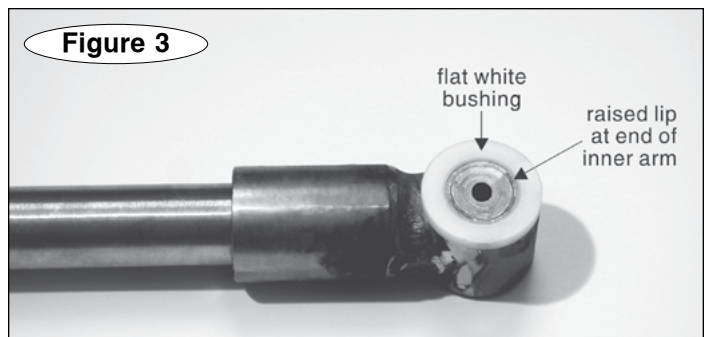
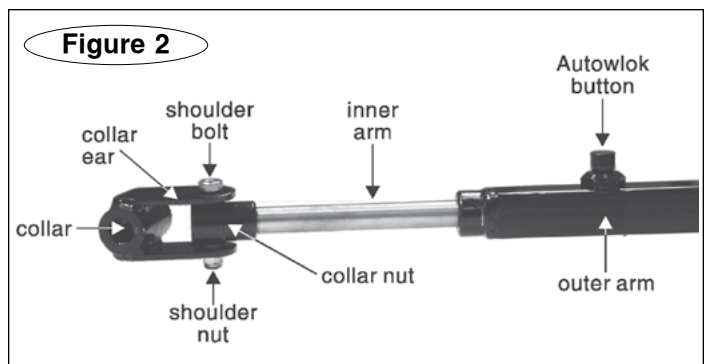
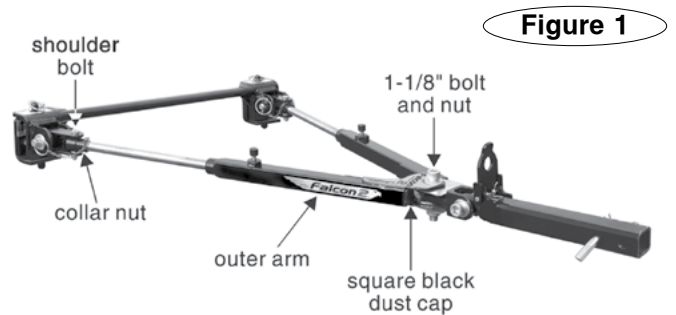

continued from preceding page

8. If the button stem (Figure 4) will not be replaced, proceed to step 9.

If the button stem will be replaced – first, with the old pin and spring (Figure 4) removed, insert the button stem flat side up (Figure 5) into the opening at the end of the inner arm opposite the flat white bushing (Figure 5).

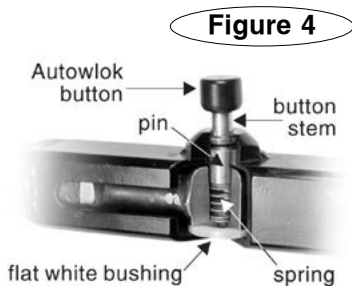

Then, slide the inner arm into the outer arm until the top of the button stem is visible through the hole in the outer arm.

Turn the tow bar arm over and move the inner arm forward or backward slightly, if necessary, until the button stem drops through the hole in the outer arm. Then, draw a straight line with a pencil across the bottom of the inner arm (Figure 6), 3/4" from the edge of the outer arm.

Slowly close the inner arm until the edge of the outer arm is even with the pencil line you drew. This position will stabilize and support the button stem.

Turn the tow bar arm back over and attach the Autowlok button to the button stem, following steps 6 through 8 under "To replace an Autowlok button..." on page three.

After the button has been attached, slide the inner arm out.

9. Replace the spring and pin (Figure 4) – insert one of the supplied springs into the opening at the end of the inner arm opposite the flat white bushing.

Then, lubricate the flat side of one of the pins thoroughly. Use a dry silicone aerosol, such as LubeMaster (part number 747). Next, insert the pin into the hole at the end of the inner arm, so that the rounded end of the pin faces up (Figure 7).

CAUTION

Do not use petroleum-based products to lubricate the tow bar. Petroleum will attract dirt and dust, which will impede the operation of the sliding inner arms and/or other components. Certain petroleum products may also corrode non-metallic components.

Figure 4 shows the flat white bushing, spring and pin correctly positioned below the Autowlok button and button stem.

10. Insert the inner arm back into the outer arm. When the inner arm is fully inserted, the Autowlok button will snap into the locked position.

11. Screw the collar nut back onto the inner arm, until the curved radius at the end of the inner arm (Figure 8) aligns to the hole through the collar nut.

Test-fit the shoulder bolt. If the collar nut is overtightened, the shoulder bolt will not fit through. If this is the case, loosen the collar nut just enough to allow the should-

er bolt to be fully inserted through the collar nut.

WARNING

Screw the collar nut back as far as it can go on the inner arm, while still allowing the shoulder bolt to fit through. If the collar nut is not threaded back to this point, towing vibrations will unthread the collar nut, and the tow bar arm will separate.

If the tow bar arm separates, the towed vehicle will
continued on next page

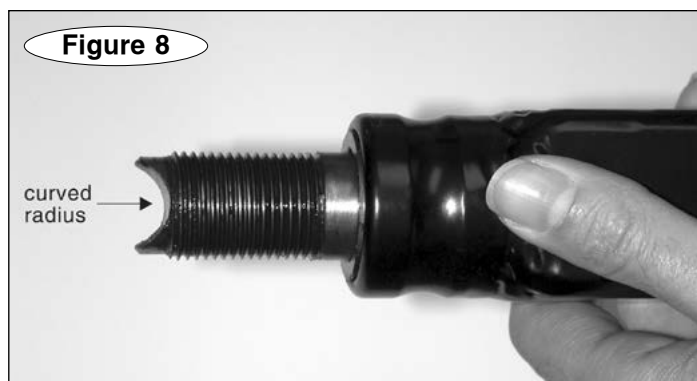
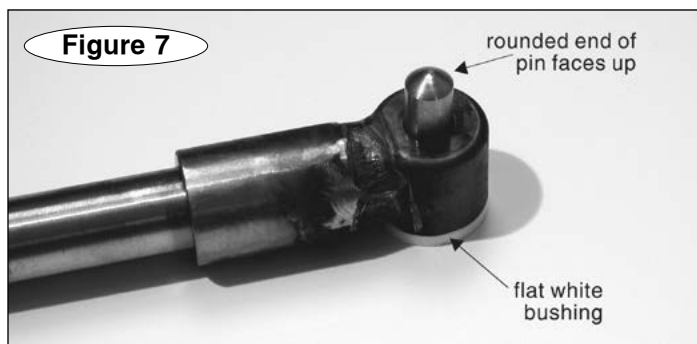
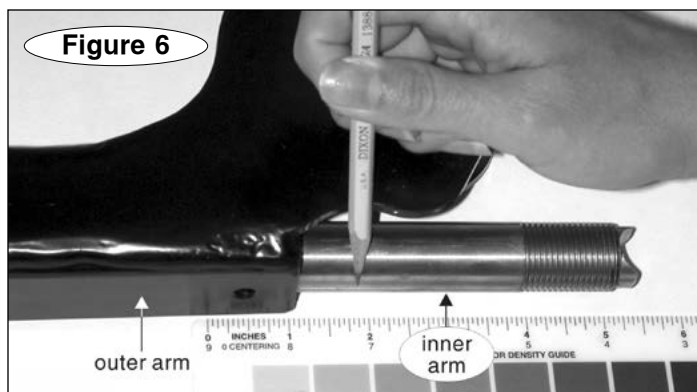
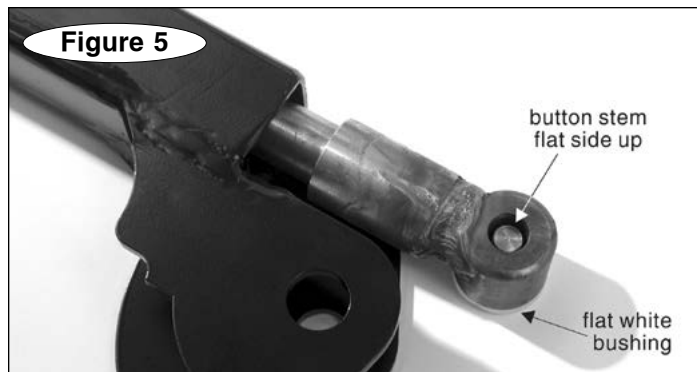

continued from preceding page

not be held in place, which may cause a loss of vehicular control, a traffic accident or loss of the towed vehicle, resulting in property damage, personal injury or even death.

12. Now, remove the shoulder bolt and position the collar ears (Figure 2) over the collar nut. Position the white bushings between the collar ears and collar nut, then bolt the collar ears back into place with the shoulder bolt.

Note: over-tightening the shoulder bolt will bind the collar and prevent it from pivoting properly. When it is tightened correctly, the collar should pivot easily.

Re-attach the square black dust cap.

13. Replace the Autowlok assembly on the other arm, if necessary, by repeating steps 2 through 12 above.

14. Re-attach both tow bar arms with the 1-1/8" bolt and nut (and the four white bushings) you removed in step 1.



WARNING

Use all mounting hardware and kit components necessary to replace the bushing(s) and Autowlok components, and re-assemble the tow bar as described above.

Failure to use all kit components, or to reassemble the tow bar correctly, may cause the tow bar to fail, which may cause a loss of vehicular control, a traffic accident or loss of the towed vehicle, resulting in property damage, personal injury or even death.

To replace an Autowlok button...

1. It is not necessary to disassemble the tow bar to replace an Autowlok button.

First, open the tow bar and extend both arms until the buttons on both arms snap into the locked position.

Note: if the button is missing, it will be necessary to lift the button stem (Figure 4) up slightly as you extend the arm, so that the button stem will clear the inner arm weldment and inner arm bushing.

2. Set the tow bar stinger on any object that will allow the tow bar arms to rest at a convenient height to work on the button.

3. With the arms fully extended and locked, draw a straight line with a pencil across the top of the inner arm (Figure 9), 3/4" from the edge of the black outer arm (Figure 9).

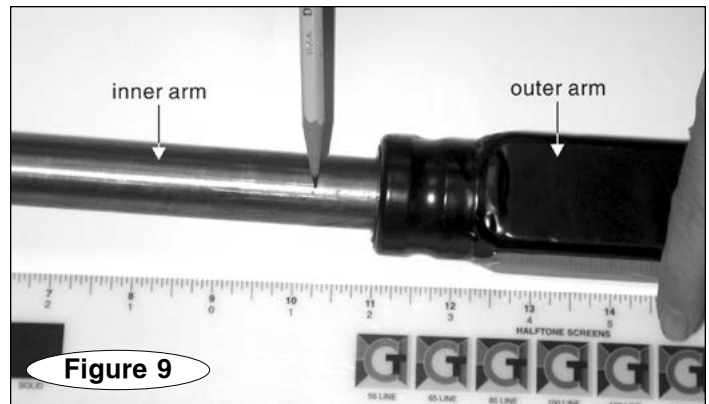

4. Depress the button (or the button stem, if the button is missing) and slowly close the arm until the edge of the outer arm is even with the pencil line you drew in the previous step.

This position will stabilize and support the button stem so that the new button can be properly attached.

5. Remove the old button (if present) with pliers or channel locks, being careful not to scratch the button stem.

6. Clean any residue that may be on the exposed surface of the button stem.

Note: for easier attachment to the button stem (step 7, below), drop the Autowlok button in boiling water for five minutes. The heat will make the button more flexible.

If you choose this method, dry the button completely before applying the glue.

7. Follow the instructions on the supplied package of epoxy glue to mix and activate the glue, then apply enough to lightly cover the inside of the button. Next, apply enough glue to completely fill the grooves at the top of the button stem.

Within 30 seconds, position the button over the top of the button stem, and tap the button down over the button stem, as far as it can go, with a rubber mallet.

CAUTION

Ensure that the button is tapped completely down, as far as it can go. If the button is not completely down, it will not depress the pin and spring far enough to lock or unlock the tow bar arm.

8. Allow 24 hours for the epoxy glue to set. The button can be depressed and released after approximately 10 minutes, but do not pull on the button for 24 hours.