



**2219 Honda Ridgeline 2017-Present**

**2219 Honda Pilot 2016+ / Acura MDX 2014+**

Installation Instructions



60 Minutes

# 2219 Honda Ridgeline 2017 - Present

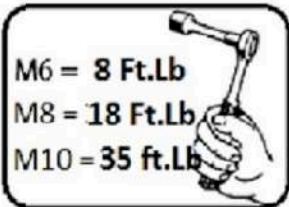
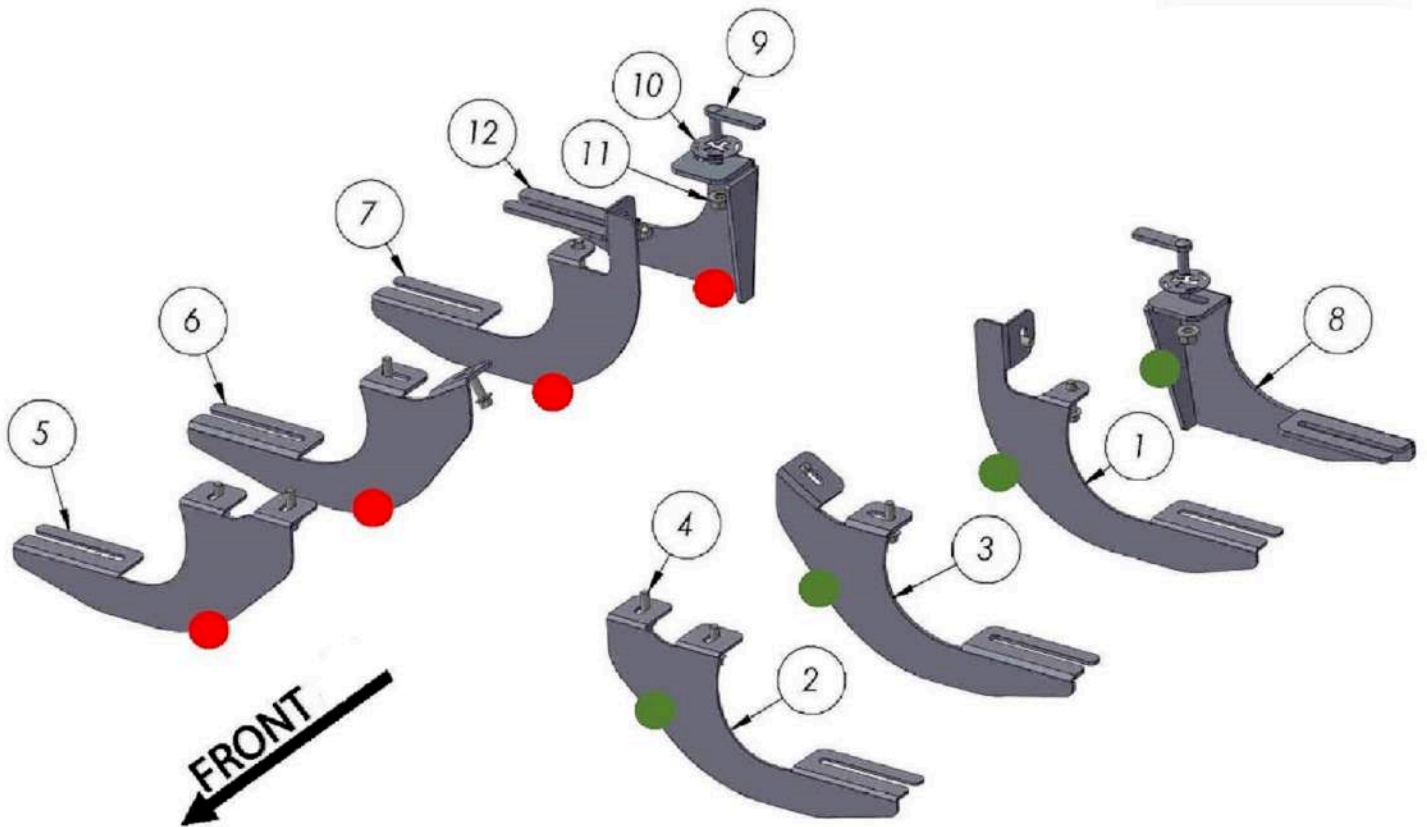

ITEM/NO	PART NAME	QTY
1	THIRTH BRACKET DRIVER	1
2	FIRST BRACKET DRIVER	1
3	SECOND BRACKET DRIVER	1
4	DIN 6921 FLANGE BOLT - M8 x 30	12
5	FIRST BRACKET PASSENGER	1
6	SECOND BRACKET PASSENGER	1
7	THIRTH BRACKET PASSENGER	1
8	FOURTH BRACKET DRIVER	1
9	HTC 243 - M10X30 (5X15X60)	2
10	HTC 269 - CLIPS (M10)	2
11	DIN 6923 FLANGE NUT - M10	2
12	FOURTH BRACKET PASSENGER	1

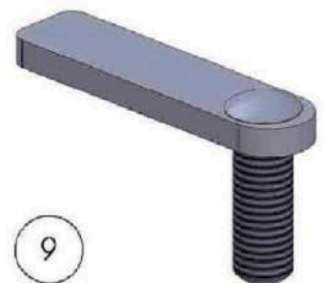

9



10

# 2219 Honda Pilot 2016+ / Acura MDX 2014+

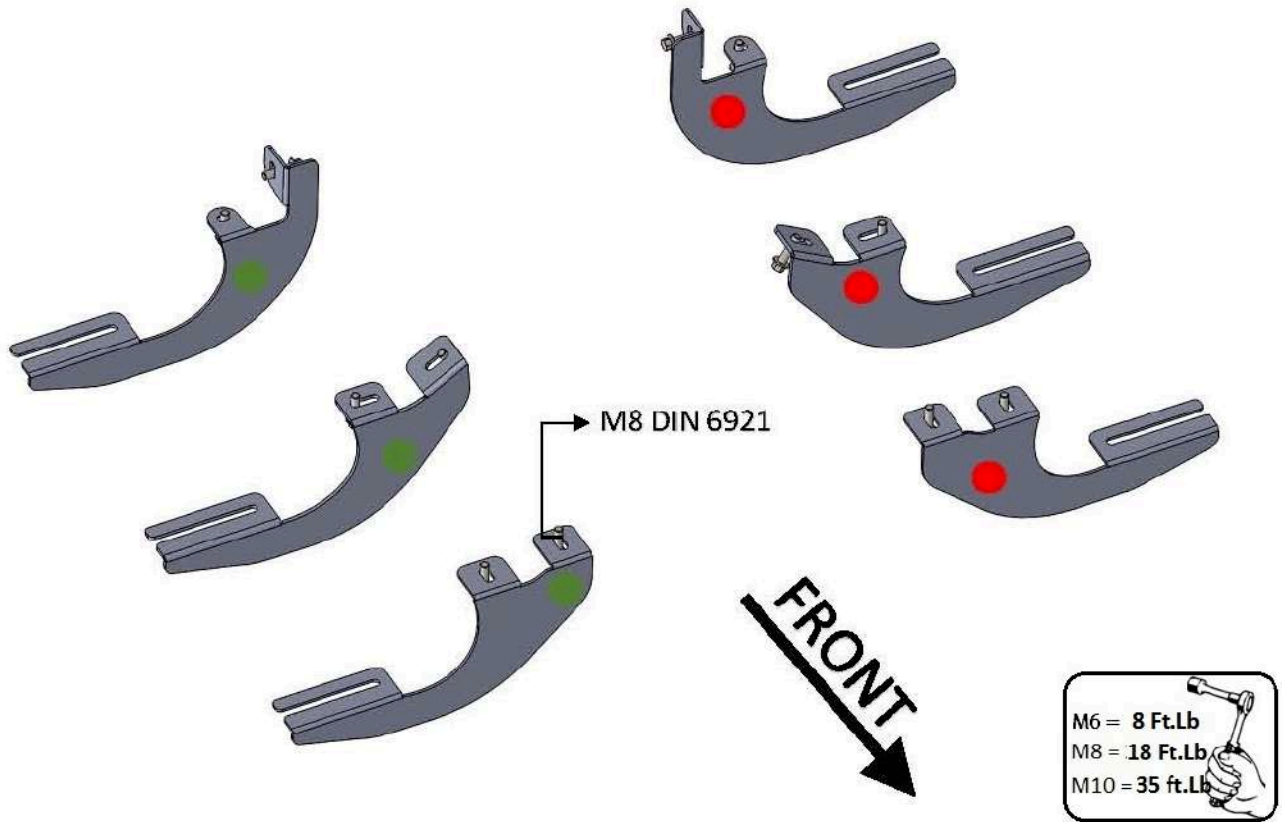

## HARDWARE

12



M8x30  
FLANGE

**WARNING:** Use of powertools will void warranty.

## BRACKETS



(x2)

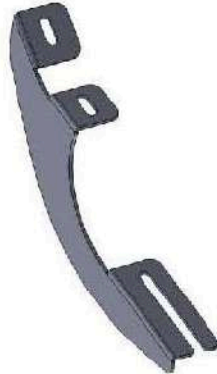

(x2)



(x2)

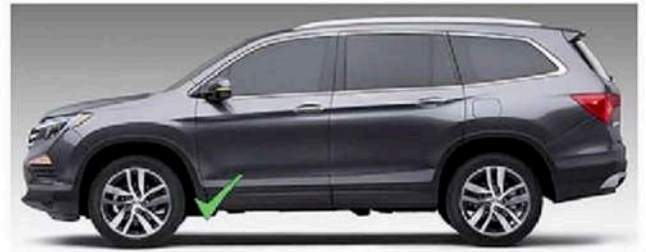

**WARNING:** Use of powertools will void warranty

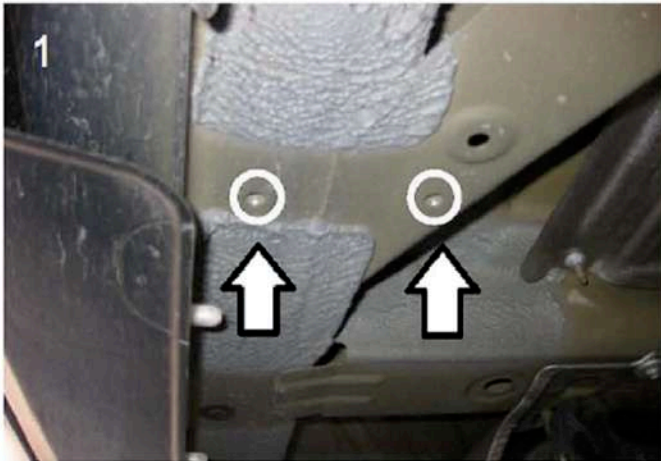

- 1) Locate front bracket mounting area image #1
- 2) Install front bracket with supplied M8 hardware, do not tighten
- 3) Proceed to middle bracket

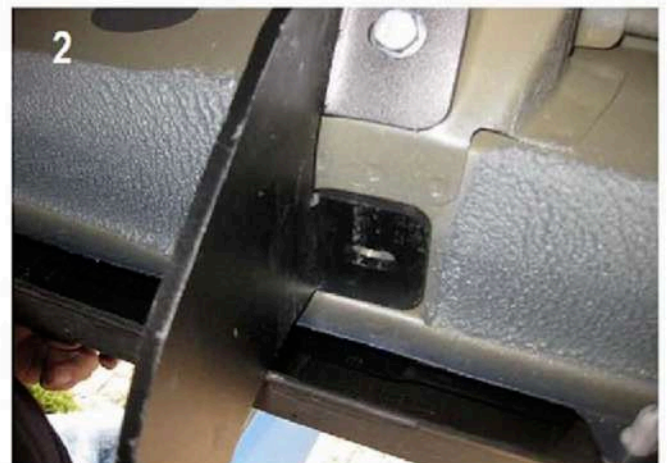
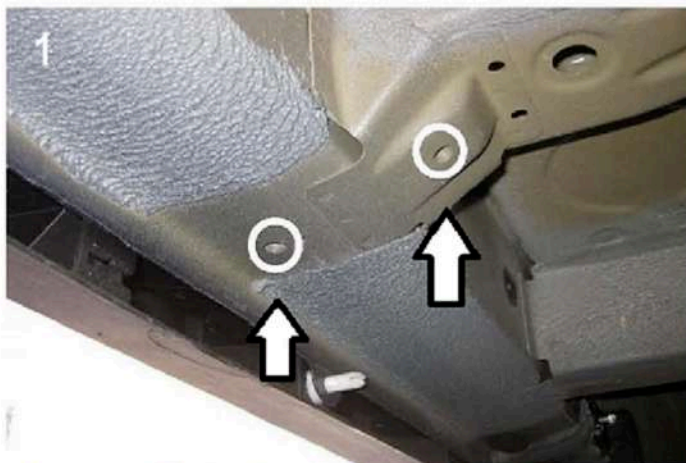
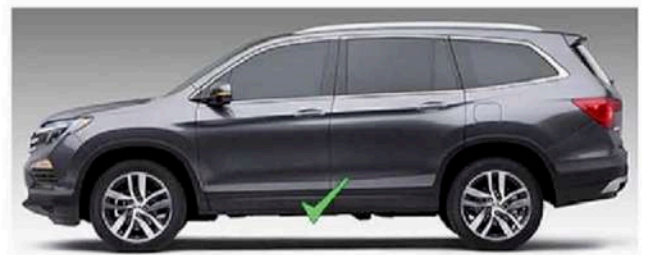

- 1) Locate middle bracket mounting area Image #1
- 2) Install middle bracket with supplied M8 hardware, do not tighten
- 3) Proceed to next bracket

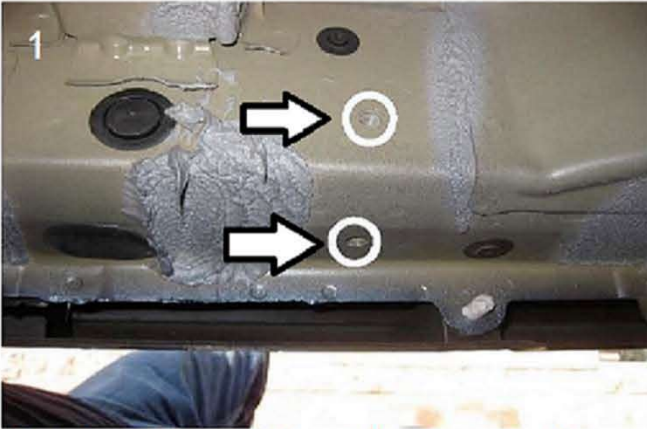
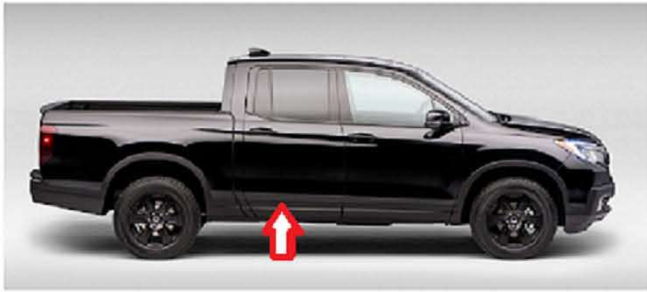

- 1) Locate rear bracket (3rd) mounting area image #1
- 2) Install rear (3rd) bracket with supplied M8 hardware, do not tighten
- 3) Proceed to last bracket



### Final Step for Ridgeline only

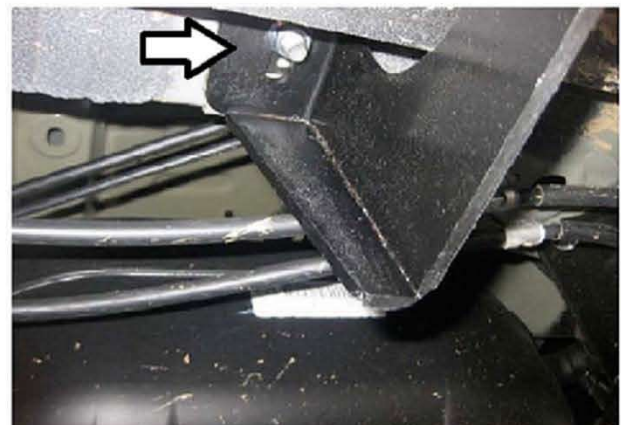

- 1) Locate rear bracket mounting area image #1
- 2) Remove factory rubber plug as shown on image #1
- 3) Insert HTC 243 with HTC 269
- 4) Install rear bracket with supplied M10 hardware, do not tighten
- 5) Loosen M8 hardware on back of steps
- 6) Proceed to tighten bracket hardware M8 to 18 ft lbs and M10 to 35 ft lbs
- 7) Proceed to tighten step hardware M8 to 18 ft lbs
- 8) Repeat procedure on opposite side

**WARNING: Use of power tools will void warranty**

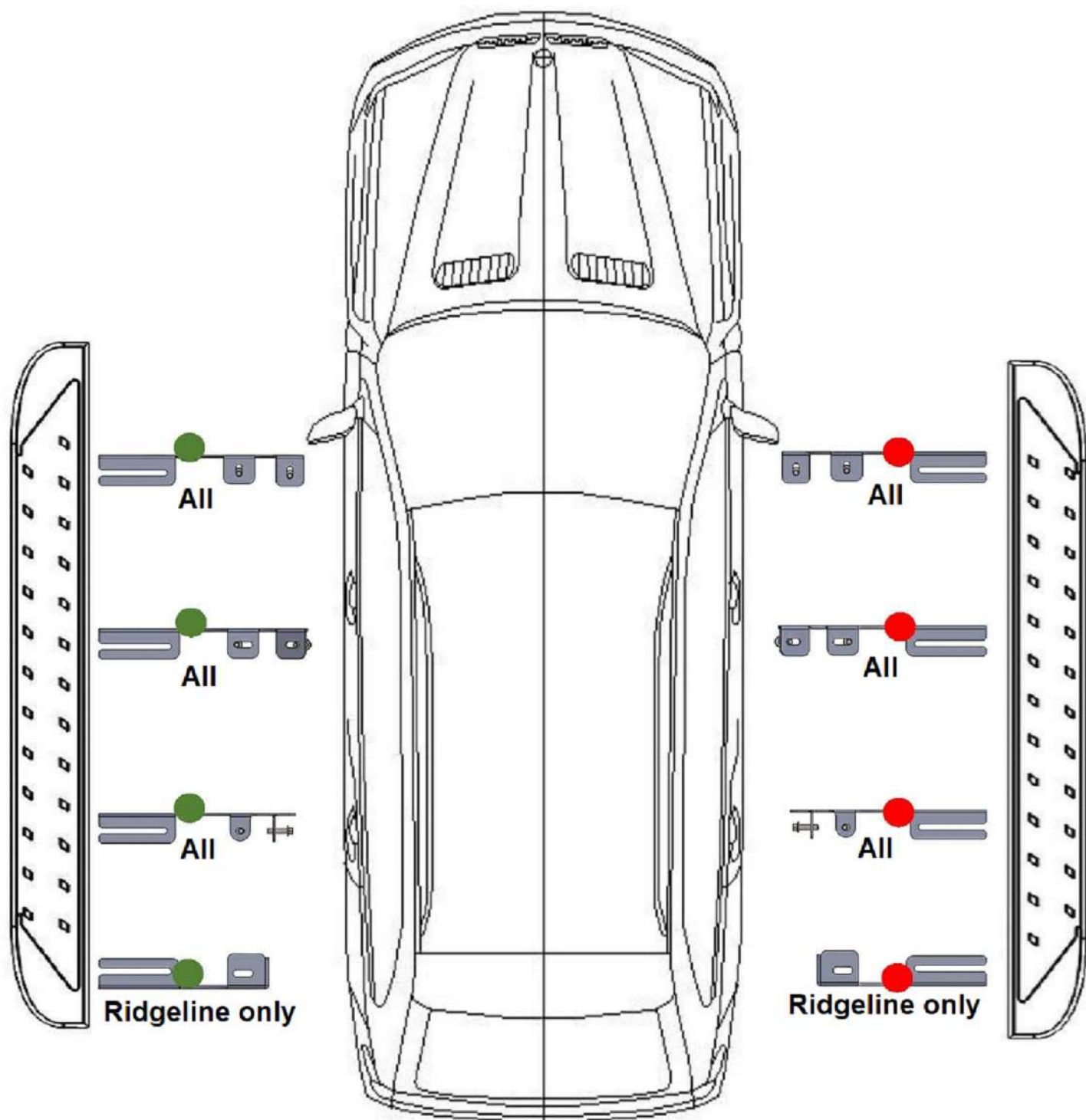

ATTENTION PLEASE! : DO NOT TIGHTEN ALL OF THE SCREWS UNTIL ALL OF THE PARTS ARE INSTALLED.

Keep your Romik accesories clean. To prevent corrision and to maintain your high quality finish, wax or polish regularly with quality stainless polish. Use a non abrasive type automotive wax. Any use of abrasive soaps, polishes or waxes can be detrimental to the finish.

Learn more about running boards and step bars we have.