

# WHEEL ALIGNMENT

INSTRUCTIONS AND INFORMATION

---

---

CAT. NO. 66000  
MAGNETIC CASTER/CAMBER  
GAGE

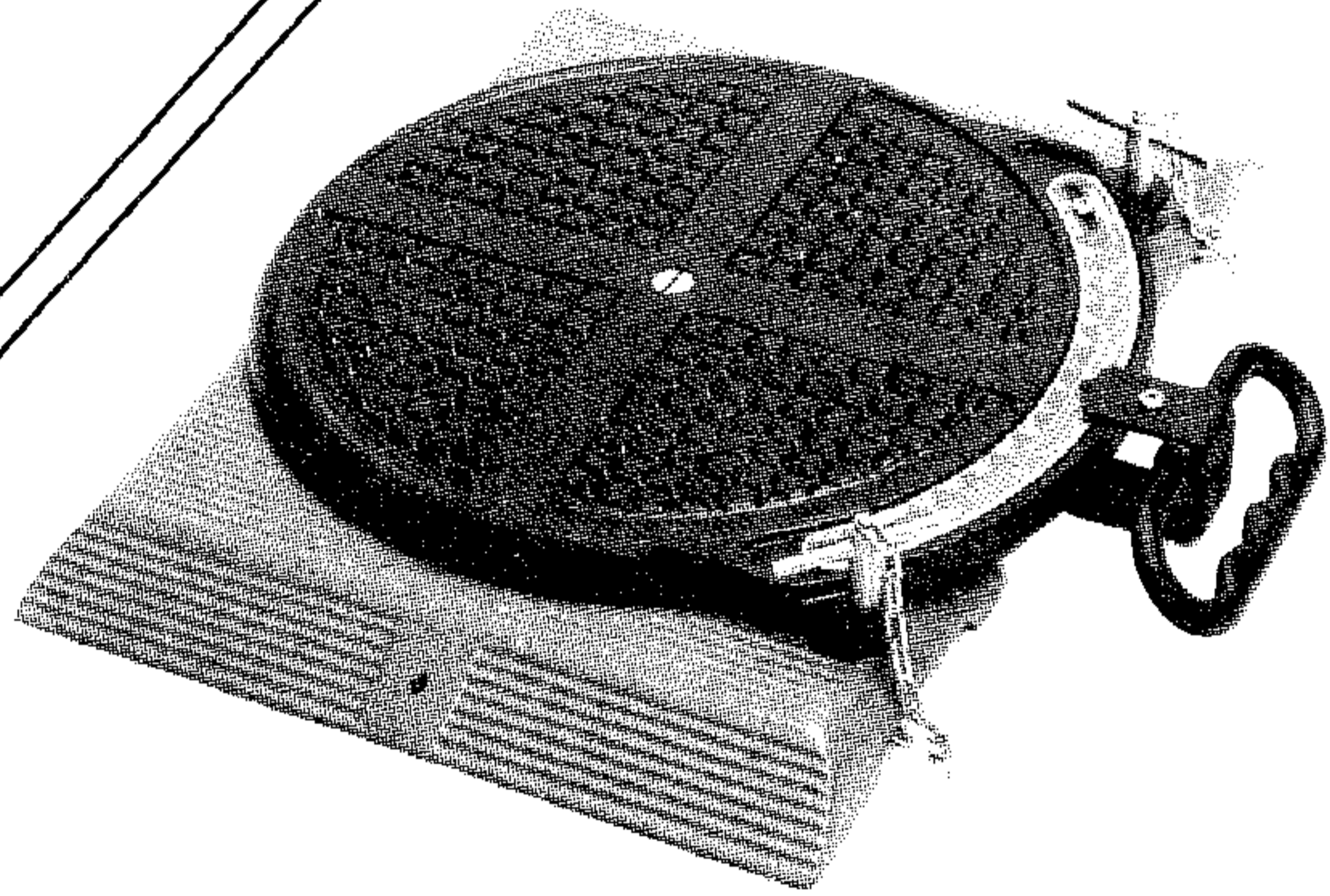
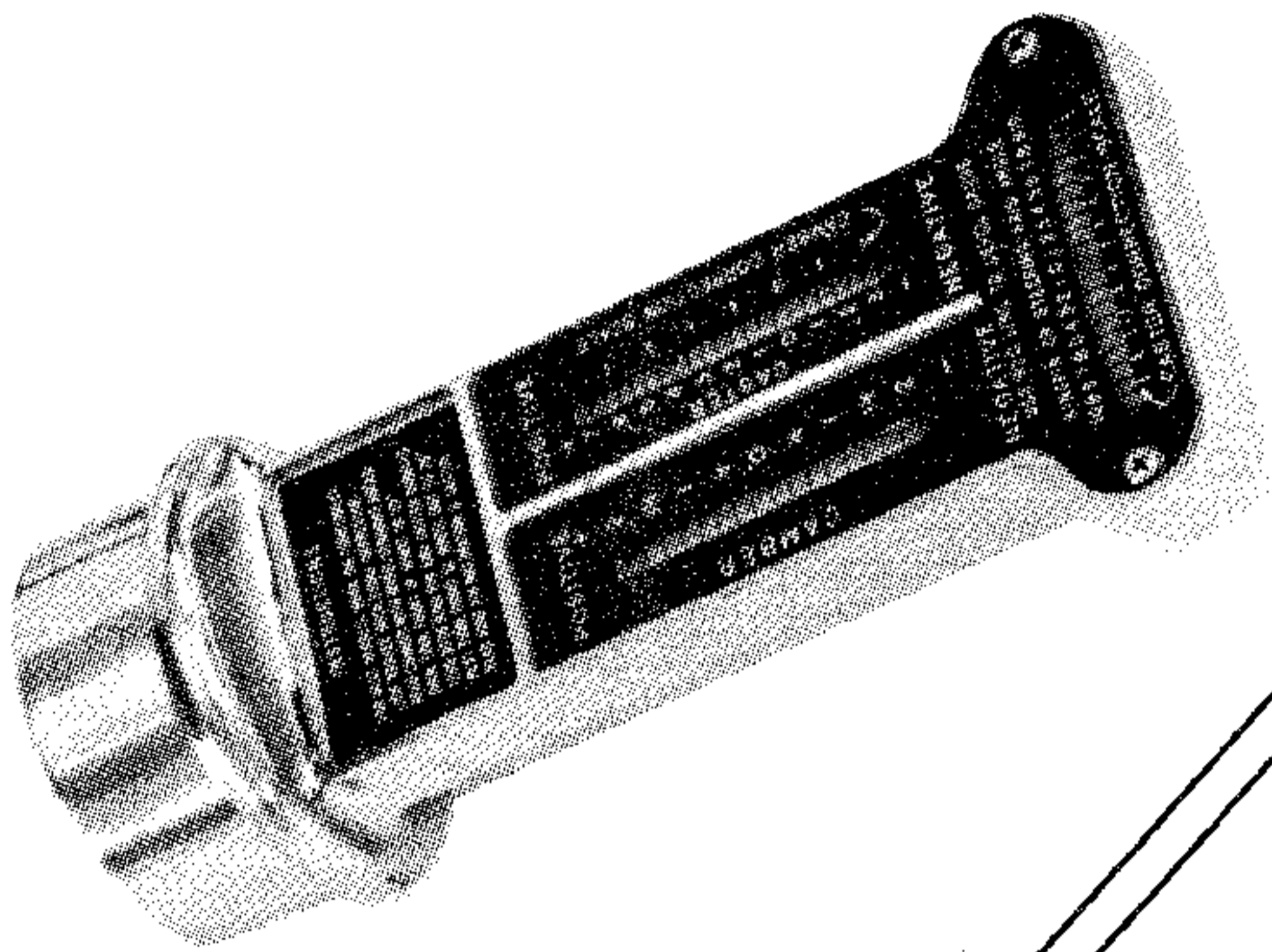

CAT. NO. 66200  
WHEEL ALIGNMENT  
TURNTABLES

---

---

Patented under one or more of the following patents:  
2,124,902 - 2,434,205 - 2,729,896



**S & G TOOL AID CORP.**

## WHEEL ALIGNMENT TIPS

### DRIVER'S COMPLAINT

**Hard Steering**

### INVESTIGATE FOR

Low or uneven tire pressure; unmatched tires; steering gear or connections adjusted too tight; insufficient or incorrect lubricant; sagging or broken springs; unequal camber; too much caster; bent suspension arm; bent steering arm; bent or broken frame

---

**Loose Steering**

Loose or worn front wheel bearings; looseness or wear in steering gear, kingpins, pivots, steering arms, drag link arm or pitman arm

---

**Pull to One Side**

Low or uneven tire pressure; unmatched front tires; loose axle "U" bolts; front spring sagging or broken; one rear spring sagging or broken; tight kingpin; incorrect toe-in or bent tie rod; bent steering knuckle or arm; incorrect camber or caster; improper tracking or shifted axles; faulty shocks

---

**Erratic Steering**

Low or uneven tire pressure; unmatched tires; incorrect brake adjustment or oil soaked lining; loose shackles, kick shackles or axle "U" bolts; incorrect caster, sagged or broken springs; bent knuckles, spindle, tie rod or drag link

---

**Wander or Weave**

Low or uneven tire pressure; looseness or tightness in steering gear or connections; loose pivots or wheel bearings; loose spring shackles, kick shackles or axle "U" bolts; tight or loose kingpins; spring sagging, broken or too flexible; bent spindle, defective shocks or stabilizer; improper caster or toe-in; loose rear wheels; bent or broken frame

---

**Low Speed Shimmy**

Low or uneven tire pressure; steering connections worn or out of adjustment; steering gear incorrectly adjusted; loose kingpins; loose wheel bearings; unbalanced wheel assemblies; eccentric wheels or tires; incorrect caster or camber; bent spindle or knuckles; too much toe-in; defective shock absorbers

---

**High Speed Shimmy  
or "Tramp"**

Low or uneven tire pressure; unmatched front tires; wheels or tires eccentric or out of balance; loose steering connections or shackles; broken or sagging springs; excessive or unequal caster; too much toe-in; bent tie rods; inoperative shock absorbers; sagging or broken springs

# INSTRUCTIONS FOR USE OF

CAT. NO. 66000, MAGNETIC CASTER/CAMBER GAGE  
CAT. NO. 66200, WHEEL ALIGNMENT TURNTABLES

## I Definition of WHEEL ALIGNMENT Terms

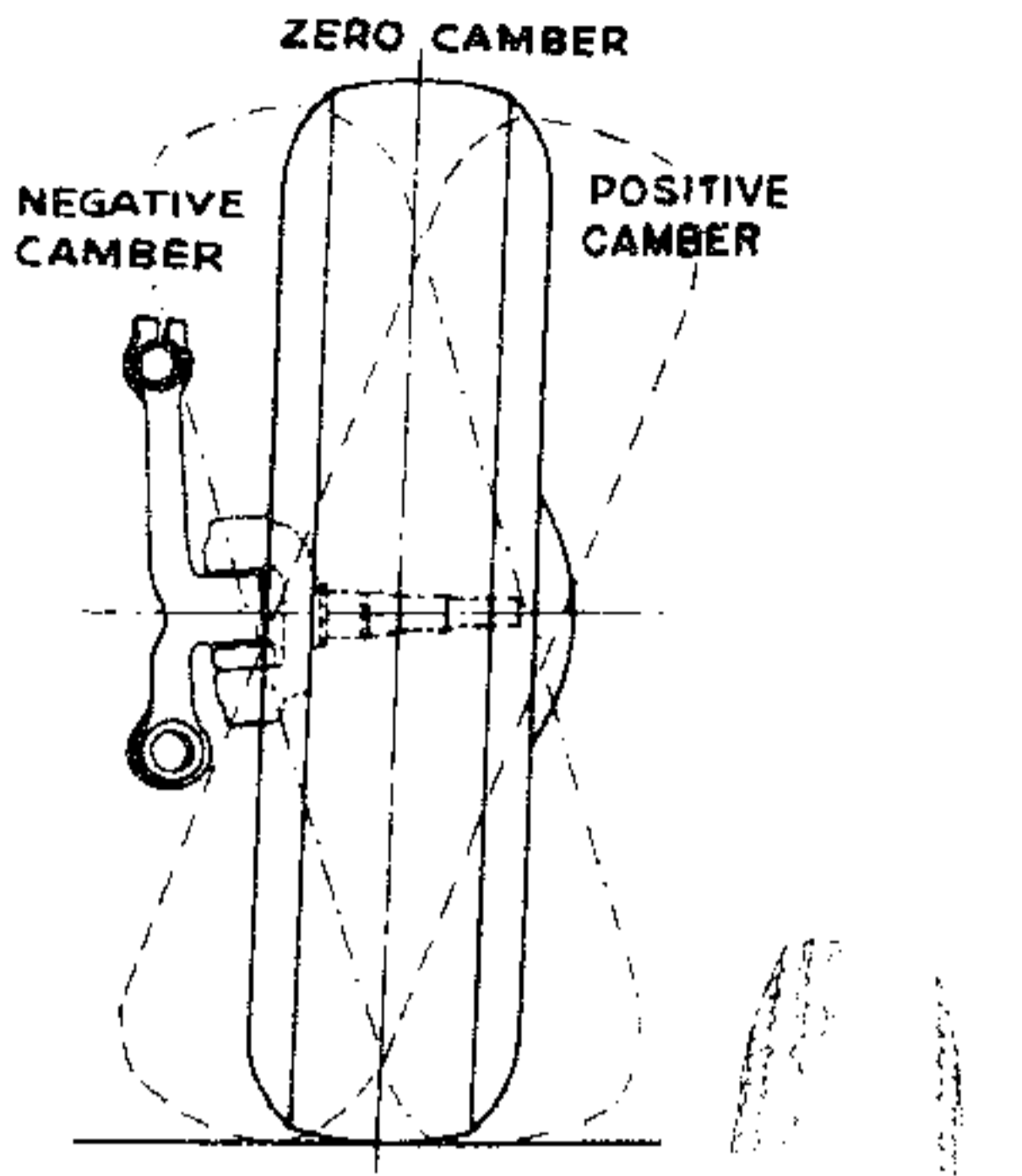

Wear caused by excessive camber.

### **CAMBER**

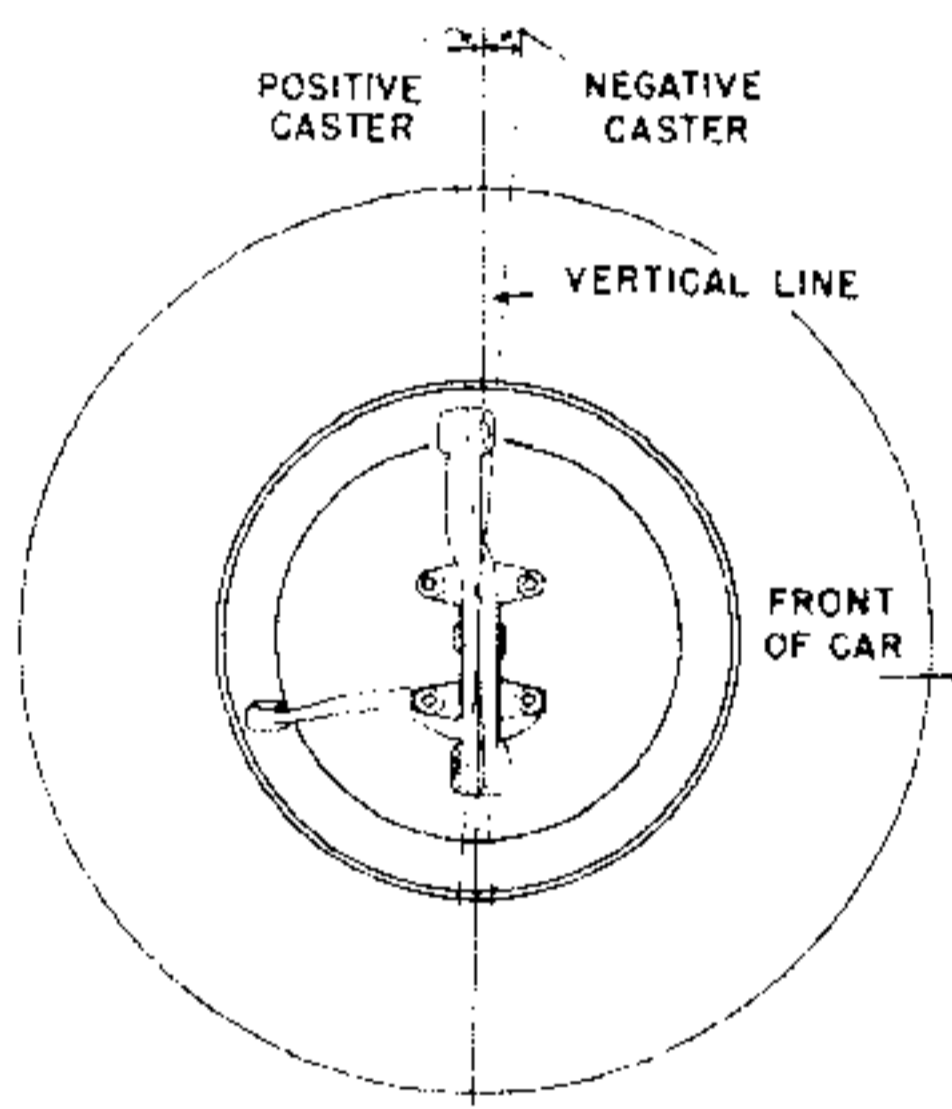

### **CASTER**

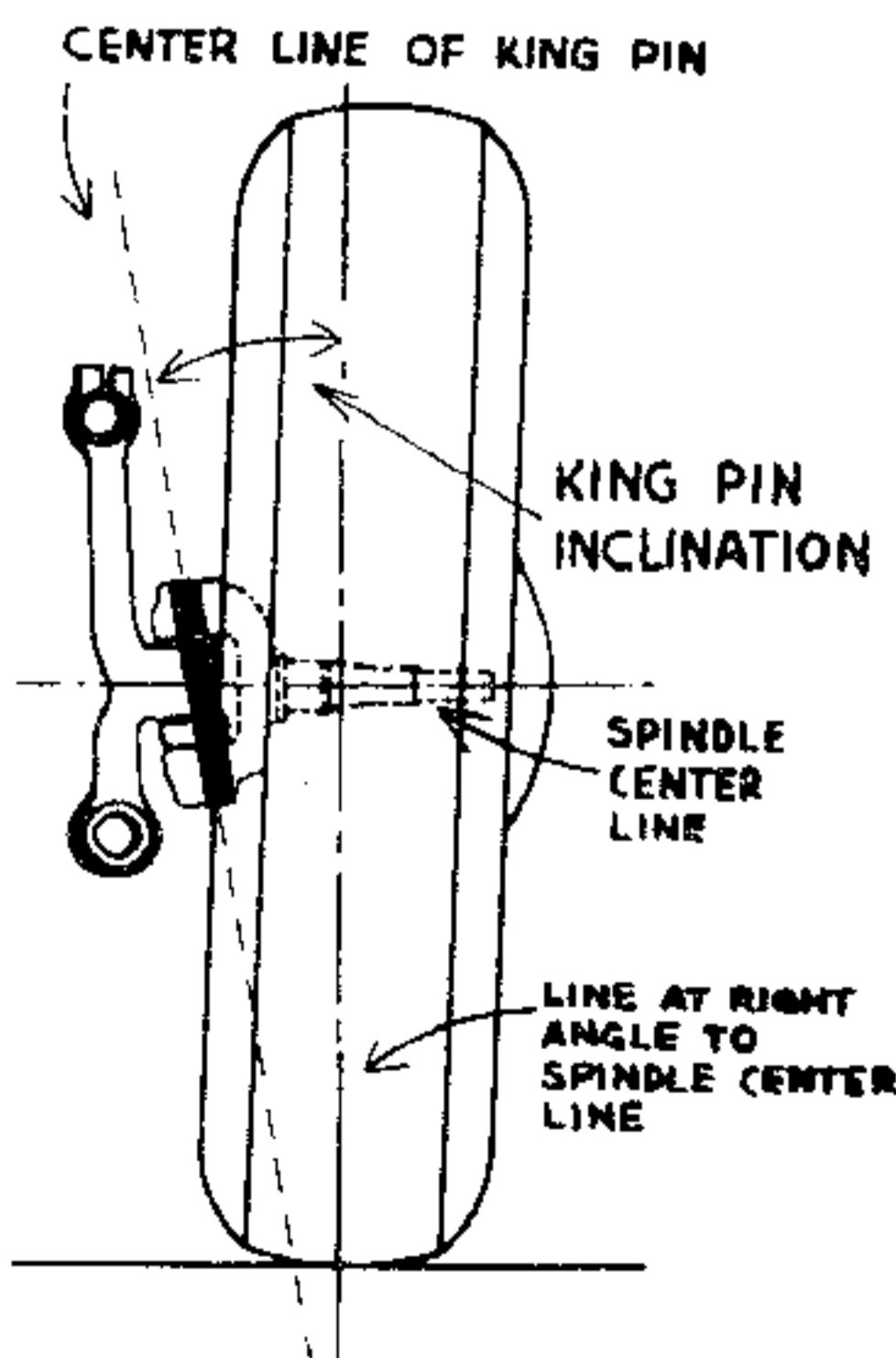

### **KINGPIN INCLINATION**

1. **CAMBER** is the tilt of the top of the wheel. Camber is referred to as being zero when the wheel is straight up and down. An outward tilt indicates positive camber, while an inward tilt indicates negative camber.

Camber is adjustable to compensate for spring sag and road crown. Readings should be kept within the vehicle manufacturer's specifications. The variation between the wheels should not exceed  $3/8^\circ$ . Excessive camber will cause part of the tire tread to wear faster than the rest of the tread.

2. **CASTER** is the tilt of the top of the support arm towards or away from the driver. Caster is referred to as being zero when the support arm is straight up and down. Positive caster means that the top of the support arm is tilted towards the driver. Negative caster means that the top of the support arm is tilted away from the driver.

Caster is adjustable to improve directional stability. Readings should be kept within manufacturers specifications and the variation between the wheels should not exceed  $3/8^\circ$ .

Excessive caster may cause wandering, weaving, shimmying or hard steering. Unequal caster will cause pulling to one side.

3. **KINGPIN INCLINATION** is also called Steering Axis Inclination on vehicles equipped with ball joint suspension. It is the inward tilt of the top of the kingpin as compared to a line at right angles to the spindle.

Kingpin inclination is a most important directional stability factor. In addition to minimizing the stress on the king pins and bushings, it also resists any outside force turning the wheels and is responsible for the wheels returning to the straight ahead position after they have been turned.

Kingpin inclination should be maintained within manufacturers specifications. Since it is not adjustable, incorrect readings indicate bent parts, usually the spindle, which should be replaced.

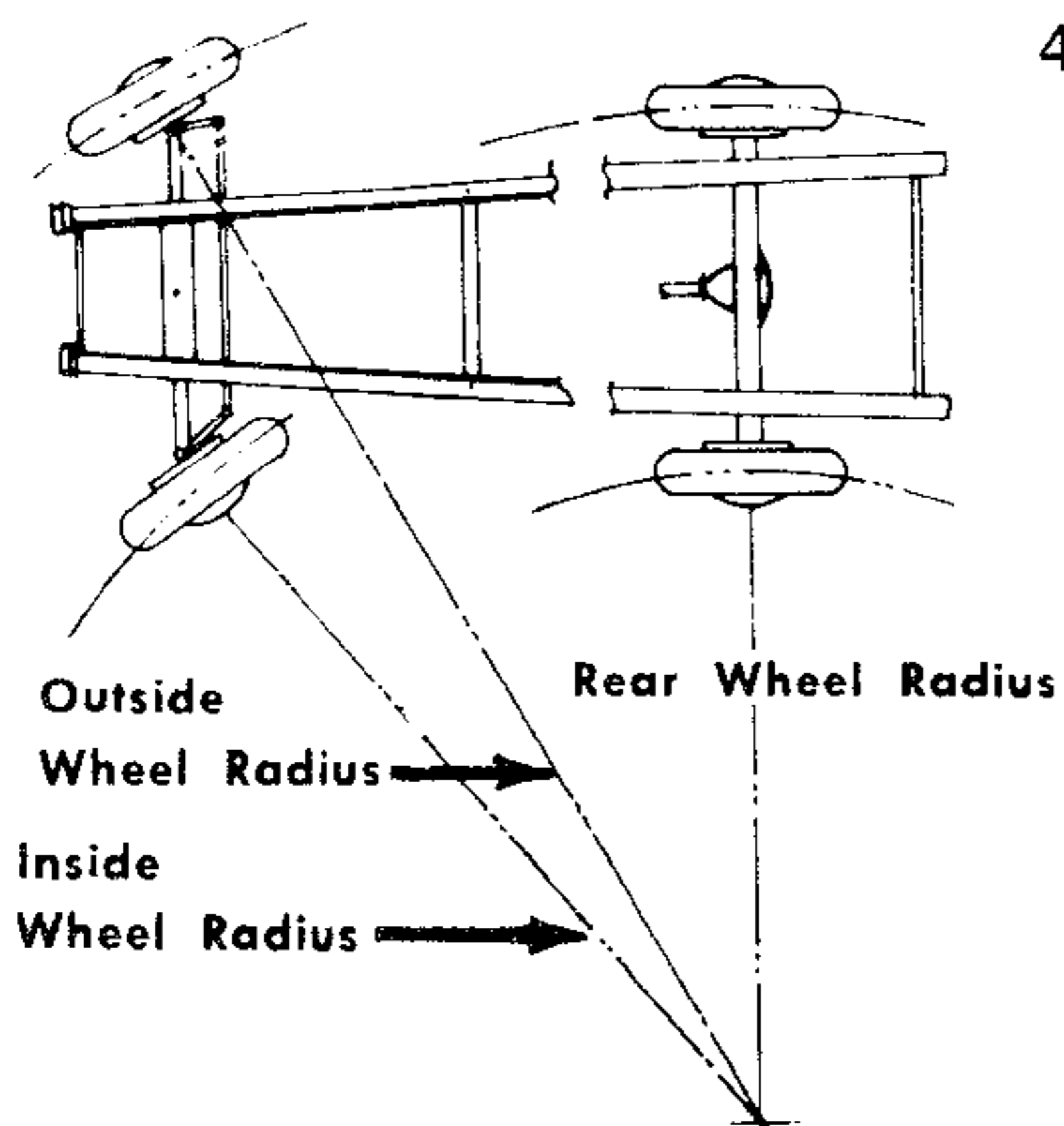

**TOE-OUT ON TURNS**

4. **TOE-OUT ON TURNS** When a vehicle makes a turn, the inside wheel travels in a smaller circle than the outside wheel. The inside wheel, therefore, turns at a greater angle.

Since toe-out on turns is controlled by the proper position of the steering arms and is not adjustable, inaccurate readings would indicate bent parts, usually the steering arm. Correction is accomplished by replacing the bad arm.

No matter how accurately the front wheels are positioned for straight ahead driving, they may still be out of their correct relative position on turns.

The wheels of an average car turn to some degree at least 60% of the time. Inaccurate turning radius results in abnormal and excessive tire wear.

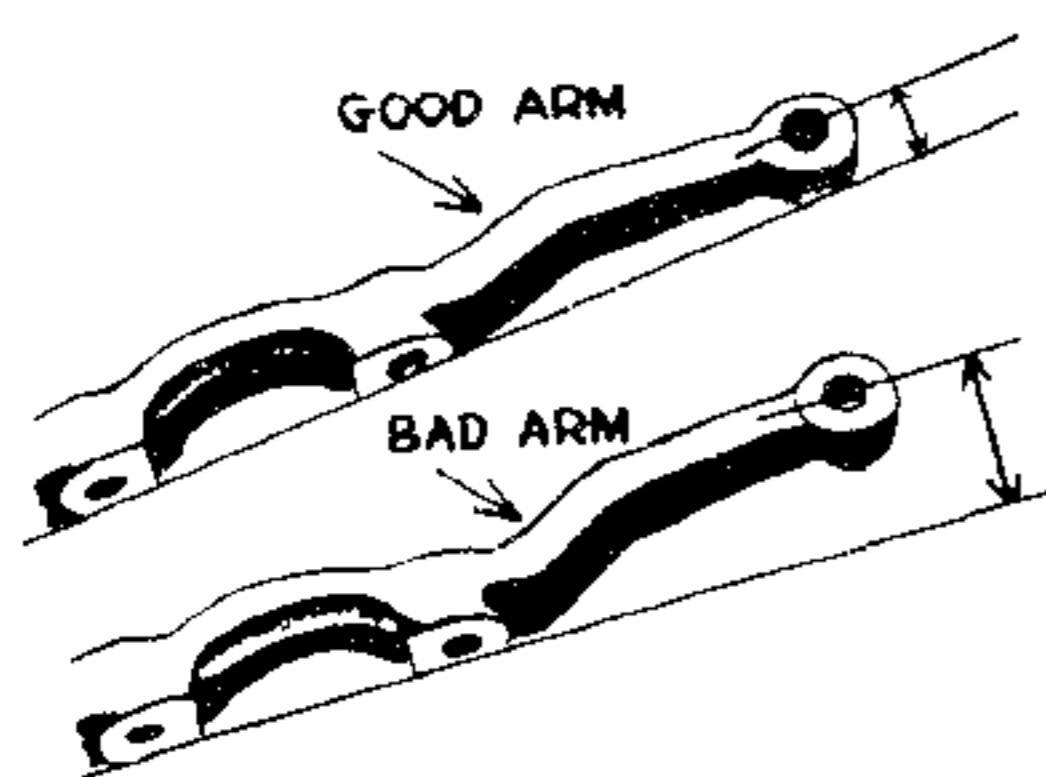

5. **TOE-IN** is the difference in distance between the front of the wheels as compared to the back of the front wheels.

Readings should be kept within manufacturer's specifications. Toe-out may cause wandering or weaving. Incorrect toe-in or toe-out may cause abnormal and excessive tire wear.

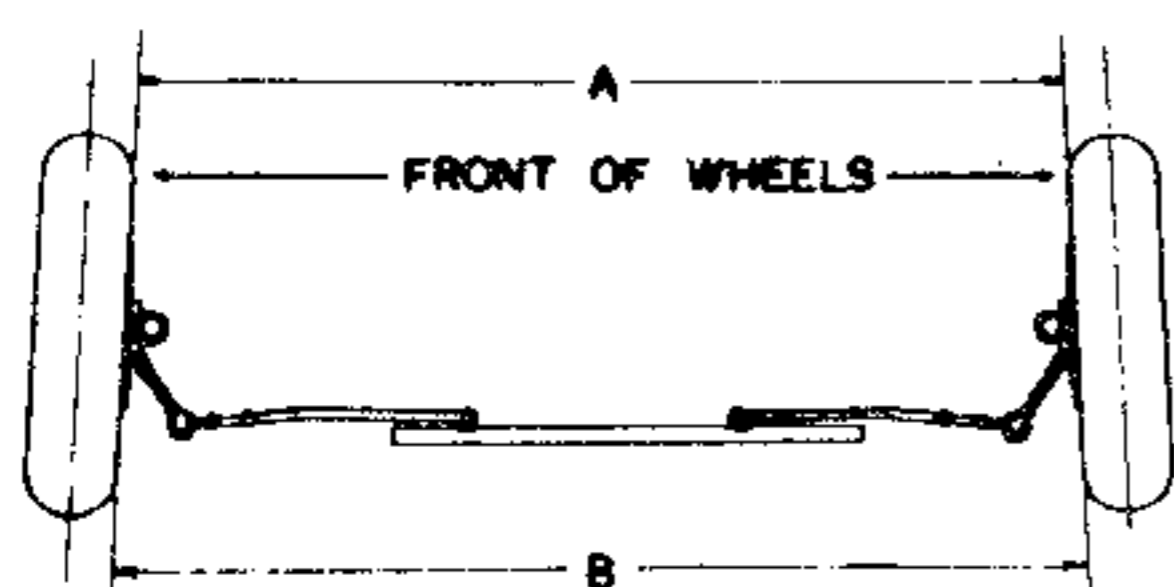

**TOE-IN**

## II Select a FLOOR AREA for Wheel Alignment Testing

1. While your set may be used in any part of your shop without the necessity of tying up valuable space, it is recommended that the area chosen be one that is readily accessible and reasonably level.
2. After the area has been selected, rectangular spots should be painted on the floor at each of the front wheel locations. Turntables should be placed on these spots and leveled.

## III PRELIMINARY VEHICLE INSPECTION

1. Before starting an alignment job, a preliminary inspection of the condition of the vehicle should be made. A check should be made for loose wheel bearings, worn kingpin bushings and ball socket joints, inactive shock absorbers, sagging or broken springs and badly or irregularly worn tires.
2. Corrections or replacement should be made before proceeding.
3. All tires should be inflated to the correct air pressure. The front tires should be of the same size and of equal wear.

## IV WHEEL ALIGNMENT PROCEDURE

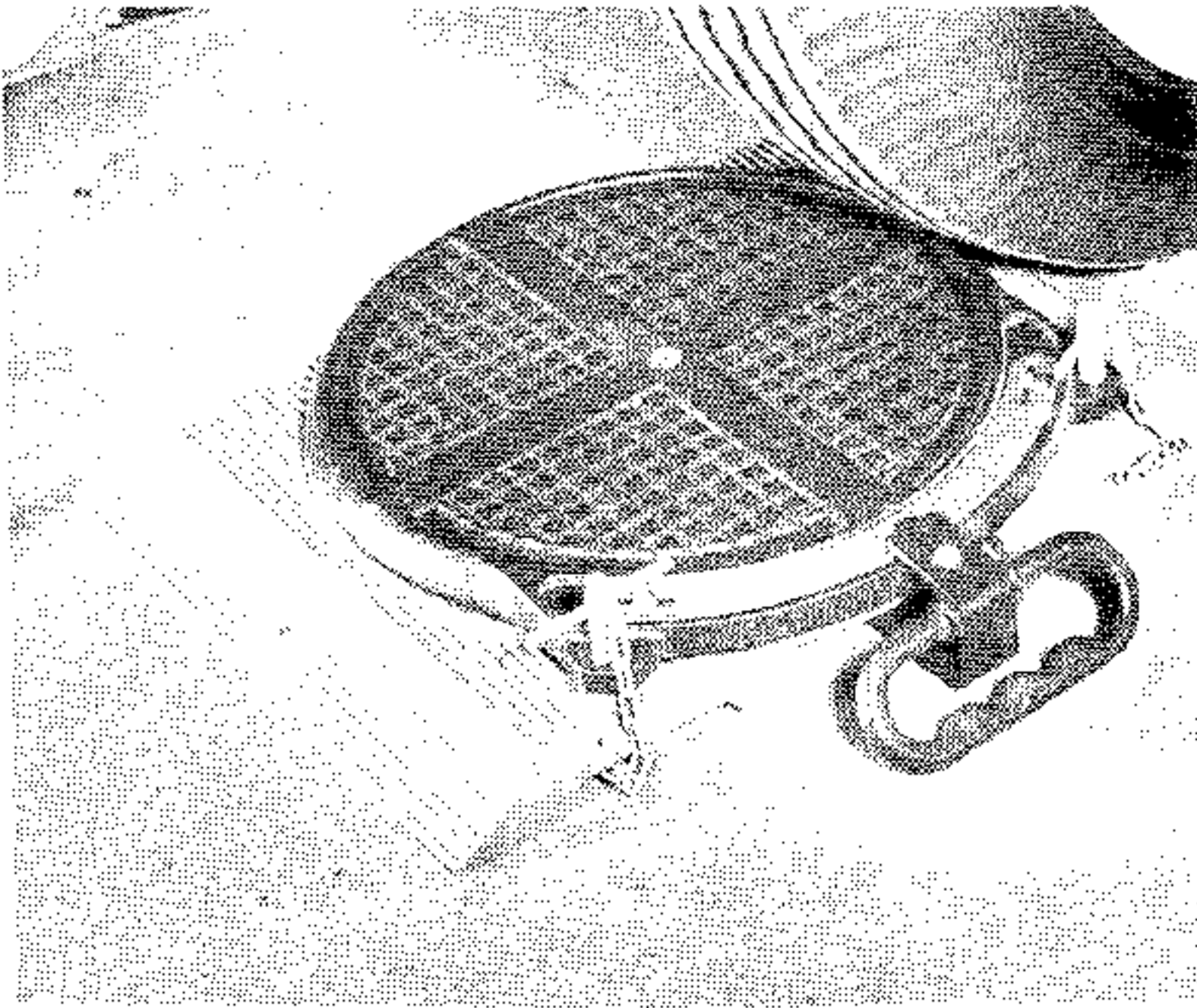

1. Drive the car forward to the edge of the rectangles you have painted on the floor. With the lock pins in place, firmly wedge the tapered edge of a turntable under the front of each tire. Slowly drive the car forward until it is centered on the turntables. (The car should not be backed into checking position as inaccurate readings may result.) Apply the brakes gently to prevent the turntables from sliding. If sliding occurs, use a piece of rubber mat under turntable (Level them to compensate for the mat.) For best results lock brakes with brake pedal jack.

2. The rear wheels of the vehicle should be raised 1 7/8" to allow for the height of the turntables. This can be accomplished by using plywood, wooden blocks or any solid material having a height of 1 7/8". A pair of wooden blocks cut 10"x10"x1 7/8" high are ideal. Jack up rear of vehicle. Place one block under each rear wheel.
3. Remove the locking pins from the turntables. Grasp the center of front bumper and bounce the front end up and down vigorously. Let the car settle back slowly and equally from the top of the final bounce. Make certain that both of the turntable pointers read 0° on the dial. If necessary, loosen the dial plate screws and adjust the dials to 0°.
4. Using a suitable tool remove both hub and dust caps. Wipe off the machined end of the wheel flange. This is the surface on which your gauge will locate. It is machined to a close tolerance and is the only machined surface on the outside of the wheel.

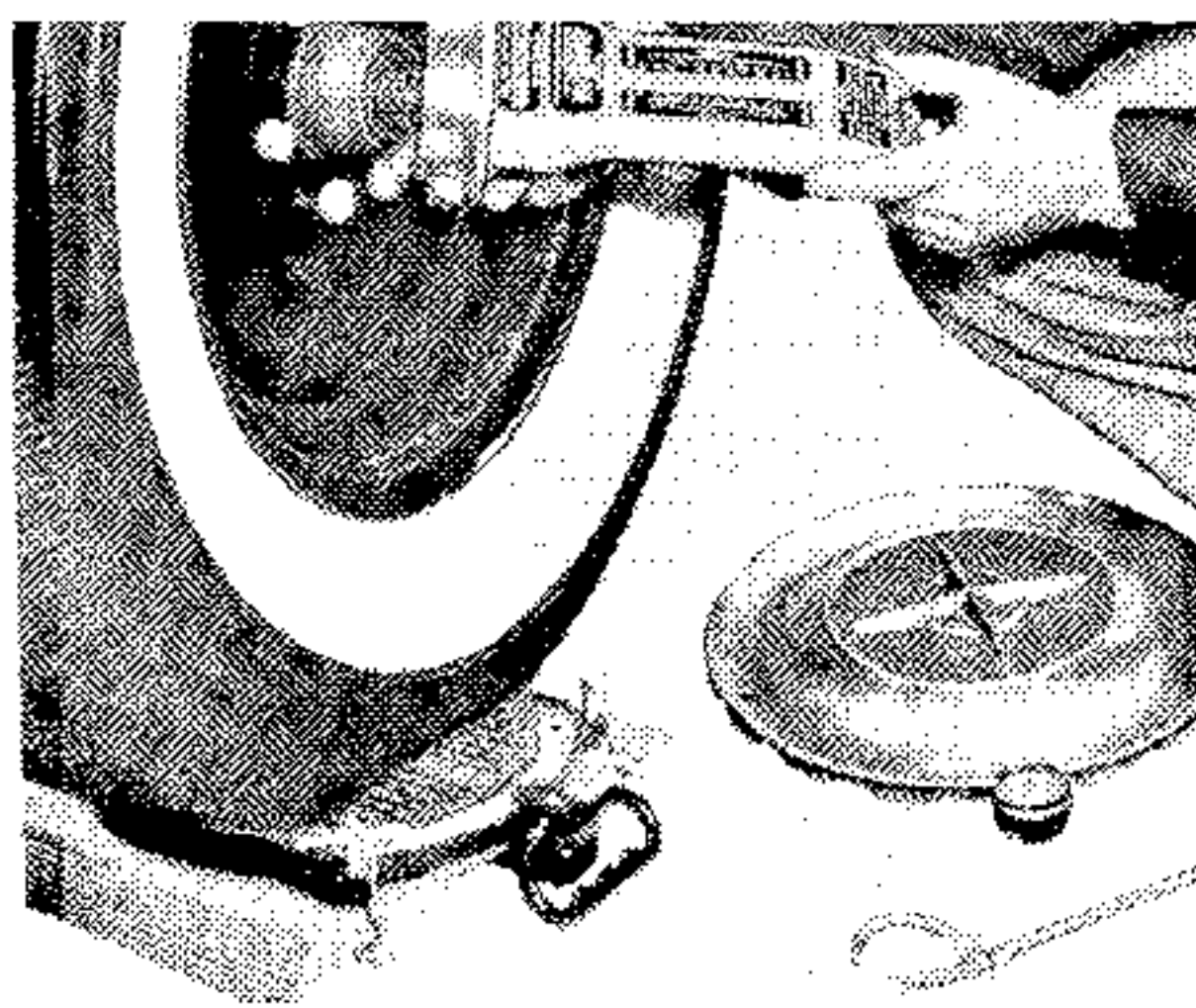

5. Hold the magnetic gauge at a slight angle to the machined surface so that the centering plunger will enter the lathe center hole in the end of the spindle. Rotate the gauge back and forth several times to provide a good seat. The sharp edges of the notches in the Alnico magnet will act as an end reamer and remove any burrs that may exit. The gauge should now be firmly seated and no rocking motion should be evident.

## V TAKE READINGS

1. It is suggested that a chart be made and all of the readings listed before making any corrections.

	LEFT WHEEL	RIGHT WHEEL	DESIRED READING
<b>CAMBER</b>			
<b>CASTER</b>			
<b>KING PIN</b>			
<b>TOE-OUT</b>			
<b>TOE-IN</b>			

The front end should be checked in the following order; starting with the left wheel.

2. With the wheels straight ahead and the kingpin inclination bubble centered on zero, you can now take the camber reading directly from the center of the bubble on the camber scale on the right side of the gauge. Write down the reading for the left wheel.

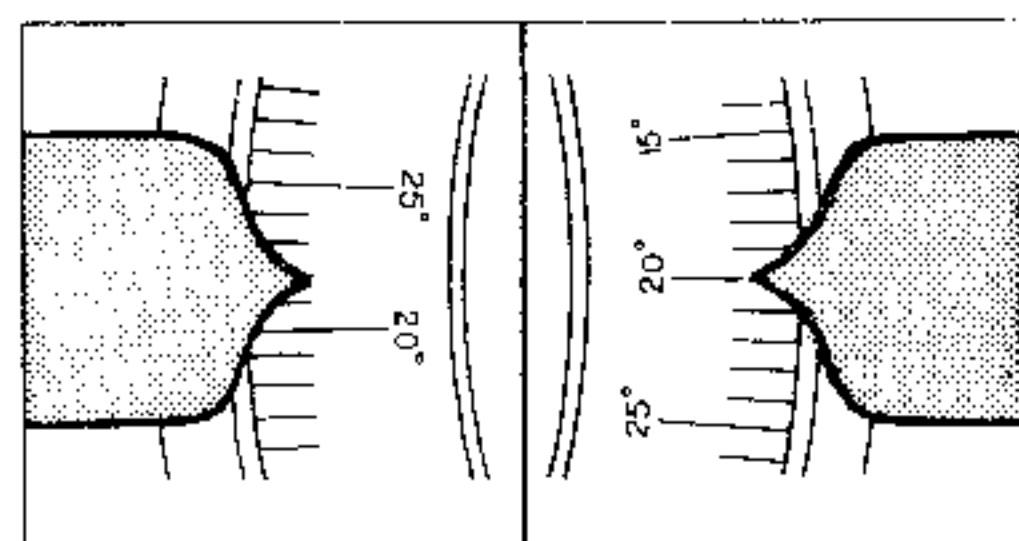
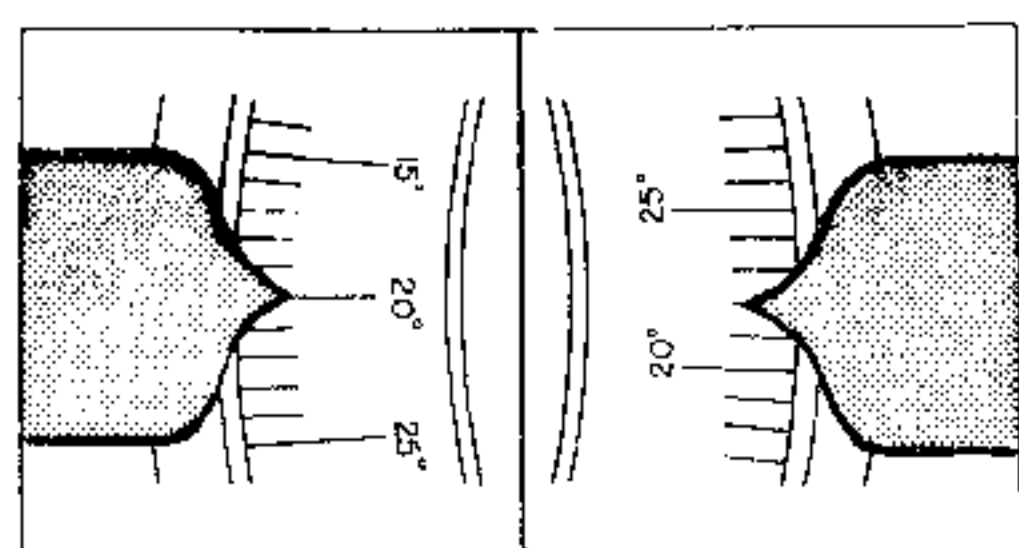
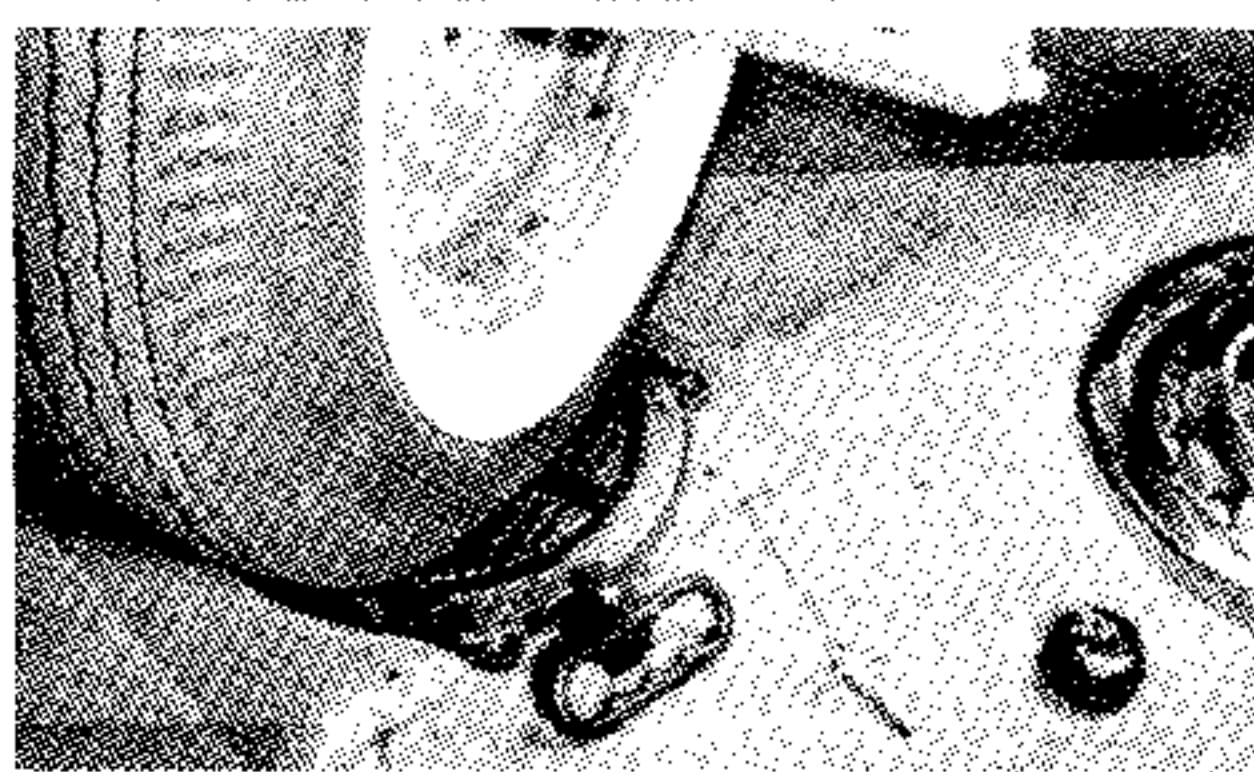
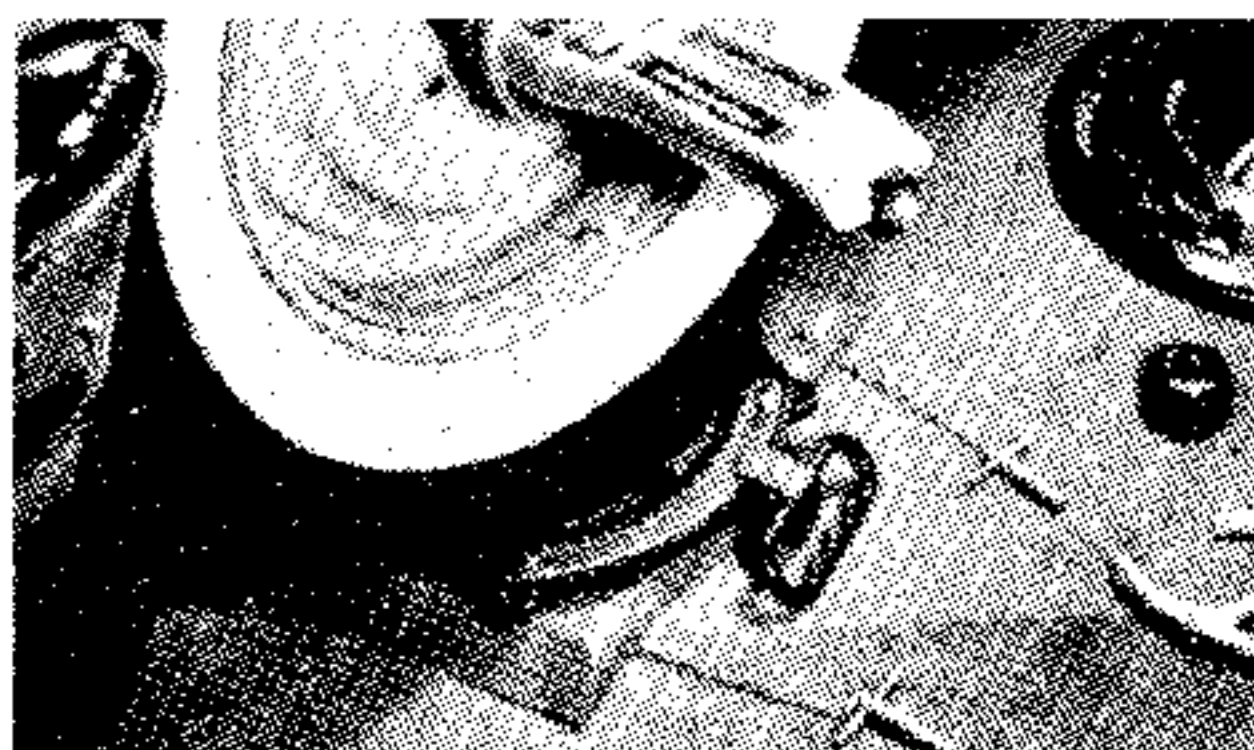

Left wheel Right wheel

3. Caster, Kingpin Inclination and toe-out on turns are read at the same time. With both turntable pointers indicating  $0^\circ$ , turn the front of the left wheel in to  $20^\circ$  on the turntable dial. Go to the right front wheel and read the turntable dial. The amount indicated on the turntable dial is the toe-out on turns reading for the right wheel. It should be greater than  $20^\circ$ . Write down the reading.
4. Go back to the left wheel. Rotate the gauge until the center of the kingpin inclination bubble reads  $0^\circ$  and adjust the knob on the end of the gauge until the center of the caster bubble reads  $0^\circ$ . Then turn the front of the wheel out to  $20^\circ$ . The center of the bubble at the top of the gauge will now indicate the correct Kingpin Inclination.

The center of the bubble on the caster scale on the left side of the gauge will indicate the amount of caster and whether negative or positive. Mark the readings.

5. The same operations should now be repeated at the right wheel and the readings marked down.

## VI MAKE CORRECTIVE ADJUSTMENTS

1. For the proper settings consult your Service Manual or the specifications furnished. A preliminary Toe-in check may be desirable for a general idea of the condition of the alignment. Make all of the corrections necessary before proceeding with the final Toe-in check as other changes may affect Toe-in.
2. On many of the cars today the upper pivot pin is both threaded and eccentric which provides both caster and camber adjustments at this point. Since several turns are required to change caster any appreciable amount, that correction must be made first.

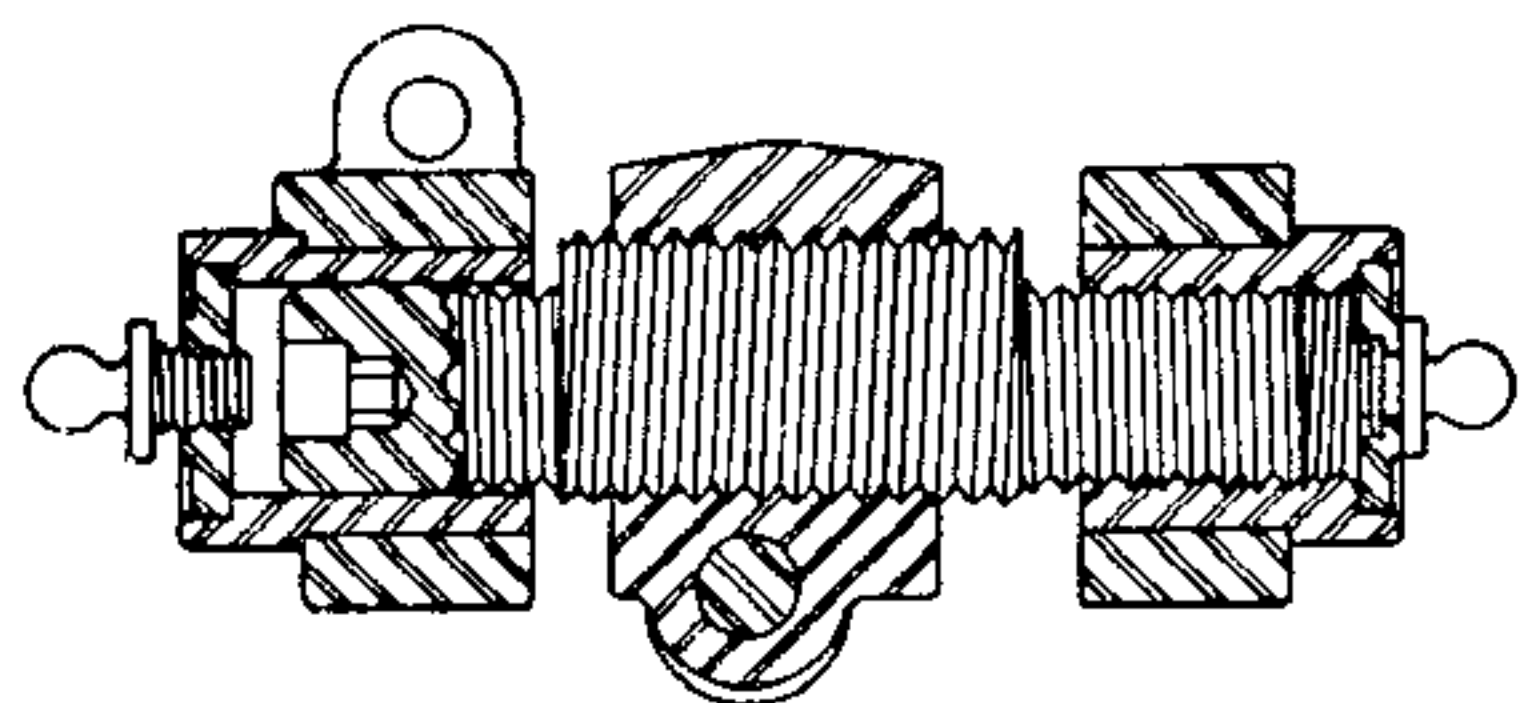

3. The change **caster** loosen the clamp bolt at the upper end of the support arm. On those cars which use an allen wrench for adjustment, the grease fitting must first be removed and the allen wrench inserted. On other cars using this type of pin, a crow-foot or offset wrench must be used on the hex portion of the pin. It is located in the opening between the support arm and upper control arm.

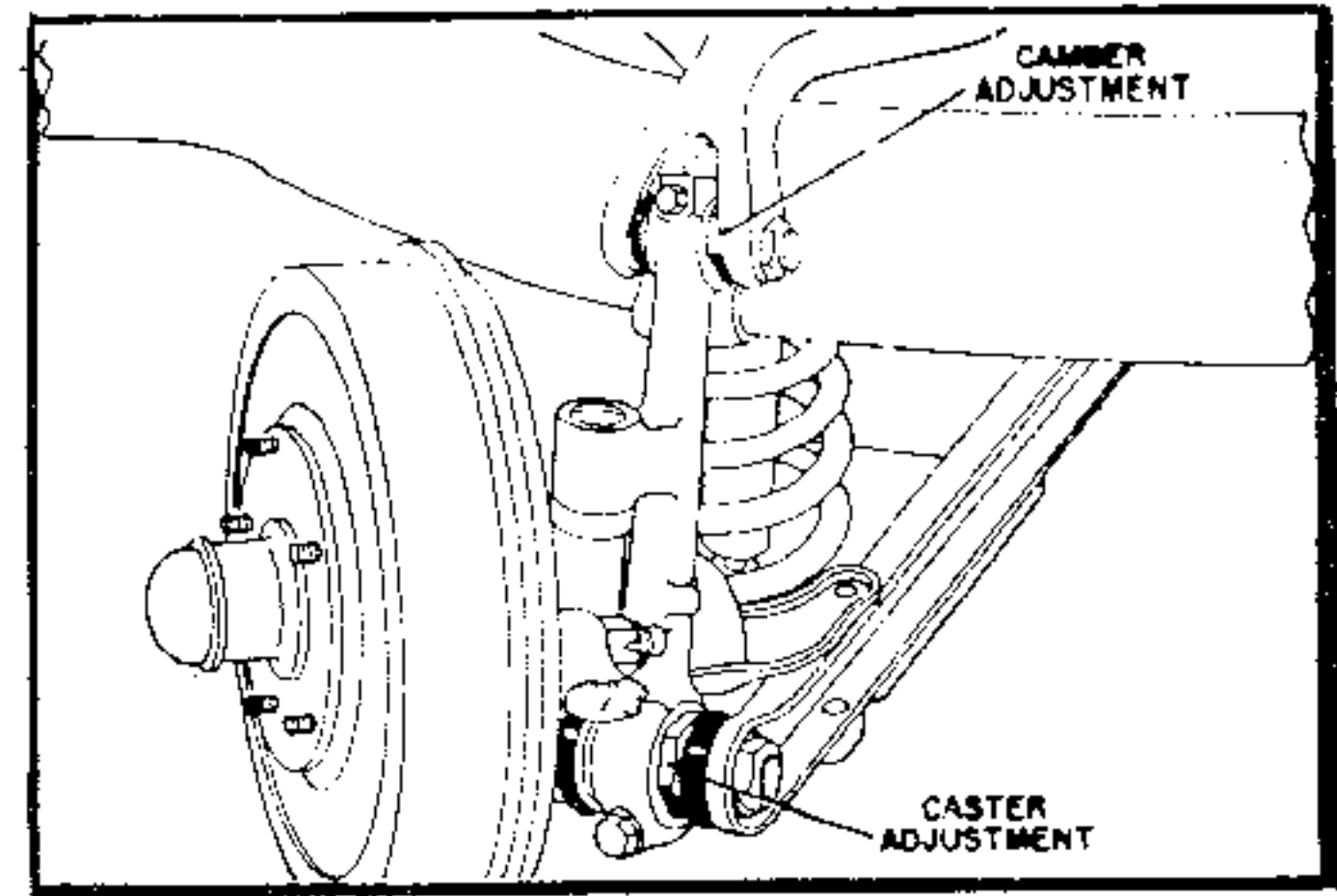
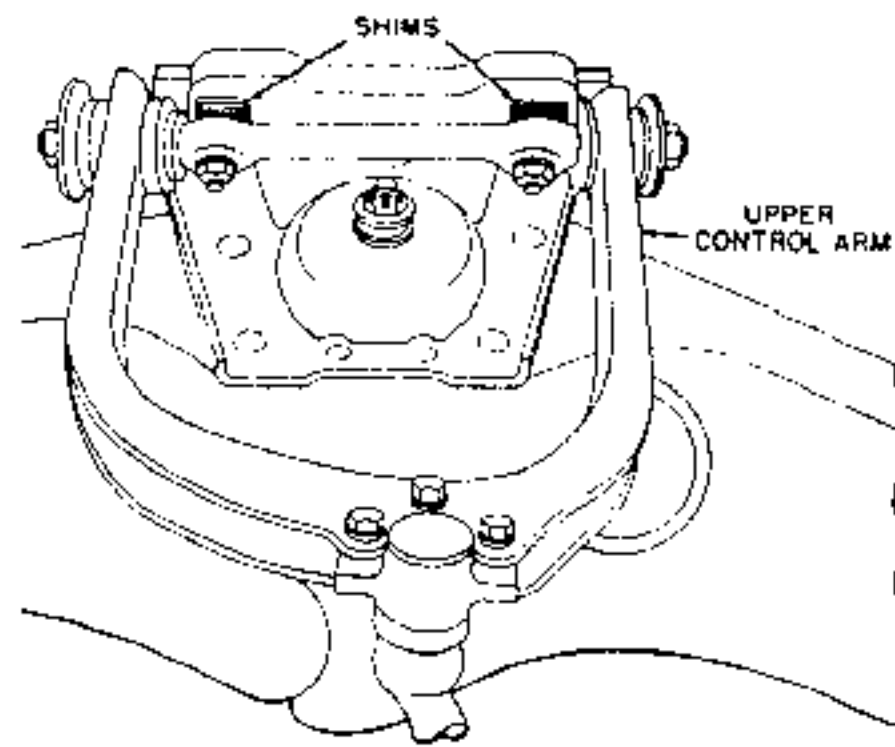
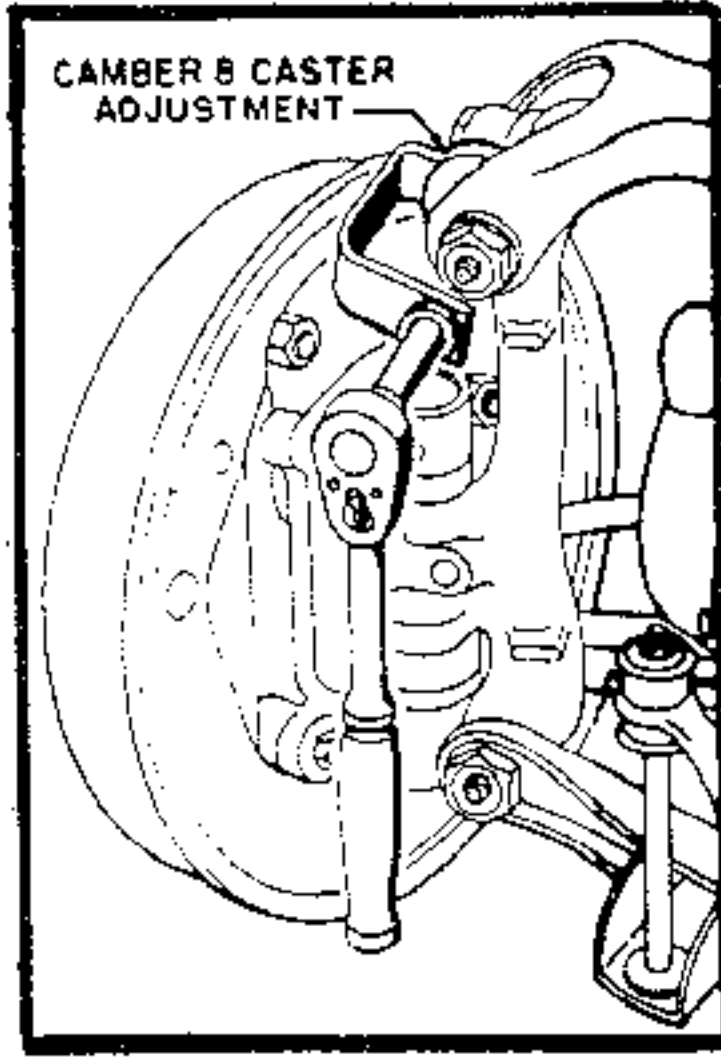
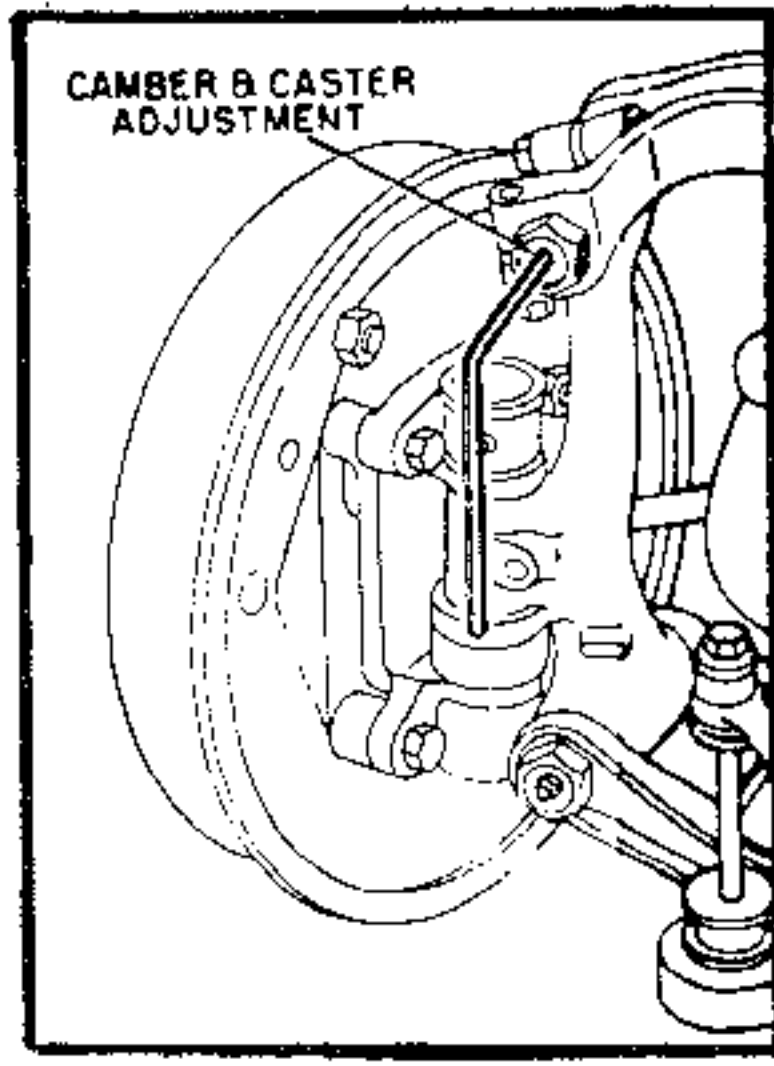

4. The **camber** adjustment is controlled by the eccentric action of the pivot pin. Since a half turn of the pin is the maximum eccentric adjustment, it is the limit of the camber adjustment.
5. Additional caster and camber can be obtained in most cases by the use of shims.
6. After the adjustments have been made, the support arm clamp bolt should be tightened securely and grease fittings replaced.
7. Still another type of system used on the modern car is one where a separate adjustment pin is provided for Caster and another adjustment pin for Camber.

8. Various other systems use spacers and washers for accomplishing the adjustments. Among these is the ball joint suspension system which uses shims for both the caster and camber adjustment. In this system the caster should be corrected first by the addition of a shim either at the front or rear of the mounting bolts. To make a camber adjustment remove or add shims of equal thickness to both front and rear bolts. Tighten the bolts securely when an adjustment has been completed.

## VII MAKING ADJUSTMENTS WITH THE WHEELS OFF

While the adjustments are usually made when the front wheels are on the turntables and the locking pins out, it is sometimes desirable to make adjustments with the front wheels removed:

1. Take all readings in the conventional manner with the front wheels on the turntables. Make a note of the readings and the amount of adjustment needed, also whether negative or positive.
2. Raise the front end and remove the wheels.
3. Making certain that the brake pedal is firmly locked, apply the gauge to the machined surface on the end of the hub and take a second reading. This is the starting point.
4. Make the caster adjustment first, using the kingpin level to determine the amount of adjustment made. The space between each of the lines of the caster correction scale below the kingpin inclination level is equal to one degree of caster. If the bubble moves towards the front of the car, the adjustment is being made in a positive direction. (The top of the support arm moves in the opposite direction from the bubble.)

5. Make the camber adjustment using the camber scale on the gauge. If the bubble goes to either end, adjust the caster bubble to zero and use the caster level to read camber. The space between each of the lines of the camber correction scale on the left side of the caster level is equal to one degree of camber.
6. Lower the front wheels onto the turntables, bounce the car from the center and double check the readings.

### VIII ADAPTERS AVAILABLE

These magnetic gauge adapters for No. 66000 are available if needed. Wheel spindle size determines which adapter to use.

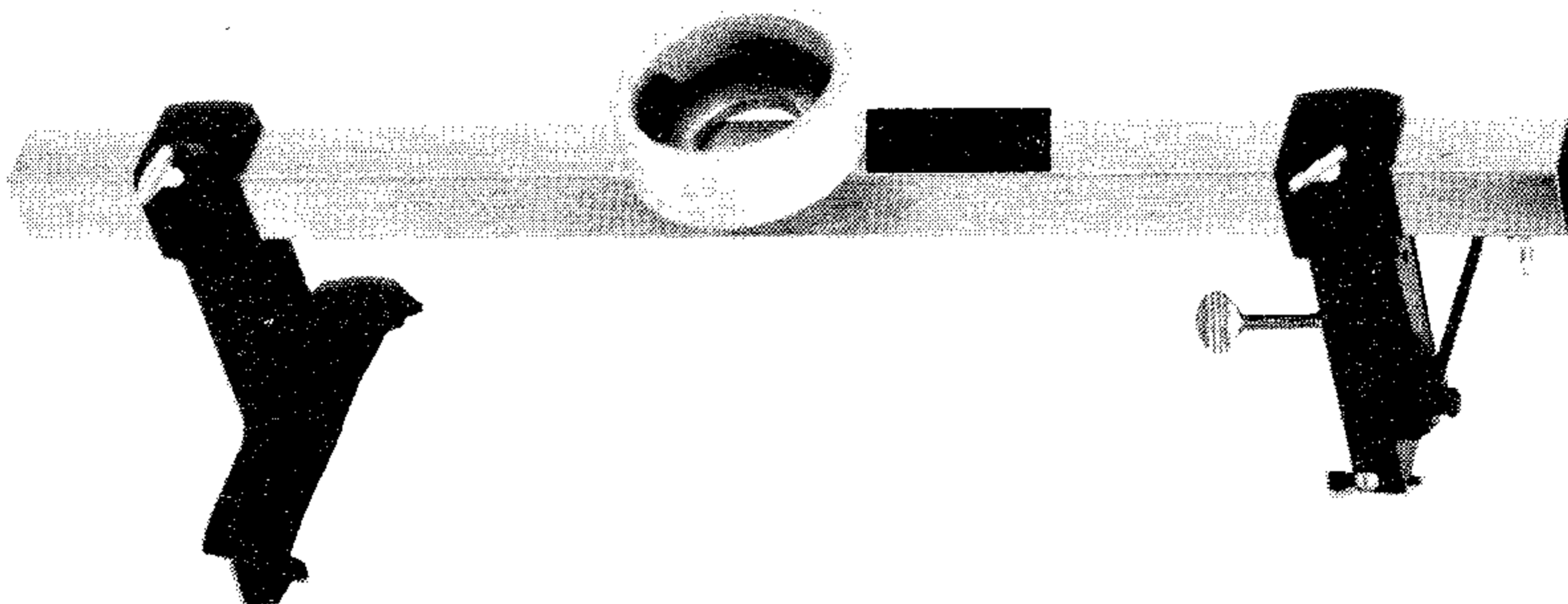

**S & G TOOL AID CORP.**



## 66000

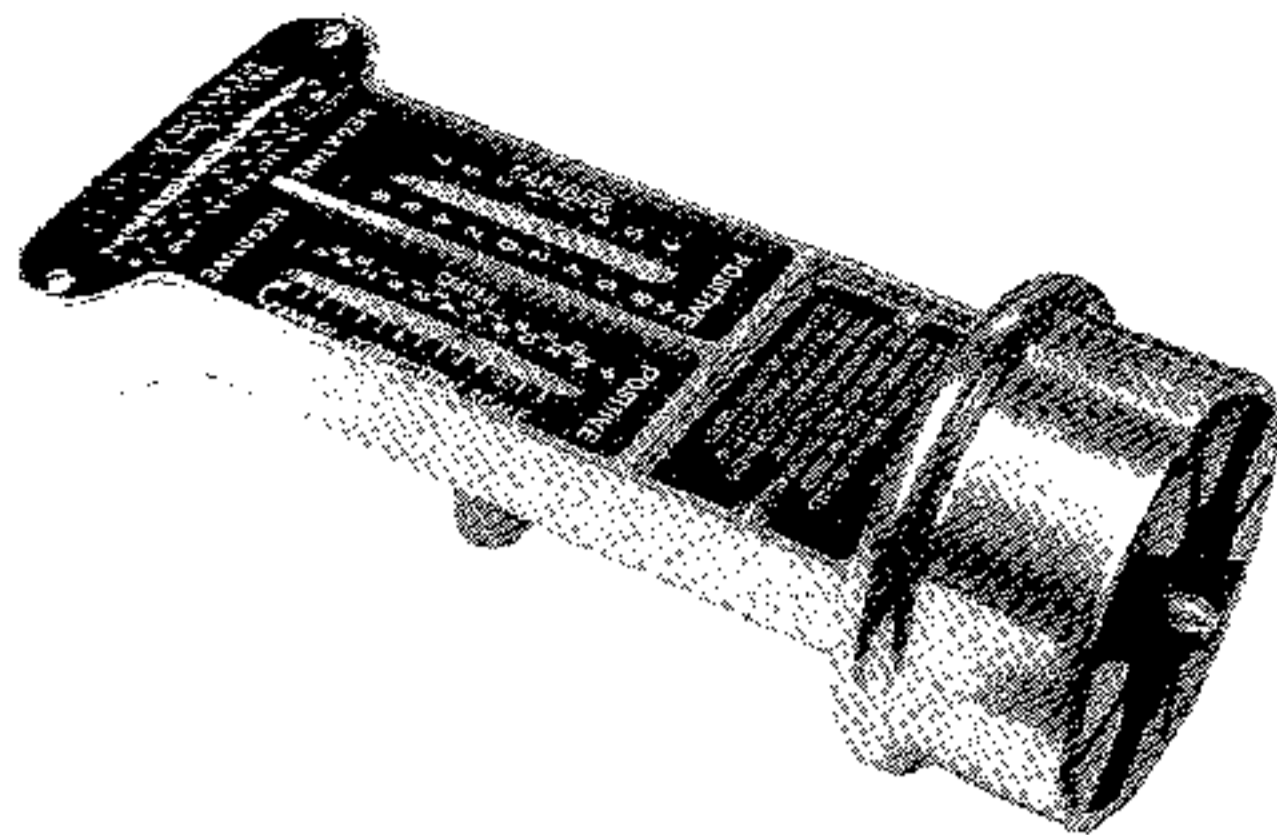

## MAGNETIC CASTER/CAMBER GAGE

**66000** - Quickly determine causes of erratic steering and excessive tire wear without tying up valuable floor space and working capital. Use this magnetic gage on all vehicles to check caster and camber in 5 minutes on a rack, pit or as a portable floor unit. Easy to use—direct reading—no special schooling required, no calculations necessary. Equipment requires no extra space. The low cost can be amortized quickly and yield profitable results immediately.

FUNCTION	SCALE RANGE
Camber	+8° to -8°, Numerically by degrees and in increments of 1/2°
Caster	+14° to -6°, Numerically by degrees and in increments of 1/2°
Kingpin	+20° to -20°, Numerically by degrees and in increments of 1/2°

Multi pole Alnico Magnet has built in cutter teeth to remove burrs on wheel hub surface. Precision gage has level vials which are internally ground with evenly spaced permanent markings. Provides micrometer accuracy. Vials are recessed to eliminate breakage. Gage is equipped with spring loaded centering plunger to pinpoint center of wheel. Readings are not affected by wheel runout, uneven rims or tire bulges. Supplied with full instructions and wheel alignment specifications for passenger cars, imported vehicles and light trucks. Packed in permanent protective metal storage box.

## 66150

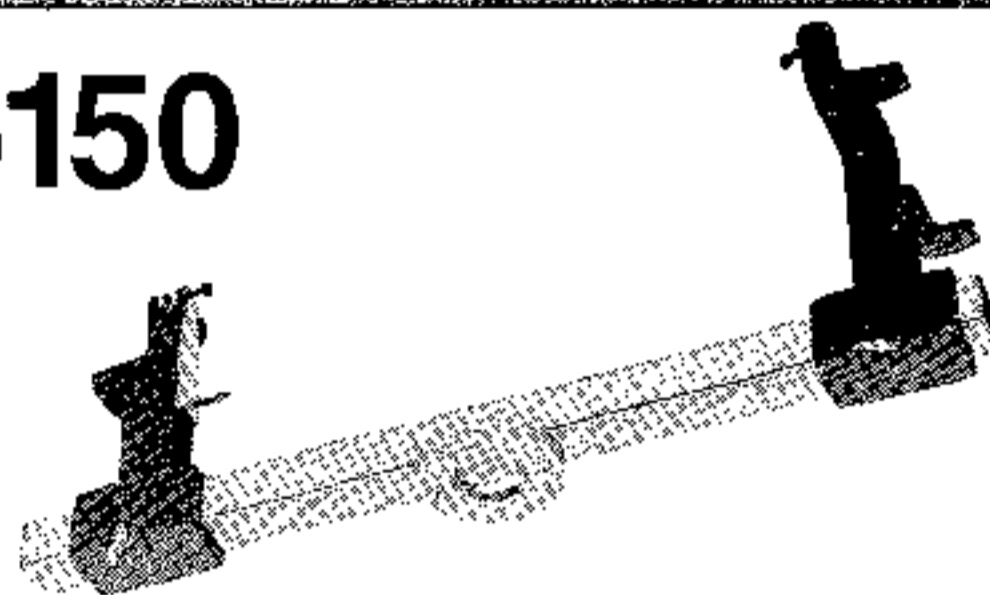

## CASTER/CAMBER GAGE ADAPTER

**66150** - Adapter for unusual wheels such as magnesium, Jeep and special foreign.

## 66160

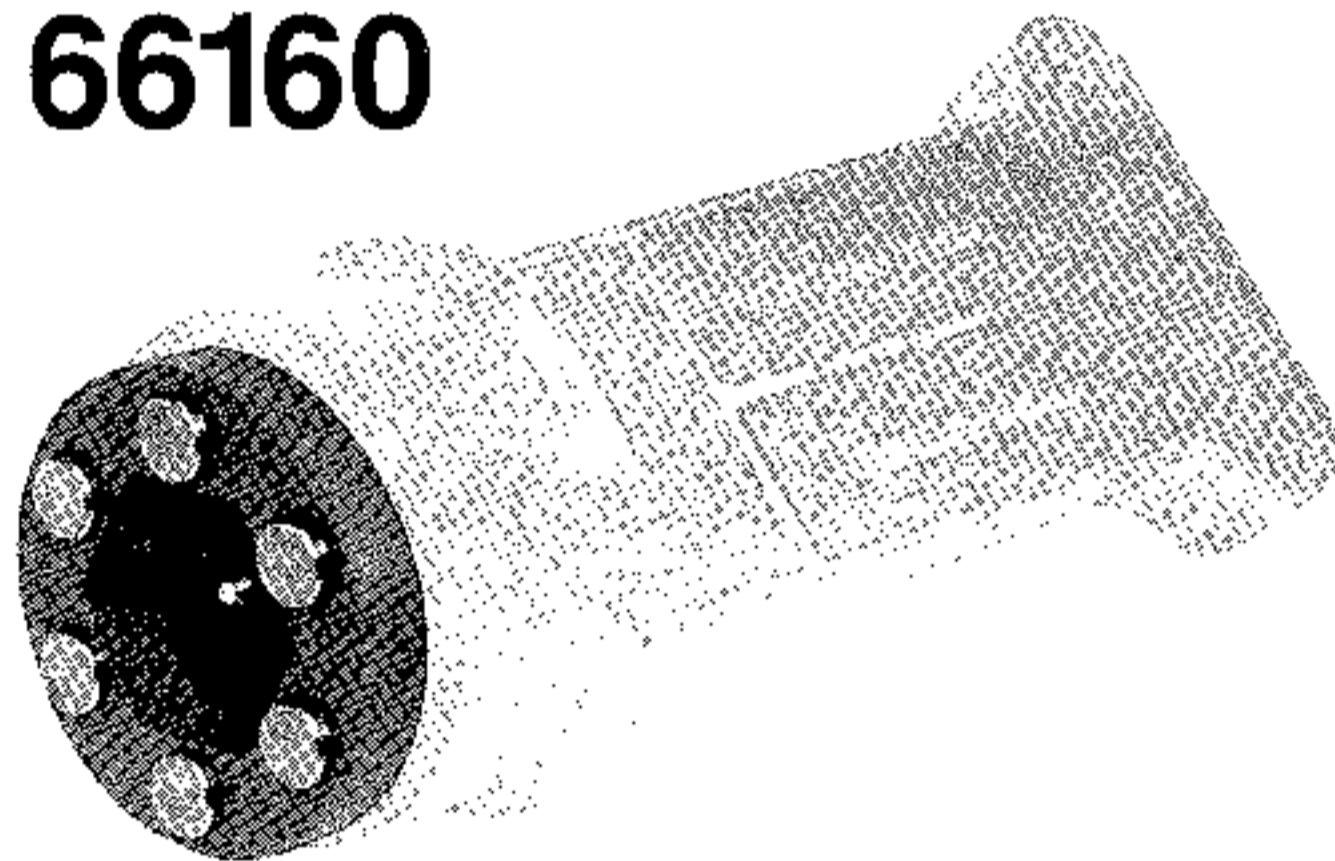

## MAGNETIC TRANSFER ADAPTER

**66160** - Use in conjunction with our Cat. No. 66000, Magnetic Caster/Camber Gage. This adapter is designed to fit on many vehicles, including General Motors A, J and X Body cars, Chrysler K Bodies and all Ford vehicles with standard wheels. Eliminates the need to remove the spindle nut. The adapter is placed over the spindle nut making direct contact with the hub. Adheres to the hub magnetically when the Caster/Camber Gage is applied.

## 66170

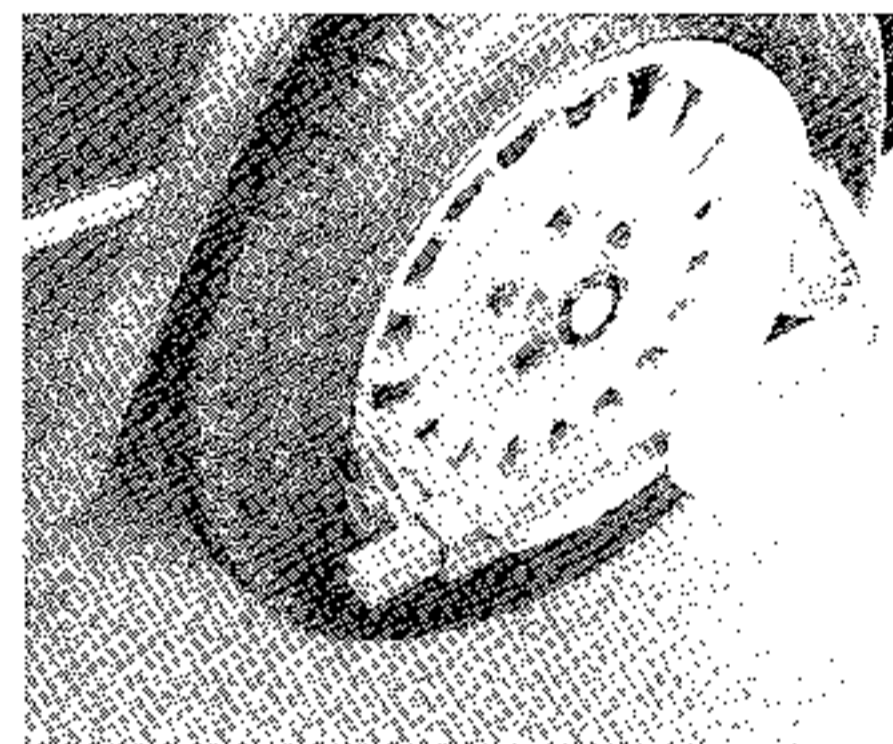

## NO MAR RIM ADAPTER FOR MAGNETIC CASTER/CAMBER GAGE

**66170** - Designed to fit onto wheels that have wheel hubs which are difficult to engage. Will not mar mags, aluminum or custom wheels. Adapter is attached to the outside of the wheel felloe eliminating any possible damage.

## 66200

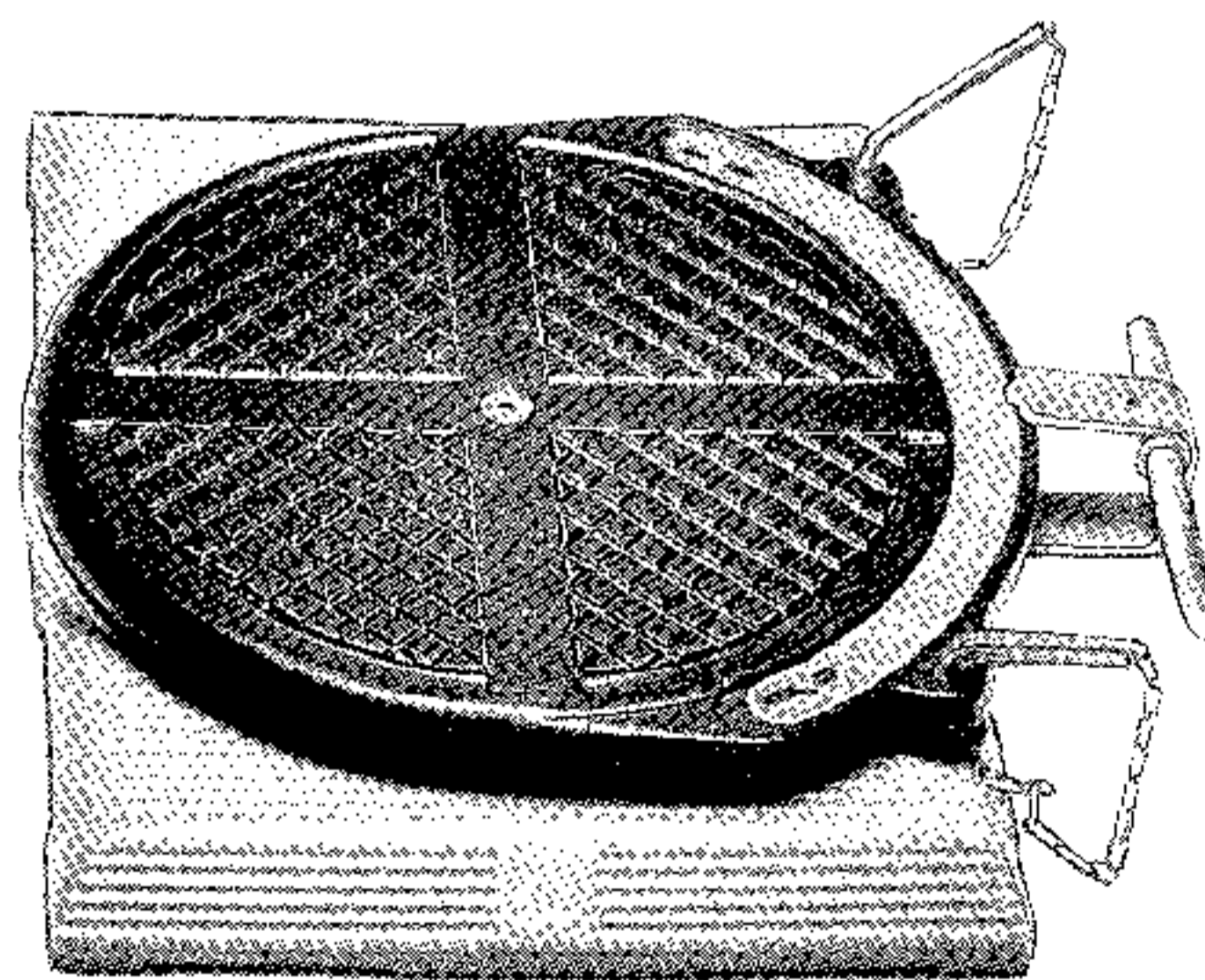

## WHEEL ALIGNMENT TURNTABLES (SET OF TWO)

**66200** - A companion aid to Cat. No. 66000. Engineered for modern cars and light trucks. Designed to handle all types of tires. Provides full 100° caster swing. Designed to be used as portable floor units or on stands, racks or pits. These turntables indicate accurate toe-out on turn angle of each wheel allowing the bottom of the wheel to turn freely while alignment adjustments are made. Use for caster and steering axis inclination measurement. Large dials are easily read from any angle and can be adjusted to zero starting position at any time. Ball bearings are enclosed in precision ground surfaces to simulate actual road conditions and allow for freedom of movement in all directions. Tapered pins hold plates firmly locked while vehicle is being driven onto turntable. Pins are attached with chain to prevent loss. Jacks are not necessary as turntables have non-skid design to minimize sliding. Supports 5,000 lbs. per wheel. Top plate motion is 3". Sold as set of two units. Shipping weight is 63 lbs. per pair. Dimensions 11" x 15" x 2".

## 61500 61600

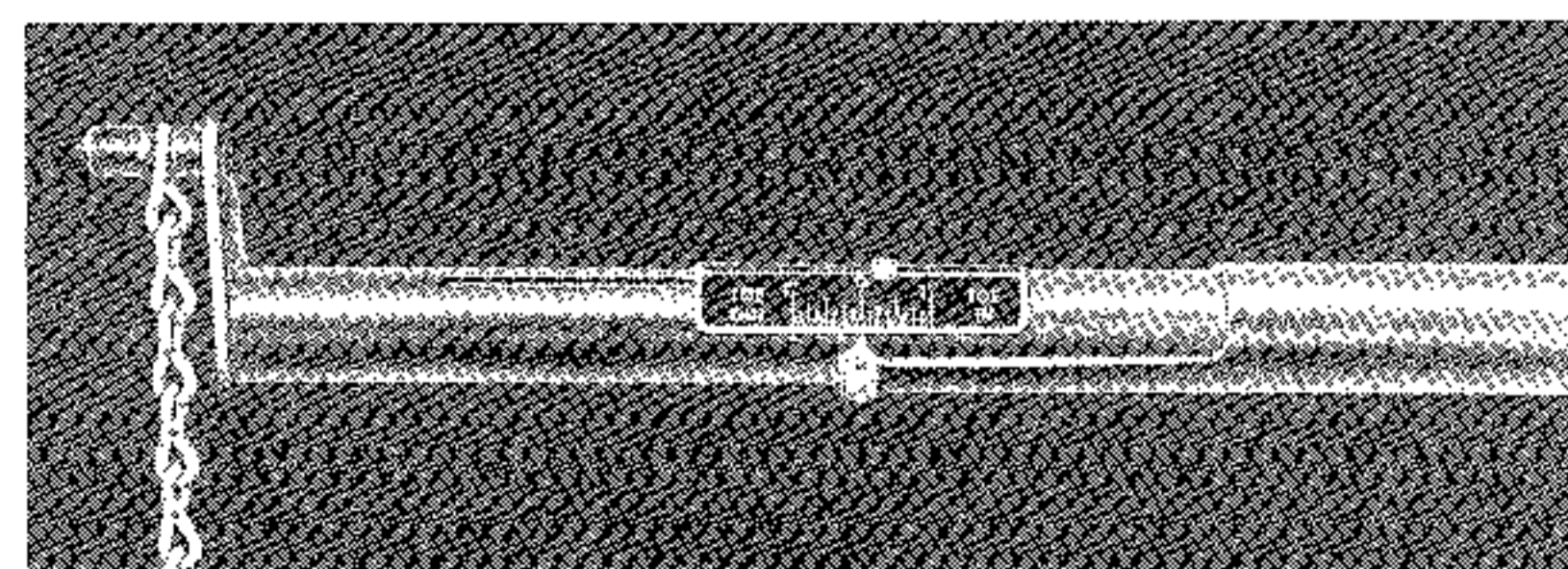

## DUBY WHEEL ALIGNING GAGES

Instant and direct "toe-in, toe-out" reading for all vehicles. Inexpensive and easy to use. Simple instructions have metric conversion scale if required. Available in two sizes:

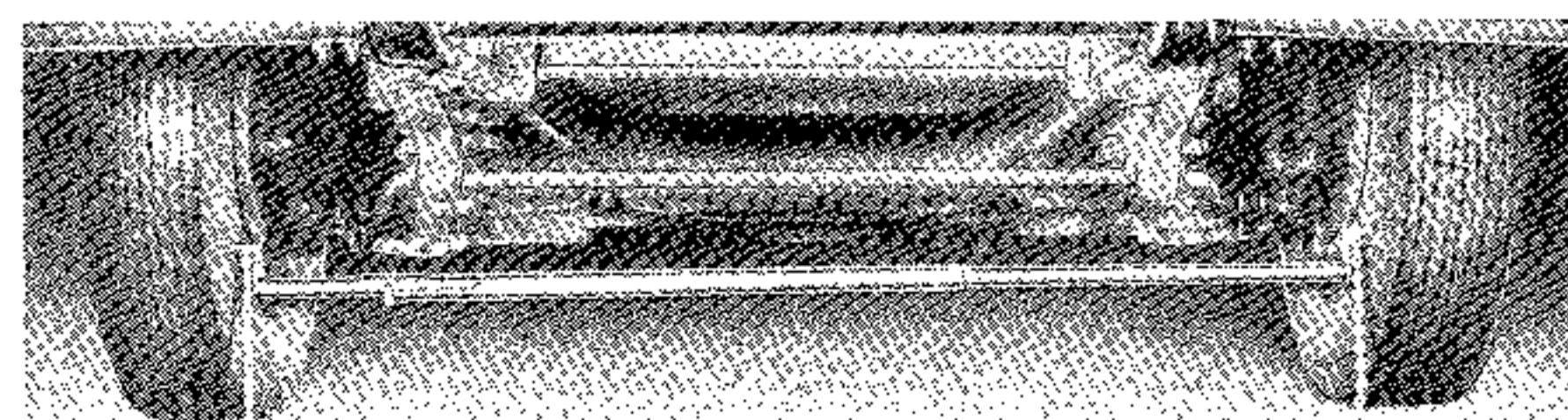

CAT NO.	APPLICATION	OPERATIONAL WIDTH RANGE
61500	Standard cars, trucks & buses	46" - 74"
61600	Standard & compact cars, light trucks	39" - 60"