

# 10' x 20'

## 3-in-1 MaxAP™ Canopy + Enclosure & Extension Kits

### Assembly Instructions

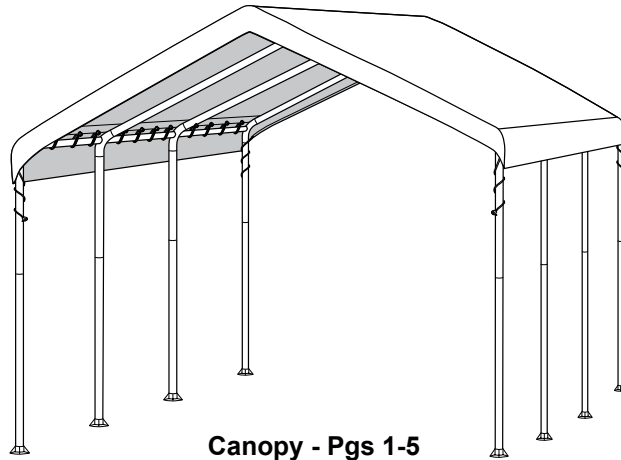

Canopy - Pgs 1-5

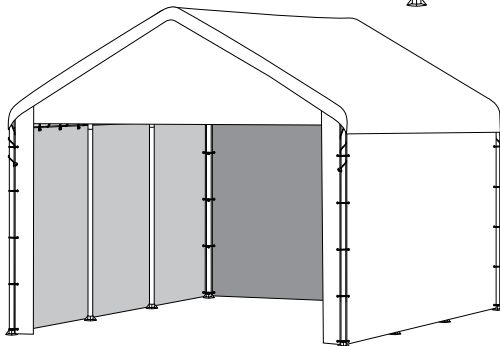

Enclosure Kit - Pgs 6-8

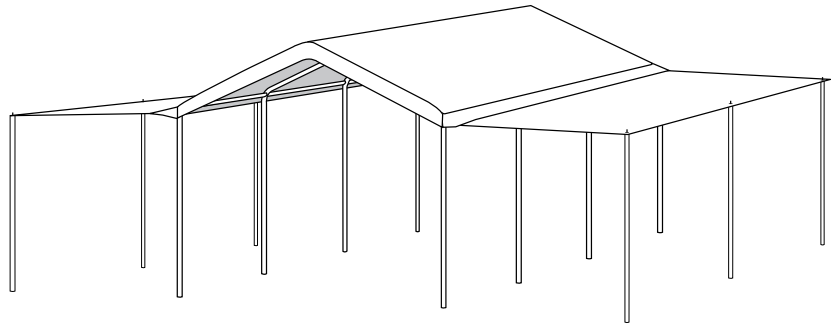

Extension Kit - Pgs 9-11

DESCRIPTION	MODEL #
3-in-1 MaxAP™ 10' x 20' Canopy - 8 Leg - White <i>Plus Enclosure &amp; Extension Kits</i>	23532 or 29532

#### RECOMMENDED TOOLS

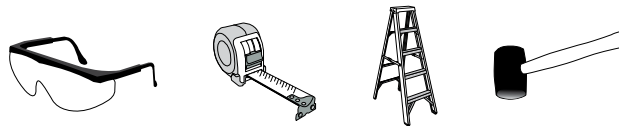

Please read instructions **COMPLETELY** before assembly. This shelter **MUST** be securely anchored. THIS IS A TEMPORARY STRUCTURE AND NOT RECOMMENDED AS A PERMANENT STRUCTURE.

**Before you start:** 2 or more individuals recommended for assembly, approximate time 3 hours.



## ATTENTION:

This shelter product is manufactured with quality materials. It is designed to fit the **ShelterLogic® Corp.** custom fabric cover included. **ShelterLogic® Corp.** Shelters offer storage and protection from damage caused by sun, light rain, tree sap and animal - bird excrement. Please anchor this **ShelterLogic® Corp.** structure properly. See manual for more anchoring details. Proper anchoring, keeping cover tight and free of snow and debris is the responsibility of the consumer. This product is not recommended for severe weather conditions. Please read and understand the installation detail, warnings and cautions prior to beginning installation. If you have any questions call the customer service number listed below. Please refer to the warranty card inside this package.

## DANGER:

Prior to installation, consult with all local municipal codes regarding installation of temporary shelters. Choose the location of your shelter carefully. **DANGER: Keep away from electrical wires.** Check for overhead utility lines, tree branches or other structures. Check for underground pipes or wires before you dig. DO NOT install near roof lines or other structures that could shed debris onto your shelter. DO NOT hang objects from the roof or support cables.

## WARNING:

Risk of fire. DO NOT smoke or use open flame devices (including grills, fire pits, deep fryers, smokers or lanterns) in or around the shelter. DO NOT store flammable liquids (gasoline, kerosene, propane, etc.) in or around your shelter. Do not expose top or sides of the shelter to open fire or other flame source.

## CAUTION:

Use **CAUTION** when erecting the frame. Use safety goggles during installation. Secure and bolt together overhead poles during assembly. Beware of pole ends.

## PROPER ANCHORING AND INSTALLATION OF FRAME:

### PROPER ANCHORING OF THE FRAME IS THE RESPONSIBILITY OF THE CONSUMER.

**ShelterLogic® Corp.** is not responsible for damage to the unit or the contents from acts of nature. Any product that is not anchored securely has the potential to fly away causing damage, and is not covered under the warranty. Periodically check the anchors to ensure stability. **ShelterLogic® Corp.** cannot be responsible for any product that blows away. **NOTE:** *Your product's cover can be quickly removed and stored prior to severe weather conditions.* If strong winds or severe weather is forecast in your area, we recommend removal of cover.

## REPLACEMENT PARTS, ASSEMBLY, SPECIAL ORDERS:





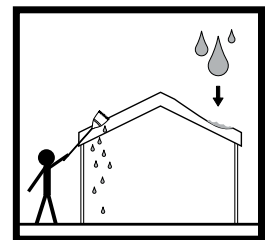
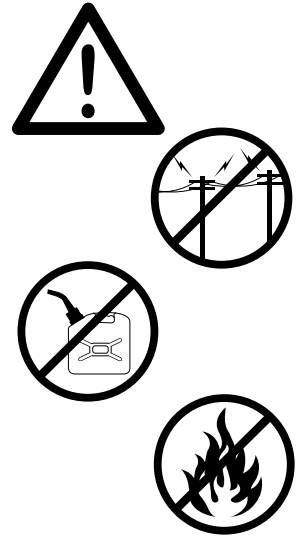

Genuine **ShelterLogic® Corp.** replacement parts and accessories are available from the factory, including anchoring kits for nearly any application, replacement covers, wall and enclosure kits, frame parts, zippered doors and other accessories. All items are shipped factory direct to your door.

## CARE AND CLEANING:

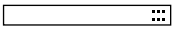
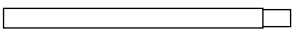
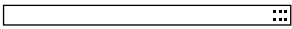
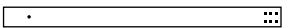
A tight cover ensures longer life and performance. Always maintain a tight cover. Loose fabric can accelerate deterioration of cover fabric. Immediately remove any accumulated debris from the roof structure with a broom, mop or other soft-sided instrument. Use extreme caution when removing debris from cover- always remove from outside the structure. DO NOT use hard-edged tools or instruments like rakes or shovels to remove debris. This could result in punctures to the cover. DO NOT use bleach or harsh abrasive products to clean the fabric cover. Cover is easily cleaned with mild soap and water.

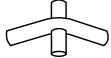

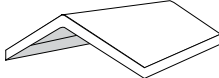
# 3-in-1 MaxAP™ 10' x 20' Canopy + Enclosure & Extension Kits - Parts List - Model #23532 or 29532

Description of Parts:		Quantity	Part #
	Rafter Poles 24 <sup>3</sup> / <sub>8</sub> in. / 61,9 cm	8	13104
	Cross Rails 40 <sup>11</sup> / <sub>16</sub> in. / 103,3 cm	25	13103
	Cross Rails 39 <sup>1</sup> / <sub>2</sub> in. / 100,3 cm	9	13107
	Leg Poles 39 in. / 99 cm	8	13105
	3 - Way Frame Connectors	6	13101
	4 - Way Frame Connectors	6	13102
	Bungee Cords	24	10066
	Cover	1	10072
	Base Feet	8	802916
	Temporary Spike Anchors	8	10431
<b>See Pages 6 - 8</b>	Enclosure Kit	1	
<b>See Pages 9 -11</b>	Extension Kit	1	

## 1. LAY OUT ROOF FRAME

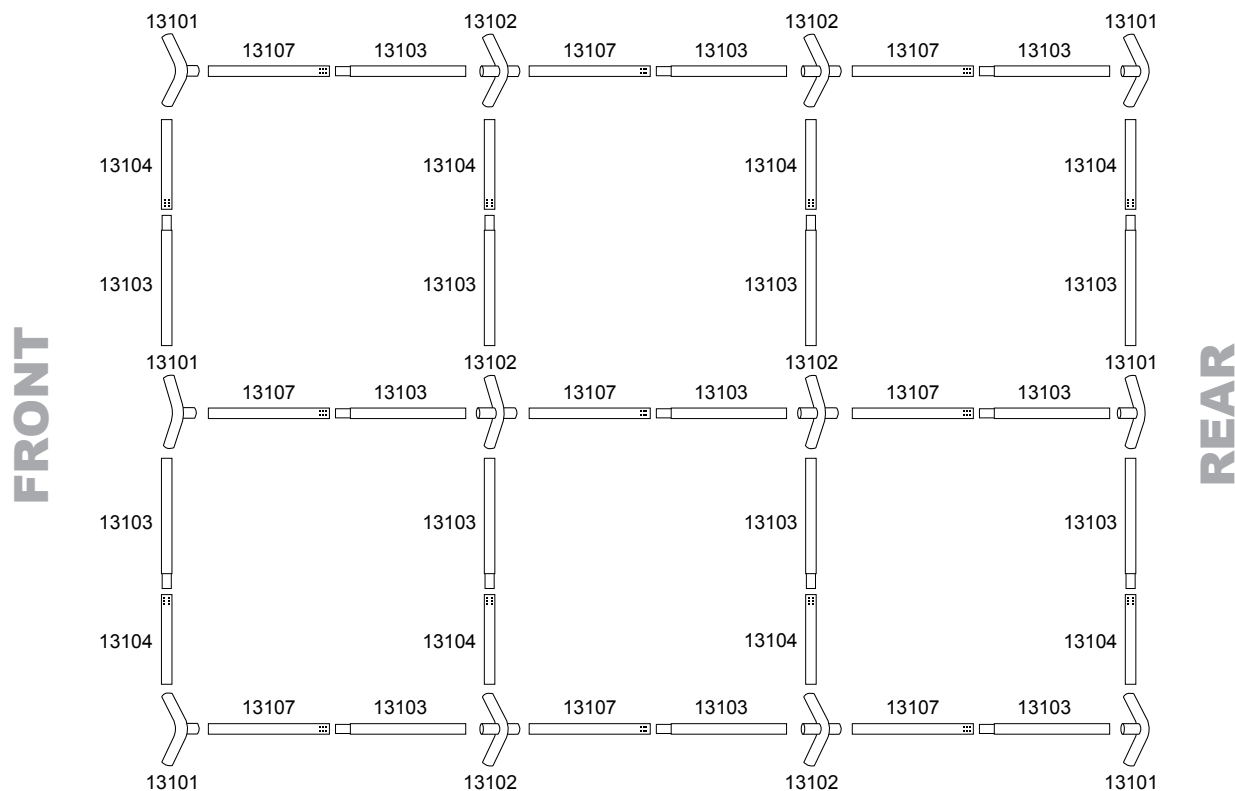

## 2. ASSEMBLE ROOF FRAME

NOTE: Swedged tubes insert into plain ends at the crimp marks.

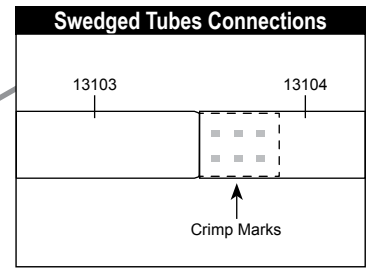
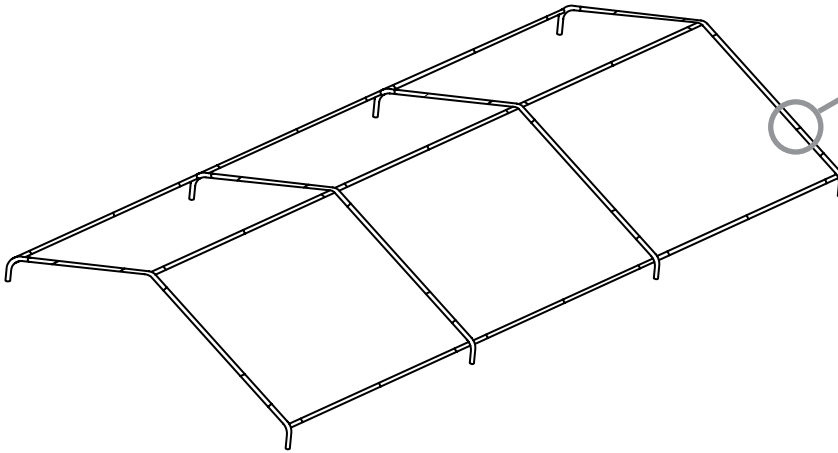

## 3. ASSEMBLE LEGS & ATTACH TO ROOF FRAME

Attach all legs to one side first. Let the other side of roof frame rest on the ground. Repeat for opposite side.

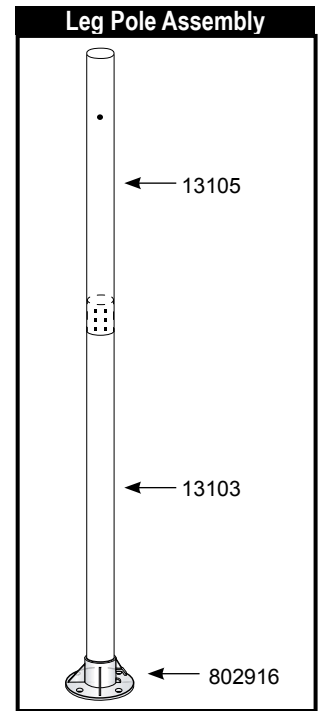
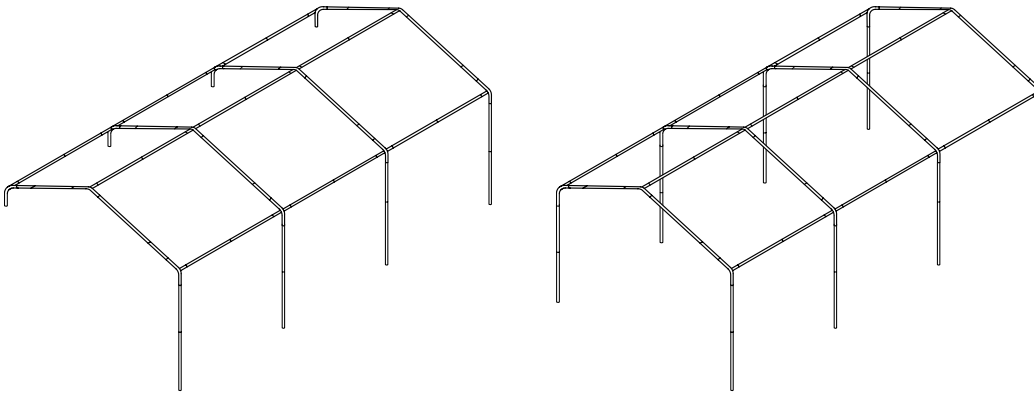

## 4. ANCHOR THE FRAME

There are four holes on each base foot that the anchor can go into.

- A.** Select a hole in each base foot. Insert each anchor (10431) into the ground until the round head is touching the base foot. These anchors prevent the canopy from shifting. Insert one anchor into all four base feet. *This is a temporary spike anchor. Not intended for permanent use.*
- B.** To securely anchor canopy, Accessory Anchoring Kit #10073 is recommended. The 4-anchor pins are inserted into the ground. Then the ropes are tied from the anchors to the corner tees as shown in **B**.

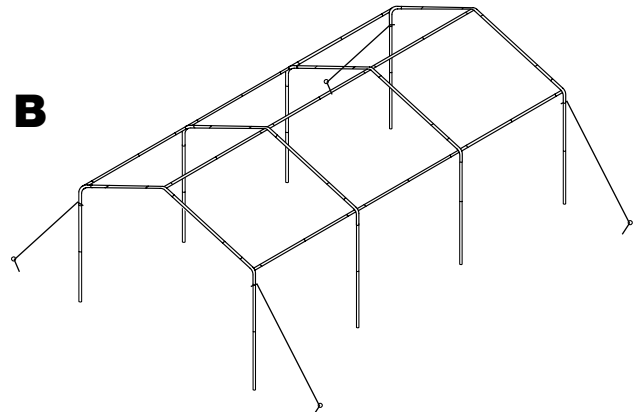
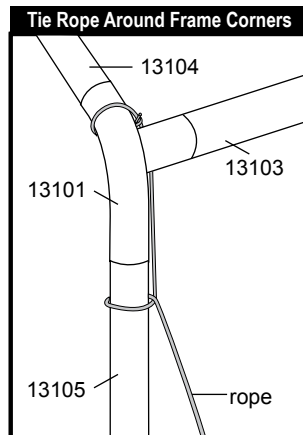
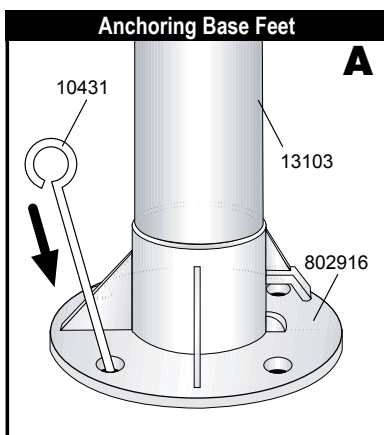

## 5. PLACE COVER AND SECURE TO CANOPY FRAME

- A. Place cover over assembled roof frame with grommet panels facing down, aligned with cross rails.
- B. Make sure the cover is properly aligned on the frame, secure the four corners of the cover with bungees (10066) to the frame first. Attach remaining bungees.

*Re-adjust bungees position along cross pole as needed to ensure a tight and even fit of the cover to the frame.*

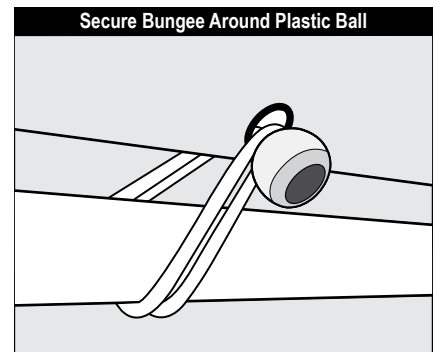
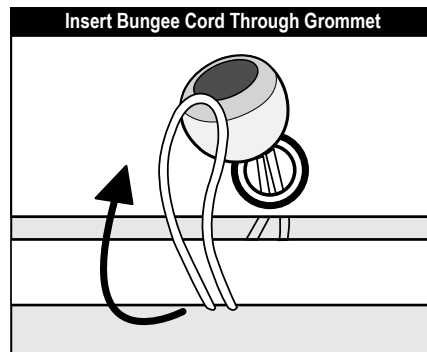
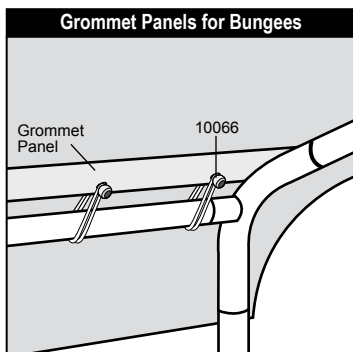
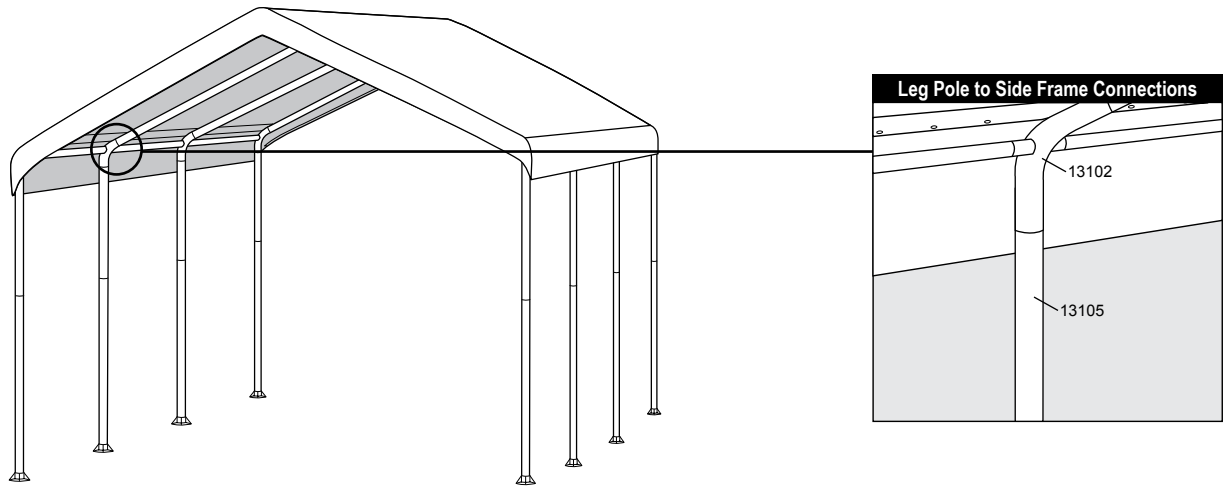

## 6. TIGHTEN THE COVER WITH TWIST TITE™

- A. Wrap the cord with plastic ball and "S" hook at the corners of the cover around the corner leg poles. Insert "S" hook into the hole of the corner leg poles.
- B. Twist each leg pole toward the inside of the shelter until the cover becomes tight. Twist the leg poles equally to ensure the cover stays aligned during tightening.

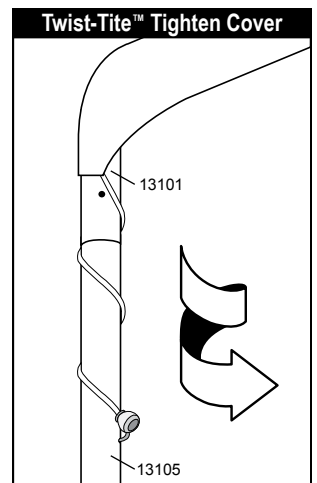

# 10' x 20'

## MaxAP™ Canopy Enclosure Kit

### Assembly Instructions

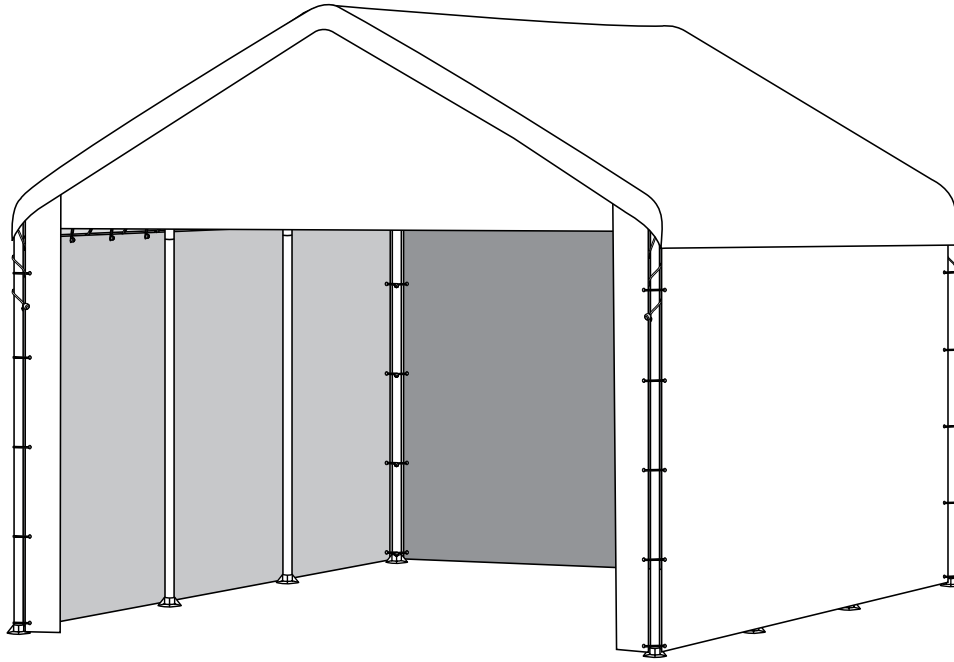





#### RECOMMENDED TOOLS

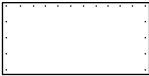

Before you start: 2 or more individuals recommended for assembly, approximate time 1 hour.

#### MaxAP™ 10' x 20' Canopy Enclosure Kit - Parts List

Description of Parts:	Quantity	Part #
 <span style="margin-left: 100px;">Side Walls</span>	2	12082
 <span style="margin-left: 100px;">Back Panel</span>	1	10085
 <span style="margin-left: 100px;">Double Zipper Door Panel</span>	1	10086
 <span style="margin-left: 100px;">Bungee Cords</span>	80	10066

**NOTES:**

- Canopy Enclosure panels attach to frame with bungee cords.
- Leave Canopy Cover bungees in place when attaching Enclosure panels.

**CAUTION:** Bungee Cords are under extreme tension. Use Caution when installing. Safety glasses are recommended to prevent injury.

**1. ATTACH SIDE WALLS TO FRAME**

- A. If tightened at corner leg poles, disengage the TwistTite™ cord and “S” hook from canopy cover and corner legs. Re-tighten **after** all Enclosure panels have been secured, as shown in Step 3.
- B. Attach the extension panels with bungees to the cross rails at the top first. Adjust the panels as needed to ensure a tight and even fit before securing to the leg poles.

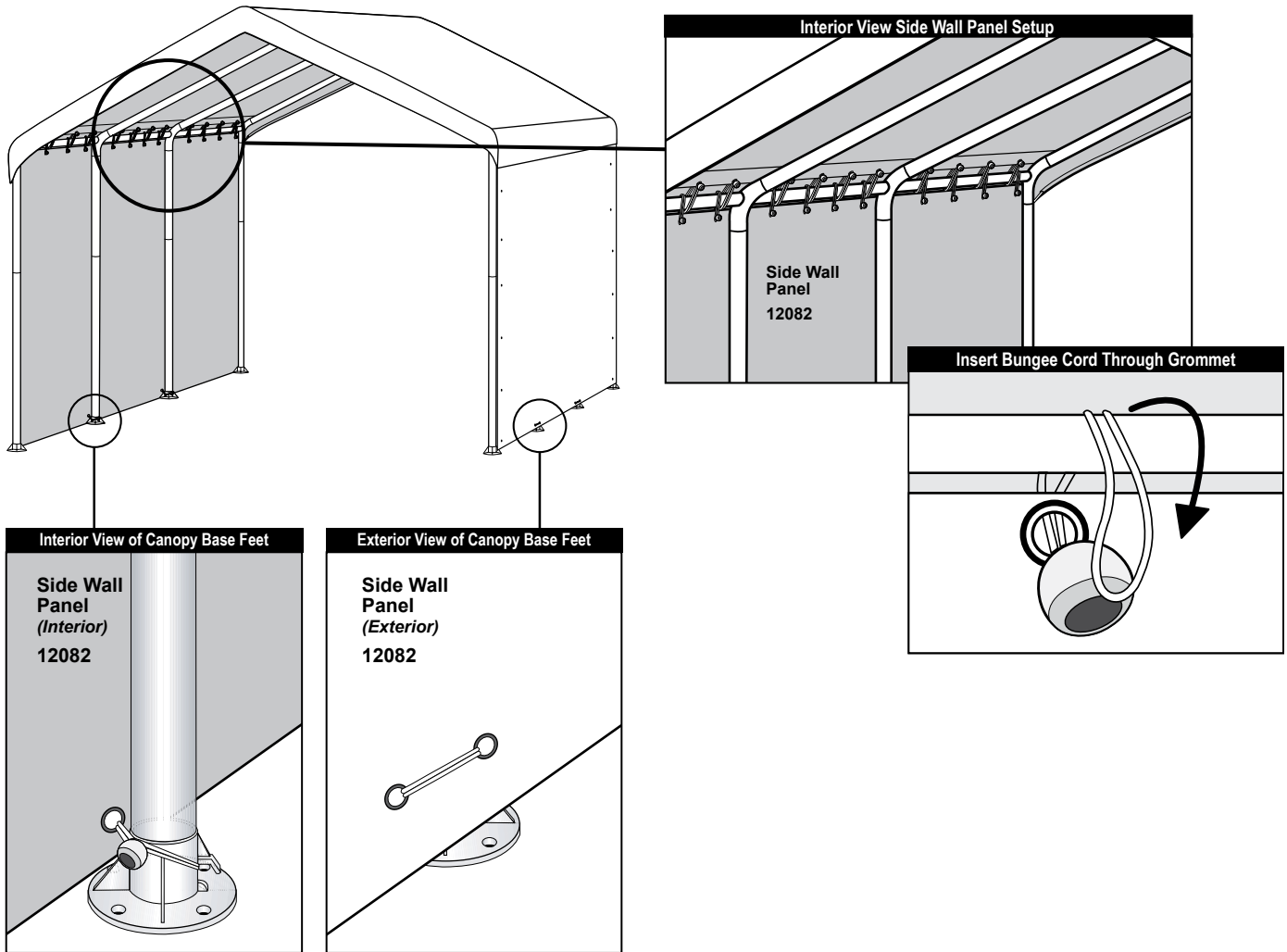

## 2. ATTACH ENCLOSURE END AND ZIPPER DOOR PANELS

When securing enclosure panels to corner legs, note that each bungee is shared with the neighboring panel.

**NOTE:** Door panels zippers must be closed when securing door panel.

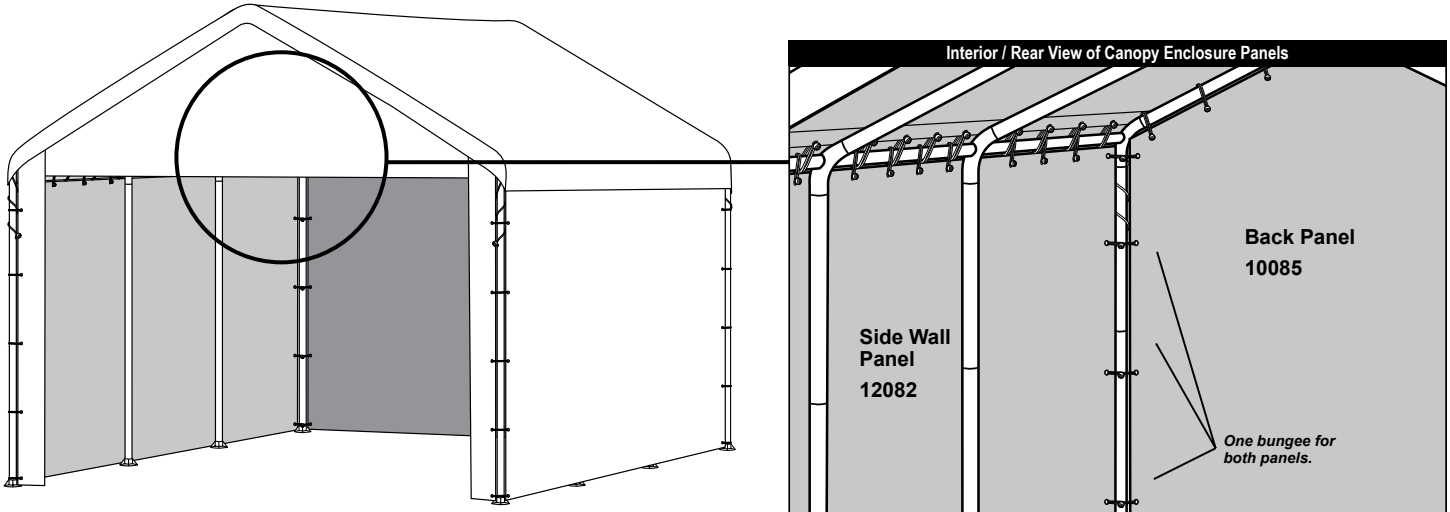

## 3. TIGHTEN THE COVER WITH TWIST TITE™

- A. Wrap the cord with plastic ball and "S" hook at the corners of the cover around the corner leg poles. Insert "S" hook into the hole of the corner leg poles.
- B. Twist each leg pole toward the inside of the shelter until the cover becomes tight. Twist the leg poles equally to ensure the cover stays aligned during tightening.

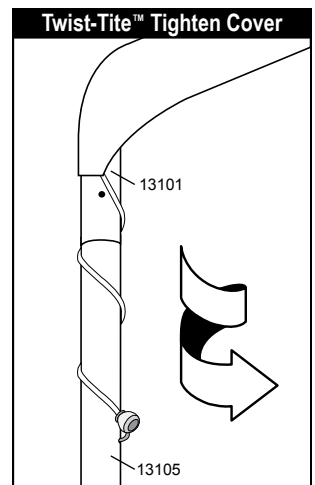



# 10' x 20'

## MaxAP™ Canopy Extension Kit

### Assembly Instructions

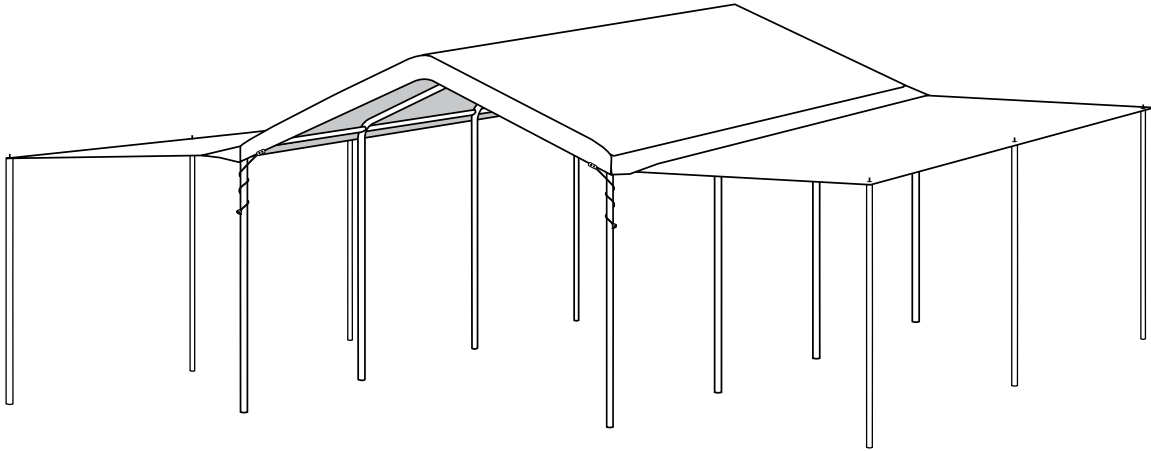



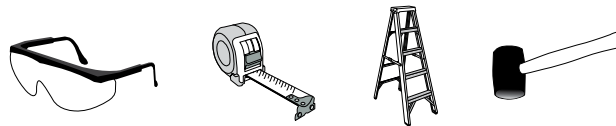





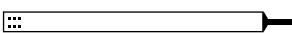
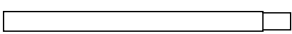

#### RECOMMENDED TOOLS

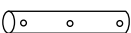

Before you start: 2 or more individuals recommended for assembly, approximate time 1 hour.

#### MaxAP™ 10' x 20' Canopy Extension Kit - Parts List

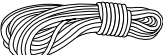
Description of Parts:	Quantity	Part #
 Tent Poles, top 38 1/2 in. / 97,8 cm	6	10458
 Tent Poles, bottom 40 3/16 in. / 102,1 cm	6	10459
 Bolts 1/4 x 1 1/2 in.	8	03025
 Wing Nut	8	07000
 Bungee Cords	50	10066
 Extension Panel	2	12082
 Tetherball	4	10465
 "S" Hook	4	10464
 Ropes 3'	4	10463
 Temporary Spike Anchors	6	10447
 Rope Toggle	6	10436
 Clamp	8	10462
 Guy Ropes 11'	6	10437

**NOTES:**

- Canopy extension panels attach to frame cross rails with bungee cords.
- Leave Canopy Cover bungees in place when attaching extension panels.
- Extension panels will not allow the canopy cover TwistTite mechanism to properly tighten the cover when extended. An alternate TwistTite Clamp system is included with this kit and shown in Step 5.

**1. ATTACH SIDE WALLS TO FRAME**

- A. If tightened at corner leg poles, disengage the TwistTite™ cord and “S” hook from canopy cover and corner legs. Wrap up TwistTite™ cord and secure inside the shelter with one of the cover panel bungee cords.
- B. Attach the extension panels with bungees to the cross rails at the top first. Adjust the panels as needed to ensure a tight and even fit before extending panel and securing to the tent poles.

**CAUTION: Bungee Cords are under extreme tension. Use Caution when installing. Safety glasses are recommended to prevent injury.**

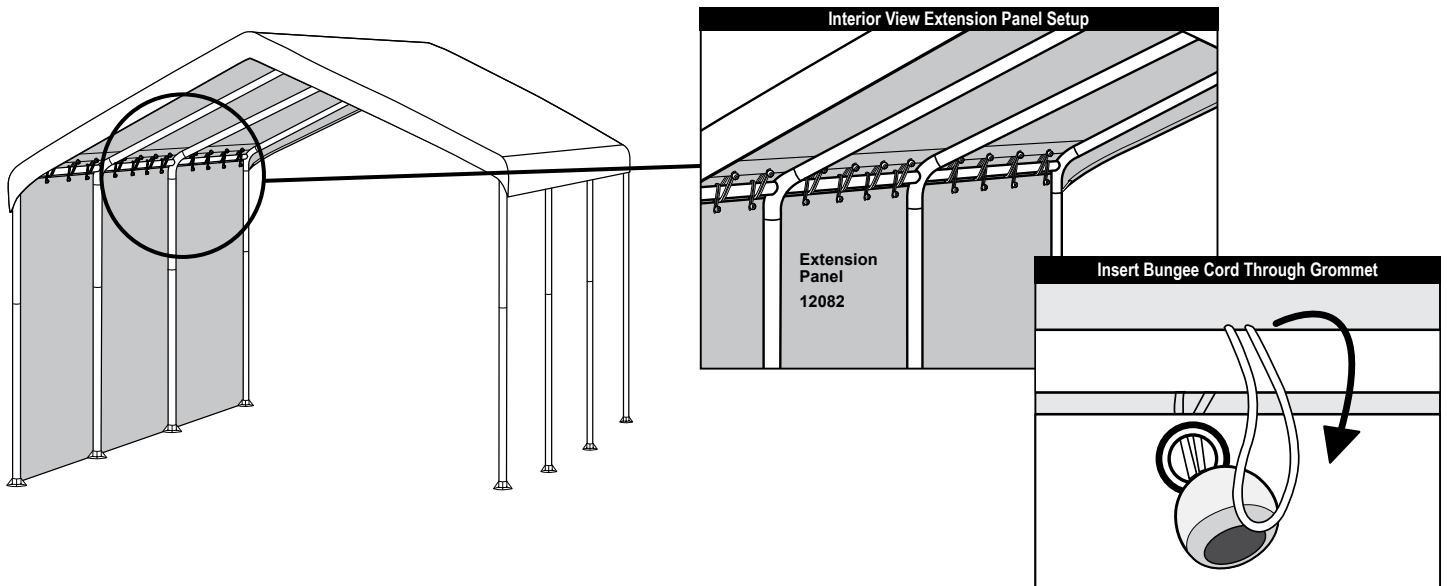

**2. ASSEMBLE EXTENSION PANEL TENT POLES**

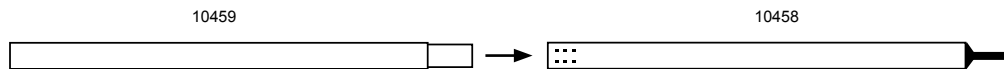

**3. RAISE EXTENSION PANELS AND ATTACH TENT POLES**

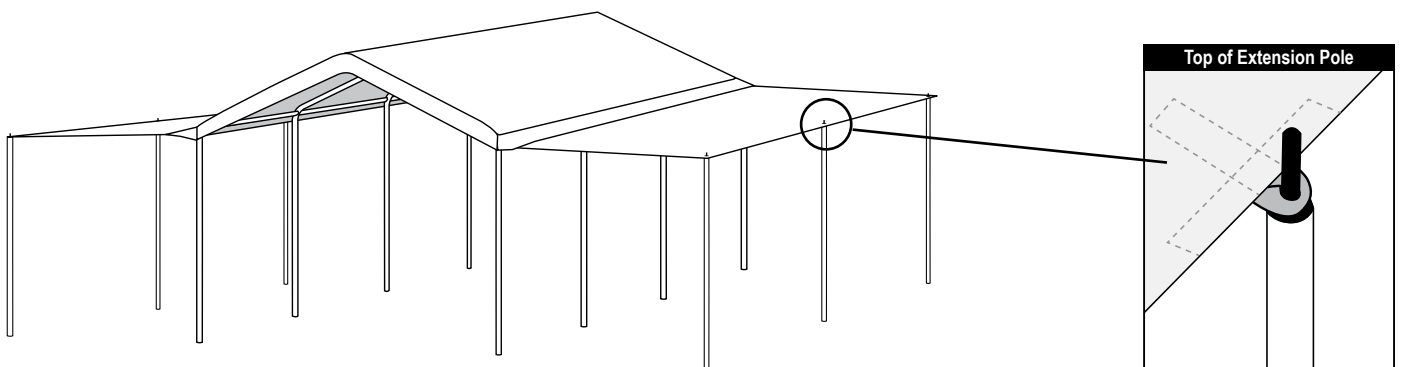

## 4. ANCHORING AND ROPE TOGGLES

- A. Thread the Guy Ropes 10437 through the Rope Toggle 10436 as shown below. Tie a knot at the end of the rope to keep it from sliding out of the rope toggle.
- B. Make a loop knot at the other end of the rope and place it over the tab the the top of the tent pole.
- C. Place the anchor securely in the ground about 3' from each tent pole.
- D. Tighten anchor rope with rope toggle.

***This is a temporary spike anchor. Not intended for permanent use.***

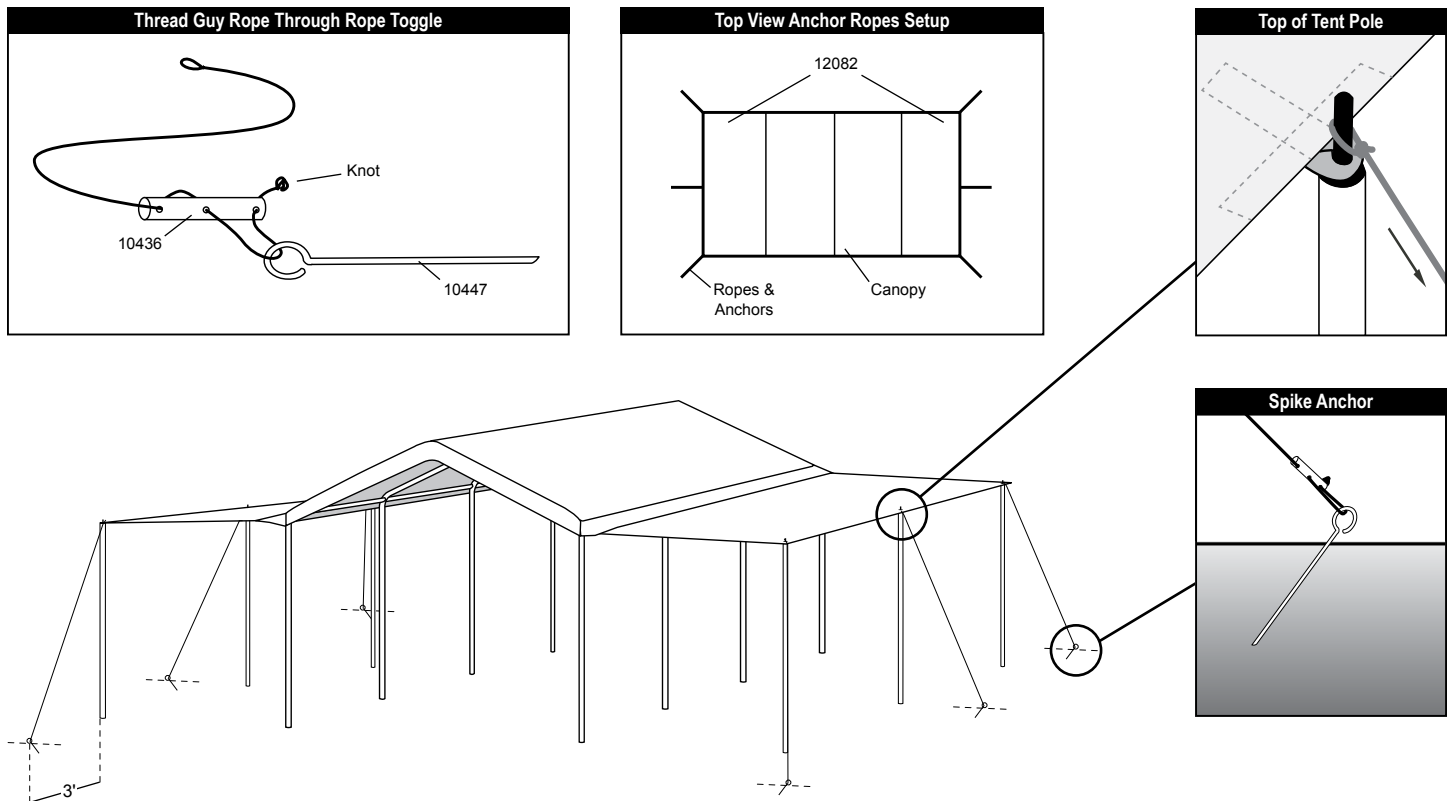

## 5. TIGHTEN THE COVER WITH CLAMP TWIST TITE™

- A. Mount the clamp and new TwistTite™ cable so it holds onto the rope that is still threaded through the canopy cover edges.
- B. The clamp should be mounted approximately 6" to 10" up from the corners.
- C. Wrap the cord with plastic ball and "S" hook at the corners of the cover around the corner leg poles. Insert "S" hook into the hole of the corner leg poles.
- D. Twist each leg pole toward the outside of the shelter until the cover becomes tight.

***Twist the leg poles equally to ensure the cover stays aligned during tightening.***

