

**3401403**

Power Steering Pressure Line Hose Assembly

General Installation Instructions**Inspect Steering System**

Check Fluid, Hoses, and Lines for the following...

- Physical Damage (Hoses and Lines near heat or friction sources such as manifolds, engine block, exhaust, or pulleys)
- Leakage (most noticeable near fittings or hose ends)
- Hose hardness (Internal wear may cause rubber to be brittle or flaking)
- Hose softness (Internal deterioration may cause rubber to feel spongy or too soft)
- Fluid discoloration (Particles may be present from internal hose and component wear causing the fluid to appear dark, resulting in blockage)

To ensure a healthy power steering system, it is best to replace all hoses and lines together. New power steering fluid is a necessity to ensure proper performance and long life of the system. Be sure to properly dispose the old fluid.

Hose / Line Removal

- Most hoses are removed with a wrench or screwdriver. It may be helpful to apply an anti-corrosion spray ahead of time to negate the effects of road grime and heat cycles
- Expect old fluid to spill or leak; using a catch pan and/or drop cloth is recommended

Hose / Line Installation

- Pressure Hose; Hand tighten the threaded fitting or banjo bolt (both ends). Then tighten with a wrench to proper specs. Specs will vary based on vehicle, so consult a repair manual if possible
- Return Hose; Hand tighten threaded fitting first (if applicable); then tighten with a wrench. Secure clamped hose connection/s... put loose clamp on hose, then push hose over barbed or nipple end of steel line. Slide clamp into position, then tighten with a screw driver or small socket

*** (tip - with your finger, apply a small amount of power steering to end of steel line. This will act as a lubricant to slide the hose in place if needed) ***

Flush or Bleed the System

- Locate the Return Line at the Power Steering Pump
- Remove the Return Line from the pump, and place the end into a catch/drain pan
- Use included plastic flushing cap on the pump. It will block the tube/fitting from the removed return line
- Fill the reservoir with the proper power steering fluid and start the engine
- With the engine running, turn the steering wheel from side to side (lock to lock)
- Continue to fill the reservoir as required until the power steering fluid is clear
- Turn the engine off, remove the flushing cap from the pump, and reinstall the return line on the pump
- Check the fluid level after some operating time and fill if needed

O-Ring Installation

O-ring(s) are a vital part of the success of your new hose not leaking. We include new O-Rings in all our hose kits where they are required. If you do not install them and install them properly, your hose is prone to leak. Lubricate the O-Rings with silicone grease. This will help the O-Ring slide over the end of the fittings easier. Do not use excessive force that could cut or damage the O-Ring. Check to see that the O-Rings sits firmly in the end of the fitting.

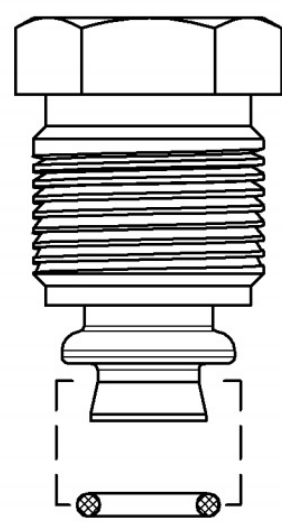

Standard O-Ring Flare

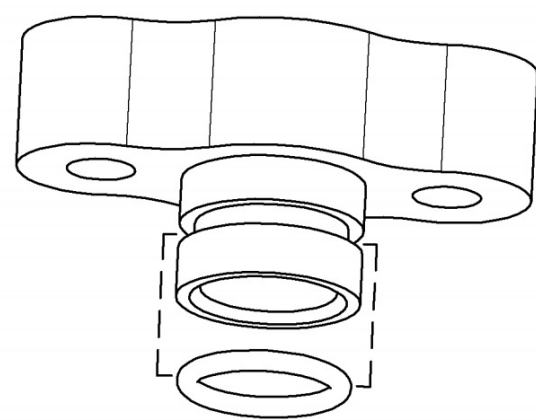

Captive O-Ring

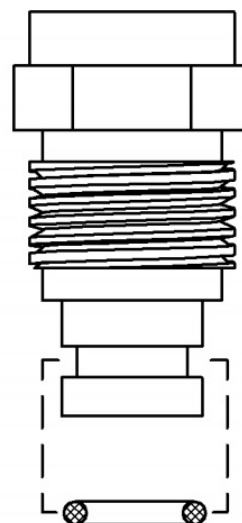

Swivel O-Ring Type I

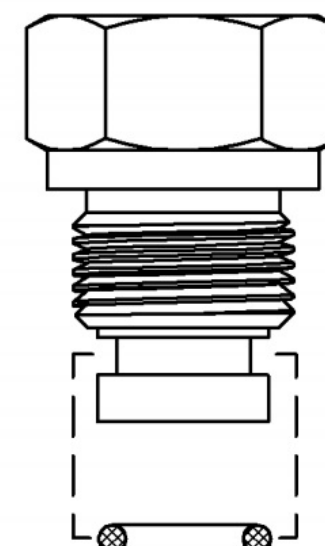

Swivel O-Ring Type II

Power Steering Pressure Switch

Some applications of this hose require the use of a Power Steering Pressure Switch.

If your vehicle is equipped with a Power Steering Pressure Switch, remove the switch from the old hose, clean the threads and install the switch in the port on the new hose, shown below. Tighten the switch to prevent leakage.

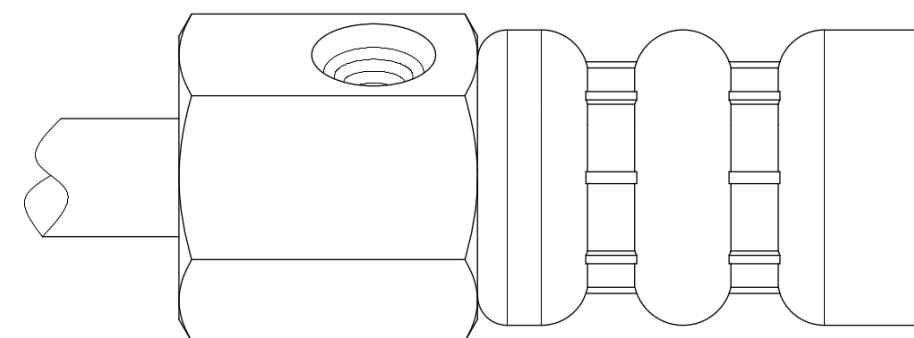
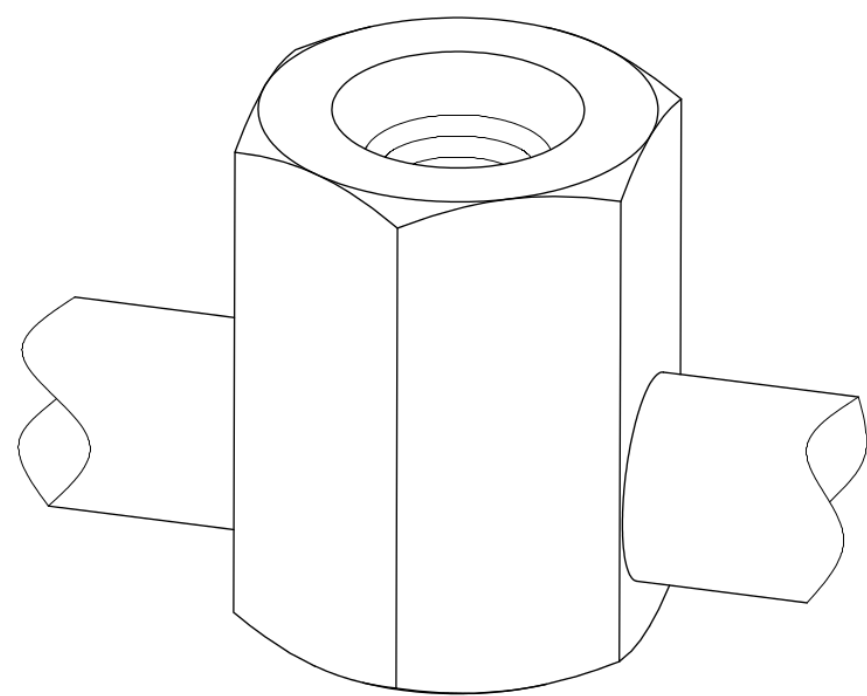

If your vehicle **does Not** have a Pressure Switch, insert the plug included with your hose in the port And tighten.

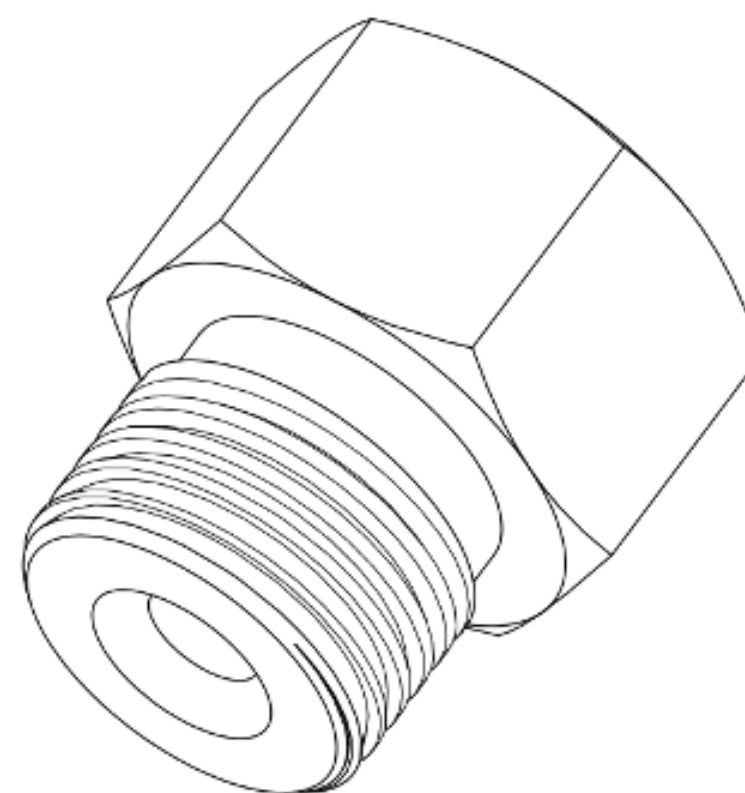
**Universal Pressure Switch**

WARNING! This hose is designed for vehicles with a pressure switch (sensor) but will also work for vehicles without a pressure switch. If your vehicle does **not** use a pressure switch, you must **block the switch port** by installing the plug which is included with this hose. Otherwise fluid will leak from the open port.

Sunsong accepts no liability for the content of this Tech Tip, or for the consequences of any actions taken on the basis of the information provided. We suggest that you **always** consult a **Repair Manual** or **Professional Technician**.

© 2018 - Sunsong NA, Inc.