



3402318

Power Steering Pressure Line Hose Assembly

General Installation Instructions

Inspect Steering System

Check Fluid, Hoses, and Lines for the following...

- Physical Damage (Hoses and Lines near heat or friction sources such as manifolds, engine block, exhaust, or pulleys)
- Leakage (most noticeable near fittings or hose ends)
- Hose hardness (Internal wear may cause rubber to be brittle or flaking)
- Hose softness (Internal deterioration may cause rubber to feel spongy or too soft)
- Fluid discoloration (Particles may be present from internal hose and component wear causing the fluid to appear dark, resulting in blockage)

To ensure a healthy power steering system, it is best to replace all hoses and lines together. New power steering fluid is a necessity to ensure proper performance and long life of the system. Be sure to properly dispose the old fluid.

Hose / Line Removal

- Most hoses are removed with a wrench or screwdriver. It may be helpful to apply an anti-corrosion spray ahead of time to negate the effects of road grime and heat cycles
- Expect old fluid to spill or leak; using a catch pan and/or drop cloth is recommended

Hose / Line Installation

- Pressure Hose; Hand tighten the threaded fitting or banjo bolt (both ends). Then tighten with a wrench to proper specs. Specs will vary based on vehicle, so consult a repair manual if possible
- Return Hose; Hand tighten threaded fitting first (if applicable); then tighten with a wrench. Secure clamped hose connection/s... put loose clamp on hose, then push hose over barbed or nipple end of steel line. Slide clamp into position, then tighten with a screw driver or small socket

*** (tip - with your finger, apply a small amount of power steering to end of steel line. This will act as a lubricant to slide the hose in place if needed) ***

Flush or Bleed the System

- Locate the Return Line at the Power Steering Pump
- Remove the Return Line from the pump, and place the end into a catch/drain pan
- Use included plastic flushing cap on the pump. It will block the tube/fitting from the removed return line
- Fill the reservoir with the proper power steering fluid and start the engine
- With the engine running, turn the steering wheel from side to side (lock to lock)
- Continue to fill the reservoir as required until the power steering fluid is clear
- Turn the engine off, remove the flushing cap from the pump, and reinstall the return line on the pump
- Check the fluid level after some operating time and fill if needed

O-Ring Installation

O-ring(s) are a vital part of the success of your new hose not leaking. We include new O-Rings in all our hose kits where they are required. If you do not install them and install them properly, your hose is prone to leak. Lubricate the O-Rings with silicone grease. This will help the O-Ring slide over the end of the fittings easier. Do not use excessive force that could cut or damage the O-Ring. Check to see that the O-Rings sits firmly in the end of the fitting.

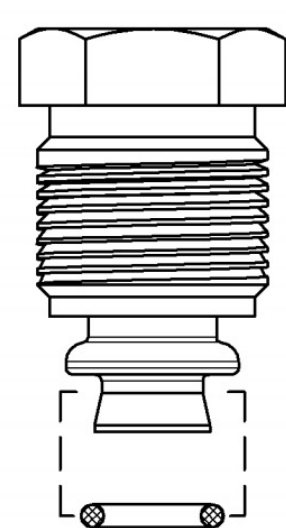

Standard O-Ring Flare

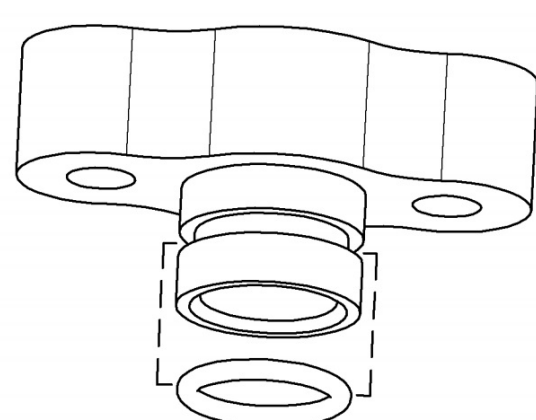

Captive O-Ring

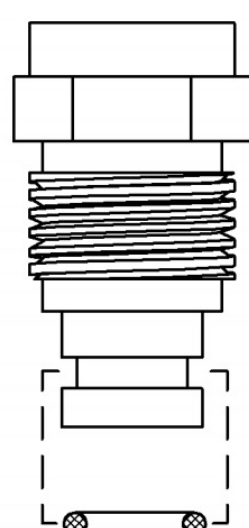

Swivel O-Ring Type I

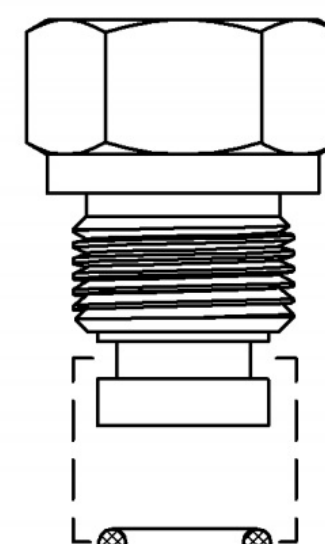

Swivel O-Ring Type II

GM O-Ring and Clamp

On this application GM uses special fittings that requires the use of a clamp and bolt to mount one end of the hose to the rack.

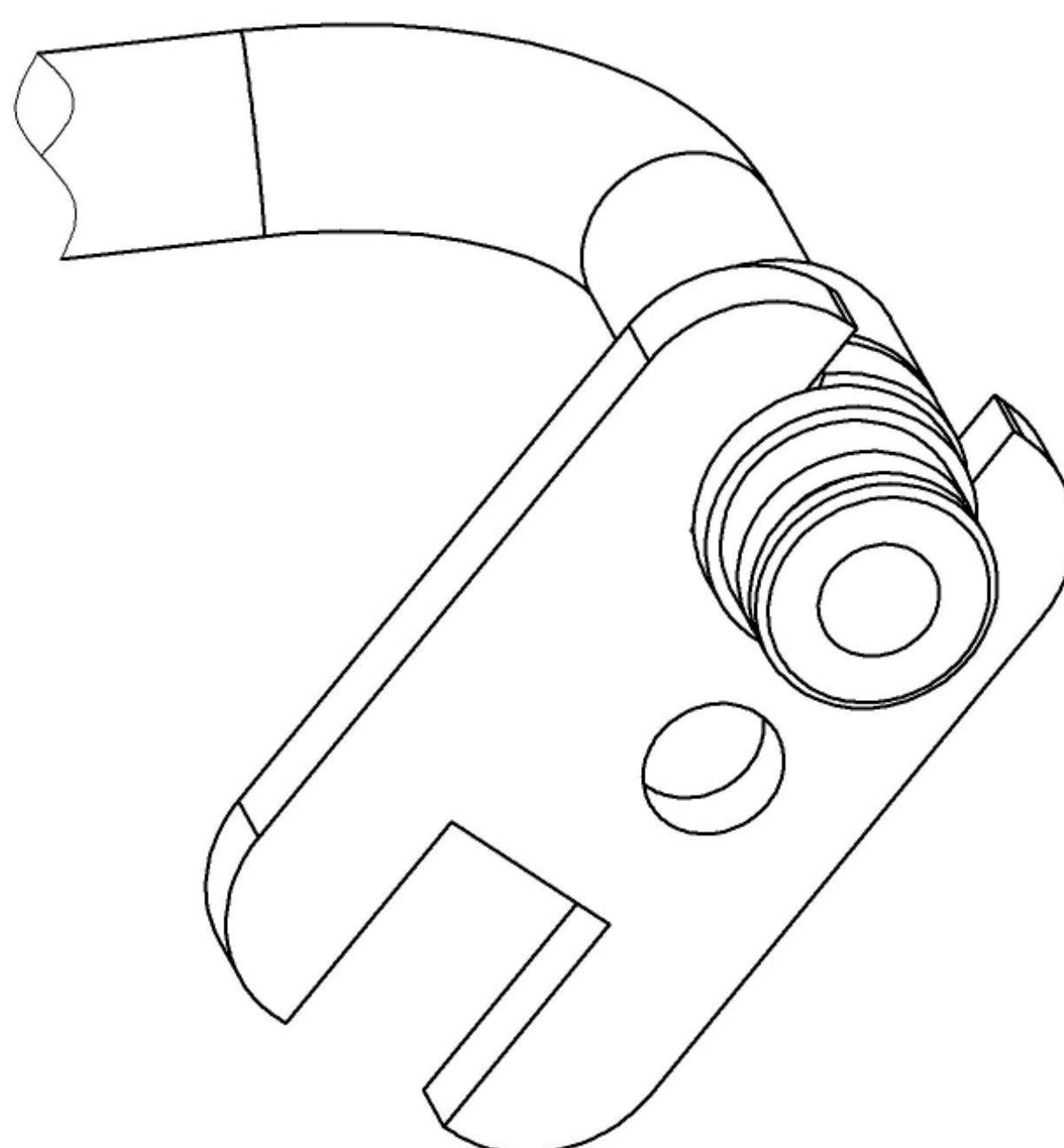

You will need to remove the bolt from the clamp And pull the hose out of the port. Be sure to check And see that the O-Ring from the old hose Is Not left in the port hole. If so, remove old O-Ring before installing New hose. Apply some silicone grease to the New O-Ring And slide the clamp into place on the hose fitting. (See drawing above) Install clamp around second hose And bolt into place.

Tighten bolt securely to prevent leakage.

GM Steering Line Fitting Seals

This hose is provided with a 'duck-bill' style oil seal for replacement of the current oil seal which will be of the same style. Prior to installing the new pressure hose, the old oil seal must be removed from the steering gear pressure port and replaced with the new seal. The 'duck bill' style oil seal, after installing in the steering gear, is 'pierced' by the power steering pressure line during installation of the pressure line



IMPORTANT: When removing the old oil seal from the pressure port, **do not** remove the seal with tools such as screwdrivers, picks, or awls as they are likely to scratch the housing bore causing leaks, and require steering gear replacement. GM recommends using their tool J-42640 for removing the seal. See instructions below.

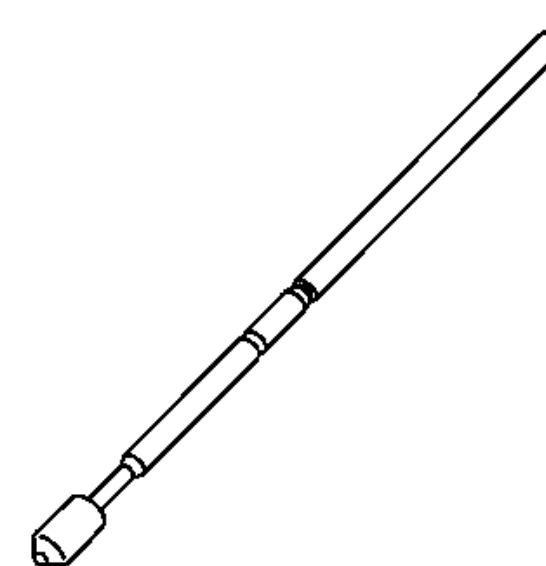
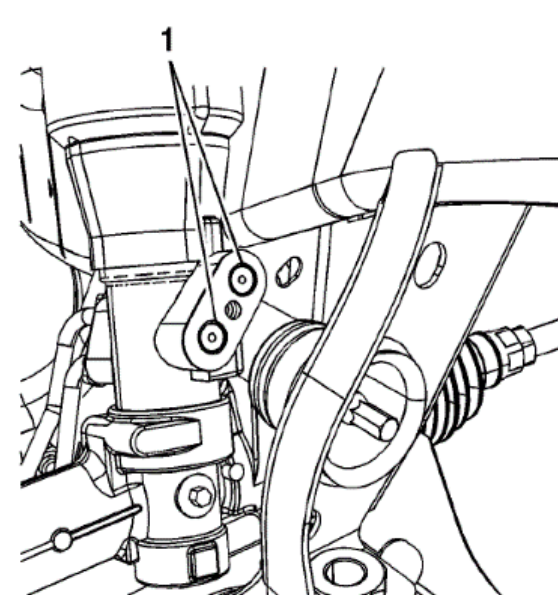

GM Technical Service Bulletin No. 07-02-32-002N Sept. 11, 2013 states: IMPORTANT: Only insert J-42640 just far enough in to the duck bill seal to get behind the duck bill seal's steel ring. Then using the tool, pry against the steel ring to remove the seal. Do not insert the tool too far into the duck bill seal and pry against the housing bore. Prying against the housing bore could scratch the housing bore and require steering gear replacement.

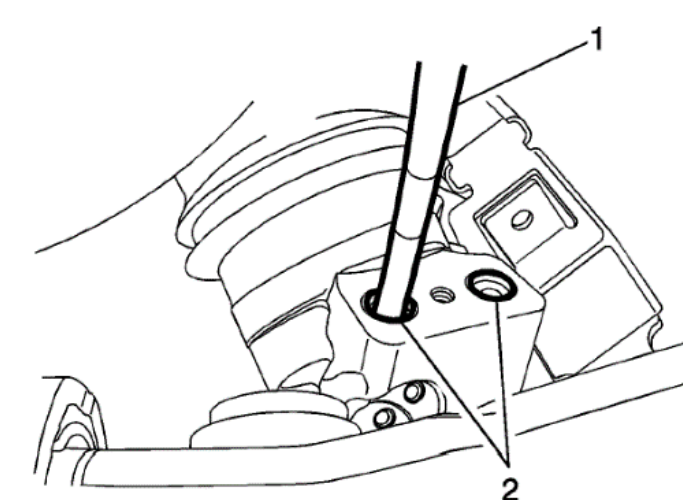

Sunsong accepts no liability for the content of this Tech Tip, or for the consequences of any actions taken on the basis of the information provided. We suggest that you **always** consult a **Repair Manual** or **Professional Technician**.

© 2018 - Sunsong NA, Inc.