

MB MITTLER BROS. MACHINE & TOOL

TANNER
Racing Products *By* **MB**
MITTLER BROS. MACHINE & TOOL



2016

SHAPING THE WORLD SINCE 1980



A few words from our President:

To those of you who have read this page many times, thank you, and to first time readers, welcome and thank you for your interest in our company. Without all of you, none of this would be possible - THANK YOU FOR YOUR BUSINESS!

We have added a number of new products this year and hope you'll find them useful in your work. We are always open to your input and suggestions for new products.

Once again, thank you for allowing me the privilege of this bully pulpit. While we gained a majority in the Senate and strengthened the majority in Congress, we still have an out of control President who acts independently, has no respect for Congress, the rule of law or the majority of the American people. We face a very important election in 2016 and I urge you and everyone in your sphere of influence to TURN OUT AND VOTE! It is important that you make your voice heard.

As you view the candidates I also suggest that you think about the future you want not only for yourself, but also for your children and grandchildren. Do you want a larger government that takes more of what you work hard for or a smaller, less imposing government? I think I know what many independent, entrepreneurial business owners will want. So again, I suggest you break all the rules and talk to your family, employees and other groups that you are a part of to tell your own story and who you think is the best candidate for the job.

I wish you and yours the very best in 2016. I am reminded of what my good friend Joseph tells me in every email he sends – “Do a good deed for someone every day”. What a great world we would live in if everyone did this.

Mike Mittler

The bitterness of poor quality remains long after the sweetness of a cheap price is forgotten!

GOD BLESS AMERICA

PLEASE SUPPORT OUR TROOPS-THE TRUE HEROES OF THIS COUNTRY! THEIR EFFORTS FOR OVER 200 YEARS ALLOW US THE FREEDOM WE HAVE TODAY.



Made In The USA



Mittler Bros. Machine & Tool

Notchers & Accessories	6-11
Benders & Accessories	12-17
Bead Rollers & Accessories	18-21
Gold Series Bead Rolls	22
High Throat Bead Rollers	23-24
Jamey Jordan Signature Series	25-33
Rotary Machines & Accessories	34-35
Bench Press & Accessories	36-39
Punch & Flares	40-41
Dimple Dies & Flare Tools	42
Louver Press Kit	43
Power Hammers	44-45
Sheet Metal Brakes	46-49
Foot Shears	50
English Wheels	51-52
Shrinker / Stretcher	53-54
Planishing Hammer	55
Hand Tools & Clecos	56
Metal Forming Hand Tools	57
Informational DVDs	58
Rear Ends & Accessories	59-65
Front Hubs	66
Off Road Housings & Hubs	67
Spools	68
Crankshafts	69

Tanner Racing by Mittler Bros.

Shocks / Springs / Accessories	70-76
Quarter Midget & Go-Kart Acces.	77
Sprockets / Chassis Dyno	78
Scales & Accessories	79-84
Leveling	85
Pull Down Rig	86-87
Tire Gauges	88-89
Set Up Equipment	90-92
Adjustment Tools	93
Bump Steer Tools	94
Bump Stop Adjuster	95
Pyrometers	96
Data Recording	97
Switches & Electrical	97-98
Clamp on Chassis Accessories	99-100
Misc. Accessories	101
Misc. Tools	102
Team Recognition	103



New Products



120" Sheet Metal Brake
see page 48



Spring Steel Forming Die
See Website or Call For Info



Foot Shear Work Support Arms
see page 50

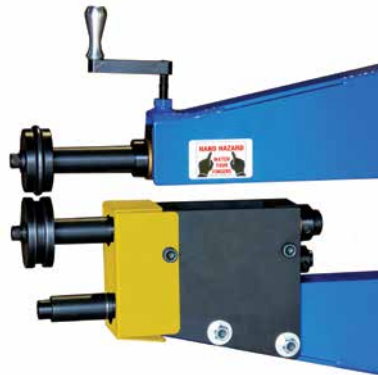

Bead Roller High Throat Adapter Kit
see page 23



45 Degree Rolls
see page 20



Rivet / Bead Roll Layout Tool
see page 26



Gold Series Designer Rolls
see page 22



New Products

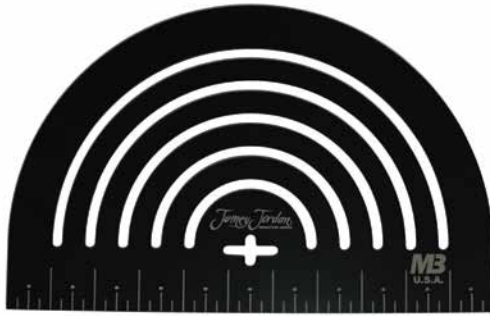

**Jamey Jordan Signature Series
Bead Roll Layout Templates**

see page 26



Econo Radius Brake
see page 49



Forming Dies
see page 42



High Throat Bead Roller Table
see page 32



HydroShox
see page 76



WiFi Scales
see page 79



Single Speed Ultimate Tube Notcher

The Best Gets Better!



1° Swivel Vise Allows Quick & Accurate Setup!



Hand Wheel Calibrated In .013" Segments For Precision Notching

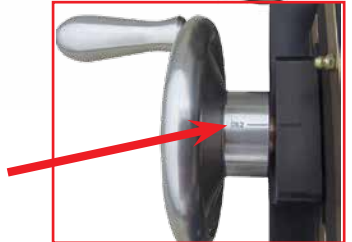

- Over 25 Years of Proven Use
- Highest Quality Notch/Cope In Minimal Time
- End Mill Design Allows Quick & Easy Metal Removal
- Swivel Vise with 1° Increments
- V-Block Design Means Quick Setup Time
- Optional Adjustable Height Vise for Offset Notching
- Makes a Perfect Tig Weld Fit
- No Coolant Needed
- No Dust or Excessive Noise

Model Options

Model 400-S

Vise Capacity 3/4" to 2" Tubing
Standard Vise

Model 400-U

Upgraded Vise Capacity 3/4" to 2-3/8" Tubing
Larger V-Block Vise
Recommended for pipe notching

Model 400-SADJ

Vise Capacity 3/4" to 2" Tubing
Adjustable Height Vise

Model 400-UADJ

Upgraded Vise Capacity 3/4" to 2-3/8" Tubing
Adjustable Height Larger V-Block Vise
Recommended for pipe notching



Ships Truck Freight
@ 300 lbs.
43L x 19W x 24H

Max Diameter
2" OD Standard Vise
2 3/8" OD Upgraded Vise

1 HP AC Motor
115 Volts / 15 Amp
1 Phase 60 Hertz
International Motor Upgrade (See p. 7)



Variable Speed Ultimate Tube Notcher

90° Notch = 16 Sec.
45° Notch = 27 Sec.



All the Features of the Ultimate Tube Notcher, with Variable Speed Control!

- 75 to 250 RPM Adjustable Cutter Speed
- Use Fast Speeds for Thin Walled Tube
- Use Slow Speeds for Large Diameter Thick Walled Tube
- End Mill Design Allows Quick & Easy Metal Removal
- Swivel Vise with 1° Increments
- V-Block Design Means Quick Setup Time
- Makes a Perfect Tig Weld Fit
- No Coolant Needed
- No Dust or Excessive Noise
- Optional Adjustable Height Vise for Offset Notching

Model Options

Model 400-VS

Vise Capacity 3/4" to 2" Tubing
Standard Vise

Model 400-VSADJ

Vise Capacity 3/4" to 2" Tubing
Adjustable Height Vise

Model 400-VSU

Upgraded Vise Capacity 3/4" to 2-3/8" Tubing
Larger V-Block Vise
Recommended for pipe notching

Model 400-VSUADJ

Upgraded Vise Capacity 3/4" to 2-3/8" Tubing
Adjustable Height Larger V-Block Vise
Recommended for pipe notching



Max Diameter
2" OD Standard Vise
2 3/8" OD Upgraded Vise

1-1/2 HP AC Motor
115, 208, 230, 240 Volts / 15 Amp
1 Phase 50/60 Hertz



Double Sided VS Ultimate Tube Notcher

Notch From Either Cutter Side



Two Sided Notch Side & Top View



Cluster Joint Created Without Need To Remove From Vise & Reposition Tube

Wider Table Allows Vise To Travel Further so Cutting Can Be Accomplished on Both Sides of the End Mill. This Allows Notching those otherwise "Impossible Pieces".

All The Features of our proven Variable Speed Ultimate Tubing Notcher



Extended Vise Travel Allows Notching on Either Side of the Cutter

Model Options

Model 400-VS2

Vise Capacity 3/4" to 2" Tubing
Standard Vise

Model 400-VSU2

Upgraded Vise Capacity 3/4" to 2-1/2" Tubing
Larger V-Block Vise
Recommended for pipe notching

Model 400-VS2ADJ

Vise Capacity 3/4" to 2" Tubing
Adjustable Height Vise

Model 400-VSU2ADJ

Upgraded Vise Capacity 3/4" to 2-1/2" Tubing
Adjustable Height Larger V-Block Vise
Recommended for pipe notching

Max Diameter
2" OD Standard Vise
2-1/2" OD Upgraded Vise



Ships Truck Freight
@ 470 lbs.
48L x 35W x 38H

1-1/2 HP AC Motor
115, 208, 230 Volts / 15 Amp
1 Phase 50/60 Hertz



Standard Hydraulic Tube Notcher

- Capacity
2" OD Maximum
1" OD Minimum
- Produces Straight or Angle Cuts
- Includes 10 Ton Hydraulic Ram
- 35 Lbs.

Max Tube Wall Thickness 0.125"



Standard OD Notcher Dies:

1"	100-010-1
1-1/8"	100-010-1125
1-1/4"	100-010-1250
1-3/8"	100-010-1375
1-1/2"	100-010-1500
1-5/8"	100-010-1625
1-3/4"	100-010-1750
2"	100-010-2

Replacement Punch (2" Wide)
Model 100-005

Standard Hydraulic Tube Notcher With Die (your choice) **Model 100 Hydraulic**
Pump Sold Separately

Heavy Duty Hydraulic Tube Notcher

- Capacity
2-3/8" OD Maximum
1-1/2" OD Minimum
- Great for Production Work
- Recommended for Pipe Notching & Fencing
- Includes 10 Ton Hydraulic Ram
- 50 Lbs.

Max Tube Wall Thickness 0.154"



Heavy Duty OD Notcher Dies:

Tube Sizes	
1-1/2"	100-030-1500
1-5/8"	100-030-1625
1-3/4"	100-030-1750
2"	100-030-2
Pipe Sizes	
1.66"	100-030-166
1.90"	100-030-190
2-3/8"	100-030-2375

Replacement Punch (2-1/2" Wide)
Model 100-023

Heavy Duty Hydraulic Tube Notcher With Die (your choice) **Model 100-U Hydraulic**
Pump Sold Separately

Accessories



90 PSI Compressed Air
Air Hydraulic Pump, 6' Hose & Fitting
Model 900-504-6

- Air Hydraulic Pump - **Model 900-504**
- 6' Hose - **Model 900-505-6**
- 10' Hose - **Model 900-505-10**
- 20' Hose - **Model 900-505-20**



115v. 1Ph 60Hz with 10' Operator Cord
Electric Hydraulic Pump, 6' Hose & Fitting
Model 900-508-6

- Electric Hydraulic Pump - **Model 900-508**
- 6' Hose - **Model 900-505-6**
- 10' Hose - **Model 900-505-10**
- 20' Hose - **Model 900-505-20**



Bench Mounting Bracket
(Fits either unit)
Model 100-200



Optional Floor Stand
with Locking Casters
Model 3100-100



Hole Saw Notchers



Basic Steel Unit
Model 1700-BSU

- Sets to Exact Angles (0-60 Degrees)
- Automatic Centering of Tube
- Notches Tubing from 1/2" to 2" Diameter
- Power with Drill Press or Hand Drill
- Economical Enough for the Amateur
- Rugged Enough for the Professional



Deluxe Double
Adjustable Aluminum Mount
Model 1700-DADM

Hole Saws



Hole Saws		
Size	Part #	
3/4"	1700-501	
1"	1700-502	
1-1/4"	1700-503	
1-3/8"	1700-504	
1-1/2"	1700-505	
1-5/8"	1700-506	
1-3/4"	1700-507	
2"	1700-508	

PipeMaster



Tube Sizes-OD		
Size	Part #	
1"	MB-PT100	
1-1/8"	MB-PT1125	
1-1/4"	MB-PT125	
1-3/8"	MB-PT1375	
1-1/2"	MB-PT150	
1-5/8"	MB-PT1625	
1-3/4"	MB-PT175	
2"	MB-PT200	
Pipe Sizes-ID		
1-1/4"	MB-P125	
1-1/2"	MB-P150	
2"	MB-P200	

5-Piece Pro Race Kit

Qty. (1 Kit.) 1", 1-1/4", 1-1/2", 1-3/4" & 2" Model MB-PT001 (Includes Carrying Case)

Dragster Kit

Qty. (1 Kit.) 1-5/8" & 1-1/2" Model MB-PT002 (Includes Carrying Case)



Hydraulic 180° Tube Bender



Easily Produces Compound Bends



Swing Out Work Tray Holds Follow Bar & Removes for Compound Bends

Max Capacity
2" OD Tubing .125" Wall
1-1/2" Pipe (1.90" OD) .145" Wall

- Hydraulic Powered 25 Ton Ram
- 8-1/4 Stroke
- Digital Readout in 1° Increments for Maximum Repeatability
- Bends Mild Steel, Stainless, Aluminum, 4130 Tubing & Pipe
- Rolling Stand with Locking Casters
- Cam Action Follow Bar Pressure Release
- Rugged Rack & Pinion Drive
- 3" Minimum Radius
- Bends Square Tubing 3/4" to 2"
- Small & Medium Saddles Included
- Storage Shelves for Shoes & Follow Bars

.065" Minimum Wall Thickness

180° Bender (25 Ton Ram) Model 2500

Hydraulic Pump & Shoe Sets Sold Separately p. 14

Heavy Duty 180° Bender (25 Ton Ram) Model 2500-HD Stronger

Rack & Pinion Drive, Recommended For Pipe & Heavy Wall Moly Bending



Round Tube Shoe Sets			
Tube OD	CL Rad.	Part #	
* 2"	8"	2500-S00	
1-3/4"	8"	2500-S01	
1-3/4"	7"	2500-S02	
45mm	178mm	2500-M45	
1-5/8"	7"	2500-S03	
40mm	152mm	2500-M40	
1-1/2"	6"	2500-S04	
△ 1-1/2"	4-1/2"	2500-S34	
38mm	152mm	2500-M38	
1-3/8"	5"	2500-S05	
30mm	102mm	2500-M30	
30mm	102mm	2500-M30	
1-1/8"	4"	2500-S07	
1"	4"	2500-S08	
25mm"	102mm"	2500-M25	
3/4"	4"	2500-S09	
1/2"	4"	2500-S17	

Square Tube Shoe Sets			
Tube OD	CL Rad.	Part #	
* 2"	8"	2500-S18	
1-3/4"	8"	2500-S16	
1-3/4"	7"	2500-S15	
1-1/2"	6"	2500-S14	
1-1/4"	5"	2500-S13	
1-1/8"	4"	2500-S12	
1"	4"	2500-S11	
3/4"	4"	2500-S10	
Pipe Shoe Sets			
Pipe Size	OD	CL Rad.	Part #
* 1-1/2"	1.90	8"	2500-S32
1-1/4"	1.66	6"	2500-S31
1"	1.31	5"	2500-S30

See Accessories
Pages 14-16

* Must Purchase Model # 2500-302 Large Adjustable Saddle



Hydraulic 90° Tube Bender



Max Capacity
 2" OD Tubing .125" Wall
 1-1/2" Pipe (1.90" OD) .145" Wall

.065" Minimum Wall Thickness

NEW Stand Available (See p. 14)

- 25 Tons of Hydraulic Power
- 6-1/4 Stroke
- Portable at 60 lbs, and No Need to Anchor
- 3 1/2" Minimum Radius
- Bends Mild Steel, Stainless, Aluminum, 4130 Tubing & Pipe
- Engraved Reference Scale for Easy Repeatability
- 3/4" to 2" OD Round Tubing
- Bends Square Tubing 3/4" to 2"
- Small & Medium Adjustable Saddles Included
- Instructional 1 hour DVD Included

90° Bender (25 Ton Ram) Model 900

Hydraulic Pump Sold Separately p. 14
 Shoe Sets Sold Separately

Round Tube Shoe Sets			
Tube OD	CL Rad.	Part #	
* 2"	8"	900-S01	
* 2"	7"	900-S02	
1-3/4"	8"	900-S03	
1-3/4"	7"	900-S04	
45mm	178mm	900-M45	
1-5/8"	7"	900-S05	
1-5/8"	6"	900-S06	
40mm	152mm	900-M40	
1-1/2"	7"	900-S07	
1-1/2"	6"	900-S08	
38mm	152mm	900-M38	
1-3/8"	5"	900-S09	
1-1/4"	5"	900-S10	
30mm	102mm	900-M30	
1-1/8"	4"	900-S11	
1"	4"	900-S12	
25mm	102mm	900-M25	
3/4"	4"	900-S14	

Square Tube Shoe Sets			
Tube OD	CL Rad.	Part #	
* 2"	8"	900-S25	
1-1/2"	7"	900-S26	
1-1/4"	5"	900-S27	
1"	4"	900-S28	
3/4"	4"	900-S29	

Pipe Shoe Sets			
Pipe Size	OD	CL Rad.	Part #
* 1-1/2"	1.90	8"	900-S41
1-1/4"	1.66	6"	900-S42
1"	1.315	5"	900-S43
3/4"	1.050	4"	900-S44
1/2"	.84	4"	900-S45

**See Accessories
 Pages 14-16**

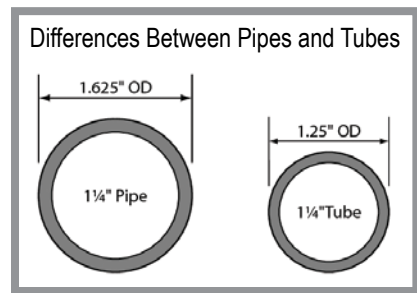

* Must Purchase Model # 2500-302 Large Adjustable Saddle



Tube Bending Accessories

90° Tube Bender Stand



- Use of cubic feet to bend instead of valuable square footage
- Ease of portability with roll around stand
- Can take off stand for portability for offsite jobs
- Allows user to make bends in the “negative plain”

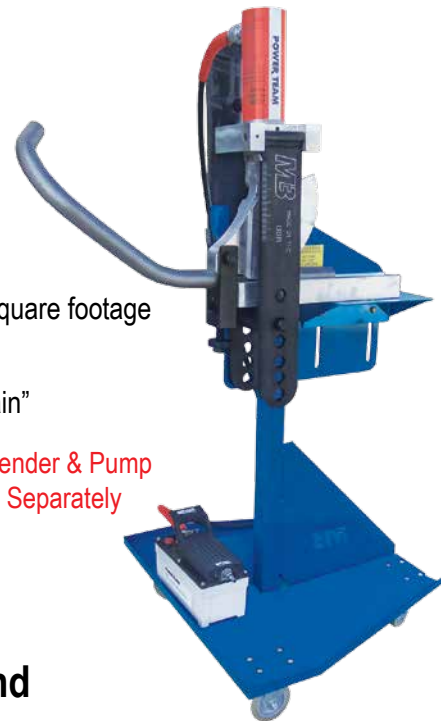

Tube Bender & Pump
Sold Separately

90° Tube Bender Stand Model 900-300

Adjustable Saddles

For 90° & 180° Hydraulic Tube Benders

- Securely holds each tube, eliminates tube creep
- Easy Release “V” Block eliminates Stuck Saddle from tube spring back
- Easier Bend-to-Bend Alignment with light pressure on tube
- Saddles Handle Round & Square Tubing

Adjustable Saddle Sold Separately -
Not Included with Shoe Set

3/8" TO 1-3/8" OD. Small Adjustable Saddle

Model 2500-300

1-1/2" TO 1-3/4" OD. Medium Adjustable Saddle

Model 2500-301

2" OD. Large Adjustable Saddle

Model 2500-302



Bend Stop for 180° Tube Bender

Pre Set Stop For Accurate Repeat Bends

Bolts to the side of the 2500 180° Hydraulic Bender frame and routes shop air through the valve to your air hydraulic pump. Once adjustable stop button is moved to proper preset position, button will contact the air “switch” and cuts the air to your pump at the preset position. Three Bend Presets makes this Ideal for repeat production work.



Air Stop Kit for 2500 180° Bender
Model 2500-400



90 PSI Compressed Air

Air Hydraulic Pump, 6' Hose & Fitting

Model 900-504-6

Air Hydraulic Pump - Model 900-504

6' Hose - Model 900-505-6

10' Hose - Model 900-505-10

20' Hose - Model 900-505-20



115v. 1Ph 60Hz with 10' Operator Cord

Electric Hydraulic Pump, 6' Hose & Fitting

Model 900-508-6

Electric Hydraulic Pump - Model 900-508

6' Hose - Model 900-505-6

10' Hose - Model 900-505-10

20' Hose - Model 900-505-20



Digital Read Out
For Model 900 Bender
Model 900-D



Tube Bending Instructional
DVD For Model 900 Bender
Model 900-500-DVD



Bend-Tech Software

Save Time, Material, & Money....Do it Right the First Time!

Tube Bending Software Requires XP, Vista, Windows 7 or Windows 8

BEND-TECH EZ

- Designed for Tube Bending Projects with simple 2D parts (completed parts that lay flat)
- Predefined Templates to illustrate and assist in part layout and setup
- 6 Bends allowed with custom part interface
- Total Tube Length identified for your specific bending project
- Bend Start Points identified for each bend
- Printable Setup Sheet -- easy to follow
- Upgrade to Higher Software Level -- EZ-3D, PRO, or SE

Bend-Tech EZ Software [Model 900-510](#)

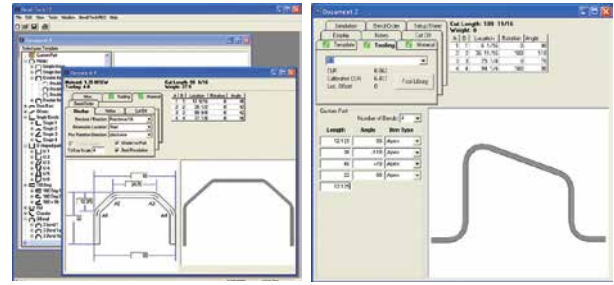

BEND-TECH EZ-3D

- All EZ Features Included
- 3D Custom Part Window for multiple bends
- 360-degree Part Rotation to view part from any angle
- Simple Setup Terms of "front, back, floor, ceiling, left, & right"
- Reverse Bending order available
- Bending Simulation illustrates each bend process and final shape
- Upgrade to Higher Software Level -- PRO or SE

Bend-Tech EZ-3D Software [Model 900-511](#)

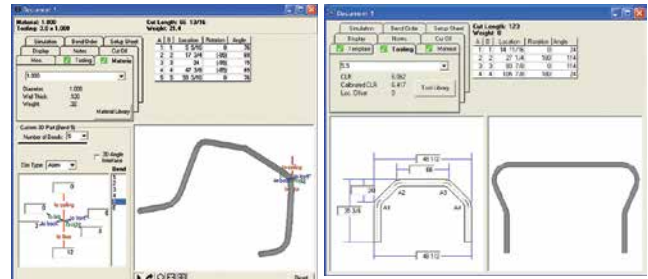

BEND-TECH PRO

- All EZ-3D Features Included
- Entire Manufacturing Instructions are printable to check each part design & process
- Each Part Shown Individually with dimensions, angle, degree of notch
- Cutting Instructions -- includes notching (fish-mouth)
- Full 3D Assembly Design
- 10 Bends Allowed

Bend-Tech PRO Software [Model 900-512](#)

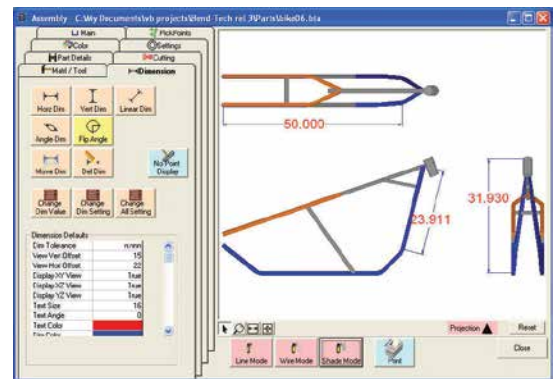

BEND-TECH SE

- All PRO Features Included
- DXF Compatible
- Commercial Bending
- Springback Compensation
- Manufacturability Checking
- LRA to XYZ, transfer any part into a XYZ data
- 50 Bends Allowed

Band Number	Location	Rotation	Bend
Band Number: 1	Location: 8.604	Rotation: 0	Bend Angle: 80.7
Band Number: 2	Location: 25.936	Rotation: 88.5	Bend Angle: 80.7
Band Number: 3	Location: 42.776	Rotation: 0	Bend Angle: 80.7
Band Number: 4	Location: 60.108	Rotation: 271.5	Bend Angle: 80.7

Part Name: example 127 01
 Dia: 1.315
 Description: small ball brace
 Material: 17-5 SSM
 Display: 4.0
 Color: CLR 40
 Date: 09/13/2005
 Use .250 spacer after the seal

Part Length: 74.343
 Weight: 7.4

Band	Location	Rotation	Angle	Dir
1	8.604	0	80.7	4
2	25.936	88.5	80.7	4
3	42.776	0	80.7	4
4	60.108	271.5	80.7	4

Custom Instructions: XYZ

Band	Start	End	Start	End
1	10	0	4	Appt
2	10	21	18	4
3	10	24	0	4
4	10	28	0	4

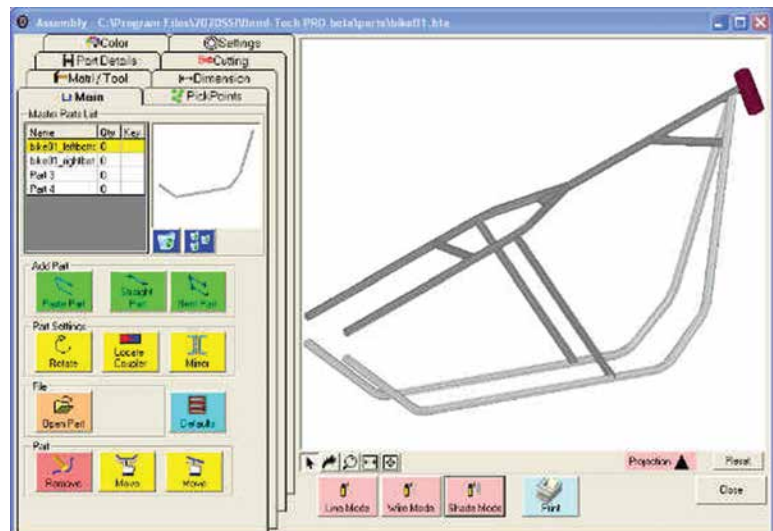

Bend-Tech SE Software [Model 900-513](#)

Requires "Pro" Tube Bending Software - Latest Release



Alignment Tools

Digital Angle Gauge with Level



- Convenient "HOLD" feature
- Press the ZERO button to calibrate the gauge to any reference surface
- Standard AAA batteries for up to 2 years life
- Built in level uses patent pending Dead Level* technology
- Super strong magnets securely attach the gauge to saw blades and other metallic surfaces

*Dead Level refers to absolute level with respect to the center of the earth. This setting is permanently calibrated.

Digital Angle Gauge w/ Level
Model MB-WR365

Digital Protractor



- Long legs for added versatility
- Measure work-piece or construction angles
- Use for marking and layout
- 2" wide X 7/8" thick X 9" long
- Can be used in any plane
- 0.1 degree resolution, accuracy, and repeatability
- Sets both miter and bevel angles on almost any machine
- Strong magnets on all blade edges for ease of use
- Blades can be tightened for holding measurements

Digital Protractor
Model MB-WR410

End material waste and slow trial & error fabrication. The Notch & Bend Aligner assures precise axial alignment of notches and bends. Add the finishing touch to your **Ultimate Notcher** and **Tube Bender**!



Capacity:
3/4" OD to 2" OD Round

Notch & Bend Aligner
Complete w/ Smart Tool
Model 1800-STA

← 2-1/4" →
Mount Only
Model 1800-A



Smart Tool Angle Sensor
Model 1800

- Beeps at level and plumb
- Digitally reads all angles in degrees, % slope, & pitch
- Push button recalibration
- For use in a variety of applications & equipment



Magnetic Mount
Model 1800-505
No Smart Tool owner should be without!

Bend Protractors



Close Up View



Bend Protractors	
CL Radius	Part #
4"	2100-4
5"	2100-5
6"	2100-6
7"	2100-7
8"	2100-8
4" to 8" Set	2100

- Easily Set Any Degree Of Bend From 0° to 90°
- Can Be Used As A Bend Template Or Degree Indicator
- Inner Scale Shows Degree Of Bend
- Outer Scale Shows Developed Length For Each Degree Of Bend
- Light Weight Aluminum For Ease Of Use
- Precision Laser Engraving



180° Manual Tube Bender



Capacity
3/8" - 1" OD Tube
.049" Wall to .095" Wall



Tube In Starting Position



Finished 180° Bend

Manual 180° Tube Bender - Includes: Shoe Set (Your Choice)

Model 950

Round Tube Shoe Sets			
3 Piece Set - Main Shoe, Follow Roller & Eccentric Lock Roll			
Tube Size	CL Rad.	Part #	
1"	3-1/2"	950-S01	
7/8"	3-1/2"	950-S02	
3/4"	2-1/2"	950-S03	
5/8"	2-1/2"	950-S04	
1/2"	2"	950-S05	
Combo 3/8" / 1/2"	2"	950-S20	



Square Tube Shoe Sets			
3 Piece Set - Main Shoe, Follow Roller & Eccentric Lock Roll			
Tube Size	CL Rad.	Part #	
1"	3-1/2"	950-S06	
7/8"	3-1/2"	950-S07	
3/4"	2-1/2"	950-S08	
5/8"	2-1/2"	950-S09	
1/2"	2"	950-S10	

Model 950 is 30 lbs. with one shoe set

Time saving features to upgrade your existing 180° Manual Tube Bender

RetroFit Degree Wheel Kit **Model 950-DWK**



Simply insert your tube into the bender, pull follow roller into contact with tube, loosen thumb screw and rotate degree dial so "0" aligns with arrow. Pull follow roll until arrow aligns with degree of bend desired.



Eccentric Lock Roll (Specify Tube Size at Order) **Model 950-006** Offset

mount allows lock roll to prevent tube creep & hold tube secure during bending operation.



Variable Speed Power Drive Bead Rollers

Max Capacity
 19 Ga (.040") Mild Steel
 16 Ga (.050") Aluminum
 24 Ga (.025") Stainless



24"



36"



42"

Built with Pride in the USA For Over 30 Years!

- 24" Model - Billet Aluminum Frame
- 36" & 42" Models - Jig Welded Steel Frame
- 100+ Bead Roll Profiles (See pages 20-22)
- 1-1/8" Throat Height
- Adjustable Depth of Bead
- Oilite Bushings for Long Life
- 10' Variable Speed Foot Pedal Operated
- Forward / Reverse Switch
- Both Shafts Driven

Bead Rolls Sold Separately
 (See pg. 20-21)

24" Throat Depth Variable Speed Bead Roller [Model 210-24](#)

36" Throat Depth Variable Speed Bead Roller [Model 200-36](#)

42" Throat Depth Variable Speed Bead Roller [Model 200-42](#)

42" Model Ships Truck Freight Only

Upgraded Adjustable Shaft Models Available On Page 27

NEW Gold Series Bead Rolls
 (See pg. 22)

24" Manual Bead Roller Available



Manual to Power Drive Motor Conversion Kit

[Model 200-302](#)

(Upgrade from a Manual to a Power Drive Bead Roller)



STD. Motor to Industrial Motor Conversion Kit

[Model 200-300](#)

(Easy bolt on conversion kit to upgrade for 16 Ga Mild steel Capacity)
 10 Foot Pedal Cord



Industrial Variable Speed Bead Rollers

Ideal For Restoration Using Up To 16 Ga Mild Steel

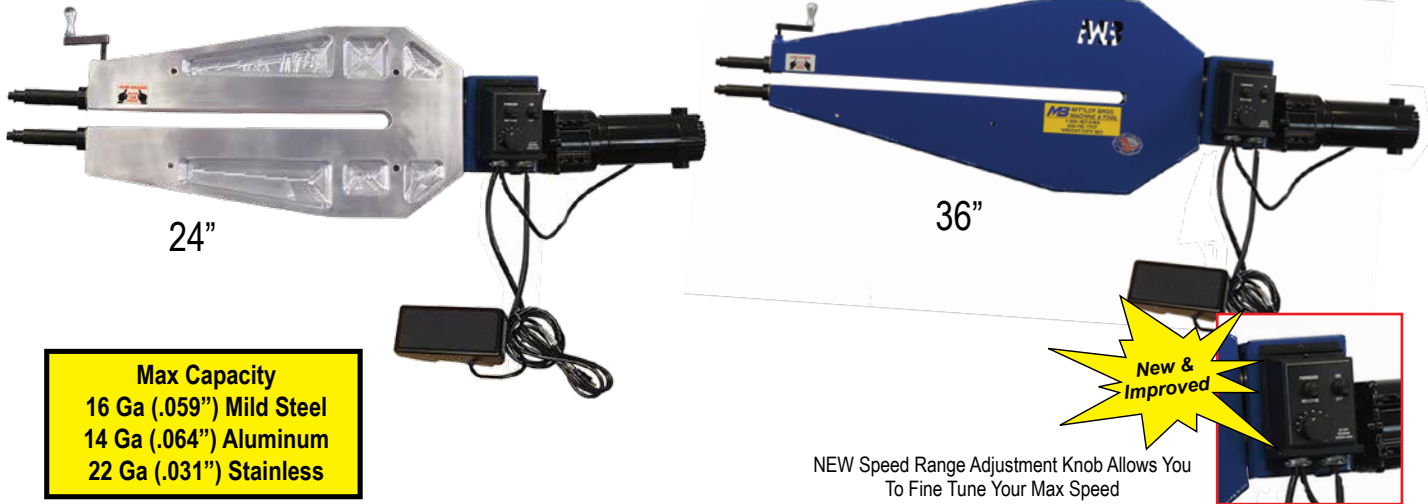

Max Capacity
 16 Ga (.059") Mild Steel
 14 Ga (.064") Aluminum
 22 Ga (.031") Stainless

NEW Speed Range Adjustment Knob Allows You To Fine Tune Your Max Speed

Increased Motor Torque & Horsepower To Handle Those Demanding Jobs with Ease!

- 24" Model - Billet Aluminum Frame
- 36" Model - Jig Welded Steel Frame
- 100+ Bead Roll Profiles (See pages 20-22)
- 1-1/8" Throat Height
- Adjustable Depth of Bead
- Oilite Bushings for Long Life
- 10' Variable Speed Foot Pedal Operated
- Forward / Reverse Switch
- Speed Range Adjustment Knob

24" Throat Depth Industrial Variable Speed Bead Roller (Billet Aluminum) [Model 210-24NV](#)

36" Throat Depth Industrial Variable Speed Bead Roller (Jig Weld Steel) [Model 200-36NV](#)

Bead Rolls Sold Separately (See pg. 20-21)

Upgraded Adjustable Shaft Models Available On Page 27

NEW Gold Series Bead Rolls (See pg. 22)

Bead Roller Accessories



Floor Stands

- Bolt Together Design For Easy Shipping
- Industrial Coated Finish
- Fits All Bead Rollers



Speed Adjustment Kit Enables You To Fine Tune Your Max Speed On Industrial Bead Rollers

Works with Industrial Bead Roller Motors Only

Speed Adjustment Kit
[Model 200-305](#)

Depth Stop

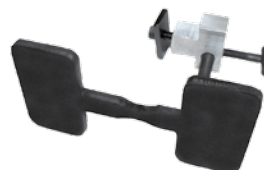

Depth Stop
[Model 200-009](#)

Roll Holder



Roll Holder
[Model 200-RH](#)

Voltage Converter



Power Converter required when operating power drive bead roller on power source other than 110 volts.

110, 200, 220 & 240 Volt Input / 110 or 220 Volt Output

500 Watt (5 Amp) Voltage Converter [Model 200-552](#)

2000 Watt (16 Amp) Voltage Converter [Model 200-558](#)



Largest Selection of Rolls Available!

For Use With All Standard (1-1/8" Throat) Bead Rollers:

210-24, 210-24NV, 200-36, 200-36NV, 200-42, 210-24M, 202-24, 202-24NV, 202-36, & 202-36NV

Standard Round Bead Roll Sets		
Description	Steel P/N	
1/8" Round	201-125	
3/16" Round	201-188	
1/4" Round	201-250	
5/16" Round	201-313	
3/8" Round	201-375	
1/2" Round	201-500	
5/8" Round	201-625	
3/4" Round	201-750	
1" Round	201-100	



Standard Edge Bead Roll Sets		
Description	Steel P/N	
1/8" Edge Bead	201-125-E	
3/16" Edge Bead	201-188-E	
1/4" Edge Bead	201-250-E	
5/16" Edge Bead	201-313-E	
3/8" Edge Bead	201-375-E	
1/2" Edge Bead	201-500-E	
5/8" Edge Bead	201-625-E	
3/4" Edge Bead	201-750-E	
1" Edge Bead	201-100-E	



Standard Flat Bead Roll Sets		
Description	Steel P/N	
1/8" Flat	201-125-F	
3/16" Flat	201-188-F	
1/4" Flat	201-250-F	
5/16" Flat	201-313-F	
3/8" Flat	201-375-F	
1/2" Flat	201-500-F	
5/8" Flat	201-625-F	
3/4" Flat	201-750-F	
1" Flat	201-100-F	



45° Bead Roll Sets		
Description	Steel P/N	
1/8" 45°	201-125-45	
3/16" 45°	201-188-45	
1/4" 45°	201-250-45	
5/16" 45°	201-313-45	
3/8" 45°	201-375-45	
1/2" 45°	201-500-45	
5/8" 45°	201-625-45	
3/4" 45°	201-750-45	
1" 45°	201-100-45	



Standard Step Roll Sets		
Description	Steel P/N	
.062" Step	201-062-S	
.090" Step	201-090-S	
1/8" Step	201-125-S	
3/16" Step	201-188-S	
1/4" Step	201-250-S	
45° Step	201-045-S	

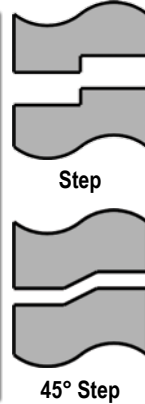

Bead Size Indicates Width

All Standard Roll Sets
2-1/2" OD x 3/4" ID

All Rolls Available in Nylatron at same price!
Nylatron Rolls are Ideal for Pre-Finished Materials as well as Copper, Brass & Thin Aluminum
Add Letter "D" to the End of Part #
ex. 1/8" Round Nylatron Roll #201-125D

Tube Bead Rolls

Fits all model 200 & 210 Bead Rollers



HD

Rolls A Bead So Hoses Won't Slip Off

HD Tube Bead Rolls **Model 201-010**
(1-1/4" ID Min x .095" Wall Aluminum , .059 Mild Steel, .043 Stainless Steel)

Recommended for use with
24" BR w/ Industrial Motor or Rotary Machine



Specialty Rolls

For Use With All Standard (1-1/8" Throat) Bead Rollers:

210-24, 210-24NV, 200-36, 200-36NV, 200-42, 210-24M, 202-24, 202-24NV, 202-36, & 202-36NV

Specialty Roll Sets		
Description	Steel P/N	
Art Pattern Roll Set	201-102	
Blank Roll Set (non-machined)	201-002	
Body Line Roll Set	201-084	
Fender Flare Roll Set	201-065	
Full Radius Tank Roll Set	201-083	
Hem Roll Set Combo	201-037	
Hem Roll Set Steel	201-038	
Hem Roll Step #1 (1/4" 90°)	201-059	
Hem Roll Step #1 (3/8" 90°)	201-008	
Hem Roll Step #2 (140°)	201-060	
Hem Roll Step #3 Flat	201-068	
Louver Roll Set	201-082	
Shear Roll Set	201-058	
Standard Tank Roll Set	201-070	
Spoiler Roll Set	201-072	
Tipping Roll Set	201-101	
Tube Bead Roll Set (HD)	201-010	
30° Angle Roll Set	201-069	
90° 1/2" Angle Roll Set	201-500-B	
90° 3/4" Angle Roll Set	201-750-B	
1/8" Double Taper Pinstripe Roll Set	201-125-DPT	
1/16" Wire Bead Roll Set (3 pc Set)	201-062-WBS	
1/8" Wire Bead Roll Set (3 pc Set)	201-125-WBS	
3/4"W x 1/2"D Wire Trough Roll Set	201-750-WTS	

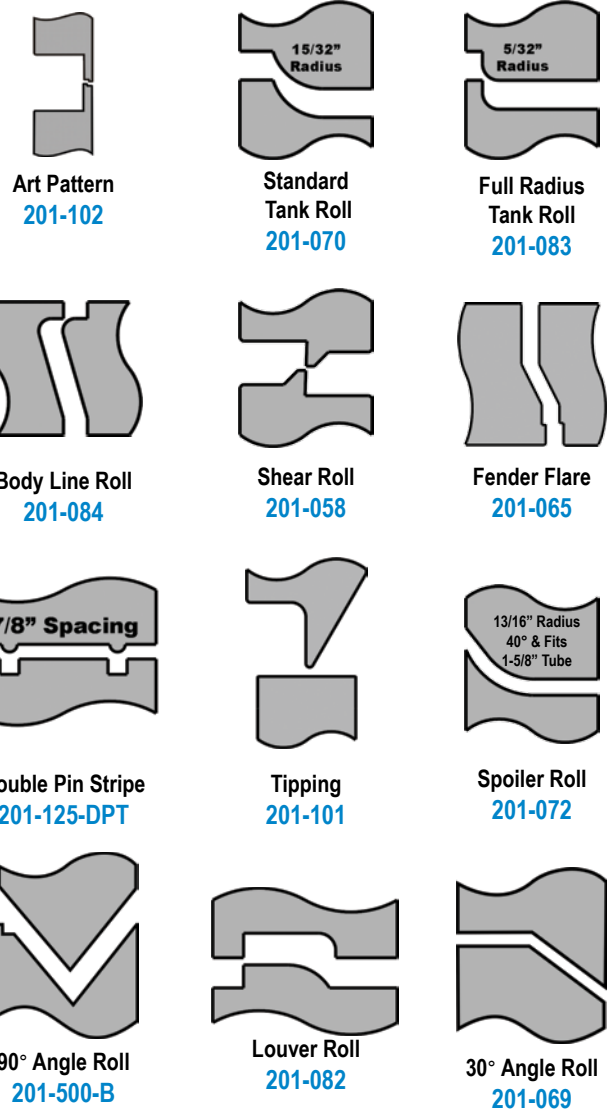

Hem Roll Set Complete

This easy, three-step process creates hem rolls approximately 1/4" deep on steel or aluminum up to .040" thick without marring pre-painted aluminum. Rolls are available in HEAT-TREATED STEEL or COMBO STEEL & NYLATRON.

Complete Hem Roll Set Combo Steel / Nylatron
Model 201-037

Complete Hem Roll Set Combo Heat Treated Steel
Model 201-038

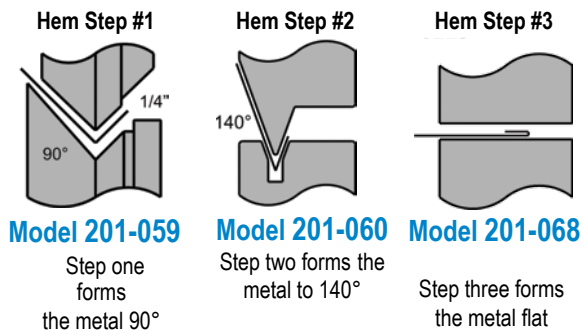

Bead Size
Indicates Width

Some Rolls Available in Nylatron at same price!
Nylatron Rolls are Ideal for Pre-Finished Materials as well as Copper, Brass & Thin Aluminum
Add Letter "D" to the End of Part #
ex. 1/8" Round Nylatron Roll #201-125D

Wire Bead Roll Set Complete

1/16" Wire Bead Roll Set **Model 201-062-WBS**
1/8" Wire Bead Roll Set **Model 201-125-WBS**

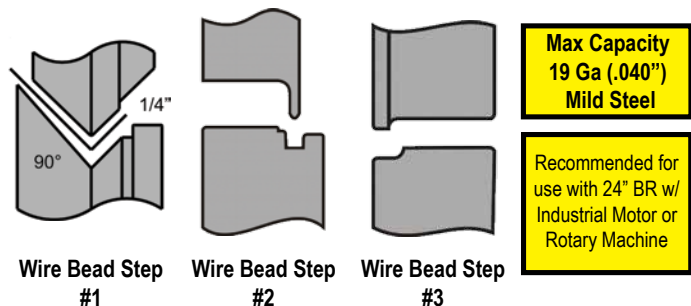

Max Capacity
19 Ga (.040")
Mild Steel

Recommended for
use with 24" BR w/
Industrial Motor or
Rotary Machine



Specialty Rolls Gold Series

For Use With All Standard (1-1/8" Throat) Bead Rollers:

210-24, 210-24NV, 200-36, 200-36NV, 200-42, 210-24M, 202-24, 202-24NV, 202-36, & 202-36NV

GOLD SERIES

Designer Rolls

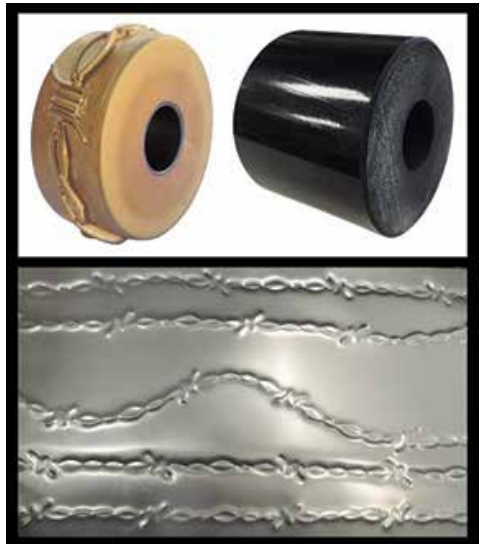

Barb Wire
203-101

Card Suit
203-121

Circle
203-211

Chain
203-131

Diamond
203-201

Diamond Plate
203-171

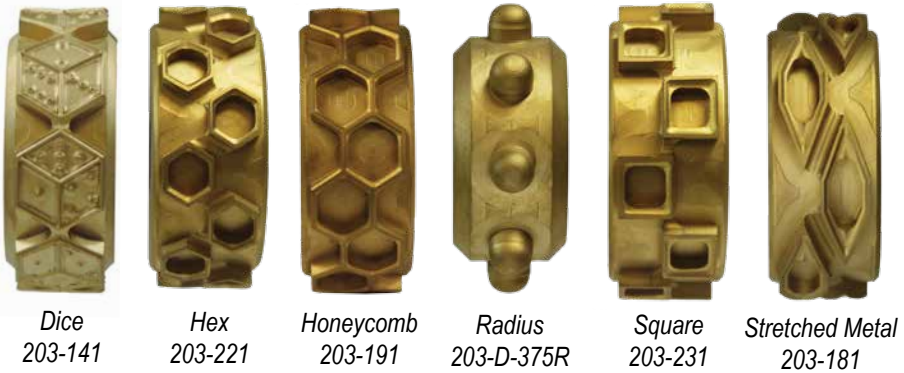

Dice
203-141

Hex
203-221

Honeycomb
203-191

Radius
203-D-375R

Square
203-231

Stretched Metal
203-181



22 Ga Mild Steel



16 Ga Aluminum



Replace Bottom Skateboard Wheel with Hem 3 for a whole new look (sold separately)

- Set Fits All 1-1/8" Throat MB Bead Rolls
- Top roll is Heat Treated and Titanium Nitride Coated for long life
- Bottom roll is Urethane

ROLL ONLY ROLL SET

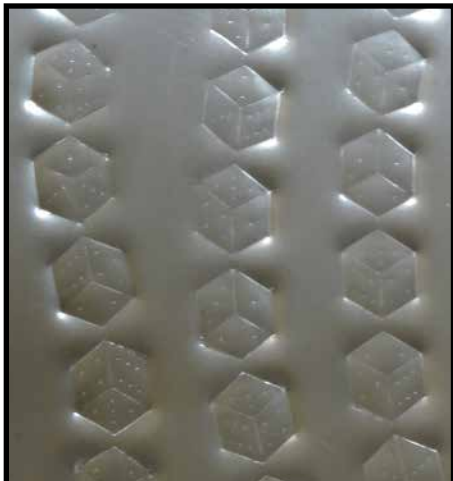

**Max Capacity
16 Ga (.050") Aluminum**



High Throat Variable Speed Bead Roller

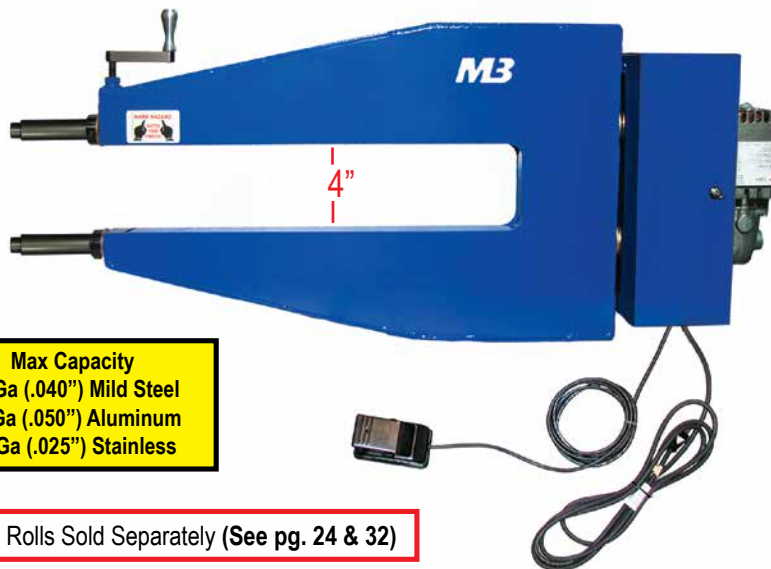
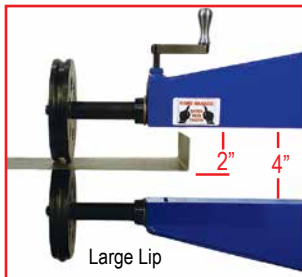

Max Capacity
 19 Ga (.040") Mild Steel
 16 Ga (.050") Aluminum
 24 Ga (.025") Stainless

Bead Rolls Sold Separately (See pg. 24 & 32)

- 24" & 36" Models Available
- Rigid Steel Frame
- Large Selection of Bead Roll Profiles
- 4" High Throat for Extra Clearance
- Adjustable Depth of Bead
- Oilite Bushings for Long Life
- Variable Speed Foot Pedal Operated
- Forward / Reverse Switch
- Both Shafts Driven

24" Throat Depth High Throat Variable Speed Bead Roller **Model 204-24**

36" Throat Depth High Throat Variable Speed Bead Roller **Model 204-36**

Upgraded Adjustable Shaft Models Available On Page 27

Industrial Variable Speed Models

Max Capacity
 18 Ga (.047") Mild Steel
 14 Ga (.064") Aluminum
 24 Ga (.025") Stainless

Bead Rolls Sold Separately (See pg. 24 & 32)



24" Throat Depth Industrial VS High Throat Bead Roller **Model 204-24NV**

36" Throat Depth Industrial VS High Throat Bead Roller **Model 204-36NV**

Upgraded Adjustable Shaft Models Available On Page 27

Increased Motor Torque & Horsepower To Handle Up To 18 Ga Mild Steel

Accessories

High Throat Adapter Kit



Converts Your High Throat Bead Roller to Standard Size, allowing use of all standard rolls.

Model 202-300

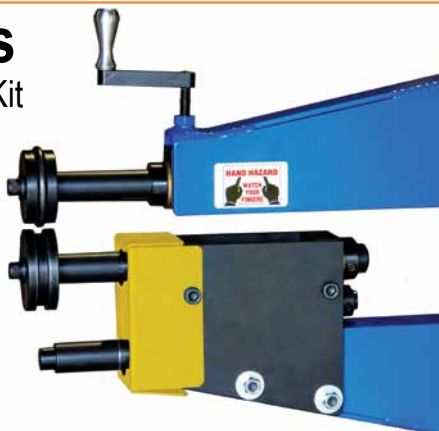

Depth Stop
 (Fits High Throat Bead Roller)
Model 204-009



Roll Holder
 (High Throat Bead Roller)
Model 204-RH



High Throat Bead Roll Sets 5-1/2" OD

For Use With All 4" Throat Bead Rollers: 204-24, 204-24NV, 204-36, 204-36NV, 202-24-HT, 202-24NV-HT, 202-36-HT, & 202-36NV-HT

5-1/2" OD
Upper



5-1/2" OD
Lower



Round Bead Roll Sets		
Description	Steel P/N	
1/8" Round	204-125	
3/16" Round	204-188	
1/4" Round	204-250	
5/16" Round	204-313	
3/8" Round	204-375	
1/2" Round	204-500	



Edge Bead Roll Sets		
Description	Steel P/N	
1/8" Edge Bead	204-125-E	
3/16" Edge Bead	204-188-E	
1/4" Edge Bead	204-250-E	
5/16" Edge Bead	204-313-E	
3/8" Edge Bead	204-375-E	
1/2" Edge Bead	204-500-E	



Step Roll Sets		
Description	Steel P/N	
.062" Step	204-062-S	
.090" Step	204-090-S	
1/8" Step	204-125-S	
3/16" Step	204-188-S	
1/4" Step	204-250-S	
45° Step	204-045-S	



Flat Bead Roll Sets		
Description	Steel P/N	
1/8" Flat	204-125-F	
3/16" Flat	204-188-F	
1/4" Flat	204-250-F	
5/16" Flat	204-313-F	
3/8" Flat	204-375-F	
1/2" Flat	204-500-F	

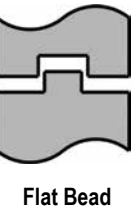

Specialty Roll Sets		
Description	Steel P/N	
Art Pattern Roll Set	204-102	
Blank Roll Set (non-machined)	204-002	
Body Line Roll Set	204-084	
Full Radius Tank Roll Set	204-083	
Hem Roll Set Combo	204-037	
Hem Roll Step #1 (1/4" 90°)	204-059	
Hem Roll Step #1 (3/8" 90°)	204-008	
Hem Roll Step #2 (140°)	204-060	
Hem Roll Step #3 Flat	204-068	
Shear Roll Set	204-058	
Standard Tank Roll Set	204-070	
Spoiler Roll Set	204-072	
Tipping Roll Set	204-101	
30° Angle Roll Set	204-069	
90° 1/2" Angle Roll Set	204-500-B	
90° 3/4" Angle Roll Set	204-750-B	

High Crown Bead Roll Sets 2-1/2" OD/ 8-1/2" OD

204-24, 204-24NV, 204-36, & 204-36NV Powered Bead Rollers

High Crown Rolls allow more throat height usage

2-1/2" OD
Upper Roll



8-1/2" OD
Lower Roll



High Crown Rolls
Available with same shapes as 5 1/2 OD Bead Roll Sets
Add Letters "HC" to the End of the Part Number
Example: 1/8" Round Bead Roll 204-125-HC



MB MITTLER BROS. MACHINE & TOOL

Jamey Jordan

SIGNATURE SERIES

Mittler Bros. is proud to offer Jamey Jordan Signature Series of Bead Rollers & Unique Rolls. Check out some of the unique artistic type work you can do with this combination.



"I had these ideas and concepts about how I could shape the metal, but there really wasn't a die on the market that could facilitate my ideas, so I teamed up with Mittler Brothers and created my own."

- Jamey Jordan

Bead Roller Layout Templates

- Saves Time and Material
- 1/8" Aluminum for Long Life
- Laser Engraved



Arc Layout Template 202-415
2" to 6" Radius

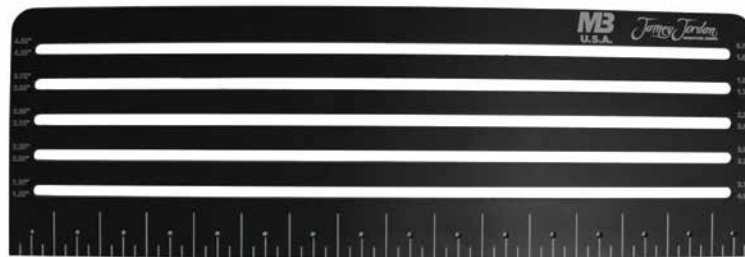

Straight Layout Template 202-410
.5" to 4.75" Spacing



Hole Layout Template 202-405
.875" to 2.25 Diameter"

Rivet / Bead Roll Layout Tool

- Allows Infinite Combinations of Spacing
- Retractable Design
- Laser Engraved



Rivet / Layout Tool 202-400



Standard Motor Bead Roller w/ Adjustable Shaft

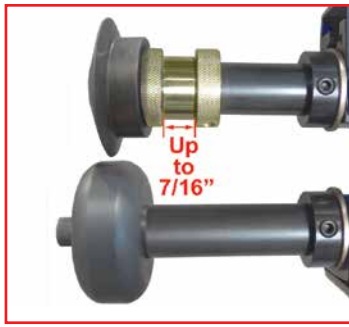

Adjustable Shaft Allows For A Greater Range Of Motion

Bead Rolls Sold Separately



Max Capacity
 19 Ga (.040") Mild Steel
 16 Ga (.050") Aluminum
 24 Ga (.025") Stainless

- 24" Model - Billet Aluminum Frame
- 36" Model - Jig Welded Steel Frame
- 100+ Bead Roll Profiles (See pages 20-22)
- 1-1/8" Throat Height
- Adjustable Depth of Bead
- Oilite Bushings for Long Life
- Variable Speed Foot Pedal Operated
- Forward / Reverse Switch
- Shaft Driven & Adjustable Up To 7/16"

Standard Motor Bead Rollers w/ Adjustable Shaft

See page 18 for Standard Motor specs.

24" Throat Depth Variable Speed Bead Roller
 With Upper Adjustable Shaft

Model 202-24

36" Throat Depth Variable Speed Bead Roller
 With Upper Adjustable Shaft

Model 202-36

Industrial Motor Bead Roller w/ Adjustable Shaft

Adjustable Shaft Allows For A Greater Range Of Motion



Max Capacity
 16 Ga (.059") Mild Steel
 14 Ga (.064") Aluminum
 22 Ga (.031") Stainless

Bead Rolls Sold Separately

Industrial Motor Bead Rollers w/ Adjustable Shaft

24" Throat Depth Industrial Variable Speed Bead Roller
 With Upper Adjustable Shaft

Model 202-24NV

36" Throat Depth Industrial Variable Speed Bead Roller
 With Upper Adjustable Shaft

Model 202-36NV

Increased Motor Torque & Horsepower To Handle Up To 16 Ga Mild Steel

Upgrade Your Existing Bead Roller With An Adjustable Shaft

All the parts required to upgrade Bead Roller Models:
 210-24, 210-24NV, 200-36, 200-36NV, 210-24M

Adjustable Shaft Upgrade Kit

24" **Model 202-022**

36" **Model 202-061**



Jamey Jordan Signature Series



Close Up

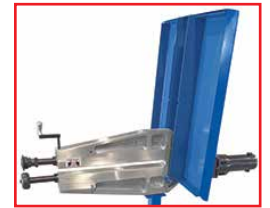

In Upright Position

24" or 36" Bead Roller Table
Model 202-200

- Supports Material While You Work
 (Bead Roller Not Included)
 (Not For Use On High Throat Models, See Page 32)



Jamey Jordan

Art Of Bead Rolling Vol. 1 DVD
MB-1000-JJ1...

Jamey shows you how to lay out and execute basic designs as well as logos with this How-To DVD.

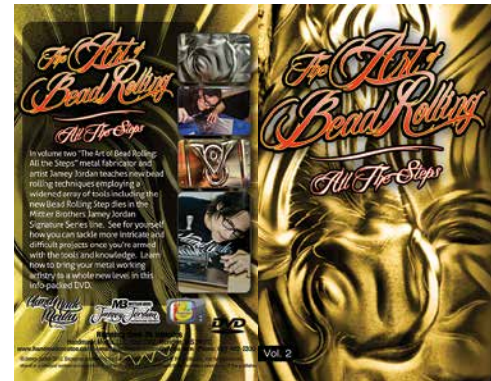

Jamey Jordan

Art Of Bead Rolling Vol. 2 DVD
MB-1000-JJ2...

Learn how to bring your metal working artistry to a whole new level in this info packed DVD.

Jamey Jordan Signature Series Bead Roller Kit

This kit includes everything you need to get started with the "Fine Art" of bead rolling.

Jamey Jordan Signature Series Bead Roller Kit

24" Model 202-24NV-K

36" Model 202-36NV-K

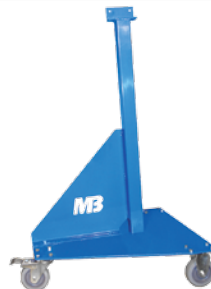

Rolling Stand w/ Locking Casters
Model 200-150

Each kit includes:

- 202-100 Art Roll Kit (4 Rolls)
- 202-105 Soft Step Set
- 202-24NV or 202-36NV Bead Roller
- 202-200 Bead Roller Table
- 200-150 Rolling Stand
- MB-1000-JJ1 Instructional DVD



202-24NV
24" Bead Roller



202-200
Bead Roller Table



Jamey Jordan Signature Series Bead Rolls

For Use With All Standard (1-1/8" Throat) Bead Rollers

These Rolls Work Best When Used With A Bead Roller With Adjustable Shaft



* All of the "Jamey Jordan Signature Series" rolls will fit existing Mittler Bros. Standard (1-1/8" Throat) Bead rollers.



202-090
Soft Step Roll



202-091
Radius Step Roll



202-092
45° Step Roll



202-101
Art Roll



202-102
Solid Roll



202-103
Solid Groove



202-104
Universal Groove

Individual Bead Rolls

Description	Part #	
Scar Roll Set (3 Rolls)	202-099	
Art Roll (1 Roll)	202-101	
Art Roll Delrin Plastic (1 Roll)	202-101-D	
Solid Roll (1 Roll)	202-102	
Solid Groove Roll (1 Roll)	202-103	
Universal Groove Roll (1 Roll)	202-104	
Soft Step Set (2 Rolls)	202-105	
Radius Step Set (2 Rolls)	202-106	
45° Step Set (2 Rolls)	202-107	
Soft Step Roll (1 Roll)	202-090	
Radius Step Roll (1 Roll)	202-091	
45° Step Roll (1 Roll)	202-092	
Skateboard Wheel Roll (3 Rolls)	202-108	
Stitching Set (2 Rolls)	202-109	
1/2" Radius Roll Set (2 Rolls)	202-100TR	
5/8" Radius Roll Set (2 Rolls)	202-125TR	
3/4" Radius Roll Set (2 Rolls)	202-150TR	
7/8" Radius Roll Set (2 Rolls)	202-175TR	

Scar Roll Set

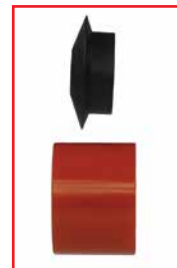

202-099
Scar 3pc. Kit

This set allows you to create a classic "Scar". The first roll combo makes the smooth line & The second roll combo makes the lines across.

Stitching Roll Set



This set will allow you to create a "Stitch" like effect which will open you up to all kinds of faux upholstered sheet metal projects.



202-109
Stitching 2pc. Set

Skateboard Wheel Roll 3pc. Set

Will allow you to use the bottom die with any existing top die to create any bead profile you can imagine. Three different hardness rolls are included.



Durometer or "Hardness" of the rolls:

Black = 60

Orange = 80

Blue = 90

Model 202-108



Jamey Jordan Signature Series Bead Rolls

For Use With All Standard (1-1/8" Throat) Bead Rollers

These Rolls Work Best When Used With A Bead Roller With Adjustable Shaft

Bead Roller Table Available
Page 28

* All of the "Jamey Jordan Signature Series" rolls will fit existing Mittler Bros. Standard (1-1/8" Throat) Bead rollers.

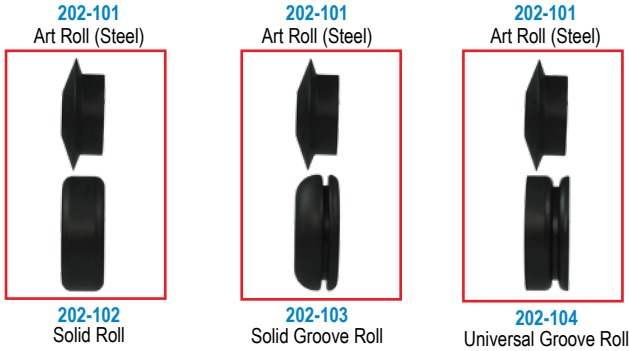

Jamey Jordan Signature Series Art Roll Kit

This 4 roll kit comes with all the rolls designed by Jamey Jordan for use in creating works of art on sheet metal using a bead roller.

Includes: 202-101, 202-102, 202-103, 202-104

#202-101 is available in nylatron upon request (#202-101-D)

Model 202-100



Jamey Jordan Signature Series Step Die Kit

These dies will allow a softer, smoother finish on your step. Each roll will allow you create its own unique bead profile.

Includes: 202-105, 202-106, 202-107

#202-101 is available in nylatron upon request (#202-101-D)

Model 202-094

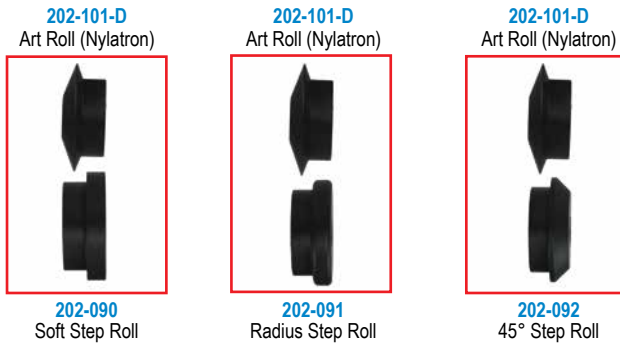

Jamey Jordan Signature Series Art Roll Step Kit

The ability to use the Top Nylatron Art Roll, with the lower step rolls, is to work in small extremely tight areas that do not effect the outside areas. The Top Art Roll allows the creation of highly defined steps and bead profiles.

Includes: 202-101-D, 202-090, 202-091, 202-092

Model 202-095

Tube Roll Sets

* These Rolls Work Best When Used With A Bead Roller With Adjustable Shaft

These roll sets shape sheet metal up into a radius bend to allow tubing to sit flush against it.

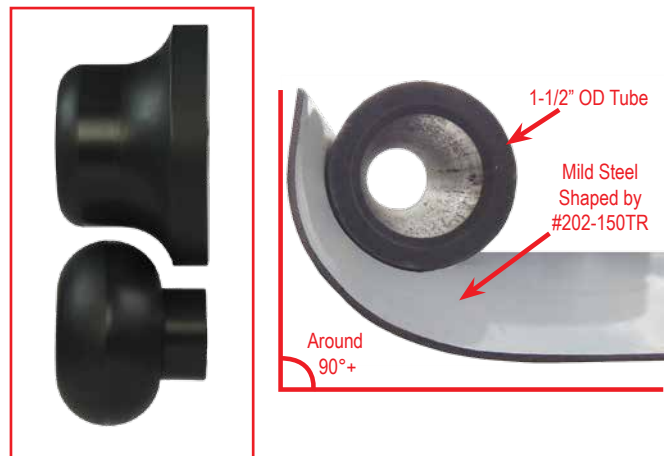

202-100TR 1/2" Radius 1" Tube	202-125TR 5/8" Radius 203- 1/4" Tube	202-150TR 3/4" Radius 203- 1/2" Tube	202-175TR 7/8" Radius 1-3/4" Tube
--	---	---	--



4" High Throat Standard Bead Roller w/ Adjustable Shaft



MB MITTLER BROS.
MACHINE & TOOL
Jamey Jordan
SIGNATURE SERIES

Bead Rolls Sold Separately

- 24" & 36" Models Available
- Rigid Steel Frame
- Large Selection of Bead Roll Profiles
- 4" High Throat for Extra Clearance
- Adjustable Depth of Bead
- Oilite Bushings for Long Life
- Variable Speed Foot Pedal Operated
- Forward / Reverse Switch
- Shaft Driven & Adjustable Up To 7/16"

Max Capacity
19 Ga (.040") Mild Steel
16 Ga (.050") Aluminum
24 Ga (.025") Stainless

24" Throat Depth 4" High Throat Bead Roller **Model 202-24-HT**
With Upper Adjustable Shaft

36" Throat Depth 4" High Throat Bead Roller **Model 202-36-HT**
With Upper Adjustable Shaft

4" High Throat Industrial Bead Roller w/ Adjustable Shaft



Max Capacity
18 Ga (.047") Mild Steel
14 Ga (.064") Aluminum
24 Ga (.025") Stainless

Bead Rolls Sold Separately

- 24" & 36" Models Available
- Rigid Steel Frame
- Large Selection of Bead Roll Profiles
- 4" High Throat for Extra Clearance
- Adjustable Depth of Bead
- Oilite Bushings for Long Life
- Variable Speed Foot Pedal Operated
- Forward / Reverse Switch
- Speed Range Adjustment Knob

24" Throat Depth 4" High Throat Industrial Variable Speed Bead Roller **Model 202-24NV-HT**
With Upper Adjustable Shaft

36" Throat Depth 4" High Throat Industrial Variable Speed Bead Roller **Model 202-36NV-HT**
With Upper Adjustable Shaft

Increased Motor Torque & Horsepower To Handle Up To 18 Ga Mild Steel

Upgrade Your Existing High Throat Bead Roller With An Adjustable Shaft

All the parts required to upgrade Bead Roller Models:
204-24, 204-24NV, 204-36, 204-36NV

Adjustable Shaft Upgrade Kit

24" **Model 202-022-HT**

36" **Model 202-061-HT**



Jamey Jordan Signature Series Bead Rolls

For Use With All High Throat (4" Throat) Bead Rollers

These Rolls Work Best When Used With A Bead Roller With Adjustable Shaft

* All of the "Jamey Jordan Signature Series" High Throat rolls will fit existing Mittler Bros. High Throat (4" Throat) Bead rollers.



Individual Bead Rolls	
Description	Part #
Art Roll (1 Roll)	202-101-HT
Solid Roll (1 Roll)	202-102-HT
Solid Groove Roll (1 Roll)	202-103-HT
Universal Groove Roll (1 Roll)	202-104-HT

Jamey Jordan Signature Series Art Roll Kit

This 4 roll kit comes with all the rolls designed by Jamey Jordan for use in creating works of art on sheet metal using a high throat bead roller.

Includes: 202-101-HT, 202-102-HT, 202-103-HT, & 202-104-HT

Model 202-100-HT



High Throat Bead Roller Table

Supports Material While You Work



New Table Designed Specifically for your High Throat Bead Roller!

Model 202-200-HT

(Not For Use with Standard Bead Rollers - See Page 28)



Triangle Punch & Flares

For Use In Press to Punch Smooth, Flared Triangle Holes in Sheet Metal Panels

- Heat Treated Tool Steel For Long Life
- Drill Template Included

MB MITTLER BROS.
MACHINE & TOOL
Jamey Jordan
SIGNATURE SERIES

Jamey Jordan Signature Series

Material Thickness Capacity:
Aluminum .060"
Mild Steel .060"
Stainless Steel .040"



1-1/2"	Model 1330-010
2"	Model 1330-020
2-1/2"	Model 1330-030
3 Punch Kit	Model 1330-100

Kit Includes 3 Punches and 1 Universal Press Block

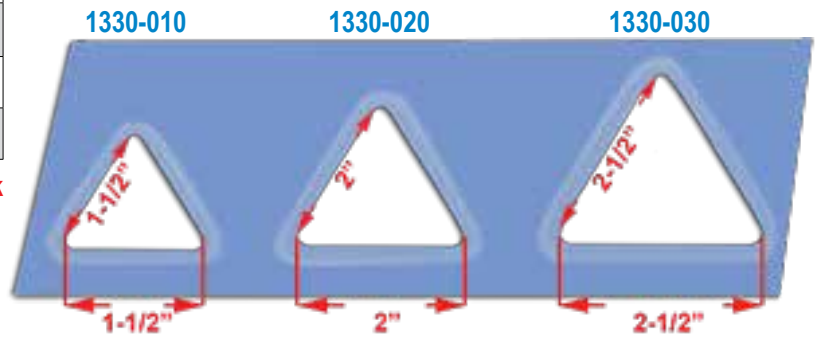

Universal Press Block Model 1330-001

Oval Punch & Flares

For Use In Press to Punch Smooth, Flared Oval Holes in Sheet Metal Panels

- Heat Treated Tool Steel For Long Life
- Drill Template Included
- Requires Universal Press Block

Material Thickness Capacity:
Aluminum .060"
Mild Steel .060"
Stainless Steel .040"

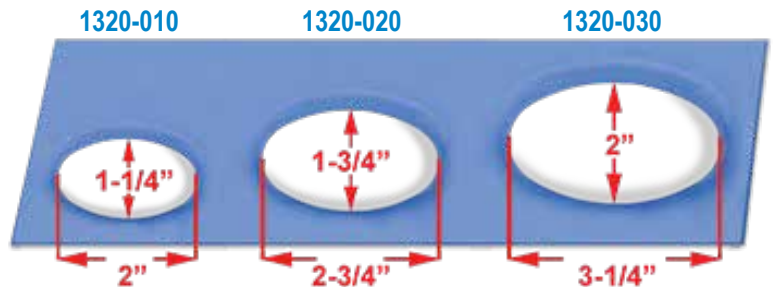

Universal Press Block Model 1320-001



- Fits All Sizes
- Only One Needed

1-1/4" x 2"	Model 1320-010	
1-3/4" x 2-3/4"	Model 1320-020	
2" x 3-1/4"	Model 1320-030	
Oval Punch Kit	Model 1320-100	

Kit Includes 3 Punches and 1 Universal Press Block



Variable Speed Rotary Machine Kit

14" Throat Variable Speed Rotary Machine Kit Includes #200-009-R Depth Stop & One Roll Set of your choice

- 7/8" Throat Height
- 3/8" Plate Construction
- Ideal for Production Work
- Keyed Shafts 1/8" X 1/16"
- Electric Motor With Magnetic Disc Brake
- Variable Speed, Foot Pedal Operated 0 - 24 RPM
- Needle Bearings
- Ships UPS 95 Lbs.

**Consult Factory
On Stainless Steel
Applications**

**Max Capacity:
14 Ga (.074") Mild Steel
Standard Bead Only**

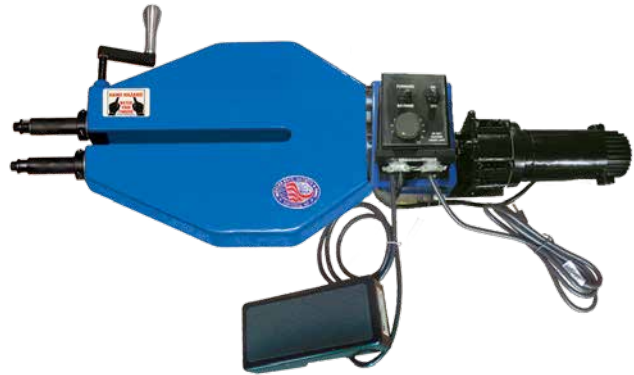

Model 200-14NV

10" Throat Variable Speed Rotary Machine Kit Includes #200-009-R Depth Stop & One Roll Set of your choice



Model 200-10NV

- 1-1/8" Throat Height
- 2" x 3" x 3/16" Tube Construction
- Electric Motor With Magnetic Disc Brake
- Variable Speed, Foot Pedal Operated 0 - 24 RPM
- Keyed Shafts 1/8" X 1/16"
- Oilite Bushings
- Ships UPS 65 Lbs.

**Max Capacity:
16 Ga (.059") Mild Steel
Standard Bead Only**

**Consult Factory
On Stainless Steel
Applications**

Accessories

Floor Stands

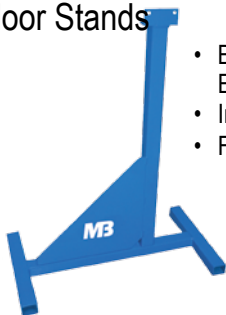

**H- Frame
Model 200-031**

- Bolt Together Design For Easy Shipping
- Industrial Coated Finish
- Fits Rotary Machines



**Rolling Stand w/ Locking Casters
Model 200-150**

Depth Stop



**Depth Stop
Model 200-009-R**

Roll Holder



**Roll Holder
Model 200-RH**



Rotary Machine Roll Sets

Specialty Roll Sets		
Description	Steel P/N	
Combo 2" Crimp & 5/16" Bead <small>(Contains a Crimp Roll Set & a Bead Roll Set)</small>	201-081-K	
2" Crimp Roll Set	201-003-K	
Duct Work "V" Groove Roll Set	201-079-K	
Elbow Edge Roll Set	201-064-K	
Fire Damper Roll Set	201-055-K	
Hem Roll Step #1 (1/4" 90°)	201-059-SK	
Hem Roll Step #1 (3/8" 90°)	201-008-K	
Hem Roll Step #2 (140°)	201-060-SK	
Hem Roll Step #3 Flat	201-068-K	
Hem Roll Set Combo	201-037-K	
Gore Edge Roll Set	201-054-K	
Offset Swedge Roll Set	201-078-K	
OGEE Roll Set	201-074-K	
Shear Roll Set	201-058-K	
Spin Collar #1 Roll Set	201-051-K	
Spin Collar #2 Roll Set	201-052-K	
Turning Roll Set	201-053-K	
Flange Roll Sets		
1/4" Flange Roll Set	201-057-K	
3/8" Flange Roll Set	201-056-K	
Edge Bead Roll Sets		
1/8" Edge Bead Roll Set	201-125-EK	
3/16" Edge Bead Roll Set	201-188-EK	
1/4" Edge Bead Roll Set	201-250-EK	
5/16" Edge Bead Roll Set	201-313-EK	
3/8" Edge Bead Roll Set	201-375-EK	
1/2" Edge Bead Roll Set	201-500-EK	
Round Bead Roll Sets		
1/8" Round Bead Roll Set	201-125-K	
3/16" Round Bead Roll Set	201-188-K	
1/4" Round Bead Roll Set	201-250-K	
5/16" Round Bead Roll Set	201-313-K	
3/8" Round Bead Roll Set	201-375-K	
1/2" Round Bead Roll Set	201-500-K	
1" Round Bead Roll Set	201-100-K	
Flat Bead Roll Sets		
1/8" Flat Bead Roll Set	201-125-FK	
3/16" Flat Bead Roll Set	201-188-FK	
1/4" Flat Bead Roll Set	201-250-FK	
5/16" Flat Bead Roll Set	201-313-FK	
3/8" Flat Bead Roll Set	201-375-FK	
1/2" Flat Bead Roll Set	201-500-FK	
Step Roll Sets		
1/16" Step Roll Set	201-062-SK	
1/8" Step Roll Set	201-125-SK	
45° Step Roll Set	201-045-SK	

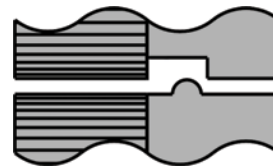

Combo Crimp & Bead
(2 roll set)
201-081-K



2" Crimp
Roll Set
201-003-K

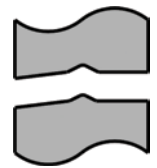

Duct Work
"V" Set
201-079-K



Elbow Edge Set
201-064-K

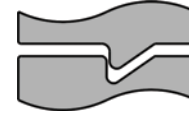

Fire Damper Set
201-055-K



Flange Roll Set
201-056-K

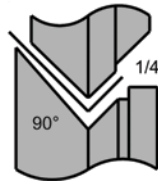

Hem Step #1
201-059-SK

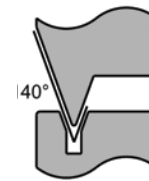

Hem Step #2
201-060-SK

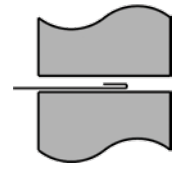

Hem Step #3
201-068-SK



Gore Edge Set
201-054-K



Off Set Swedge
201-078-K

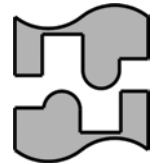

OGEE Set
201-074-K



Shear Roll
201-058-K



Spin Collar
Step 1
201-051-K



Step 2
201-052-K



Round Bead Roll
201-052-K



Flat Bead Roll
201-125-FK



Std. Step Roll
201-062-K



45° Step Roll
201-045-K

Roll Sets for Rotary Machines Use a 1/8" keyway
-K Stands For Keyed

All Standard Roll Sets
2-1/2" OD x 3/4" ID



Hydraulic Bench Presses



5 Ton Hydraulic Bench Press

Max Tooling Capacity
3" Punch & Flare &
16 Ga Mild Steel

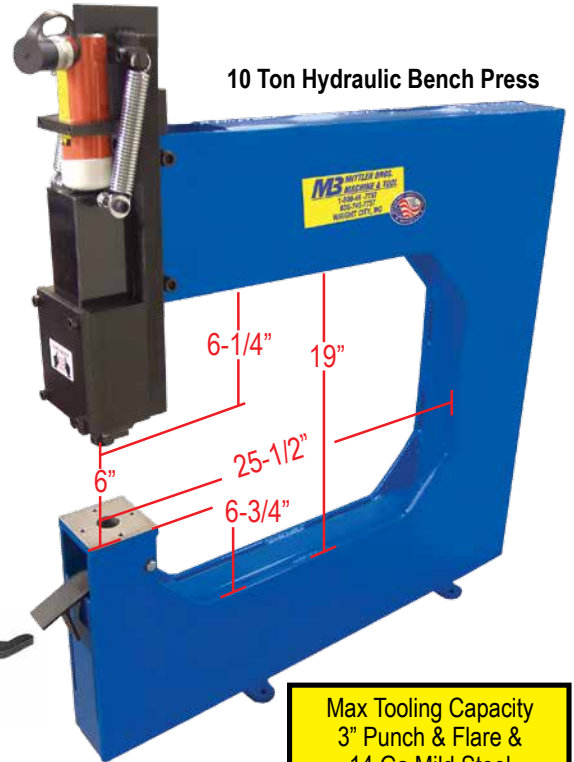

10 Ton Hydraulic Bench Press

Max Tooling Capacity
3" Punch & Flare &
14 Ga Mild Steel



See Website for Adapter



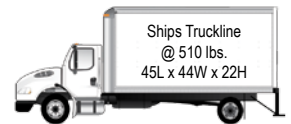

- Rugged Welded Plate/ Box Tube Construction
- Mount Tooling For Straight in use or Rotate 90° for side to side use
- Includes Slug Ejector, Spring Loaded Centering Pin, Tool Mount Adapter & Arbor Nut Wrench
- Can be Used as Standard Press or Arbor Press
- 3" Maximum clearance between tooling
- Ideal for production work

5 Ton Hydraulic Bench Press **Model 2200-H**
10 Ton Hydraulic Bench Press **Model 2210-H**

Hydraulic Pumps Sold Separately

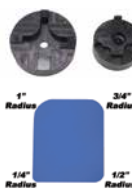

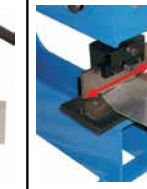
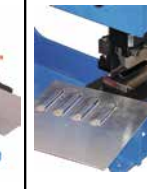
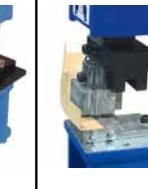
Accepts All Bench Press & Louver Press Tooling (pp. 34-36)
Most Tooling mounts for front to back use or rotate 90° for side to side use

 Corner Radius Punch	 90° Degree Bend	 Corner Punch	 Shear	 Louver Punch / Die	 Shrinker / Stretcher Deep Throat	 Punch & Die Mounting Kit Round, Square & Oblong Punches	 Punch & Flare
---	---	--	---	--	---	---	---

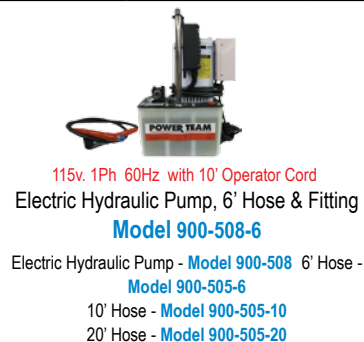

Manual Bench Presses

3 Ton Manual Bench Press

Model 2200-M

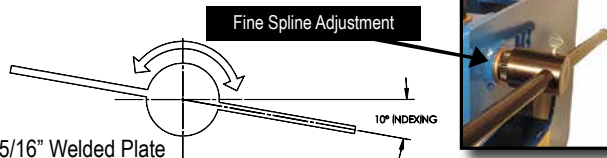
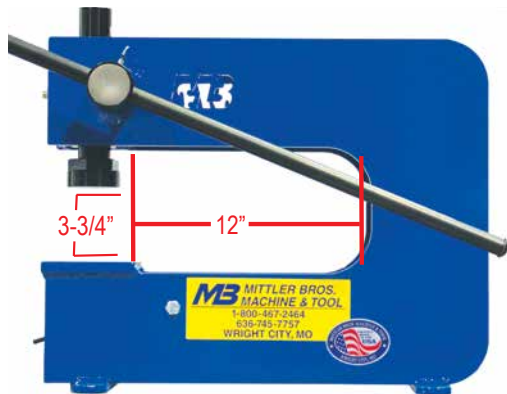

- Rugged 5/16" Welded Plate
- Can be Used as Standard Press or Arbor Press
- 1" Clearance Between Mounted Tooling
- Mount Tooling for Front to Back Use or Rotate 90° for side to side Use
- Includes Slug Ejector, Spring Loaded Centering Pin & Arbor Nut Wrench



Maintain Consistent Depth Across Work Piece
Bench Press Ram Stop **Model 2200-RS**

Max Tooling Capacity
3" Punch & Flare &
16 Ga Mild Steel
Tooling & Dies Sold Separately



- Same Great Features As All Our Manual Bench Presses
- Two 12" Deep Throats
- Mount 2 Types Of Tooling Simultaneously
- Ideal For Production Use
- Includes Slug Ejector, Spring Loaded Centering Pin & Arbor Nut Wrench

Dual Manual Bench Press - 3 Ton
Model 2240-2M...



- Rugged 5/16" Welded Plate Construction
- Two 12" Deep & Two 3" Deep Throats
- Mount 4 Types Of Tooling Simultaneously
- Ideal For Production Use



Quad Manual Bench Press - 3 Ton
Model 2240-4M...

- Can be added to any 2200 Series existing press
- Allows 10 degree Indexing
- Allows fast positioning of handle
- No Tool Adjustment



Quick Index Press Handle
Kit **Model 2200-IH...**

Small Manual Bench Press **Model 2240-1M...**

The Small Bench Press is perfect for those of us with limited space in their garages or shops and it still has all the same great tooling options as all of our presses

- Rugged 5/16" Welded Plate Construction
- 3" Deep Throat
- Ideal For Production Use
- Can Be Mounted On Any Stable Surface Using The Included Hole Drill Template

Can Be Mounted On Either Side
Of Model #2240-2M
Dual Manual Bench Press

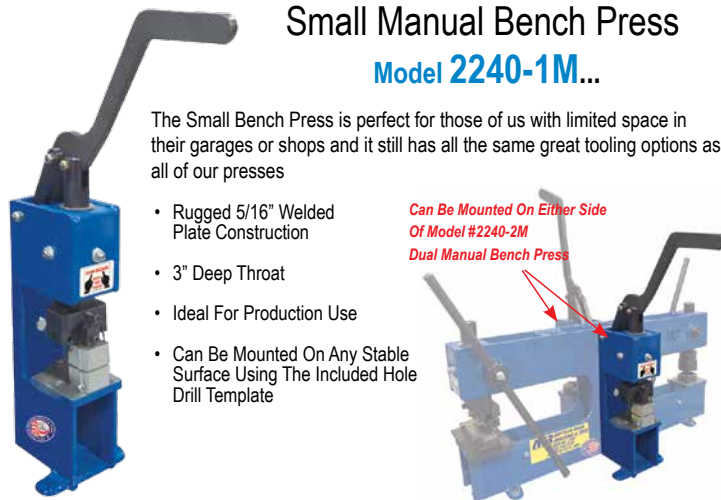

Bench Press Accessories

Fits All Bench Presses & Louver Press Kits

Most Tooling mounts for front to back use or rotate 90° for side to side use



Bench Press Louver Punch Start-Up Kits		
Size	Part #	
1"	2200-LA-01	
2"	2200-LA-02	
3"	2200-LA-03	
4"	2200-LA-04	
5"	2200-LA-05	
3" Dome	2200-LA-06	
4" Dome	2200-LA-07	
Individual Louver Punch Dies		
1"	500-041	
2"	500-042	
3"	500-043	
4"	500-044	
5"	500-045	
3" Dome	500-046	
4" Dome	500-047	



Bench Press Louver Punch / Die

Max Capacity:
16 Ga (.059") Mild Steel

← Order a **Bench Press Louver Punch Start Up Kit**, with the size of punch you want, from the top list.

← After that you will just have to order the **Individual Louver Punch Die Sets** from the bottom list.

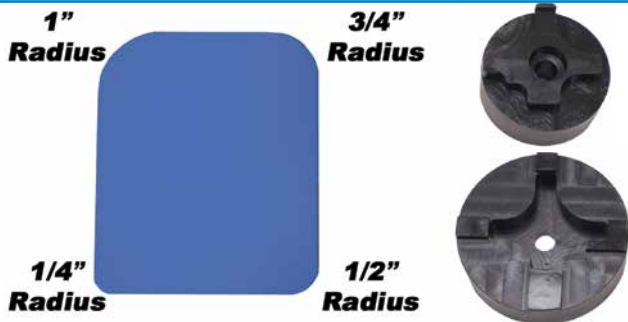
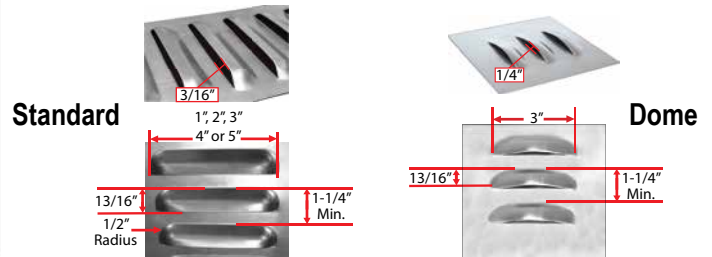

Corner Radius Punch

Punch four different radius corners to give your part that nice finished look. Two ranges of radii to choose from. Create uniform rounded corners.

1/4", 1/2", 3/4", 1"
 1-1/4", 1-1/2", 1-3/4" & 2" **Model 2200-4RCP**
Model 2200-020-A

Max Capacity: 8 Ga (.125") Soft Alum. & 16 Ga (.059") Mild Steel

Dzus® Punch



Dzus® Punch makes perfect #5 (1 inch spacing) and #6 (1-3/8 inch spacing) Dzus button and spring holes in one operation.

Includes:
 #5 (1" Spacing)
 #6 (1-3/8" Spacing)

Model 2200-DZ-5/6...

Max Capacity
 19 Ga (.040") Mild Steel
 18 Ga (.040") Aluminum

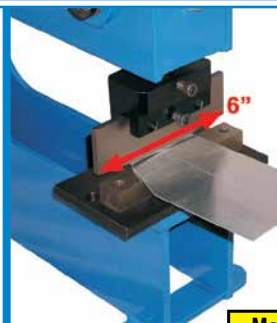

Shear

Great for cutting sheet metal up to 19 Ga mild steel. Cut your blanks for the corner punch & 90° brake shown below. Up to 6" Width.

Model 2200-SA.....

Max Capacity: 19 Ga (.040") Mild Steel

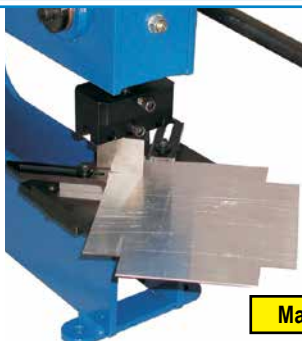

Corner Punch

Great for making those little boxes and trays. Creates 1/8" x 1/8" to 1-1/2" x 1-1/2" cut out.

Model 2200-CPA...

Max Capacity: 16 Ga (.059") Mild Steel



90° Degree Brake

Finish up those boxes & trays with this handy brake. Up to 4-1/2" Width

Includes Ram Adapter

Model 2200-90DA.....

Max Capacity: 11 Ga (.120") Mild Steel



Bench Press Accessories

Fits All Bench Presses & Louver Press Kits

Most Tooling mounts for front to back use or rotate 90° for side to side use

Shrinker / Stretcher Deep Throat



Max Capacity:
18 Ga (.047") Mild Steel

With a deep throat depth, it makes forming compound panels quick and easy. Shrinker and stretcher jaws swap out in seconds. Extra throat clearance when shrinking or stretching panels. Mounts in Bench Press (#2200-M, #2240, #2200-H, #2210-H) & Louver Press Kit

Shrinker / Stretcher Deep Throat Set with Adaptors

Model 550-100.

Shrinker Deep Throat Set with Adaptors

Model 550-101..

Stretcher Deep Throat Set with Adaptors

Model 550-102..

Press Brake Mounting Adapter Kit

Allows the mounting of all Mittler Bros. Press Tooling into any manufacturers press brake.

Model 2200-096A.....

Includes:

QTY: 1 #2200-96 Lower Mount Adapter

QTY: 1 #2200-97 Upper Mount Adapter

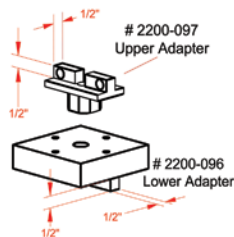

Tube Flattening Die

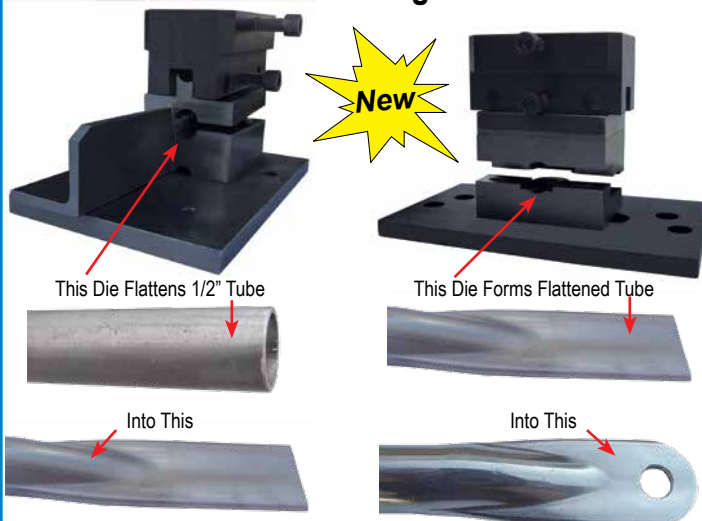

Tube Flattening Die

- 3/8" 2200-TF.375
- 1/2" 2200-TF.500
- 5/8" 2200-TF.625
- 3/4" 2200-TF.750

Tube Punch & Radius Die

- 3/8" - 1/2" 2200-TPR
- 5/8" - 3/4" 2200-TPR2

This punch press operation is a cost-effective way to produce a flat tube end for tubular assemblies. This is a two step operation, one step for flattening the tube, while the other radius the corners and punches a hole in one motion.

Designed For .045" Wall

Punch & Die Mounting Kit

Includes Coupling Nut and Die Holder

Model 2200-040...

(Required for Round, Oblong, Square, Hex, & Metric Punch & Die Sets
Punch & Die Sold Separately)

Max Capacity
16 Ga (.059") Mild Steel
12 Ga (.080") Aluminum



WHEN ORDERING Punch & Die Sets Provide: Material Type & Material Thickness to Determine Die Clearance



Punch & Die Sets

Round, Oblong, Square & Hex

Punch & Die Sets

Each Set Contains One Individual Size

#2200-515 Round Punch / Die Set - per size

5/32" up to 1-1/16" (w/Urethane Stripper)

#2200-516 Oblong Punch / Die Set - per size 3/16" x 3/4" up to 13/16" x 1" (w/Urethane Stripper)

#2200-517 Square Punch / Die Set - per size 1/4" x 1/4" up to 13/16" x 13/16" (w/Urethane Stripper)

#2200-518 Hex Punch / Die Set - per size 11/32" up to 27/32" (w/Urethane Stripper)



Individual Punch & Die Set Complete As Shown



Automotive Punch & Flare Tools

Automotive Punch & Flare Sets		
Size	Part #	
1"	1300-013	
1-1/4"	1300-014	
1-1/2"	1300-015	
1-3/4"	1300-016	
2"	1300-017	
2-1/2"	1300-018	
3"	1300-020	

Punch & Flare



Punch & Bead



Automotive Punch & Bead Sets		
Size	Part #	
1"	1300-013-B	
1-1/4"	1300-014-B	
1-1/2"	1300-015-B	
1-3/4"	1300-016-B	
2"	1300-017-B	
2-1/2"	1300-018-B	
3"	1300-020-B	

Punch & Flare Kit 1" thru 2-1/2"
Model 1300-402...

Punch & Flare Set 1" thru 3"
Model 1300-403...

Max Thickness:
Aluminum 14 Ga (.064")
Mild Steel 16 Ga (.059")
Stainless Steel 19 Ga (.043")

Max Thickness:
Aluminum 18 Ga (.040")
Mild Steel 19 Ga (.040")
Stainless Steel 20 Ga (.037")

Punch & Bead Kit 1" thru 2-1/2"
Model 1300-402-B

Punch & Bead Kit 1" thru 3"
Model 1300-403-B

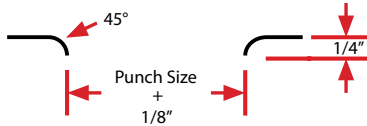

Just drill a pilot hole for the draw bolt, then apply the tool and tighten the bolt for a smooth, flared or beaded hole in one easy step. Punch hole only by removing female flare ring and use punch and die. Easily mounts in our Bench Presses.



Automotive Punch / Flare

Gauge Hole Punches

2-1/16" Hole Punch Model 1300-028

2-1/4" Hole Punch Model 1300-026

2-5/8" Hole Punch Model 1300-021

3-3/8" Hole Punch Model 1300-030

4-(Small Autometer Tachometer)

Capacity :
Mild Steel 16 Ga

Aircraft Punch & Flare Tools

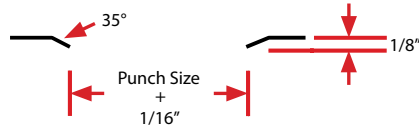

Aircraft Punch / Flare

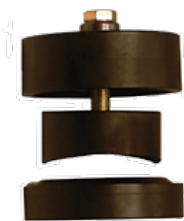

Max Thickness:
Aluminum 14 Ga (.064")
Mild Steel 16 Ga (.059")
Stainless Steel 19 Ga (.040")

Aircraft Punch & Flare Sets

Size	Part #	
1"	1300-030AC35	
1-1/4"	1300-031AC35	
1-1/2"	1300-032AC35	
1-3/4"	1300-033AC35	
2"	1300-034AC35	
2-1/4"	1300-035AC35	
2-1/2"	1300-036AC35	
2-3/4"	1300-037AC35	
3"	1300-038AC35	
3-1/8"	1300-039AC35	
3-1/4"	1300-040AC35	
3-1/2"	1300-041AC35	
3-3/4"	1300-042AC35	
4"	1300-043AC35	
5"	1300-044AC35	
6"	1300-045AC35	

Instrument Hole Punches



Instrument Hole Punches

Size	Part #	
2-1/4"	1300-026	
3-1/8"	1300-029	

Capacity : Mild Steel 16 Ga

Just drill a pilot hole for the draw bolt, then apply the tool and tighten the bolt for a smooth, flared in one easy step. Punch hole only by removing female flare ring and use punch and die. Easily mounts in our Bench Presses.

6pc Punch & Flare Set 1" thru 2-1/2"
(does not include 2-1/4")
Model 1300-415

7pc Punch & Flare Set 1" thru 3"
(does not include 2-1/4" or 2-3/4")
Model 1300-412

9pc Punch & Flare Set 1" thru 3"
Model 1300-414

13pc Punch & Flare Set 1" thru 4"
Model 1300-413
(does not include 3-1/8")



MB MITTLER BROS. MACHINE & TOOL

Jamey Jordan SIGNATURE SERIES

Triangle Punch & Flares

For Use In Press to Punch Smooth, Flared Triangle Holes in Sheet Metal Panels

- Heat Treated Tool Steel For Long Life
- Drill Template Included



Material Thickness Capacity:
 Aluminum .060"
 Mild Steel .060"
 Stainless Steel .040"

1-1/2"	Model 1330-010
2"	Model 1330-020
2-1/2"	Model 1330-030
3 Punch Kit	Model 1330-100

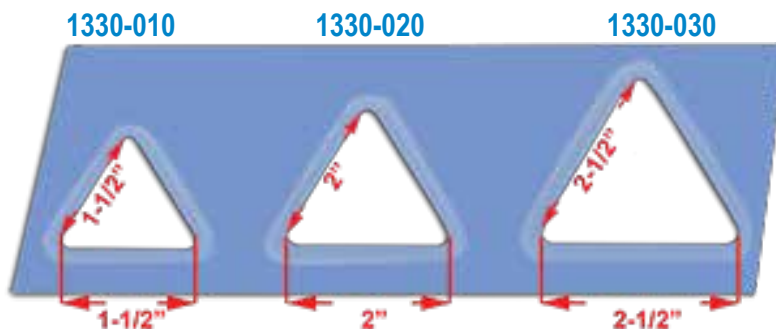

Universal Press Block

Model 1330-001

Kit Includes 3 Punches and 1 Universal Press Block

Oval Punch & Flares

For Use In Press to Punch Smooth, Flared Oval Holes in Sheet Metal Panels

- Heat Treated Tool Steel For Long Life
- Drill Template Included
- Requires Universal Press Block

Material Thickness Capacity:
 Aluminum .060"
 Mild Steel .060"
 Stainless Steel .040"



1-1/4" x 2"	Model 1320-010
1-3/4" x 2-3/4"	Model 1320-020
2" x 3-1/4"	Model 1320-030
Oval Punch Kit	Model 1320-100

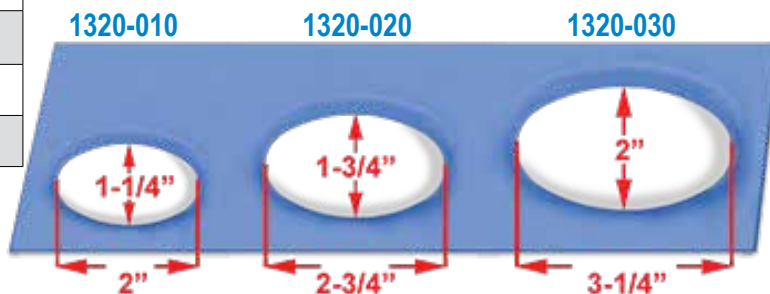

Kit Includes 3 Punches and 1 Universal Press Block



Universal Press Block

Model 1320-001

- Fits All Sizes
- Only One Needed



Dimple Dies



- Adds Strength
- 1/4" Radius
- Enhanced Appearance

Max Capacity:
0.125" Mild Steel
4130 Chrome Moly

- 4 Piece Dimple Die Kit
(1/2", 1", 1-1/2", & 2")
Model # 1310-310
- 5 Piece Dimple Die Kit
(1/2", 1", 1-1/2", 2" & 2-1/2")
Model # 1310-311
- 6 Piece Dimple Die Kit
(1/2", 1", 1-1/2", 2", 2-1/2" & 3")
Model # 1310-312
- 7 Piece Dimple Die Kit
(1/2", 3/4", 1", 1-1/4", 1-1/2", 1-3/4", & 2") **Model # 1310-313**
- 9 Piece Dimple Die Kit
(1/2", 3/4", 1", 1-1/4", 1-1/2", 1-3/4", 2", 2-1/2" & 3")
Model # 1310-314

Dimple Dies		
Size	Part #	
1/2"	1310-301	
3/4"	1310-302	
1"	1310-303	
1-1/4"	1310-304	
1-1/2"	1310-305	
1-3/4"	1310-306	
2"	1310-307	
2-1/2"	1310-308	
3"	1310-309	

Flare Tools



Max Capacity:
0.063" Mild Steel

Flare tool guide ring centers tooling in your precut hole then draw together with supplied bolt.

- Adds Strength
- Enhanced Appearance

Flare Kit (1/2" thru 2-1/2")
Model 1300-401

Automotive Flare Sets		
Size	Part #	
1/2"	1300-001	
5/8"	1300-002	
3/4"	1300-003	
1"	1300-004	
1-1/4"	1300-005	
1-1/2"	1300-006	
1-3/4"	1300-007	
2"	1300-008	
2-1/2"	1300-009	

Forming Dies



Round



Triangle



Oval

Round Forming Die Sets		
Size	Part #	
1/2"	1340-010	
5/8"	1340-020	
3/4"	1340-030	
1"	1340-040	
1-1/4"	1340-050	
1-1/2"	1340-060	
1-3/4"	1340-070	
2"	1340-080	
2-1/2"	1340-090	

Oval Forming Die Sets		
Size	Part #	
1-1/4" x 2"	1350-010	
1-3/4" x 2-3/4"	1350-020	
2" x 3-1/4"	1350-030	
Set	1350-100	

Triangle Forming Die Sets		
Size	Part #	
1-1/2"	1360-010	
2"	1360-020	
2-1/2"	1360-030	
Set	1360-100	



Louver Press Kit



- Each kit includes:**
- 10-Ton Hydraulic Ram
 - Die Mounting Plate
 - Precision Slide Assembly
 - Blueprints, Bill of Material and Instructions for building a 48" Throat Louver Press Frame.



Frame To Be Built By Customer

Maximum Tooling Capacity
3" Punch & Flare &
14 Ga Mild Steel

Frame To Be Built By Customer

Hydraulic Pump Sold Separately

Standard

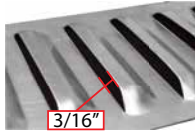

1", 2", 3"
4" or 5"

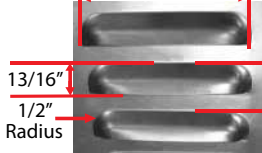

Dome

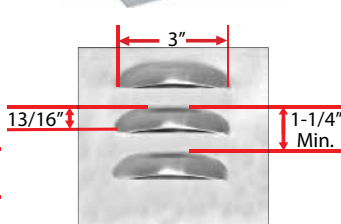

LOUVER PRESS KIT (With Hydraulic Ram & Slide Assembly)		
Size	Part #	
1"	500-LA-041	
2"	500-LA-042	
3"	500-LA-043	
4"	500-LA-044	
5"	500-LA-045	
3" Dome	500-LA-046	
4" Dome	500-LA-047	
INDIVIDUAL LOUVER PUNCHES/DIE (Punch & Die only)		
Size	Part #	
1"	500-041	
2"	500-042	
3"	500-043	
4"	500-044	
5"	500-045	
3" Dome	500-046	
4" Dome	500-047	

Accessories



90 PSI Compressed Air
Air Hydraulic Pump, 6' Hose & Fitting
Model 900-504-6

Air Hydraulic Pump - **Model 900-504**
6' Hose - **Model 900-505-6**
10' Hose - **Model 900-505-10**
20' Hose - **Model 900-505-20**



115v. 1Ph 60Hz with 10' Operator Cord
Electric Hydraulic Pump, 6' Hose & Fitting
Model 900-508-6

Electric Hydraulic Pump - **Model 900-508**
6' Hose - **Model 900-505-6**
10' Hose - **Model 900-505-10**
20' Hose - **Model 900-505-20**

Accepts All Bench Press & Louver Press Tooling (pp. 35-36)
Most Tooling mounts for front to back use or rotate 90° for side to side use

Corner Radius Punch	90° Degree Bend	Corner Punch	Shear	Louver Punch / Die	Shrinker / Stretcher Deep Throat	Punch & Die Mounting Kit Round, Square & Oblong Punches	Punch & Flare



Power Hammer

A Rugged, Robust Machine for the Metalworking Professional

Shaping, Shrinking & Stretching, and Soft Dies allow you to create compound shapes quickly & easily. The upper hammer stroke is adjustable to help produce the general shape and complete the finish work as well. A leather strap & leaf spring support the upper die assembly, which provides a cushioned blow that closely simulates shaping metal with a bossing mallet and shot bag. This allows a more controlled movement of the metal, unlike other methods which use metal to metal dies.

Throat Depth: 26"
1 Horsepower Motor
Approx 900 Blows Per Minute
Based on 60 lb. Yoder M2 Hammer

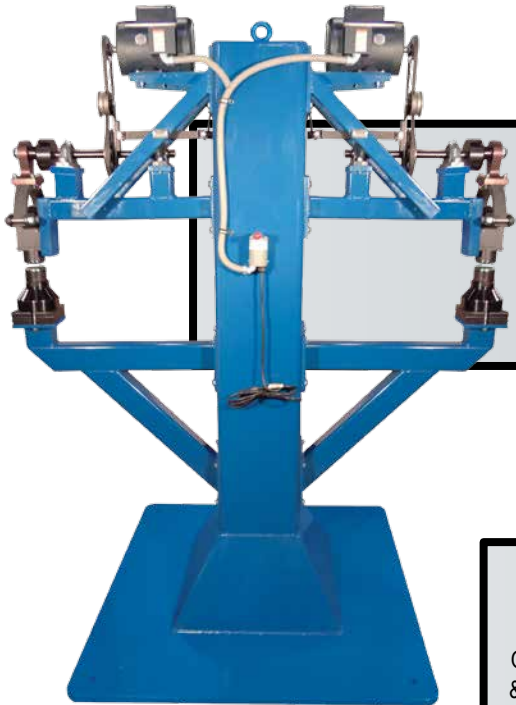

Double Headed Power Hammer
Model 4200-100

* Double Headed Power Hammer Kit

Model 4200-100

Two Power Hammer Assemblies Mounted on Fabricated Upper & Lower Arm Weldments, Assembled & Mounted on Pedestal, Adjustments & Calibrations Properly Set, Factory Tested, **Includes 1 complete set of Power Hammer Dies (8 Dies).**

* Single Head Power Hammer Kit

Model 4200-150

One Power Hammer Assembly Mounted on Fabricated Upper & Lower Arm Weldments, Assembled & Mounted on Pedestal, Adjustments & Calibrations Properly Set, Factory Tested - **Includes 1 Upper Flat Die & 1 Lower Radius Die**



Single Head Power Hammer Kit
Model 4200-150



Power Hammer - Single Head
 Less Upper & Lower Arm Weldments & Pedestal
Model 4200-200

Power Hammer - Single Head

Model 4200-200

Includes Ram, Anvil, Flywheel, Spring & Belting, 1 HP Motor, 3" Motor Pulley, 6" Motor Pulley, Rod End Bearings (2), Clutch Return Spring, Clutch Idler Pulley w/ Bolt & Spacer, Pillow Block Bearing(2), All Belts & Hardware, 1 Upper Flat Die & 1 Lower Radius Die,
(Customer must provide Upper & Lower Arm Weldments, and Pedestal)

**Call for a Truckline quote*



Power Hammer

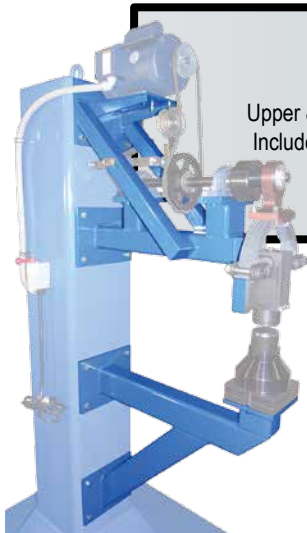

Fabricated Arms
Less Power Hammer Head & Pedestal
Model 4200-300

Fabricated Arms
Model 4200-300
 Upper & Lower Arm Weldment designed to support Power Hammer Kit - Price Includes Mounting of Power Hammer Kit on Arms, Adjustments & Calibrations Properly Set, Factory Tested
(Power Hammer Kit Not Included in Price)

**Call for a Truckline quote*



Power Hammer Pedestal
Less Fabricated Arms
Model 4200-400

*** Power Hammer Pedestal**
Model 4200-400
 12" x 12" x 1/2" Wall - 84" High Tube mounted on a 4'x4'x1" Thick Base Plate.
 Pedestal is pre drilled with Support Arm Mount Holes.
(Power Hammer Kit & Arms Not Included in Price)

Upper & Lower Arm Weldment & Pedestal
 Drawings **Model 4200-410** (Drawings Only)
Drawings Included with any of the Power Hammer Kits

Power Hammer Dies

All Dies Precision Machined from the Highest Quality Steel for Long Life

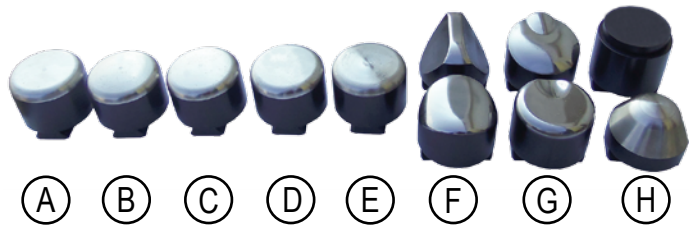

Power Hammer Dies		
Die Type (Location)	Part #	
A Flat (Top)	4200-602-F	
B 4" Radius (Bottom)	4200-602-4	
C 6" Radius (Bottom)	4200-602-6	
D 12" Radius (Bottom)	4200-602-12	
E 24" Radius (Bottom)	4200-602-24	
F Stretching Set (2 Pieces)	4200-600-ST	
G Shrinking Set (2 Pieces)	4200-605-SH	
H Soft Set (2 Pieces)	4200-603-SD	
Complete Die Set (All Dies Listed Above)	4200-600	
Blank Die	4200-601	

** Complete Die Set Included with Double Headed Power Hammer Model #4200-100*



Ultimate Box & Pan Brake

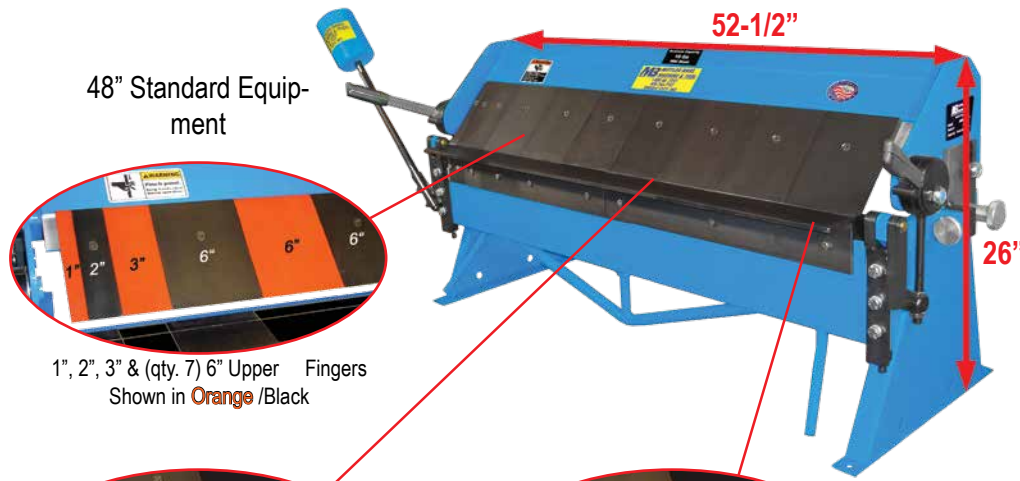

48" Standard Equipment

Max Capacity for 48"
 16 Ga (.062") Mild Steel
 20 Ga (.0375") Stainless
 12 Ga (.080") Aluminum



1", 2", 3" & (qty. 7) 6" Upper Fingers
 Shown in **Orange** /Black



1", 2", 3", 6" & (qty. 3) 12" Bed Fingers Shown in **Yellow** /Black

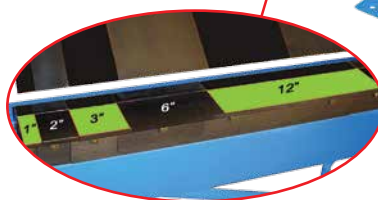

1", 2", 3", 6", 12" & 24" Apron Angle Fingers Shown in **Green** /Black



All Three Types Of Fingers Are Removable For Greater Material Manipulation

3 Segmented Finger Design
 (Color Added for Clarity)

- Bending Length: 48" w/ 49" of Clearance
- 125° Degree of Bend Max.
- 1/4" Reverse Bend Min. (with 1/4" Apron Fingers)
- 3-1/2" Depth of Box Max.
- 2" Down leg Max.
- Radius Finger Kits Available
- 1-1/2" Lift of Beam Max.
- Front to Rear Adjustment: 1"
- Wrenchless Upper Adjustment

48" 16 Ga Box & Pan Brake w/ Straight Pinch Fingers **Model 2800-48-16**

(Floor Stand Optional)



48" 16 Ga Box & Pan Brake w/ Upper Radius Fingers

Model 2800-48-16-R

(Substituting Straight Pinch Fingers For Radius Fingers of your choice)

(Floor Stand Optional)

72" 18 Ga Box & Pan Brake **Model 2800-72-18**

(Includes Floor Stand)

- Bending Length: 72" w/ 73" of Clearance
- Counterweight at each end of Apron

72" Standard Equipment:
 1", 2", 3" and (qty. 11) 6" Upper Fingers
 1", 2", 3", 6" and (qty. 5) 12" Bed Fingers
 1", 2", 3", 6", 12", and (qty. 2) 24" Apron Angle Fingers

Max Capacity for 72"
 18 Ga (.050") Mild Steel
 22 Ga (.031") Stainless
 14 Ga (.064") Aluminum



48" @ 680 lbs. w/ stand
 48" @ 550 lbs. w/o stand
 Skid Size: 72" L x 35" W x 40" H

72" @ 1275 lbs. w/ stand
 Skid Size: 88" L x 35" W x 45" H



Radius Fingers

Radius Fingers easily exchange for standard Upper Pinch Fingers to create radius bends for making and repairing aircraft, automotive, motorcycle panels, and general sheet metal fabrication.



Simple 90° Radius Bend
(requires optional radius fingers)

Upper Radius Finger Kits							
12", 24", 36", 48", 60", or 72" Available							
Size	Length	Part #		Size	Length	Part #	
1/16"	(12")	2800-A255-K12		1/16"	(48")	2800-A255-K48	
1/8"	(12")	2800-A260-K12		1/8"	(48")	2800-A260-K48	
3/16"	(12")	2800-A270-K12		3/16"	(48")	2800-A270-K48	
1/4"	(12")	2800-A280-K12		1/4"	(48")	2800-A280-K48	
5/16"	(12")	2800-A290-K12		5/16"	(48")	2800-A290-K48	

(radius is measured inside of bend)

See our website or call for additional kit information and pricing



Reverse Apron Fingers

Reverse Apron Fingers are easily exchanged for the standard Apron 3" Wide Angle Fingers to allow extremely tight 1/4" or 1/2" reverse bends for creating air boxes, instrument panels, interior panels, etc.



Reverse Inside Door Flange

Reverse Apron Finger Kits							
12", 24", 36", 48", 60", or 72" Available							
Size	Length	Part #		Size	Length	Part #	
1/4" Thick	(12")	2800-A151-K12		1/4" Thick	(48")	2800-A151-K48	
1/2" Thick	(12")	2800-A150-K12		1/2" Thick	(48")	2800-A150-K48	

See our website or call for additional kit information and pricing



Box & Pan Accessories

Back Gauge kit



Apron Stop



Heavy Duty Stand

Sets Working Height to 38"



Stand Ships
Truck Freight
@ 130 lbs.
57L x 24W x 22H

Heavy Duty Floor Stand For 48" Box & Pan Brake [Model 2800-400](#)

Apron Stop [Model 2800-A360](#)

Back Gauge Kit [Model 2800-A350-K](#)

Full Length Radius Bar For 48" [Model 2800-A300-48](#)

Full Length Radius Bar for 72" [Model 2800-A300-72](#)

Casters (2 Swivel, 2 Fixed) With Mount Bars & Hardware [Model 2800-A420](#)

Digital Angle Gauge w/ Level [Model MB-WR365](#)

Digital Angle Gauge w/ Level

See P. 14 for more info



Ultimate Box & Pan Brake Sample Bends

Just a sample of the hundreds of bends the Ultimate Box & Pan can do!



Double Reverse 90°
Without Bending Side Legs



Triple 90° Radius Bend
w/ 90° Reverse Bend
(requires optional radius fingers)



Triple 90° Radius Bend w/ Offset Bend

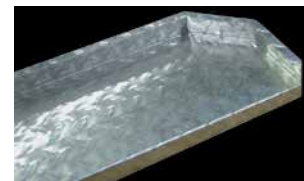

45° Corner w/ Flanged Lip



Sheet Metal Brakes

16 Gauge Straight Brake Heavy Duty Construction



- 1-1/2" Lift of Beam Max
- 125° Degree of Bend Max
- 1/2" Reverse Bend Min
- Wrenchless 1" Set Back Adjustment
- Precision Machined Cam
- Bronze Bearing with Steel Pivot Pin
- 2 Counter Weights Included
- Legs Included on 72" & 96"

Max Capacity
16 Ga (.059) Mild Steel
12 Ga (.080) Aluminum
20 Ga (.038) Stainless

120" Shown , 48", 72" & 96" Available

- 48" 16 Gauge Bench Top Straight Brake** Model **2800-4816S**
- Heavy Duty Floor Stand For 48" Sheet Metal Brake** Model **2800-400**
- 72" 16 Gauge Straight Brake** Model **2800-7216S**
- 96" 16 Gauge Straight Brake** Model **2800-9616S**
- 120" 16 Gauge Straight Brake** [Call For Information](#)

 Ships Truck Freight
 72" @ 840 lbs.
 Skid Size: 72"L x 35"W x 40"H
 96" @ 2300 lbs.
 Skid Size: 120"L x 43"W x 66"H

These 16 Gauge models are designed for race car body and general shop fabrication. This design is not only economical, but also includes some of the same quality features of our Ultimate Box & Pan Brake. The Mittler Brothers 16 Gauge brake is built to last.

22 Gauge Straight Brake Ideal For .040 Aluminum Body Fabrication



72" Shown , 96" Available

The MB 22 Gauge Brake is designed for race car body fabrication. This design is not only economical, but also includes some of the same quality features of our Ultimate Box & Pan Brake. The 72" & 96" Brakes include legs. The 96" includes 1/2" Upper Radius Bar. The Upper Radius Bar is optional on the 72". (mounting holes are pre drilled in 72" brake)

- Precision Machined Cam
- Bronze Bearing with Steel Pivot Pin
- Wrenchless Upper Adjustments
- Legs Included

 Ships Truck Freight
 72" @ 465 lbs.
 Skid Size: 90"L x 35"W x 56"H
 96" @ 715 lbs.
 Skid Size: 110"L x 38"W x 56"H

- 72" 22 Gauge Straight Brake** Model **2800-7222S**
- 72" Radius Bar (Optional)** Model **2800-A310-72**
- 96" 22 Gauge Straight Brake** Model **2800-9622S**

Max Capacity:
22 Ga (.030") Mild Steel
18 Ga (.040") Aluminum



48" Econo Radius Brake

Many Features of a Full Size Brake at a Fraction of the Price

- 1", 2", & 3" Diameter Tubes Included
- Mounts On Your Existing Bench Or Table
- Material Hold Down Clamp
- Degree Wheel for Accurate, Repeatable Bends
- Adjustable Bottom Roll

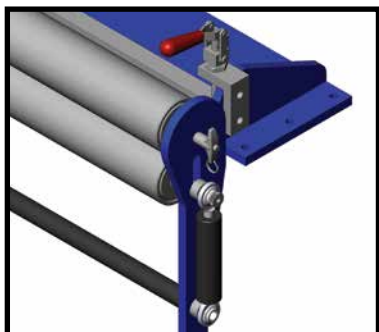

Coming Soon! Please Call for More Information.

Radius Brakes



4' Radius Brake
Model 2800-4816RB



6' Radius Brake
Model 2800-7216RB



Optional Back Gauge

Standard Equipment

- 16 Ga capacity (18 Ga on 8') in mild steel
- Quick tooling change over
- Convenient radius roll storage on machine
- 1", 2", 2-1/2", 3", & 4" diameter tubes included with 6' and 8' machines.
- 1", 2", 3", 4", 5", and 6-5/8" diameter tubes included with 4' machine
- Note: Tube sizes do not necessarily refer to finished part radius. Material type and thickness will affect the true finished radius.

4' Radius Brake

Model 2800-4816RB

(6 Radius Tubes & 1 Radius Head) (Ship Weight-750 lbs.)

6' Radius Brake

Model 2800-7216RB

(5 Radius Tubes & 1 Radius Head) (Ship Weight-840 lbs.)

8' Radius Brake

Model 2800-9618RB

(5 Radius Tubes & 1 Radius Head) (Ship Weight-1090 lbs.)

Back Gauge

Model 2800-RB



Foot Shears

Ideal for the Body Fabricator



Optional Back Gauge Kit

- Precision Machined Steel Table
- Available in 72" Cut w/ 72" Table or 52" Cut w/ 52" Table
- Reversible Blades for Extended Life
- Adjustable Blade Clearance For Maximum Versatility
- Engraved Scale

Ultimate 52" 16 Ga Foot Shear Model **3000-52-16**
Back Gauge Kit for 52" Foot Shear Model **3000-52-200**

52" Foot Shear Max Capacity
 16 Ga (.059") Mild Steel
 12 Ga (.080") 6061 Aluminum
 24 Ga (.025") Stainless

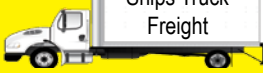

52" @ 985 lbs.
 Skid Size: 72"L x 40"W x 53"H
 72" @ 1,200 lbs.
 Skid Size: 96"L x 40"W x 53"H

72" Foot Shear Max Capacity
 24 Ga (.024") Mild Steel
 18 Ga (.040") 6061 Aluminum

Ultimate 72" Foot Shear Model **3000-72-24**
Back Gauge Kit for 72" Foot Shear Model **3000-72-200**



Retractable Support Arms
 Model **3000-100**



Bench Mount English Wheel

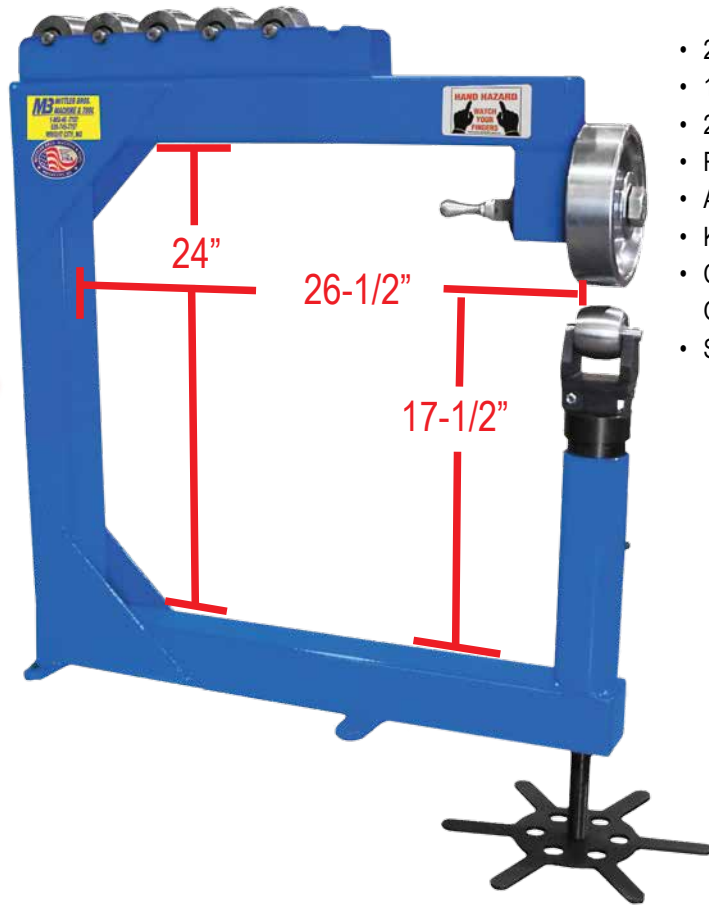

- 26-1/2" Deep Throat
- 17-1/2" From Bottom frame to Top of Anvil Wheel
- 2-1/2" OD - 2" Wide Anvils & 7" OD x 2" Wide Top Wheel
- Rugged 3" x 4" x 1/4" Tube construction
- Adjustable Anvil Wheel Angle
- Kick Wheel Manual Pressure Adjustment
- Cam Action Release on Top Wheel For Quick & Easy Anvil Change-Out
- Ships UPS - 2 Boxes (129 Lbs. & 38 Lbs.)

Max Capacity:
 16 Ga (.059") Mild Steel
 10 Ga (.100") Soft Aluminum



Model 2900-300

Std. Bench Mount Welded English Wheel Model 2900
 Completely finished as shown

Bench Mount Unwelded English Wheel Kit Model 2900-K
 Unwelded kit includes all machined parts, top wheel assemblies, 6 anvils wheels, cut to length frame material, detailed step by step instructions and blueprints.

Optional Floor Stand With Locking Casters Model 2900-300
 (For model 2900)

Anvil Wheels

CNC Machined In House
 Heat Treated Steel
 Hard Turned & Polished
 After Heat Treat
 For Concentricity

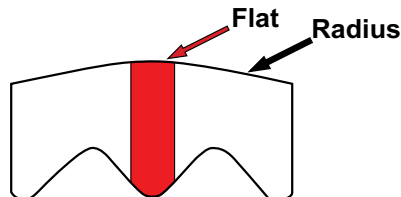

Edging Anvil
 Model 2900-A6



Deep Reach Anvil
 Model 2900-A7



Anvil Wheels		
2-1/2" Dia x 2" Wide	Part #	
Flat	2900-A0	
12" Rad w/3/4" Flat	2900-A1	
8-1/2" Rad w/ 1/2" Flat	2900-A2	
5" Rad w/ 3/8" Flat	2900-A3	
3-1/4" Rad w/ 1/4" Flat	2900-A4	
2-3/8" Rad w/ 1/8" Flat	2900-A5	
Set of Wheels Above (6 Wheels)	2900-A	
Edging Anvil	2900-A6	
Deep Reach Anvil	2900-A7	



Floor Model English Wheel

A Rugged, Robust Machine for the Metalworking Professional

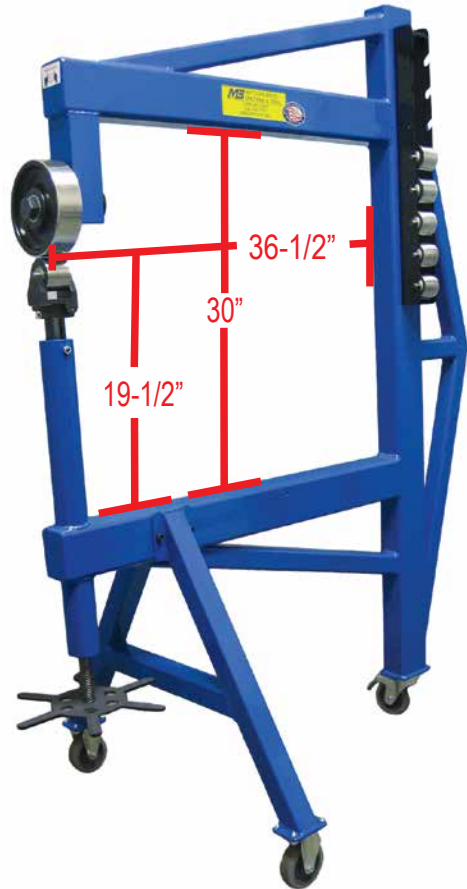

- Free Standing
- 72" Overall Height
- 50" Overall Depth
- 36-1/2" Deep Throat
- 30" Throat Height
- 2-1/2" OD x 2" Wide Anvil Wheels - Quantity: 6
- 7" OD x 2" Wide Upper Wheel
- Built in Anvil Wheel Holder
- Rugged 3" x 4" x 1/4" Tube construction
- Adjustable Anvil Wheel Angle
- Cam Action Release on Top Wheel for Quick & Easy Anvil Change-Out
- Kick Wheel Manual Pressure Adjustment
- Casters - 2 Fixed, 1 Swivel with Lock

Max Capacity:
 16 Ga (.059") Mild Steel
 10 Ga (.100") Soft Aluminum



Floor Model English Wheel **Model 4000**

Completely finished as shown above

Floor Model English Wheel **Model 4010**

With 9" OD x 3" Wide Upper Wheel & 3" OD x 3" Wide Lower Wheels

Metal Shaper Station

Specifications:

Working Height.....	47"
Width.....	52"
Depth.....	55"
Max. Anvil Opening.....	1"
Weight.....	475 lbs.
Upper Wheel.....	2" wide x 4-1/2" Dia.
Rolls.....	Case Hardened

Unique Upper Wheel "CAM" Release

6 Anvil Wheels Included

- 2-1/2" Dia x 2" Wide;
 - 2900-A0 = Flat
 - 2900-A1 = 12" Rad w/ 3/4" Flat
 - 2900-A2 = 8-1/2" Rad w/ 1/2" Flat
 - 2900-A3 = 5" Rad w/ 3/8" Flat
 - 2900-A4 = 3-1/4" Rad w/ 1/4" Flat
 - 2900-A5 = 2-3/8" Rad w/ 1/8" Flat
- CNC Machined
Heat Treated Steel



Metal Shaping Work Cell:

- **Hammering / Blocking** to pre-form the custom aluminum or steel parts;
- **Wheeling and raising** metal panels;
- **Shrinking or stretching**;
- **Planishing**; Perfect for motorcycle tanks, hood scoops, fender flares, door skins, etc.

Foot Operated Shrinker / Stretcher

Max Capacity:
 16 Ga (.059") Mild Steel
 10 Ga (.100") Soft Aluminum



Metal Shaper Station **Model 3200**

Complete with Stand, Shrinker / Stretcher Body with Jaws, 6 Lower Anvil
Wheels



Heavy Duty Shrinker / Stretcher

MB MITTLER BROS.
MACHINE & TOOL

Jamey Jordan
SIGNATURE SERIES

Jamey Jordan Signature Series
Shrinker/Stretcher

Model 570.....

(Jaws not included)

Replacement Jaw Sets



Shrinker Jaw Set (Steel)

Stretcher Jaw Set (Steel)

Shrinker Jaw Set (Aluminum)

Stretcher Jaw Set (Aluminum)

Model 570-200

Model 570-210

Model 570-220

Model 570-230

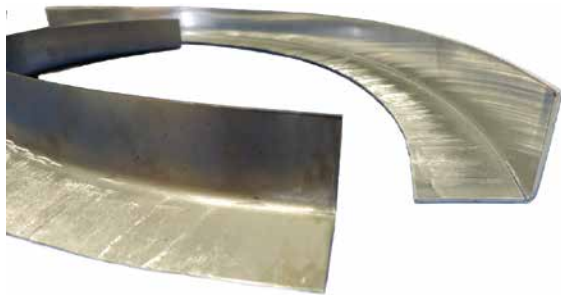

Max Capacity
16 Ga (.059") Mild Steel
14 Ga (.064") Aluminum
19 Ga (.043") Stainless

- Revolutionary Design
- All Bearing Design for smooth operation and long life
- Down acting/Up acting
- Comes with Bench Mount Plate (Stand Available, pg. 51)
- High Leverage
- Ideal for Professional Metal Worker
- 7" Throat Depth
- Precision Machine Frame
- Stand Available (see page 51)



Shrinker / Stretcher

Made In The USA By Lancaster

Max Capacity
 18 Ga (.047") Mild Steel
 14 Ga (.064") Aluminum
 19 Ga (.043") Stainless



Power Shrinker-Stretcher

Model 560....

(Complete as shown)

- Perfect for Curved Angles and Channels
- 80 - 120 PSI Air Pressure at 20 CFM
- Speed Adjustable Air Cylinder
- Easy Switch Over With Quick Release Pin
- Foot Pedal Control Leaves Both Hands Free to Guide Work
- Rugged Welded and Coated Frame

Std. Power Kit Only
Model 560-NB (Complete as shown)



Shrinker / Stretcher Deep Throat

Extra throat clearance when shrinking or stretching panels.

Mounts in Bench Press

(#2200-M, #2200-H, #2210-H) & Louver Press

Shrinker / Stretcher Deep Throat Set with Adaptors

Model 550-100

Shrinker Deep Throat Set with Adaptors

Model 550-101

Stretcher Deep Throat Set with Adaptors

Model 550-102

Combo Shrinker-Stretcher Set



Combo Shrinker & Stretcher

Model 550-CU

(1 Body with one set of shrinker jaws & one set of stretcher jaws)

Shrinker-Stretcher Set



Model 550-STSH

(1 Shrinker Body w/Jaws, Handle & 1 Stretcher Body w/ Jaws, Handle)

Individual Bodies

Shrinker Body Model 550-MSHR (1 Shrinker Body w/Jaws & Handle)

Stretcher Body Model 550-MSTR (1 Stretcher Body w/Jaws & Handle)

Foot Operated Stand

Use your foot to control the machine while your hands are free to move the metal.

Shrinker/ Stretcher Kit w/ Foot Operated Stand

Model 550-FSK

(Shrinker, Stretcher, & Stand Included in Price)

Stand Only

Model 550-FS

(Shrinker / Stretcher Not Included in Price)



Replacement Jaw Sets

Stretcher Jaw Set Model 550-512

Shrinker Jaw Set Model 550-511



Floor Stand

Floor Stand with Locking Casters

Model 3100-100



Planishing Hammers

Now More Versatile

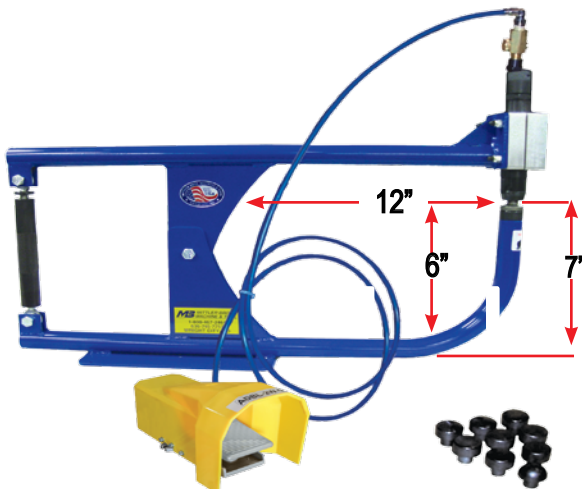

12" Planishing Hammer

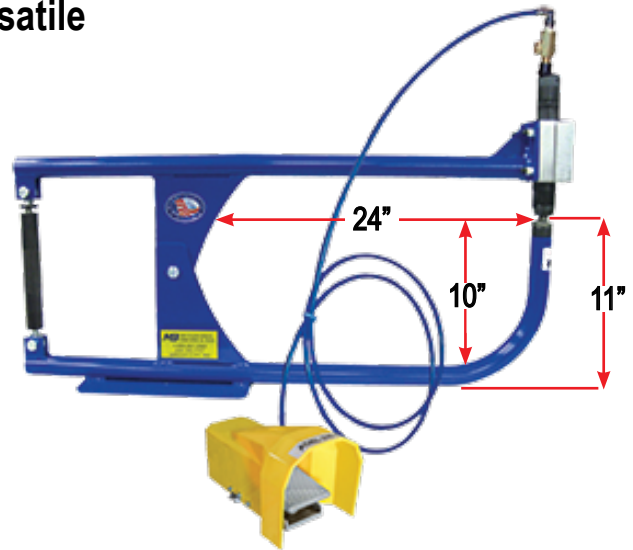

24" Planishing Hammer

Speed up fabrication time on complex multi form aluminum and steel panels for making those impossible to find replacement parts.

- 4600 Hits Per Minute @ 90 PSI
- Adjuster Sets Load Force and makes Anvil Changes Easy
- Foot Pedal Control for Hands Free Operation
- 12" & 24" Throat Depth Available
- Billet aluminum hammer mounting block eliminates all slippage



180° Bend Produced Using NEW Stretcher Die # 2700-024

12" Planishing Hammer with 9 Radius Steel Anvils **Model 2700**

24" Planishing Hammer with 9 Radius Steel Anvils **Model 2700-24**

Capacity
 18 Ga (.048") Mild Steel
 13 Ga (.062") Soft Aluminum (1100/3003)



Optional Floor Stand w/ Locking Casters
Model 3100-100

Planishing Hammer Anvils		
Description	Part #	
3/4" Rad.	2700-010	
1-1/2" Rad.	2700-011	
2" Rad.	2700-012	
3" Rad.	2700-013	
4" Rad.	2700-014	
6" Rad.	2700-015	
8" Rad.	2700-016	
12" Rad.	2700-017	
Flat	2700-018	
Complete 9 Pc. Set	2700-100	
Upper Anvil Head	2700-516	
Stretcher Die	2700-024	



Hand Tools



CLECO Pliers

Handy tool for sheet metal and body fabrication. Simply drill the hole then apply the spring loaded CLECO to hold your work in place.

Model MB-TP74

CLECO Kits

40 CLECOS & 1 Pliers - either size.

1/8" Cleco Kit MB-102

3/16" Cleco Kit MB-103



Individual CLECOS

Dia.	Drill Size	Price
1/8"	#30	MB-102-S
3/16"	#10	MB-103-S

Beverly Throatless Shears

Throatless shears are ideal for all-purpose metal cutting tools. They permit any desired cut in heavy gauge materials while still handling lighter gauges without distortion.

14 Gauge B-1 Throatless Shear

- 18 lbs.
- 14 Gauge mild steel capacity.
- 18 Gauge stainless capacity.
- 18" height (Less handle).
- 4-1/4" blade length.

Model MB-TP253

Model MB-TP253B - BLADES

10 Gauge B-2 Throatless Shear

- 35 lbs.
- 10 Gauge mild steel capacity.
- 14 Gauge stainless capacity.
- 15" height (less handle).
- 4-3/8" blade length.

Model MB-TP254

Model MB-TP254B - BLADES

7 Gauge B-3 Throatless Shear

- 58 lbs.
- 7 Gauge mild steel capacity.
- 10 Gauge stainless capacity.
- 15" height (less handle).
- 5-5/8" blade length.

Model MB-B3

Model MB-B3B - BLADES



Beverly Slitting Shear

- 10.5 lbs
- Equipped with high carbon, high chrome blades.
- 10 Gauge mild steel slitting capacity.
- 3/16" mild steel trimming capacity.
- 3/16" x 2" bar stock capacity.
- 8" height (less handle).
- 3-1/2" blade length.
- 14 Gauge stainless capacity.

Model MB-TP257



Side Grip Clamps

Side Grip clamps are designed to clamp at the edge of the work area. Ideal for holding work pieces of all types, particularly during bonding, sealing or gluing operations. Plier-operated, Spring loaded, Constant clamping force.

Use MB-TP74 installation tool.

Clamping Capacity (gap) 1/2"

Eff. Body Depth (reach) 1"

Body Length 2-3/16"

Model MB-TP125SG



Air Rivet Gun

Lightweight, heavy-duty professional Sets 3/32", 1/8", 5/32", 3/16" steel and aluminum blind rivets without adjustments by changing the nose bushing.

Model 62780



Swivel Riveting Tool

Rotates 360° and rivets in any position. High leverage handles for added power. Hardened steel construction for long life. Extended nose for hard to reach places. Will pull 3/32", 1/8", 5/32", & 3/16" rivets.

Model MB-TP844



Hand Seamer

1.5 lbs. Wide, deep jaws machined for smooth parallel fit. Forms precise folds and seams. 1" Deep x 3-1/2" wide throat.

Model MB-TP44



Offset Hand Seamer

1.25 lbs. Offset design allows for additional leverage. 1-1/4" deep x 3-1/8" wide throat. Forged Steel design.

Model MB-TP44-0



High Capacity Offset Snips

Red Handle
(Cuts left and straight)
Model MB-TP904L

Green Handle
(Cuts right and straight)
Model MB-TP904R

18 Gauge mild steel capacity. Ergonomic handle design. Alloy steel jaws with grooved tips and serrated upper jaws for optimal performance.



Metal Forming Hand Tools



Shot-filled canister provides dead blow action for sustained impact, maximum power and striking force.

Convex faces minimize bounce & resistance.

Welded steel core construction provides unmatched strength.

Soft Face Dead Blow Hammers

These handy plastic mallets are some of our favorites and make a great addition to any home workshop or full-time metal shop.

21 oz	Model MB-TC1
26 oz	Model MB-TC2
45 oz	Model MB-TC3

- One Piece Urethane Construction.
- No Exposed Metal on Handles or Heads

Bossing Mallets

Extra deep reach makes them a "must have" for all types of metal work projects. Each mallet also has two radii for added usefulness and practicality.



1.5 Lbs.	Model MB-TCBM1	
2.3 Lbs.	Model MB-TCBM2	
3 Lbs.	Model MB-TCBM3	
3 Pack (# 1,2,3)	Model MB-TCBM4	



Blocking Hammers

Blocking Hammers are ideal for roughing (blocking) high-dome shapes in aluminum or steel.

[Model MB-BH350](#)



Wooden Mallets

A good, all-purpose tool to have in your arsenal. Use a disk sander to easily customize one or both mallet heads to suit the job at hand, or leave as is.

Small 2-1/2" dia	Model MB-SUM00	
Medium 2-3/4" dia	Model MB-MUM00	
Large 3" dia	Model MB-LUM00	



20 Hole Adjustable Rivet Spacer

For uniform spacing of rivets, bolts, nails, etc. Unique fan design expands to 36". Equally spaces up to 20 holes between 2 given points. Made of 301 stainless steel.

[Model MB-12-11700](#)

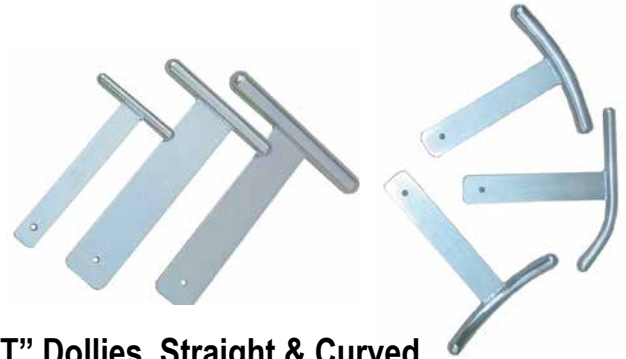

"T" Dollies, Straight & Curved

These handy T-Dollies can be used to form flanges and edges by hammering (with hammer or wood slapper) the metal over the rounded dolly. T-Dollies can be hand held or placed in a vise.

Straight:

1/2" x 4"	Model MB-TPA5518	
3/4" x 6"	Model MB-TPA5519	
1" x 8"	Model MB-TPA5520	

Curved: pat. pending

Gentle Curve	Model MB-FCTD01	
Crescent	Model MB-FCTD02	
Slope	Model MB-FCTD03	

Slappers

Metalshapers know that wood slappers of various shapes, although a seemingly simple tool, quickly become a valuable asset in any metal shop.

Flat	Model MB-FFS01	
Curved	Model MB-CFS01	
Round	Model MB-RBS01	

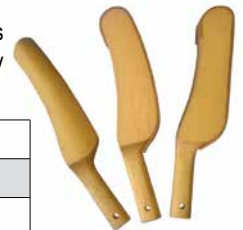

Shot Bag

Our bags have a suede outer finish and a tanned inner surface for blemish-free metal work.

(Shot Sold Separately)

12" [Model MB-LSB12](#)



Informational DVDs



Jamey Jordan
Art Of Bead Rolling
Vol. 1 DVD
MB-1000-JJ1...



Jamey Jordan
Art Of Bead Rolling
Vol. 2 DVD
MB-1000-JJ2...



Ron Covell
Shaping Aluminum
with Hand Tools DVD
MB-1000-1

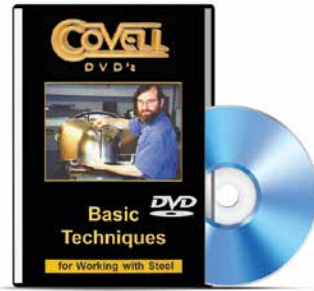

Ron Covell
Basic Techniques
for Working Steel DVD
MB-1000-3



Ron Covell
Working With
Tubing DVD
MB-1000-4



Ron Covell &
Ron Fournier
Hammer Forming
Techniques DVD
MB-1000-15



Ron Covell
English Wheel
Techniques DVD
MB-1000-19



Ron Covell
TIG Welding
Basics DVD
MB-1000-21



Ron Covell
Advanced TIG
Welding DVD
MB-1000-25



Ron Covell
High Power
Metalshaping
Workshop DVD
MB-1000-26



Ron Covell
Beading Machine
Basics DVD
MB-1000-31



Ron Fournier
Metal Shaping
DVD
MB-BSD00



Ron Fournier
Sheet Metal Hand
Tools DVD
MB-HTV01



Fabricated Differential Housing

Unique Triangulate Design For Maximum Strength

- Precision CNC Machined
- CAD/CAM Designed
- All Tig Welded
- Drain and Fill Plugs Installed
- Precision Ground Mounting Plate
- Mild Steel or 4130 Construction

Dragster



Tube End



Profab



Road Course

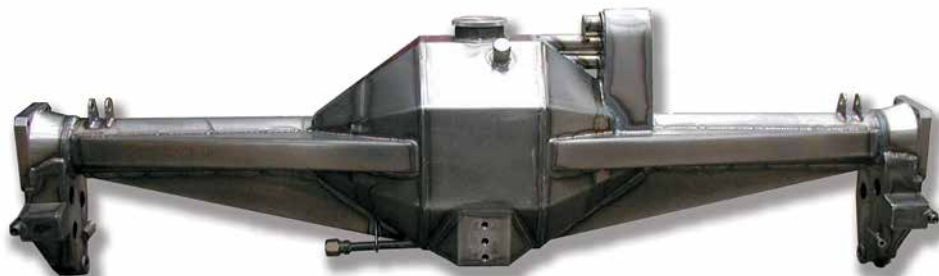

9" Racing Housings



Custom Built to any Width, any Offset!

INCLUDES:

- 1 Pair Standard 5x5 Hubs w/Short Coarse Studs [1400-034](#)
- 1 Pair of Standard 6061 24 Spline Drive Flanges [1400-033-6061](#)
- 1 Pair of Rear Hub Accessory Kits, Left / Right [1400-400-L / R](#)
(Includes bearings, seals, o-rings & hardware)
- 1 Pair Steel Rotor Adapters 8 Hole 7" BC [1400-003-S](#)
- 1 Pair 28 or 31 Spline Standard GN Axles
- 1 New Housing between 58" and 62" with 3"OD x 3/16" Wall Tubes
- 1 3/4 Allen Fill Plug
- 1 1/2 Allen Drain Plug

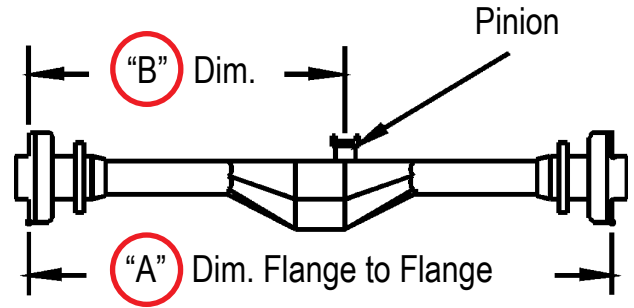

Just Give Us Your "A" and "B" Dimensions & We'll Do The Rest

Complete Floater Housing Assembly as Listed Above

New 9" Ford Housings

ECONO



Model 1000-509

Precision Laser & Robotic Fabrication. Precision Ground Mounting Surface. Close Fit Axle Tube Sockets. Smooth Back, Great for Street Rods Heavy Duty 3/16" Material **22-3/4" Wide**

Track 9



Model 1000-503
Model 1000-504

Precision Laser & Robotic Fabrication. Internal Gussets Provide Extra Support. Precision Ground Mounting Surface. Close Fit 7" Deep Axle Tube Sockets. High Form 50 Material **NASCAR & IMCA** Approved **27" Wide**

- Track 9 Housing Standard Weight (1/8" thick) [Model 1000-503](#)
- Track 9 Housing NASCAR Approved (3/16" thick) [Model 1000-504](#)
- "ECONO" 9" Ford Housing (3/16" thick) [Model 1000-509](#)

Basic Rear End Kit



Kits Use 3" Diameter Tubing

Basic Track 9 Kit As Shown Above Starting At



Complete Rear Hub Kits

All Complete Hub Kits are For One Wheel & Comes Complete as Listed Below

- Hub w/ Races & Studs Installed
- Bearings
- Hub Seal & Axle Seal
- Spindle Nut & Lockwasher
- Hub Cap w/ Screws & O-Ring
- Steel Rotor Adapter w/ Bolts
- 6061 Drive Flange w/ O-Ring & Bolts



Complete Rear Hub Kits		
Description	Part #	
Standard Right Rear Kit (LONG COARSE 5/8" STUDS ARE STANDARD)	1400-402-R	
Standard Left Rear Kit (LONG COARSE 5/8" STUDS ARE STANDARD)	1400-402-L	
Light Weight Right Rear Kit (SHORT COARSE 5/8" STUDS ARE STANDARD)	1400-401-R	
Light Weight Left Rear Kit (SHORT COARSE 5/8" STUDS ARE STANDARD)	1400-401-L	
Steel Drive Flanges	(add to Above Price)	
7075 Aluminum Drive Flanges	(add to Above Price)	

Standard Rear Hubs

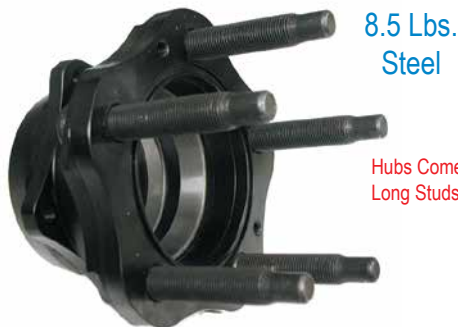

8.5 Lbs.
Steel

Hubs Come w/ Coarse 5/8"
Long Studs, Races

- Forged Steel Hub
- Race Proven On Our NASCAR Truck
- Uses Rotor Adapter Plates - Eliminates Brake Hat

Rear Hubs & Parts		
Description	Part #	
5x5 Steel Rear Hub 8.5 Lbs.	1400-5x5RS	
5x5 Aluminum Rear Hub	1400-5x5RA	
Inner / Outer Race (L610510)	1400-502	
Inner / Outer Bearing (L610549)	1400-501	
Axle Seal (SCP-50395)	1400-511	
Hub Seal (SCP-2168)	1400-510	

Lite Weight Rear Hubs



6 Lbs.
Steel

Hubs Come w/ Coarse 5/8"
Short Studs, Races

- Ideal For Light Weight Cars
- Reduces Rotating & Unsprung Weight
- Uses Same Drive Plate & Bearings
As Grand National Hub Shown Above

5x5 Steel Rear Hub With Studs &
Races Model 1400-LWRH

Wheel Studs



Wheel Studs .690" Knurl (length from under head to end)		
Description	Part #	
5/8" dia. x 3-3/4" Long Coarse	1400-527	
5/8" dia x 2-3/4" Short Coarse	1400-523	
5/8" dia x 3-3/4" Long Fine	1400-526	
5/8" dia x 2-3/4" Short Fine	1400-524	



Drive Flanges

All Our Drive Flanges Have A 7" OD For Proper Wheel Support Without A Brake Rotor Hat

Standard Drive Flange

- SUITABLE FOR MOST IMCA TYPE CARS
- 6061-T6 ALUMINUM
- HARD COAT ANODIZED FOR WEAR
- BEST WITH LIMITED POWER AND TIRE

1.98 Lbs.



6061 Aluminum Drive Flange w/ Cap, Bolts, O-rings, & Hard Coat Anodized For Wear Resistance

Model **1400-033-6061**

Ultimate Drive Flange

- 7075-T6 ALUMINUM
- IDEAL FOR ANY APPLICATION
- SUITABLE FOR HIGH HORSE POWER AND BIG TIRES

1.98 Lbs.



5 X 5 (24 SPLINE) 7075 Aluminum Drive Flange w/ Cap, Bolts, O-rings, & Hard Coat Anodized For Wear Resistance

Model **1400-033-7075**

Apply High Pressure Lube To Drive Flanges At each Installation. See Page 59

Steel Drive Flange

- USE WHERE RULES WON'T ALLOW ALUMINUM
- HIGH STRENGTH STEEL

4.72 Lbs.



5 X 5 (24 SPLINE) Steel Drive Flange w/ Cap, Bolts & O-rings

Model **1400-006**

Bolt Circle Adapters

4 3/4" or 4 1/2" Bolt Circle

Ideal For Street Stock & IMCA Modified Cars

Allows The Use Of Our Proven Grand National Hub

This is just a thick drive flange with a dual bolt pattern

allowing you to use our 5 x 5 hubs with your stock pattern wheels

Includes Hub Cap & all hardware required

Widens The Track By 11/16" Per Side over std. Drive Flange

Bolt Circle Adapter Steel Model **1400-017-S**

Bolt Circle Adapter Aluminum Model **1400-017-A** (Specify 4-1/2" or 4-3/4" BC and Stud Type)



Floater Housing Accessories

GN 5X5 HUB PARTS	
Description	Part #
Right Hand 5x5 G N Spindle Nut	1400-512
Left Hand 5x5 G N Spindle Nut	1400-509
Tang Locking Washer	1400-513
Inner / Outer Bearing (#L610549)	1400-501
Inner / Outer Race (#L610510)	1400-502
Hub Seal (SCP-2168)	1400-510
Axle Seal (SCP-50395)	1400-511
O'Ring For Drive Flange (241)	1400-514
O'Ring For Hub Cap (132)	1400-515
Left Hub Accessory Kit	1400-400-L
Right Hub Accessory Kit	1400-400-R
GN Hub Cap w/ O-Ring & Bolts	1400-009

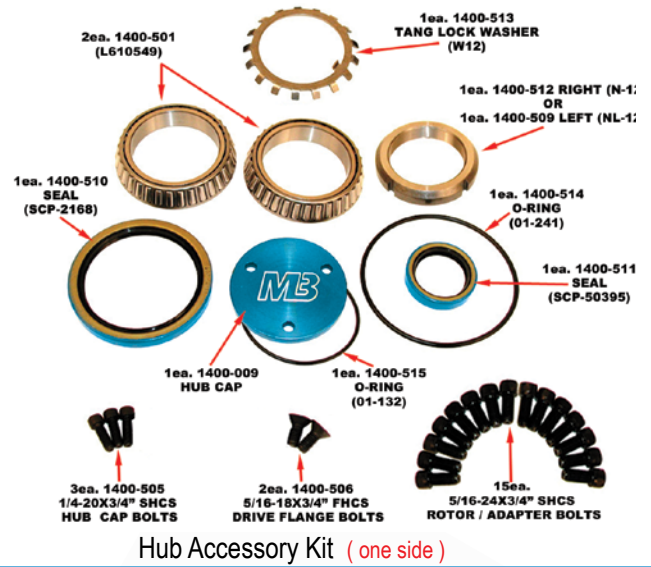

Grand National Double Spline Axles

Specify 28 or 31 Spline

Light Weight Gun Drilled Axles

31 Spline Only



Grand National Rear Snout Left

Model 800-004-L

Grand National Rear Snout Right

Model 800-004-R



Spindle Nut Socket Makes Removal & Installation A Breeze

Fits 1/2" Drive Ratchet And Has Stainless Drive Pins

#12 Grand National Spindle Nut

Model 1400-013

#11 Speedway Spindle Nut

Model 1400-014



High Pressure Lube Extend Drive Flange Life!

We have tested the High Pressure Lube and found it to be the Ultimate Lube for high pressure applications. Also works great for spark plugs, aluminum fittings, etc.

We also recommend High Pressure Lube be applied on a regular basis to improve Drive Flange Life.



Model 1400-531

Seals-it

9" Ford Inner Axle Seal

This billet aluminum seal has three O-rings that seal it to the axle tube and two bonded, heavy duty, neoprene inner seals designed to compensate for any amount of axle run out.

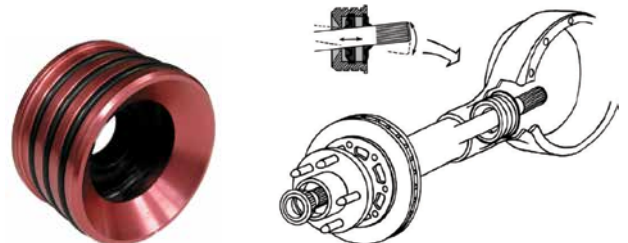

Red	Model AS9188	2.625" OD
Gold	Model AS9520	2.500" OD
Blue	Model AS9218	2.560" OD
Silver	Model AS9125	2.750" OD



Rear End Accessories

All housing ends are machined from premium grade mild steel so there is no fear of cracking when MIG welding is used to attach to the housings. All ends are 1" thick unless stated otherwise.



Early Big Ford Housing Ends. 3.150" Bore 1/2x20 Threaded Holes
Model 1000-260

Early Big Ford Housing Ends. 3.150" Bore, 2" Thick, Uses An Axle Seal, 3/8" Bolt Holes
Model 1000-253

Late **Model Big Ford** (Torino) Housing Ends.
 3.150" Bore, 3/8" Holes
Model 1000-254



Symmetrical / Lamb Housing Ends 3.150" Bore,
 3/8" Bolt Holes
Model 1000-255



Oldsmobile Housing Ends 3.150" Bore
 3/8" Bolt Holes
Model 1000-251



These 2-1/2" Fill Cap Assemblies Have A Steel Weld Bung & Aluminum Cap
Model 1000-302



These 1-1/4" Fill Cap Assemblies Have A Steel Weld Bung & Aluminum Cap. They Also work Great For Weight Bars
Model 1000-301



These 1/2" Pipe Threaded Fittings Are 1/2" High & Have A 7/8" Register Diameter
Model 1000-320



This 1/8" Pipe Weld Bung and Vent Fitting Work Great For Race Applications
Model 1000-340



Grade 8 Press In Face Plate Studs for 9" Fords
 Set of 10
Model 1000-505-S

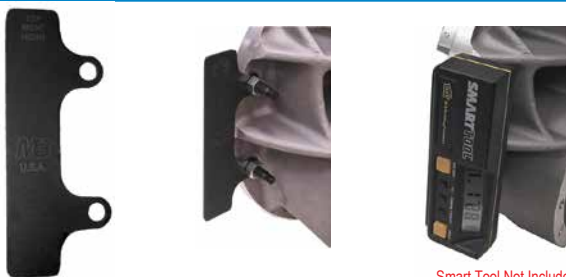

Smart Tool Not Included

Pinion Angle Plate Model 1000-310

Pinion Angle Plate

Just bolt the plate to the right side third member studs. Use a digital level to set pinion angle.

The MB Pinion Angle Plate is a quick and simple method to check and set pinion angle. Use this when first setting up chassis or making bar changes. This will allow you to maintain this critical angle.



Rear End Narrowing Kits

For 8", 8.8", 9" Ford, Dana 44/60, 12-Bolt Chevy

Narrow any rear end for racing or rodding applications with this precision-made kit. A 1-1/2" by 60" lineup bar is passed through the trimmed rear-end housing and the inner bearing blocks. This assures the accurate, true and square reinstallation of the housing ends. (Additional sizes available upon request)

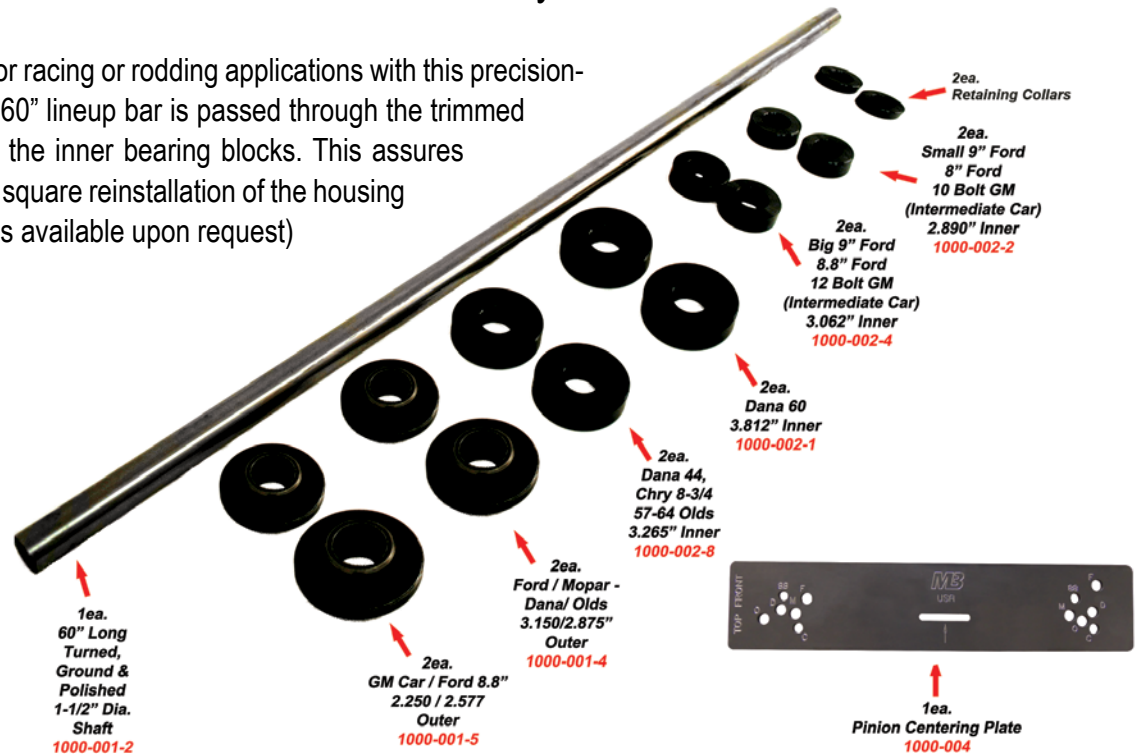

72" Long Shaft (#1000-001-3) Substitute for 60" Shaft Add

Rear End Narrowing Kit as Described Above Model 1000-RENK1

Optional Outer Line Up Blocks		
Description	Part #	
Big Ford / Dana /Olds- 3.150/ 2.875	1000-001-4	
GM Car / Ford 8.8" 2.250 / 2.577	1000-001-5	
GN Floater Snout Alignment Rings (works with 1000-RENK2)	1000-005	
Strange Floater Line-Up Pucks 1-1/2" ID	1000-002-9	
Strange Floater Line-Up Pucks 1-3/8" ID	1000-002-12	
Optional Inner Line Up Blocks		
Dana 60 - 3.812	1000-002-1	
Ford 9", 8" / GM 10 Bolt - 2.890	1000-002-2	
Dana 44 / Olds 57-64 /Chry 8-3/4" - 3.265	1000-002-8	
Ford 9", 8.8" / GM 12 Bolt Car 3.062	1000-002-4	
Tube Line Up Ring for Floater Kit (1000-RENK2)	1000-006	

Pinion Centering Plate



Use This Precision Machined and Engraved Steel Plate To Locate Your Pinion Centerline When Narrowing A Housing or Checking Offsets. Fits 9" Ford, 8.8" Ford, 12 Bolt Chevy, Dana 60, 8-3/4" Mopar & Oldsmobile.

Pinion Centering Plate Model 1000-004

Custom Line Up Blocks Available Upon Request

1ea. 60" Long Turned, Ground & Polished 1-1/2" Dia. Shaft Model 1000-001-2

1ea. 72" Long Turned, Ground & Polished 1-1/2" Dia. Shaft Model 1000-001-3

Narrowing Kit For 9" Ford Floater Housings

(for Mittler GN Snouts)

This Kit Allows You To Fabricate A Precision Floater Housing, And Includes Inner Blocks To Fit 9" Ford (Specify Size), Tube Alignment Rings To Square Tube With Center, Snout Alignment Rings, 72" Alignment Bar and Pinion Centering Plate.

Floater Rear End Narrowing Kit as Described Above Model 1000-RENK2



Impala Front Hubs

Direct Replacement - Ideal For Rule Cars
 5 X 5 Bolt Pattern
 7" Diameter Provides Proper Wheel Support
 Uses Rotor Adapter Plate To Eliminate Brake Hat



11-1/2 lbs.
Complete

Hubs Include 5/8" Short Studs, Races & Dust Caps. Please Specify Coarse Or Fine Studs.

Impala Spindle Pin **800-013**

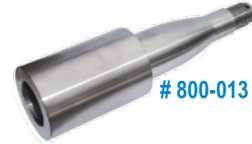

800-013

These Fit '70 to '76 Spindles

Impala Front Hubs & Parts		
Description	Part #	
Steel Front Hub 9 Lbs.	1400-IMPS	
Aluminum Front Hub 7 Lbs.	1400-IMPA	
Inner Bearing (LM48548)	1400-530	
Inner Race (LM48510)	1400-508	
Outer Bearing (LM12649)	1400-529	
Outer Race (LM12610)	1400-507	
Seal (19753)	1400-522	

Grand National Front Hubs

Race Proven
 5 X 5 Bolt Pattern
 7" Diameter Provides Proper Wheel Support
 Uses Rotor Adapter Plate To Eliminate Brake Hat



Fits SCP GN
Front Spindle

Hubs Include 5/8" Short Studs, Races & Dust Caps. Please Specify Coarse Or Fine Studs.

5 x 5 Front Hubs & Parts

Description	Part #	
Steel Front Hub	1400-5x5S	
Aluminum Front Hub	1400-5x5A	
Inner Bearing (3383)	1400-516	
Inner Race (3320)	1400-518	
Outer Bearing (2687)	1400-517	
Outer Race for Steel Hub (2630)	1400-519	
Outer Race For Aluminum Hub (2620)	1400-520	
Seal (23666)	1400-521	

Rotor Adapter Plates



Rotor Adapter Plates

Description	Part #	
8 Hole Aluminum on 7" B.C. 1-1/4 lbs.	1400-003-A	
8 Hole Steel on 7" B.C. 3 lbs.	1400-003-S	
10 Hole Aluminum on 6.8" B.C	1400-002-A	
10 Hole Steel on 6.8" B.C.	1400-002-S	

Brake Rotors

Standard Brake Rotors
 (11.75" Dia. x 1.25" Thick) 9 Lbs. Model **1400-532**

Light Weight Brake Rotors
 (11.75" Dia. x .810" Thick) 8.5 Lbs. Model **1400-533**

Rotor Bolt Kit For 8 Hole Rotors Model **1400-504-13** (13pcs)

Rotor Bolt Kit For 10 Hole Rotors Model **1400-504-15** (15pcs)



Off Road Housings & Hubs

- All Tig Welded
- Drain and Fill Plugs Installed

- CAD/CAM Designed
- Precision Ground Mounting Plate



Tubing Options Available
3" - 1/4 Wall, 3.25" - 1/4 Wall,
3.5" - 1/4 Wall, 4" - 1/4 Wall

Off Road Basic Housing

We Can Fabricate A Housing For Any Application

Call for a Quote!



Optional Bracing Shown

Off Road Rear Hub Kits

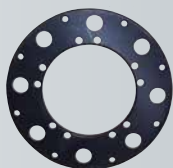

Off Road Rear Hub Kits		
Description	Part #	
5x5-1/2 Right Rear Hub Kit - 40 spl (LONG COARSE 5/8" STUDS ARE STANDARD)	1400-403-R	
5x5-1/2 Left Rear Hub Kit - 40 spl (LONG COARSE 5/8" STUDS ARE STANDARD)	1400-403-L	
5x5-1/2 Right Rear Hub Kit - 24 spl (LONG COARSE 5/8" STUDS ARE STANDARD)	1400-406-R	
5x5-1/2 Left Rear Hub Kit - 24 spl (LONG COARSE 5/8" STUDS ARE STANDARD)	1400-406-L	
 <p>3" OD</p>		
Off Road Spindle Snout		
Off Road 4130 Snout Left	Model 800-004-ML	
Off Road 4130 Snout Right	Model 800-004-MR	
		
Rotor Adapter Plates		
8 Hole Steel on 7" B.C. 3 lbs	1400-003-S	
10 Hole Steel on 6.8" B.C.	1400-002-S	
Rotor Bolt Kit-18 pcs	1400-505-18	

5x5-1/2 Steel Drive Flange		
Description	Part #	
24 Spline Steel Drive Flange	1400-043-24	
40 Spline Steel Drive Flange	1400-043-40	
Off Road 5x5 - 1/2 Hub Parts		
Rear Hub 5x5-1/2 Standard Steel with Races & Long Course 5/8" Studs	1400-052	
Bearing #L610549 - Timkin	1400-536	
Bearing Race #L610501 - Timkin included in hub Price	1400-537	
#12 Spindle Nut w/Lock ring - Right hand Thread	1400-538	
#12 Spindle Nut w/Lock ring - Left hand Thread	1400-539	
O-Ring for Drive Flange to Hub - Large	1400-514	
Seal - Hub	1400-510	
Seal - Axle	1400-511	
O-Ring for 40 Spline Hub Cap 01-135	1400-535	
O-Ring for 24 Spline Hub Cap 01-132	1400-515	
Rear Dust Cap w/bolts & O-Ring - 40 Spline	1400-054	
Rear Dust Cap w/bolts & O-Ring - 24 Spline	1400-009	
Left Hub Accessory Kit - 40 Spline	1400-404-L	
Right Hub Accessory Kit - 40 Spline	1400-404-R	
Left Hub Accessory Kit - 24 Spline	1400-405-L	
Right Hub Accessory Kit - 24 Spline	1400-405-R	



Spools

Spools Sold Exclusively Through Our Dealers



Lite Weight Spool

Weight: 6.1 lbs.

Improved Design Allows Strength Equal To A Standard Weight Spool (7.82 lbs.)

- CNC Machined From Forgings
- 4130 Heat Treated Steel Or 7075-T6 Aluminum
- Available In 23, 28, 31, 33, 35 & 40 Spline
- Lifetime Guarantee Against Breakage

9" Ford Mini Spool

PRECISION CNC MACHINED

- Heat Treated
- Lite Weight
- Replaces Stock-Type Side Gears
- Available In 28 and 31 Spline
- Optional 4130 Pin



Pinion Supports

Heavy Duty Pinion Support For All 9" Ford Cases
Precision CNC Machined From Billet

Available In All Popular Configurations
Daytona Bearing [Model 1900-001](#)
Big Bearing [Model 1900-002](#)
10 Bolt Heavy Duty [Model 1900-003](#)



Description	Part #	Weight
9" FORD SPOOL		
Ultra Lite Steel Spool 4130 Heat Treat - 28 Spline	1500-002-28-FUL	6.22 lbs.
Ultra Lite Steel Spool 4130 Heat Treat - 31 Spline	1500-002-31-FUL	5.94 lbs.
Standard Steel Spool 4130 Heat Treat - 28 Spline	1500-006-28-FSTD	
Standard Steel Spool 4130 Heat Treat - 31 Spline	1500-006-31-FSTD	
Standard Steel Spool 4130 Heat Treat - 33 Spline	1500-006-33-FSTD	
"Scalloped" Steel Spool 4130 Heat Treat - 40 Spline	1500-023-40-FS	
Standard Steel Spool - 35 Spline Small Bearing	1500-018-35-SBS-F	
Standard Steel Spool - 35 Spline Big Bearing	1500-025-35-BBS-F	
Standard Steel Spool - 35 Spline (Strange)	1500-006-35-FS-STG	7.82 lbs.
9" FORD MINI SPOOLS		
28 Spline Mini Spool	1500-020-28-FMS	2.98 lbs.
31 Spline Mini Spool	1500-020-31-FMS	2.74 lbs.
Moly Cross Pin	1500-102	
CHRYSLER SPOOLS		
8.75 Chrysler 4130 Heat Treat - 30 Spline	1500-026-30-CHY	9.24 lbs.
8.75 Chrysler 4130 Heat Treat - 35 Spline	1500-026-35-CHY	8.40 lbs.
DANA 44 SPOOLS		
Dana 44 4130 Heat Treat - 30 Spline High Series	1500-010-30-DAHS	9.44 lbs.
Dana 44 4130 Heat Treat - 30 Spline Low Series	1500-010-30-DALS	9.44 lbs.
TOYOTA SPOOLS		
Toyota 8" 4130 Heat Treat - 30 Spline	1500-017-30-T8	6.46 lbs.
Toyota V6 4130 Heat Treat - 30 Spline	1500-024-30-TV6	6.92 lbs.
Dwarf & Legend - Steel, 10 Bolt - 23 Spline	1500-030-23-S-DL10	3.56 lbs.
Dwarf & Legend - Steel, 8 Bolt - 23 Spline	1500-031-23-S-DL8	2.92 lbs.
Dwarf & Legend - Aluminum, 10 Bolt - 23 Spline	1500-030-23-AL-DL10	1.74 lbs.
Dwarf & Legend - Aluminum, 8 Bolt - 23 Spline	1500-031-23-AL-DL8	1.24 lbs.
MINI Dwarf & Legend - Steel, 8 Bolt - 23 Spline	1500-032-23-MS-DL	1.18 lbs.



Custom Billet Crankshafts

Featuring the “Best-Fit” design that puts the right weight in the right place Every time!



- Made in America with American Materials & Labor
- Custom Made to your Application
- Production Runs
- Made from the highest quality E4340 Aircraft Billet steel
- CNC Machined for Accuracy & Finite Element Analysis Designed
- Micro Polished
- Gundrilled Main Optional
- Aero Designed Leading & Trailing Edges
- Ion - Plasma Nitride for Superior Journal Surface Hardness & Wear Resistance
- Aerodynamic Profiled Counterweights
- Lightening holes in all four rods to reduce rotational weight & reduce or eliminate the need for heavy metal to balance



We Start With High Quality Timken
4340 Material



All Cranks Machined On Our 5 Axis Mazak Integrex
CNC

This Technology Lets Us Build A Custom Crank For
Your Exact Application

Quarter Midget Shocks

VISION Series

Tanner by Mittler, with feedback from customers, has designed, developed and extensively tested our new Vision quarter midget shock. The Vision shock is the most universal, user friendly shock available and yields the fastest lap times. We have extracted the solid features from our Platinum 4 shock such as the NO LEAK seal, quick change spring feature, Titanium Nitride shaft coating, and added several additional PERFORMANCE driven features such as:

- 62% increased air/gas chamber
- Micro Tower shim support.
- PERIMETER FLOW pistons
- Sandvick shim stacks
- Lightest shock on the market

One of the most important shock characteristics not widely discussed is Hysteresis, which is the delay a shock sees when changing direction or reaches high shaft velocities. Typically a shock that does not change direction well will reduce grip. Reduced grip is simply slower lap times. The same holds true for a shock with high shaft velocities. At high shaft speeds the internal flow capabilities can cause a hydraulic lock as well. A Quarter Midget will see shaft speeds double of what you will see on a typical NASCAR race car or even a Sprint car and the Vision shock has addressed this SUCCESSFULLY.



The "Quad Flow" includes bias porting, radial channeling, and calibrated bleed. Quad Flow pistons draw fluid from the wall of the shock where the temperature is coolest reducing shock fade. The unique design provides flow characteristics that will allow for a linear, digressive or progressive valving curve.

VISION Series

Standard	Split Valve
85550-3	85550-3/5
85550-4	85550-5/3
85550-5	85550-4/6
85550-6	85550-6/4

QUAD FLOW Series

Standard	Split Valve
85550-3 Q	85550-3/5 Q
85550-4 Q	85550-5/3 Q
85550-5 Q	85550-4/6 Q
85550-6 Q	85550-6/4 Q



See Page 75
For Complete Spring Selection



Quarter Midget Shocks

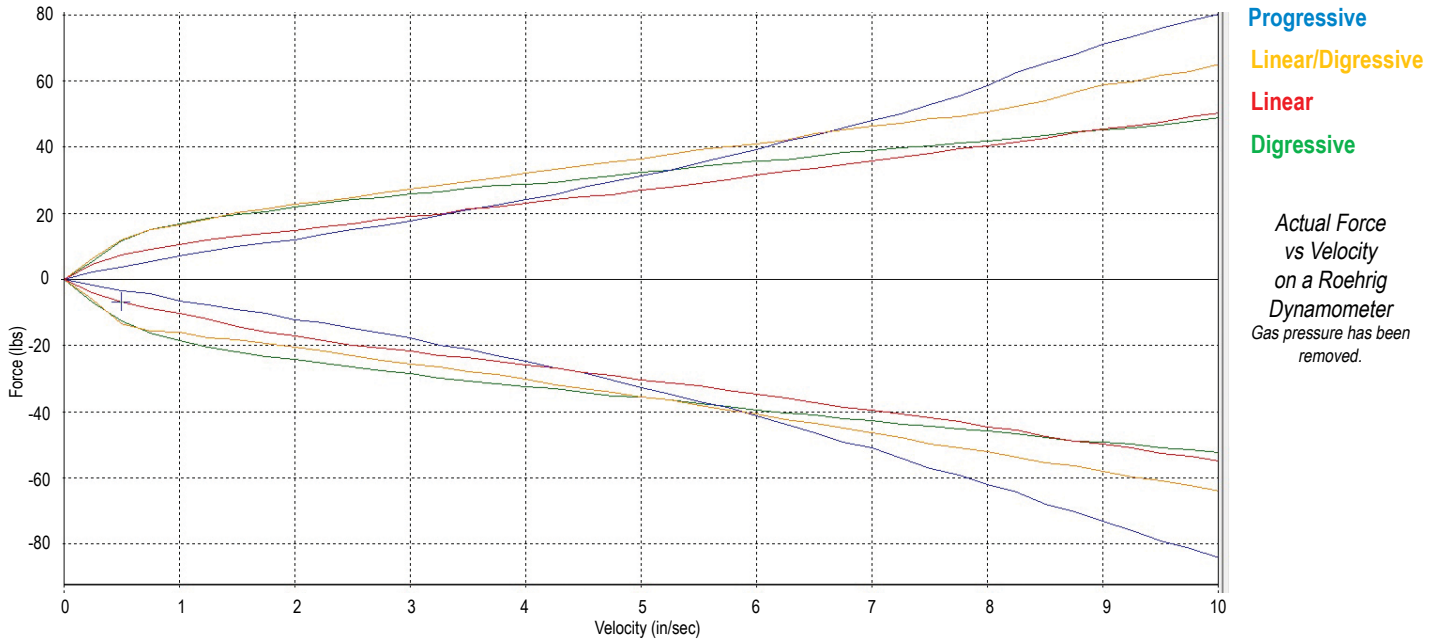

Graph demonstrates the 4 most used shock curves in Motorsports; **Linear**, **Digressive**, **Progressive**, and **Linear/Digressive**.

G2-G3 Shocks - **Linear**; **Platinum 4 Shocks** - **Digressive**; **VISION Shocks** - **Digressive**
VISION QUAD FLOW Series - **Linear**, **Progressive**, **Digressive**, or **Linear/Digressive**

Generation 2



G2 Standard	G2 Split Valve
85510-2	85510-3/5
85510-3	85510-5/3
85510-4	85510-4/6
85510-5	85510-6/4
85510-6	

Complete Shock
w/ Coil Over Kit

- Calibrated Fluid to Gas/Air Chamber Balance
- Titanium Nitride Coated Shaft
- Pinch Style Spring Adjustment Collar
- Hybrid Shaft Seal
- User Revalveable/Rebuildable
- Custom Valving Available
- Maintenance Free Design
- Coil Kit Included with All Shocks
- Indexed Spring Cone
- Fine Thread Adjustment

Coil Spring Mounting
Kit Included With Each
G2 / G3 Shock

NO Leaks!

Platinum 4

Internal design components such as the High Flow Digressive Piston, improved separator cavity balance, carbon fiber shim technology, Titanium Nitride coated shaft, and hybrid shaft seal are some of the reasons the Platinum 4 dominated the 2009 Quarter Midget Season.



P4 Standard	P4 Split Valve
85540-3	85540-3/5
85540-4	85540-5/3
85540-5	85540-4/6
85540-6	85540-6/4

Complete Shock
w/ Coil Over Kit

- High Flow Digressive Control Piston
- User Revalveable (No Piston Change Required)
- Pinch Style Spring Adjustment Collar
- Hybrid Shaft Seal
- Titanium Nitride Coated Shaft
- Custom Valving Available



Shock Rebuilding

Shock Inflation Tool



Shock Inflation Tool [Model 75590](#)

Shock Rebuild Drip Cup



Drip Cup [Model 75566](#)

Shock Rebuild Tool Kit

Shock Rebuild Tool Kit [Model 75592](#)

Shock Vise



Shock Vise [Model SV-1](#)

- Shock Rebuilding Made Easier
- Holds Shock Top & Piston Shaft
- Clamp In Existing Vise or Bolt Down

Universal Shock Wrench
Fits All Tanner Shocks



Shock Wrench [Model 75575](#)

Shock Jaws

Fits All Tanner Shocks



Shock Jaws [Model 75570](#)

Shock Body Jaws

Fits All Tanner Shocks

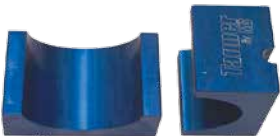

Shock Body Jaws [Model 75572](#)

Shock Inflation Adapter



Inflation Adapter [Model 75580](#)

Valve Core Tools



Deluxe Valve Core Tool [Model 22460](#)



Deluxe Valve Core Tool w/10 Valve Cores [Model 22470](#)

Rebuild Your Shocks With These Handy Tools

Shock Oil

Specially Formulated for Shock Applications



Pint Shock Oil Fills 6 Shocks	Model 75540	
Quart Shock Oil Fills 12 Shocks	Model 75545	



Shock Service Parts

Old Style
G2 / G3 Rebuild Kit
Built Prior to Jan. 2009



Old Style G2 / G3 Rebuild Kit
Model 85642

New Style
G2/G3/P4 Rebuild Kit



G2/G3/P4 Rebuild Kit
Model 85742

Shock Rebuild Kit

VISION Rebuild Kit



VISION Rebuild Kit
Model 85842

Shock Master Rebuild Kit



Old Style G2 / G3 Master Rebuild Kit	Model 85605
G2/G3/P4 Master Rebuild Kit	Model 85705
VISION Master Rebuild Kit	Model 85805

(Each Kit Rebuilds 8 Shocks)

Shock Master Valving Kit



G2 / G3 Shock Master Valving Kit	Model 85600
P4 Shock Master Valving Kit	Model 85700
VISION Shock Master Valving Kit	Model 85800
QUAD FLOW Shock Master Valving Kit	Model 85900

G2 / G3 Carbon Shim Kit

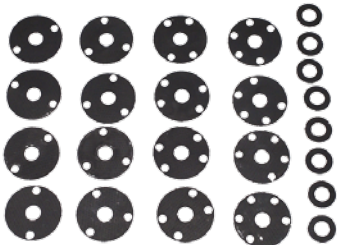

G2 / G3 Carbon Shim Kit
Model 85602

P4 Carbon Shim Kit

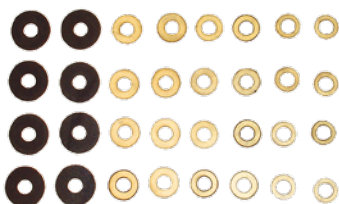

P4 Carbon Shim Kit
Model 85702

VISION

Sandvick Steel Shim Kit



VISION Shim Kit
Model 85802

(Each Kit Contains Shims
To Completely Valve 4 Vision Shocks)

Shim Kits

QUAD FLOW

Sandvick Steel Shim Kit



QUAD FLOW Shim Kit
Model 85902

(Each Kit Contains Shims
To Completely Valve 4 Vision Shocks)



Shock Parts



**G2/G3/P4
Flat Spring Cone**
#85525



Shaft Guide
#85730



**G2/G3/P4
Tapered Spring Cone**
#85522



**G2/G3/P4
Adjustment Nut**
#85527



**VISION
Scalloped Spring Cone**
#85822



**VISION
Adjustment Nut**
#85827

Shock Shafts



G2 / G3 Shock Shaft (2 Pack)	Model 85610	
P4 / VISION Shock Shaft (2 Pack)	Model 85710	

Quad Flow Shim Stop

#8553-07



Rod End
#85524

Cone Spacer

#85523



Bare Shock Parts

Description	Part #	Description	Part #
G2/G3 Control Piston	8551-080	New Style Shaft Seal	8551-141
G2/G3 Control Piston Shim [split valve only]	8551-082	Bronze Bushing	8551-150
G2/G3 Bleed Spacer	8551-084	#6 O-Ring [Bleed Screw]	8551-180
P4 Primary Shim	8551-086	Valve Core	8551-210
P4 Secondary Shim	8551-087	Control Piston Band	8551-220
G2/G3/P4 Separator Piston	8551-090	Shaft Guide O-ring	8551-230
Gas Fill Port	8551-100	G2/G3/P4 Separator Cap O-ring	8551-240
Spherical Bearing	8551-120	G2/G3 AN Washers for control piston	8551-250
3/4 Internal Snap Ring	8551-130	Internal Shaft O-ring	8551-270
G2/G3 Shaft Seal [Old Style U-Cup]	8551-140	G2/G3/P4 Separator Piston O-ring	8551-280

Evolution Of The Tanner Shock Piston



G1 Piston
1999 - 2003



G2 Piston
2004 - Present



P4 Piston
2008 - Present



VISION Piston
2011 - Present

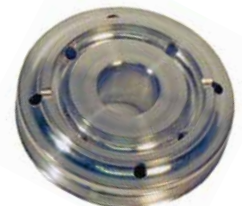

Quad Flow Piston
2014 - Present



Quarter Midget Springs

Fits ALL Quarter Midget Shocks

All Springs are not created equal. Each rate of a HOT SPRING & RED HOT SPRING is custom designed to an optimized stress level. The optimized stress level creates a consistent and quicker recovery allowing the tire to follow the back side of bumps and undulations promoting quicker lap times.

3 1/2" Red Hot Springs	
Lbs. Per In.	Part #
75 #/in.	753-75
80 #/in.	753-80
85 #/in.	753-85
90 #/in.	753-90
95 #/in.	753-95
100 #/in.	753-100
105 #/in.	753-105
110 #/in.	753-110
115 #/in.	753-115
120 #/in.	753-120
125 #/in.	753-125
130 #/in.	753-130
135 #/in.	753-135
140 #/in.	753-140
145 #/in.	753-145
150 #/in.	753-150
155 #/in.	753-155

HOT SPRINGS



5" Tall

RED HOT SPRINGS



3-1/2" Tall

5" Hot Springs	
Lbs. Per In.	Part #
55 #/in.	752-55
60 #/in.	752-60
65 #/in.	752-65
70 #/in.	752-70
75 #/in.	752-75
80 #/in.	752-80
85 #/in.	752-85
90 #/in.	752-90
95 #/in.	752-95
100 #/in.	752-100
105 #/in.	752-105
110 #/in.	752-110
115 #/in.	752-115
120 #/in.	752-120
125 #/in.	752-125
130 #/in.	752-130
135 #/in.	752-135
140 #/in.	752-140
145 #/in.	752-145
150 #/in.	752-150
155 #/in.	752-155
160 #/in.	752-160
165 #/in.	752-165
170 #/in.	752-170
175 #/in.	752-175
180 #/in.	752-180
185 #/in.	752-185

Springs

Each Rate Has A Calibrated Wire Diameter

CNC Wound With Optimum Pitch

Open Pitch Design Yields Instant Recovery

Precision Ground Closed Ends



HydroShox

Combines the Adjustability of Hydraulics with the Damping of Coil Over Shocks



- 17-3/4" Eye to Eye Raised
- 13-3/4" Eye to Eye Lowered
- 4" of Hydraulic Cylinder Travel
- 3" of Shock Travel
- Fits Standard 2" ID x 4" Tall Coil Over Springs
- One Hydraulic Unit Controls All 4 Cylinders
- Other Sizes Available Soon



Quarter Midget & Go Kart

Tach Mounting Brackets

Sendec Style Bracket



Mychron Style Bracket



5/8" Mychron Bracket	Model 75023	
3/4" Mychron Bracket	Model 75024	
7/8" Mychron Bracket	Model 75025	
3/4" Sendec Bracket	Model 95910	
7/8" Sendec Bracket	Model 95915	

HONDA Linkage Kit



Honda Linkage	Model 75010	
Honda Cable	Model 75005	
Deco Cable	Model 75006	

Exhaust Clamps



Deco



Honda

Clamps On Nerf Bar
CNC Billet Aluminum

Deco Exhaust Clamp	Model 75020	
Honda Exhaust Clamp	Model 75021	

Engine Plates



Tapered Plate



Standard Flat Plate



Hardware
Included

Tapered Plate Model 75055

1/4" Std. Plate	Model 75050	
1/2" Std. Plate	Model 75052	

Steering Shaft Mount

Adjustable



Steering Shaft Mount Model 75060

Steering Wheel Quick Disconnect



Complete Kit	Model 75070	
Spline Only	Model 75069	

Engine Starter Pull Strap



8ft Pull Strap Model 75400

Quarter Midget Axle Shafts

36" Long
6061 T6 Aluminum
Centerless Ground
Keyed for Component Location



Standard Aluminum Axle	Model 75134	
Snap Ringed Axle	Model 75135	

Fits Bullrider, Stanley & Early Nervo

Chassis Alignment Bars



Front Alignment Bar	Model 75105	
Rear Alignment Bar	Model 75110	



Drivetrain

Engine Sprockets	
Size	Part #
18 Tooth	75218
19 Tooth	75219
20 Tooth	75220
21 Tooth	75221
22 Tooth	75222
23 Tooth	75223
24 Tooth	75224
25 Tooth	75225
26 Tooth	75226
27 Tooth	75227
28 Tooth	75228
29 Tooth	75229
30 Tooth	75230
31 Tooth	75231
32 Tooth	75232
33 Tooth	75233
34 Tooth	75234
35 Tooth	75235
36 Tooth	75236
37 Tooth	75237
38 Tooth	75238
39 Tooth	75239
40 Tooth	75240
41 Tooth	75241
42 Tooth	75242

Sprockets



Axle Sprockets	
Size	Part #
23 Tooth	75323
24 Tooth	75324
25 Tooth	75325
26 Tooth	75326
27 Tooth	75327
28 Tooth	75328
29 Tooth	75329
30 Tooth	75330
31 Tooth	75331
32 Tooth	75332
33 Tooth	75333
34 Tooth	75334

- Special Tooth Design for Easy Pick & Release
- CNC Machined For Accuracy
- Heat Treated Aluminum
- Fits All Popular Hubs
- Light Weight

Chassis Dyno

This small car chassis dyno is designed for up to 20 hp. testing of go-karts, quarter midgets, Mini Cup & Bandolero cars. The portable design makes race track set up & use a breeze. Troubleshoot your issues without burning up limited practice time. Car can be set up & performing dyno tests in minutes.

- Large Diameter Pressure / Torque Gauge
- Fine Resolution Load Valve
- Quick Reference HP / Torque Charts
- High Grip Aluminum Knurled Rollers
- Remote Throttle Control
- All ALUMINUM frame construction
- 5" ALUMINUM Rollers

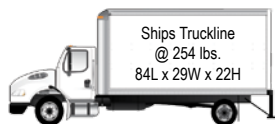

Quarter Midget / Mini Cup / Go-Kart / Bandolero **D3** Chassis Dyno 60" ...Model 99500



WiFi Scales

Scales Create Their Own Network Allowing Any WiFi Capable Device To Connect

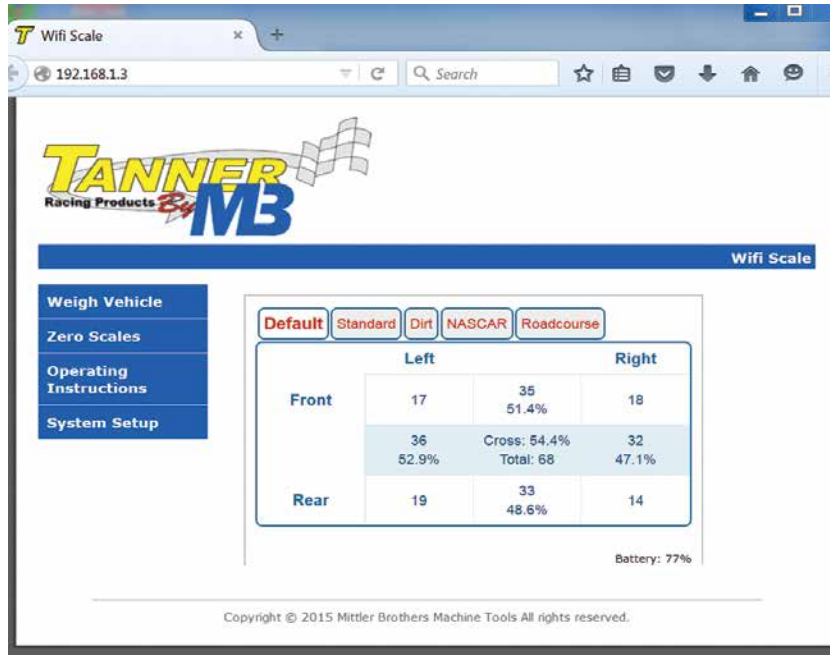

- No External Network or Internet Connection Required
- No App Required
- Works With Virtually Any Mobile Phone, Tablet, or Computer
- Read & Control Scales via Web Browser
- Encrypted Secure Connection
- Available in any of the 10" or 15" Wireless Scale Platforms



Ultimate Wireless Radio Frequency Scales

This scale system is in use by Top NASCAR Sprint Cup, Nationwide, and Camping World Truck Series Teams. No matter what form of motorsports you participate in, the ULTIMATE Wireless RF Scale system will make your job easier and more accurate. Just Imagine being able to walk around your race vehicle not tripping over cables and getting all the information you need on the palm sized control panel. All weights and percentages can be displayed on the 5-1/4" x 7-1/2" control.

- AA Platform Batteries Last Up to 400 Hours of Use
- All Functions Contained In 5-1/4" x 7-1/2" Control
- Custom Fitted Case for Hand Held and Charger
- Backlit High Contrast Display for Night Use
- Individual and Multiple Pad Zeroing
- Battery Life Indicator Displays in %
- User Selectable Display Formats
- Pounds or Kilograms Selectable
- Uses Inexpensive AA Batteries
- Instant Display Updates
- 5.7" LCD Display
- Internal Antenna
- Touch Screen
- 1 Year Warranty



1" Tall Wireless Scales

Model 50550

- Four 1" Tall 15" x 15" Scale Pads
- 5.7" LCD Touch Screen Display With Carrying Case
- Same Great Features As Our Ultimate RF Scales



3" Tall Pads

New 1" Tall Pads

6000 lb Capacity (1500 lbs per Pad)

These Scales Are 1/2 The Weight Of A Standard Scale & They Have 2x The Strength
Billet Roll Back Trays For 1" Scales



- 60% Less Deflection
- No More Torsional Twist
- Easy to Carry, Store & Use
- Includes Four Billet Roll Back Trays
- Aircraft Aluminum Smooth Top Construction

1" Tall Wireless Scales With Roll Back Trays

Model 50555

1" Tall Wired Scales With Roll Back Trays

Model 50345

Billet Roll Back Trays For 1" Scales Only

Model 52430

Scales Not Included



NEW 1" Tall RaceScales

1" Tall Wired Scales

Model 50340

- Four 1" Tall 15" x 15" Scale Pads
- Digital Display With Carrying Case
- Same Great Features As Our Deluxe Scales



USB Style Connectors

Wireless Ultimate RF Scales 15" Pads

Model 50520

- Permanent Mold design yields stronger parts
- Smooth Top for Easy Camber Rollout
- Built In Handles
- Full 225 Square Inch Surface Area
- Lightweight Design
- Internal Rib Design Reduces Deflection



15" Pads

7000 lb Capacity (1750 lbs per Pad)



Wireless Ultimate RaceScales Jr. 10" Pads

Applications

- Go-Kart
- Quarter Midget
- Mini Cup
- TQ/Micro
- Formula SAE
- Bandolero
- Arena Cup
- Quads



The Wireless Ultimate RF 10" Scales are designed to accommodate vehicles under 1000 pounds. The same technology used in the ULTIMATE Wireless RaceScales is utilized to deliver a high quality small car system at an affordable price.

Wireless Ultimate RaceScales Jr. 10" Pads Model 50220



RaceScales

RaceScales Jr. 10" Pads

- 10" x 10" CNC Billet Aluminum Pads
- 250 Lbs. Per Pad Capacity
- 9' Heavy Duty Flexible Cables
- Lbs. or Kg Selectable
- Displays All Weights and Percentages
- Zero All Pads at Once or Individually
- 40 Hr. Battery Life (rechargeable)
- 1 Year Warranty
- 1/10th Pound Resolution



Applications

- Go-Kart
- Quarter Midget
- Mini Cup
- TQ/Micro
- Formula SAE
- Bandolero
- Arena Cup
- Quads

RaceScale Jr.'s are the perfect choice in weighing vehicles 1000 pounds and under reading in 1/10th pound resolution. New Deluxe Software allows user to calculate center of gravity and store setups. Control Module operates up to 40 hours on internal battery and has instant "ON" feature with supplied power adapter. Conditioned Software updating provides stable readings with quick updates when chassis adjustments are made.

RaceScale Jr. 10" CNC Pads (with case) Model 50210

Standard RaceScales

- 15" x 15" Pads
- 1500 lbs. Per Pad Capacity
- 18' Heavy Duty Flexible Cables
- Strongest Pads in the Industry
- Lbs. or Kg Selectable
- Displays All Weights and Percentages
- Displays all Information at Once
- Zero All Pads at Once or Individually
- 40 Hr. Battery Life (rechargeable)
- 1 Year Warranty



Displays all Information at Once

This low cost version does not have anything economical about it except the price. Uses many of the same high quality components that our Deluxe systems are manufactured with.

Standard RaceScales w/ 15" Pads Model 50250
Poly Storage Case Model 53660



RaceScales

Deluxe RaceScales

- 1500 lb per wheel capacity
- 15" x 15" Permanent Mold Platforms
- Custom Matched Load Cells
- Stainless Push-lock Connectors
- Gold Plated Contacts
- One Touch Functions
- Selectable Display format
- Memory Storage
- Center of Gravity Calculation
- Fuel Mileage Calculation
- 18' Heavy Duty Flexible Cables
- Displays All Weights and Percentages
- Lbs. or Kg Selectable
- Zero All Pads at Once or Individually
- 40 Hr. Battery Life (rechargeable)
- 1 Year Warranty



An ideal system for NASCAR, SCCA, IRL, USAC, and Other Professional Teams who demand the best. Deluxe RaceScales were developed for the racer by the racer using today's leading edge technology.

Deluxe RaceScales w/ 15" Pads (with case) Model 50300

Deluxe RaceScales w/ 15" Pads & Scale Cart Model 50310

Aircraft Scales

- 15" x 15" Cast Aluminum Pads
- 1500 Lbs. Per Pad Capacity
- Reads to 1 Lb. / 1/10% Accurate
- Displays All Weights and Percentages
- Displays All Information at Once
- Lbs. or Kg Selectable
- Zero All Pads at Once or Individually
- 40 Hr. Battery Life (rechargeable)
- 1 Year Warranty
- 18' Heavy Duty Flexible Cables



Deluxe Aircraft Scales include custom length cables with Deluxe Stainless Steel connectors and software to calculate center of gravity height. Used by Experimental Aircraft builders with great success.



Aircraft Scale Set (with case) Model 50297

Certification Available

Scale Accessories

Roll Back Tray



- 15" Long Roll Back Area
- Roll off/Roll on Reduces Suspension Binding
- Promotes Accurate Readings
- Works with Wired or Wireless Systems

Rollback Set Of 4 w/ Steel Feet **Model 52421**

Leveling Foot



Steel Leveling Foot **Model 52426**

Replacement Cables



Economy Cable	Model 53620	
Deluxe Cable	Model 53640	
USB Cable	Model 53680	

Control Box & Cable Storage Case



- Light Weight Double Wall Poly Design
- Protects Your Valuable Investment

Poly Storage Case **Model 53660**

Portable Aluminum Scale Cart



- Ships UPS
- Rolls Easy
- All Aluminum
- Control Box Fits in Top
- Extra Storage For Turning Plates
- Pad Shelves Angled Down in Back for Stability

Scale Cart **Model 52300**

10" Elephant Stands



- 10" Tall
- Aluminum Construction
- Wheel Stops Included

10" Stands / Qty 4 **Model 52400**

Control Box Charger / Battery



Replacement Control Box Charger	Model 53530
Replacement Control Box Battery	Model 53580



Leveling

Laser Leveling Kit



- CNC Machined Targets & Swivel Laser Base
- Laser Etched Scale Won't Wear Off
- Fitted Carrying Case
- Absolute Must for Leveling Your Scales



Complete Laser Leveling Kit **Model 52500**

Chassis Set-Up Fixture

- Portable Design for Easy Set-Up & Storage
- Custom Built To Your Wheel Base
- All Aluminum Construction
- Adjustable Tread Width
- Fits all 15" Scale Systems
- 12 Leveling Feet



Leveling Foot Detail



Chassis Set-Up Fixture **Model 51300**

Specify Wheel Base & Tread Width When Ordering

Smart Tool Digital Level



- Great for Setting Suspension Link Angles
- Reads Degrees, % Slope & Pitch
- Fits Levels Listed Below (See Page 9)

Smart Tool Digital Level **Model 1800**

Bandolero/ Legend Car Chassis Set-Up Fixture



Bandolero/Legend Car Set-Up Fixture
Model 51350



Ultimate Pull Down Rig

Benefits

- Perform Accurate Bump Stop or Coil Bind Setups
- Align Springs to Maximize Travel
- Travel and Evaluate Chassis Over Full Motion Range
- Study Bump Steer & Camber changes over the full suspension motion range
- Evaluate corner weight effects of sway bar changes
- Help Substitute for Testing Bans and Much More

Features

- Fully Self Contained & Computer Controlled
- Laptop Included With Data Acquisition Software Loaded
- Exports Data To Excel & Pi Toolbox
- Pull The Vehicle Down Or Push The Wheels Up
- Pull/Push to Distance or Wheel Load
- Extremely Rigid Frame For Minimum Deflection
- Built In Lighting Under Vehicle
- 3 Finger Scales Reading Outer, Center and Inner Loads
- Built In Heavy Duty Turn Plates
- Table Tilts For Easy Loading
- Installation And Basic Training Included

Options

- Servo Valves
- Sway Bar Load Measurements
- Bump Stop Load Measurements
- Pi Toolbox Data Export

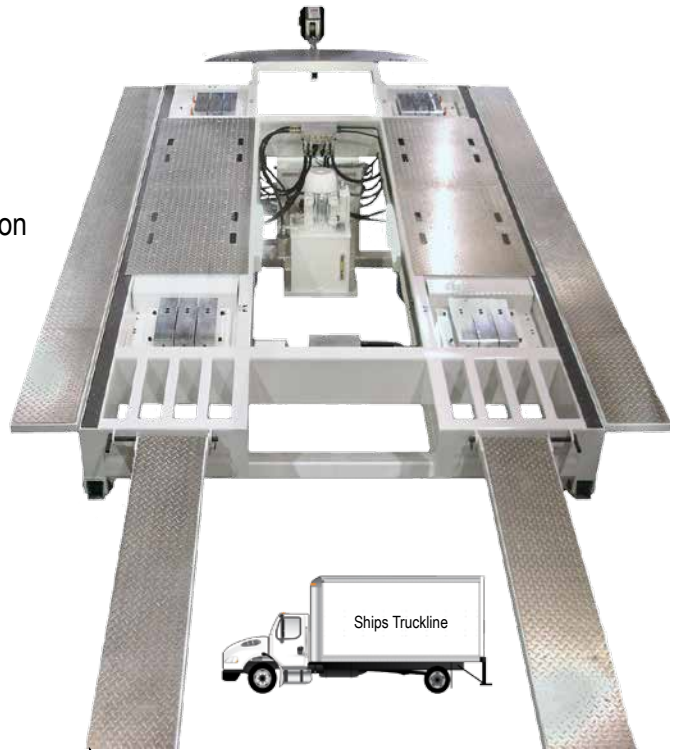

New *Spring Rater Attachment Coming Soon*



No Bind Chassis Hook Up



Rigid Frame Mounts



Shock Sensor

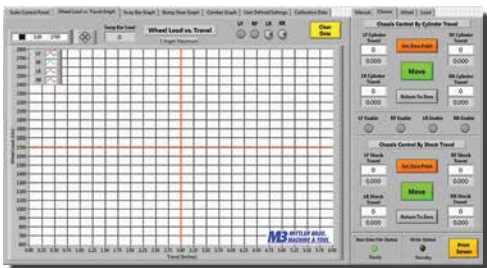

Wheel Load vs. Travel

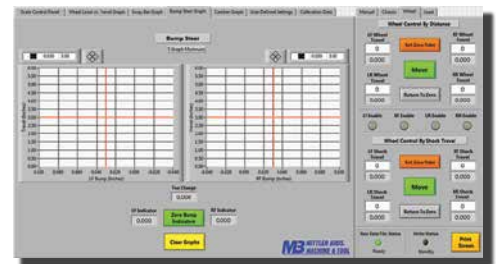

Bump Steer / Camber



Ultimate Pull Down Rig

Used by Race Winning Teams From Coast to Coast



**Servo Valves
Available Now!**
Maximum Repeatability

Quality, more features than expected, and very user friendly are just a few of the comments customers share regarding their ULTIMATE PDR. The ULTIMATE PDR is rapidly becoming the standard of NASCAR and Short Track Teams.

Pull Down Only Rigs Starting

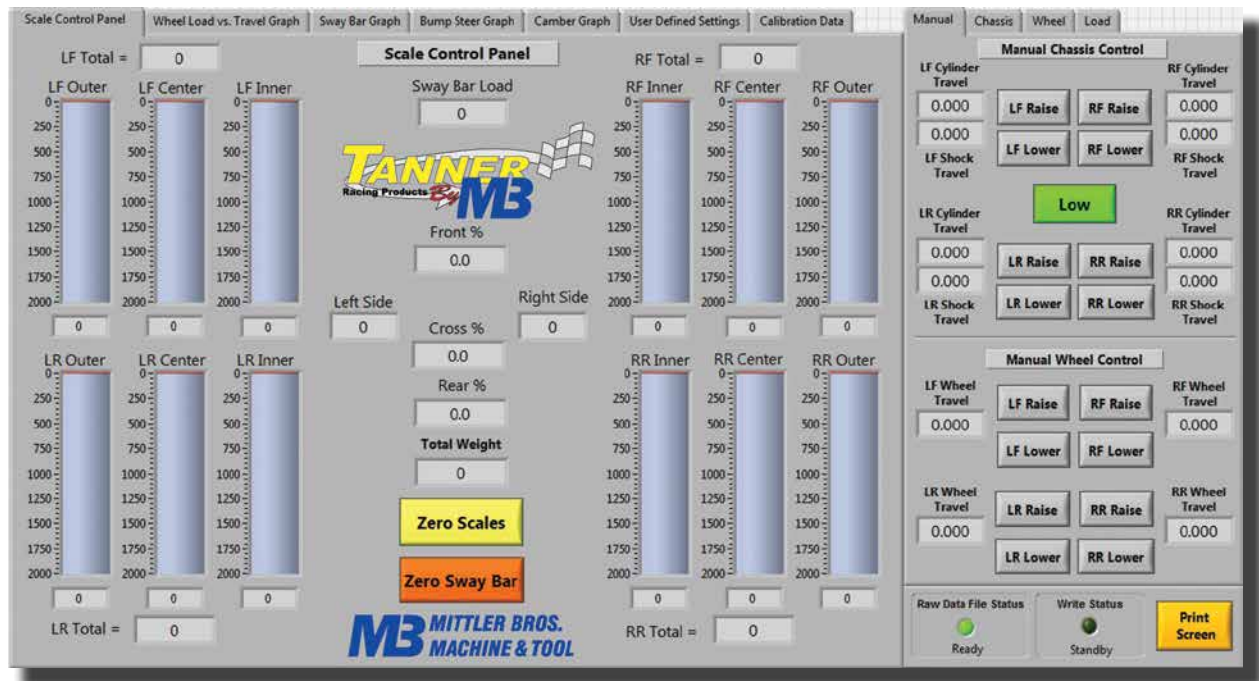

All Rig Functions Controlled From The Proprietary User Interface



Tire Gauges

Deluxe Tire Gauge Kit

Replacement Parts



A versatile quick change tire gauge kit for all types of racing. Why purchase 3 separate tire gauges when you can have all ranges covered in one kit with a convenient storage case. Never be stuck without the proper pressure range again.

Includes:

- Quick Change 15#, 30# & 60# Gauge Heads With Bleeders
- Quick Change Hose Assembly W/ 45° Swivel Chuck
- 2-1/2" Gauge Faces With Protective Bumpers
- Padded Carry Case

2-1/2" Acrylic Lens	Model 20006	
4" Acrylic Lens	Model 20007	
2-1/2" Rubber Bumper	Model 20012	
4" Rubber Bumper	Model 20014	

Deluxe Tire Gauge Kit Model 20190



Extreme Tire Management



Manifold Allows Up to Six Tires at a Time



Digital Accuracy

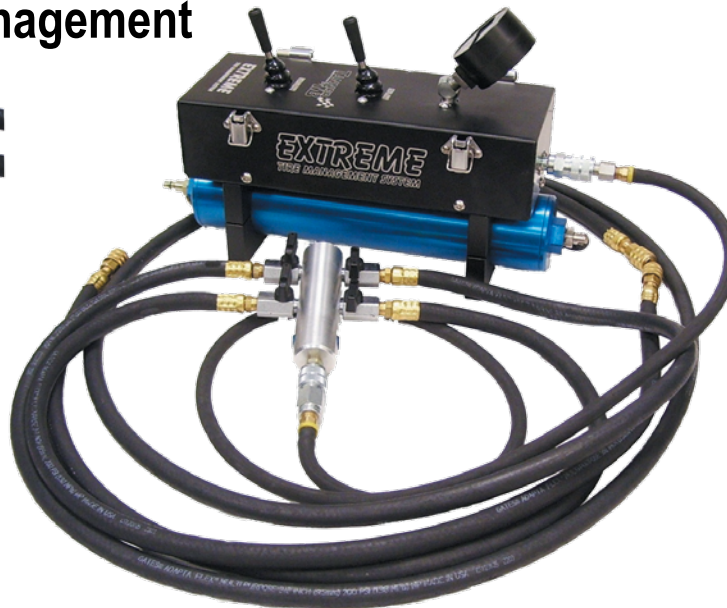

Removable Lid for Protection and Transport



Complete Kit Weighs Only 25 pounds

We don't make the nitrogen, WE MAKE IT BETTER

The Extreme Tire Management System uses a proprietary innovation that filters out moisture and contaminants from industrial grade nitrogen, resulting in pressure consistency in every set of tires. Other systems use nitrogen but can not provide this level of purification and portability.

- Enables you to purge your tires to virtually 0% humidity
- Will reduce your pressure build up by an average of 2 to 4 PSI
- Will purge and fill multiple tires at once
- Is light weight and portable
- Requires no electricity

Complete Extreme Tire Management System for 4 Tires Model 20950



Tire Gauges

Deluxe Tire Gauges

15 psi	Model 20115	
30 psi	Model 20130	
60 psi	Model 20160	

- 2-1/2" Face
- Quick Air Release
- Protective Bumper
- 45 Degree Swivel Chuck
- Industry Standard For Years



Liquid Filled Tire Gauges

15 psi	Model 20215	
30 psi	Model 20230	
60 psi	Model 20260	

- 2-1/2" Face
- Quick Air Release
- Protective Bumper
- 45 Degree Swivel Chuck
- Glycerin Filled For Shock Resistance



Night Bright Tire Gauges

**Electroluminescent
Internal Lighting!**

**The Best Gauge For
Day And NIGHT!**

- Easy to Read
- Quick Air Release
- Protective Bumper
- Storage Case Included
- Excellent Night Viewing
- 45 Degree Swivel Chuck
- Large 4" Diameter Illuminated Face
- Internal Battery Virtually Lasts Forever

15 psi	Model 20515	
30 psi	Model 20530	
60 psi	Model 20560	



Deluxe
Pressure
Release

Momentary
On Switch

Actual Photo Taken
At Night

Monster Tire Gauges

2-1/2" Glow In The Dark

- Excellent Night Viewing
- Quick Air Release
- Face Glows for Hours
- Protective Bumper
- 45 Degree Swivel Chuck
- 2-1/2" Diameter Easy to Read Face

15 psi	Model 20315	
30 psi	Model 20330	
60 psi	Model 20360	

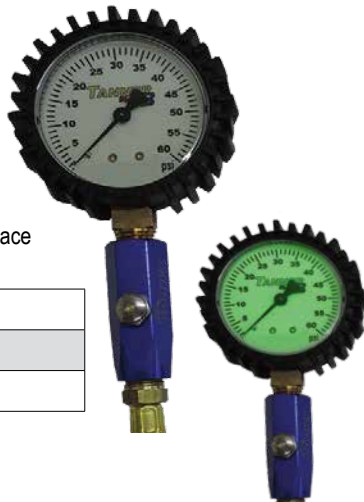

- Large 4" Face
- Easy to Read
- Shock Proof Bumper
- Storage Case Included
- Deluxe Handle with Release

15 psi	Model 20415	
30 psi	Model 20430	
60 psi	Model 20460	



Set-up Equipment

Digital Tread Depth Gauge

- High Quality Mitutoyo Gauge
- Anodized 4 Point Foot w/ Sight Hole
- Form Fitted case
- Zeroing Block



Model 21600

Nitro Dryer



Reduces Moisture Going Into The Tires Which Helps Avoid Pressure Build-Up

- Lightweight Design
- Rechargeable Cartridge
- Easy In-Line Hook-Up
- All Aluminum Construction

Nitro Dryer	Model 20900
Recharge	Model 20906
Replacement Cartridge	Model 20905

Staggerite Tire Caliper

- Round Stationary Arm Keeps Measurement Accurate
- Laser Etched Markings
- 55" to 102" Circumference

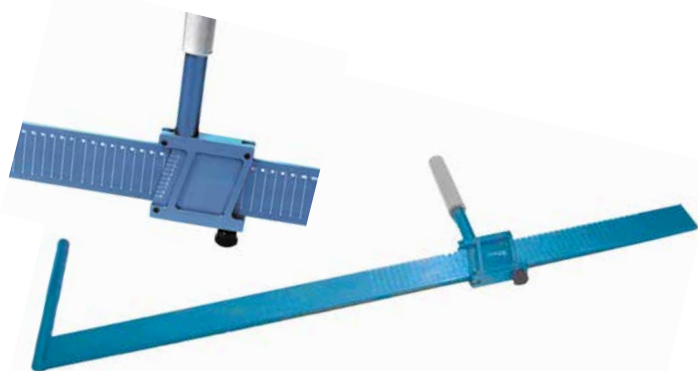

Staggerite Tire Caliper

Model 22120

Stagger Tapes

- Lightweight & Portable
- Measure Tires Quickly
- Flexible & Easy to Read
- 10' Long



1/4" Stagger Tape	Model 22000
1/2" Stagger Tape	Model 22010

Stagger Roller

- Measure Tires Quickly
- Lightweight
- Easy To Store
- All Aluminum



Stagger Roller

Model 22130



Set-up Equipment

EZ Sweep Caster Slip Plates

EZ Sweep is a new unique design in Caster Slip Plates.

- 15° or 20° Sweep
- No Grease or Bearings
- Roll on/off, No jack required
- PTFE Impregnated Slip Barrier
- Low Profile (3/16" Total Height)
- Ultra Durable Stainless Steel Base



15° Model 57115

20° Model 57120

Turn Plates

- Great For Checking Ackerman
- Low Profile Design, 1" High
- Aluminum Construction
- Quick & Accurate
- 25° Rotation

Model 57200



Set-up Equipment

Caster / Camber Gauge

Shown With 57320 Magnetic Adapter and Included Case



- 4° to 12° Caster
- Custom Fitted Case
- 6° Positive / Negative Camber
- Use With or Without Turning Plates
- Stepped Design Keeps All Vials on Spindle CL
- Separate Pos. / Neg. Vials for Accurate Readings

Caster / Camber Gauge	
Description	Part #
Gauge Only	57400
Gauge & Magnetic Adapter	57420
Gauge & Ford Adapter	57430
Gauge & Wide 5 Adapter	57440
Gauge & SCP Adapter	57450
Gauge & GM Adapter	57460
Gauge & Bandolero Adapter	57470
Gauge & 5/8" Adapter	57480
Gauge & 14mm Adapter	57490

Toe Plate Kit



Kit Includes (2) Toe Plates & (2) Precision Tape Measures

Toe Plate Kit **Model 56200**

Digital Camber Gauge



Check & set your Camber quickly and easily with this Digital Tool. Reads in 1/10 Degree Resolution and uses standard Caster / Camber Gauge adapters. Ships with 57320 Magnetic Adapter. Smart Tool Included. Order other Adapters Separately.

Digital Camber Gauge w/ 57320 Adapter	Model 57300
Digital Camber Gauge Mount w/ 57320 Adapter	Model 57305

(mount & adapter only, no Smart Tool or Case)

Caster / Camber Adapters



Caster / Camber Adapters	
Description	Part #
Magnetic Adapter	57320
Ford Adapter (3/4-16)	57330
Wide 5 Adapter (1 13/16-16)	57340
SCP Adapter (27/32-20)	57350
GM Adapter (3/4-20)	57360
Bandolero Adapter (18mm x 1.5)	57370
5/8" Adapter (5/8-18)	57380
14mm Adapter (14mm x 1.5)	57390

Valve Core Tools



4-Way Valve Core Tool	Model 22450
Deluxe Valve Core Tool	Model 22460
Deluxe Valve Core Tool w/ 10 Cores	Model 22470



Adjustment Tools

A-Arm Shims

Standard Shims



- Fits 6" A Arm Centers
- Kit Contains 1 Each: 1/16, 1/8", 1/4", and 3/8"
- Staggered Tabs Allow For Quick & Easy Changes
- Laser Etched Markings For Easy Size Identification

Standard Camber Shim Kit	Model 40600
1/2" Camber Shim	Model 40610
3/4" Camber Shim	Model 40615
1" Camber Shim	Model 40620

Universal Shims



- Fit 5-1/2" & 6" A Arm Centers
- Kit Contains 1 Each: 1/16", 1/8", 1/4", and 3/8"

Universal Camber Shim Kit [Model 40650](#)

Pinion Shims



1° Pinion Shim	Model 40510
1-1/2° Pinion Shim	Model 40515
2° Pinion Shim	Model 40520

Lowering Blocks



1/2" Lowering Block	Model 40405
1" Lowering Block	Model 40410
1-1/2" Lowering Block	Model 40415
1°, 1/2" Lowering Block	Model 40550-1
1-1/2°, 1/2" Lowering Block	Model 40550-15
2°, 1/2" Lowering Block	Model 40550-20

Spring Rubbers



- Fine Tuning At Its Best
- Inserts Quickly
- Increase Spring Rate Instantly
- Urethane Material Never Hardens
- Color Coded For Easy Reference

Soft Spring Rubber	Model 41510
Medium Spring Rubber	Model 41515
Firm Spring Rubber	Model 41520

Soft Coil-Over Spring Rubber	Model 42005
Medium Coil-Over Spring Rubber	Model 42010
Firm Coil-Over Spring Rubber	Model 42010

Jack Bolt Clamps



Standard Right Clamp	Model 90600
Tapered Right Clamp	Model 90601
Standard Left Clamp	Model 90610
Tapered Left Clamp	Model 90611



Bump Steer Tools

One Step
Bump Steer Gauge



Bump Steer Gauge



- Only One Indicator Needed
- Fits 5x5, 5x4-3/4 & 5x4-1/2
- Compact Portable Design
- Ideal For Shop or Track Use
- Precision Machined Aluminum Wheel Plate

- Adjusts To Any Height
- Lightweight & Portable
- Measures 6" of Travel
- Comes With 2 Dial Indicators
- Fits 5 x 5 and Standard Wide 5 Hubs
- Works at Ride Height or On Jack Stands

One Step Bump Steer Gauge	Model 1200-BSG
Super "TRICK" Digital Dial Indicator	Model 1200-504

Bump Steer Gauge	Model 56100
Replacement Dial Indicator	Model 56110
Wide Five Snap Cap Adapter	Model 1200-020

TECH NOTE

Front end geometry is one of the most important aspects of proper race car set-up. BUMP STEER is a major key to correct geometry. Incorrect BUMP STEER will allow the tires to turn on their own as the suspension travels up and down. A car with proper BUMP STEER will have faster and more consistent lap times. Today's coil bind and bump stop set-ups make BUMP STEER settings more critical than ever.

Accu-lign



- Excellent suspension adjustment access
- High accuracy - no wheel run out errors
- Precise rolling radius/corner weight control
- Precise leveling with floor tiles or laser
- Billet aluminum, CNC milled for high accuracy
- Includes 4 wheel plates
- Available for any hub pattern including centerlocks
- Raises vehicle approx +5" for easy access
- DIY super accurate water level using home center PVC pipe
- Specify Bolt Pattern(s) When Ordering

The Accu-Lign is a revolutionary alignment system that: solves suspension access problems, eliminates roll on pads and ramps, and improves alignment accuracy.

Complete **Accu-Lign System** (Starting at)



Bump Stop Adjuster



Bump Stop Adjuster
Model 56160

The remote adjustable bump stop perch is a new innovative method to making racing with bump stops EASY! No more plastic shims to fracture or be forced out.

- Total lift of 1/2"
- Compact remote ram
- 2-1/2" Spring register
- Fits all coil over shocks
- Hard anodized Aircraft aluminum
- Light weight Kevlar transfer lines
- Direct replacement for lower spring perch
- Cuts time of tuning your bump stops by 75%
- Each turn of remote raises or lowers bump stop 1/8"
- Can be mounted in reach of the driver where rules allow or under the hood for easy access



Vibration resistant remote ram raises or lowers bump stops 1/8" per turn.



Quick release dry break allows for instant shock removal. Makes for user friendly spring or bump stop changes.

Pivot Jack

An Innovative Solution To Tight Garage Spaces !

The ULTIMATE Pivot Jack satisfies many needs for the automotive industry, motorsports, and the hobbyist. Unique 360° pivoting handle allows user to jack vehicles in tight areas. Twist handle release allows for a smooth controlled down action as well.

- 1 Ton Capacity
- Weighs 55 Lbs.
- Handle Pivots 360°
- 21" Maximum Height
- 3 1/2" Minimum Height
- Aluminum Construction
- Built In Hydraulic Bypass
- 16 Strokes To Maximum Height

Pivot Jack
Model 55000

Who benefits from the Pivot Jack?

- Tire Stores
- Restoration
- Auto Shops
- Body Shops
- Race Teams
- Auto Storage
- Car Collectors
- Roadside Service



Pyrometers

Smart Temp Memory Pyrometer

Smart Temp will store 10 complete sets of temperatures recording three places per tire. Comes with detachable probe and foam lined protective case. Designed for left or right handed use. The Smart Temp can be ordered with the Auto Lock feature which seeks the highest temp, records it, and prompts you to move the probe to the next location. An excellent diagnostic tool for chassis tuning allowing you to pinpoint problem areas in your chassis setup.

- 10 sets of Memory
- 3 Temps Per Wheel
- Carrying Case
- Left or Right Handed
- Temperature Averaging
- Adjustable Contrast
- Detachable / Replaceable Probe

LEFT = 177	RIGHT = 210
LF x LR = 197	RF x LR = 195

Side & Cross

170	189	208
183	198	212

Wheel & Axle

170	189	208
183	198	212

Tires

Smart Temp	Model 21300
Smart Temp w/ Auto Lock	Model 21320
Replacement Probe	Model 21050



Digital Tire Pyrometers

- Reliable Type "K" Thermocouple
- Convenient Coiled Cord
- Foam Lined Carrying Case
- 1/4 of 1% Accuracy
- Operates on 9 Volt Battery



Digital Pyrometer w/ Case	Model 21100
Digital Pyrometer w/o Case	Model 21000

Replacement Storage Case



Replacement Storage Case [Model 53666](#)

Digital Infrared Pyrometers

- Use for Tires, Headers, Interior Hot Spots or Track Temps
- Temps at The Touch of a Finger
- Ranges From 0-750° Fahrenheit
- Laser Beam for Pin Point Accuracy



Mini Infrared w/Laser

[Model 21511](#)

Replacement Tire Probe

- Racing Tire Probe
- Fast Updates
- Strong Tip



Replacement Probe [Model 21050](#)



Data Recording

Robic Stopwatches



- Times up to 3 competitors at once, up to 450 memory recall
- Customize to use as a Start timer simultaneously or separately.
- 150 memory recall of each timer.
- Professional stopwatch with 150 memory recall for each of up to three (3) separate chronographs.
- Average, Fastest and Slowest lap time, number and speed.
- Water Resistant to 30 meters.

SC 505W Lap Memory
Model 25100



- Multi-mode Stopwatch - Lap, Split, or Dual Split timing modes.
- 50 dual memory recall of previous readings in ascending or descending order.
- 1/100 second resolution up to 24 hours.
- Automatically counts up to 1000 readings.
- Multi-mode countdown timer - stop, auto-repeat or count-up modes.
- 1/10 second resolution during countdown.
- Preset time values from one second to 24 hours.
- Completion alarm at conclusion of Countdown time.
- Shows current lap and split running times.
- Water Resistant to 30 meters.

SC-606W 50 Memory
Model 25120



- EL Backlight illuminates entire display.
- 300 Dual Split Memory recall.
- 1/100 second precision to 100 hours.
- User selectable Running Lap or Split Time.
- Automatic Lap Counter to 999.
- Speed Timer in mph/kph.
- 300 memory recall of lap speed, time and number.
- Advanced Countdown Timers show time remaining.
- Water Resistant to 30 meters.

SC 848W 300 Dual Memory
Model 25180



30500



30510



30520



30631

Standard Switch Panels

Starter Button & Ign.	Model 30500	
Starter Button, Ign. & Light	Model 30501	
Starter Button, Ign. & 1 Acc.	Model 30510	
Starter Button, Ign. & 1 Acc. w/ Light	Model 30511	
Starter Button, Ign. & 2 Acc.	Model 30520	
Starter Button, Ign. & 2 Acc. w/ Light	Model 30521	
Starter Button, Ign. & 3 Acc.	Model 30530	
Starter Button, Ign. & 3 Acc. w/ Light	Model 30531	
Starter Button & Magneto	Model 30540	

Deluxe Switch Panels

With Aircraft Flip Cover

Starter Button & Ign.	Model 30600
Starter Button, Ign. & 1 Acc.	Model 30610
Starter Button, Ign. & 1 Acc. w/ Light	Model 30611
Starter Button, Ign. & 2 Acc.	Model 30620
Starter Button, Ign. & 2 Acc. w/ Light	Model 30621
Starter Button, Ign. & 3 Acc.	Model 30630
Starter Button, Ign. & 3 Acc. w/ Light	Model 30631
Starter Button & Magneto	Model 30640

Specify Color When Ordering: **RED, BLUE or BLACK**



Switches & Electrical

Aircraft Safety Cover



Safety Cover

Model 33020

Aluminum Switch Handle Extensions



2" Extension (pair)	Model 33060
3" Extension (pair)	Model 33070

Sprint Car Battery Pack

- High Temp Wire
- All Hook Ups
- Switch
- 20 lb. Sender
- 9 Volt Battery Holder



Battery Pack Kit Model 32180

Weather Proof Switch Cover



Weather Proof Case

Model 33040

Charging Posts



Red (pos) Charging Post	Model 36320
Black (neg) Charging Post	Model 36340

Ignition Switch



Ignition Switch w/ Weather Proof Cover	Model 33100
Start / Ignition Switch	Model 33130
Magneto Switch	Model 33140

Push Button Starter Switch



HD Push Button Starter Switch Model 33150

Master Switches



Switch Panels Available in: **Red,**
Blue & Black

Master Switch	Model 35100
Master Switch w/ Panel	Model 35200
Alternator Master Switch	Model 35300

Through Panel Battery Cable Connectors



Red (pos) Through Panel Post	Model 36420
Black (neg) Through Panel Post	Model 36440



Clamp on Chassis Accessories



Helmet Hooks		
Description	Part #	
1-1/2" Blue Helmet Hook	95420-Blue	
1-1/2" Gray Helmet Hook	95420-Gray	
1-1/2" Red Helmet Hook	95420-Red	
1-5/8" Blue Helmet Hook	95430-Blue	
1-5/8" Gray Helmet Hook	95430-Gray	
1-5/8" Red Helmet Hook	95430-Red	
1-3/4" Blue Helmet Hook	95440-Blue	
1-3/4" Gray Helmet Hook	95440-Gray	
1-3/4" Red Helmet Hook	95440-Red	



**Breathers Work
on Rear Ends
and Transmissions!**

Rear End Breather		
Description	Part #	
1-1/2" Blue Vent-Clamp	95520-Blue	
1-1/2" Red Vent-Clamp	95520-Red	
1-3/4" Blue Vent-Clamp	95540-Blue	
1-3/4" Red Vent-Clamp	95540-Red	



Long Reach Universal Clamps		
Description	Part #	
1" Long Reach Universal Clamp	95810	
1-1/4" Long Reach Universal Clamp	95815	
1-1/2" Long Reach Universal Clamp	95820	
1-3/4" Long Reach Universal Clamp	95840	
2" Long Reach Universal Clamp	95860	
2-1/4" Long Reach Universal Clamp	95880	

Rear End Breather Tank



1-1/2" Vent Tank	Model 95525	
1-3/4" Vent Tank	Model 95545	

Short Reach Universal Clamps



1" Diameter Universal Clamp	Model 95715	
1-1/2" Diameter Universal Clamp	Model 95720	
1-3/4" Diameter Universal Clamp	Model 95740	

Replacement Breather



Replacement Breather

Model 95500

Mirror Mount Kits



1-1/2" Mirror Mount Kit	Model 95700	
1-3/4" Mirror Mount Kit	Model 95710	

Reducer Bushings

Use to Reduce Your Clamp ID Size



1-3/4" to 1-1/2" Reducer Bushing	Model 95000	
1-3/4" to 1-5/8" Reducer Bushing	Model 95010	



Clamp on Chassis Accessories

Includes Clamp On Holder & Insulated Bottle



Drink Holders		
Description	Part #	
1-1/2" Blue Drink Bottle Kit	95320-Blue	
1-1/2" Gray Drink Bottle Kit	95320-Gray	
1-1/2" Red Drink Bottle Kit	95320-Red	
1-3/4" Blue Drink Bottle Kit	95340-Blue	
1-3/4" Gray Drink Bottle Kit	95340-Gray	
1-3/4" Red Drink Bottle Kit	95340-Red	

Includes Clamp On Holder & Washable Padded Liner



Radio Holders		
Description	Part #	
1-1/2" Blue Radio Box	95220-Blue	
1-1/2" Gray Radio Box	95220-Gray	
1-1/2" Red Radio Box	95220-Red	
1-3/4" Blue Radio Box	95240-Blue	
1-3/4" Gray Radio Box	95240-Gray	
1-3/4" Red Radio Box	95240-Red	



Includes Clamp On Holder, 2 Insulated Bottles, 6' Kwik Connect Sippy Hose w/ Bite Valve



Kwik Change Drink Holder		
Description	Part #	
1-1/2" Blue Kwik Change Drink Kit	95325-Blue	
1-1/2" Gray Kwik Change Drink Kit	95325-Gray	
1-1/2" Red Kwik Change Drink Kit	95325-Red	
1-3/4" Blue Kwik Change Drink Kit	95345-Blue	
1-3/4" Gray Kwik Change Drink Kit	95345-Gray	
1-3/4" Red Kwik Change Drink Kit	95345-Red	

Firewall Bolt On Coil Mount

Description	Part #	
Blue Coil Clamp	95610-Blue	
Gray Coil Clamp	95610-Gray	
Red Coil Clamp	95610-Red	



Single Clamp On Coil Mounts

Description	Part #	
1-1/2" Blue Single Coil Clamp	95620-Blue	
1-1/2" Gray Single Coil Clamp	95620-Gray	
1-1/2" Red Single Coil Clamp	95620-Red	
1-3/4" Blue Single Coil Clamp	95640-Blue	
1-3/4" Gray Single Coil Clamp	95640-Gray	
1-3/4" Red Single Coil Clamp	95640-Red	



Misc. Accessories

Shifter Boot Kit



Shift Boot Kit	Model 40810
Shift Boot Only	Model 40812
Frame Only	Model 40814

Drawstring for Easy Changes
Includes: Boot, Frame & Rivets

Frame / Cage Gussets

Stronger Than Flat Gussets
Fit 1-1/2" to 1-3/4" Tube
No Trimming Required



10 Pack	Model 40310
25 Pack	Model 40312
100 Pack	Model 40314



Specify Color When Ordering: BLACK or NATURAL

"Solid Core" Steering Wheel

- Helps To Prevent Broken Fingers & Thumbs!
- Aluminum Construction
- Ribbed Cover
- 15" Diameter
- 3-1/2 lbs.



"Solid Core" Steering Wheel [Model 2600](#)

Heat Insulating Floor Mats

Reflects The Heat So Your Feet & Legs Don't Feel It.



10" x 10" Mat	Model 67120
10" x 15" Mat	Model 67130
10" x 20" Mat	Model 67140
20" x 20" Mat	Model 67150
20" x 30" Mat	Model 67160

Header Wrap

Available in: BLACK & NATURAL

1" x 12' Roll (Natural Only)	Model 66012
2" x 25' Roll	Model 66025
2" x 50' Roll	Model 66050
2" x 100' Roll	Model 66100



Misc. Tools

Frame Height Gauges

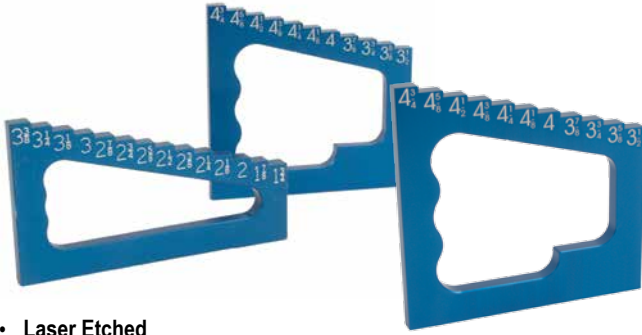

- Laser Etched
- Easy To Grip
- Solid Aluminum Construction

1-3/4" to 3-3/8"	Model 56010
3-1/2" to 4-3/4"	Model 56020
4" to 7-3/8"	Model 56030

Super Sockets

All Super Sockets Are Precision CNC Machined From Heat Treated Steel And Are Space Age Coated. No Springs Are Needed.



Kryptonite 2-1/4" Short Super Socket	Model 600-002-KS
Kryptonite 3-1/4" Long Super Socket	Model 600-001-KL
Original 2-1/4" Short Super Socket	Model 600-002-S
Original 3-1/4" Long Super Socket	Model 600-001-L

Plumb Bob Kit

Inexpensive Method to Square a Race Car
Includes 2 Plumb Bobs & 16' of String



Plumb Bob Kit [Model 56300](#)

Safety Wire & Pliers



9" Safety Wire Pliers	MB-TP68SR
9" Milbar Safety Wire Pliers	MB-TP68R
Safety Wire .020"	MB-TP67
Safety Wire .032"	MB-TP65
Safety Wire .041"	MB-TP66

AN Wrenches



- Laser Etched
- 90° & 15° Ends
- Will Not Spread Apart
- Color Anodized For Easy ID
- CNC Precision Machined

AN Wrenches		
Description	Part #	
-3 thru -10 Wrench Set	62100	
-6 thru -16 Wrench Set	62200	
-3 thru -20 Wrench Set	62300	
-3 Single Wrench (7/16")	62003	
-4 Single Wrench (9/16")	62004	
-6 Single Wrench (11/16")	62006	
-8 Single Wrench (7/8")	62008	
-10 Single Wrench (1")	62010	
-12 Single Wrench (1-1/4")	62012	
-16 Single Wrench (1-1/2")	62016	
-20 Single Wrench (1-13/16")	62020	

Air Rivet Gun



Air Rivet Gun [Model 62780](#)

Learn more about automotive tools we have.

