



**SAFETY SEMINAR
HANDBOOK**





THINK SAFETY

FROM ENERPAC TO YOU	3
HIGH PRESSURE HYDRAULIC TOOLS	4
LIFTING FORCES	5
COMPONENTS	6
JACKS 6	6
CYLINDERS	7
HAND PUMPS	8
HOSES	9
COUPLERS	10
OIL	11
GAUGES	12
HYDRAULIC SYSTEMS	12
BASIC HYDRAULIC SYSTEM	12
PRESSES	15
MAINTENANCE SET	16
SETUP CONSIDERATIONS	18
THE 80% RULE	18
EXTENSIONS	19
WORK AREA	19
EQUIPMENT STORAGE	20
SUMMARY IN BRIEF	21
QUESTIONS	22
ANSWERS	23

FROM ENERPAC TO YOU...

Thank you for using Enerpac hydraulic tools and welcome to the Hydraulic Tool Safety Seminar Handbook. This handbook is a companion to the Hydraulic Tool Safety Seminar Video. The handbook contains an overview of the information that was presented in the video and questions to help you study what you learned in the video.

Promoting personal safety is the primary goal of the video/handbook set. Whether you work in maintenance or production; power plant, shipyard, mine, shop floor, or construction site; we hope you will learn to use your hydraulic tools safely. When you practice safety, you also benefit by being more efficient and by increasing the useful life of your tools.

This seminar presents real concerns that real people deal with on a day-to-day basis. It's not just an exercise to fulfill a safety training requirement. You must be diligent when it comes to safety. We can provide high quality tools and accessories, but it is up to you to be aware of the situation that you put yourself and others into.

If you have a situation that is not covered in this seminar, please call our Technical Services Department. We are here to make even your toughest job easier.

We sincerely hope this seminar helps you get the most out of your Enerpac hydraulic tools.

Keep this handbook in your work area for ready reference.

HIGH PRESSURE HYDRAULIC TOOLS

High pressure hydraulic tools are designed to be operated up to 700 bar [10,000 psi] hydraulic pressure. Most fluid power systems operate at 210 bar [3,000 psi]; with some going up to 350 bar [5,000 psi].

The hydraulic pressure is the pressure that builds up inside the equipment (jacks, pumps, cylinders, hoses). Any components connected to a high pressure pump must also be rated to withstand 700 bar [10,000 psi] because the entire system becomes pressurized to 700 bar [10,000 psi].

Equipment Ratings

Equipment ratings include many different specifications. The ratings that you need to be the most concerned with are: hydraulic pressure or maximum rated pressure, capacity or tonnage, stroke, and oil capacity. These ratings are used to choose the correct equipment for your application. The ratings are explained in the table below.

Rating	Description
Hydraulic Pressure or Maximum Rated Pressure	This is the maximum operating pressure. All components in a hydraulic system have a maximum pressure rating. The operating hydraulic pressure should never be higher than that of the lowest rated component in the system.
Capacity or Tonnage	This is the maximum amount of weight a tool can lift, push, pull, or squeeze. Jacks, cylinders, presses, spreaders, and other accessories have capacity or tonnage ratings.
Stroke	This is the distance that the plunger will extend out of a jack, cylinder, or press. The stroke rating must be longer than the distance that you are moving the load.
Oil Capacity	This is the amount of oil a component holds. The pump must hold enough oil to fill the hydraulic circuit.
Note: If you are sizing equipment for an application, choose the cylinder first and then the pump. The pump should have a big enough reservoir to fill the cylinder and hose(s). New hoses are not filled with oil.	

SAFETY FACTORS

High pressure hydraulic tools are designed to be safely operated up to the manufacturer's ratings. They are not designed with an unspecified safety factor that allows you to exceed the equipment rating.

In fact, it is safer to use high pressure tools at 80% of their maximum instead of 100%. The 80% rule is explained in greater detail under "Setup Considerations" on page 18.

REMEMBER:

The 80% Rule-It is safer to use high pressure tools at 80% of their maximum rating instead of 100%.

LIFTING FORCES

This section briefly explains some of the forces at work while you are lifting a load with a jack or cylinder. The main line of force is through the center of the plunger. The weight should be distributed as close to this center line as possible. The entire base of the jack or cylinder needs to be on a solid and level surface for a stable lift. Good and bad lifts are pictured below.

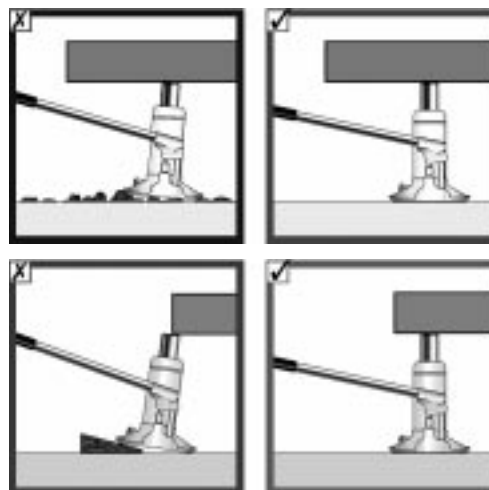

If the load is not centered or the entire face of the plunger saddle does not contact the load, side loading will occur. Side loading creates an unstable setup which may shift or fall. It also damages the jack or cylinder by distorting the wiper seal and bending the plunger. Side loading increases with distance. The further you extend the plunger, the more unstable it becomes.

COMPONENTS

Jacks

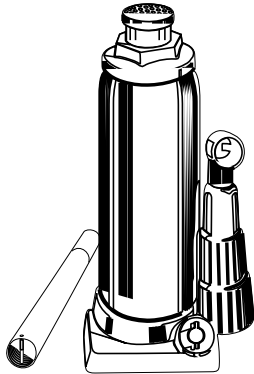

In this section you will find information about the basic components that make up a hydraulic system.

The jack is one of the oldest and most familiar pieces of hydraulic equipment. This familiarity contributes to misuse which can lead to personal injury.

The jack is a load lifting device and should never be used as a load holding device, especially when a person will be going underneath the supported load. Keep the following in mind when using a jack:

- The base of the jack should be fully supported and as level as possible. When working on soft surfaces, put a sturdy metal plate under the base of the jack for stability.
- The saddle on the end of the plunger should make full contact with the load. Try to move the load on the center line of force to prevent side loading.
- Do not try to lift a load more than the rated stroke. If you need to lift the load further, block the load, raise the level of the jack with a sturdy support, and continue the lift.

REMEMBER:

Do not go under a load supported by a jack. After the load has been raised, it should be blocked.

CYLINDERS

The cylinder (or ram) operates much the same as the jack, except that it is more versatile. Since the pump is separate, the cylinder can be used in several positions. By adding extensions and attachments to the cylinder, you can create a wide variety of hydraulic tools. The extensions and attachments are covered in the "Maintenance Set" section of this handbook.



The saddle in the plunger serves two important purposes. It protects the plunger threads from damage and it keeps the end of the plunger from becoming deformed. Keep the saddle in place at all times. Do not thread attachments into the plunger and rely on the plunger threads for support. The load must be transferred to the face of the plunger. The threads in the plunger may be stripped if loaded.

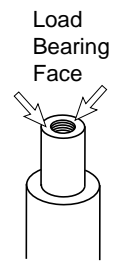

As with the jack, the cylinder is a load lifting device and should never be used as a load holding device, especially when a person will be going underneath the supported load. Keep the following in mind when using a cylinder:

- The base of the cylinder should be fully supported. Where applicable, use a cylinder base for added stability. Do not weld or otherwise modify the cylinder to attach a base or other support.
- The saddle on the end of the plunger should make full contact with the load. Try to move the load on the center line of force to prevent side loading. Be especially careful about side loading long-stroke cylinders.
- Do not try to lift a load more than the rated stroke. If you need to lift the load further, block the load, raise the level of the cylinder with a sturdy support, and continue the lift.

REMEMBER:

Do not go under a load supported by a cylinder. After the load has been raised, it should be blocked.

HAND PUMPS

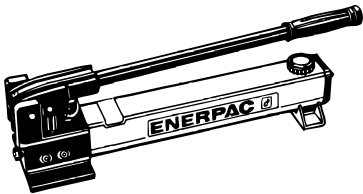

Hand pumps are a convenient, portable source of hydraulic power. They are designed to be stable during operation. For best performance, operate the pump handle at moderate speed. When the handle gets hard to push at high pressure, take short strokes. The maximum leverage is obtained in the last 5 degrees of stroke. Adding an extension dangerous.

Things to remember when using a hand pump:

- Close the release valve finger tight only. Using tools on the release valve can damage it and cause the pump to malfunction.
- In certain situations the pump handle can "kick back". Always keep your body to the side of the pump, away from the line of force of the handle.
- Many hand pumps can be operated in the horizontal or vertical position. However, when using it in the vertical position, the hose end must be down or you will pump air instead of oil. Check the pump Instruction sheet to determine the correct operating position for your pump.

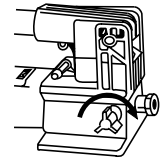

HOSES

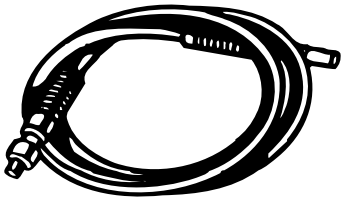

Rubber hoses are made in 4 layers: a rubber tube on the inside, 2 layers of wire braid, and a protective rubber layer on the outside. If the wire braid can be seen from the outside, it is time to replace the hose. Rubber hoses have a 2:1 safety factor. Thermoplastic hoses are frequently used with power-driven hydraulic pumps. Only 700 series thermoplastic hoses have a 4:1 safety factor.

Use the following information to avoid problems with hoses:

- Do not kink or tightly bend hoses. This will damage the wire braid. The minimum bend radius is approximately 12 cm [4,5 inches]. This means there should be no less than 24 cm [9 inches] between the straight sections of the hose as pictured.

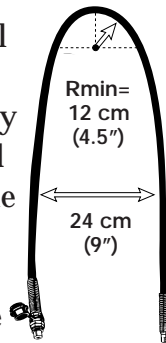

- The most sensitive part of the hose is at the fitting. To reduce damage, do not bend the hose at the fitting. Keep the strain relief (spring or boot) guard over the fitting as shown. It will help to support the hose.

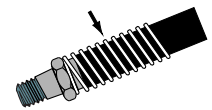

- Make the layout of the hoses such that there is no risk of damage, due to vehicles, trucks etc. Do not drop objects onto hose.
- Hoses are not designed to be used as a tow rope for your pump. Do not pull on the hose to move the pump.
- Never pressurize a hose which has a kink or sharp bend.
- Hydraulic pressure in a hose, cylinder or other component can increase due to heat. Never try to push balls or couplers to reduce the pressure. To avoid such problems, always store components in warm areas.

REMEMBER:

Always discard damaged hoses to eliminate the risk of someone else using the hose. The next user might not notice the damage until the hose is pressurized. A leak in a hose can cause high pressure oil to penetrate your skin. If you are ever injured by a spray of oil, see a doctor immediately.

COUPLERS

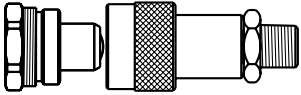

The advantage of using couplers rather than threaded connections is that you can quickly make and break hydraulic connections. The disadvantage of using couplers is that they are frequently the point at which dirt enters a hydraulic system.

Observe the following when using couplers:

- Make sure couplers are clean before making any connections. Use dust caps to keep couplers clean. If a dust cap was not used, clean the coupler by carefully blowing the dirt out with compressed air.
- Tighten couplers hand tight only; do not use wrenches. The threads must be fully engaged to allow for proper oil flow. A partially connected, checked-off, coupler is shown below along with a properly connected coupler.

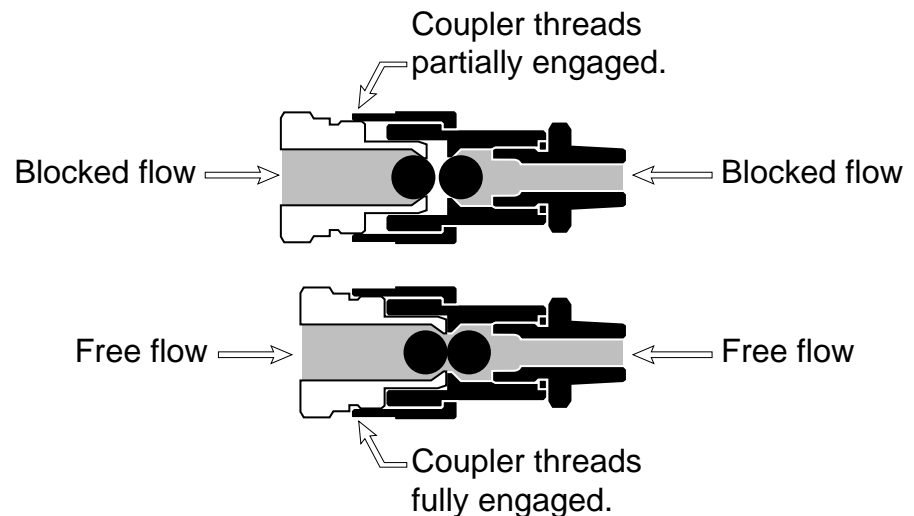

- Couplers are designed to be pressurized only when they are connected together. Never pressurize half couplers.

REMEMBER:

Since half couplers are not designed to hold pressure, you should never hold a load with an extended cylinder and then disconnect the hose.

OIL



All oils are not alike. The correct oil will protect moving parts and will not damage seals. Using the wrong oil will damage your equipment and lead to malfunctions. Use Enerpac premium hydraulic oil.

The most important oil characteristic is viscosity. Heat is also an important factor. See the chart below for details.

Characteristic	Enerpac Specifications	Effects
Viscosity	30-32 cSt at 40°C [42-45 SUS @210°F] 5.3-5.4 cSt at 100°C [150-165 SUS @100°F]	Viscosity describes the ability of an oil to flow. If the oil is too thin, there is not enough lubrication. If the oil is too thick, it will not flow fast enough to perform as required.
Operating Temperature	65°C [150°F] maximum	High temperatures also cause seal damage. In general, if the system is too hot to touch, it is too hot to use.

REMEMBER:

Always dispose of used oil properly. Observe local ordinances. Do not mix used hydraulic oil with other fluids.

GAUGES

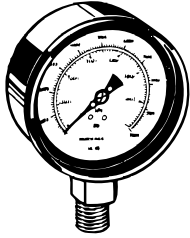

All hydraulic systems should have a gauge. The gauge is the window to the hydraulic system. In addition to indicating the operating pressure, the gauge can also warn you that something is going wrong.

In a lifting situation the gauge will read as follows:

- The gauge will not show much of a pressure rise until the cylinder contacts the load.
- The pressure will start to rise after the cylinder has contacted the load.
- The pressure continues to rise with each pump stroke.
- When the load starts to move, the pressure will remain constant. If you continue pumping and the load does not move, you may have reached the end of the cylinder stroke, or part of your setup may be yielding.

REMEMBER:

The gauge shows more than maximum pressure. It can also alert you to what is happening throughout an operation.

HYDRAULIC SYSTEMS

Basic Hydraulic System

The components described in the first section of this handbook are connected together to form a basic hydraulic system as shown below.

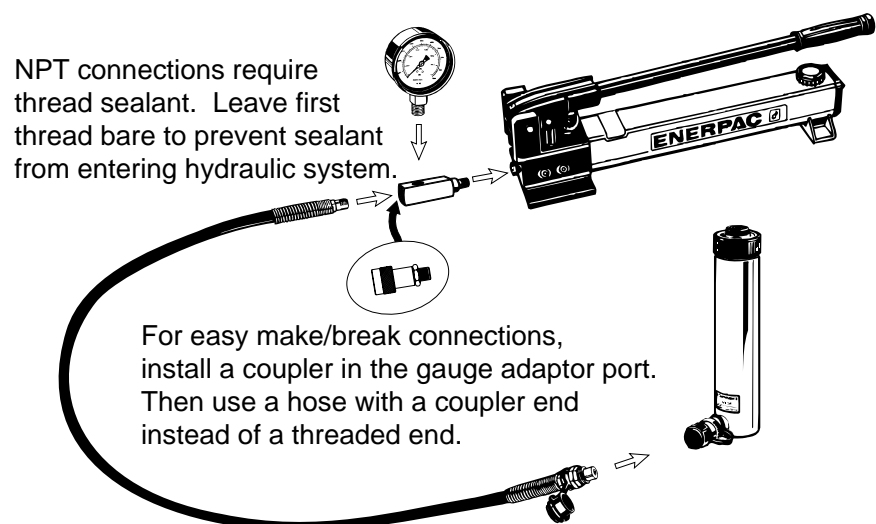

HYDRAULIC SYSTEMS (Continued)

Before using the hydraulic system:

- Check that all connections are tight and leak free. It is especially important to check all coupler connections because, after the system has been pressurized, you will not be able to tighten the couplers by hand and using tools will damage the couplers.
- Remove air from system.
- Check oil level in pump reservoir. Fill only to level indicated on the pump. Over-filling the reservoir may cause the pump to malfunction. Fill the reservoir only when all cylinders have been retracted. If you add oil when the cylinder is extended, the reservoir will overflow or be pressurized when you retract the cylinder.
- When using an electric, air, or gas powered hydraulic pump energize the pump only when the directional control valve is in the neutral position.
- In lifting systems, use lifting bases that spread out the load. This reduces the contact pressure between the cylinder and the floor and avoids sinking or punching of the floor. Most working floors cannot withstand high loads.
- Use shut-off valves for temporary load holding. Never hold a load on a coupler or directional control valve.
- Never get under a load.
- Use cribbing for load holding for long periods.
- Do not use hose to lift or pull equipment.

Removing Air from the Hydraulic System	
How to tell if there is air in the system.	Hydraulic system operation should be instant and smooth. For every pump stroke, the cylinder should rise evenly. If the cylinder movement is erratic or jerky, there may be air in the system.
How to remove air from the system	<p>Air will always go to the highest point in the system. This includes the inside of the cylinder plunger. That is why the cylinder must be turned upside down (single acting) or laid on its side (double-acting) to get the air out. To remove air from the system, position setup as illustrated below.</p> <p>(NOTE: double-acting cylinders must have the couplers facing up.)</p> <p>Fully advance and retract the cylinder 2 or 3 times. You can usually hear the air escaping through the reservoir.</p>

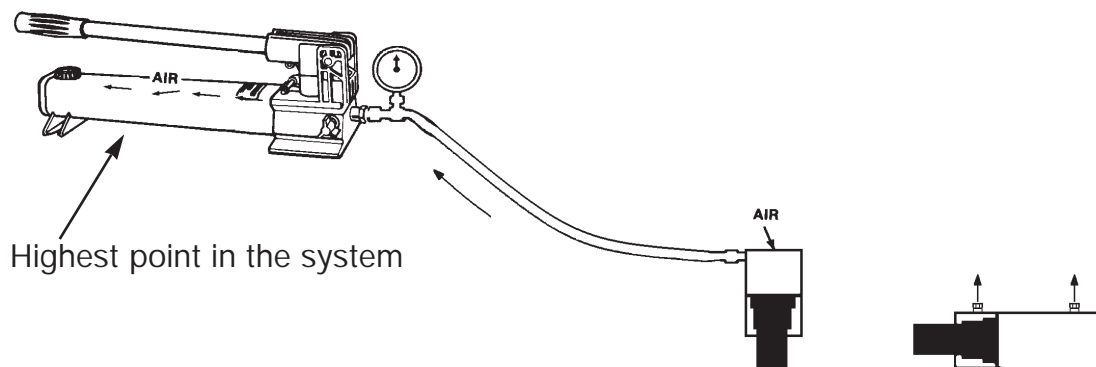

PRESSES

When using a press, have no loose pieces in the setup. If you need to use spacers to get to your workpiece, the spacers should be constructed in one solid piece. Spacers can be tack-welded together for increased stability.

When using horizontal presses, tie all pieces. Do not rely on friction to hold the pieces up; if one piece falls or breaks, the whole setup will fall. Elements of a safe press setup are shown below:

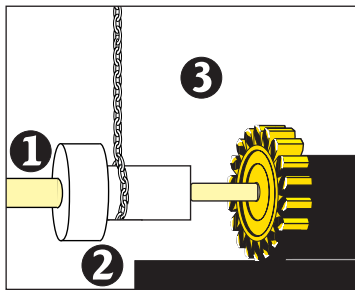

- 1 The ram and all parts of the setup are centered on the line of force.
- 2 Blocks have been tack welded together so that there are no loose pieces in the setup.
3. Block assembly is suspended by a chain and gear is supported from below.

Depending upon your individual application, guards and/or additional controls may be required. It is the responsibility of the user to provide these devices if required.

REMEMBER:

Keep your hands out of the working area and stand clear of the press when pressure is applied.

MAINTENANCE SET

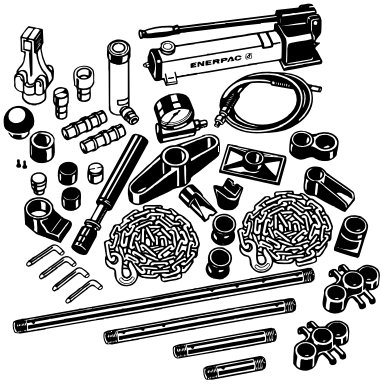

The Enerpac maintenance set includes a pump, hose, cylinder, gauge, and several extensions and attachments. The maintenance set is designed so that you can create setups for use in a variety of situations.

REMEMBER:

Never exceed 350 bar [5,000 psi] when using cylinder attachments. Always use a gauge to verify the operating pressure. Gauge response in a lifting situation is described under "Gauges" on page 15.

The first step in adding attachments to the cylinder is to mount the base attachment or adaptor saddle as shown below. Snug the bolts on the base attachment with a wrench.

When using threaded attachments, be sure all threads are fully engaged. Tighten by hand; no tools are required. When using lock-on attachments, always secure connection with a lock pin.

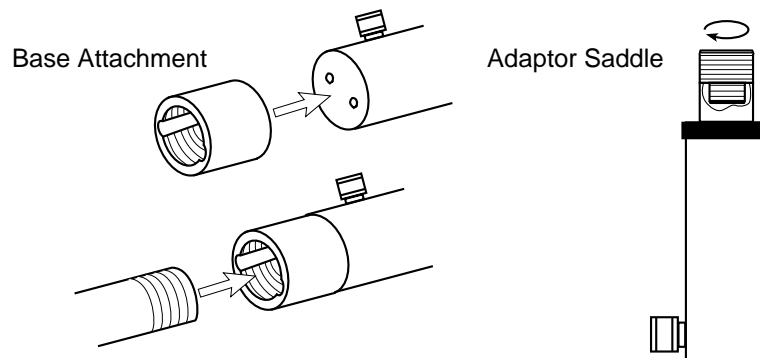

The maintenance set extensions and attachments are not made of standard pipe materials. They are designed to be much stronger. Standard grade parts will bend or break with much less load than the maintenance set components. See "Setup Considerations" on page 18 for guidelines on using your own cylinder extensions.

Two examples of maintenance set setups are shown below. Note that all pieces are securely fastened together.

CLAMPING SETUP

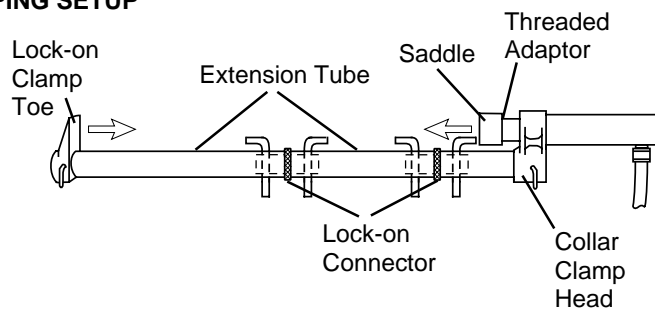

PUSHING SETUP

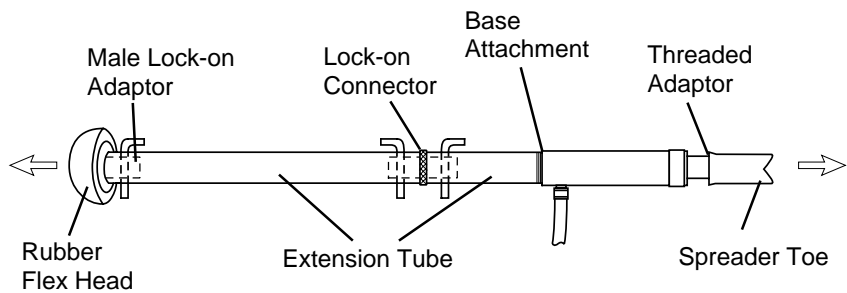

SETUP CONSIDERATIONS

The 80% Rule

When you make hydraulic setups, you should always examine the setup before using it. You want to look for ways to protect yourself and others, and ways to protect your equipment and other property.

Try to create the ideal setup. Since few things in life are ideal, following the 80% rule will result in more stable setups and prolong the life of your equipment. The 80% rule applies to cylinder stroke and cylinder capacity.

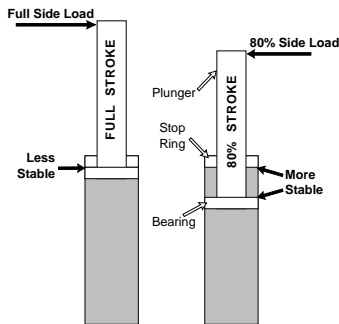

Cylinder Stroke – The illustration at left shows 2 benefits of applying the 80% rule to cylinder stroke. The first is that leaving distance between the stop ring and the bearing reduces side loading force resulting in a more stable cylinder. The second is that you avoid damaging the stop ring by running the plunger all the way up and hitting the stop ring with the bearing.

Cylinder Capacity – The reason for applying the 80% rule to cylinder capacity (tonnage) is that most loads are not lifted on their true center. This results in side loading of the cylinder. Allowing for a safety factor is the simplest way to compensate for the off-center characteristics of a one-point lift.

EXTENSIONS

In many situations, you will need to use extensions in your setup. The extension should be one rigid piece.

When selecting extension material, keep in mind that hollow shapes are stronger than solid pieces. Some suitable cross sections are shown below:

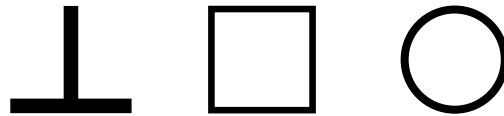

REMEMBER:

Never have any loose pieces in your setup. Loose pieces may shift and fly out when pressure is applied. Use one-piece extensions or tack weld the pieces together.

WORK AREA

Examine your work area before pressurizing the hydraulic system. Again, you will be looking for ways to protect yourself and others, and ways to protect your equipment and other property. Observe the following:

- Check hoses and couplers. Hoses should have straight runs and be free of tangles or kinks. Coupler connections must be fully tightened.
- Protect your equipment from the work you are doing. For example, try to locate the equipment away from weld spatter and paint over-spray. Use protective covers when necessary.
- Have adequate operator space and clear aisle ways. For instance, do not box yourself in between the setup and a wall.

EQUIPMENT STORAGE

Increase efficiency and protect your equipment by using good storage techniques.

Hydraulic equipment should be stored in a dry environment at temperatures above freezing. Store pumps and cylinders on a sturdy shelf and hoses in a rack. The hose rack shown below keeps hoses from becoming tangle and kinked. The rack can be made by cutting notches in a section of angle iron.

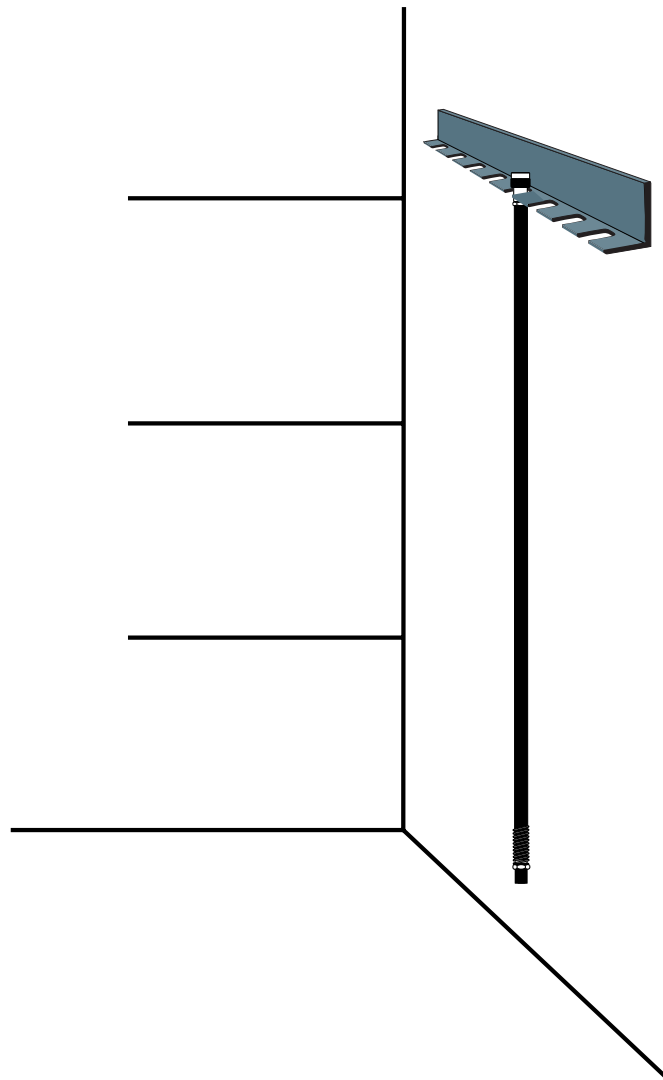

SUMMARY IN BRIEF

You should be familiar with all of the information presented in the Hydraulic Safety Seminar. However, the 3 practices shown below are essential to promoting personal safety and will help you to protect yourself and others.

You must be diligent when it comes to safety. We can provide high quality tools and accessories, but it is up to you to be aware of the situation that you put yourself and others into.

When you practice safety, you also benefit by being more efficient and by increasing the useful life of your tools.

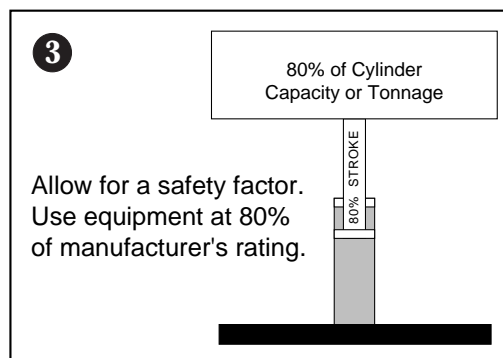
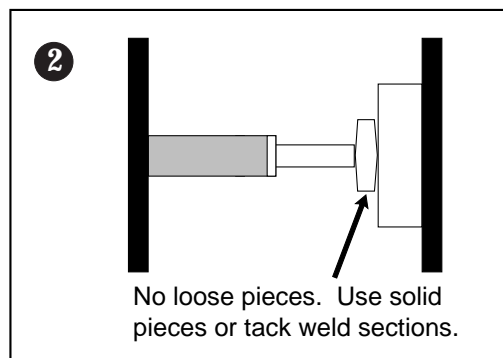
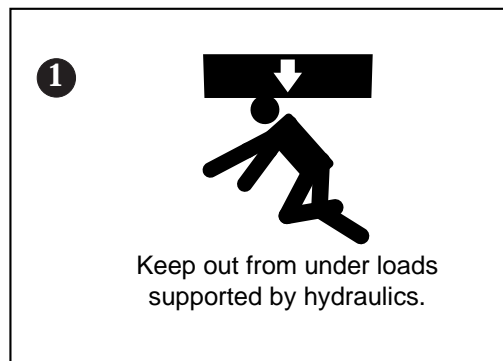

QUESTIONS

1. Which hydraulic components are rated in terms of capacity or tonnage?
2. True or False – Side loading can damage a jack or cylinder by distorting the wiper seal and bending the plunger.
3. What should you do if you have to lift a load further than the rated stroke of the jack or cylinder?
4. True or False – It is OK to work under a load that is held up by a jack or cylinder as long as the load doesn't exceed the capacity or tonnage rating.
5. True or False – You should never weld or otherwise modify a cylinder to attach a base or other support.
6. True or False – Adding an extension to a pump handle will give you more leverage when pumping.
7. True or False – You should tighten coupler connections with a wrench to be sure they are tight.
8. If cylinder movement is jerky, what may be wrong?
9. When you add extensions to a cylinder, how does it affect the maximum operating pressure?
10. True or False – The 80% rule applies to cylinder stroke and cylinder capacity.

ANSWERS

1. (see page 1) Jacks, cylinders, presses, spreaders, and other accessories have capacity or tonnage ratings.
NOTE: Pumps are rated for maximum operating pressure in bar [psi].
2. (see page 3) True – Side loading can damage a jack or cylinder by distorting the wiper seal and bending the plunger. Side loading also creates an unstable setup which may shift or fall.
3. (see pages 4 and 5) If you need to lift a load further than the rated stroke, block the load, raise the level of the cylinder with a sturdy support, and continue the lift. You could also switch to a jack or cylinder with a longer stroke.
4. (see pages 4 and 5) False – Never work under a load that is held up by a jack or cylinder. The load must be securely blocked before anyone goes under it.
5. (see page 5) True – You should never weld or otherwise modify a cylinder to attach a base or other support.
6. (see page 6) False – Adding an extension to a pump handle will not give you more leverage, but it will make the pump unstable.
7. (see page 8) False – You should tighten coupler connections hand tight only, but do be sure that all threads are fully engaged.
8. (see page 12) If cylinder movement is jerky, air may be trapped in the hydraulic system.
9. (see page 14) When you add extensions to a cylinder, the maximum operating pressure must be cut in half, to 350 bar [5,000 psi]. Always use a gauge to verify the operating pressure.
10. (see page 16) True – The 80% rule applies to cylinder stroke and cylinder capacity. Following the 80% rule will result in more stable setups and prolong the life of your equipment.