

URMDA

INSTALLATION INSTRUCTIONS

- LEAF SPRING:** With vehicle unloaded measure 5" from the Timbren frame bracket to axle pad.
- AIR SUSPENSION:** With vehicle unloaded & full air pressure measure 5" from the Timbren frame bracket to axle pad.
- When positioning frame bracket ensure that the Aeon spring rests over center of axle pad.
- Drill holes for frame bracket providing for at least four 1/2" Gr.8 bolts through the bracket & frame. (Bolt frame bracket to frame using existing holes where possible)
- Assemble Aeon spring to bracket as shown in adjacent diagram.

NOTES:

The frame bracket can be inverted as long as there is adequate clearance between the gussets and the leaf spring. Holes in frame bracket must be within the gusset area.

SAFETY CAUTIONS

Ensure sufficient clearance between frame bracket & tire.

Do not exceed vehicle manufacturer's recommended axle weight rating. Check for AEON® interference with vehicle components - Under load AEON® will "expand" in diameter.

Ref. = Reference
Part = Part #.
Qty. = Quantity

Ref	Part	Qty
1	F11102-150	4
2	F40052-020	4
3	K10055-003	2
4	A00200-65V00	2

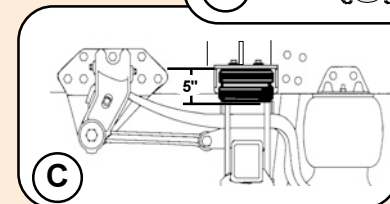
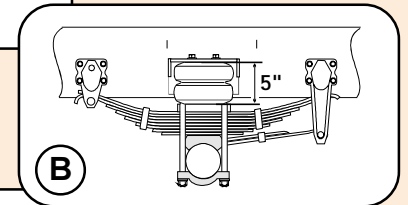
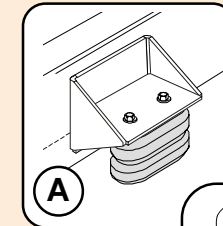
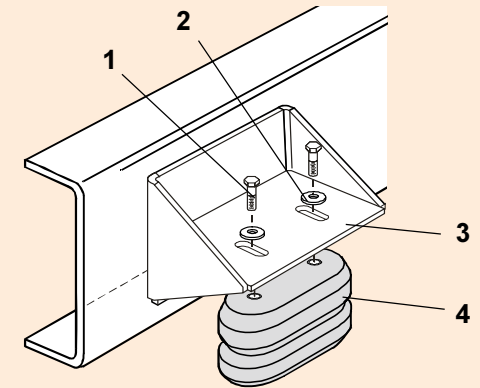



Ride Quality Control

TIMBREN SES

Suspension Enhancement Systems

Typical Light Duty & Medium Duty Installation

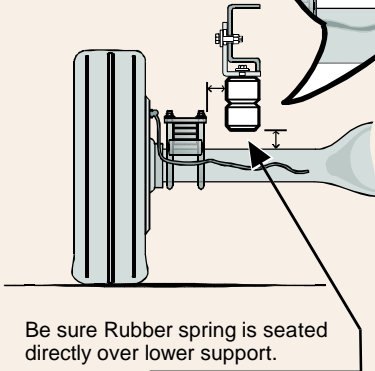
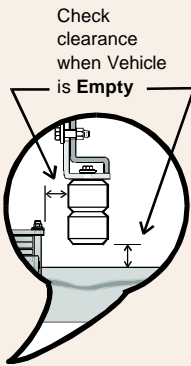

Be sure Rubber spring is seated directly over lower support.

Typical Heavy Duty Installation

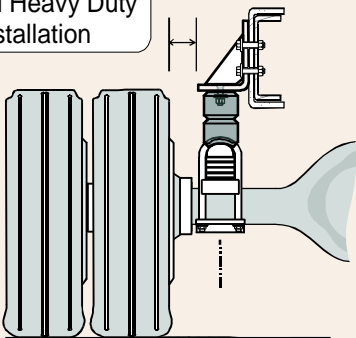

Clearance Instructions

For Light Duty Pickups & Vans

Rear SES kits should have approximately 1" gap between rubber spring and axle for 1/2 and 3/4 tons, and for one ton the gap should be about 1/2" when the vehicle is completely unloaded. A cap or fifth wheel plate will reduce or eliminate this gap.

Front SES kits are usually in contact with the front suspension at all times.

For Medium Duty & Heavy Duty Trucks, Trailers, Motor Homes, and more

Medium & Heavy Duty vehicles often have pre-load as outlined in the instruction sheet. (For specific Medium Duty applications with a constant load on the suspension like Rvs, Utility Vans or Cube Vans, the Timbren SES kits are pre-loaded.)

Check clearances when vehicle is empty...

Consider Your Needs..!

Knowing the use of the vehicle will help you to select the right SES kit. For example a one ton truck can be configured as a pick-up, service vehicle or tow truck. Standard capacity or severe service applications are available for many applications.

Knowing that the suspension has been modified or is old and sagging should indicate the need to adjust the ride height to obtain the correct clearance.

This can be done by altering the SES kit (changing rubber spring or bracket) or re-arching the leaf springs to renew the optimum OEM ride height.

Limited Lifetime Warranty

TIMBREN SES kits are warranted against defects in material and workmanship, under normal use and service, for the life of the vehicle on which the kit was originally installed. The warranty is not transferable and proof of purchase is required. The warranty is limited to the replacement of the failed part. TIMBREN will not be responsible for any labour or freight charges involved in the replacement of any product. TIMBREN shall be entitled to make its own inspection to determine the validity of the warranty claim. TIMBREN shall not be liable nor warrant the product in the event of alteration, misuse, overload, negligence or damage caused by others.