

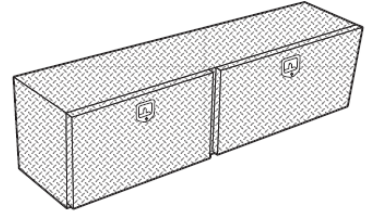

Tool Box

Topsider & Underbody



Part No. 170481, 170601, 170721, 170901, 170961,
190241, 190361, 190481, 190601

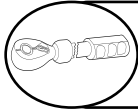

REMOVE CONTENTS FROM BOX. VERIFY ALL PARTS ARE PRESENT.

READ INSTRUCTIONS CAREFULLY BEFORE STARTING INSTALLATION.

DO NOT OVER TORQUE. STANDARD OPERATING LOAD FOR TIGHTEN BODY MOUNT NUTS & BOLTS VARIES FROM 45 TO 65 FOOT POUND.



30-60 min



Cutting Not Required



Drilling Required

WARNINGS

Before drilling into your truck bed, check under your vehicle to ensure the drill location does not puncture, cut or obstruct any brake or fuel fluid lines, electrical wires, fuel tanks, etc. Mounting bolts should be installed from the underside to help prevent any damage underneath your vehicle.

PARTS INCLUDED

A

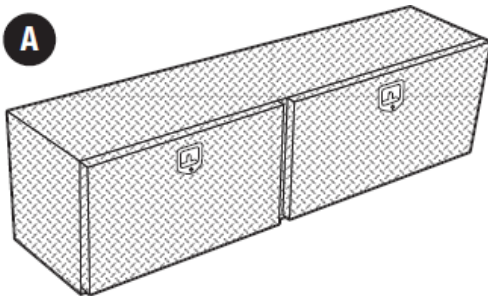

B

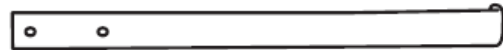

C

PARTS INCLUDED

part	description	qty.
A	aluminum topsider toolbox	1
B	key	2
C	legs	2

TOOLS REQUIRED

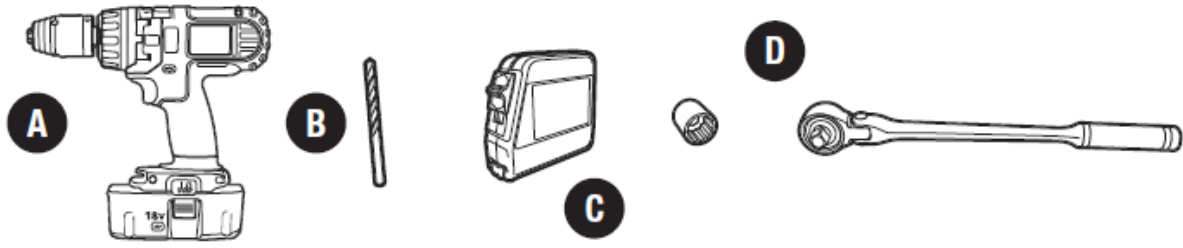

PARTS LIST:

Part	description	Qty.
A	drill	1
B	5/16" drill bit	1
C	tape measure	1
D	socket wrench	1

INSTALLATION PROCEDURE:

PLACE BOX ON THE BED RAIL OF THE TRUCK BED SITUATED ON LEVEL GROUND

1

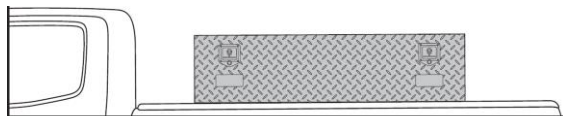

Put box on bed rail with handle and logo badge out.

2

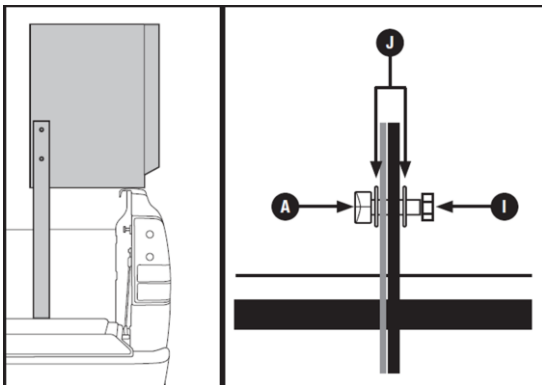

Place leg (C) on end of box (A) in from the rear corner. The closer to the corner the leg is mounted the stronger the box will be. Ensure box is level and use a square to ensure leg (C) is vertical.

Ensure legs are at appropriate height so that the legs rest on the truck bed.

Repeat on other end.

For added security the legs (C) may be bolted to the truck bed.

UNDERBODY INSTALLATION

PARTS INCLUDED

A

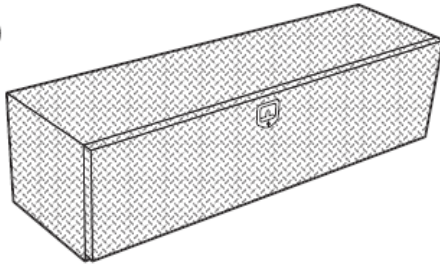

B

PARTS INCLUDED

part	description	qty.
A	aluminum underbody toolbox	1
B	key	2

INSTALLATION

NOTE:

Box may be used on numerous truck types and chassis styles. Therefore we recommend contacting your local truck up-fitter/ equipment dealer for installation and or mounting brackets.

Mounting brackets should always be equal to or thicker than 1/4" steel.

Underside of box must be supported.

PRODUCT CARE

- Periodically check the product to ensure all fasteners are tight and components are intact.
- Regular waxing is recommended to protect the finish of the product.
- **Use ONLY Non-Abrasive automotive wax.** Use of any soap, polish or wax that contains an abrasive is detrimental and can scratch the finish leading to corrosion.
- Aluminum polish may be used to polish small scratches and scuffs for **Stainless Steel finish.**
- Mild soap may be used to clean the product for both **Stainless Steel and Black finish.**

FAQ's

1. Hardware's are not of correct size.

In GMC / Chevrolet truck model 2006 & up, customer needs to reuse the factory body bolts to install the bracket. If your vehicle is not GMC / Chevrolet 2006 & up, please ensure that holes are not partially covered with any plastic grommet or rust? If it is, please remove the plastic grommet & rust from the thread holes & re-try the installation.

2. Mounting Bracket are not getting Installed properly.

In some cases Illustration images shown in Installation manual may not be the exactly same as per actual vehicle images ,also if Driver / Passenger side mounting brackets are very identical in the design, suggest referring Parts Identification guide to avoid fitment issue.

3. Products are thumping / rattling after installation.

Please ensure that all required mounting brackets / hardware's are installed & tighten correctly. Suggest using white lithium / regular grease between the metal to metal contact surfaces.

4. Side Bar is not aligning with vehicle / Step Pads are not aligning with vehicle doors.

Side bar may be interchanged or mounting brackets are not installed at the correct position in the vehicle. Please refer Parts identification guide.

5. Missing / Excess Hardware.

Recheck hardware count as per the part list.

6. Product not installing properly.

Ensure make model year, cab length and bed size of your vehicle is listed in the application. All installation steps are followed correctly.