



# 5" Oval Bend End Bar

Part No. A7082S /B



Dodge Ram 1500 Crew Cab

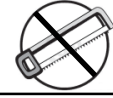

60-180 min

Cutting Not Required

Drilling Not Required



REMOVE CONTENTS FROM BOX. VERIFY ALL PARTS ARE PRESENT.



READ INSTRUCTIONS CAREFULLY BEFORE STARTING INSTALLATION.

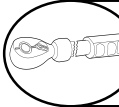

DO NOT OVER TORQUE. STANDARD OPERATING LOAD FOR TIGHTEN BODY MOUNT NUTS & BOLTS VARIES FROM 45 TO 65 FOOT POUND.

### PARTS LIST:

Qty	Part Description	Qty	Part Description
1	Driver/left side 5" Oval Straight Sidebar	12	8-1.25mm x 25mm Combo Hex Bolts
1	Passenger/right side 5" Oval Straight Sidebar	18	8mm x 24mm x 2mm Flat Washers
6	Mounting Brackets	18	8-1.25mm Nylon Lock Nuts

(6) Left or Right Mounting Brackets

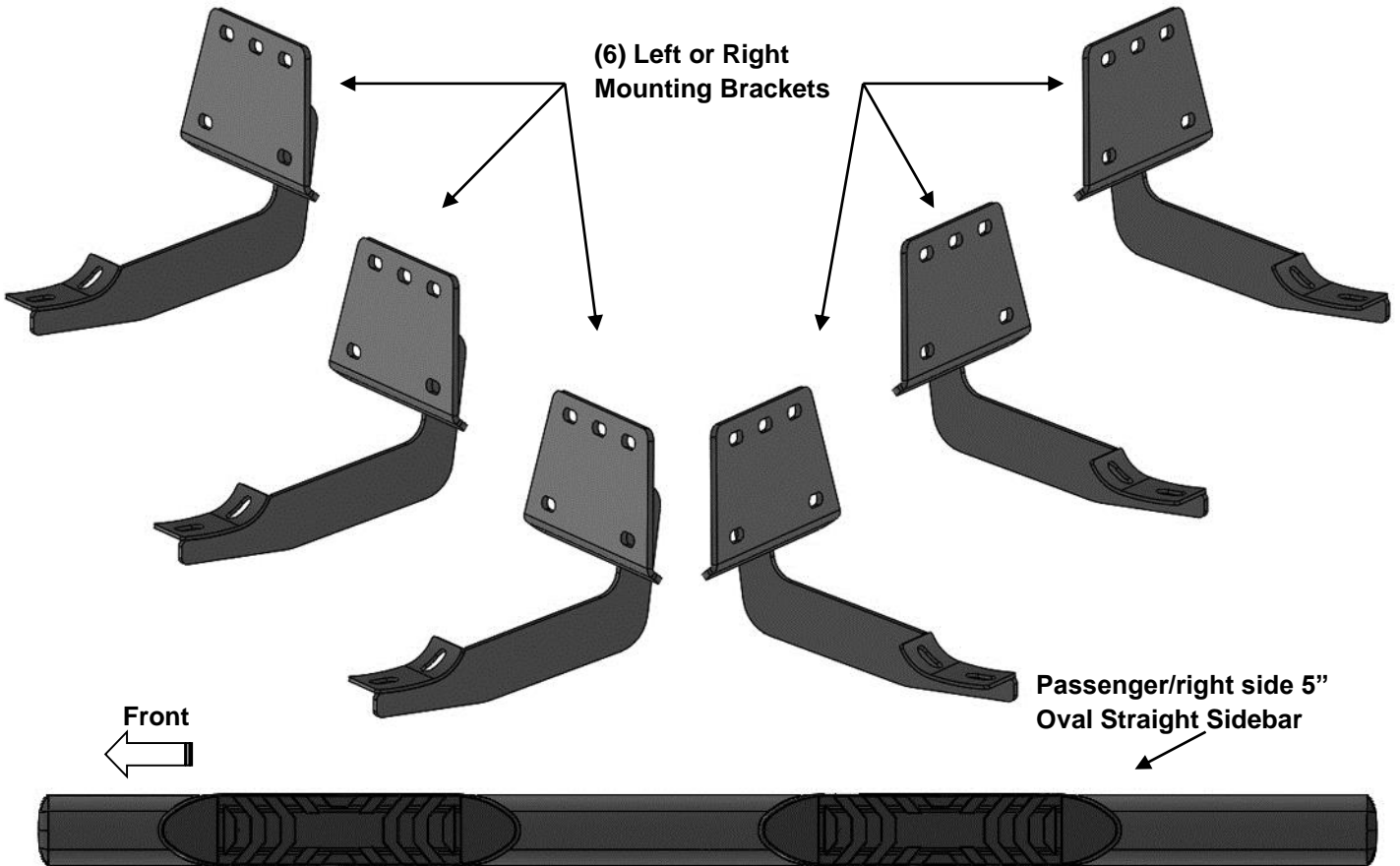

## INSTALLATION PROCEDURE:

1. Start the installation under the passenger side of the vehicle. Locate the front (3) factory studs along the inner side of the body panel, **(Figure 1)**.
2. Select (1) Mounting Bracket. **NOTE:** All (6) Brackets are universal and will fit left or right side. Attach the Mounting Bracket to the (3) factory studs with (3) 8mm Flat Washers and (3) 8mm Nylon Lock Nuts, **(Figures 2 & 3)**. Leave brackets loose at this time.
3. Repeat **Steps 1 & 2** to install the Universal Brackets in the center and rear mounting locations along the body panel, **(Figure 4—7)**.
4. Carefully unwrap and select the Passenger/right Sidebar. Use the illustration above to help identify the correct Sidebar. Place the Sidebar on top of the Brackets. **IMPORTANT:** Do not slide, (front to back or rotate), the Sidebar on the Brackets or damage to the finish on the Sidebar may result.
5. Attach the Sidebar to the Brackets with (6) 8mm Combo Hex Bolts, **(Figures 8 & 9)**. Do not tighten hardware at this time.
6. Level and adjust the Sidebar as necessary and fully tighten all hardware.
7. Repeat **Steps 1—6** for Driver/left Sidebar installation.
8. Do periodic inspections to the installation to make sure that all hardware is secure and tight.

### Passenger/right Side Installation Pictured

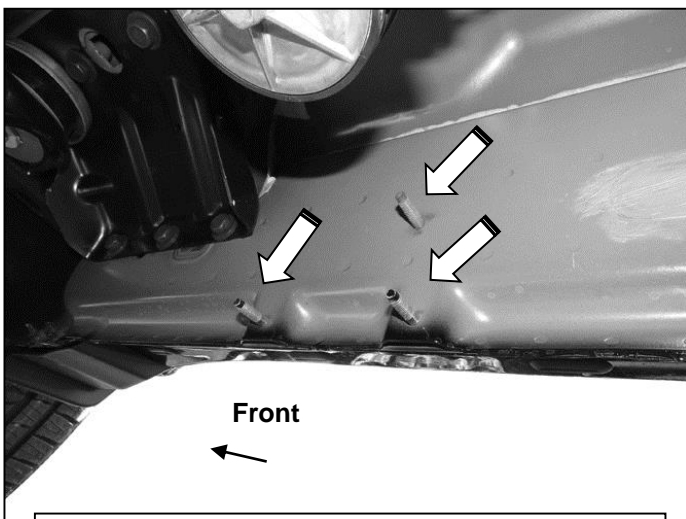

**(Fig 1) Passenger side front mounting location**

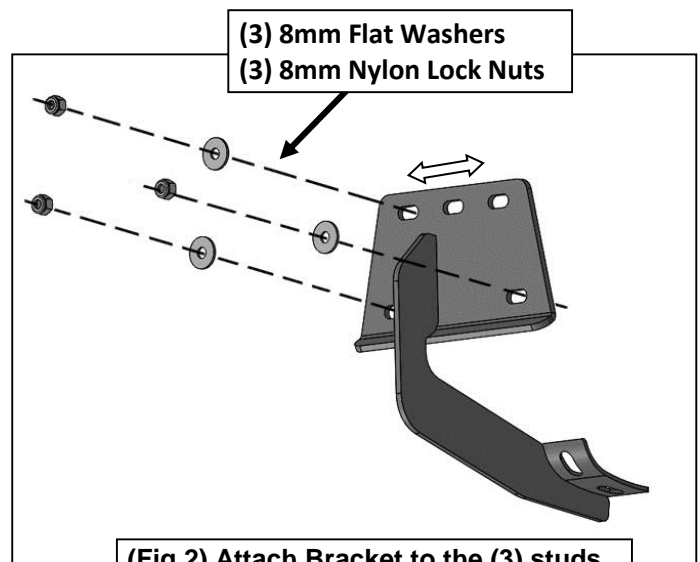

**(Fig 2) Attach Bracket to the (3) studs**

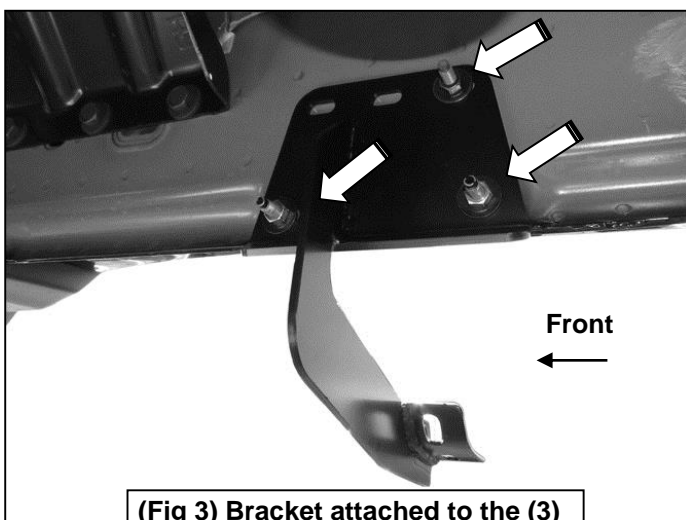

**(Fig 3) Bracket attached to the (3) front studs on the passenger side**

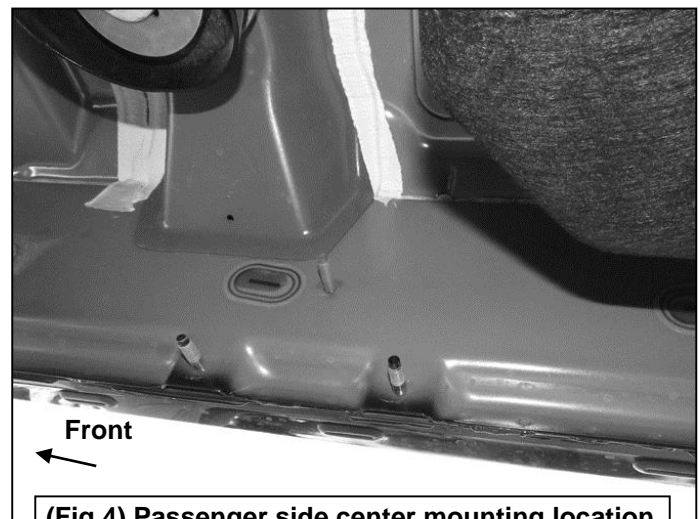

**(Fig 4) Passenger side center mounting location**

### Passenger/right Side Installation Pictured

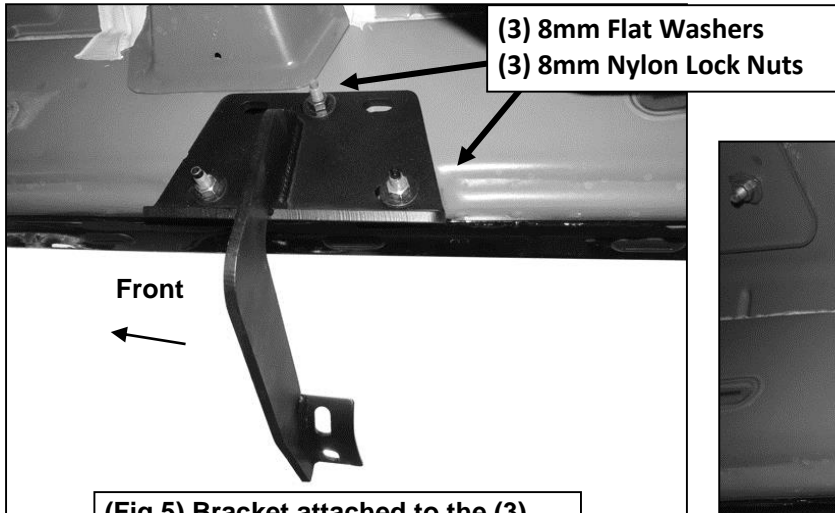

(Fig 5) Bracket attached to the (3) center studs on the passenger side

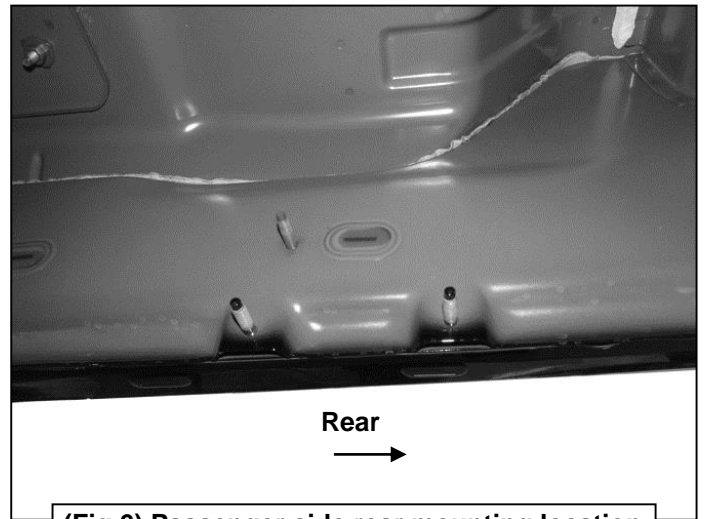

(Fig 6) Passenger side rear mounting location

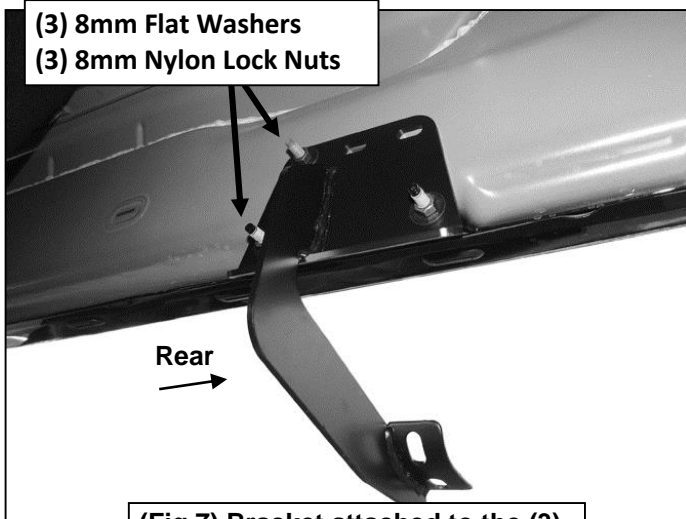

(Fig 7) Bracket attached to the (3) rear studs on the passenger side

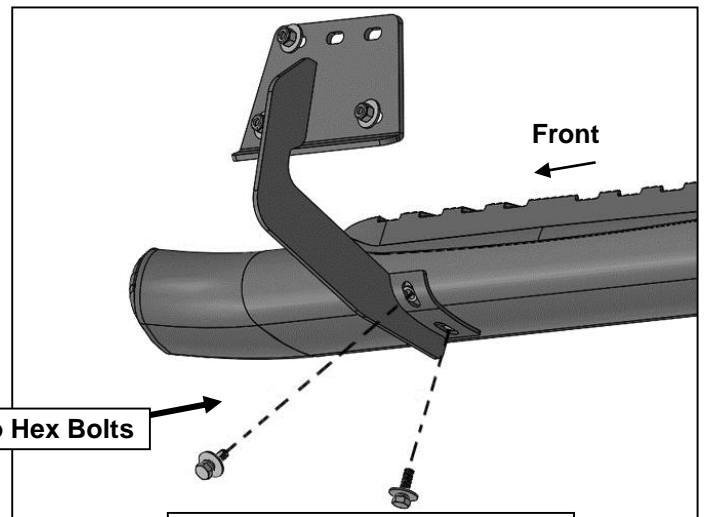

(Fig 8) Passenger front side Bracket attached to Sidebar

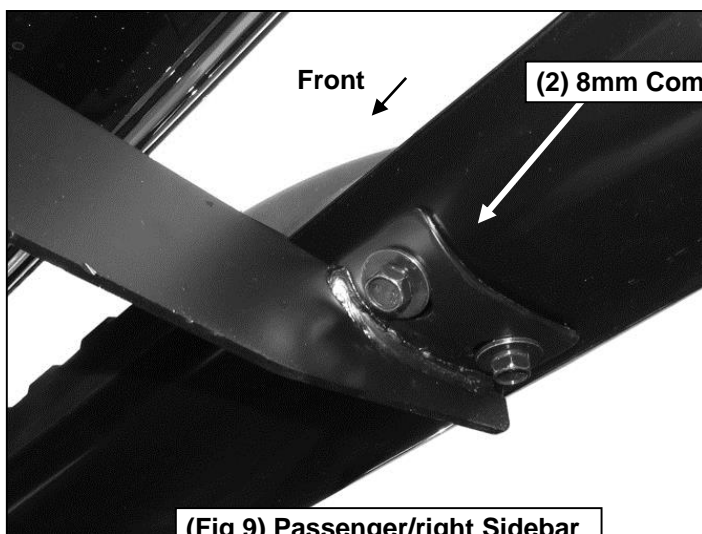

(Fig 9) Passenger/right Sidebar attached to Bracket pictured

No.	Parts Identification
1	Passenger / Right 'Rear' Bracket marked "PR"
2	Driver / Left 'Rear' Bracket marked "DR"
3	Passenger / Right 'Center' Bracket marked "PC"
4	Driver / Left 'Center' Bracket marked "DC"
5	Passenger / Right 'Front' Bracket marked "PF"
6	Driver / Left 'Front' Bracket marked "DF"

**Note:**

- This guide is to identify the parts and not a reference for part count.
- For part count, refer Parts List.
- Product / Bracket image is representative and actual design may vary.

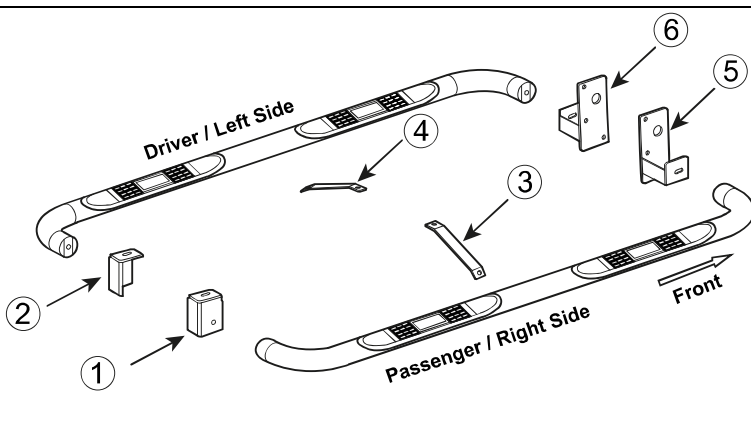

### PRODUCT CARE

- Periodically check the product to ensure all fasteners are tight and components are intact.
- Regular waxing is recommended to protect the finish of the product.
- **Use ONLY Non-Abrasive automotive wax.** Use of any soap, polish or wax that contains an abrasive is detrimental and can scratch the finish leading to corrosion.
- Aluminum polish may be used to polish small scratches and scuffs for **Stainless Steel finish.**
- Mild soap may be used to clean the product for both **Stainless Steel and Black finish.**

### FAQ's

- 1. Hardware's are not of correct size.**  
*In GMC / Chevrolet truck model 2006 & up, customer needs to reuse the factory body bolts to install the bracket. If your vehicle is not GMC / Chevrolet 2006 & up, ensure that holes are not partially covered with any plastic grommet or rust? If it is, remove the plastic grommet & rust from the thread holes & re-try the installation.*
- 2. Mounting Bracket are not getting Installed properly.**  
*In some cases Illustration images shown in Installation manual may not be the exactly same as per actual vehicle images ,also if Driver / Passenger side mounting brackets are very identical in the design, suggest referring Parts Identification guide to avoid fitment issue.*
- 3. Products are thumping / rattling after installation.**  
*Ensure that all required mounting brackets / hardware's are installed & tighten correctly. Suggest using white lithium / regular grease between the metal to metal contact surfaces.*
- 4. Side Bar is not aligning with vehicle / Step Pads are not aligning with vehicle doors.**  
*Side bar may be interchanged or mounting brackets are not installed at the correct position in the vehicle. Refer Parts identification guide.*
- 5. Missing / Excess Hardware.**  
*Recheck hardware count as per the part list.*
- 6. Product not installing properly.**  
*Ensure make model year, cab length and bed size of your vehicle is listed in the application. All installation steps are followed correctly.*

### Check out these other TrailFX Products!!



Keystone Automotive Operations Inc. (KAO) warrants this product to be free of defects in material and workmanship at the time of purchase by the original retail consumer. KAO disclaims any other warranties, express or implied, including the warranty of fitness for a particular purpose or an intended use. If the product is found to be defective, KAO may replace or repair the product at our option, when the product is returned prepaid, with proof of purchase. Alteration to, improper installation, or misuse of this product voids the warranty. KAO's liability is limited to repair or replacement of products found to be defective, and specifically excludes liability for any incidental or consequential loss or damage.