

2016-20 Toyota Tacoma
Elite Modular Front Runner
VGFRG-2124-2125BK
Installation Instruction

Thank you very much for choosing our products.

Please read the installation instruction carefully before using our product and be sure to fully understand the contents mentioned above for subsequent installation.

In addition, please keep properly the installation instruction for product maintenance in future.

Attention

- The following symbols are used in this installation instruction.











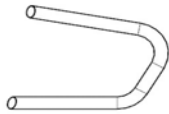
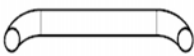



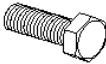

**Caution**

**Relevant matters must be obeyed for safety.
Non-compliance may result in injury or other accidents.
Please read carefully and obey strictly.**

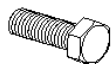
**Note**

**Relevant matters must be obeyed for the smooth installation
and use.**

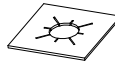
- Non-compliance may cause the problems with vehicle. Please do not install that is not recorded in this instruction.
- Please forgive that we are not responsible for any consequences arising from the installation not according to our installation instruction.

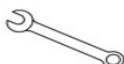
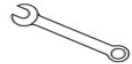
Product Composition *Please confirm if it is missing.					
A、Side bend (2 pieces, R、L) 	B、Top bend (1 pieces) 	C、Middle tube (1 piece) 	D、Sand baffle plate (1 piece) 	E、Sub plate (2 pieces, R、L) 	F、Mount Bracket (2 pieces, R、L) 
G、Top Support Bracket (2 pieces, R、L) 	H、M10*35 (55*18*T=5) -8.8 "T" Bolt (2 pieces) 	I、M10*35-8.8 Bolt (14 pieces) 	J、M10 (Φ10.5*Φ25*T2.0) Flat Washer (24 pieces) 	K、M10 Lock Washer (24 pieces) 	L、M10 -8.0 Nut (10 pieces) 
M、M8*20 -8.8 Bolt (4 pieces) 	N、M8 (Φ8.4*Φ22*T1.5) Flat Washer (4 pieces) 	O、M8 Lock Washer (4 pieces) 	P、M10 (Φ48*Φ12*5.0) Flat Washer (4 pieces) 	Q、M10*120 -8.8 Bolt (L=50) (2 pieces) 	R、M10 plastic retainers (2 pieces) 
Installation tools *Please prepare these tools before installation.					
Allen wrench #6 	wrench 13/14 	wrench 16/17 			
Attentions					
<ul style="list-style-type: none"> - The labels of fitting procedure inside the thick wire frame is particularly important. Pay attention to them in the actual installation. - Pay attention to safety during installation. 					
Fitting Procedure (The installation process is shown below, Fig-8)					

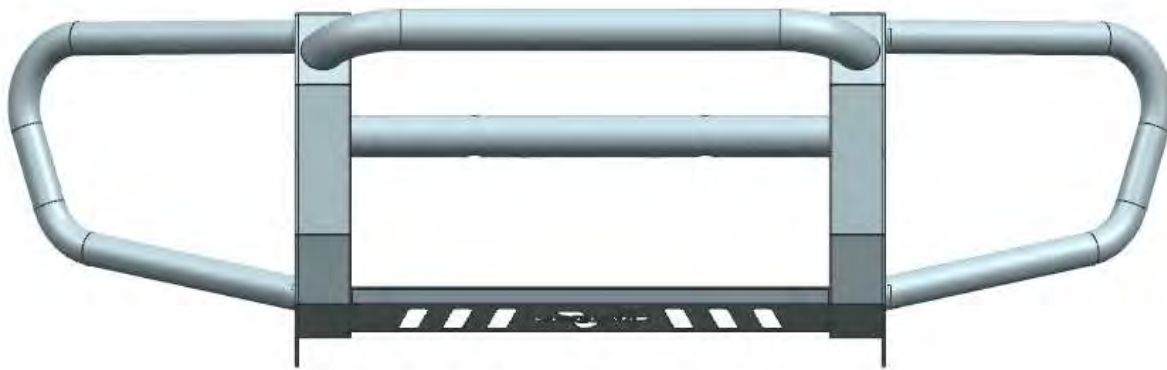

Fig1 : Parts assembly

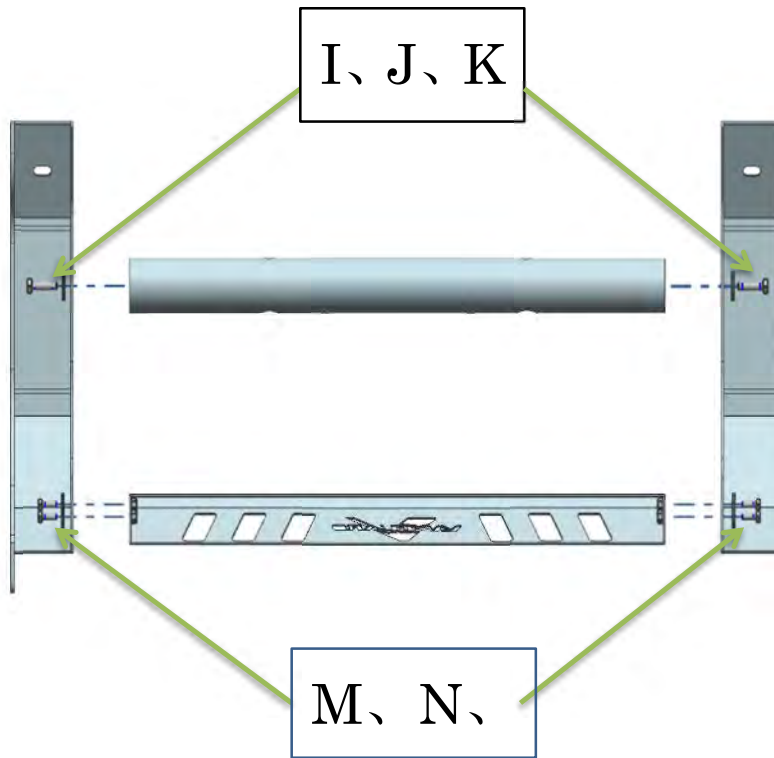

Fig2: Parts assembly

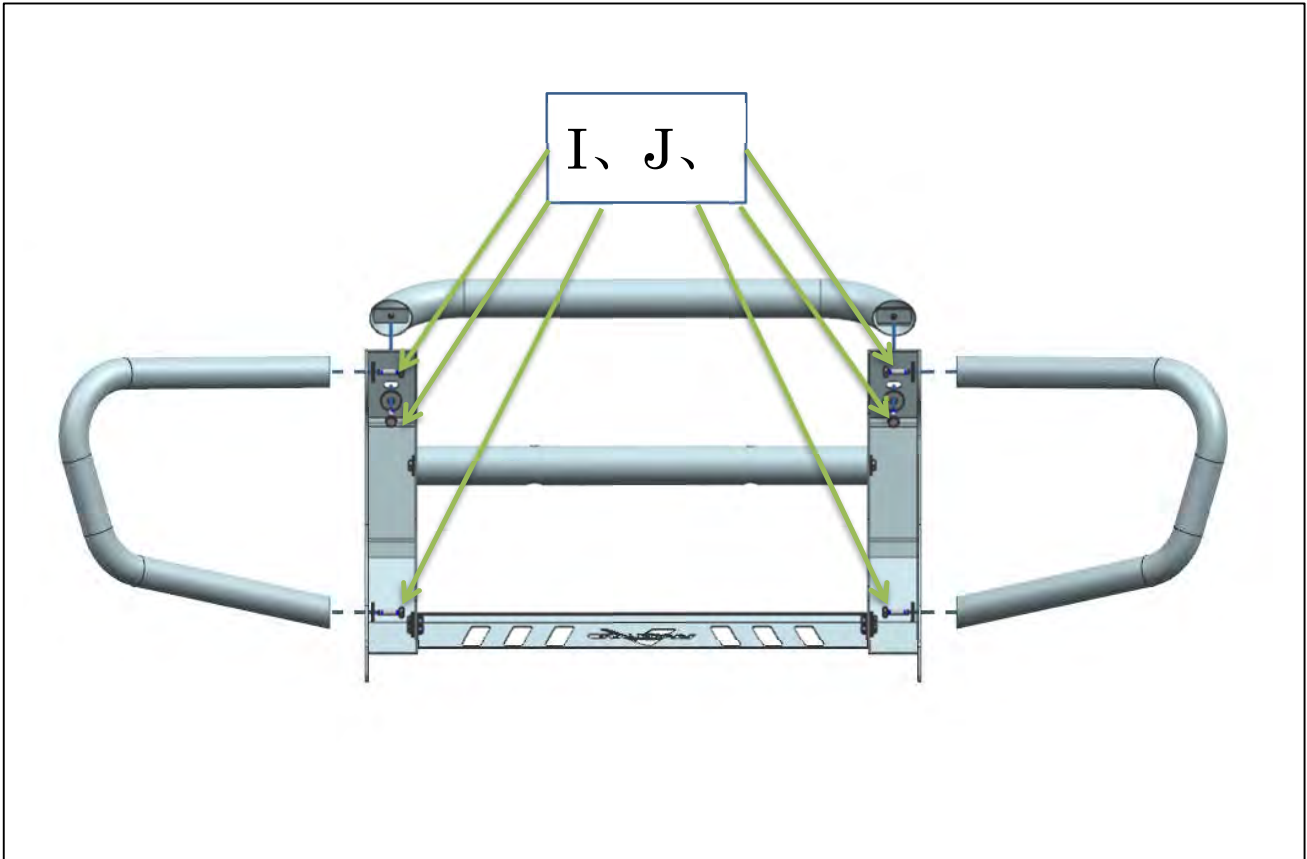

Fig3: Open hood and remove plastic cover to locate cross-support in front of radiator (arrows)

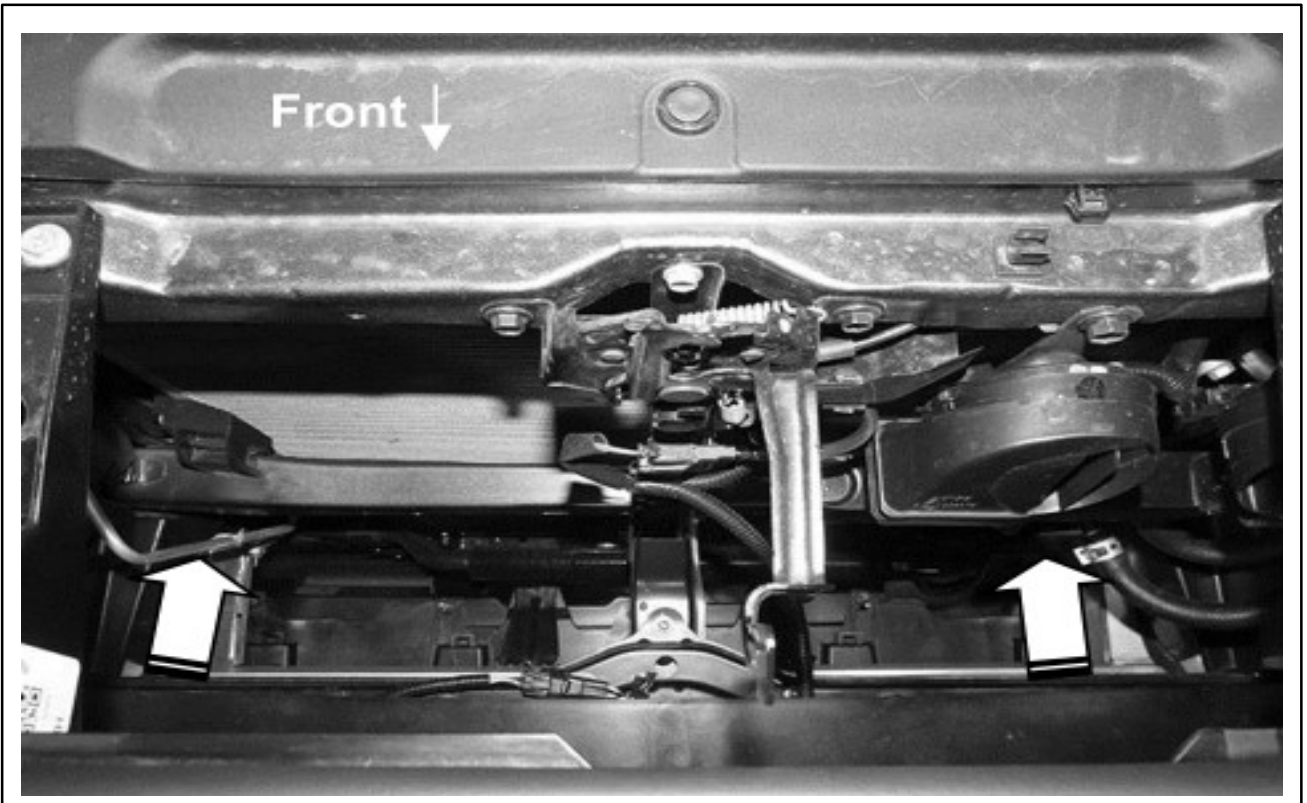

Fig4: Plastic bumper removed for instruction purposes only-do not remove bumper, Locate the outer holes in the bottom of the radiator cross support (arrow) viewed from below.



Fig5: Insert Bolt plate (arrow) into back of radiator cross support and down through hole in bottom (passenger side pictured through bumper)

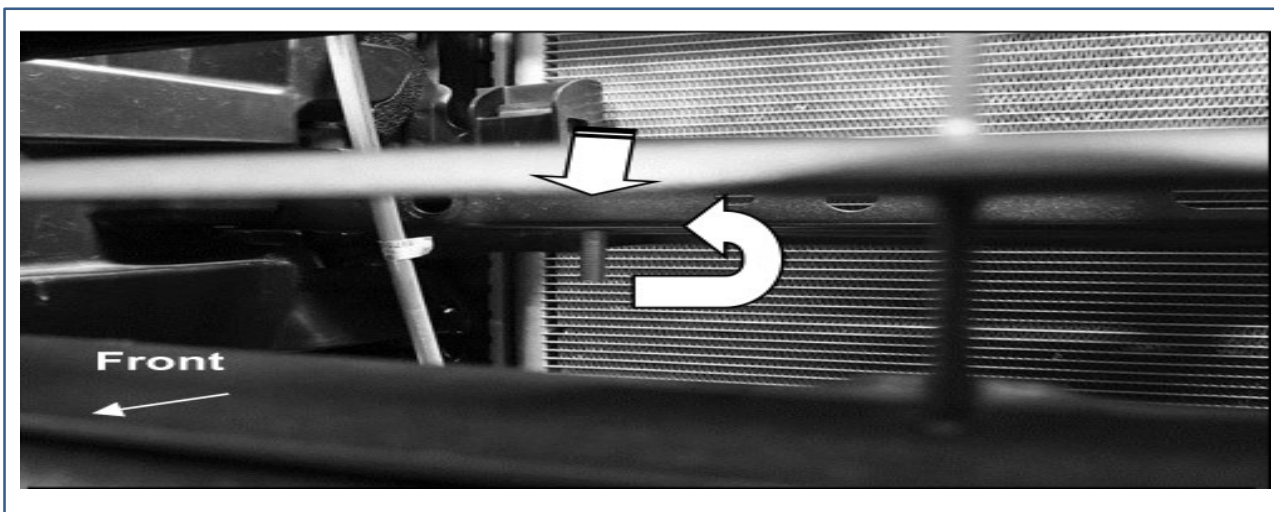

Fig6: Driver side Bolt Plate installed

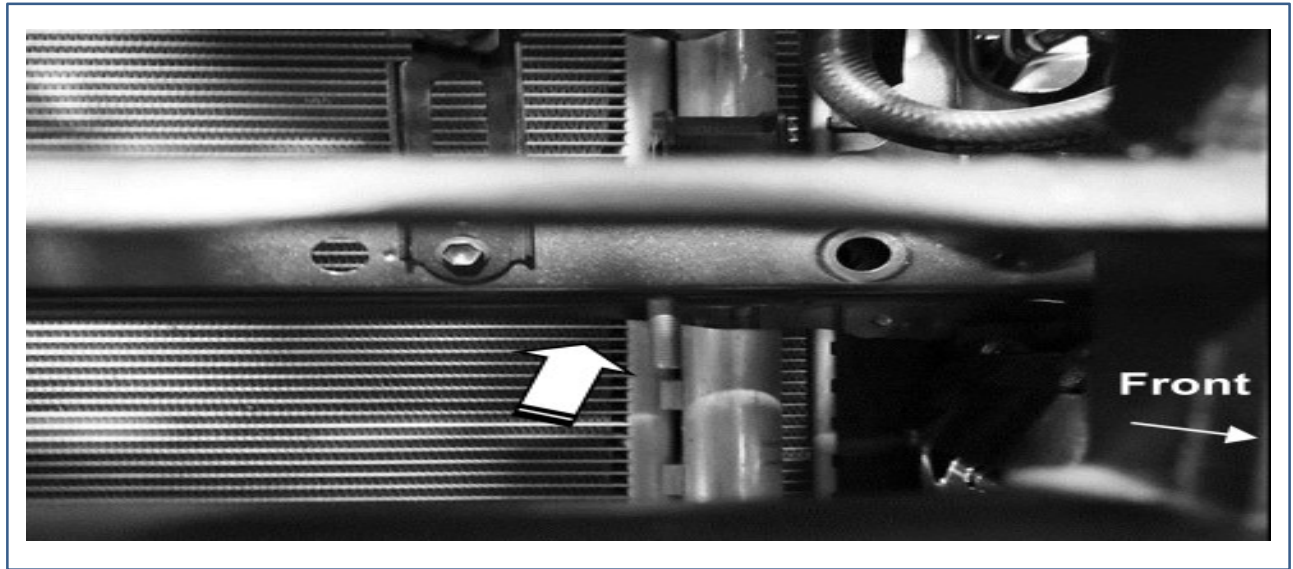

Fig6: Passenger side Top Support Bracket

Fig7: Passenger side Top Support Bracket installed-pictured from below bumper

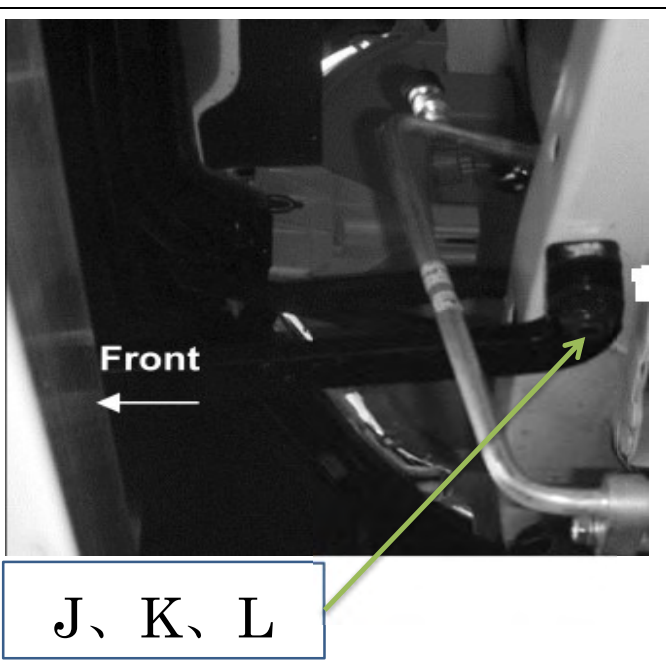
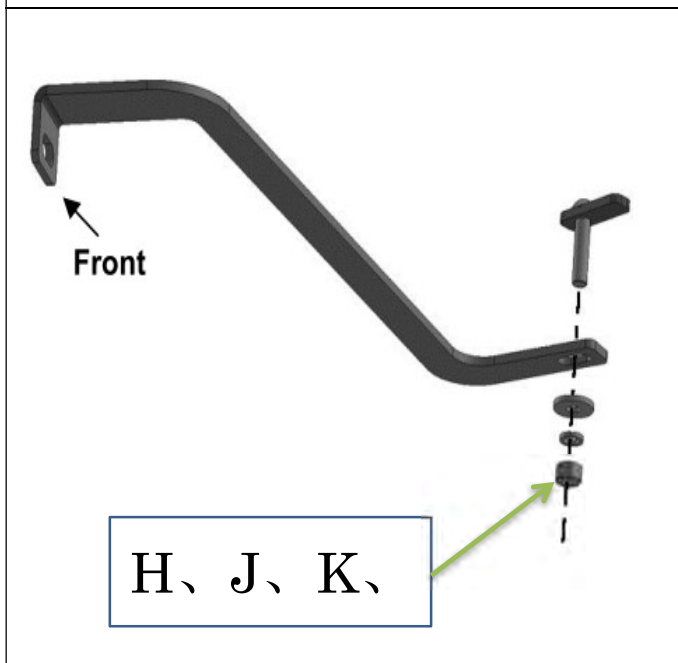
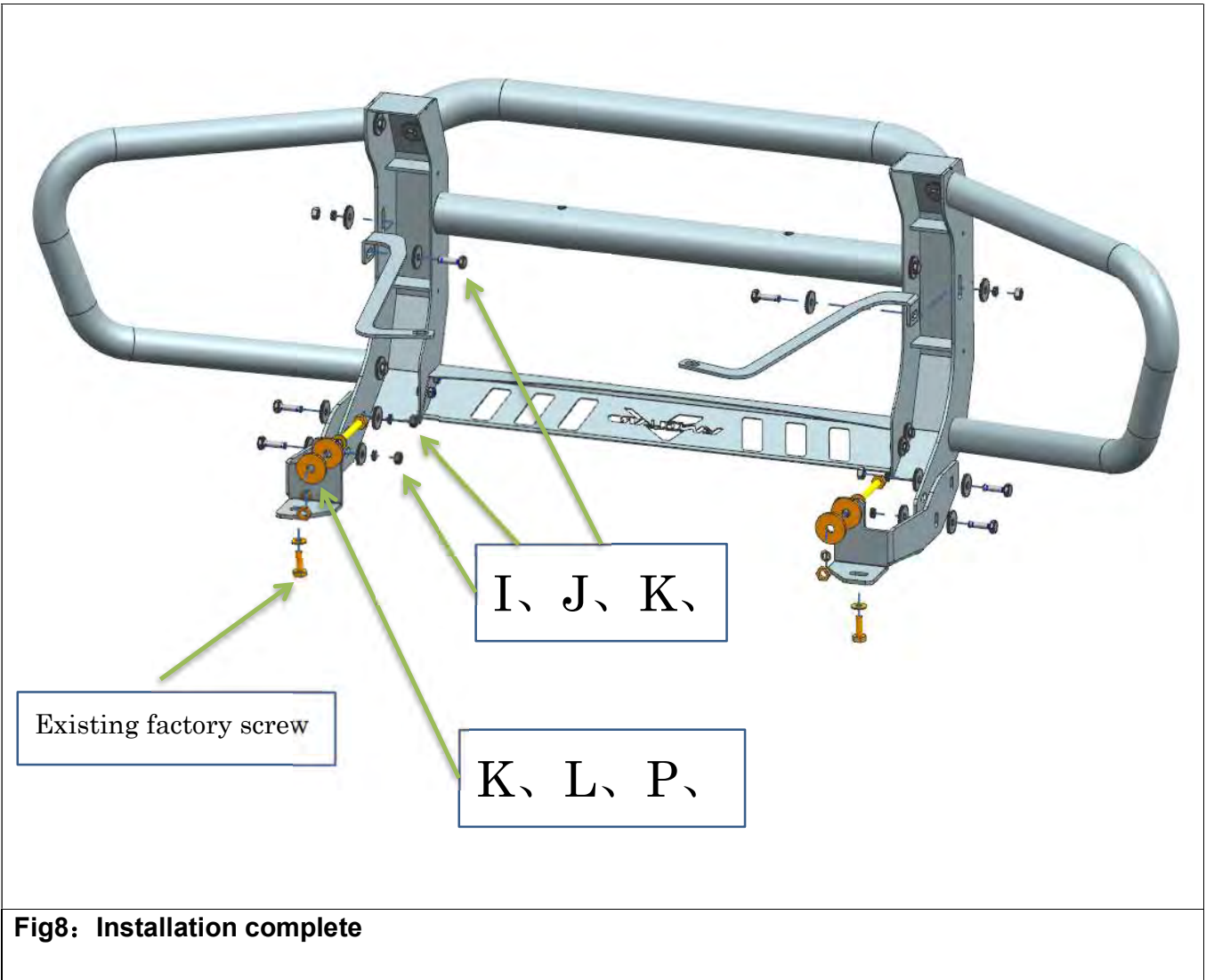
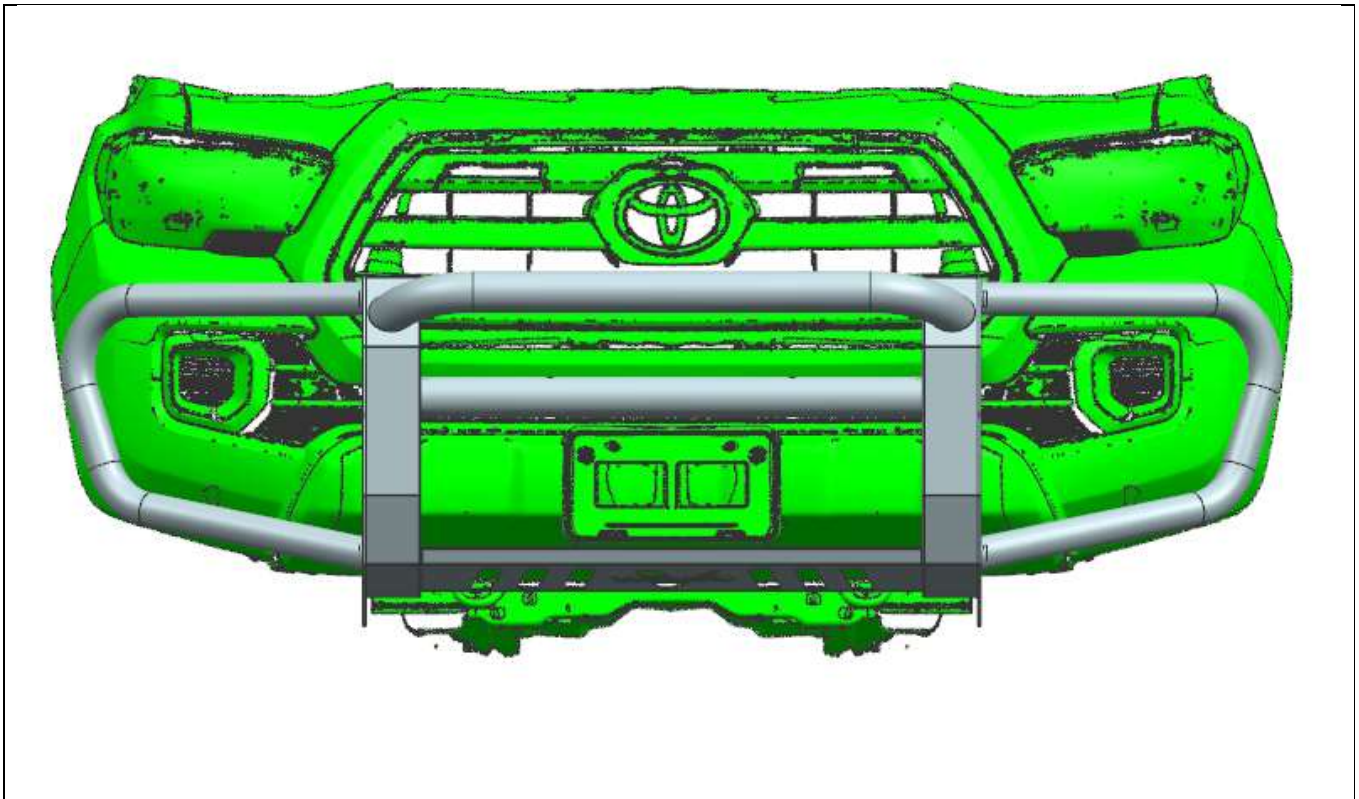

Fig7: Installation Instruction





TIPS:

= **Routine Maintenance** =

- 1) Please use neutral detergent to wet the soft cloth or suede and so on, then clean our product.

Note

- Do not use any hard objects such as brushes. Otherwise, it will cause surface scratches.
- Please protect the product from gasoline, light fuel, fuel oil, brake fuel, engine oil, paint thinner, sulphuric acid(battery liquid), wax remover, etc. Otherwise, it will cause product discoloration and dyeing. In case product come into contact with above objects, please use neutral detergent to wet the soft cloth or suede and so on, then clean our product and wash it with water quickly.