

2015-20 Chevrolet Colorado

Elite Modular Front Runner

VGFRG-2124-2126BK

Installation Instruction

Thank you very much for choosing our products.

Please read the installation instruction carefully before using our product and be sure to fully understand the contents mentioned above for subsequent installation.

In addition, please keep properly the installation instruction for product maintenance in future.

Attention

- The following symbols are used in this installation instruction.



Caution

**Relevant matters must be obeyed for safety.
Non-compliance may result in injury or other accidents.
Please read carefully and obey strictly.**









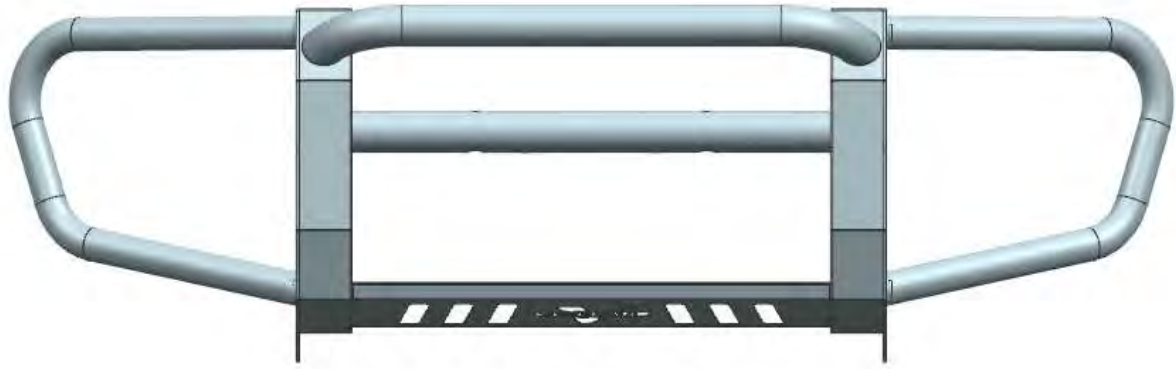



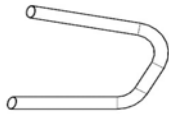
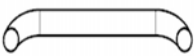

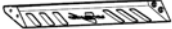

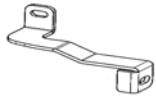

Note

**Relevant matters must be obeyed for the smooth installation
and use.**

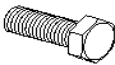

- Non-compliance may cause the problems with vehicle. Please do not install that is not recorded in this instruction.
- Please forgive that we are not responsible for any consequences arising from the installation not according to our installation instruction.

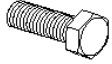

Product Composition *Please confirm if it is missing.

<p>A、Side bend (2 pieces, R、L)</p> 	<p>B、Top bend (1 pieces)</p> 	<p>C、Middle tube (1 piece)</p> 	<p>D、Sand baffle plate (1 piece)</p> 	<p>E、Sub plate (2 pieces, R、L)</p> 	<p>F、Mount Bracket (2 pieces, R、L)</p> 
<p>G、Top Support Bracket (2 pieces, R、L)</p> 	<p>H、Sleeve (2 pieces)</p> 	<p>I、M12*90 -8.8 Bolt (L=25) (4 pieces)</p> 	<p>J、M12 (Φ12.5*Φ24*T2) Flat Washer (8 pieces)</p> 	<p>K、M12 Lock Washer (4 pieces)</p> 	<p>L、M12 -8.0 Nut (4 pieces)</p> 
<p>M、M10×80-8.8 Bolt (2 pieces)</p> 	<p>N、M10*35-8.8 Bolt (14 pieces)</p> 	<p>O、M10 (Φ10.5*Φ25*T2.0) Flat Washer (22 pieces)</p> 	<p>P、M10 Lock Washer (16 pieces)</p> 	<p>Q、M10 -8.0 Nut (8 pieces)</p> 	<p>R、M8*20 -8.8 Bolt (4 pieces)</p> 
<p>S、M8 (Φ8.4*Φ22*T1.5) Flat Washer (4 pieces)</p> 	<p>T、M8 Lock Washer (4 pieces)</p> 				

Installation tools *Please prepare these tools before installation.

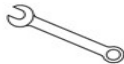
 <p>wrench 13/14</p>	 <p>wrench 16/17</p>	 <p>wrench 18//19</p>
---	---	---

Attentions

- The labels of fitting procedure inside the thick wire frame is particularly important. Pay attention to them in the actual installation.

Pay attention to safety during installation.

Fitting Procedure (The installation process is shown below, Fig1-8)

Fig1 : Parts assembly

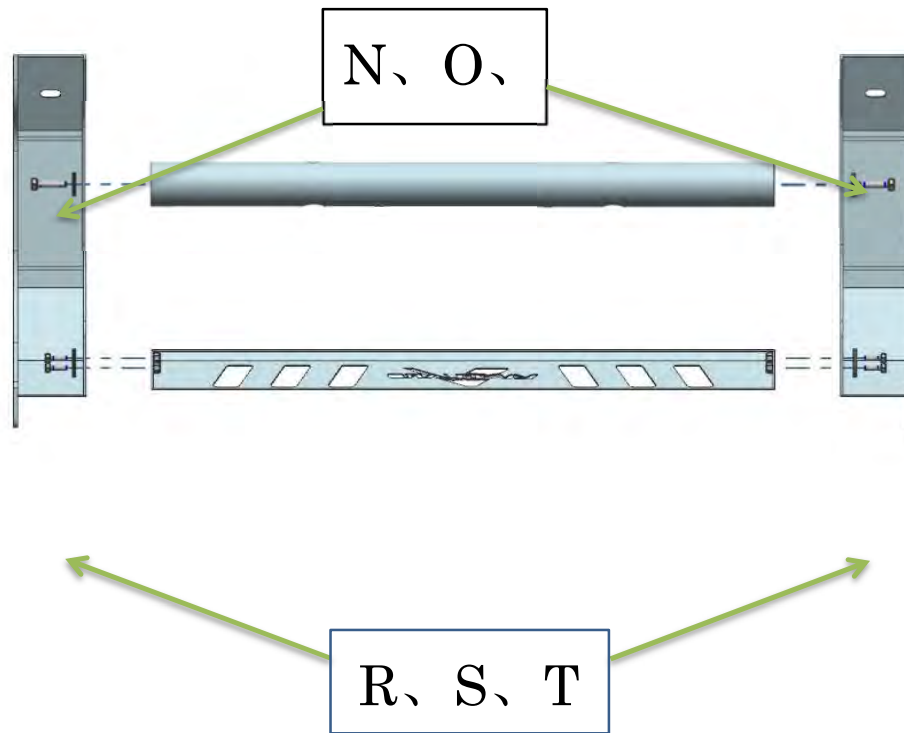

Fig2: Parts assembly

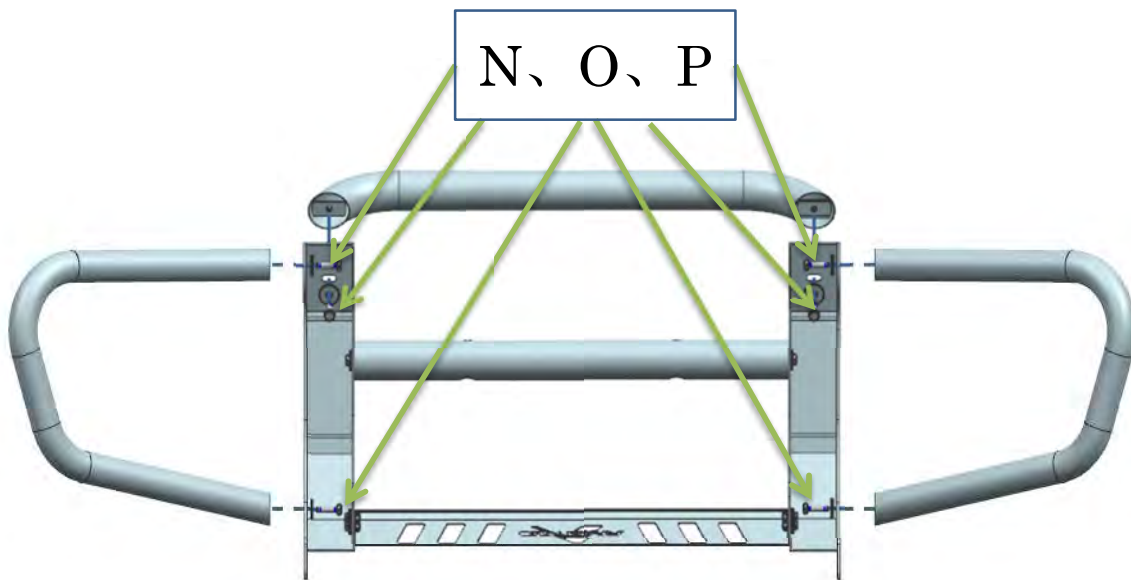

Fig3: Remove splash guard or skid plate from bottom of engine behind bumper

Fig4A: Remove hardware attaching bumper cover to cross member behind bumper

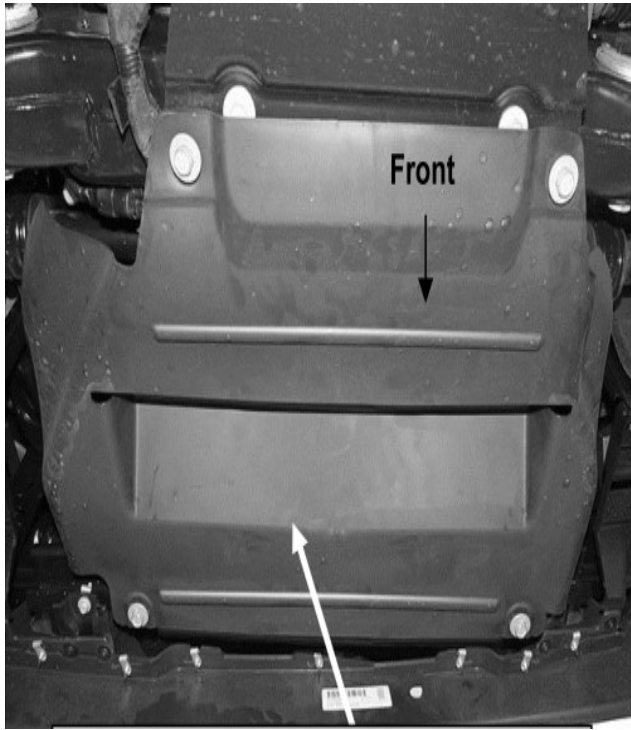

Fig4B: Remove hardware attaching plastic fill panel to inner fender

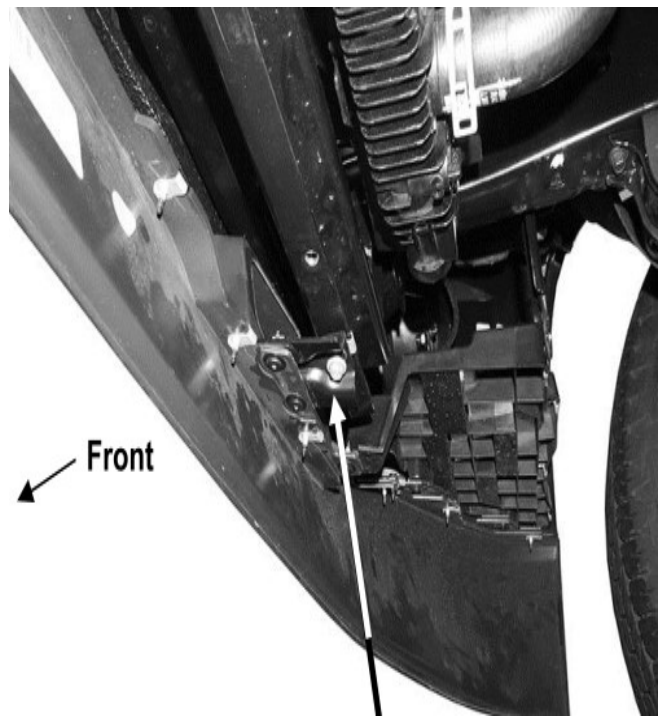

Fig4C: Remove hardware attaching fender liner to bumper cover



Fig4D: Pull back fender liner to access Bumper hardware and unplug light if equipped



Fig4E: Remove hardware attaching bumper cover to fender. Remove bumper cover

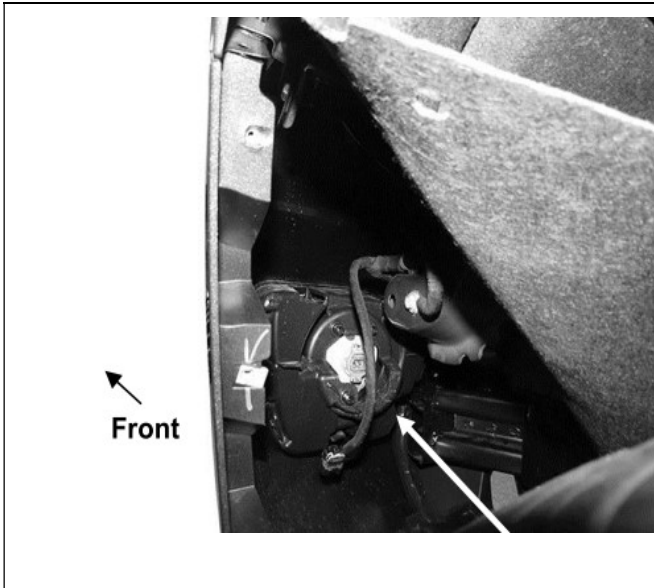

Fig5: Remove factory bolt (arrow).

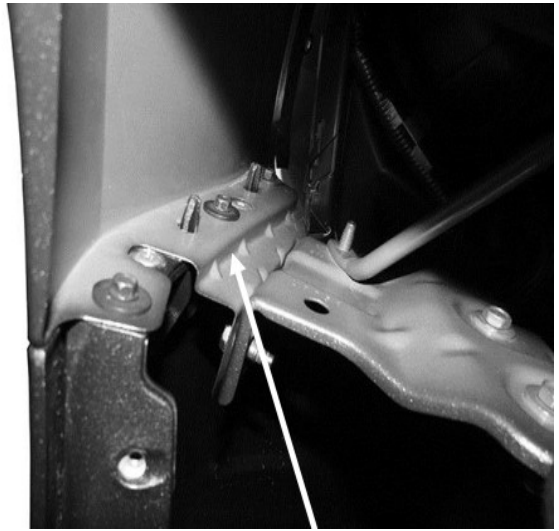

Fig6: Hold Top Bracket in place to determine area to cut from air deflector

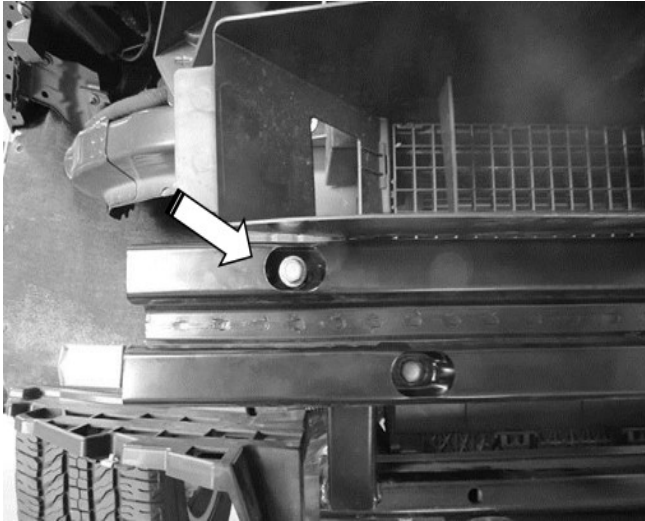

Fig7: Passenger Top Bracket



**Fig8: Air deflector cut to clear Top Bracket
(NOTE: Grille Guard installed to align Top Brackets before tightening 10mm x 80mm Hex Bolts)**

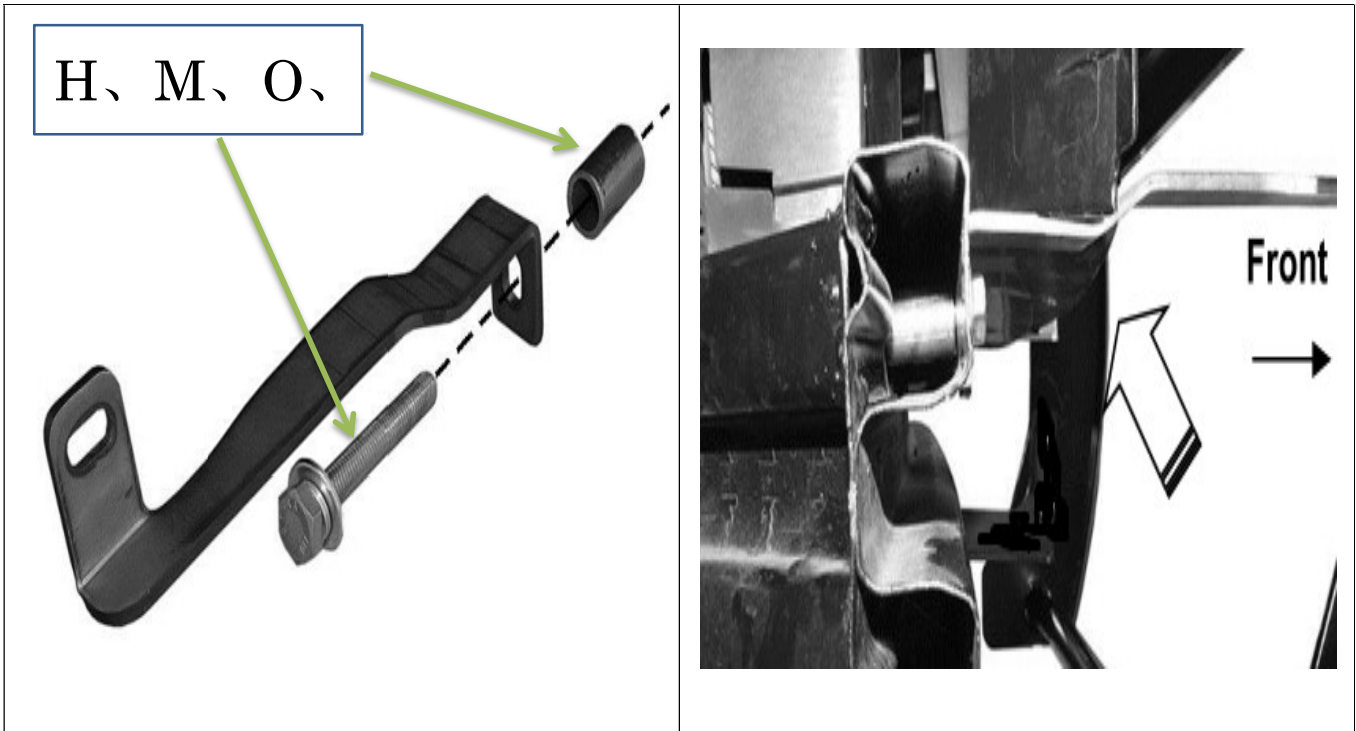

Fig9:Mount Bracket installed Installation Instruction

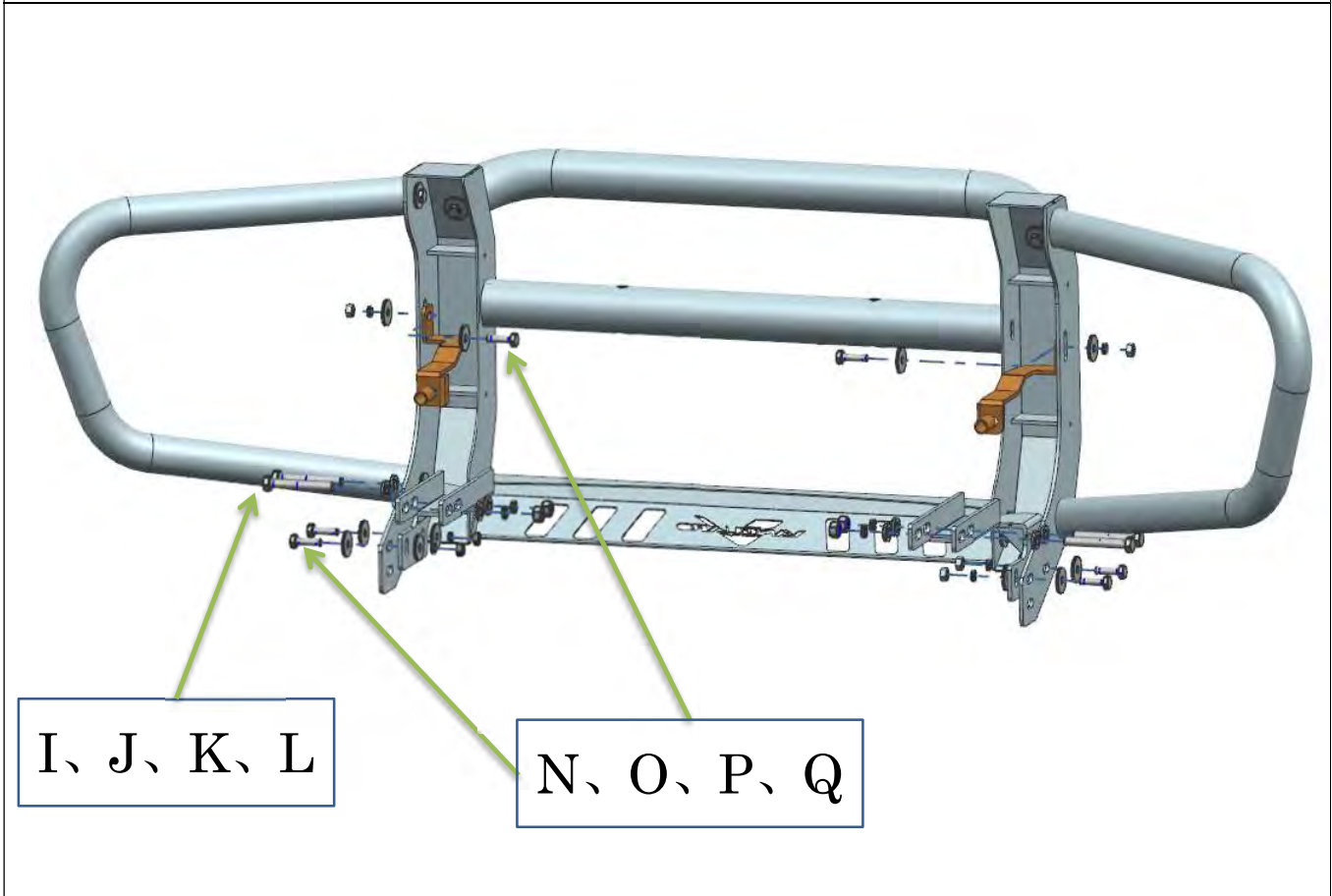
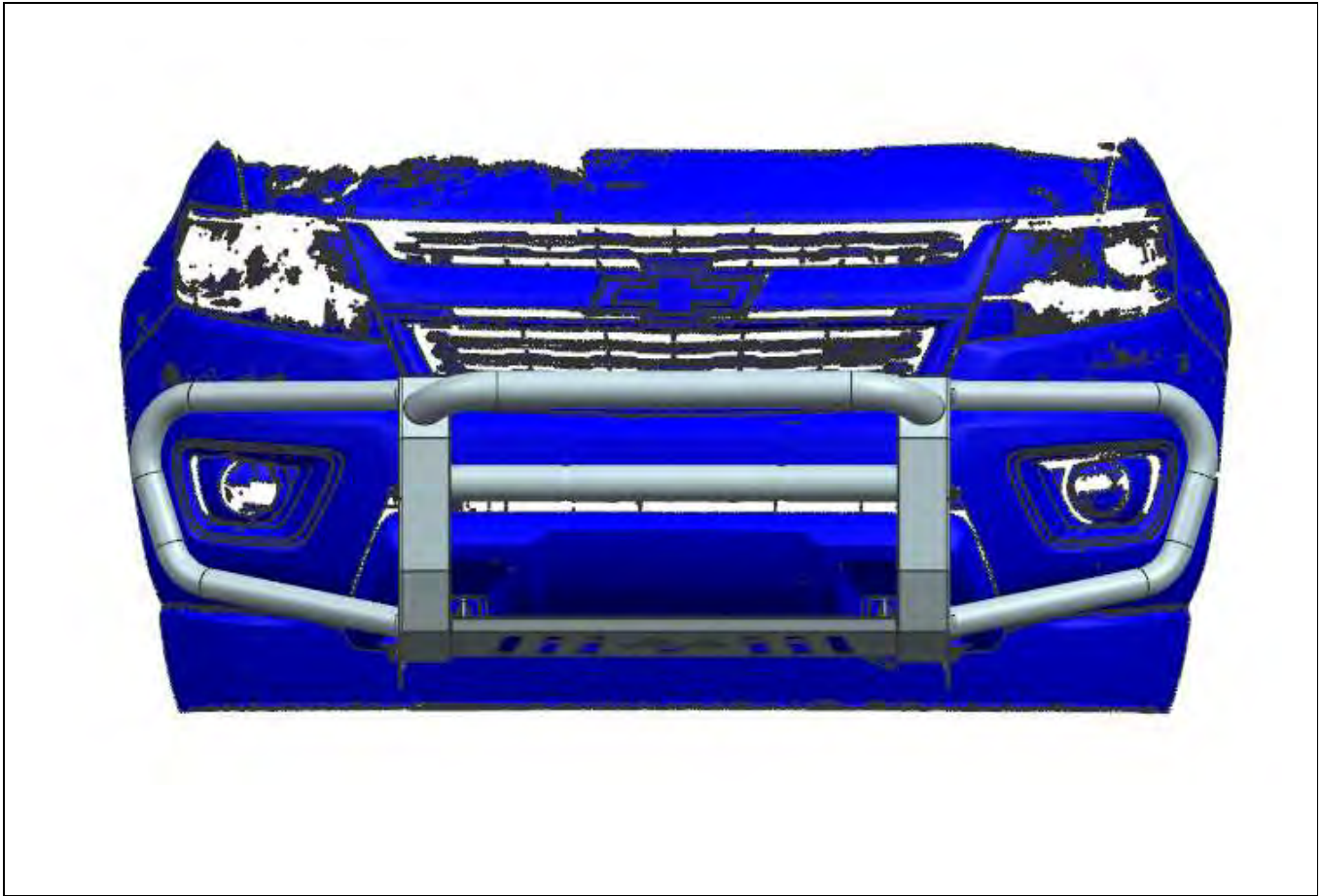

Fig9: Installation complete



TIPS:

= Routine Maintenance =

- 1) Please use neutral detergent to wet the soft cloth or suede and so on, then clean our product.

Note

- Do not use any hard objects such as brushes. Otherwise, it will cause surface scratches.
- Please protect the product from gasoline, light fuel, fuel oil, brake fuel, engine oil, paint thinner, sulphuric acid (battery liquid), wax remover, etc. Otherwise, it will cause product discoloration and dyeing. In case product come into contact with above objects, please use neutral detergent to wet the soft cloth or suede and so on, then clean our product and wash it with water quickly.