



INSTALLATION MANUAL

PRODUCT NAME: FRONT BAR FOR TACOMA 2024+

一、ATTENTION













1.For the convenience of installation,please read the product installation manual carefully before installation.Pay attention to protect surface of your car to avoid scratches.











2.Please check regularly whether all accessories connected to the car are loose or not to ensure safety using.

3.All the pictures in this manual are for reference only.The pictures may be different from the actual product,but the installation method is the same.

二、ACCESSORIES

NO.	DES	QTY	IMAGE	NO	DES	QTY	IMAGE
1	FRONT BAR	1		8	HEXAGON FLANGE NUT M6	2	
2	WING RACK (L)	1		9	HEXAGON NUT M10	6	
3	WING RACK (R)	1		10	HEXAGON NUT M12	14	
4	WINCH PLATE	1		11	HEXAGON NUT M8	4	
5	LIGHT BAR	1		12	HEXAGON BOLT M10*40	6	
6	RADAR BRACKET	2		13	HEXAGON BOLT M10*40*1.25	4	
7	BAR STRIP 1400mm	1		14	HEXAGON BOLT M12*35	6	

NO	DES	QTY	IMAGE
15	HEXAGON BOLT M12*40	8	
16	HEXAGON BOLT M6*20	2	
17	HEXAGON BOLT M8*25	10	
18	Hexagon socket bolts M6*20	8	
19	FLAT WASHER φ10x20	16	
20	FLAT WASHER φ12x30x3.0	28	
21	FLAT WASHER φ6*12*1.6	2	
22	FLAT WASHER φ8x20	14	
23	SPRING WASHER φ10	10	
24	SPRING WASHER φ12	14	

NO	DES	QTY	IMAGE
25	SPRING WASHER D8	10	
26	HOOK	2	
27	MESH	1	
28	LIGHT BAR BRACKET	2	
29	MESH BRACKET	2	
30	RADAR HOLE PLUG	2	
31	COVER PLATE	2	
32	Fog light mounting bracket	2	
33	Control box bracket	1	
34	Fog light + harness	2	

35	TACOMA front radar extension harness 35CM	2	
----	---	---	---

≡.BAR INSTALLATION

1.

Install the two wings (2.3.)
onto the bar (1) with
bolts and washer (17.22.25.)

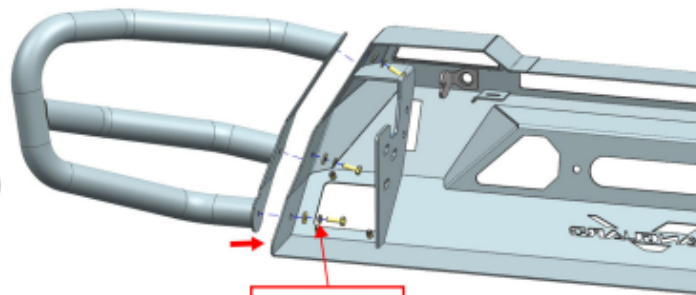

17.22.25.

2.

Install 2 cover plates (31)
onto the bar (1)
with bolts (18)

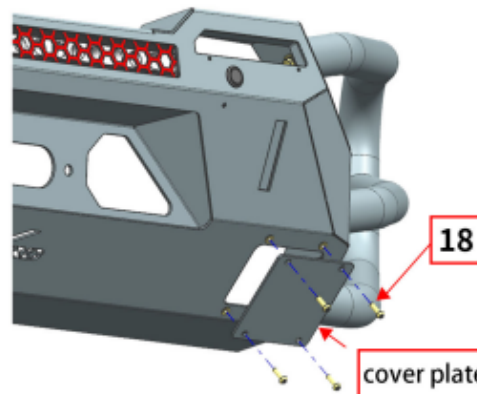

18

cover plate

3.

Install the hooks with
bolts (9.12.19.,23.)

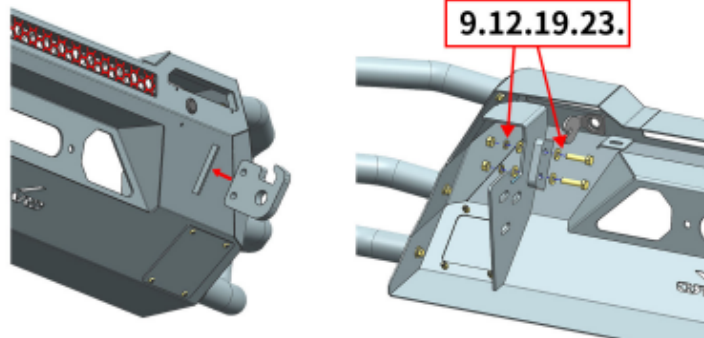

9.12.19.23.

4.

Install radar bracket onto the bar with bolts (8.16.21.)
And put on radar hole plug

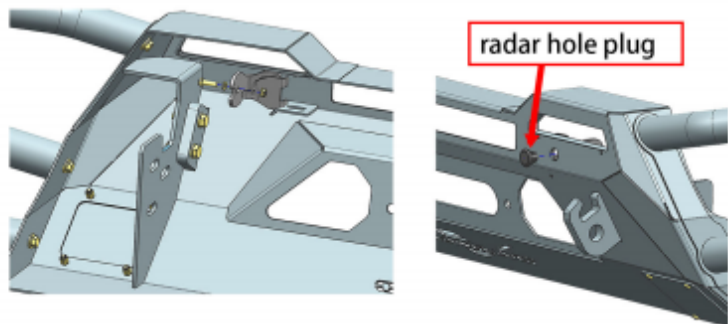

5.

Install light bar bracket onto the bar with bolts (11.17.22.25.)

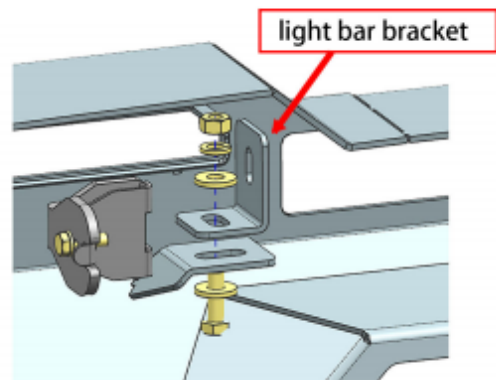

6.

Install light bar and mesh onto the bar with bolts (11.17.22.25.)

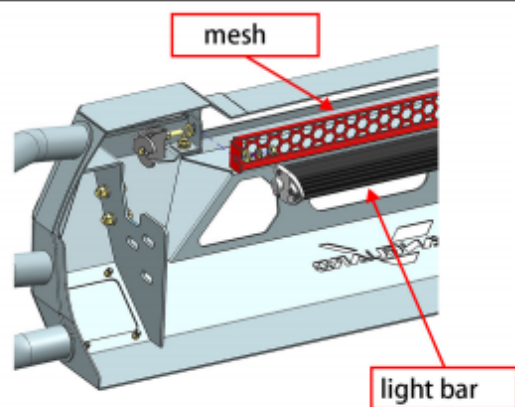

7.

Install winch plate onto the bar with bolts(10.14.20.24.)

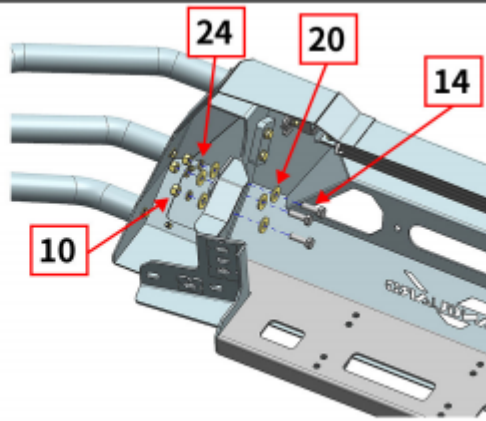

8.Remove fender flare



9. Remove top screw

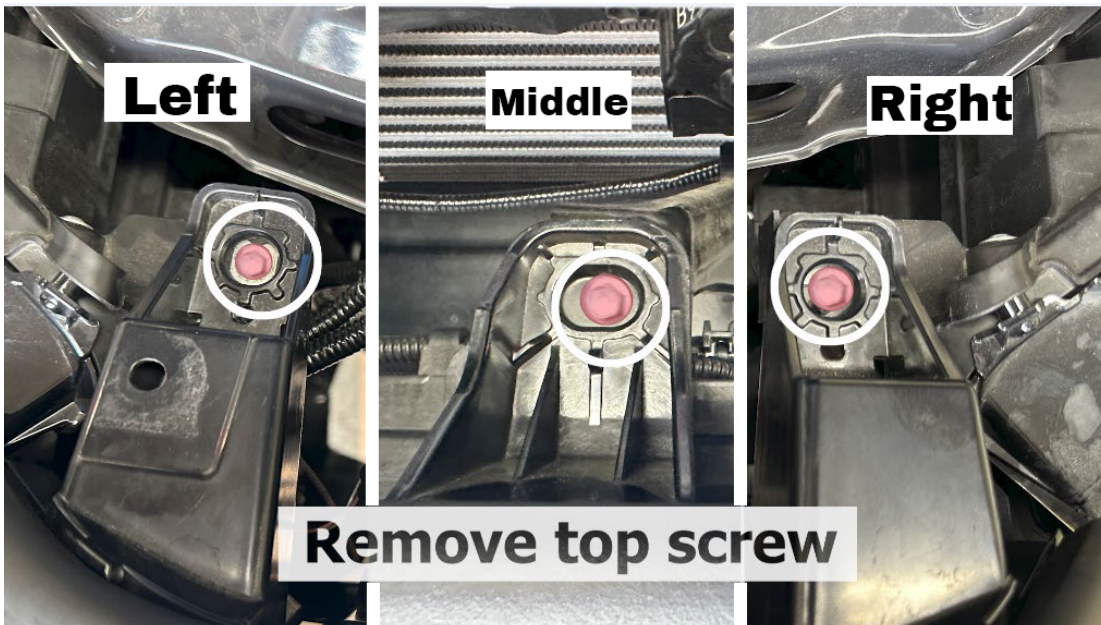

9. Remove bottom screw



10. Unplug the wiring harness and front camera plugs located on passenger side.

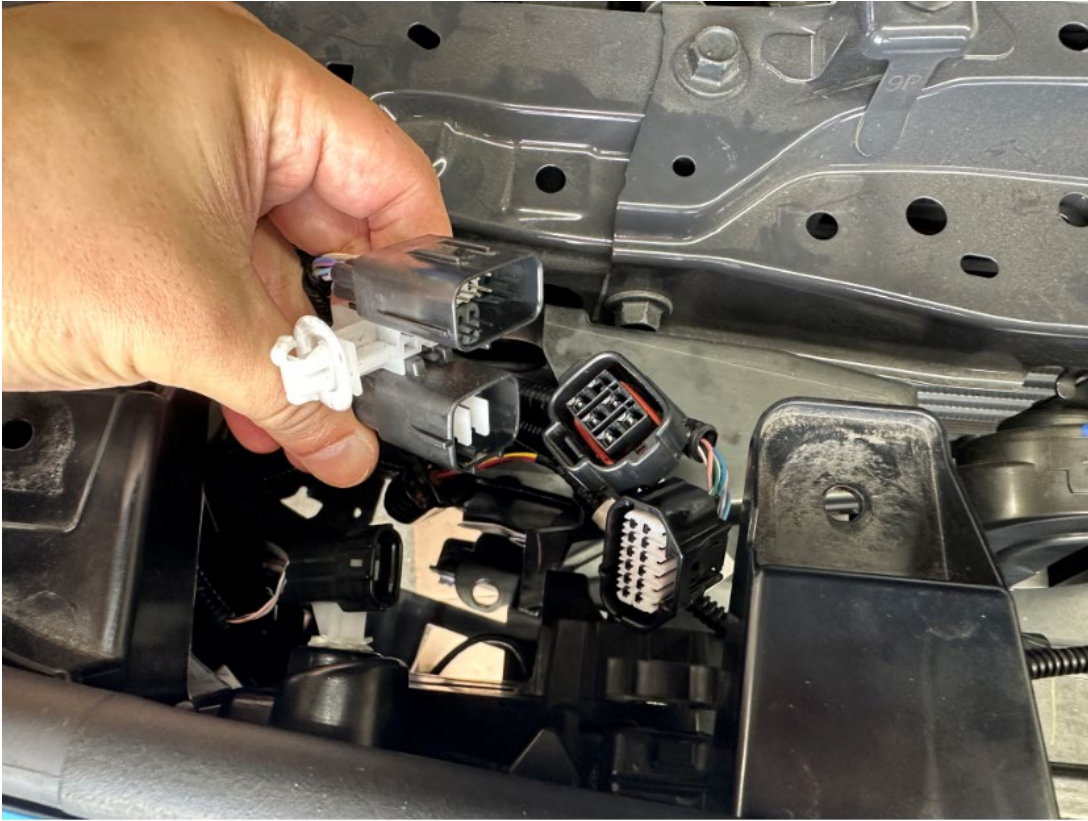

11.Remove front bumper



12.Remove bottom fender



13.Remove the parking sensor

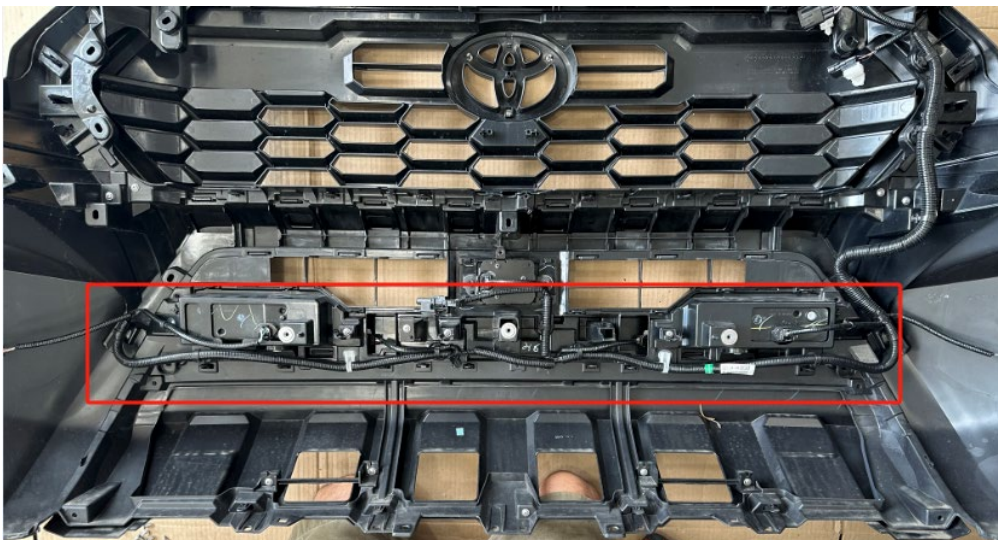

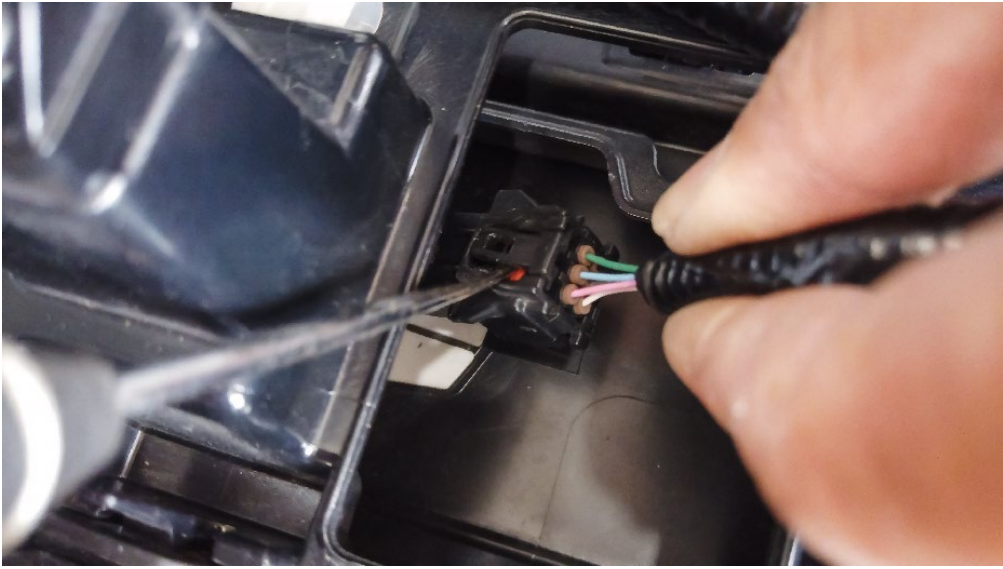

14. Make sure the sensor is centered and level with the panel

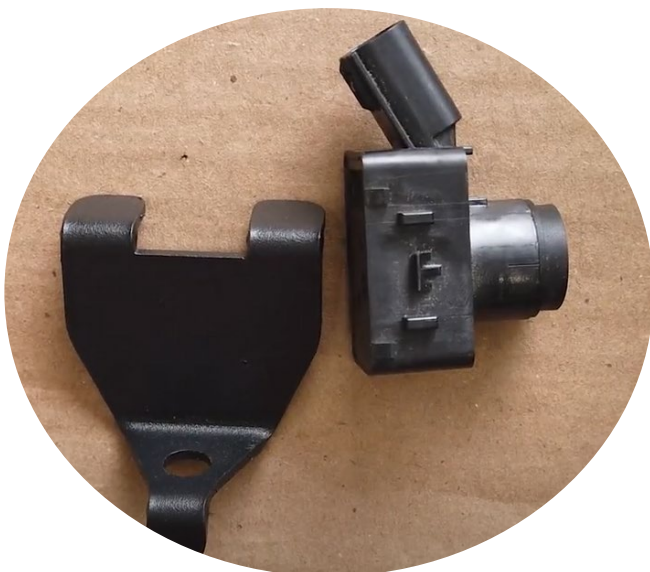
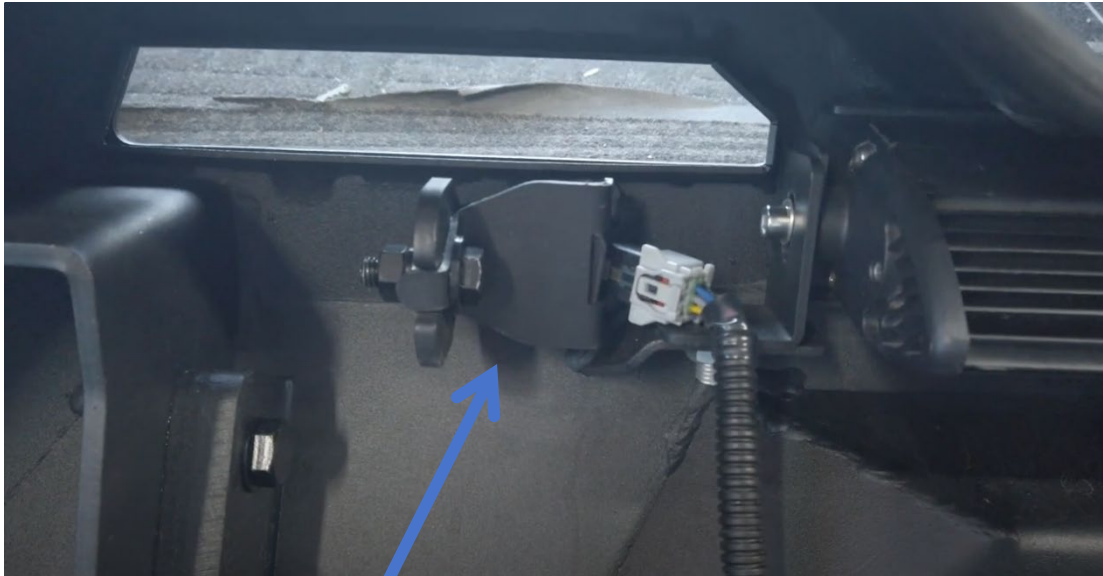

15. Remove the crash bar cover

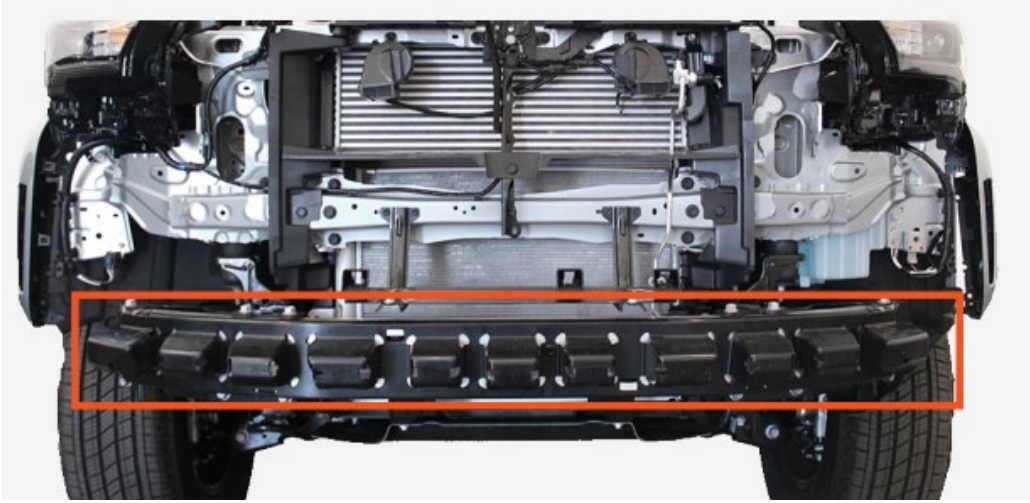

16. Remove the bolts as shown below. You can remove the crash bar.

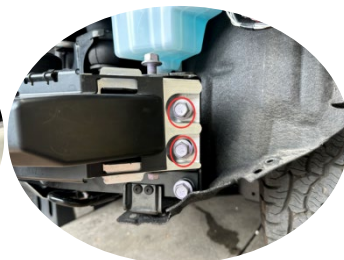
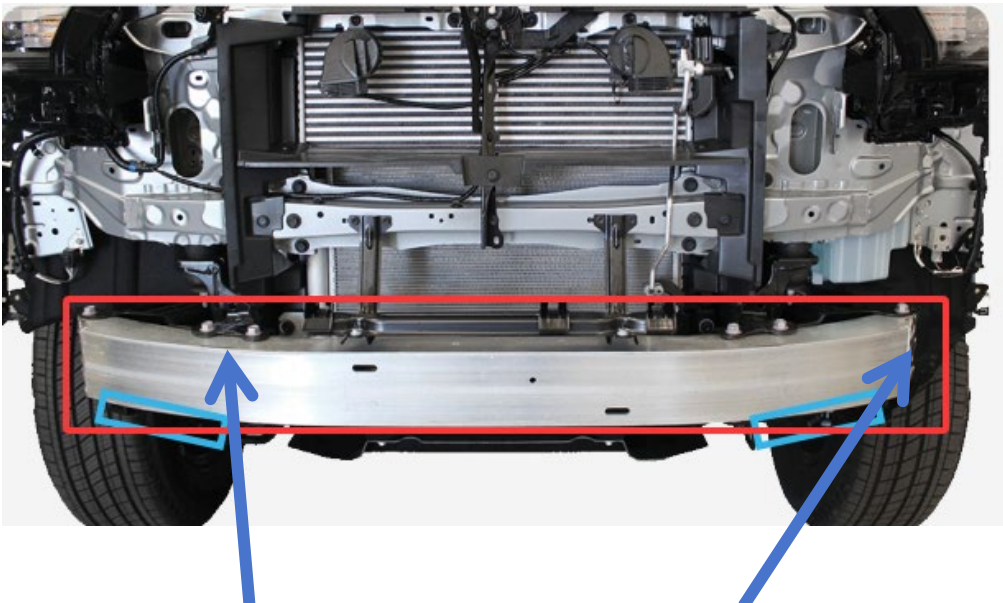

16. Remove it

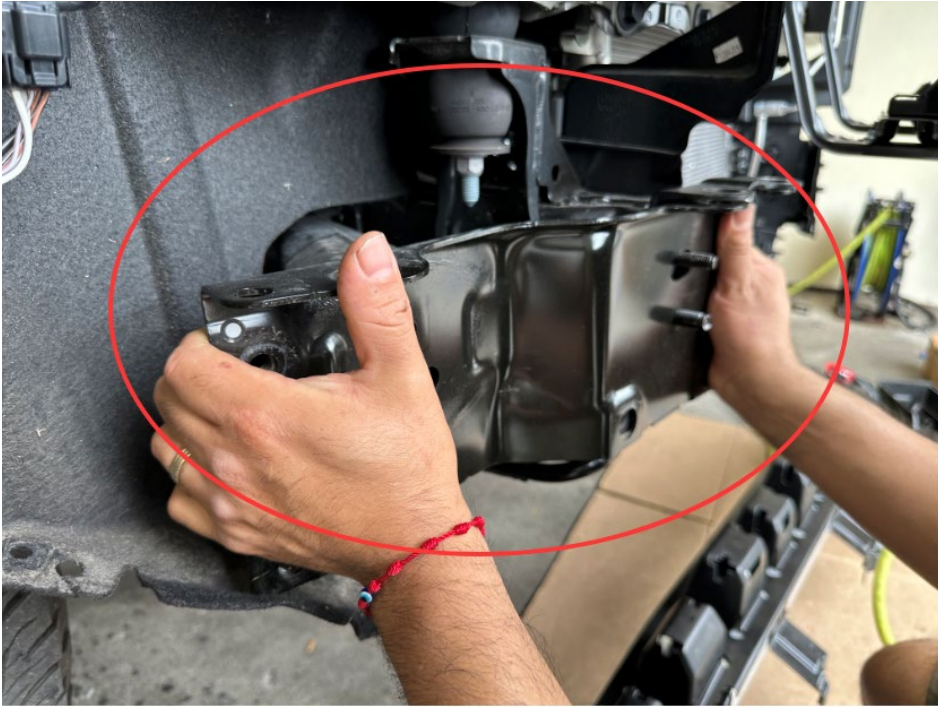

17. Install winch reinforcement

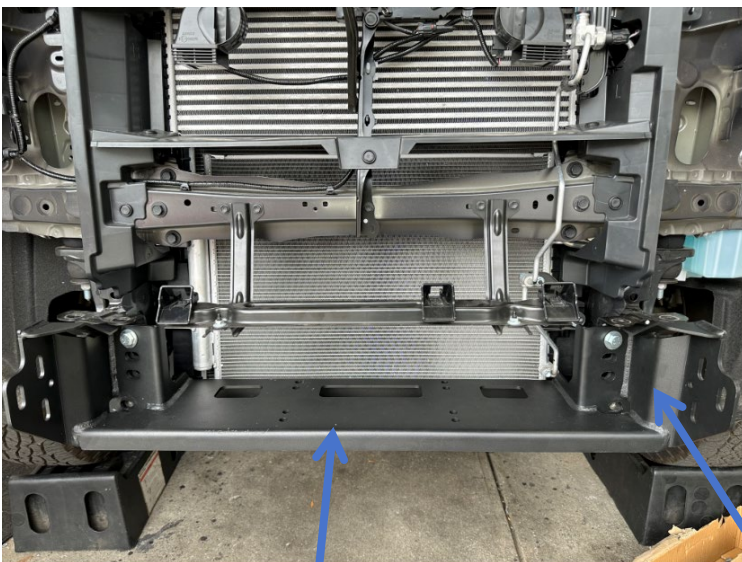

Reinforcement

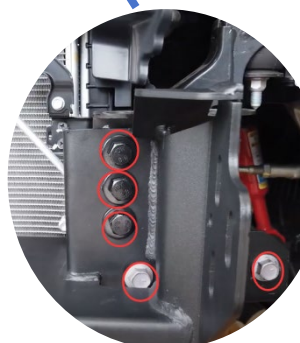

18.Remove original bracket and install our bracket as below.

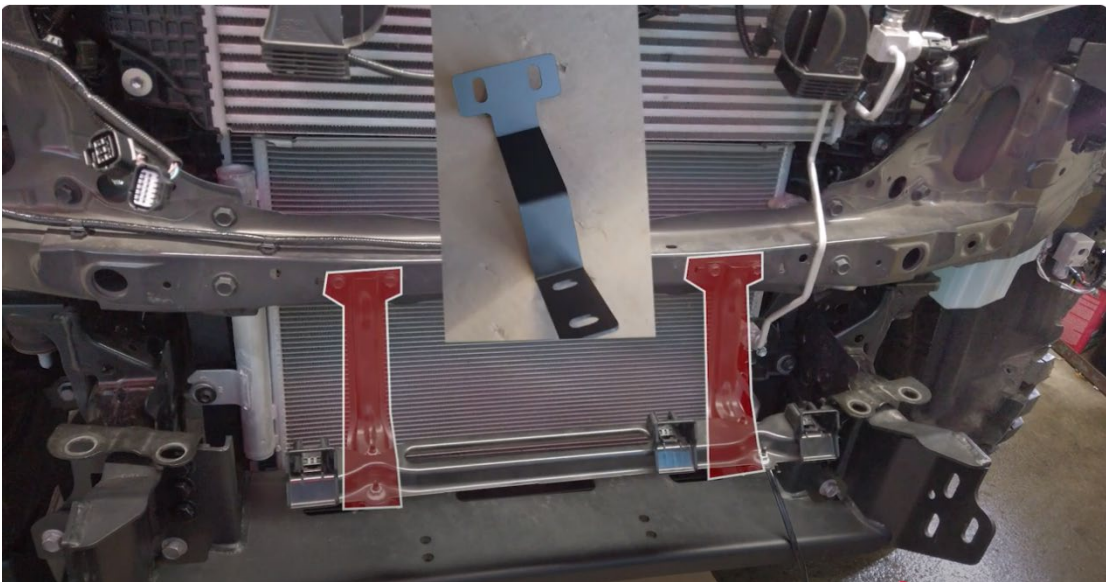
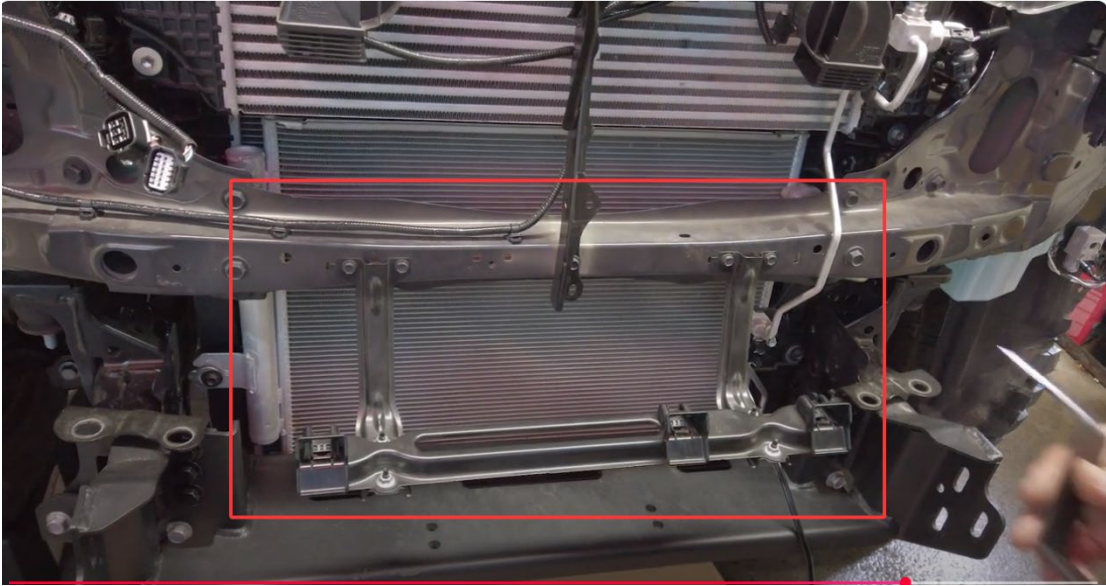

19.Position the winch

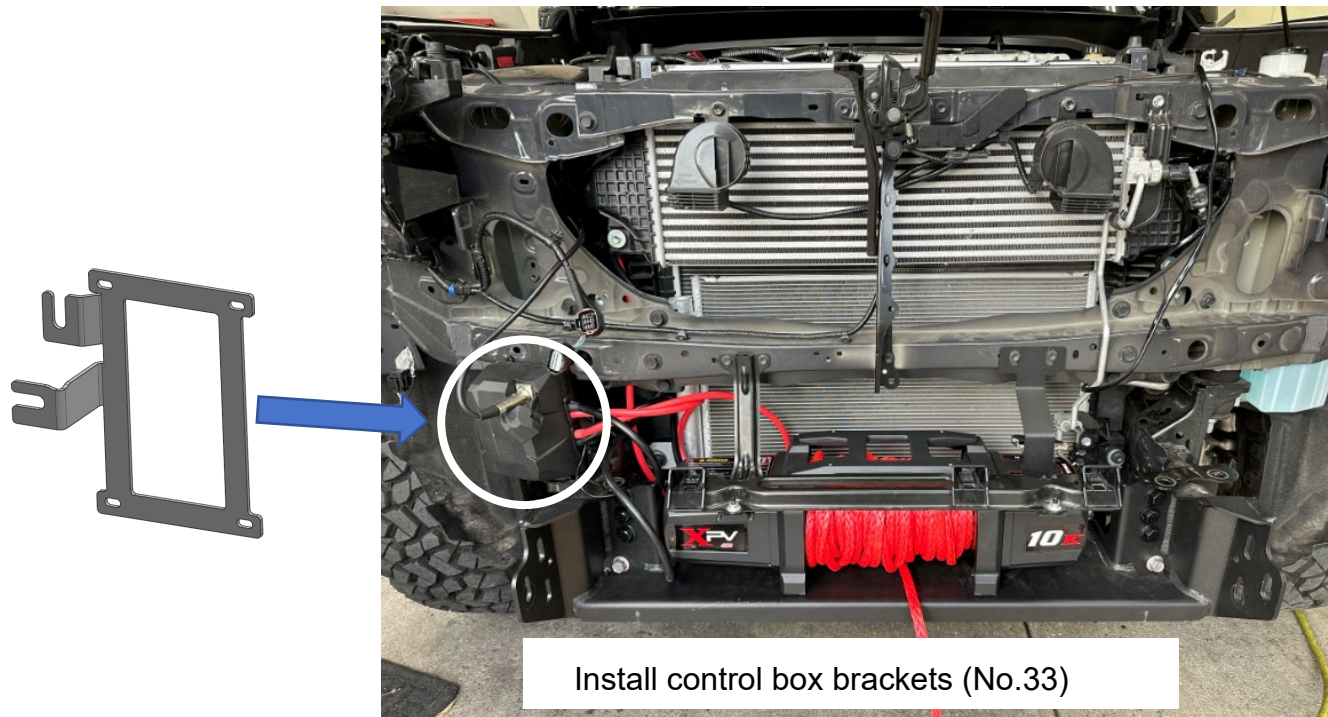

20.Put plastic front bumper back



21. Cut along the edge as shown below

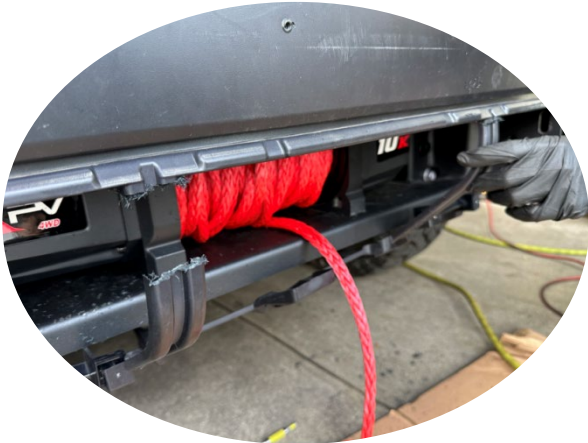

22.Install steel bumper.



Driver side



Passenger side



If you want to watch installation video. Please scan QR code below.

