

POWER STEERING SYSTEM FLUSH PROCEDURE

The power steering system must be flushed prior to installation of any replacement component. If you are installing a replacement rack, we strongly recommend that the pump and hoses be replaced as well.

Follow the steps below to properly flush the system:

1. Remove all pressure and return lines from pump. Flush the pump reservoir, return, and pressure lines by circulating new fluid through components until fluid runs clear. Be sure to use only the specific fluid recommended for the vehicle. If the vehicle is over 5 years old, we recommend that the hoses be replaced.
2. Reconnect pressure line to pump and steering component. Reconnect return line only to steering component.
3. Place the return line from power steering unit into a drain pan. Cap the return port on reservoir to prevent leakage.
4. Fill the power steering fluid reservoir with *NEW* recommended power steering fluid for the vehicle.
5. Disable the engine so it will not start when cranked. Refer to vehicle service manual for correct procedure.
6. Crank engine and continue to replenish fluid until the fluid coming from the return line has no air bubbles. Caution should be taken to ensure that the power steering pump is not operated without fluid. Note: Do not subject the vehicle's starter to prolonged cranking, as this may damage the starter.
7. Connect the return line to the power steering pump. Make sure the fluid in the pump reservoir is at proper operating level.
8. Vacuum bleed the system (engine off & front wheels off the ground) and refill reservoir to proper level if necessary.
9. Check for smooth assist, excessive noise, connections for leakage and system for proper operation.

This is a quick reference guide only. For more detailed information on system operation and servicing, always refer to a technical service manual or approved information system.

POWER STEERING SYSTEM VACUUM BLEEDING PROCEDURE

The power steering system must be bled following the installation of any replacement component.

Follow the steps below to properly bleed the system:

1. Verify that hoses are routed properly. Contact with the frame or engine may cause system noises.
2. Verify all hose connections are tight.
3. Remove the pump reservoir cap.
4. Fill the reservoir to the FULL COLD level.
5. Tightly insert rubber vacuum plug onto the pump reservoir.
7. Attach the vacuum pump to the rubber vacuum plug.
8. Apply a vacuum of 60-68kPa (18-20 in Hg) maximum for a minimum of 3 minutes.
9. Slowly release the vacuum.
10. Remove the vacuum pump and rubber plug.
11. Repeat steps #4 through #9 until fluid no longer drops.
12. Fill the reservoir to the FULL COLD level*. Reinstall the pump reservoir cap.

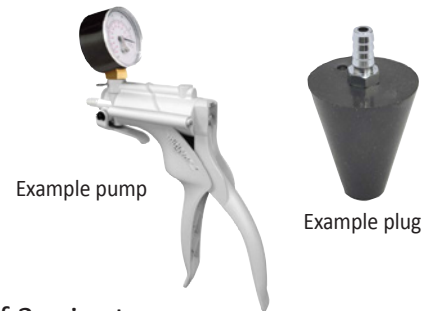

Start the engine. Allow engine to idle.

13. Turn of engine. Verify the fluid level.

14. Start the engine. Allow the engine to idle.

CAUTION: DO NOT HOLD STEERING WHEEL AT THE LOCK TO LOCK POSITIONS.

15. Turn the wheel, lock to lock, three times.

16. Switch engine off. Verify fluid level. Check for any signs of air in the system.

If air is present repeat the procedure as necessary.

*When adding or changing the fluid, be sure to use only the manufacturer's suggested fluid.

This is a quick reference guide only. For more detailed information on system operation and servicing, always refer to a technical service manual or approved information system.

THE PERFECT POWER STEERING INSTALLATION

Reduce Returns With These Simple Steps...

- 1 REMOTE RESERVOIR**
Replace reservoir or clean internal filters.



- 2 FLUID**
Use proper fluid.



- 3 FLUSH**
Flush 4 quarts of OE recommended fluid to clean out debris.

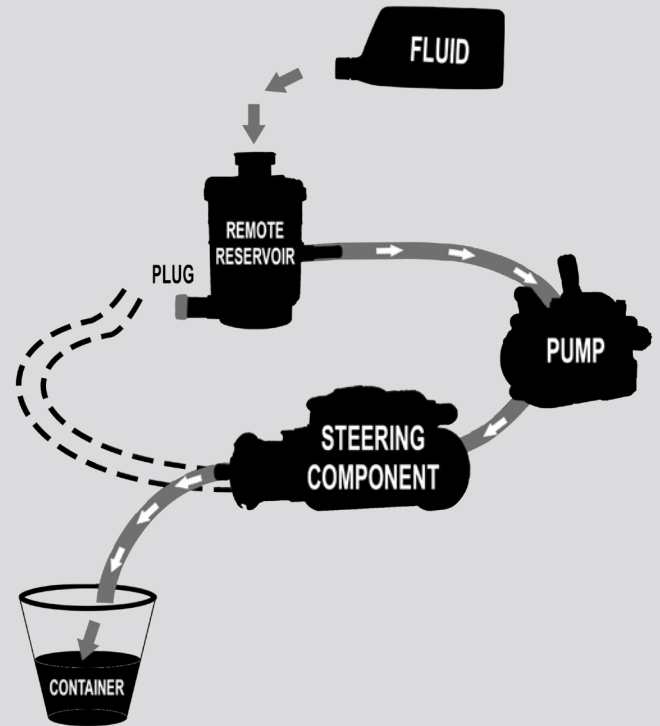

- 4 IN-LINE FILTER**
Install filter on the return line to catch contamination.



- 5 HOSES**
Replace hoses at 5 years or 100K miles.

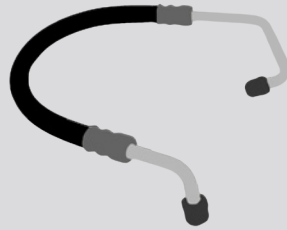

- 6 VACUUM BLEED***
Remove air to ensure proper function and to prime the steering pump. (Particularly if the pump has a remote reservoir.)

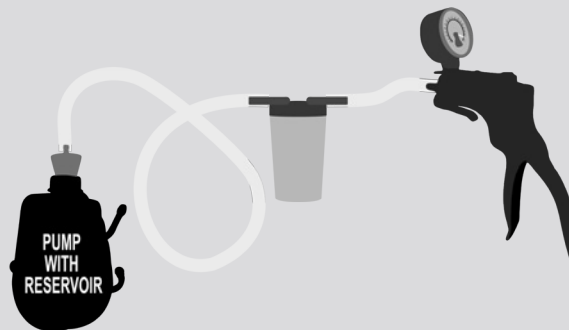

*Refer to the Power Steering System Vacuum Bleeding Procedure document for complete instructions.

This is a quick reference guide only. For more detailed information on system operation and servicing, always refer to a technical service manual or approved information system.

THE IMPORTANCE OF FILTERING POWER STEERING SYSTEMS

- Fluid contamination is the leading cause of power steering component failure.
- Internal hose linings can degrade over time, causing debris to circulate through the system. The contaminated fluid clogs valves and remote reservoirs (*Image 1*), and decreases the lubricating properties of the fluid.
- Clogged OE remote reservoirs (*Image 2*) restrict the flow of fluid, which can starve the pump, causing premature pump failure.
- Cleaning or replacing remote reservoirs is an essential part of the complete power steering installation.
- Installing an in-line filter (*Image 3*) to catch debris before it reaches critical steering components, ensures long power steering system service life.
- In the event the paper element clogs, in-line filters have a built-in bypass preventing flow restrictions in the steering system.



Image 1

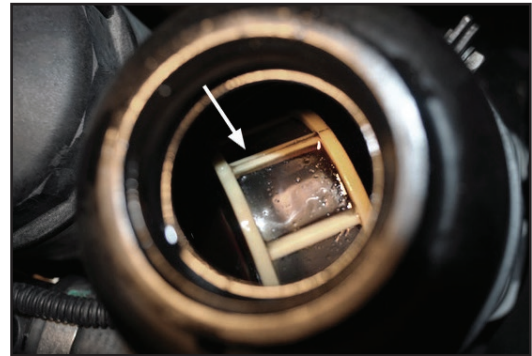

Image 2



Image 3

POWER STEERING SYSTEM FLUSH PROCEDURE

The power steering system must be flushed prior to installation of any replacement component. If you are installing a replacement rack, we strongly recommend that the hoses be replaced as well.

Follow the steps below to properly flush the system:

1. Remove all pressure and return lines from pump. Flush the pump reservoir, return, and pressure lines by circulating new fluid through components until fluid runs clear. Be sure to use only the specific fluid recommended for the vehicle. **If the vehicle is over 5 years old, we recommend that the hoses be replaced.**
2. Reconnect pressure line to pump and steering component. Reconnect return line only to steering component.
3. Place the return line from power steering unit into a drain pan. Cap the return port on reservoir to prevent leakage.
4. Fill the power steering fluid reservoir with **NEW** recommended power steering fluid for the vehicle.
5. Disable the engine so it will not start when cranked. Refer to vehicle service manual for correct procedure.
6. Crank engine and continue to replenish fluid until the fluid coming from the return line has no air bubbles. Caution should be taken to ensure that the power steering pump is not operated without fluid. **Note: Do not subject the vehicle's starter to prolonged cranking, as this may damage the starter.**
7. Install in-line filter. Connect the return line to the power steering pump. Make sure the fluid in the pump reservoir is at proper operating level.
8. Bleed the system (engine off & front wheels off the ground) and refill reservoir to proper level if necessary. **Vacuum bleeding is the recommended method to properly prime and bleed the system.**
9. Check for smooth assist, excessive noise, connections for leakage and system for proper operation.

This is a quick reference guide only. For more detailed information on system operation and servicing, always refer to a technical service manual or approved information system.

THE PERFECT POWER STEERING INSTALLATION

Reduce Returns With These Simple Steps...

- 1 REMOTE RESERVOIR**
Replace reservoir or clean internal filters.



- 2 FLUID**
Use proper fluid.



- 3 FLUSH**
Flush 4 quarts of OE recommended fluid to clean out debris.

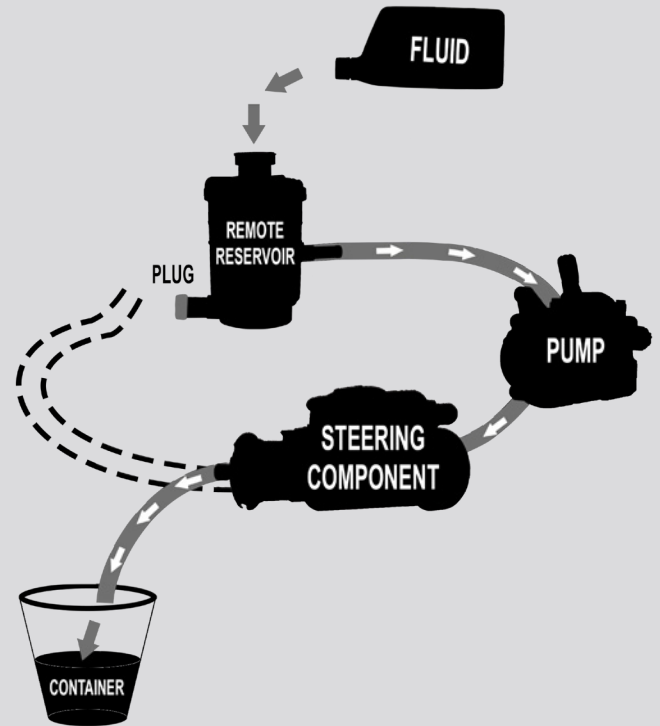

- 4 IN-LINE FILTER**
Install filter on the return line to catch contamination.



- 5 HOSES**
Replace hoses at 5 years or 100K miles.

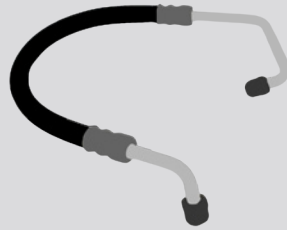

- 6 VACUUM BLEED***
Remove air to ensure proper function and to prime the steering pump. (Particularly if the pump has a remote reservoir.)

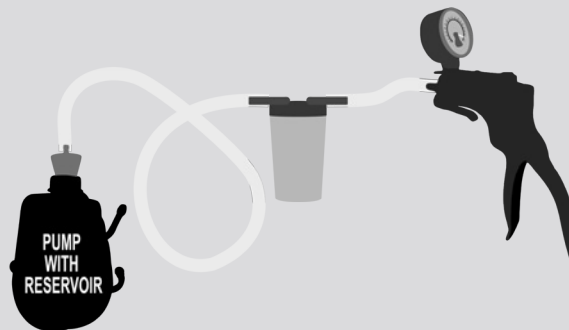

*Refer to the Power Steering System Vacuum Bleeding Procedure document for complete instructions.

This is a quick reference guide only. For more detailed information on system operation and servicing, always refer to a technical service manual or approved information system.

POWER STEERING PUMP REPLACEMENT PROCEDURES

Critical Steps

Always refer to authorized service procedures for specific vehicles when servicing the power steering system. Following these procedures are important to fix it correctly the first time.

1. Flush and bleed the system using the proper special tools. Any residual contaminants will result in pump failure. Verify that the filter (screen material) in the reservoir is clean and free of contamination. Low or no pressure from the power steering pump may be the result of dirty or contaminated fluid. This will cause the relief valve to stop functioning.
2. Remove the pulley using the proper tool. Distorting the pulley may damage bearings on the new pump. Pulley alignment is crucial.
3. Use the new O-rings included with the replacement pump. The new reservoir O-ring must be lubricated with OE-specific Power Steering Fluid prior to installation.
4. Properly install the pulley onto the new pump's drive shaft. Installation tools are included with each replacement pump.
5. Use only the recommended Power Steering Fluid that is specific to the vehicle.
6. Properly bleed the system to avoid damaging the pump.



FILTRATION WITH PUMP REPLACEMENT

Even the best system flush can still leave behind small particulate matter. Adding a return-side filter will aid in collecting these particles before they reach the pump.

Basic Vacuum Bleeding

This procedure will aid with initial noise upon install, foamy fluid conditions and fluid pushing out/off the cap after vehicle shut down.

Tools Required: J35555 Mighty Vac and J43485 Power Steering Bleeder Adapter

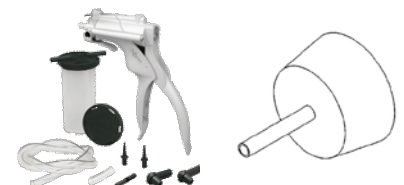

POWER STEERING SYSTEM FLUSH PROCEDURE

The power steering system must be flushed prior to installation of any replacement component. If you are installing a replacement rack, we strongly recommend that the pump and hoses be replaced as well.

Follow the steps below to properly flush the system:

1. Remove all pressure and return lines from pump. Flush the pump reservoir, return, and pressure lines by circulating new fluid through components until fluid runs clear. Be sure to use only the specific fluid recommended for the vehicle. **If the vehicle is over 5 years old, we recommend that the hoses be replaced.**
2. Reconnect pressure line to pump and steering component. Reconnect return line only to steering component.
3. Place the return line from power steering unit into a drain pan. Cap the return port on reservoir to prevent leakage.
4. Fill the power steering fluid reservoir with **NEW** recommended power steering fluid for the vehicle.
5. Disable the engine so it will not start when cranked. Refer to vehicle service manual for correct procedure.
6. Crank engine and continue to replenish fluid until the fluid coming from the return line has no air bubbles. Caution should be taken to ensure that the power steering pump is not operated without fluid. **Note: Do not subject the vehicle's starter to prolonged cranking, as this may damage the starter.**
7. Connect the return line to the power steering pump. Make sure the fluid in the pump reservoir is at proper operating level.
8. Bleed the system (engine off & front wheels off the ground) and refill reservoir to proper level if necessary. **Vacuum bleeding is the recommended method of removing air from the system.**
9. Check for smooth assist, excessive noise, connections for leakage and system for proper operation.

This is a quick reference guide only. For more detailed information on system operation and servicing, always refer to a technical service manual or approved information system.

POWER STEERING PUMP REPLACEMENT PROCEDURES

Critical Steps

Always refer to authorized service procedures for specific vehicles when servicing the power steering system. Following these procedures are important to fix it correctly the first time.

1. Flush and bleed the system using the proper special tools. Any residual contaminants will result in pump failure. Verify that the filter (screen material) in the reservoir is clean and free of contamination. Low or no pressure from the power steering pump may be the result of dirty or contaminated fluid. This will cause the relief valve to stop functioning.
2. Remove the pulley using the proper tool. Distorting the pulley may damage bearings on the new pump. Pulley alignment is crucial.
3. Use the new O-rings included with the replacement pump. The new reservoir O-ring must be lubricated with OE-specific Power Steering Fluid prior to installation.
4. Properly install the pulley onto the new pump's drive shaft. Installation tools are included with each replacement pump.
5. Use only the recommended Power Steering Fluid that is specific to the vehicle.
6. Properly bleed the system to avoid damaging the pump.



FILTRATION WITH PUMP REPLACEMENT

Even the best system flush can still leave behind small particulate matter. Adding a return-side filter will aid in collecting these particles before they reach the pump.

Basic Vacuum Bleeding

This procedure will aid with initial noise upon install, foamy fluid conditions and fluid pushing out/off the cap after vehicle shut down.

Tools Required: J35555 Mighty Vac and J43485 Power Steering Bleeder Adapter

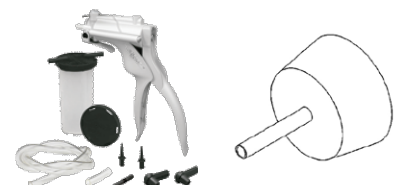

1. Verify that hoses are routed properly. Contact with the frame or engine may cause system noises.
2. Verify all hose connections are tight.
3. Remove the pump reservoir cap.
4. Fill the reservoir to the FULL COLD level.
5. Attach the J-43485 to the J35555 or equivalent.
7. Place the J-43485 on to the reservoir filler neck.
8. Apply a vacuum of 68kPa (20inHg) maximum. Wait 5 minutes.
9. Remove the J-43485 and J-3555 tools.
10. Fill the reservoir to the FULL COLD level. Reinstall the pump reservoir cap. Start the engine. Allow engine to idle.
11. Turn of engine. Verify the fluid level.

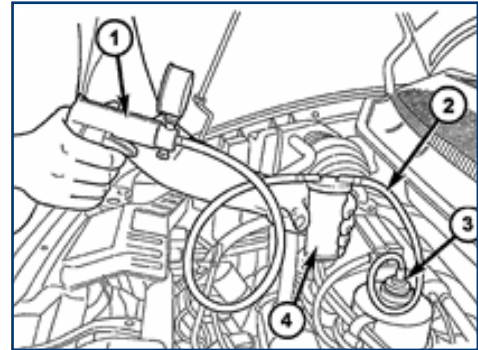

CAUTION: DO NOT TURN STEERING WHEEL LOCK TO LOCK.

12. Start the engine. Allow the engine to idle.
13. Turn the wheel 180-360 degrees in both directions. Do this 5 times.
14. Switch engine off. Verify fluid level.

When adding fluid, or making a complete fluid change, Be sure to use the proper fluid.

This is a quick reference guide. For more detailed information on system operation and servicing, always refer to the technical service manual or approved information system.

STEERING CORE RETURNS

How to Return Cores Responsibly

WHY?

- ELIMINATE safety hazards
- STOP environmental pollution
- INCREASE core credits

How To Return: Steering Gears & Pumps



1 DRAIN

Remove all necessary components from the old unit for installation on the new unit. Drain the OE fluid out of the ports into an approved container.



2 PLUG

Plug or cap the inlet and outlet ports on the drained unit using the supplied caps and plugs from the new unit.

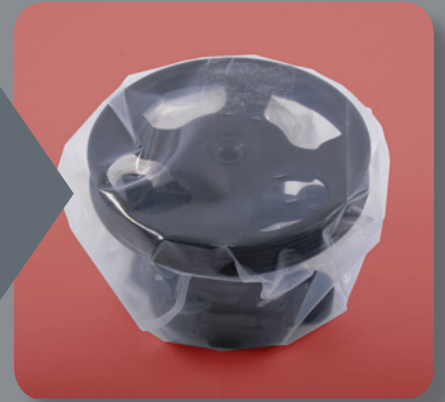

3 BAG

Place the drained and plugged unit into the shipping bag.

Steering Racks

To Return Steering Racks follow steps 1- 2. Due to rack size no bag is provided.

1
DRAIN

2
PLUG

RETURN

STEERING PUMP RESERVOIR INSTALLATION INSTRUCTIONS

NOTE: STEERING RESERVOIRS ARE GUARANTEED TO THE SPECIFIC VEHICLE APPLICATIONS FOR WHICH THEY ARE LISTED. THE FOLLOWING PROCEDURES MUST BE PERFORMED TO ENSURE PROPER INSTALLATION AND TO PROTECT WARRANTY.

1. Disconnect and remove existing reservoir.
2. Install new reservoir. Connect supply and return lines.
3. Verify that hoses are routed properly. Contact with the frame or engine may cause system noises.
4. Verify all hose connections are tight.
5. Remove the pump reservoir cap.
6. Fill the reservoir to the FULL COLD level.
7. Tightly insert rubber vacuum plug onto the pump reservoir.
8. Attach the vacuum pump to the rubber vacuum plug.
9. Apply a vacuum of 60-68kPa (18-20 in Hg) maximum for a minimum of 3 minutes.
10. Slowly release the vacuum.
11. Remove the vacuum pump and rubber plug.
12. Repeat steps #4 through #9 until fluid no longer drops.
13. Fill the reservoir to the FULL COLD level. Reinstall the pump reservoir cap. Start the engine. Allow engine to idle.
14. Turn off engine. Verify the fluid level.
15. Start the engine. Allow the engine to idle.
 - **CAUTION: DO NOT HOLD STEERING WHEEL AT THE LOCK TO LOCK POSITIONS.**
16. Turn the wheel, lock-to-lock, three times.
17. Switch engine off. Verify fluid level. Check for any signs of air in the system. If air is present repeat the procedure as necessary.



INSTRUCTION SHEET

EVO Actuator Replacement

Read instructions before proceeding

NOTE: The original equipment supplier has replaced the EVO actuator with a direct connection. This pump assembly has the new direct connection hardware installed. Union fitting and connector tube makes the EVO actuator NOT Required. See instructions below.



This Direct Connection hardware is the new installation preference going forward by the manufacturer.

IMPORTANT: Tape electrical connector from EVO fitting to the wire harness assembly

INSTALLATION INSTRUCTIONS:

1. Remove power steering pump assembly from vehicle. *
2. Install power steering pump assembly into vehicle. *
3. Flush power steering system. *
4. Bleed power steering system. *
5. Tighten the connector tube to 28 N · m (20 lb. ft).

* For further information reference, consult TBC7903.

26138184

26138184

INSTRUCTION SHEET

FOR EFFECTIVE REPAIR, USE ALL PARTS IN KIT REGARDLESS OF ORIGINAL CONDITION

EVO/TFE Actuator Replacement

Read instructions carefully before proceeding.

- 1** Remove power steering pump assembly from vehicle.*

IMPORTANT: Tape electrical connector from EVO/TFE fitting to the wire harness assembly.

- 2** Remove EVO/TFE actuator and discharge fitting from the power steering pump assembly.

- 3** Clean area on pump assembly of dirt and debris.

- 4** Lubricate o-rings with power steering fluid. Install union fitting assembly into pump assembly.

Tighten the fitting assembly to 75 N·m (55 lb ft).

- 5** Lubricate o-ring with power steering fluid. Install connector tube to union fitting.

Tighten the connector tube to 28 N·m (20 lb ft).

NOTE: With installation of union fitting and connector tube the installation of EVO/TFE actuator and discharge fitting is not required.

- 6** Install power steering pump assembly into vehicle.*

- 8** Bleed power steering system.*

- 7** Flush power steering system.*

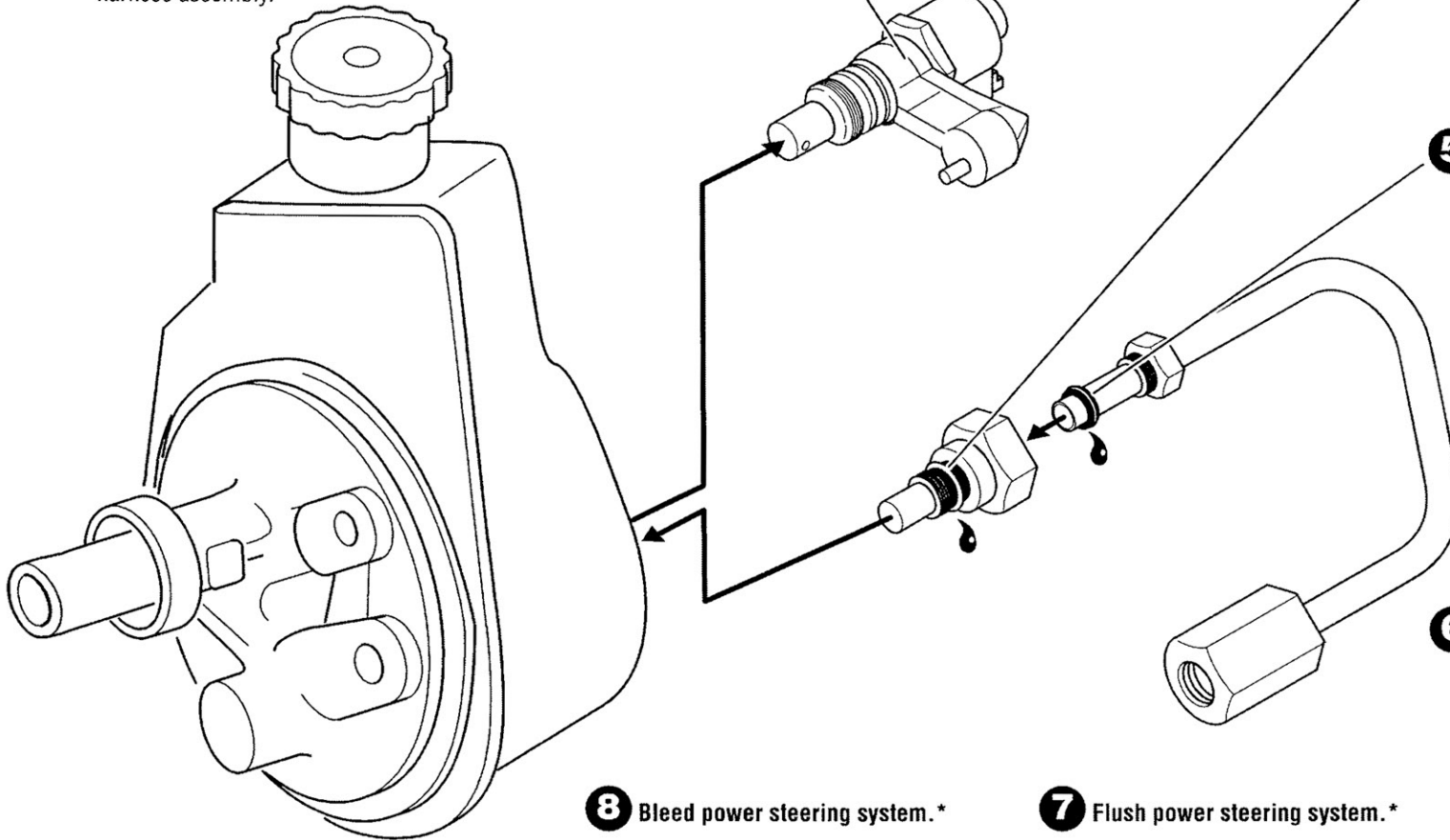

IMPORTANT NOTICE

The replacement unit may appear different than Original Equipment (OE).
The fit and function of the replacement unit matches the OE design.

ATTENTION INSTALLER

Install supplied O-ring as shown.

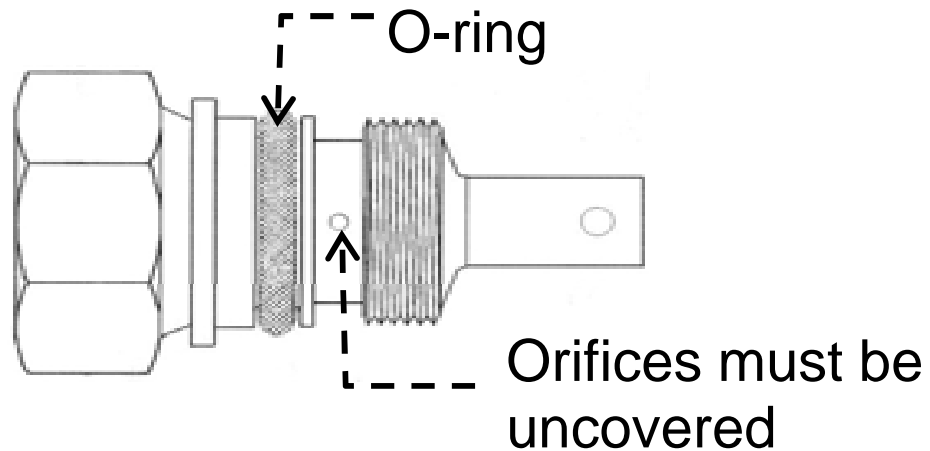

Note: For core credit, noted hardware must accompany core.