

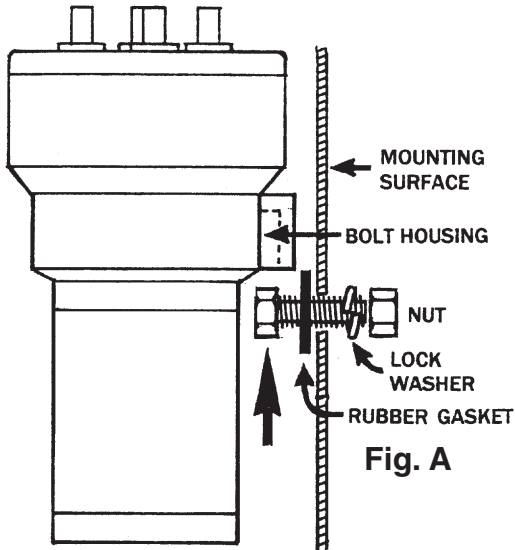

INSTALLATION INSTRUCTIONS FOR MUSICAL AIR HORNS - 4 TRUMPETS

The addition of a Wolo horn kit in your vehicle will provide an extra level of sound. The Wolo name, with more than twenty years experience, is your guarantee of a superior horn product.



1. Install the compressor in the engine compartment in a dry location and safe from engine exhaust manifold heat. To secure the compressor, drill a 3/16-inch hole through metal and mount compressor vertically (air outlets at the top). Insert head of bolt into the bolt housing and secure to the vehicle referring to Figure A. Use mounting hardware in the order shown – bolt, rubber gasket, mounting surface, lock washer, nut.

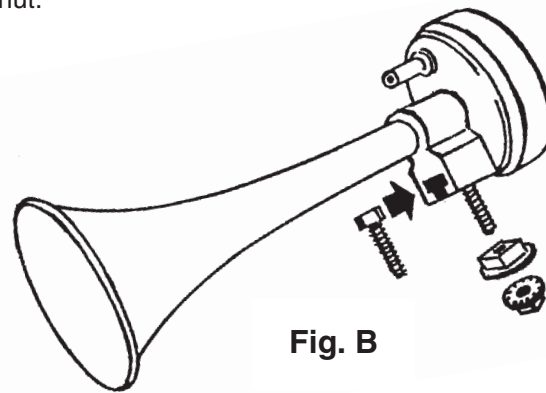

2. Position each trumpet with open end facing down, mark and drill a 1/4-inch hole for each trumpet. Secure to vehicle referring to Figure B. Use mounting hardware in order shown - spacer, lock washer/nut.

3. **IMPORTANT:** Mount trumpets with the open ends facing down. This will prevent water from entering into the trumpets and compressor. **Water damage to the horn's component parts is not covered by our factory warranty.**

4. Using plastic air tubing included in the kit, cut to proper length and install referring to Figure C. The inlet fitting on each trumpet has a colored ring. When connecting the plastic tubing, mate with the same color ring on the compressor outlet fitting. **CAUTION:** Avoid making any kinks or sharp bends in tubing that will restrict the airflow and alter the horn's sound.

5. The compressor should be oiled every four to six months. Unbolt the compressor and place four to six drops of oil into the opening of the bolt housing which is the air intake for the compressor. If you are unable to unbolt the compressor remove one of the hoses from the compressor and place four to six drops of oil into the outlet. For best result use 10W, WD-40, air tool oil or any light weight oil.

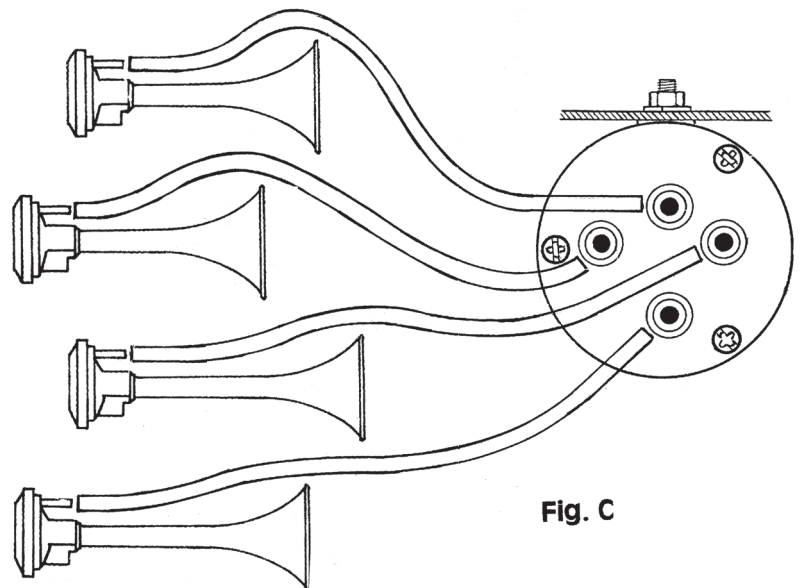

ELECTRICAL CONNECTIONS USING VEHICLE'S FACTORY HORN SWITCH

For a vehicle with a (2) wire system: If vehicle's factory horn has two (2) terminals, simply transfer the wires to the terminals on the bottom of the compressor. **IMPORTANT:** when testing the horns, if compressor motor turns on but the horn does not sound, reverse the wires connected at the bottom of the compressor.

For a vehicle with a (1) wire system: If vehicle's factory horn has one (1) terminal, simply transfer wire to the compressor's positive (+) terminal on bottom of compressor. The compressor's negative terminal is connected to any metal body ground. Connection should be free of rust or paint.

ELECTRICAL CONNECTIONS FOR A NEW HORN BUTTON SWITCH:

Install the relay in a dry location with the terminals facing downward near the compressor. Refer to Figure D for wiring.

- A. Connect relay terminal 87 to the positive terminal at the bottom of the compressor. Use no less than a 16-gauge wire.
- B. Connect relay terminal 85 to the horn switch terminal. The other horn switch terminal is connected to ground (body of vehicle). An 18-gauge wire is suggested for this connection.
- C. Connect relay terminals 30/86 to positive (+) 12-volt battery, alternator or accessories. Use 16-gauge or heavier wire. A 20-ampere fuse is suggested to be installed as shown in Figure D.

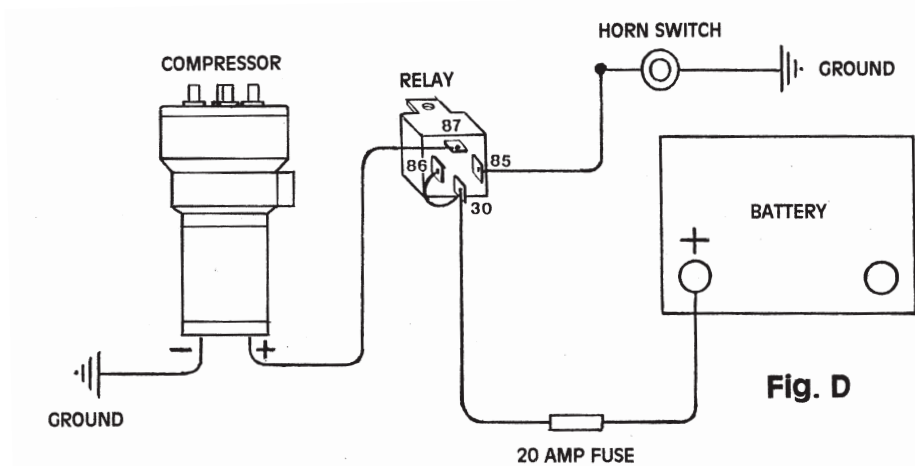

RECAP OF TERMINAL CONNECTIONS

Terminals 30/86: the two (2) terminals are connected to 12-volt positive (+) using a fuse.
Terminal 85: connect horn switch negative (-).
Terminal 87: connect positive (+) terminal of compressor.