



**XSCORPION**

# TABLE OF CONTENT

## Power Distribution Block. (EXPERT LINK)

MINI ANL Power <a href="#">Distribution Block</a> .....	5
AGU Power Distribution Block.....	8
MAXI Power Distribution Block.....	10
ANL Power Distribution Block.....	12

## PWR.GND.Distribution Block. Battery Terminal

Power. Ground Distribution Block.....	14
Battery Terminal.....	16

## Power Distribution Block. (INSTALLER SERIES)

MINI ANL Power Distribution Block.....	18
AGU Power Distribution Block.....	19

## FUSE. Diode. Resistor. Capacitor

MINI ANL, ANL.....	20
AGU.....	21
MAXI, ATC, SHORT LEG.....	22
Mini, AGC, Diode, Resistor, NP Capacitor.....	23

## Cable

Power. Ground Cable.....	24
Speaker Cable.....	26
Primary Cable.....	27

## RCA Cable. Power Amp Kit

RCA Audio Video Cable.....	28
RCA Audio Cable.....	28
Phono Plug.....	29
Power Amp Kit.....	30
Cable Kit.....	32

## Capacitor. Accessory. Switch. Terminal

Hybrid Capacitor.....	33
Fan, Fan Protection Grill, Digital Voltmeter, Digital Amp & Volt Meter.....	34
Circuit Breaker, Isolater, Relay.....	35
Converter, Ground Loop Isolator, POP Eliminator.....	36
Bass Blocker, Connector, Switch, LED, Pin Switch.....	37
In Line Wired Fuse Holder, Expandable Braided Sleeving, Heat Shrink Tubing, Split Loom Tubing.....	39
Cable Tie, Screw, Hook & Loop, Tape, Glue Stick, Barrier	
Terminal Strip, Bussbar.....	40
Terminal.....	41

## Fabric

Ensemble Carpet, Trunk Liner Carpet, Grille Cloth.....	44
Premium Automotive Trim Carpet (Un-Backed).....	45

## Rattle Block / Sound Deadening

Rattle Block / Sound Deadening.....	46
Rattle Block Roller.....	47

## Tools. Removal Key

Tool.....	48
Removal Key.....	50

## SMD Strip LED

51

## Enclosure

Vented.....	53-55
Sealed.....	53-55
Bandpass.....	55
Vehicle Specific.....	56
Enclosure Accessory.....	61
Promotional Item.....	61

## Mounting Dash Kits Applicaion Guide

62

## Product Locator & Vehicle Application Reference

99

## Car Stereo Mounting Dash Kits

105

## Wiring Harness

BMW, Chrysler, Chrysler Import, Daewoo.....	122
Dodge, Euro, Ford.....	123
GM.....	124
Honda, Hyundai.....	127
Kia, Isuzu, Jeep, Mazda.....	128
Mitsubishi, Nissan, SmartCar, Subaru.....	129
Suzuki, Toyota, Volvo, VW.....	130
Alpine, Clarion, JVC, Kenwood, Pioneer, Sony.....	131
External Power Harness.....	132
Auxiliary Harness.....	133

## Antenna Adapter

Chrysler, Euro, Ford, GM.....	135
Honda, Hyundai, Kia, Lexus, Nissan.....	136
Subaru, Universal.....	137
VW, Volvo.....	138

# MINI ANL IN - LINE FUSE HOLDER

**EXPERT LINK<sup>®</sup>**

## INTRODUCING THE SAFEST & SMALLEST ULTRA HIGH POWER FUSE HOLDER AVAILABLE

No longer is there a need for large space consuming power blocks. The new mini ANL allows power transfer to equal any other block, while using half the space. From single to quad outputs.

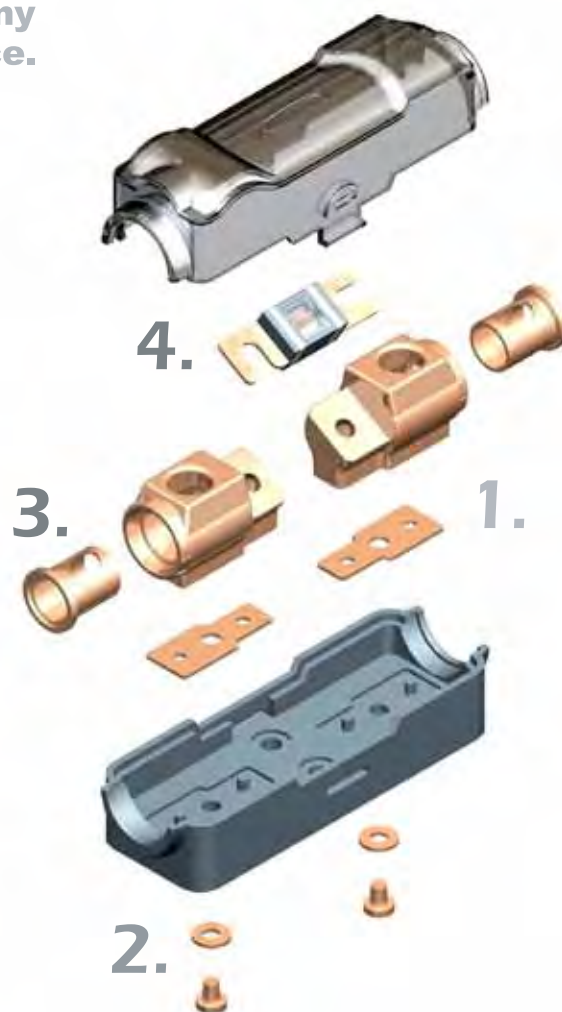

1. Non-Conducting Heat Dissipating Insulator
2. Non-Conducting O Ring Heat Dissipating Insulator
3. Patented Ring Adapter from 1/0 to 2 ga.
4. Smallest Ultra High Power Fuse in the Market with LED Indicator Ranging from 30 to 300 AMP.

# MINI ANL INLINE FUSE HOLDERS

## PATENTED 0/2/4 GAUGE ADAPTER RING

Designed to fit 1/0, 2 & 4 ga. Power Cable

## PATENTED 4/8 GAUGE ADAPTER RING

Designed to fit 4 or 8 ga. Power Cable

## CONNECTING FASTENERS

Uniquely designed to secure fuses in place for ultimate performance, accurate contact & voltage loss prevention.

## TERMINAL MOUNTING STRUCTURE

High temperature composite terminal base for high current transfer capability

### MINI ANL Inline Fuse Holders

<b>AMA48P</b>	0 / 2 / 4 / 8 ga. In & Out	PLATINUM
<b>AMA48G</b>	0 / 2 / 4 / 8 ga. In & Out	GOLD
<b>CMANL48P</b>	4/8 ga. In & Out (compact size)	PLATINUM
<b>CMANL48G</b>	4/8 ga. In & Out (compact size)	GOLD
<b>MANL02P</b>	0/2 ga. In & Out with Adapters	PLATINUM
<b>MANL02G</b>	0/2 ga. In & Out with Adapters	GOLD



# MINI ANL DISTRIBUTION BLOCKS

INTRODUCING OUR NEWEST MINI ANL FUSE WITH LED INDICATOR, RANGING FROM 30 TO 300 AMP. THE EASY WAY TO BE SURE YOUR POWER IS FLOWING.

## MINI ANL Distribution Blocks

<b>MANL3024P</b>	Three 0/2/4 ga. In. Two 4/8 ga. Out with Adapters	PLATINUM
<b>MANL3024G</b>	Three 0/2/4 ga. In. Two 4/8 ga. Out with Adapters	GOLD
<b>MANL3034P</b>	Three 0/2/4 ga. In. Three 4/8 ga. Out with Adapters	PLATINUM
<b>MANL3034G</b>	Three 0/2/4 ga. In. Three 4/8 ga. Out with Adapters	GOLD
<b>MANL3044P</b>	Three 0/2/4 ga. In. Four 4/8 ga. Out with Adapters	PLATINUM
<b>MANL3044G</b>	Three 0/2/4 ga. In. Four 4/8 ga. Out with Adapters	GOLD

## Digital MINI ANL Distribution Blocks

<b>DMANL3024P</b>	Three 0/2/4 ga. In & Two 4/8 ga. Out with Adapters	PLATINUM
<b>DMANL3024G</b>	Three 0/2/4 ga. In & Two 4/8 ga. Out with Adapters	GOLD
<b>DMANL3034P</b>	Three 0/2/4 ga. In & Three 4/8 ga. Out with Adapters	PLATINUM
<b>DMANL3034G</b>	Three 0/2/4 ga. In & Three 4/8 ga. Out with Adapters	GOLD

NOTE: Each package includes one Input Adapter and all Output Adapters.

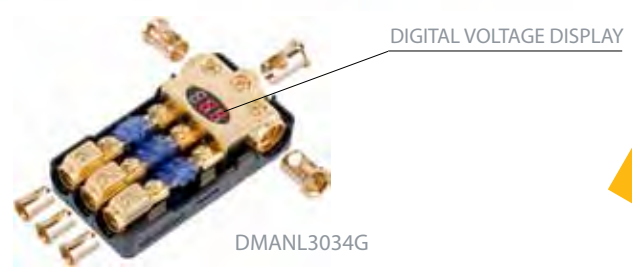
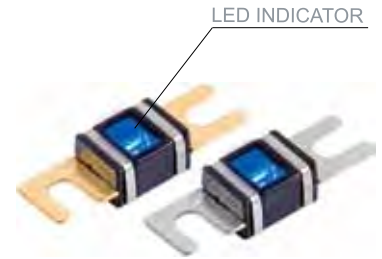

# AGU INLINE FUSE HOLDERS

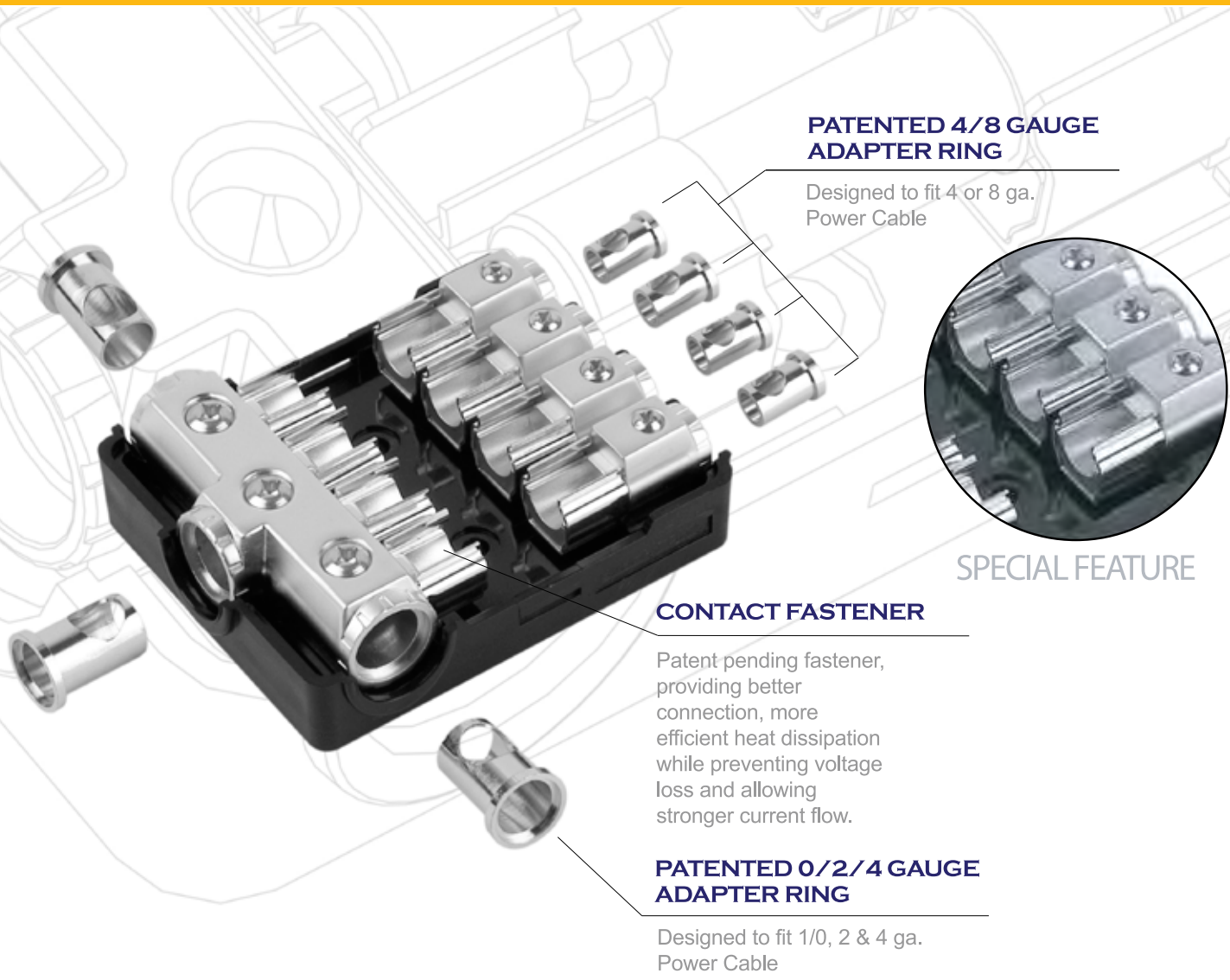

**PATENTED 4/8 GAUGE ADAPTER RING**

Designed to fit 4 or 8 ga. Power Cable



SPECIAL FEATURE

**CONTACT FASTENER**

Patent pending fastener, providing better connection, more efficient heat dissipation while preventing voltage loss and allowing stronger current flow.

**PATENTED 0/2/4 GAUGE ADAPTER RING**

Designed to fit 1/0, 2 & 4 ga. Power Cable

**AGU Inline Fuse Holders**

<b>AGU48P</b>	4/8 ga. In & Out with Adapters	PLATINUM
<b>AGU48G</b>	4/8 ga. In & Out with Adapters	GOLD



AGU

8

XSCORPION

# AGU DISTRIBUTION BLOCKS

INTRODUCING OUR NEWEST AGU FUSE WITH LED INDICATOR, RANGING FROM 30 TO 100 AMP. THE EASY WAY TO BE SURE YOUR POWER IS FLOWING.

## AGU Distribution Blocks

<b>AGU3224P</b>	Three 2/4 ga. In. Two 4/8 ga. Out with Adapters	PLATINUM
<b>AGU3224G</b>	Three 2/4 ga. In. Two 4/8 ga. Out with Adapters	GOLD
<b>AGU3234P</b>	Three 2/4 ga. In. Three 4/8 ga. Out with Adapters	PLATINUM
<b>AGU3234G</b>	Three 2/4 ga. In. Three 4/8 ga. Out with Adapters	GOLD
<b>AGU3044P</b>	Three 0/2/4 ga. In. Four 4/8 ga. Out with Adapters	PLATINUM
<b>AGU3044G</b>	Three 0/2/4 ga. In. Four 4/8 ga. Out with Adapters	GOLD

## Digital AGU Distribution Blocks

<b>DAGU3224P</b>	Three 2/4 ga. In & Two 4/8 ga. Out with Adapters	PLATINUM
<b>DAGU3224G</b>	Three 2/4 ga. In & Two 4/8 ga. Out with Adapters	GOLD
<b>DAGU3234P</b>	Three 2/4 ga. In & Three 4/8 ga. Out with Adapters	PLATINUM
<b>DAGU3234G</b>	Three 2/4 ga. In & Three 4/8 ga. Out with Adapters	GOLD

NOTE: Each package includes one Input Adapter and all Output Adapters.

LED INDICATOR



**INNOVATIVE  
DESIGNS THAT  
SET US APART  
FROM THE REST**



AGU3224G



AGU3234G



AGU3044G



AGU3224P



AGU3234P



AGU3044P

DIGITAL VOLTAGE DISPLAY



DAGU3224G

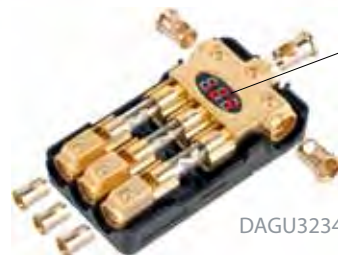

DAGU3234G

DIGITAL VOLTAGE DISPLAY



DAGU3224P



DAGU3234P

# AGU

Your Source of Ultimate Technology

# POWER DISTRIBUTION BLOCK

Patented - All Rights Reserved by Xscorpion

# MAXI DISTRIBUTION BLOCKS

## CONNECTING FASTENERS

Uniquely designed to secure fuses in place for ultimate performance, accurate contact & voltage loss prevention.

## PATENTED 4/8 GAUGE ADAPTER RING

Designed to fit 4 or 8 ga. Power Cable

## TERMINAL MOUNTING STRUCTURE

High temperature composite terminal base for high current transfer capability.

## PATENTED 2/4 GAUGE ADAPTER RING

Designed to fit 2 or 4 ga. Power Cable



MAXI

10

XSCORPION



# MAXI DISTRIBUTION BLOCKS

FEATURING OUR LINE OF MAXI FUSES RANGING FROM 30 TO 120 AMP.

## Top Loading MAXI In line Fuse Holders & Distribution Blocks

<b>MAX48P</b>	4/8 ga. In & Out with Adapters	PLATINUM
<b>MAX48G</b>	4/8 ga. In & Out with Adapters	GOLD
<b>MAX24P</b>	2/4 ga. In & Out with Adapters	PLATINUM
<b>MAX24G</b>	2/4 ga. In & Out with Adapters	GOLD
<b>XFHT48P</b>	4/8 ga. In & Out with Adapters, Top Loading	PLATINUM
<b>XFHT48G</b>	4/8 ga. In & Out with Adapters, Top Loading	GOLD
<b>MAX3224P</b>	Three 2/4 ga. In. Two 4/8 ga. Out with Adapters	PLATINUM
<b>MAX3224G</b>	Three 2/4 ga. In. Two 4/8 ga. Out with Adapters	GOLD
<b>MAX3234P</b>	Three 2/4 ga. In. Three 4/8 ga. Out with Adapters	PLATINUM
<b>MAX3234G</b>	Three 2/4 ga In Three 4/8 ga Out with Adapters	GOLD

NOTE: Each package includes one Input Adapter and all Output Adapters.



MAX48G



MAX24G



XFHT48G



MAX48P



MAX24P



XFHT48P



MAX3224G



MAX3234G



MAX3224P



MAX3234P

# MAXI

Your Source of Ultimate Technology

# POWER DISTRIBUTION BLOCK

Patented - All Rights Reserved by Xscorpion

# ANL INLINE FUSE HOLDERS

## CONNECTING FASTENERS

Uniquely designed to secure fuses in place for ultimate performance, accurate contact & voltage loss prevention.

## PATENTED 0/2 GAUGE ADAPTER RING

Designed to fit 1/0 & 2 ga. Power Cable

## TERMINAL MOUNTING STRUCTURE

High temperature composite terminal base for high current transfer capability

## PATENTED 0/2 GAUGE ADAPTER RING

Designed to fit 1/0 & 2 ga. Power Cable

## 0/2/4 ga. In & Out Inline Fuse Holders

<b>ANL02P</b>	0/2 ga. In & Out with Adapters	PLATINUM
<b>ANL02G</b>	0/2 ga. In & Out with Adapters	GOLD
<b>ANL4040P</b>	0/2 ga. In & Out with Adapters	PLATINUM
<b>ANL4040G</b>	0/2 ga. In & Out with Adapters	GOLD

## Digital 0/2/4 ga. In & Out Inline Fuse Holders

<b>DANL4040P</b>	0/2 ga. In & Out with Adapters	PLATINUM
<b>DANL4040G</b>	0/2 ga. In & Out with Adapters	GOLD



# ANL DISTRIBUTION BLOCKS

INTRODUCING OUR NEW ANL FUSE WITH LED INDICATOR, RANGING FROM 80 TO 300 AMP. THE EASY WAY TO BE SURE YOUR POWER IS FLOWING.

## 0/2/4 ga. In & Out Inline Fuse Holders & Distribution Blocks

<b>ANL2020P</b>	0/2 ga. In & Out with Adapters	PLATINUM
<b>ANL2020G</b>	0/2 ga In & Out with Adapters	GOLD
<b>ANL2010P</b>	0/2 ga. In & Out with Adapters	PLATINUM
<b>ANL2010G</b>	0/2 ga. In & Out with Adapters	GOLD
<b>ANL1010P</b>	0/2/4 ga. In & Out	PLATINUM
<b>ANL1010G</b>	0/2/4 ga. In & Out	GOLD
<b>ANL3022P</b>	Three 0/2 ga. In, Two 2/4 ga. Out with Adapters	PLATINUM
<b>ANL3022G</b>	Three 0/2 ga. In, Two 2/4 ga. Out with Adapters	GOLD
<b>ANL3032P</b>	One 1/0 ga.&Two 2 ga. In, Three 4 ga. Out	PLATINUM
<b>ANL3032G</b>	One 1/0 ga.&Two 2 ga. In, Three 4 ga. Out	GOLD
<b>ANL3042P</b>	One 1/0 ga.&Two 2 ga. In, Four 4 ga. Out	PLATINUM
<b>ANL3042G</b>	One 1/0 ga.&Two 2 ga. In, Four 4 ga. Out	GOLD



ANL2020G



ANL2010G



ANL1010G



ANL2020P



ANL2010P



ANL1010P



ANL3022G



ANL3032G



ANL3042G



ANL3022P



ANL3032P



ANL3042P

# DIGITAL POWER. GROUND DISTRIBUTION BLOCKS

## Digital Power Distribution Block

<b>DGDB2048P</b>	One 0/2 ga. In. One 2/4 ga., One 4/8 ga. & Two 8 ga. Out with Adapters	PLATINUM
<b>DGDB2048G</b>	One 0/2 ga. In. One 2/4 ga., One 4/8 ga. & Two 8 ga. Out with Adapters	GOLD
<b>DGDB10248P</b>	One 0/2 ga. In. One 2/4 ga., Two 4/8 ga. & Two 8 ga. Out	PLATINUM
<b>DGDB10248G</b>	One 0/2 ga. In. One 2/4 ga., Two 4/8 ga. & Two 8 ga. Out	GOLD



DGDB0248G



DGDB0248P



DGDB10248G



DGDB10248P

## Power. Ground Distribution Blocks

<b>GDB20248P</b>	Two 0 ga. In. One 0 ga., One 2 ga., Two 4ga. & Two 8 ga. Out	PLATINUM
<b>GDB20248G</b>	Two 0 ga. In. One 0 ga., One 2 ga., Two 4ga. & Two 8 ga. Out	GOLD
<b>GDB10248P</b>	One 1/0 ga. In. One 2 ga., Two 4 ga. & Two 8 ga. Out	PLATINUM
<b>GDB10248G</b>	One 1/0 ga. In. One 2 ga., Two 4 ga. & Two 8 ga. Out	GOLD
<b>GDB0248P</b>	One 0/2 ga. In. One 2/4 ga., One 4 ga. & Two 8 ga. Out with Adapters	PLATINUM
<b>GDB0248G</b>	One 0/2 ga. In. One 2/4 ga., One 4 ga. & Two 8 ga. Out with Adapters	GOLD
<b>GDBRP</b>	Any Gauge In & Out Power Cable (with Ring Terminals)	PLATINUM
<b>GDBRG</b>	Any Gauge In & Out Power Cable (with Ring Terminals)	GOLD
<b>GDB1248P</b>	One 2/4 ga. with Adapter In. Four 8 ga. Out	PLATINUM
<b>GDB1248G</b>	One 2/4 ga. with Adapter In. Four 8 ga. Out	GOLD

NOTE: Ring Terminals are not included



GDB20248G



GDB10248G



GDB0248G



GDB20248P



GDB10248P



GDB0248P



GDBRG



GDBRP



GDB1248P



GDB1248G

# POWER. GROUND DISTRIBUTION BLOCKS

## Terminal Blocks

<b>TB000P</b>	Three 0/2 ga. with Adapters	PLATINUM
<b>TB000G</b>	Three 0/2 ga. with Adapters	GOLD
<b>TB4444P</b>	Four 4/8 ga. with Adapters	PLATINUM
<b>TB4444G</b>	Four 4/8 ga. with Adapters	GOLD
<b>TB0444P</b>	One 0/2 ga. & Three 4/8 ga. with Adapters	PLATINUM
<b>TB0444G</b>	One 0/2 ga. & Three 4/8 ga. with Adapters	GOLD
<b>TB048LP</b>	One 0/2 ga., One 4/8 ga. with Adapters & Four 8 ga. on Left	PLATINUM
<b>TB048LG</b>	One 0/2 ga., One 4/8 ga. with Adapters & Four 8 ga. on Left	GOLD
<b>TB048RP</b>	One 0/2 ga., One 4/8 ga. with Adapters & Four 8 ga. on Right	PLATINUM
<b>TB048RG</b>	One 0/2 ga., One 4/8 ga. with Adapters & Four 8 ga. on Right	GOLD



## Power. Ground Distribution Blocks

<b>GDB2034P</b>	Two 0/2 ga. In with Adapters Three 4 ga. Out	PLATINUM
<b>GDB2034G</b>	Two 0/2 ga. In with Adapters Three 4 ga. Out	GOLD
<b>GDB2088P</b>	Two 0/2 ga. In with Adapters Eight 8 ga. Out	PLATINUM
<b>GDB2088G</b>	Two 0/2 ga. In with Adapters Eight 8 ga. Out	GOLD



# DIGITAL BATTERY TERMINALS

## CRYSTAL CLEAR ACRYLIC COVER

Protects from surrounding environments damage

## TWO OF ANY GA. CABLES

Use two any gauge cables with ring terminals

## THREE DIGIT VOLTMETER

Digital display ranging from 10.0 to 20.0 Volts

## TWO 4 GAUGE OUTPUTS

### Battery Terminals

<b>DBT24RP</b>	Two 4 ga. & Two Any ga. Cable with Ring Terminal (Digital)	PLATINUM
<b>DBT24RG</b>	Two 4 ga. & Two Any ga. Cable with Ring Terminal (Digital)	GOLD
<b>DBT024RP</b>	One 1/0 ga. Two 4 ga. & Two Any ga. Cable with Ring Terminal (Digital)	PLATINUM
<b>DBT024RG</b>	One 1/0 ga. Two 4 ga. & Two Any ga. Cable with Ring Terminal (Digital)	GOLD
<b>BTRP</b>	Accepts any ga. Cable with Ring Terminal (Includes Positive to Negative Adapter)	PLATINUM
<b>BTRG</b>	Accepts any ga. Cable with Ring Terminal (Includes Positive to Negative Adapter)	GOLD
<b>BT0288P</b>	One 0/2 ga. , One 2/4 ga. with Adapters & Two 8 ga. (Includes Positive to Negative Adapter)	PLATINUM
<b>BT0288G</b>	One 0/2 ga. , One 2/4 ga. with Adapters & Two 8 ga. (Includes Positive to Negative Adapter)	GOLD
<b>BT1224P</b>	One 2/4 ga. , & Two 4/8 ga. with Adapters (Includes Positive to Negative Adapter)	PLATINUM
<b>BT1224G</b>	One 2/4 ga. , & Two 4/8 ga. with Adapters (Includes Positive to Negative Adapter)	GOLD

NOTE: Ring Terminals are not included



DBT24RG



DBT24RP



DBT024RG



DBT024RP



BTRG



BT0288G  
(Includes Clear Cover)



BT1224G



BTRP



BT0288P  
(Includes Clear Cover)



BT1224P

# BATTERY TERMINALS

## Ring Terminals

<b>RT4P</b>	One 4/8 ga. Out with Adapter	PLATINUM
<b>RT4G</b>	One 4/8 ga. Out with Adapter	GOLD
<b>RT0P</b>	One 0/2 ga. Out with Adapter	PLATINUM
<b>RT0G</b>	One 0/2 ga. Out with Adapter	GOLD
<b>RT44P</b>	Two 4/8 ga. Out with Adapters	PLATINUM
<b>RT44G</b>	Two 4/8 ga. Out with Adapters	GOLD
<b>RT00P</b>	Two 0/2 ga. Out with Adapters	PLATINUM
<b>RT00G</b>	Two 0/2 ga. Out with Adapters	GOLD



## Ground Terminals

<b>GT48P</b>	4/8 ga. Out with Adapter	PLATINUM
<b>GT48G</b>	4/8 ga. Out with Adapter	GOLD
<b>GT02P</b>	0/2 ga. Out with Adapter	PLATINUM
<b>GT02G</b>	0/2 ga. Out with Adapter	GOLD



## GM Battery Terminal Posts

<b>BTP-ESP</b>	Short - Extender	PLATINUM
<b>BTP-ESG</b>	Short - Extender	GOLD
<b>BTP-ELP</b>	Long - Extender	PLATINUM
<b>BTP-ELG</b>	Long - Extender	GOLD
<b>BTPSP</b>	Short	PLATINUM
<b>BTPSG</b>	Short	GOLD
<b>BTPLP</b>	Long	PLATINUM
<b>BTPLG</b>	Long	GOLD



## Ring Terminals

<b>RT4/8P</b>	4/8 ga. Out with Adapter	PLATINUM
<b>RT4/8G</b>	4/8 ga. Out with Adapter	GOLD
<b>RT0/2P</b>	0/2 ga. Out with Adapter	PLATINUM
<b>RT0/2G</b>	0/2 ga. Out with Adapter	GOLD



# MINI ANL DISTRIBUTION BLOCKS

MINI ANL FUSE RANGING FROM 30 TO 175 AMP

## Low Profile MINI ANL Fuse Power Distribution Block

<b>SMADB3228P</b>	One 2/4/8 ga. & Two 4/8 ga. In, Two 8/10 ga. Out	PLATINUM
<b>SMADB3228G</b>	One 2/4/8 ga. & Two 4/8 ga. In, Two 8/10 ga. Out	GOLD
<b>SMADB3238P</b>	One 2/4/8 ga. & Two 4/8 ga. In, Three 8/10 ga. Out	PLATINUM
<b>SMADB3238G</b>	One 2/4/8 ga. & Two 4/8 ga. In, Three 8/10 ga. Out	GOLD
<b>SMADB3248P</b>	One 2/4/8 ga. & Two 4/8 ga. In, Four 8/10 ga. Out	PLATINUM
<b>SMADB3248G</b>	One 2/4/8 ga. & Two 4/8 ga. In, Four 8/10 ga. Out	GOLD



SMADB3228G



SMADB3238G



SMADB3248G



SMADB3228P



SMADB3238P



SMADB3248P

## Mini ANL In-Line Fuse Holders

<b>MFHT48P</b>	4/8 ga. In/Out with Adapters, Top Loading	PLATINUM
<b>MFHT48G</b>	4/8 ga. In/Out with Adapters, Top Loading	GOLD
<b>MFH48P</b>	4/8 ga. In/Out with Adapters, Weather Proof	PLATINUM
<b>MFH48G</b>	4/8 ga. In/Out with Adapters, Weather Proof	GOLD



MFHT48G



MFHT48P



MFH48G



MFH48P



# AGU DISTRIBUTION BLOCKS

AGU FUSES RANGING FROM 30 TO 100 AMP



## Low Profile AGU Fuse Power Distribution Block

<b>SAGDB3228P</b>	One 2/4/8 ga. & Two 4/8 ga. In, Two 8/10 ga. Out	PLATINUM
<b>SAGDB3228G</b>	One 2/4/8 ga. & Two 4/8 ga. In, Two 8/10 ga. Out	GOLD
<b>SAGDB3238P</b>	One 2/4/8 ga. & Two 4/8 ga. In, Three 8/10 ga. Out	PLATINUM
<b>SAGDB3238G</b>	One 2/4/8 ga. & Two 4/8 ga. In, Three 8/10 ga. Out	GOLD
<b>SAGDB3248P</b>	One 2/4/8 ga. & Two 4/8 ga. In, Four 8/10 ga. Out	PLATINUM
<b>SAGDB3248G</b>	One 2/4/8 ga. & Two 4/8 ga. In, Four 8/10 ga. Out	GOLD



SAGDB3228G

SAGDB3228P

SAGDB3238G

SAGDB3238P

SAGDB3248G

SAGDB3248P

## AGU In-Line Fuse Holders

<b>FHT48P</b>	4/8 ga. In/Out with Adapters, Top Loading	PLATINUM
<b>FHT48G</b>	4/8 ga. In/Out with Adapters, Top Loading	GOLD
<b>FH48P</b>	4/8 ga. In/Out with Adapters, Weather Proof	PLATINUM
<b>FH48G</b>	4/8 ga. In/Out with Adapters, Weather Proof	GOLD



FHT48G

FHT48P

FH48G

FH48P

## AGU Power Distribution Blocks

<b>PDB1228P</b>	One 2/4 ga. with Adapter In. Two 8 ga. Out	PLATINUM
<b>PDB1228G</b>	One 2/4 ga. with Adapter In. Two 8 ga. Out	GOLD
<b>PDB3238P</b>	Three 2/4 ga. with Adapter In. Three 8 ga. Out	PLATINUM
<b>PDB3238G</b>	Three 2/4 ga. with Adapter In. Three 8 ga. Out	GOLD
<b>PDB3248P</b>	Three 2/4 ga. with Adapter In. Four 8 ga. Out	PLATINUM
<b>PDB3248G</b>	Three 2/4 ga. with Adapter In. Four 8 ga. Out	GOLD

NOTE: Each package includes one Input Adapter.



PDB1228P

PDB1228G

PDB3238P

PDB3238G

PDB3248G

PDB3248P

**AGU** Your Source of Ultimate Technology **POWER DISTRIBUTION BLOCK**

Patented - All Rights Reserved by Xscorpion

### THE SMALLEST FUSE W / THE HIGHEST & WIDEST AMP RANGE FROM 30 TO 300

#### MINI ANL Fuses with LED [ 3pcs / Blister ]

<b>MA30P</b>	30 AMP	PLATINUM
<b>MA30G</b>	30 AMP	GOLD
<b>MA40P</b>	40 AMP	PLATINUM
<b>MA40G</b>	40AMP	GOLD
<b>MA50P</b>	50 AMP	PLATINUM
<b>MA50G</b>	50 AMP	GOLD
<b>MA60P</b>	60 AMP	PLATINUM
<b>MA60G</b>	60 AMP	GOLD
<b>MA70P</b>	70 AMP	PLATINUM
<b>MA70G</b>	70 AMP	GOLD
<b>MA80P</b>	80 AMP	PLATINUM
<b>MA80G</b>	80 AMP	GOLD
<b>MA100P</b>	100 AMP	PLATINUM
<b>MA100G</b>	100 AMP	GOLD
<b>MA125P</b>	125 AMP	PLATINUM
<b>MA125G</b>	125 AMP	GOLD
<b>MA150P</b>	150 AMP	PLATINUM
<b>MA150G</b>	150 AMP	GOLD
<b>MA175P</b>	175 AMP	PLATINUM
<b>MA175G</b>	175 AMP	GOLD
<b>MA200P</b>	200 AMP	PLATINUM
<b>MA200G</b>	200 AMP	GOLD
<b>MA250P</b>	250 AMP	PLATINUM
<b>MA250G</b>	250 AMP	GOLD
<b>MA300P</b>	300 AMP	PLATINUM
<b>MA300G</b>	300 AMP	GOLD

#### ANL Fuses with LED Indicator [Blister]

<b>ANL80PL</b>	80 AMP	PLATINUM
<b>ANL80GL</b>	80 AMP	GOLD
<b>ANL100PL</b>	100 AMP	PLATINUM
<b>ANL100GL</b>	100 AMP	GOLD
<b>ANL150PL</b>	150 AMP	PLATINUM
<b>ANL150GL</b>	150 AMP	GOLD
<b>ANL200PL</b>	200 AMP	PLATINUM
<b>ANL200GL</b>	200 AMP	GOLD
<b>ANL250PL</b>	250 AMP	PLATINUM
<b>ANL250GL</b>	250 AMP	GOLD
<b>ANL300PL</b>	300 AMP	PLATINUM
<b>ANL300GL</b>	300 AMP	GOLD

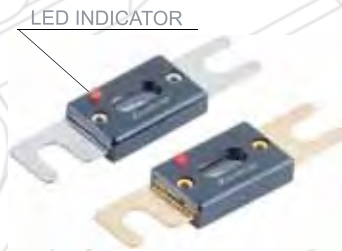

#### ANL Fuses [Blister]

<b>ANL80P</b>	80 AMP	PLATINUM
<b>ANL80G</b>	80 AMP	GOLD
<b>ANL100P</b>	100 AMP	PLATINUM
<b>ANL100G</b>	100 AMP	GOLD
<b>ANL150P</b>	150 AMP	PLATINUM
<b>ANL150G</b>	150 AMP	GOLD
<b>ANL200P</b>	200 AMP	PLATINUM
<b>ANL200G</b>	200 AMP	GOLD
<b>ANL250P</b>	250 AMP	PLATINUM
<b>ANL250G</b>	250 AMP	GOLD
<b>ANL300P</b>	300 AMP	PLATINUM
<b>ANL300G</b>	300 AMP	GOLD

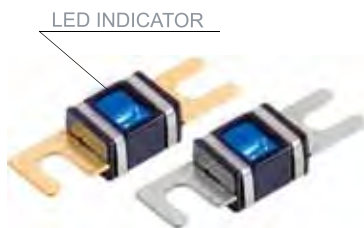

### MINI ANL Fuses [ 3pcs / Blister ]

<b>MANL30P</b>	30 AMP	PLATINUM
<b>MANL30G</b>	30 AMP	GOLD
<b>MANL40P</b>	40 AMP	PLATINUM
<b>MANL40G</b>	40AMP	GOLD
<b>MANL50P</b>	50 AMP	PLATINUM
<b>MANL50G</b>	50 AMP	GOLD
<b>MANL60P</b>	60 AMP	PLATINUM
<b>MANL60G</b>	60 AMP	GOLD
<b>MANL70P</b>	70 AMP	PLATINUM
<b>MANL70G</b>	70 AMP	GOLD
<b>MANL80P</b>	80 AMP	PLATINUM
<b>MANL80G</b>	80 AMP	GOLD
<b>MANL100P</b>	100 AMP	PLATINUM
<b>MANL100G</b>	100 AMP	GOLD
<b>MANL125P</b>	125 AMP	PLATINUM
<b>MANL125G</b>	125 AMP	GOLD
<b>MANL150P</b>	150 AMP	PLATINUM
<b>MANL150G</b>	150 AMP	GOLD
<b>MANL175P</b>	175 AMP	PLATINUM
<b>MANL175G</b>	175 AMP	GOLD

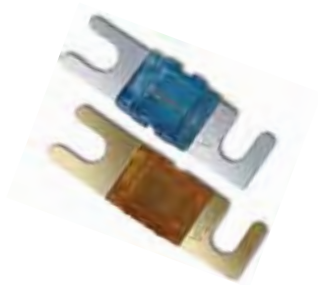

### AGU Fuses with LED Indicator [5pcs / Blister]

<b>AGU30PL</b>	30 AMP	PLATINUM
<b>AGU30GL</b>	30 AMP	GOLD
<b>AGU40PL</b>	40 AMP	PLATINUM
<b>AGU40GL</b>	40 AMP	GOLD
<b>AGU50PL</b>	50 AMP	PLATINUM
<b>AGU50GL</b>	50 AMP	GOLD
<b>AGU60PL</b>	60 AMP	PLATINUM
<b>AGU60GL</b>	60 AMP	GOLD
<b>AGU70PL</b>	70 AMP	PLATINUM
<b>AGU70GL</b>	70 AMP	GOLD
<b>AGU80PL</b>	80 AMP	PLATINUM
<b>AGU80GL</b>	80 AMP	GOLD
<b>AGU100PL</b>	100 AMP	PLATINUM
<b>AGU100GL</b>	100 AMP	GOLD

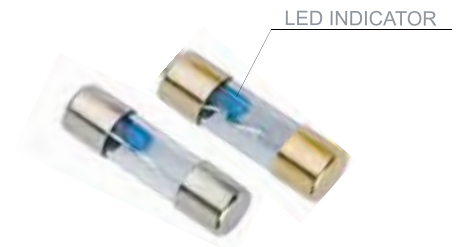

### AGU Fuses [5pcs / Blister]

<b>AGU30P</b>	30 AMP	PLATINUM
<b>AGU30G</b>	30 AMP	GOLD
<b>AGU40P</b>	40 AMP	PLATINUM
<b>AGU40G</b>	40 AMP	GOLD
<b>AGU50P</b>	50 AMP	PLATINUM
<b>AGU50G</b>	50 AMP	GOLD
<b>AGU60P</b>	60 AMP	PLATINUM
<b>AGU60G</b>	60 AMP	GOLD
<b>AGU70P</b>	70 AMP	PLATINUM
<b>AGU70G</b>	70 AMP	GOLD
<b>AGU80P</b>	80 AMP	PLATINUM
<b>AGU80G</b>	80 AMP	GOLD
<b>AGU100P</b>	100 AMP	PLATINUM
<b>AGU100G</b>	100 AMP	GOLD



### MAXI Fuses [Blister]

<b>MX30P</b>	30 AMP	PLATINUM
<b>MX30G</b>	30 AMP	GOLD
<b>MX40P</b>	40 AMP	PLATINUM
<b>MX40G</b>	40 AMP	GOLD
<b>MX50P</b>	50 AMP	PLATINUM
<b>MX50G</b>	50 AMP	GOLD
<b>MX60P</b>	60 AMP	PLATINUM
<b>MX60G</b>	60 AMP	GOLD
<b>MX70P</b>	70 AMP	PLATINUM
<b>MX70G</b>	70 AMP	GOLD
<b>MX80P</b>	80 AMP	PLATINUM
<b>MX80G</b>	80 AMP	GOLD
<b>MX100P</b>	100 AMP	PLATINUM
<b>MX100G</b>	100 AMP	GOLD
<b>MX120P</b>	120 AMP	PLATINUM
<b>MX120G</b>	120 AMP	GOLD



### ATC Fuses with LED Indicator [10pcs / Bag]

<b>ATCF5L</b>	5 AMP	NICKEL
<b>ATCF10L</b>	10 AMP	NICKEL
<b>ATCF15L</b>	15 AMP	NICKEL
<b>ATCF20L</b>	20 AMP	NICKEL
<b>ATCF25L</b>	25 AMP	NICKEL
<b>ATCF30L</b>	30 AMP	NICKEL
<b>ATCF35L</b>	35 AMP	NICKEL

LED INDICATOR

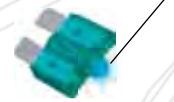

### ATC Fuses [25pcs/ Bag]

<b>ATCF2</b>	2 AMP	NICKEL
<b>ATCF3</b>	3 AMP	NICKEL
<b>ATCF4</b>	4 AMP	NICKEL
<b>ATCF5</b>	5 AMP	NICKEL
<b>ATCF7.5</b>	7.5 AMP	NICKEL
<b>ATCF10</b>	10 AMP	NICKEL
<b>ATCF15</b>	15 AMP	NICKEL
<b>ATCF20</b>	20 AMP	NICKEL
<b>ATCF25</b>	25 AMP	NICKEL
<b>ATCF30</b>	30 AMP	NICKEL
<b>ATCF35</b>	35 AMP	NICKEL
<b>ATCF40</b>	40 AMP	NICKEL



### MAXI Fuses [5pcs/Bag]

<b>MXF30</b>	30 AMP	NICKEL
<b>MXF40</b>	40 AMP	NICKEL
<b>MXF50</b>	50 AMP	NICKEL
<b>MXF60</b>	60 AMP	NICKEL
<b>MXF70</b>	70 AMP	NICKEL
<b>MXF80</b>	80 AMP	NICKEL
<b>MXF100</b>	100 AMP	NICKEL
<b>MXF120</b>	120 AMP	NICKEL



### Short LEG Fuse/Toyota Fuse

<b>SLMINIF10</b>	10 AMP Short Leg Mini Fuse	(10 pcs / Bag)
<b>SLMINIF15</b>	15 AMP Short Leg Mini Fuse	(10 pcs / Bag)
<b>SLMINIF20</b>	20 AMP Short Leg Mini Fuse	(10 pcs / Bag)
<b>SLMINIF25</b>	25 AMP Short Leg Mini Fuse	(10 pcs / Bag)
<b>SLMINIF30</b>	30 AMP Short Leg Mini Fuse	(10 pcs / Bag)



## MINI Fuses [10pcs / Bag]

<b>MINIF2</b>	2 AMP	NICKEL
<b>MINIF3</b>	3 AMP	NICKEL
<b>MINIF4</b>	4 AMP	NICKEL
<b>MINIF5</b>	5 AMP	NICKEL
<b>MINIF7.5</b>	7.5 AMP	NICKEL
<b>MINIF10</b>	10 AMP	NICKEL
<b>MINIF15</b>	15 AMP	NICKEL
<b>MINIF20</b>	20 AMP	NICKEL
<b>MINIF25</b>	25 AMP	NICKEL
<b>MINIF30</b>	30 AMP	NICKEL
<b>MINIF35</b>	35 AMP	NICKEL



## AGC Fuses [10pcs / Bag]

<b>AGCF1</b>	1 AMP	NICKEL
<b>AGCF2</b>	2 AMP	NICKEL
<b>AGCF3</b>	3 AMP	NICKEL
<b>AGCF5</b>	5 AMP	NICKEL
<b>AGCF7.5</b>	7.5 AMP	NICKEL
<b>AGCF10</b>	10 AMP	NICKEL
<b>AGCF15</b>	15 AMP	NICKEL
<b>AGCF20</b>	20 AMP	NICKEL
<b>AGCF25</b>	25 AMP	NICKEL
<b>AGCF30</b>	30 AMP	NICKEL
<b>AGCF35</b>	35 AMP	NICKEL
<b>AGCF40</b>	40 AMP	NICKEL



## DIODES [10pcs / Bag]

<b>DIOD1</b>	1 AMP	DIODE
<b>DIOD3</b>	3 AMP	DIODE
<b>DIOD6</b>	6 AMP	DIODE

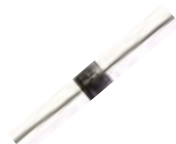

## RESISTORS [50pcs / Bag]

<b>R382</b>	382 ohm	RESISTOR
<b>R523</b>	523 ohm	RESISTOR
<b>R681</b>	681 ohm	RESISTOR
<b>R887</b>	887 ohm	RESISTOR
<b>R1.13K</b>	1.13k	RESISTOR
<b>R1.47K</b>	1.47k	RESISTOR
<b>R1.8K</b>	1.8k	RESISTOR
<b>R2.37K</b>	2.37k	RESISTOR
<b>R3.01K</b>	3.01k	RESISTOR
<b>R3.74K</b>	3.74k	RESISTOR
<b>R4.75K</b>	4.75k	RESISTOR
<b>R6.04k</b>	6.04k	RESISTOR
<b>R7.5K</b>	7.5k	RESISTOR
<b>R9.53K</b>	9.53k	RESISTOR
<b>R11.8K</b>	11.8k	RESISTOR



## NON POLAR CAPACITORS [10pcs / Bag]

<b>NPC2.2</b>	2.2 µf	100V
<b>NPC3.3</b>	3.3 µf	100V
<b>NPC4.7</b>	4.7 µf	100V
<b>NPC6.8</b>	6.8 µf	100V
<b>NPC22</b>	22 µf	100V
<b>NPC47</b>	47 µf	100V
<b>NPC80</b>	80 µf	100V
<b>NPC100</b>	100 µf	100V
<b>NPC125</b>	125 µf	100V
<b>NPC150</b>	150 µf	100V
<b>NPC200</b>	200 µf	100V



# SNAKE SKIN. FLAT POWER. GROUND CABLES



## 1/0 GA. FLAT POWER. GROUND CABLES [EXPERT LINK]

<b>FP0.50BL</b>	1/0 ga. 50 ft.	4214 x .127 mm Strand Count	BLUE
<b>FP0.50R</b>	1/0 ga. 50 ft.	4214 x .127 mm Strand Count	RED
<b>FP0.50P</b>	1/0 ga. 50 ft.	4214 x .127 mm Strand Count	PLATINUM
<b>FG0.50BK</b>	1/0 ga. 50 ft.	4214 x .127 mm Strand Count	BLACK

## 2 GA. FLAT POWER. GROUND CABLES [EXPERT LINK]

<b>FP2.50BL</b>	2 ga. 50 ft.	2646 x .127 mm Strand Count	BLUE
<b>FP2.50R</b>	2 ga. 50 ft.	2646 x .127 mm Strand Count	RED
<b>FP2.50P</b>	2 ga. 50 ft.	2646 x .127 mm Strand Count	PLATINUM
<b>FG2.50BK</b>	2 ga. 50 ft.	2646 x .127 mm Strand Count	BLACK

## 4 GA. FLAT POWER. GROUND CABLES [EXPERT LINK]

<b>FP4.80BL</b>	4 ga. 80 ft.	1666 x .127 mm Strand Count	BLUE
<b>FP4.80R</b>	4 ga. 80 ft.	1666 x .127 mm Strand Count	RED
<b>FP4.80P</b>	4 ga. 80 ft.	1666 x .127 mm Strand Count	PLATINUM
<b>FG4.80BK</b>	4 ga. 80 ft.	1666 x .127 mm Strand Count	BLACK

## 8 GA. FLAT POWER. GROUND CABLES [EXPERT LINK]

<b>FP8.200BL</b>	8 ga. 200 ft.	665 x .127 mm Strand Count	BLUE
<b>FP8.200R</b>	8 ga. 200 ft.	665 x .127 mm Strand Count	RED
<b>FP8.200P</b>	8 ga. 200 ft.	665 x .127 mm Strand Count	PLATINUM
<b>FG8.200BK</b>	8 ga. 200 ft.	665 x .127 mm Strand Count	BLACK



## SNAKE SKIN POWER. GROUND CABLES [EXPERT LINK]

<b>SSP0.50</b>	1/0 ga. 50 ft.	4214 x .127 mm Strand Count	Snake Skin
<b>SSP2.50</b>	2 ga. 50 ft.	2646 x .127 mm Strand Count	Snake Skin
<b>SSP4.80</b>	4 ga. 80 ft.	1666 x .127 mm Strand Count	Snake Skin
<b>SSP8.200</b>	8 ga. 200 ft.	665 x .127 mm Strand Count	Snake Skin

# POWER. GROUND CABLES



## Power. Ground Cables [Expert Link]

1/0 ga. 4214 x .127mm Strand Count

<b>PW0.50BL</b>	1/0 ga. 50 ft.	BLUE
<b>PW0.50R</b>	1/0 ga. 50 ft.	RED
<b>PW0.50P</b>	1/0 ga. 50 ft.	PLATINUM
<b>GW0.50BK</b>	1/0 ga. 50 ft.	BLACK



## Power. Ground Cables [Installer Series]

<b>P4.100BL</b>	4 ga. 100 ft.	BLUE
<b>P4.100R</b>	4 ga. 100 ft.	RED
<b>P4.100P</b>	4 ga. 100 ft.	PLATINUM
<b>G4.100BK</b>	4 ga. 100 ft.	BLACK



2 ga. 2646 x .127mm Strand Count

<b>PW2.50BL</b>	2 ga. 50 ft.	BLUE
<b>PW2.50R</b>	2 ga. 50 ft.	RED
<b>PW2.50P</b>	2 ga. 50 ft.	PLATINUM
<b>GW2.50BK</b>	2 ga. 50 ft.	BLACK



<b>P8.250BL</b>	8 ga. 250 ft.	BLUE
<b>P8.250R</b>	8 ga. 250 ft.	RED
<b>P8.250P</b>	8 ga. 250 ft.	PLATINUM
<b>G8.250BK</b>	8 ga. 250 ft.	BLACK



4 ga. 1666 x .127mm Strand Count

<b>PW4.80BL</b>	4 ga. 80 ft.	BLUE
<b>PW4.80R</b>	4 ga. 80 ft.	RED
<b>PW4.80P</b>	4 ga. 80 ft.	PLATINUM
<b>GW4.80BK</b>	4 ga. 80 ft.	BLACK



<b>P10.400BL</b>	10 ga. 400 ft.	BLUE
<b>P10.400R</b>	10 ga. 400 ft.	RED
<b>G10.400BK</b>	10 ga. 400 ft.	BLACK



8 ga. 665 x .127mm Strand Count

<b>PW8.200BL</b>	8 ga. 200 ft.	BLUE
<b>PW8.200R</b>	8 ga. 200 ft.	RED
<b>PW8.200P</b>	8 ga. 200 ft.	PLATINUM
<b>GW8.200BK</b>	8 ga. 200 ft.	BLACK



[Blister]

<b>P4.18BL</b>	4 ga. 18 ft.	BLUE
<b>P4.18R</b>	4 ga. 18 ft.	RED
<b>G4.18BK</b>	4 ga. 18 ft.	BLACK

# SPEAKER CABLES



## Ultra Flat Speaker Cables [Expert Link]

	10 ga. 413 x .127mm Strand Count	
<b>FS10.100PB</b>	10 ga. 100 ft.	PLAT / BLUE
	12 ga. 259 x .127mm Strand Count	
<b>FS12.200PB</b>	12 ga. 200 ft.	PLAT / BLUE
	14 ga. 168 x .127mm Strand Count	
<b>FS14.300PB</b>	14 ga. 300 ft.	PLAT / BLUE
	16 ga. 39 x .15mm Strand Count	
<b>FS16.800PB</b>	16 ga. 800 ft.	PLAT / BLUE

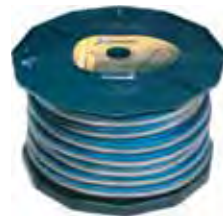

## Speaker Cables [Expert Link]

	10 ga. 413 x .127mm Strand Count	
<b>SW10.100BL</b>	10 ga. 100 ft.	BLUE
<b>SW10.100PB</b>	10 ga. 100 ft.	PLAT / BLUE
	12 ga. 259 x .127mm Strand Count	
<b>SW12.200BL</b>	12 ga. 200 ft.	BLUE
<b>SW12.200PB</b>	12 ga. 200 ft.	PLAT / BLUE
	14 ga. 168 x .127mm Strand Count	
<b>SW14.300BL</b>	14 ga. 300 ft.	BLUE
<b>SW14.300PB</b>	14 ga. 300 ft.	PLAT / BLUE
	16 ga. 39 x .15mm Strand Count	
<b>SW16.800BL</b>	16 ga. 800 ft.	BLUE
<b>SW16.800PB</b>	16 ga. 800 ft.	PLAT / BLUE



## Speaker Cables [Installer Series]

<b>S10.200BL</b>	10 ga. 200 ft.	BLUE
<b>S10.200PB</b>	10 ga. 200 ft.	PLAT / BLUE
<b>S12.300BL</b>	12 ga. 300 ft.	BLUE
<b>S12.300PB</b>	12 ga. 300 ft.	PLAT / BLUE
<b>S14.400BL</b>	14 ga. 400 ft.	BLUE
<b>S14.400PB</b>	14 ga. 400 ft.	PLAT / BLUE
<b>S16.1000BL</b>	16 ga. 1000 ft.	BLUE
<b>S16.1000PB</b>	16 ga. 1000 ft.	PLAT / BLUE
<b>S18.1000BL</b>	18 ga. 1000 ft.	BLUE
<b>S18.1000PB</b>	18 ga. 1000 ft.	PLAT / BLUE



## Speaker Cables [Installer Series] [Blister]

<b>S12.25PB</b>	12 ga. 25 ft.	PLAT / BLUE
<b>S12.50PB</b>	12 ga. 50 ft.	PLAT / BLUE
<b>S14.25PB</b>	14 ga. 25 ft.	PLAT / BLUE
<b>S14.50PB</b>	14 ga. 50 ft.	PLAT / BLUE
<b>S16.25PB</b>	16 ga. 25 ft.	PLAT / BLUE
<b>S16.50PB</b>	16 ga. 50 ft.	PLAT / BLUE
<b>S18.25PB</b>	18 ga. 25 ft.	PLAT / BLUE
<b>S18.50PB</b>	18 ga. 50 ft.	PLAT / BLUE



# PRIMARY CABLES



## Primary Cables [Expert Link]

<b>EP12.250RD</b>	12 ga.	250 ft.	RED
<b>EP12.250BK</b>	12 ga.	250 ft.	BLACK
<b>EP14.300RD</b>	14 ga.	300 ft.	RED
<b>EP14.300BK</b>	14 ga.	300 ft.	BLACK
<b>EP16.350BL</b>	16 ga.	350 ft.	BLUE
<b>EP16.350BK</b>	16 ga.	350 ft.	BLACK
<b>EP16.350GN</b>	16 ga.	350 ft.	GREEN
<b>EP16.350OR</b>	16 ga.	350 ft.	ORANGE
<b>EP16.350RD</b>	16 ga.	350 ft.	RED
<b>EP16.350PL</b>	16 ga.	350 ft.	PURPLE
<b>EP16.350YL</b>	16 ga.	350 ft.	YELLOW
<b>EP16.350PK</b>	16 ga.	350 ft.	PINK
<b>EP16.350BN</b>	16 ga.	350 ft.	BROWN
<b>EP16.350WT</b>	16 ga.	350 ft.	WHITE
<b>EP16.350GY</b>	16 ga.	350 ft.	GREY
<b>EP18.400BL</b>	18 ga.	400 ft.	BLUE
<b>EP18.400BK</b>	18 ga.	400 ft.	BLACK
<b>EP18.400GN</b>	18 ga.	400 ft.	GREEN
<b>EP18.400OR</b>	18 ga.	400 ft.	ORANGE
<b>EP18.400RD</b>	18 ga.	400 ft.	RED
<b>EP18.400PL</b>	18 ga.	400 ft.	PURPLE
<b>EP18.400YL</b>	18 ga.	400 ft.	YELLOW
<b>EP18.400PK</b>	18 ga.	400 ft.	PINK
<b>EP18.400BN</b>	18 ga.	400 ft.	BROWN
<b>EP18.400WT</b>	18 ga.	400 ft.	WHITE
<b>EP18.400GY</b>	18 ga.	400 ft.	GREY
<b>EP18.400VT</b>	18 ga.	400 ft.	VIOLET
<b>EP18.400LB</b>	18 ga.	400 ft.	LT. BLUE
<b>EP18.400LG</b>	18 ga.	400 ft.	LT. GREEN

## Five / Nine Conductor Cable [Expert Link]

18 ga. 22 x .20 mm Strand Count

<b>MC918.100</b>	18ga.	100 ft.	9 CONDUCTOR
<b>MC918.100</b>	18ga.	100 ft.	5 CONDUCTOR



## Primary Cables [Installer Series]

<b>XP12.300RD</b>	12 ga.	300 ft.	RED
<b>XP12.300BK</b>	12 ga.	300 ft.	BLACK
<b>XP14.350RD</b>	14 ga.	350 ft.	RED
<b>XP14.350BK</b>	14 ga.	350 ft.	BLACK
<b>XP16.400BL</b>	16 ga.	400 ft.	BLUE
<b>XP16.400BK</b>	16 ga.	400 ft.	BLACK
<b>XP16.400GN</b>	16 ga.	400 ft.	GREEN
<b>XP16.400OR</b>	16 ga.	400 ft.	ORANGE
<b>XP16.400RD</b>	16 ga.	400 ft.	RED
<b>XP16.400PL</b>	16 ga.	400 ft.	PURPLE
<b>XP16.400YL</b>	16 ga.	400 ft.	YELLOW
<b>XP16.400PK</b>	16 ga.	400 ft.	PINK
<b>XP16.400BN</b>	16 ga.	400 ft.	BROWN
<b>XP16.400WT</b>	16 ga.	400 ft.	WHITE
<b>XP16.400GY</b>	16 ga.	400 ft.	GREY
<b>XP18.500BL</b>	18 ga.	500 ft.	BLUE
<b>XP18.500BK</b>	18 ga.	500 ft.	BLACK
<b>XP18.500GN</b>	18 ga.	500 ft.	GREEN
<b>XP18.500OR</b>	18 ga.	500 ft.	ORANGE
<b>XP18.500RD</b>	18 ga.	500 ft.	RED
<b>XP18.500PL</b>	18 ga.	500 ft.	PURPLE
<b>XP18.500YL</b>	18 ga.	500 ft.	YELLOW
<b>XP18.500PK</b>	18 ga.	500 ft.	PINK
<b>XP18.500BN</b>	18 ga.	500 ft.	BROWN
<b>XP18.500WT</b>	18 ga.	500 ft.	WHITE
<b>XP18.500GY</b>	18 ga.	500 ft.	GREY
<b>XP18.500VT</b>	18 ga.	500 ft.	VIOLET
<b>XP18.500LB</b>	18 ga.	500 ft.	LT. BLUE
<b>XP18.500LG</b>	18 ga.	500 ft.	LT. GREEN



# AUDIO VIDEO CABLES

## Audio Video Quad Shield Platinum RCA [Expert Link] [Blister]

<b>AVP 3</b>	3 ft.	Audio Video
<b>AVP 6</b>	6 ft.	Audio Video
<b>AVP 9</b>	9 ft.	Audio Video
<b>AVP 12</b>	12 ft.	Audio Video
<b>AVP 15</b>	15 ft.	Audio Video
<b>AVP 18</b>	18 ft.	Audio Video



## Quad Shield Platinum RCA Cables [Expert Link] [Blister]

<b>QS 1.5</b>	1.5 ft.	Quad Shield
<b>QS 3</b>	3 ft.	Quad Shield
<b>QS 6</b>	6 ft.	Quad Shield
<b>QS 12</b>	12 ft.	Quad Shield
<b>QS 15</b>	15 ft.	Quad Shield
<b>QS 18</b>	18 ft.	Quad Shield
<b>QSY 2M</b>	Y Adapter 2 Male	Quad Shield
<b>QSY 2F</b>	Y Adapter 2 Female	Quad Shield



## Spiral Twist Platinum & Blue RCA Cables [Expert Link] [Blister]

<b>STP 1.5</b>	1.5 ft.	Plat / Blue
<b>STP 3</b>	3 ft.	Plat / Blue
<b>STP 6</b>	6 ft.	Plat / Blue
<b>STP 12</b>	12 ft.	Plat / Blue
<b>STP 15</b>	15 ft.	Plat / Blue
<b>STP 18</b>	18 ft.	Plat / Blue
<b>STPY 2M</b>	Y Adapter 2 Male	Plat / Blue
<b>STPY 2F</b>	Y Adapter 2 Female	Plat / Blue



## Triple Shield RCA Cables w / Drain Wire [Blister]

<b>1.5TR</b>	1.5 ft.	Triple Shield
<b>3 TR</b>	3 ft.	Triple Shield
<b>6 TR</b>	6 ft.	Triple Shield
<b>12 TR</b>	12 ft.	Triple Shield
<b>15 TR</b>	15 ft.	Triple Shield
<b>18 TR</b>	18 ft.	Triple Shield
<b>Y2M TR</b>	Y Adapter 2 Male	Triple Shield
<b>Y2F TR</b>	Y Adapter 2 Female	Triple Shield



## Quad Connector Triple Shield RCA Cables [Blister]

<b>QTR 9</b>	9 ft.	Triple Shield
<b>QTR 17</b>	17 ft.	Triple Shield
<b>QTR 20</b>	20 ft.	Triple Shield



## Transparent RCA Cables

<b>1.5CR</b>	1.5 ft.	Transparent
<b>3 CR</b>	3 ft.	Transparent
<b>6 CR</b>	6 ft.	Transparent
<b>12 CR</b>	12 ft.	Transparent
<b>15 CR</b>	15 ft.	Transparent
<b>18 CR</b>	18 ft.	Transparent
<b>Y2M CR</b>	Y Adapter 2 Male	Transparent
<b>Y2F CR</b>	Y Adapter 2 Female	Transparent



# RCA CABLES. PHONO PLUGS

## Transparent Blue RCA Cables

<b>1.5 BR</b>	1.5 ft.	BLUE
<b>3 BR</b>	3 ft.	BLUE
<b>6 BR</b>	6 ft.	BLUE
<b>12 BR</b>	12 ft.	BLUE
<b>15 BR</b>	15 ft.	BLUE
<b>18 BR</b>	18 ft.	BLUE
<b>Y2M BR</b>	Y Adapter 2 Male	BLUE
<b>Y2F BR</b>	Y Adapter 2 Female	BLUE



## Phono Plug EXPERT LINK®

3.5mm-to-3.5mm & 3.5mm-to-RCA Stereo Interconnect Cable for Audio Devices.

<b>35E3XL</b>	3.5mm-to-3.5mm	3 ft.
<b>35E6XL</b>	3.5mm-to-3.5mm	6 ft.
<b>35E12XL</b>	3.5mm-to-3.5mm	12 ft.
<b>35R3XL</b>	3.5mm-to-RCA	3 ft.
<b>35R6XL</b>	3.5mm-to-RCA	6 ft.
<b>35R12XL</b>	3.5mm-to-RCA	12 ft.



## Transparent Red RCA Cables [Blister]

<b>3 RR</b>	3 ft.	RED
<b>6 RR</b>	6 ft.	RED
<b>12 RR</b>	12 ft.	RED
<b>15 RR</b>	15 ft.	RED
<b>18 RR</b>	18 ft.	RED
<b>22 RR</b>	22 ft.	RED
<b>Y2M RR</b>	Y Adapter 2 Male	RED
<b>Y2F RR</b>	Y Adapter 2 Female	RED



<b>35E3</b>	3.5mm-to-3.5mm	3 ft.
<b>35E6</b>	3.5mm-to-3.5mm	6 ft.
<b>35E12</b>	3.5mm-to-3.5mm	12 ft.
<b>35R3</b>	3.5mm-to-RCA	3 ft.
<b>35R6</b>	3.5mm-to-RCA	6 ft.
<b>35R12</b>	3.5mm-to-RCA	12 ft.



**RCA CABLE** Your Source of Ultimate Technology

Patented - All Rights Reserved by Xscorpion

# POWER AMP KITS

## 1/0GA. PWR AMP Kit 4000 Watts [Expert Link] [Blister]

**PAKE.05B** Plat & Blue Cable w/ Platinum matching accessories

**PAKE.05R** Red & Blk Cable w/ Gold matching accessories

- 17ft. 1/0ga. Power Cable
- 3ft. 1/0ga. Ground Cable
- 15ft. Amplifier Remote Turn-On Wire
- Plat/Gold ANL In-Line Fuse Holder
- Plat/Gold ANL Fuse
- Plat/Gold Ground Terminal
- Plat/Gold Ring Terminal
- Plat/Gold Spade Terminal
- Butt Connector
- Grommet
- Cable Tie
- Self Tapping Screw
- Misc.



## 4GA. PWR AMP Kit with Capacitor 2000-3600 Watts [Blister]

**PAKC.42B** Plat & Blue Cable w/ Platinum matching accessories

**PAKC.42R** Red & Blk Cable w/ Gold matching accessories

- 1.2 Farad Digital Capacitor
- 17ft. & 3ft. 4ga. Power Cable
- 4ft. & 3ft. 4ga. Ground Cable
- 15ft. Amplifier Remote Turn-On Wire
- 15ft. Triple Shielded RCA Cable
- 14ga. Speaker Wire
- Plat/Gold PWR/GRND Dist. Block
- Plat/Gold ANL In-Line Fuse Holder
- Plat/Gold ANL Fuse
- Plat/Gold Ring Terminal
- Plat/Gold Spade Terminal
- Butt Connector
- Self Tapping Screw
- Loom Tubing
- Grommet
- Cable Tie
- Misc.



## 4 GA. PWR AMP Kit 2000 Watts [Expert Link] . [Blister]

**PAKE.45B** Plat & Blue Cable w/ Platinum matching accessories

**PAKE.45R** Red & Blk Cable w/ Gold matching accessories

- 17ft. 4ga. Power Cable
- 3ft. 4ga. Ground Cable
- 15ft. Amplifier Remote Turn-On Wire
- Plat/Gold ANL In-Line Fuse Holder
- Plat/Gold ANL Fuse
- Plat/Gold Ground Terminal
- Plat/Gold Ring Terminal
- Plat/Gold Spade Terminal
- Butt Connector
- Grommet
- Cable Tie
- Self Tapping Screw
- Misc.



## 4-8GA. COMBO PWR AMP Kit 2000 Watts [Blister]

**PAK48.2B** Plat & Blue Cable w/ Platinum matching accessories

**PAK48.2R** Red & Blk Cable w/ Gold matching accessories

- 17ft. 4ga. Power Cable
- 8ft. 8ga. Power Cable
- 3ft. 4ga. Ground Cable
- 6ft. 8ga. Ground Cable
- 15ft. Amplifier Remote Turn-On Wire
- 15ft. Triple Shielded RCA Cable
- 14ga. Speaker Wire
- 2 Gang AGU PWR Dist. Block
- Plat/Gold AGU Fuse
- Plat/Gold ANL In-Line Fuse Holder
- Plat/Gold ANL Fuse
- Plat/Gold Battery Terminal
- Plat/Gold PWR/GRND Dist. Block
- Plat/Gold Ring Terminal
- Plat/Gold Spade Terminal
- Butt Connector
- Self Tapping Screw
- Grommet
- Cable Tie
- Misc.



## 8GA. PWR AMP Kit 1200 Watts [Expert Link] . [Blister]

**PAKE.85B** Plat & Blue Cable w/ Platinum matching accessories

**PAKE.85R** Red & Blk Cable w/ Gold matching accessories

- 17ft. 8ga. Power Cable
- 3ft. 8ga. Ground Cable
- 15ft. Triple Shielded Blue RCA Cable
- 20ft Platinum/Blue Speaker Wire
- 15ft. Amplifier Remote Turn-On Wire
- Plat/Gold AGU In-Line Fuse Holder
- Plat/Gold AGU Fuse
- Plat/Gold Ring Terminal
- Plat/Gold Spade Terminal
- Loom Tubing
- Self Tapping Screw
- Grommet
- Cable Tie
- Misc.



## 4GA. PWR AMP Kit 1800 Watts

**PAK49B** Plat & Blue Cable w/ Platinum matching accessories

**PAK49R** Red & Blk Cable w/ Gold matching accessories

- 17ft. 4ga. Power Cable
- 3ft. 4ga. Ground Cable
- 18ft. Triple Shielded RCA Cable
- 20ft Platinum/Blue Speaker Wire
- 15ft. Amplifier Remote Turn-On Wire
- Plat/Gold ANL In-Line Fuse Holder
- Plat/Gold ANL Fuse
- Plat/Gold Ring Terminal
- Plat/Gold Spade Terminal
- Loom Tubing
- Self Tapping Screw
- Grommet
- Cable Tie
- Misc.



# POWER AMP KITS

## 4GA. PWR AMP Kit 1800 Watts [Installer Series] . [Blister]

**PAK44BL** Plat & Blue Cable w/ Platinum matching accessories

- 16ft. Transparent Blue Power Cable
- 3ft. Platinum Ground Cable
- 15ft. Blue Amplifier Remote Turn-On Wire
- 15ft. Transparent Blue RCA Cable
- 20ft. Platinum/Blue Speaker Wire
- Platinum AGU In-Line Fuse Holder
- Platinum AGU Fuse
- Platinum Ring Terminal
- Platinum Spade Terminal
- Butt Connector
- Grommet
- Cable Tie
- Self tapping Screw
- Crimp Cap
- Misc.



## 4GA. PWR AMP Kit 1800 Watts [Installer Series]

**PAK46** Red & Blk Cable w/ Gold matching accessories

- 16ft. Transparent Red Power Cable
- 3ft. Transparent Blk Ground Cable
- 16ft. Yellow Remote Turn On Wire
- 15ft. Transparent Blue RCA Cable
- 20ft. Transparent Blue Speaker cable
- Gold AGU In-Line Fuse Holder
- Gold AGU Fuse
- Gold Ring Terminal
- Gold Spade Terminal
- Butt Connector
- Loom Tubing
- Cable Tie
- Self Tapping Screw
- Grommet
- Misc.



## 8GA. PWR AMP Kit 1000 Watts [Installer Series] . [Blister]

**PAK88BL** Plat & Blue Cable w/ Platinum matching accessories

- 16ft. Transparent Blue Power Cable
- 3ft. Platinum Ground Cable
- 15ft. Blue Amplifier Remote Turn-On Wire
- 15ft. Transparent Blue RCA Cable
- 20ft. Platinum/Blue Speaker Wire
- Platinum AGU In-Line Fuse Holder
- Platinum AGU Fuse
- Platinum Ring Terminal
- Platinum Spade Terminal
- Butt Connector
- Grommet
- Cable Tie
- Self tapping Screw
- Crimp Cap
- Misc.



## 8GA. PWR AMP Kit 1000 Watts [Installer Series]

**PAK86** Red & Blk Cable w/ Gold matching accessories

- 16ft. Transparent Red Power Cable
- 3ft. Transparent Blk Ground Cable
- 16ft. Yellow Remote Turn On Wire
- 15ft. Transparent Blue RCA Cable
- 20ft. Transparent Blue Speaker cable
- Gold AGU In-Line Fuse Holder
- Gold AGU Fuse
- Gold Ring Terminal
- Gold Spade Terminal
- Butt Connector
- Loom Tubing
- Cable Tie
- Self Tapping Screw
- Grommet
- Misc.



## 10GA. PWR AMP Kit 600 Watts [Installer Series] . [Blister]

**PAK80BL** Plat & Blue Cable w/ Platinum matching accessories

- 16ft. Transparent Blue Power Cable
- 3ft. Platinum Ground Cable
- 15ft. Blue Amplifier Remote Turn-On Wire
- 15ft. Transparent Blue RCA Cable
- 20ft. Platinum/Blue Speaker Wire
- ATC In-Line Fuse Holder
- ATC Fuse
- Platinum Ring Terminal
- Platinum Spade Terminal
- Butt Connector
- Grommet
- Cable Tie
- Self tapping Screw
- Crimp Cap
- Misc.



## 10GA. PWR AMP Kit 600 Watts [Installer Series]

**PAK82** Red & Blk Cable w/ Gold matching accessories

- 16ft. Transparent Red Power Cable
- 3ft. Transparent Black Ground Cable
- 16ft. Blue Remote Turn On Wire
- 15ft. Transparent Blue RCA Cable
- 20ft. Transparent Blue Speaker Wire
- ATC In-Line Fuse Holder
- ATC Fuse
- Ring Terminal
- Spade Terminal
- Butt Connector
- Loom Tubing
- Cable Tie
- Self Tapping Screw
- Grommet
- Misc.



# CABLE KITS

## 1/0 ga. SNAKE SKIN Cable Kits [Expert Link]

18" 1/0 ga. Snake Skin Power Cable with MINI ANL Fuse Holder & Digital Battery Terminal (Includes 250 AMP MINI ANL Fuse with LED) (Blister)

**MAK0S** 1/0 ga. 4214 x .127 mm Strand Count



## 1/0 ga. ANL Cable Kits [Expert Link]

18" 1/0 ga. Power Cable with ANL In-Line Fuse Holder & Battery Terminal (Includes 200 AMP ANL Fuse) (Blister)

**K0BL-BT** 1/0 ga. 4214 x .127 mm Strand Count BLUE

**K0R-BT** 1/0 ga. 4214 x .127 mm Strand Count RED



## 1/0 ga. MINI ANL Cable Kits [Expert Link]

18" 1/0 ga. Power Cable with MINI ANL Fuse Holder & Digital Battery terminal (includes 200 AMP MINI ANL Fuse with LED) (Blister)

**MAK0BL** 1/0 ga. 4214 x .127 mm Strand Count BLUE

**MAK0R** 1/0 ga. 4214 x .127 mm Strand Count RED



## 1/0 ga. ANL Cable Kits [Expert Link]

18" 1/0 ga. Power Cable with ANL In-Line Fuse Holder & Ring Terminal (Includes 200 AMP ANL Fuse) (Blister)

**K0BL-RT** 1/0 ga. 4214 x .127 mm Strand Count BLUE

**K0R-RT** 1/0 ga. 4214 x .127 mm Strand Count RED



## 4 ga. MINI ANL Cable Kits [Expert Link]

18" 4 ga. Power Cable with compact MINI ANL Fuse Holder & Ring Terminal (Includes 60 AMP MINI ANL Fuse with LED) (Blister)

**MAK4BL** 4 ga. 1666 x .127 mm Strand Count BLUE

**MAK4R** 4 ga. 1666 x .127 mm Strand Count RED



## 4 ga. AGU Cable Kits [Expert Link]

18" 4 ga. Power Cable with AGU In-Line Fuse Holder & Ring Terminal (Includes 60 AMP AGU Fuse) (Blister)

**K4BL** 4 ga. 1666 x .127 mm Strand Count BLUE

**K4R** 4 ga. 1666 x .127 mm Strand Count RED



# HYBRID CAPACITORS

**X**  
SERIES

EXPERT LINK®

80 Farad Heavy Duty Hybrid Capacitor



## Heavy Duty Hybrid Capacitor

Low ESR 18V DC Surge with Voltage Display

<b>HBC 80X</b>	80 FARAD
<b>HBC 40X</b>	40 FARAD

## Hybrid Capacitor

Low ESR 18V DC Surge with Voltage Display

<b>HBC 30</b>	30 FARAD
<b>HBC 18</b>	18 FARAD



30 Farad Hybrid Capacitor



# CAPACITOR



### Cross Flow Cooling Fans ( Blister)

<b>TF 8</b>	8" Cross-Flow Fan	12 VDC
<b>TF 5</b>	5" Cross-Flow Fan	12 VDC



### Rotary Cooling Fans

<b>FAN 615</b>	6" SQ Rotary Fan	1 1/2" DEEP
<b>FAN 61</b>	6" SQ Rotary Fan	1" DEEP
<b>FAN 5</b>	5" SQ Rotary Fan	1" DEEP
<b>FAN 3</b>	3" SQ Rotary Fan	1" DEEP



### Fan Grill

<b>FPG 3</b>	3"
<b>FPG 5</b>	5"
<b>FPG 6</b>	6"



### Digital AMP & Volt Meter

<b>DAV02P</b>	0/2/4 ga. In & Out	Platinum
---------------	--------------------	----------



VoltMeter Diameter:  
[1 7/8"-46.60mm]  
Mounting Depth:  
[5/8"-15.00mm]

### Digital Volt Meter (Blister)

Digital VoltMeter, Round, Silver / Black Surface.

<b>DVM3R</b>	Silver / Red Digit
<b>DVM3RB</b>	Black / Red Digit



VoltMeter Diameter:  
[2 1/4"-46.60mm x 1 9/16"-49.50mm]  
Mounting Depth:  
[5/8"-15.00mm]

Digital VoltMeter, Silver / Black, Red / Blue Digital

<b>DVM23BB</b>	Black Surface / Blue Digital
<b>DVM23BR</b>	Black Surface / Red Digital
<b>DVM23SB</b>	Silver Surface / Blue Digital
<b>DVM23SR</b>	Silver Surface / Red Digital

- 3 Digit Red/Blue LED Voltage Display
- Flush or Surface Mountable
- Rubberized Finish
- Two Wire Positive or Negative Hook up with Auto-Sensing Turn on





### Circuit Breaker with LED Indicators

<b>CB100L</b>	100 AMP	Blister
<b>CB150L</b>	150 AMP	Blister
<b>CB200L</b>	200 AMP	Blister
<b>CB250L</b>	250 AMP	Blister
<b>CB300L</b>	300 AMP	Blister



### Circuit Breakers

<b>CB100A</b>	100 AMP	Blister
<b>CB150A</b>	150 AMP	Blister
<b>CB200A</b>	200 AMP	Blister
<b>CB250A</b>	250 AMP	Blister



### Battery Isolator and Relay with Control Box

<b>BI 200</b>	200 Amp.
---------------	----------

- Prevents loads on auxiliary battery from draining the main battery.
- Works with all alternator types.
- Reduces charging system load by not connecting auxiliary battery until primary battery is charged to 13.2V.



### Isolator Control Box [Smart Box]

<b>ICB 2000</b>
-----------------



RL 200



RL 80

### High Current Relay

<b>RL 200</b>	200 Amp. Relay
<b>RL 80</b>	80 Amp. Relay

- High Current Relays, ideal for battery isolation. Reliable and efficient method to add secondary battery to any system.
- Easy and simple installation. Simply connect relays to operate, when ignition is powered on, the individual batteries remain separate preventing power drain.



### Relays

<b>RL 40</b>	40 AMP	5 Connector
<b>RL 30</b>	30 AMP	5 Connector



### Relay Sockets

<b>RS 5</b>	5 Wire	Socket
<b>RS 3</b>	3 Wire with Diode	Socket



LCO14.4R



LCO12.2R



LCO12



LCO9

### Line Output Converter [Hi to Low] [Blister]

**LCO14.4R** 4 Channels, with Auto Remote Amp Turn-on

**LCO12.2R** 2 Channels, with Auto Remote Amp Turn-on

**LCO12** With Gain Control

**LCO9** With Gain Control Metal Chassis

**LCO8** With Gain Control Standard Case

**LCO7** Compact Size



LCO8



LCO7



NS200



NS80



NS606



NS60

### Ground Loop Isolator [Noise Filter] [Blister]

**NS200** 200 AMP Metal Chassis

**NS80** 80 AMP Standard Size

**NS606** 60 AMP

**NS60** 60 AMP Barrel Case

**NS30** 30 AMP Barrel Case



NS30



PE100X



PE200X



PE300

### POPs Eliminator [Blister]

**PE100X** Amplifier & Stereo on POP Eliminator

**PE200X** DC Power on POP Eliminator

**PE300** Turn-on & Turn-off POP Eliminator

Delays the amplifier(s) turn-on lead 1 second to eliminate undesirable pops from the amplifier(s) when turning on an audio system or eliminates ignition turn off pops by allowing the amplifier to turn off 1 second before the radio.



### Bass Blockers Non-Polar 10% Cap [2Pcs Blister]

<b>BB14</b>	14 $\mu$ f	50 V	2800 Hz@4 $\Omega$
<b>BB99</b>	99 $\mu$ f	100 V	400 Hz@4 $\Omega$
<b>BB133</b>	133 $\mu$ f	50 V	300 Hz@4 $\Omega$
<b>BB199</b>	199 $\mu$ f	100 V	200 Hz@4 $\Omega$
<b>BB398</b>	398 $\mu$ f	100 V	100 Hz@4 $\Omega$
<b>BB468</b>	468 $\mu$ f	100 V	85 Hz@4 $\Omega$



### RCA Couplers [10 pcs/bag]

<b>CMR</b>	Male	Red
<b>CMB</b>	Male	Black
<b>CFR</b>	Female	Red
<b>CFB</b>	Female	Black



### Right Angle Adapters [10 pcs/bag]

<b>RAS-R</b>	Short	Red
<b>RAS-B</b>	Short	Black
<b>RAL-R</b>	Long	Red
<b>RAL-B</b>	Long	Black



### Banana Plugs

<b>SSR</b>	Dual	Red
<b>SSB</b>	Dual	Black



### Metal Toggle Switches [ON/OFF] W / LED

<b>MTSR-2W</b>	Red LED	With 6" Lead Wire
<b>MTSG-2W</b>	Green LED	With 6" Lead Wire
<b>MTSB-2W</b>	Blue LED	With 6" Lead Wire



### Toggle Switch Covers [Use w/ MTS Switch]

<b>TSCC</b>	Chrome
<b>T SCT</b>	Transparent
<b>TSCBK</b>	Black



### Illuminated Toggle Switches [ON/OFF]

<b>ITSLR-W</b>	Red	With 6" Lead Wire
<b>ITSLG-W</b>	Green	With 6" Lead Wire
<b>ITSLB-W</b>	Blue	With 6" Lead Wire
<b>ITSLA-W</b>	Amber	With 6" Lead Wire



RRS



RRSR



RRSG

### Round Rocker Switches [ON/OFF]

<b>RRS-2</b>	No LED
<b>RRS-2W</b>	No LED With 6" Lead Wire
<b>RRSR-2</b>	Red LED
<b>RRS-2W</b>	Red LED With 6" Lead Wire
<b>RRSG-2</b>	Green LED
<b>RRSG-2W</b>	Green LED With 6" Lead Wire



IRRSR



IRRSR

### Illuminated Round Rocker Switch [ON/OFF]

<b>IRRSR-2</b>	Red
<b>IRRSR-2W</b>	Red With 6" Lead Wire
<b>IRRSR-2</b>	Green
<b>IRRSR-2W</b>	Green With 6" Lead Wire



## Toggle Switch

**TSM 2** MINI SPST with 20" Lead Wire (ON/OFF)



## Push Button Sub Miniature [Alarm] Switch

**PB55M14M** Momentary On with 40" Lead Wire & 2 pin plug



LED12R SBLED12W SBLED3R SBLED12BF LED12RP

## LED [Includes 3 ft. Lead Wire]

**LED12R** 12V Super Bright Red LED

**SBLED12W** 12V Super Bright White LED

**SBLED3R** 3V Super Bright Red LED

**SBLED12BF** 12V Super Bright Blue Flashing

**LED12RP** 12V with Pin Plug Red LED



## Brackets

**PSB** Straight Pin Switch Bracket

**PSBL** 90° Angle Pin Switch Bracket L-Shape

## Pin Switches



**PSL** 2.5" Long Pin Switch



**PSS** 2.0" Short Pin Switch



**PSAL** 2.5" Long Pin Switch Adjustable



**PSAS** 2.0" Short Pin Switch Adjustable



**UPS** 2.0" Universal Pin Switch



**UPSA** 2.5" Long Universal Adjustable



**PPS** 1.75" Plunger Pin Switch



**FMPS** Flange Mount Euro Right Angle



w/ Water Proof Boot

**FMPSRB** Flange Mount Euro Right Angle

# ACCESSORIES

## MAXI, ATC, MINI & AGC IN-LINE FUSE HOLDERS EXPANDABLE, HEATSHRINK & LOOM TUBING



### MAXI In-line Fuse Holder

**MAX 8** 8 ga. (10 pcs/ Bag)



### ATC In-line Fuse Holder

**ATC 8** 8 ga. (10 pcs/ Bag)

**ATC 10** 10 ga. (10 pcs/ Bag)

**ATC 12** 12 ga. (10 pcs/ Bag)

**ATC 14** 14 ga. (10 pcs/ Bag)

**ATC 16** 16 ga. (10 pcs/ Bag)

**ATC 18** 18 ga. (10 pcs/ Bag)



### MINI In-line Fuse Holder

**MINI 12** 12 ga. (10 pcs/ Bag)

**MINI 14** 14 ga. (10 pcs/ Bag)

**MINI 16** 16 ga. (10 pcs/ Bag)



### AGC In-line Fuse Holder

**AGC 10** 10 ga. (10 pcs/ Bag)

**AGC 12** 12 ga. (10 pcs/ Bag)

**AGC 14** 14 ga. (10 pcs/ Bag)

**AGC 16** 16 ga. (10 pcs/ Bag)

**AGC 18** 18 ga. (10 pcs/ Bag)



### Expandable Tubing

**ET14.100BK** 1/4"×100FT BLACK

**ET38.100BK** 3/8"×100FT BLACK

**ET12.100BK** 1/2"×100FT BLACK

**ET34.100BK** 3/4"×100FT BLACK



### Heatshrink Tubing

**HST 18BK** 1/8" 4 ft. (Polybag)

**HST 18.1BK** 1/8" 100 ft. (Spool)

**HST 3/16BK** 3/16" 4 ft. (Polybag)

**HST 3/16.1BK** 3/16" 100 ft. (Spool)

**HST 1/4BK** 1/4" 4 ft. (Polybag)

**HST 1/4.1BK** 1/4" 100 ft. (Spool)

**HST 3/8BK** 3/8" 4 ft. (Polybag)

**HST 3/8.1BK** 3/8" 100 ft. (Spool)

**HST 1/2BK** 1/2" 4 ft. (Polybag)

**HST 1/2.1BK** 1/2" 100 ft. (Spool)

**HST 3/4BK** 3/4" 4 ft. (Polybag)

**HST 3/4.03BK** 3/4" 30 ft. (Spool)

**HST 1BK** 1" 4 ft. (Polybag)

**HST 1.03BK** 1" 30 ft. (Spool)



### Split Loom Tubing

**SLT 14** 1/4" 100 ft. Roll

**SLT 38** 3/8" 100 ft. Roll

**SLT 12** 1/2" 50 ft. Roll

**SLT 34** 3/4" 25 ft. Roll

# ACCESSORY

Patented - All Rights Reserved by Xscorpion

## Cable Ties

<b>CT 4</b>	4"	(1,000 pcs/ Bag)
<b>CT 6</b>	6"	(1,000 pcs/ Bag)

<b>CT 8</b>	8"	(100 pcs/ Bag)
-------------	----	----------------

<b>CT 8MS</b>	8" w/ Mounting Screw	(100 pcs/ Bag)
---------------	----------------------	----------------

<b>CT 12</b>	12"	(100 pcs/ Bag)
--------------	-----	----------------

## Screws [200 pcs/Box]

<b>DWC 1</b>	#6 x 1"	Drywall Coarse
<b>DWC 112</b>	#6 x 1 1/2"	Drywall Coarse
<b>DWC 2</b>	#6 x 2"	Drywall Coarse
<b>DWC 3</b>	#6 x 3"	Drywall Coarse

<b>WHP 12</b>	#8 x 1/2"	Wafer Head Pointed
<b>WHP 34</b>	#8 x 3/4"	Wafer Head Pointed
<b>WHP 1</b>	#8 x 1"	Wafer Head Pointed

## Self Tapping Screws

<b>WHT 12</b>	#8 x 1/2"	Wafer Head Tek Pointed
<b>WHT 34</b>	#8 x 3/4"	Wafer Head Tek Pointed
<b>WHT 1</b>	#8 x 1"	Wafer Head Tek Pointed

## Hook & Loop Fasteners

<b>VEL 1</b>	1" x 10 ft. Roll
<b>VEL 2</b>	2" x 10 ft. Roll
<b>VEL R</b>	1" Round (20 pcs/ Bag)

## Electrical Tape

3D Extended - UL Approved - Flame Retardant

<b>VET 90</b>	60' ft. x 3/4"	Vinyl	BLACK
---------------	----------------	-------	-------

## Vinyl Electrical Tape

Flame Retardant Vinyl Electrical Tape

<b>VET92BK</b>	3/4" X 60 FT.	BLACK
----------------	---------------	-------

<b>VET95RD</b>	3/4" X 60 FT.	RED
----------------	---------------	-----

<b>VET95WT</b>	3/4" X 60 FT.	WHITE
----------------	---------------	-------

<b>VET95YL</b>	3/4" X 60 FT.	YELLOW
----------------	---------------	--------

## High Temperature Resistant Tape

Flame Retardant Vinyl Electrical Tape

<b>VET99FH</b>	3/4" X 60 FT.
----------------	---------------

<b>VET299FH</b>	2" X 60 FT.
-----------------	-------------

## Double Sided Foam Tape

<b>DSFT-14</b>	1/4" X 60 ft.
----------------	---------------

<b>DSFT-12</b>	1/2" X 60 ft.
----------------	---------------

<b>DSFT-34</b>	3/4" X 60 ft.
----------------	---------------

<b>DSFT-1</b>	1" X 60 ft.
---------------	-------------

<b>DSFT-2</b>	2" X 60 ft.
---------------	-------------

## Hot Melt Glue Sticks

<b>GS - BK</b>	BLACK	(10 pcs/ Bag)
----------------	-------	---------------

<b>GS - W</b>	CLEAR	(10 pcs/ Bag)
---------------	-------	---------------

## Barrier Terminal Strip

<b>BTS 4G</b>	4 GANG	GOLD
---------------	--------	------

<b>BTS 6G</b>	6 GANG	GOLD
---------------	--------	------

<b>BTS 8G</b>	8 GANG	GOLD
---------------	--------	------

<b>BTS 10G</b>	10 GANG	GOLD
----------------	---------	------

## Bussbars

<b>BBC 3</b>	3 Capacitor Bussbar	GOLD
--------------	---------------------	------

<b>BBC 4</b>	4 Capacitor Bussbar	GOLD
--------------	---------------------	------



### Ring Terminals [5/16" Hole] Platinum

<b>RT0BP</b>	1/0 ga.	BLUE	(10 pcs/ Bag)
<b>RT0GP</b>	1/0 ga.	GREY	(10 pcs/ Bag)
<b>RT4BP</b>	4 ga.	BLUE	(10 pcs/ Bag)
<b>RT4GP</b>	4 ga.	GREY	(10 pcs/ Bag)
<b>RT8BP</b>	8 ga.	BLUE	(10 pcs/ Bag)
<b>RT8GP</b>	8 ga.	GREY	(10 pcs/ Bag)



### Ring Terminals [5/16" Hole] Gold

<b>RT0R</b>	1/0 ga.	RED	(10 pcs/ Bag)
<b>RT0B</b>	1/0 ga.	BLK	(10 pcs/ Bag)
<b>RT4R</b>	4 ga.	RED	(10 pcs/ Bag)
<b>RT4B</b>	4 ga.	BLK	(10 pcs/ Bag)
<b>RT8R</b>	8 ga.	RED	(10 pcs/ Bag)
<b>RT8B</b>	8 ga.	BLK	(10 pcs/ Bag)



### Barrier Spade [#10] Platinum

<b>BS4BP</b>	4 ga.	BLUE	(10 pcs/ Bag)
<b>BS4GP</b>	4 ga.	GREY	(10 pcs/ Bag)
<b>BS8BP</b>	8 ga.	BLUE	(10 pcs/ Bag)
<b>BS8GP</b>	8 ga.	GREY	(10 pcs/ Bag)



### Barrier Spade [#10] Gold

<b>BS4R</b>	4 ga.	RED	(10 pcs/ Bag)
<b>BS4B</b>	4 ga.	BLK	(10 pcs/ Bag)
<b>BS8R</b>	8 ga.	RED	(10 pcs/ Bag)
<b>BS8B</b>	8 ga.	BLK	(10 pcs/ Bag)



### Female Spade [.25] Platinum

<b>FS10BP</b>	10 ga.	BLUE	(10 pcs/ Bag)
<b>FS10GP</b>	10 ga.	GREY	(10 pcs/ Bag)



### Female Spade [.25] Gold

<b>FS10R</b>	10 ga.	RED	(10 pcs/ Bag)
<b>FS10B</b>	10 ga.	BLK	(10 pcs/ Bag)

### Crimp Caps



<b>CC2218</b>	22/18 ga.	CLEAR	(100 pcs/ Bag)
<b>CC1614</b>	16/14 ga.	CLEAR	(100 pcs/ Bag)
<b>CC1210</b>	12/10 ga.	CLEAR	(100 pcs/ Bag)



### T-Taps

<b>TT2218R</b>	22/18 ga.	RED	(50 pcs/ Bag)
<b>TT1614B</b>	16/14 ga.	BLUE	(50 pcs/ Bag)
<b>TT1210Y</b>	12/10 ga.	YELLOW	(50 pcs/ Bag)



### Quick Splices

<b>QS2218R</b>	22/18 ga.	RED	(50 pcs/ Bag)
<b>QS1614B</b>	16/14 ga.	BLUE	(50 pcs/ Bag)
<b>QS1210Y</b>	12/10 ga.	YELLOW	(25 pcs/ Bag)



### Butt Connectors Nylon [See Through]

<b>BC2218R</b>	22/18 ga.	RED	(100 pcs/ Bag)
<b>BC1614B</b>	16/14 ga.	BLUE	(100 pcs/ Bag)
<b>BC1210Y</b>	12/10 ga.	YELLOW	(100 pcs/ Bag)
<b>BC8R</b>	8 ga.	RED	(25 pcs/ Bag)
<b>BC4Y</b>	4 ga.	YELLOW	(15 pcs/ Bag)



### Butt Connectors [Pro] Nylon [See Through]

<b>BC2218NR</b>	22/18 ga.	RED	(100 pcs/ Bag)
<b>BC1614NB</b>	16/14 ga.	BLUE	(100 pcs/ Bag)
<b>BC1210NY</b>	12/10 ga.	YELLOW	(100 pcs/ Bag)



### Butt Connectors Seamless Nylon

<b>BC2218SNR</b>	22/18 ga.	RED	(100 pcs/ Bag)
<b>BC1614SNB</b>	16/14 ga.	BLUE	(100 pcs/ Bag)
<b>BC1210SNY</b>	12/10 ga.	YELLOW	(100 pcs/ Bag)



### Butt Connectors Seamless Nylon [with Window]

<b>BC2218WNR</b>	22/18 ga.	RED	(100 pcs/ Bag)
<b>BC1614WNB</b>	16/14 ga.	BLUE	(100 pcs/ Bag)
<b>BC1210WNY</b>	12/10 ga.	YELLOW	(50 pcs/ Bag)

All Terminals in this column are **made in Taiwan.**



### Q - Disconnects [Male] Nylon Fully Insulated

<b>MD250NFR</b>	22/18 ga.	.25	Red	(100 pcs/Bag)
<b>MD250NFB</b>	16/14 ga.	.25	Blue	(100 pcs/Bag)
<b>MD250NFY</b>	12/10 ga.	.25	Yellow	(100 pcs/Bag)



### Q - Disconnects [Female] Nylon Fully Insulated

<b>FD250NFR</b>	22/18 ga.	.25	Red	(100 pcs/Bag)
<b>FD250NFB</b>	16/14 ga.	.25	Blue	(100 pcs/Bag)
<b>FD250NFY</b>	12/10 ga.	.25	Yellow	(100 pcs/Bag)



### Quick Disconnects [Male]

<b>MD250R</b>	22/18 ga.	.25	Red	(100 pcs/Bag)
<b>MD250B</b>	16/14 ga.	.25	Blue	(100 pcs/Bag)
<b>MD250Y</b>	12/10 ga.	.25	Yellow	(100 pcs/Bag)



### Quick Disconnects [Female]

<b>FD110R</b>	22/18 ga.	.110	Red	(100 pcs/Bag)
<b>FD187R</b>	22/18 ga.	.187	Red	(100 pcs/Bag)
<b>FD250R</b>	22/18 ga.	.250	Red	(100 pcs/Bag)
<b>FD110B</b>	16/14 ga.	.110	Blue	(100 pcs/Bag)
<b>FD187B</b>	16/14 ga.	.187	Blue	(100 pcs/Bag)
<b>FD250B</b>	16/14 ga.	.250	Blue	(100 pcs/Bag)
<b>FD250Y</b>	12/10 ga.	.250	Yellow	(100 pcs/Bag)



### Bullet Connectors [Male]

<b>MB2218R</b>	22/18 ga.	.156	Red	(100 pcs/Bag)
<b>MB1614B</b>	16/14 ga.	.156	Blue	(100 pcs/Bag)



### Bullet Connectors [Female]

<b>FB2218R</b>	22/18 ga.	.156	Red	(100 pcs/Bag)
<b>FB1614B</b>	16/14 ga.	.156	Blue	(100 pcs/Bag)

All Terminals on this page are **made in Taiwan.**



### Ring Terminals

<b>RTT6R</b>	22/18 ga.	#6	Red	BLUE (100 pcs/Bag)
<b>RTT8R</b>	22/18 ga.	#8	Red	PLAT / BLUE (100 pcs/Bag)
<b>RTT10R</b>	22/18 ga.	#10	Red	(100 pcs/Bag)
<b>RTT6B</b>	16/14 ga.	#6	Blue	(100 pcs/Bag)
<b>RTT8B</b>	16/14 ga.	#8	Blue	(100 pcs/Bag)
<b>RTT10B</b>	16/14 ga.	#10	Blue	(100 pcs/Bag)
<b>RTT14B</b>	16/14 ga.	1/4"	Blue	(100 pcs/Bag)
<b>RTT516B</b>	16/14 ga.	5/16"	Blue	(100 pcs/Bag)
<b>RTT38B</b>	16/14ga.	3/8"	Blue	(100 pcs/Bag)
<b>RTT8Y</b>	12/10 ga.	#8	Yellow	(100 pcs/Bag)
<b>RTT10Y</b>	12/10 ga.	#10	Yellow	(100 pcs/Bag)
<b>RTT14Y</b>	12/10 ga.	1/4"	Yellow	(100 pcs/Bag)
<b>RTT516Y</b>	12/10 ga.	5/16"	Yellow	(100 pcs/Bag)
<b>RTT38Y</b>	12/10 ga.	3/8"	Yellow	(100 pcs/Bag)
<b>RTT12Y</b>	12/10 ga.	1/2"	Yellow	(100 pcs/Bag)
<b>RTT838R</b>	8 ga.	3/8"	Red	(25 pcs/Bag)



### Spade Terminals

<b>ST6R</b>	22/18 ga.	#6	Red	(100 pcs/Bag)
<b>ST8R</b>	22/18 ga.	#8	Red	(100 pcs/Bag)
<b>ST10R</b>	22/18 ga.	#10	Red	(100 pcs/Bag)
<b>ST6B</b>	16/14 ga.	#6	Blue	(100 pcs/Bag)
<b>ST8B</b>	16/14 ga.	#8	Blue	(100 pcs/Bag)
<b>ST10B</b>	16/14 ga.	#10	Blue	(100 pcs/Bag)
<b>ST6Y</b>	12/10 ga.	#8	Yellow	(100 pcs/Bag)
<b>ST10Y</b>	12/10 ga.	#10	Yellow	(100 pcs/Bag)
<b>ST88R</b>	8 ga.	#8	Red	(25 pcs/Bag)



### Heatshrinkable Butt Connectors

<b>HSBCR</b>	22/18 ga.	Red	(50 pcs/Bag)
<b>HSBCB</b>	16/14 ga.	Blue	(50 pcs/Bag)
<b>HSBCY</b>	12/10 ga.	Yellow	(50 pcs/Bag)





### Heatshrinkable Ring Terminals

<b>HSRT10R</b>	22/18 ga.	#10	Red	(50 pcs/Bag)
<b>HSRT10B</b>	16/14 ga.	#10	Blue	(50 pcs/Bag)
<b>HSRT38Y</b>	12/10 ga.	3/8"	Yellow	(50 pcs/Bag)



### Heatshrinkable Ring Terminals

<b>HSRT6R</b>	# 6	Red	(50pcs/Bag)
<b>HSRT8R</b>	# 8	Red	(50pcs/Bag)
<b>HSRT10R</b>	# 10	Red	(50pcs/Bag)
<b>HSRT516R</b>	# 516	Red	(50pcs/Bag)



### Heatshrinkable Ring Terminals

<b>HSRT6B</b>	# 6	Blue	(50pcs/Bag)
<b>HSRT8B</b>	# 8	Blue	(50pcs/Bag)
<b>HSRT10B</b>	# 10	Blue	(50pcs/Bag)
<b>HSRT14B</b>	# 14	Blue	(50pcs/Bag)
<b>HSRT516B</b>	# 516	Blue	(50pcs/Bag)
<b>HSRT38B</b>	# 38	Blue	(50pcs/Bag)



### Heatshrinkable Ring Terminals

<b>HSRT8Y</b>	# 8	Yellow	(50pcs/Bag)
<b>HSRT10Y</b>	# 10	Yellow	(50pcs/Bag)
<b>HSRT14Y</b>	# 14	Yellow	(50pcs/Bag)
<b>HSRT516Y</b>	# 516	Yellow	(50pcs/Bag)
<b>HSRT38Y</b>	# 38	Yellow	(50pcs/Bag)
<b>HSRT12Y</b>	# 12	Yellow	(50pcs/Bag)



### Heatshrinkable Spade Terminal

<b>HSST6R</b>	#6	Red	(50pcs/Bag)
<b>HSST8R</b>	#8	Red	(50pcs/Bag)
<b>HSST8B</b>	#8	Blue	(50pcs/Bag)
<b>HSST10B</b>	#10	Blue	(50pcs/Bag)
<b>HSST8Y</b>	# 8	Yellow	(50pcs/Bag)
<b>HSST10Y</b>	# 10	Yellow	(50pcs/Bag)
<b>HSST10R</b>	# 10	Red	(50pcs/Bag)
<b>HSST14Y</b>	# 14	Yellow	(50pcs/Bag)



### Heatshrinkable Female Disconnect

<b>HSFD25R</b>	# 25	Red	(50pcs/Bag)
<b>HSFD25B</b>	# 25	Blue	(50pcs/Bag)
<b>HSFD25Y</b>	# 25	Yellow	(50pcs/Bag)



### Heatshrinkable Female Disconnect Fully Insulated

<b>HSFD25FIR</b>	# 25	Red	(50pcs/Bag)
<b>HSFD25FIB</b>	# 25	Blue	(50pcs/Bag)
<b>HSFD25FIY</b>	# 25	Yellow	(50pcs/Bag)



### Heatshrinkable Male Disconnect

<b>HSMD25R</b>	# 25	Red	(50pcs/Bag)
<b>HSMD25B</b>	# 25	Blue	(50pcs/Bag)
<b>HSMD25Y</b>	# 25	Yellow	(50pcs/Bag)

All Terminals in this column are **made in Taiwan.**

# ENSEMBLE CARPET. GRILL CLOTH

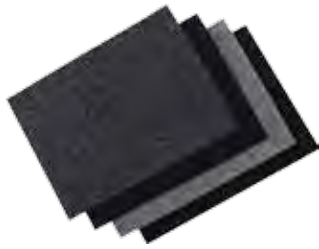

## ENSEMBLE CARPET FOR ENCLOSURES (BACKED)

<b>EN6.150CH</b>	72" X 150 Ft.	CHARCOAL
<b>EN6.150BK</b>	72" X 150 Ft.	BLACK
<b>EN4.150CH</b>	48" X 150 Ft.	CHARCOAL
<b>EN4.150BK</b>	48" X 150 Ft.	BLACK
<b>EN4.150LG</b>	48" X 150 Ft.	LT. GREY
<b>EN4.150BL</b>	48" X 150 Ft.	BLUE
<b>EN3.150BK</b>	36" X 150 Ft.	BLACK
<b>EN4.15CH</b>	48" X 15 Ft.	CHARCOAL
<b>EN4.15BK</b>	48" X 15 Ft.	BLACK
<b>EN4.15LG</b>	48" X 15 Ft.	LT. GREY
<b>EN4.15BL</b>	48" X 15 Ft.	BLUE

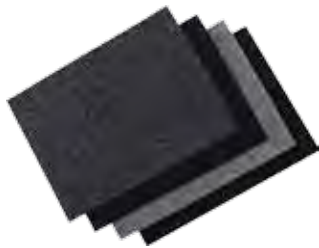

## TRUNK LINER CARPET (UN-BACKED)

<b>TL150CH</b>	54" X 150 Ft.	CHARCOAL
<b>TL150BK</b>	54" X 150 Ft.	BLACK
<b>TL150LG</b>	54" X 150 Ft.	LT. GREY
<b>TL15CH</b>	54" X 15 Ft.	CHARCOAL
<b>TL15BK</b>	54" X 15 Ft.	BLACK
<b>TL15LG</b>	54" X 15 Ft.	LT. GREY



## Grille Cloth

3D Extended in 10 Factory Colors 36" x 66"

<b>GC 3RD</b>	UV Treated	RED
<b>GC 3LS</b>	UV Treated	LIGHT SAND
<b>GC 3MA</b>	UV Treated	MEDIUM ALMOND
<b>GC 3BL</b>	UV Treated	BLUE
<b>GC 3DG</b>	UV Treated	DARK GREY
<b>GC 3BR</b>	UV Treated	BROWN
<b>GC 3LG</b>	UV Treated	LIGHT GREY
<b>GC 3BK</b>	UV Treated	BLACK
<b>GC 3OW</b>	UV Treated	OFF WHITE
<b>GC 3BU</b>	UV Treated	BURGUNDY

3D Extended 66" x 30 ft

<b>GC 30BK</b>	UV Treated	BLACK
<b>GC 30LS</b>	UV Treated	LIGHT SAND

Your Source of Ultimate Technology

# ENSEMBLE CARPET. GRILL CLOTH

# PREMIUM AUTOMOTIVE TRIM CARPET



## PREMIUM AUTOMOTIVE TRIM CARPET (UN-BACKED)

<b>AC4.150MDP</b>	40" X 150 Ft.	MEDIUM DARK PEWTER
<b>AC4.150MGT</b>	40" X 150 Ft.	MEDIUM GRAPHITE
<b>AC4.150MGY</b>	40" X 150 Ft.	MEDIUM GREY
<b>AC4.150CHL</b>	40" X 150 Ft.	CHARCOAL
<b>AC4.150LVA</b>	40" X 150 Ft.	LAVA
<b>AC4.150CND</b>	40" X 150 Ft.	CINDER
<b>AC4.150BLK</b>	40" X 150 Ft.	BLACK
<b>AC4.150BGY</b>	40" X 150 Ft.	BURGUNDY
<b>AC4.150SCL</b>	40" X 150 Ft.	SCARLET
<b>AC4.150PMT</b>	40" X 150 Ft.	PARCHMENT
<b>AC4.150MPT</b>	40" X 150 Ft.	MEDIUM
<b>AC4.150MOC</b>	40" X 150 Ft.	MOCHA
<b>AC4.150MOK</b>	40" X 150 Ft.	MEDIUM
<b>AC4.150MBL</b>	40" X 150 Ft.	MEDIUM BLUE
<b>AC4.150DOB</b>	40" X 150 Ft.	DEEP OCEAN BLUE
<b>AC4.150NVY</b>	40" X 150 Ft.	NAVY
<b>AC4.15MDP</b>	40" X 15 Ft.	MEDIUM DARK PEWTER
<b>AC4.15MGT</b>	40" X 15 Ft.	MEDIUM GRAPHITE
<b>AC4.15MGY</b>	40" X 15 Ft.	MEDIUM GREY
<b>AC4.15CHL</b>	40" X 15 Ft.	CHARCOAL
<b>AC4.15LVA</b>	40" X 15 Ft.	LAVA
<b>AC4.15CND</b>	40" X 15 Ft.	CINDER
<b>AC4.15BLK</b>	40" X 15 Ft.	BLACK
<b>AC4.15BGY</b>	40" X 15 Ft.	BURGUNDY
<b>AC4.15SCL</b>	40" X 15 Ft.	SCARLET
<b>AC4.15PMT</b>	40" X 15 Ft.	PARCHMENT
<b>AC4.15MPT</b>	40" X 15 Ft.	MEDIUM PRAIRIE TAN
<b>AC4.15MOC</b>	40" X 15 Ft.	MOCHA
<b>AC4.15MOK</b>	40" X 15 Ft.	MEDIUM OAK
<b>AC4.15MBL</b>	40" X 15 Ft.	MEDIUM BLUE
<b>AC4.15DOB</b>	40" X 15 Ft.	DEEP OCEAN BLUE
<b>AC4.15NVY</b>	40" X 15 Ft.	NAVY
<b>AC8.150CHL</b>	80" X 150 Ft.	CHARCOAL
<b>AC8.150LVA</b>	80" X 150 Ft.	LAVA
<b>AC8.150CND</b>	80" X 150 Ft.	CINDER
<b>AC8.150BLK</b>	80" X 150 Ft.	BLACK
<b>AC8.150PMT</b>	80" X 150 Ft.	PARCHMENT

# RATTLE BLOCK / SOUND DEADENING

## RATTLE BLOCK

Vibration damping & thermal insulation material which contains unbelievable adhesion that will bond to most surfaces.

The Special formulated foil layer provides additional damping and insulation also providing thermal insulation for the fire wall as well as the trunk floor over the exhaust. Ride in comfort with rattle block.



### LICENSE PLATE KIT RB412

- Included: License Plate Frame,  
1 Piece Rattle Block - 4" x 10" (102Mm x 254Mm), 4 Pieces Foam Gasket



### UNIVERSAL KIT (2 Sheets) RB2.1224

12" x 24" x 2 SHEETS = 4 SQ. FT (0.372 SQ.METRE)

- Block Rattling, Road Noise & Heat.
- Improve Soude Quality And Clarity
- Boost The Sound (Music) Overall
- Easy Cut & Applicable On Any Surface
- Self Adhesive



### SPEAKER KIT (2 Sheets) RB2.1012

12" x 10" x 2 SHEETS = 1.7 SQ. FT (0.155 SQ.METRE)

- Block Speaker Rattling,  
• Road Noise & Heat.
- Improve Sound Quality And Clarity
- Boost The Sound (Music) Overall
- Easy Cut & Applicable On Any Surface
- Self Adhesive



### DOOR KIT (6 Sheets) RB6.1224

12" x 24" x 6 SHEETS = 12 SQ. FT (1.115 SQ.METRE)

- For 2 Doors
- Block Door Panel Rattling,  
• Road Noise & Heat.
- Improve Soude Quality And Clarity
- Boost The Sound (Music) Overall
- Easy Cut & Applicable On Any Surface
- Self Adhesive

# RATTLE BLOCK / SOUND DEADENING



## UNIVERSAL KIT RB1832

18" x 32" x 1 SHEETS = 4 SQ.FT (0.372 SQ.METER)

- Block Rattling, Road Noise & Heat.
- Improve Soude Quality And Clarity
- Boost The Sound (Music) Overall
- Easy Cut & Applicable On Any Surface
- Self Adhesive



## TRUNK KIT RB5.1832

18" x 32" x 5 SHEETS = 20 SQ.FT (1.858 SQ.METER)

- Block Rattling, Road Noise & Heat.
- Improve Soude Quality And Clarity
- Boost The Sound (Music) Overall
- Easy Cut & Applicable On Any Surface
- Self Adhesive



## BULK KIT RB9.1832

18" x 32" x 9 SHEETS = 36 SQ.FT (3.345 SQ.METER)

- Block Rattling, Road Noise & Heat.
- Improve Soude Quality And Clarity
- Boost The Sound (Music) Overall
- Easy Cut & Applicable On Any Surface
- Self Adhesive



## BULK ROLL

### RB1220

12 Inches x 20 Feet = 20 SQ.FT  
1.858 SQ.Meter

### RB1260

12 Inches x 60 Feet = 60 SQ.FT  
5.574 SQ.Meter

### RB1824

18 Inches x 24 Feet = 36 SQ.FT  
3.345 SQ.Meter

### RB1840

18 Inches x 40 Feet = 60 SQ.FT  
5.574 SQ.Meter



RBR-1P  
1 Inch Roller

RBR-2P  
2 Inches Roller

## RATTLE BLOCK HEAVY DUTY SOLID PU ROLLER

- Solid rubber roller that will not scratch surface
- Thick, plated steel frame
- Contoured handle
- Water and rust resistant
- Designed for applying Rattle Block to get the strongest bond possible. Additionally, the roller will help adhere any mounted or glued material.



### Automatic Wire Stripper

**AW5-106**

Strips 10-18 AWG (2.6-1.02mm) wire



### Adjustable Stripper & Cutter

**AWSC-105**

Strips & cuts 10-24 AWG (2.6-0.51mm) wire



### Heavy Duty Cable Cutter

**CC-06**

Cuts any thickness wire upto 1/0 AWG (10mm) with side knife strip upto 8 AWG



### Wire Stripper & Cutter

**WSC-106**

Cuts & strips 10-20 AWG (2.6-0.812mm) wire



### Wire Stripper & Cutter

**WSC-107C**

Cuts & strips 10-20 AWG (2.6-0.812mm) wire



### Flush Mini Cutter

**FMC-5**

Cuts copper, metal & hard plastic



### Mini Crimper

**MC-5**

Crimps 10-22 AWG (2.6-0.644mm) insulated terminal



### Mini Cable Cutter

**MCC-5**

Cuts 4-24 AWG (5.19-0.5mm) wire



### Mini Wire Stripper

**MWS-105**

Strips 10-22 AWG (2.6-0.644mm) wire



### Quick Wire Stripper, Crimper & Cutter

**QW5-108**

Strips & cuts 10-24 AWG (2.6-0.51mm) wire, crimper 10-22 AWG (2.6-0.64mm)



### Quick Wire Stripper & Cutter

**QWSC-104**

Strips 10-24 AWG (2.6-0.51mm) & cuts 24-14 AWG (0.5-1.6mm) wire



### Telephone & Data Crimper, Stripper & Cutter

**TCSC-68**

Cat3, Cat5e, Cat6

# TOOLS



## Cable Tie Gun

### CTG-6

Thicks & cuts Nylon cable tie 0.09"-0.18" (2.2-4.8mm)



## Window & Door Clip Remover

### WDCR2

Removes and installs door handel and window crank clips.

Works on GM, Ford and others, using "C-Type" clips



## Tape Measure

### TM1619

Self Lock Tape Measure

16FT (5 Meters) x 3/4" (19mm)



## Door Panel Fastener Remover

### DPF R6

Removes door panel, plastic fastener, CRV Hardner material with oil & slip resistance handel.

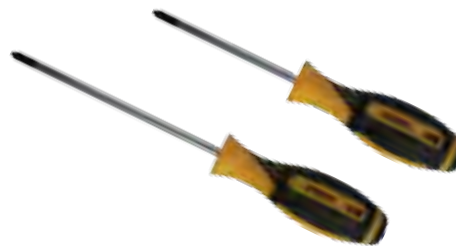

## Screw Driver

Highly Alloyed CRV Material with Oil Slip Resistance Handle.

### SDP246

#2 Philips, 4 Inch (102mm) long, 6mm thickness, Satin Finish.

### SDP266

#2 Philips, 6 Inch (152mm) long, 6mm thickness, Satin Finish.



## Pry & Chisel Tool

Door Panel, Gasket, Dash Kit, Trim Removal and Chisel Set (9 pcs)

### PCT9

Durable Nylon Plastic (Dark Blue)  
Hard set- This kit is designed to satisfy any and every installers needs. Always have the proper tool for any type of job.

### PCT9S

Sylacone Type Plastic (Clear)  
Soft set- The soft set is made specifically for high-end vehicle, eliminating the possibility of scratches and chips.

Applications:

- Automotive Interior & Exterior
- Stereo Installation
- Dash & Trim Removal
- Door Panel Removal
- Emblem Removal
- Trim Removal
- Rubber Grommet Removal



# RADIO REMOVAL KEYS



**RRK-38**  
Radio Removal Keys (38 Pcs)



**EURO-KEY333**  
MERCEDES / AUDI / PASSAT / VW (Jetta-Beetle)  
1950-UP  
• Head Unit Removal Keys  
(1set / 2pcs)



**RRK-FD4**  
• Head Unit Removal Keys  
(1set / 2pcs)



**GM-KEY222DD**  
GENERAL MOTORS  
• Double Din Head Unit Removal Keys  
(1set / 2pcs)



**RRK-EU7**  
VW / AUDI / MOST EUROPEAN  
• Head Unit Removal Keys  
(1set / 2pcs)



**BS9BK**  
• 9" Back Strap



**RRK-MB6**  
Mercedes Radio Removal Keys (3 Sets / 6 Pcs)

REMOVAL  
KEY

50

XSCORPION



# SMD STRIP LED

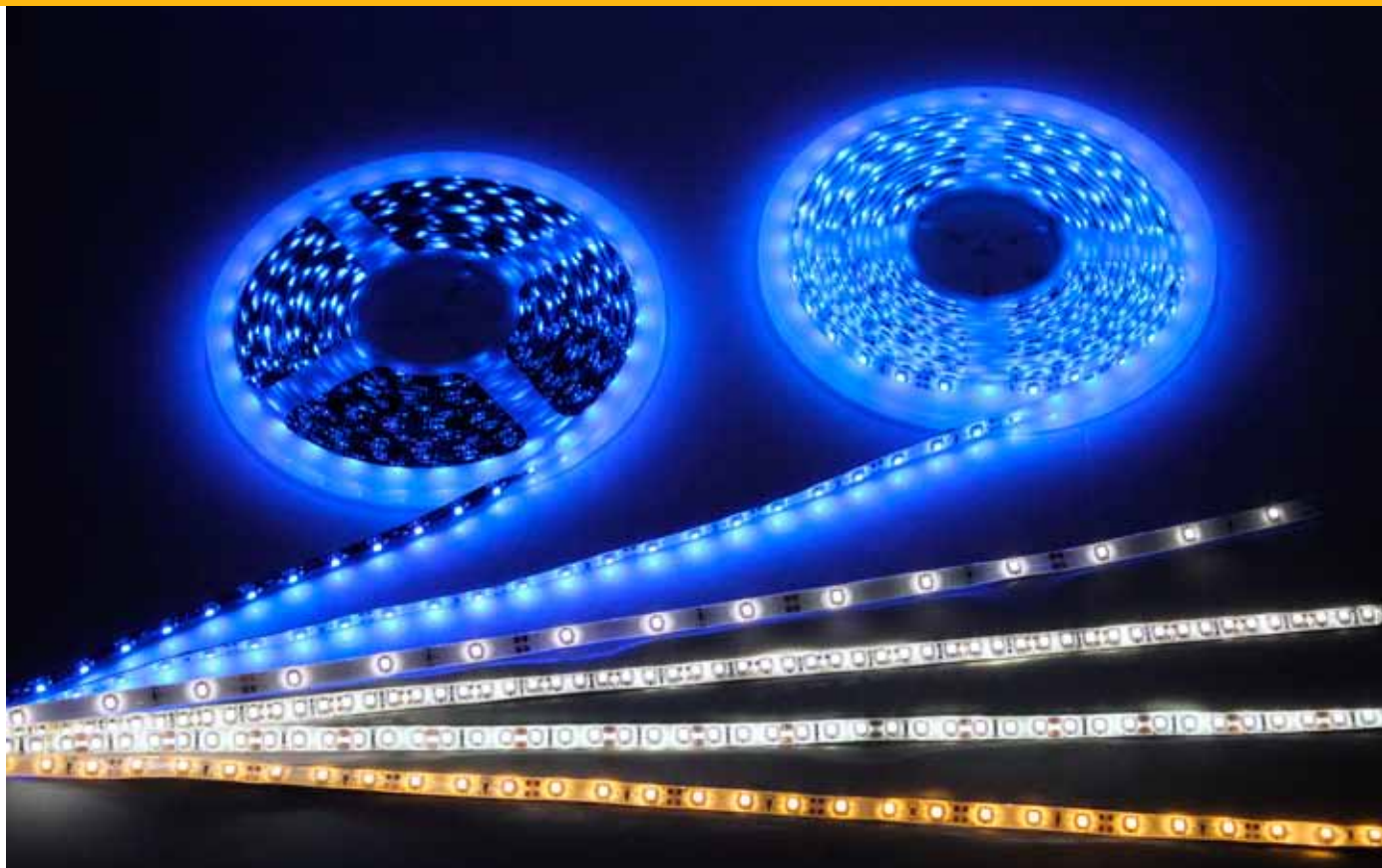

## Ultra Bright SMD Strip LED

<b>SLED 1.9 BL</b>	1ft. ( 30cm )	9 LED's per foot	30 LED's per Meter	BLUE
<b>SLED 1.9 WT</b>	1ft. ( 30cm )	9 LED's per foot	30 LED's per Meter	WHITE
<b>SLED 1.9 RD</b>	1ft. ( 30cm )	9 LED's per foot	30 LED's per Meter	RED
<b>SLED 1.9 GN</b>	1ft. ( 30cm )	9 LED's per foot	30 LED's per Meter	GREEN
<b>SLED 1.18 BL</b>	1ft. ( 30cm )	18 LED's per foot	60 LED's per Meter	BLUE
<b>SLED 1.18 WT</b>	1ft. ( 30cm )	18 LED's per foot	60 LED's per Meter	WHITE
<b>SLED 1.18 RD</b>	1ft. ( 30cm )	18 LED's per foot	60 LED's per Meter	RED
<b>SLED 1.18 GN</b>	1ft. ( 30cm )	18 LED's per foot	60 LED's per Meter	GREEN
<b>SLED 16.9 BL</b>	16.4ft. ( 5meter )	9 LED's per foot	30 LED's per Meter	BLUE
<b>SLED 16.9 WT</b>	16.4ft. ( 5meter )	9 LED's per foot	30 LED's per Meter	WHITE
<b>SLED 16.9 RD</b>	16.4ft. ( 5meter )	9 LED's per foot	30 LED's per Meter	RED
<b>SLED 16.9 GN</b>	16.4ft. ( 5meter )	9 LED's per foot	30 LED's per Meter	GREEN
<b>SLED 16.18 BL</b>	16.4ft. ( 5meter )	18 LED's per foot	60 LED's per Meter	BLUE
<b>SLED 16.18 WT</b>	16.4ft. ( 5meter )	18 LED's per foot	60 LED's per Meter	WHITE
<b>SLED 16.18 RD</b>	16.4ft. ( 5meter )	18 LED's per foot	60 LED's per Meter	RED
<b>SLED 16.18 GN</b>	16.4ft. ( 5meter )	18 LED's per foot	60 LED's per Meter	GREEN

**ULTRA BRIGHT SMD LED STRIP** is designed to be used in a wide variety of home, marine and 12volt accent lighting applications.

"The Strip LED light is a flexible, ultra bright SMD LED light strip with a strong 3M adhesive backing that is available in 4 colors (BLUE, WHITE, RED, GREEN). The LED strip is waterproof, and available in 1FT (30CM) and 16.4FT(5 METER) lengths and can be cut into any desired size .

**LED STRIP APPLICATIONS** : under vehicle lighting, dash, and interior accent lighting, marine, and motorcycles. Under counter, game room, and poolside applications are among many home applications.

# LED

## The Inside Story

XScorpion Enclosures are built with the Highest Quality Materials, combined with High Tech Design and Manufacturing Tools, operated by Skilled Craftsmen. All XScorpion Enclosures are built using 3 / 4 inch High Grade MDF, processed with the latest (CNC) Cutting Equipment to produce exacting box shapes that extract every possible Decibel and Hertz of performance from each vehicle. Precisely cut Dado and Rabbet joints are used throughout, along with a Special Joint Sealant to insure the solid, airtight performance demanded by serious bass enthusiasts. Latex Backed Carpet is applied to the exterior of each enclosure to assure durability while adding a professional appearance





### SINGLE SQUARE VENTED

**SSV-10** 1.3 QFt AIRSPACE  
SINGLE 10" SQUARE ENCLOSURE, SLOT PORTED  
• 12"H x 17"D x 16"W

**SSV-12** 1.8 QFt AIRSPACE  
SINGLE 12" SQUARE ENCLOSURE, SLOT PORTED  
• 14"H x 17"D x 19"W

**SSV-15** 2.6 QFt AIRSPACE  
SINGLE 15" SQUARE ENCLOSURE, SLOT PORTED  
• 17"H x 16"D x 24"W

**SSV-18** 5.9 QFt AIRSPACE  
SINGLE 18" SQUARE ENCLOSURE, SLOT PORTED  
• 19"H x 22"D x 36"W

### DUAL SQUARE VENTED



**DSV-8** 1.4 QFt AIRSPACE  
DUAL 8" SQUARE, SLOT PORTED  
• 10"H x 13"D x 24"W

**DSV-10** 2.7 QFt AIRSPACE  
DUAL 10" SQUARE, SLOT PORTED  
• 12"H x 17"D x 30"W

**DSV-12** 3.4 QFt AIRSPACE  
DUAL 12" SQUARE, SLOT PORTED  
• 14"H x 17"D x 32"W

**DSV-15** 4.5 QFt AIRSPACE  
DUAL 15" SQUARE, SLOT PORTED  
• 16"H x 17"D x 40"W

### DUAL SQUARE BOTTOM VENTED



**DSBV-10** 2.5 QFt AIRSPACE  
DUAL 10" SQUARE, BOTTOM SLOT PORTED  
• 13.5"H x 17"D x 24"W

**DSBV-12** 3.4 QFt AIRSPACE  
DUAL 12" SQUARE, BOTTOM SLOT PORTED  
• 15.75"H x 19"D x 29"W

### DUAL SQUARE SINGLE VENTED



**DS-10SV** 2.5 QFt AIRSPACE  
DUAL 10" SQUARE, SINGLE SLOT PORTED  
• 12"H x 17"D x 29"W

**DS-12SV** 3.2 QFt AIRSPACE  
DUAL 12" SQUARE, SINGLE SLOT PORTED  
• 13.5"H x 17"D x 32"W

### TRIPLE SQUARE VENTED



**TSV-10** 3.4 QFt AIRSPACE  
TRIPLE 10" SQUARE, SLOT PORTED  
**NO DIVIDER**  
• 13"H x 17"D x 34"W

**TSV-10D** 3.4 QFt AIRSPACE  
TRIPLE 10" SQUARE, SLOT PORTED  
**WITH DIVIDERS**  
• 13"H x 17"D x 34"W

**TSV-12** 4.9 QFt AIRSPACE  
TRIPLE 12" SQUARE, SLOT PORTED  
**NO DIVIDER**  
• 16"H x 20"D x 39"W

**TSV-12D** 4.9 QFt AIRSPACE  
TRIPLE 12" SQUARE, SLOT PORTED  
**WITH DIVIDERS**  
• 16"H x 20"D x 39"W



### SINGLE SQUARE [ W / 2 ADJ. AEROPORTS ]

**SS-10AP** 1.9 QFt AIRSPACE  
SINGLE 10" SQUARE WITH ADJUSTABLE AEROPORTS  
• 12"H x 15"D x 24"W

**SS-12AP** 2.8 QFt AIRSPACE  
SINGLE 12" SQUARE WITH ADJUSTABLE AEROPORTS  
• 13.5"H x 17"D x 28.5"W

### SINGLE SQUARE SEALED



**SS 10-.7** 0.7 QFt AIRSPACE  
**SS 12-.7**  
SINGLE 10" / 12" SQUARE, SEALED  
• 11.5"H x 13"D x 14"W

**SS 10-1.0** 1.0 QFt AIRSPACE  
**SS 12-1.0**  
SINGLE 10" / 12" SQUARE, SEALED  
• 12"H x 13"D x 16"W

**SS 10-1.4** 1.4 QFt AIRSPACE  
**SS 12-1.4**  
SINGLE 10" / 12" SQUARE, SEALED  
• 14"H x 17"D x 16"W

**SS 15-2.0** 2.0 QFt AIRSPACE  
SINGLE 15" SQUARE, SEALED  
• 16"H x 14"D x 19"W

### SINGLE HATCHBACK SEALED



**SHF 10-.7** 0.7 QFt AIRSPACE  
**SHF 12-.7**  
SINGLE 10" / 12" HATCHBACK, SEALED  
• 13"H x 8"TD x 13"BD x 14"W

**SHF 10-1.0** 1.0 QFt AIRSPACE  
**SHF 12-1.0**  
SINGLE 10" / 12" HATCHBACK, SEALED  
• 13"H x 11"TD x 16"BD x 16"W

**SHF 10-1.4** 1.4 QFt AIRSPACE  
**SHF 12-1.4**  
SINGLE 10" / 12" HATCHBACK, SEALED  
• 13"H x 14"TD x 19"BD x 16"W

**SHF 15-2.0** 2.0 QFt AIRSPACE  
SINGLE 15" HATCHBACK, SEALED  
• 15"H x 14"TD x 19"BD x 19"W

### DUAL SQUARE SEALED



**DS 10-1.5** 1.5 QFt AIRSPACE  
**DS 12-1.5**  
DUAL 10" / 12" SQUARE, SEALED  
• 11.5"H x 13"D x 28"W

**DS 10-2.0** 2.0 QFt AIRSPACE  
**DS 12-2.0**  
DUAL 10" / 12" SQUARE, SEALED  
• 12"H x 13"D x 32"W

**DS 10-2.7** 2.7 QFt AIRSPACE  
**DS 12-2.7**  
DUAL 10" / 12" SQUARE, SEALED  
• 14"H x 17"D x 32"W

**DS 15-3.4** 3.4 QFt AIRSPACE  
DUAL 15" SQUARE, SEALED  
• 16"H x 14"D x 34"W



## DUAL HATCHBACK

**DHF 10-1.5**  
**DHF 12-1.5** 1.5 QFt AIRSPACE

DUAL 10" / 12", HATCHBACK, SEALED  
• 13"H x 8"TD x 13"BD x 28"W

**DHF 10-2.0**  
**DHF 12-2.0** 2.0 QFt AIRSPACE

DUAL 10" / 12", HATCHBACK, SEALED  
• 13"H x 11"TD x 16"BD x 32"W

**DHF 10-2.7**  
**DHF 12-2.7** 2.7 QFt AIRSPACE

DUAL 10" / 12", HATCHBACK, SEALED  
• 13"H x 14"TD x 19"BD x 32"W

**DHF 15-3.4** 3.4 QFt AIRSPACE

DUAL 15", HATCHBACK, SEALED  
• 16"H x 14"TD x 19"BD x 34"W



## TRIPLE SQUARE

**TS 10-3.4** 3.4 QFt AIRSPACE

TRIPLE 10" SQUARE, SEALED  
**NO DIVIDER**  
• 14"H x 17"D x 34"W

**TS 10-3.4D** 3.4 QFt AIRSPACE

TRIPLE 10" SQUARE, SEALED  
**WITH DIVIDERS**  
• 14"H x 17"D x 34"W

**TS 12-3.8** 3.8 QFt AIRSPACE

TRIPLE 12" SQUARE, SEALED  
**NO DIVIDER**  
• 14"H x 17"D x 39"W

**TS 12-3.8D** 3.8 QFt AIRSPACE

TRIPLE 12" SQUARE, SEALED  
**WITH DIVIDERS**  
• 14"H x 17"D x 39"W



## 6x9 SINGLE WEDGE (Sold in pairs)

**6X 9 SNW** .41 QFt AIRSPACE

HOLDS ONE 6" x 9" SPEAKER  
• 8"H x 8"D x 12"W

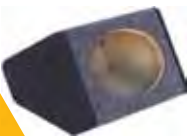

## 6x9 SINGLE PANDA (Sold in pairs)

**6X 9 PANDA** .46 QFt AIRSPACE

HOLDS ONE 6" x 9" SPEAKER  
• 8"H x 9"D x 12"W



## 6x9 SINGLE SQUARE (Sold in pairs)

**6X 9 SNS** .46 QFt AIRSPACE

HOLDS ONE 6" x 9" SPEAKER  
• 10"H x 6"D x 12"W



## 6x9 SINGLE TRAPEZOID (Sold in pairs)

**6X 9 SNT** .35 QFt AIRSPACE

HOLDS ONE 6" x 9" SPEAKER  
• 8"H x 5.5"D x 12"W



## SINGLE VENTED KICKER L5 / L7

**SSVK-10** 1.3 QFt AIRSPACE

SINGLE 10" SQUARE KICKER  
ENCLOSURE, SLOT PORTED  
• 12"H x 17"D x 16"W

**SSVK-12** 1.8 QFt AIRSPACE

SINGLE 12" SQUARE KICKER  
ENCLOSURE, SLOT PORTED  
• 14"H x 17"D x 19"W

**SSVK-15** 2.6 QFt AIRSPACE

SINGLE 15" SQUARE KICKER  
ENCLOSURE, SLOT PORTED  
• 17"H x 16"D x 24"W



## DUAL VENTED KICKER L5 / L7

**DSVK-10** 2.7 QFt AIRSPACE

DUAL 10" SQUARE KICKER  
ENCLOSURE, SLOT PORTED  
• 12"H x 17"D x 32"W

**DSVK-12** 3.4 QFt AIRSPACE

DUAL 12" SQUARE KICKER  
ENCLOSURE, SLOT PORTED  
• 14"H x 17"D x 32"W

**DSVK-15** 4.5 QFt AIRSPACE

DUAL 15" SQUARE KICKER  
ENCLOSURE, SLOT PORTED  
• 17"H x 16"D x 40"W



## SINGLE HATCH BACK KICKER SEALED L5 / L7

**SHFK 10-1.0** 1.0 QFt AIRSPACE

SINGLE 10" HATCHBACK KICKER  
ENCLOSURE, SEALED  
• 13"H x 11"TD x 16"BD x 16"W

**SHFK 12-1.4** 1.4 QFt AIRSPACE

SINGLE 12" HATCHBACK KICKER  
ENCLOSURE, SEALED  
• 13"H x 14"TD x 19"BD x 16"W

**SHFK 15-2.4** 2.4 QFt AIRSPACE

SINGLE 15" HATCHBACK KICKER  
ENCLOSURE, SEALED  
• 17"H x 14"TD x 19"BD x 22"W



## DOUBLE HATCH BACK KICKER SEALED L5 / L7

**DHF K 10-2.2** 2.2 QFt AIRSPACE

DUAL 10" HATCHBACK KICKER  
ENCLOSURE, SEALED  
• 13"H x 11"TD x 16"BD x 32"W

**DHF K 12-2.7** 2.7 QFt AIRSPACE

DUAL 12" HATCHBACK KICKER  
ENCLOSURE, SEALED  
• 13"H x 14"TD x 19"BD x 32"W

**DHF K 15-3.8** 3.8 QFt AIRSPACE

DUAL 15" HATCHBACK KICKER  
ENCLOSURE, SEALED  
• 17"H x 14"TD x 19"BD x 36"W



## SINGLE VENTED DIAMOND AUDIO

**SSVD-10**  
SINGLE 10" SQUARE DIAMOND AUDIO, WITH TRANSMISSION PORT  
• 13"H x 16"D x 16"W

1.3 QFt AIRSPACE

**SSVD-12**  
SINGLE 12" SQUARE DIAMOND AUDIO, WITH TRANSMISSION PORT  
• 15"H x 19"D x 16"W

1.9 QFt AIRSPACE



## DUAL VENTED DIAMOND AUDIO

**DSVD-10**  
DUAL 10" SQUARE DIAMOND AUDIO, WITH TRANSMISSION PORTS  
• 13"H x 16"D x 32"W

2.7 QFt AIRSPACE

**DSVD-12**  
DUAL 12" SQUARE DIAMOND AUDIO, WITH TRANSMISSION PORTS  
• 15"H x 19"D x 32"W

2.9 QFt AIRSPACE



## TRIPLE VENTED DIAMOND AUDIO

**TSVD-10**  
TRIPLE 10" SQUARE DIAMOND AUDIO, WITH TRANSMISSION PORTS  
• 13"H x 16"D x 40"W

3.7 QFt AIRSPACE

**TSVD-12**  
TRIPLE 12" SQUARE DIAMOND AUDIO, WITH TRANSMISSION PORTS  
• 16"H x 20"D x 48"W

6.4 QFt AIRSPACE



## SINGLE BANDPASS VENTED

**SBPV-10**  
SINGLE 10" BANDPASS ENCLOSURE WITH SINGLE SLOT PORT  
• 12"H x 16"D x 19"W

1.4 QFt AIRSPACE

**SBPV-12**  
SINGLE 12" BANDPASS ENCLOSURE WITH SINGLE SLOT PORT  
• 14"H x 16"D x 24"W

2.1 QFt AIRSPACE



## DUAL BANDPASS VENTED

**DBPV-10**  
DUAL 10" BANDPASS ENCLOSURE WITH DUAL SLOT PORTS  
• 13"H x 12"D x 30"W

2.0 QFt AIRSPACE

**DBPV-12**  
DUAL 12" BANDPASS ENCLOSURE WITH DUAL SLOT PORTS  
• 14"H x 16"D x 32"W

2.9 QFt AIRSPACE



## DUAL BANDPASS W/ AEROPORTS

**DBP 10-2.3**  
DUAL 10" BANDPASS ENCLOSURE WITH AEROPORTS  
• 13"H x 16"D x 24"W

2.3 QFt AIRSPACE

**DBP 12-3.0**  
DUAL 12" BANDPASS ENCLOSURE WITH AEROPORTS  
• 14"H x 19"D x 29"W

3.0 QFt AIRSPACE



## DUAL BANDPASS W/ PORTS

**DBP 10-2.7**  
DUAL 10" BANDPASS ENCLOSURE  
• 13"H x 16"D x 29"W

2.7 QFt AIRSPACE

**DBP 12-3.3**  
DUAL 12" BANDPASS ENCLOSURE  
• 14"H x 16"D x 32"W

3.3 QFt AIRSPACE



## SINGLE TRUCK

**ST 8-.7**  
SINGLE 8" TRUCK ENCLOSURE  
• 15.5"H x 4.25"TD x 7.5"BD x 20"W

0.7 QFt AIRSPACE

**ST 10-.7**  
SINGLE 10" TRUCK ENCLOSURE  
• 15.5"H x 4.25"TD x 7.5"BD x 20"W

0.7 QFt AIRSPACE

**ST 12-.7**  
SINGLE 12" TRUCK ENCLOSURE  
• 15.5"H x 4.25"TD x 7.5"BD x 20"W

0.7 QFt AIRSPACE



## DUAL TRUCK

**DT 8-1.2**  
DUAL 8" TRUCK ENCLOSURE  
• 15.5"H x 4.25"TD x 7.5"BD x 32"W

1.2 QFt AIRSPACE

**DT 10-1.2**  
DUAL 10" TRUCK ENCLOSURE  
• 15.5"H x 4.25"TD x 7.5"BD x 32"W

1.2 QFt AIRSPACE

**DT 12-1.2**  
DUAL 12" TRUCK ENCLOSURE  
• 15.5"H x 4.25"TD x 7.5"BD x 32"W

1.2 QFt AIRSPACE



## QUAD SEALED ENCLOSURES

**QS10-3.5**  
10" QUADRUPLE SQUARE SEALED 3.5 CU. FT. WITH DIVIDER  
• 12"H x 15"D x 43"W

1.5 QFt AIRSPACE

**QS12-5.0**  
12" QUADRUPLE SQUARE SEALED 5.0 CU. FT. WITH DIVIDER  
• 12"H x 15"D x 43"W

1.5 QFt AIRSPACE



## MID SIZE TRUCK

**X 8100-10**  
DUAL 10" MID SIZE TRUCK ENCLOSURE  
• 15.5"H x 4.25"TD x 7.5"BD x 44"W

1.7 QFt AIRSPACE

**X 8100-12**  
DUAL 12" MID SIZE TRUCK ENCLOSURE  
• 15.5"H x 4.25"TD x 7.5"BD x 44"W

1.7 QFt AIRSPACE



## FULL SIZE TRUCK

**X 8200-10**  
DUAL 10" FULL SIZE TRUCK ENCLOSURE  
• 15.5"H x 4.25"TD x 7.5"BD x 54"W

2.2 QFt AIRSPACE

**X 8200-12**  
DUAL 12" FULL SIZE TRUCK ENCLOSURE  
• 15.5"H x 4.25"TD x 7.5"BD x 54"W

2.2 QFt AIRSPACE

Mirror



### CAMERO / FIREBIRD 89-93

**X 6100-10**  
HOLDS TWO 10" WOOFERS  
• 15"H x 15"D x 39"W

2.2 QFt  
AIRSPACE

**X 6100-12**  
HOLDS TWO 12" WOOFERS  
• 15"H x 15"D x 39"W

2.2 QFt  
AIRSPACE



### CAMERO / FIREBIRD 94 & UP

**X 6150-10**  
HOLDS TWO 10" WOOFERS  
• 12"H x 21"D x 37"W

2.0 QFt  
AIRSPACE

**X 6150-12**  
HOLDS TWO 12" WOOFERS  
• 12"H x 21"D x 37"W

2.0 QFt  
AIRSPACE



### GM EXTENDED CAB 88 & UP

SINGLE FRONT FIRING  
**X 6200-10**  
HOLDS ONE 10" WOOFER  
• 10"H x 17"D x 30"W

1.0 QFt  
AIRSPACE



SINGLE DOWN FIRING  
**X 6250-10**  
HOLDS ONE 10" WOOFER  
• 10"H x 15"D x 30"W

1.0 QFt  
AIRSPACE



DUAL FRONT FIRING  
**X 6300-10**  
HOLDS TWO 10" WOOFERS  
• 10"H x 17"D x 57"W

1.8 QFt  
AIRSPACE



**X 6300-12**  
HOLDS TWO 12" WOOFERS  
• 11"H x 19"D x 57"W

1.8 QFt  
AIRSPACE



DUAL DOWN FIRING  
**X 6350-10**  
HOLDS TWO 10" WOOFERS  
• 10"H x 15"D x 54"W

1.8 QFt  
AIRSPACE



**X 6350-12**  
HOLDS TWO 12" WOOFERS  
• 10"H x 15"D x 54"W

1.8 QFt  
AIRSPACE



DUAL KICKER DOWN FIRING  
**X 6350-10K**  
HOLDS TWO SQUARE 10" KICKER WOOFERS  
• 10"H x 15"D x 54"W

1.8 QFt  
AIRSPACE



### GM EXTENDED CAB 2000 & UP

UP FIRING  
**X 6380-10**  
HOLDS TWO 10" WOOFERS  
• 9"H x 14"D x 54"W

2.1 QFt  
AIRSPACE



**X 6380-12**  
HOLDS TWO 12" WOOFERS  
• 9"H x 14"D x 54"W

2.1 QFt  
AIRSPACE

DOWN FIRING  
**X 6382-10**  
HOLDS TWO 10" WOOFERS  
• 9"H x 14"D x 54"W

2.1 QFt  
AIRSPACE

**X 6382-12**  
HOLDS TWO 12" WOOFERS  
• 9"H x 14"D x 54"W

2.1 QFt  
AIRSPACE



### GM EXTENDED CAB ( V TRANSMISSION ) 2007-UP

UP FIRING  
**X 6388-10**  
HOLDS TWO 10" WOOFER  
• 8"H x 14"D x 54"W

1.4 QFt  
AIRSPACE



UP FIRING  
**X 6388-12**  
HOLDS TWO 12" WOOFERS  
• 8"H x 14"D x 54"W

1.4 QFt  
AIRSPACE

DOWN FIRING  
**X 6393-12**  
HOLDS TWO 12" WOOFERS  
• 7.5"H x 13"D x 55"W

1.4 QFt  
AIRSPACE



### GMC CREW CAB (2007 CLASSIC CAB ONLY) 2003-07

FRONT FIRING  
**X 6384-10**  
HOLDS TWO 10" WOOFERS  
• 16"H x 3"TD x 7"BD x 48"W

1.5 QFt  
AIRSPACE

FRONT FIRING  
**X 6384-12**  
HOLDS TWO 12" WOOFERS  
• 16"H x 3"TD x 7"BD x 48"W

1.5 QFt  
AIRSPACE



### GM CREW CAB 2005-06

**X 6385-10**  
HOLDS TWO 10" WOOFERS  
• 5.5"H x 14"D x 52"W

1.6 QFt  
AIRSPACE

**X 6385-12**  
HOLDS TWO 12" WOOFERS  
• 5.5"H x 14"D x 52"W

1.6 QFt  
AIRSPACE



### GMC CREW CAB 2500 / 3500 2003-05

FRONT FIRING  
**X 6386-10**  
HOLDS TWO 10" WOOFERS  
• 10"H x 5"TD x 7"BD x 48"W

1.4 QFt  
AIRSPACE



### GMC CREW CAB 2500 / 3500 2006-07 (CLASSIC)

FRONT FIRING  
**X 6387-10**  
 HOLDS TWO 10" WOOFERS  
 • 10"H x 5"TD x 7"BD x 44"W

1.1 QFt  
 AIRSPACE



### CORVETTE 97-04

**X 6392-12**  
 HOLDS ONE 12" WOOFER  
 • 21"H x 6.5"D x 18"W

0.9 QFt  
 AIRSPACE



### GM CREW CAB 2003-04

**X 6390-10**  
 HOLDS TWO 10" WOOFERS  
 • 7"H x 12.75"D x 43"W

1.6 QFt  
 AIRSPACE



### CHEVY TAHOE 2000 & UP

**X 6395-12**  
 HOLDS TWO 12" WOOFERS  
 • 21.5"H x 8"TD x 10.5"BD x 46"W

3.6 QFt  
 AIRSPACE



### CHEVY GMC CREW CAB 2007-08

1500 NONE HD DOWN FIRING  
**X 6389-10**  
 HOLDS TWO 10" WOOFERS  
 • 7"H x 16.5"D x 53"W

1.4 QFt  
 AIRSPACE

1500 NONE HD DOWN FIRING  
**X 6389-12**  
 HOLDS TWO 12" WOOFERS  
 • 7"H x 16.5"D x 53"W

1.4 QFt  
 AIRSPACE



### AVALANCHE / ESCALADE 02 & UP

**X 6398-10**  
 HOLDS TWO 10" WOOFERS  
 • 15"H x 6"D x 51"W

1.6 QFt  
 AIRSPACE



### CHEVY / GMC 2009 REGULAR CAB

BEHIND SEAT  
**X 6391-10**  
 HOLDS TWO 10" WOOFERS  
 • 20"H x 6.5"TD x 8.5"BD x 57"W

2.8 QFt  
 AIRSPACE

BEHIND SEAT  
**X 6391-12**  
 HOLDS TWO 12" WOOFERS  
 • 20"H x 6.5"TD x 8.5"BD x 57"W

2.8 QFt  
 AIRSPACE



### TOYOTA PICKUP 96 & UP

**X 6400-10**  
 HOLDS TWO 10" WOOFERS  
 • 17"H x 5"TD x 8"D x 47"W

1.6 QFt  
 AIRSPACE



### TOYOTA TACOMA 02 & UP

**X 6450-10**  
 HOLDS TWO 10" WOOFERS  
 • 14.5"H x 8"BD x 3.5"TD x 41"W

1.2 QFt  
 AIRSPACE



### CHEVY S10 / S15 EXTENDED CAB All Years

DOWN FIRING  
**X 6396-12**  
 HOLDS TWO 12" WOOFERS  
 • 10.5"H x 15"D x 40"W

2.4 QFt  
 AIRSPACE



### TOYOTA TUNDRA CREW CAB 2005-UP

UP FIRING FITS UNDER REAR SEAT  
**X 6460-12**  
 HOLDS TWO 12" WOOFERS  
 • 15"H x 5"D x 48"W

1.4 QFt  
 AIRSPACE



### CHEVY COLORADO / CANYON EXTENDED CAB 2004-UP

FRONT FIRING  
**X 6399-12**  
 HOLDS TWO 12" WOOFERS  
 • 12"H x 15"D x 39"W

2.4 QFt  
 AIRSPACE



### TOYOTA TUNDRA CREW CAB 2007-UP

DOWN FIRING FITS UNDER REAR SEAT  
**X 6461-12**  
 HOLDS TWO 12" WOOFERS  
 • 17"H x 5"D x 50"W

1.5 QFt  
 AIRSPACE



### CHEVY S10 / S15 REGULAR CAB 1995-03

FRONT FIRING  
**X 7700-10**  
 HOLDS TWO 10" WOOFERS  
 • 12"H x 3"TD x 17.5"BD x 32"W

0.9 QFt  
 AIRSPACE



### NISSAN TITAN EXTENDED CAB 2004-08

DOWN FIRING  
**X 6465-10**  
 HOLDS TWO 10" WOOFERS  
 • 8"H x 12"D x 52"W

1.7 QFt  
 AIRSPACE



### NISSAN TITAN EXTENDED CAB

UP FIRING  
**X 6470-10**  
 HOLDS TWO 10" WOOFERS  
 • 12"H x 7.25"D x 52"W

1.4 QFt  
AIRSPACE



### NISSAN TITAN CREW CAB

UP FIRING  
**X 6480-12**  
 HOLDS TWO 12" WOOFERS  
 • 14.5"H x 7.5"D x 54"W

2.1 QFt  
AIRSPACE



### NISSAN FRONTIER EXTENDED CAB 2002-04

DOWN FIRING  
**X 6484-12**  
 HOLDS TWO 12" WOOFERS  
 • 12"H x 15"D x 37"W

2.7 QFt  
AIRSPACE



### NISSAN FRONTIER CREW CAB 2006

DOWN FIRING  
**X 6485-10**  
 HOLDS TWO 12" WOOFERS  
 • 6"H x 11"D x 30"W

0.7 QFt  
AIRSPACE



### HONDA RIDGELINE 2006-UP

DOWN FIRING  
**X 6500-10**  
 HOLDS TWO 10" WOOFERS  
 • 6"H x 11.5"D x 48"W

1.2 QFt  
AIRSPACE



### WRANGLER / MUSTANG 95 & UP

DOWN FIRING  
**X 6600-10**  
 HOLDS TWO 10" WOOFERS  
 • 16"H x 7"TD x 11"BD x 33"W

2.0 QFt  
AIRSPACE



### DODGE RAM EXTENDED CAB 96-01

**X 6700-10**  
 HOLDS TWO 10" WOOFERS  
 • 9"H x 15"D x 43"W

1.4 QFt  
AIRSPACE



**X 6750-10**  
 HOLDS TWO 10" WOOFERS  
 • 9"H x 15"D x 43"W

1.2 QFt  
AIRSPACE



### DODGE EXTENDED 1995-01

FRONT FIRING REAR PASSENGER OF DRIVER SIDE  
**X 6760-10**  
 HOLDS ONE 110" WOOFER  
 • 12"H x 15"D x 17"W

0.7 QFt  
AIRSPACE



### DODGE EXTENDED 1998-01

DOWN FIRING  
**X 6770-10**  
 HOLDS TWO 10" WOOFERS  
 • 8.5"H x 16.5"D x 45"W

1.4 QFt  
AIRSPACE



### DODGE RAM 02-UP

DUAL UNDER REAR SEAT UP FIRING  
**X 6780-10**  
 HOLDS TWO 10" WOOFERS  
 • 13"H x 8"D x 51"W

1.4 QFt  
AIRSPACE

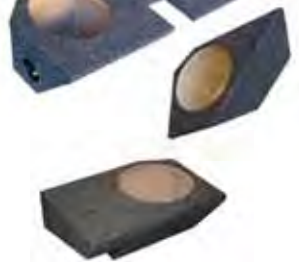

SINGLE BEHIND DRIVER'S SEAT  
**X 6785-10**  
 HOLDS ONE 10" WOOFER  
 • 12"H x 9"D x 18"W

0.7 QFt  
AIRSPACE



### DODGE DAKOTA / MITSUBISHI RAIDER EXTENDED CAB 2006-UP

DOWN FIRING  
**X 6795-10**  
 HOLDS ONE 10" WOOFER  
 • 10"H x 18"D x 11.5"W

0.8 QFt  
AIRSPACE

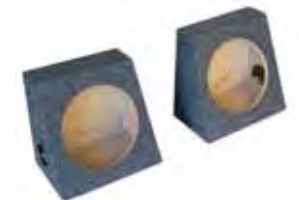

### FORD RANGER 1996-UP (Sold in pairs)

**X 6800-10**  
 HOLDS TWO 10" WOOFERS  
 • 12"H x 3"TD x 8"BD x 13"W

0.8 QFt  
AIRSPACE



### FORD RANGER EXTENDED CAB UP TO 2005 / MAZDA EXTENDED CAB

DOWN FIRING  
**X 6850-12**  
 HOLDS TWO 12" WOOFERS  
 • 7.5"H x 18"D x 39"W

2.1 QFt  
AIRSPACE

ENCLOSURE



## FORD RANGER EXTENDED CAB 2006



DOWN FIRING UNDER REAR SEAT  
**X 6900-12**  
 HOLDS TWO 12" WOOFERS  
 • 8"H x 12"D x 48"W

1.5 QFt  
AIRSPACE

## EXPEDITION / LINCOLN NAVIGATOR



DOWN FIRING  
**X 7000-12**  
 HOLDS TWO 12" WOOFERS  
 • 12"H x 12"TD x 16"BD x 45"W

2.4 QFt  
AIRSPACE

DUAL KICKER DOWN FIRING  
**X 7000-12K**  
 HOLDS TWO 12" SQUARE WOOFERS  
 FOR KICKER L5 AND L7  
 • 12"H x 12"TD x 16"BD x 45"W

2.4 QFt  
AIRSPACE

## FORD EXPLORER SPORT TRACK 2001-05



UP FIRING REAR PASSENGER SIDE UNDER SEAT  
**X 7050-10**  
 HOLDS ONE 10" WOOFER  
 • 6"H x 11"D x 22"W

0.5 QFt  
AIRSPACE

## FORD EXPLORER SPORT TRACK 2006-UP



DOWN FIRING  
**X 7060-12**  
 HOLDS ONE 12" WOOFER  
 • 5.5"H x 14"D x 24"W

0.7 QFt  
AIRSPACE

## GMC SIERRA CREW CAB 88-99



UNDER REAR SEAT DOWN FIRING  
**X 7100-10**  
 HOLDS TWO 10" WOOFERS  
 • 6"H x 15"D x 49"W

1.4 QFt  
AIRSPACE



BEHIND REAR SEAT  
**X 7150-10**  
 HOLDS TWO 10" WOOFERS  
 • 15"H x 5"TD x 6.5"BD x 61"W

2.2 QFt  
AIRSPACE

## FORD MUSTANG 94-04



REAR FIRING  
**X 7350-12**  
 HOLDS TWO 12" WOOFERS  
 • 14"H x 14"D x 30"W

2.5 QFt  
AIRSPACE

**X 7400-12**  
 HOLDS TWO 12" WOOFERS  
 • 19"H x 8"TD x 11"BD x 32"W

2.3 QFt  
AIRSPACE



**X 7400-12K**  
 HOLDS TWO 12" KICKER WOOFERS  
 • 19"H x 8"TD x 11"BD x 32"W

2.3 QFt  
AIRSPACE



## FORD MUSTANG 05-UP

IN REAR FENDER  
**X 7420-12**  
 HOLDS ONE 12" WOOFER

0.7 QFt  
AIRSPACE

• 15"H x 7"D x 15.5"W  
 FRONT FIRING IN TRUNK  
**X 7430-12**  
 HOLDS TWO 12" WOOFERS

3.6 QFt  
AIRSPACE

• 16"H x 14.5"D x 37"W



## FORD MUSTANG 1995-07

DOWN FIRING  
**X 7435-12**  
 HOLDS TWO 12" WOOFERS  
 • 8"H x 15"D x 36"W

1.7 QFt  
AIRSPACE

## CHEVY EL CAMINO

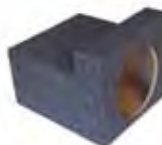

**X 7450-12**  
 HOLDS ONE 12" WOOFER  
 • 14"H x 4.5"TD x 20" BD x 18"W

1.6 QFt  
AIRSPACE

## CHEVY S10 / ISUZU PICKUP 96-UP



**X 7700-12**  
 HOLDS TWO 12" WOOFERS  
 • 16"H x 5"TD x 7"D x 32"W

1.3 QFt  
AIRSPACE

## FORD EXTENDED CAB 97-04



UNDER PASSENGER'S SEAT UP FIRING  
**X 7900-10**  
 HOLDS ONE 10" WOOFER  
 • 5"H x 11"D x 34"W

0.6 QFt  
AIRSPACE



UNDER DRIVER'S SEAT UP FIRING  
**X 7950-10**  
 HOLDS ONE 10" WOOFER  
 • 5.5"H x 11"D x 17"W

0.3 QFt  
AIRSPACE

## FORD SUPER CREW 00-03



**X 7970-10**  
 HOLDS TWO 10" WOOFERS  
 • 13"H x 8"D x 43"W

2.1 QFt  
AIRSPACE

**X 7970-12**  
 HOLDS TWO 12" WOOFERS  
 • 13"H x 8"D x 43"W

2.1 QFt  
AIRSPACE



## FORD REGULAR CAB 04-UP

DOWN FIRING  
**X 7975-10**  
HOLDS TWO 10" WOOFERS  
• 12"H x 10"TD x 13"BD x 58"W

2.5 QFt  
AIRSPACE



## FORD EXTENDED CAB 98-UP

**X 7980-10**  
HOLDS TWO 10" WOOFERS  
• 7"H x 14"D x 50"W

2.0 QFt  
AIRSPACE

**X 7980-12**  
HOLDS TWO 12" WOOFERS  
• 7"H x 14"D x 50"W

2.0 QFt  
AIRSPACE



## FORD F150 98-03

DOWN FIRING  
**X 7982-10**  
HOLDS TWO 10" WOOFERS  
• 12"H x 7"D x 51"W

1.8 QFt  
AIRSPACE



## FORD CREW CAB 2004-UP

**X 7985-10**  
HOLDS TWO 10" WOOFERS  
• 12"H x 7"D x 55"W

1.8 QFt  
AIRSPACE



## FORD F150 SUPER CREW / SUPER CAB 2004-UP

DOWN FIRING  
**X 7986-10**  
HOLDS TWO 10" WOOFERS  
• 6.5"H x 12"D x 48"W

1.4 QFt  
AIRSPACE



## FORD F150 SUPER CREW / SUPER CAB 2004-UP

UP FIRING  
**X 7987-12**  
HOLDS TWO 12" WOOFERS  
• 6"H x 13"D x 50"W

1.4 QFt  
AIRSPACE



## FORD EXTENDED CAB 97-UP

UNDER PASSENGER SEAT  
DOWN FIRE  
**X 7990-10**  
HOLDS ONE 10" WOOFER  
• 7"H x 11"D x 30"W

0.6 QFt  
AIRSPACE

UNDER DRIVER SEAT DOWN  
FIRING  
**X 7995-10**  
HOLDS ONE 10" WOOFER  
• 7"H x 11"D x 13.5"W

0.3 QFt  
AIRSPACE



## FORD F250 / F350 SUPER DUTY / SUPER CAB 2002-UP

UP FIRING  
**X 7988-10**  
HOLDS TWO 10" WOOFERS  
• 5.5"H x 12"D x 50"W

1.2 QFt  
AIRSPACE

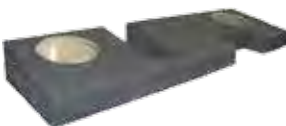

## FORD F250 / F350 SUPER DUTY CREW CAB 2004-UP with power windows models

BEHIND REAR SEAT  
**X 7989-10**  
HOLDS TWO 10" WOOFERS  
• 16"H x 3"TD x 6"BD x 55"W

1.3 QFt  
AIRSPACE



## FORD F250 / 350 SUPER DUTY / SUPER CREW 2004-07

FRONT FIRING  
**X 7999-10**  
HOLDS TWO 10" WOOFERS  
• 17"H x 3"TD x 6"BD x 55"W

1.4 QFt  
AIRSPACE

FRONT FIRING  
**X 7999-12**  
HOLDS TWO 12" WOOFERS  
• 17"H x 3"TD x 6"BD x 55"W

1.4 QFt  
AIRSPACE



## FORD F150 2003

BEHIND SEAT  
**X 7998-10**  
HOLDS TWO 10" WOOFERS  
• 12.5"H x 4.5"TD x 7.75"BD x 49"W

1.5 QFt  
AIRSPACE



## GMC YUKON / ESCALADE

CHEVY TAHOE-DOWN FIRING  
**X 8300-10**  
HOLDS TWO 10" WOOFERS  
• 17"H x 9"TD x 13"BD x 40"W

2.7 QFt  
AIRSPACE

**X 8300-12**  
HOLDS TWO 12" WOOFERS  
• 17"H x 9"TD x 13"BD x 40"W

2.7 QFt  
AIRSPACE



## HUMMER H2

DOWN FIRING  
**X 8400-10**  
HOLDS TWO 10" WOOFERS  
• 13"H x 6.5"D x 41"W

1.5 QFt  
AIRSPACE

ENCLOSURE

# ACCESSORIES. PROMOTIONAL ITEMS

## SPACER



**WS12** 12"

**WS10** 10"

**WS8** 8"  
Woofer Spacer

## CONVERTER



**CV15K.15R** 15"

**CV12K.12R** 12"

**CV10K.10R** 10"  
Converts Square Woofer Hole to Round

## CONVERTER



**CV15.12**

Converts 15" Woofer Hole to 12"

**CV12.10**

Converts 12" Woofer Hole to 10"

**CV10.8**

Converts 10" Woofer Hole to 8"

## TERMINAL



**T4G**  
4" Gold  
Binding Post

**T2S**  
2" With  
Screw

**T2**  
2"  
Push In

## SPEAKER CABLE

(for use inside enclosures)



**S12GA-20**

12ga. 20" with gold female spade

**S12GA-15**

12ga. 15" with gold female spade

## AEROPORT



**AP3.5** **AP4.6** **AP4.10**

3"x5"

4"x6"

4"x10"

## WAFFLE GRILLE

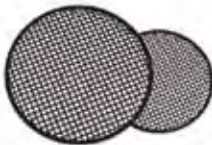

**WG8** **WG10** **WG12** **WG15**  
8" 10" 12" 15"

## CLAMP BANANA PLUG



**C-1**  
Set of 4

**SSB**  
Black

**SSR**  
Red

**D-8M6**  
8"

**D-10M6**  
10"

**D-12M6**  
12"

## DOUBLE RING MESH GRILLE



## SIGN



**SS1**  
32" X 12"

## SPOOL HOLDER



**SHD**  
36"L X 25"D X 33"H

## BANNER



**BNR-10**  
28" X 71"

## SHIRT



**SR-10**  
M, L, XL, XXL









## STICKER



**STKR-3**  
10" X 24"

# APPLICATION GUIDE

## Vehicle Make Color Chart

							
AMC Chrysler Dodge Eagle Jeep Plymouth Renault	Buick Cadillac Chevrolet Geo GMC Hummer Oldsmobile Pontiac Saturn	Ford Lincoln Mercury	Acura Honda Hyundai Isuzu Kia Mazda Mitsubishi	Infiniti Nissan	Lexus Scion Toyota	AlfaRomeo Audi Bertone BMW Daewoo Daihatsu Fiat Jaguar Landrover Mercedes MG Mini	Opel Peugeot Porsche Saab Smart Sterling Subaru Suzuki Volkswagen Volvo Yugo

## Application Guide Legend

- \* This harness works on standard wiring only.  
Not for amplified, JBL, or premium sound systems.
- \*\* Works on standard wiring systems only.  
Not for vehicles with Bose or On-Star systems.
- < Requires factory mounting bracket.
- << Fits Double Din or two Single ISO mount radios.
- ^ Requires locating a switched 12v< power source for  
after-market radios.

APPLICATION  
GUIDE

# BUICK

MAKE/MODEL	YEARS	INSTALLATION KITS	WIRE HARNESS	WIRE HARNESS	ANTENNA ADAPTER	ANTENNA ADAPTER	SPKR ACCESSORIES
		INSTALLER PREFERRED	PLUGS INTO FACTORY HARNESS	PLUGS INTO FACTORY RADIO	AFTER MARKET ANTENNA TO FACTORY ANTENNA	AFTER MARKET ANTENNA TO FACTORY RADIO	GRILLS, BRACKETS & ADAPTERS
ALLURE	05-09				GM-A16	GM-A17	
APOLLO	73-81	N/R			N/R	N/R	
CENTURY	73-77	N/R			N/R	N/R	
CENTURY	78-81	N/R	GM-1342	GM-1341M	N/R	N/R	SS-10
CENTURY	82-87	GM-K8204	GM-1342	GM-1341M	N/R	N/R	SS-10
CENTURY	88-96	GM-K8204-1E	GM-1344	GM-1343M	GM-A16	GM-A17	SS-10
CENTURY	97-05	GM-K9210P/GM-K9210DD<<	GM-1346	GM-1347M	GM-A16	GM-A17	
ELECTRA	71-73	N/R			N/R	N/R	SS-10
ELECTRA	74-77	GM-K8204			N/R	N/R	SS-10
ELECTRA	78-87	GM-K8204	GM-1342	GM-1341M	N/R	N/R	SS-10
ELECTRA	88-90	GM-K8204	GM-1344	GM-1343M	GM-A16	GM-A17	USPA-5060/SS-10
ENCLAVE (w/o OnStar)	08-10	GM-K0610DDP / GM-K0610DD<<		GM-1409M	CHR-A16	CHR-A17	
ENCLAVE (w/OnStar)	08-10	GM-K0610DDP / GM-K0610DD<<			CHR-A16	CHR-A17	
LACROSSE (w/o OnStar)	05-07				GM-A16	GM-A17	
LACROSSE (w/ OnStar & Bose)	05-07				GM-A16	GM-A17	
LACROSSE (w/ OnStar & Bose)	08-09				GM-A16	GM-A17	
LACROSSE (w/ OnStar & Bose)	2010						
LE SABRE	77-79	N/R			N/R	N/R	SS-10
LE SABRE	80-87	GM-K8204	GM-1342	GM-1341M	N/R	N/R	SS-10
LE SABRE	88-89	GM-K8204	GM-1344	GM-1343M	GM-A16	GM-A17	USPA-5060/SS-10
LE SABRE	90-94	GM-K8204	GM-1344	GM-1343M	GM-A16	GM-A17	SS-10
LE SABRE	95-99	GM-K9210P/GM-K9210DD<<	GM-1346	GM-1347M	GM-A16	GM-A17	SS-10
LE SABRE	00-05	GM-K9210P/GM-K9210DD<<	GM-1346R	GM-1346RM	VW-A16L	VW-A17	
LUCERNE (w/o OnStar)	06-10	GM-K0610DDP / GM-K0610DD<<	GM-1406^	GM-1405M	CHR-A16	CHR-A17	
LUCERNE (w/ OnStar)	06-10	GM-K0610DDP / GM-K0610DD<<			CHR-A16	CHR-A17	
PARK AVENUE	85-89	GM-K8204	GM-1342	GM-1341M	N/R	N/R	SS-10
PARK AVENUE	90-94	GM-K9210P/GM-K9210DD<<	GM-1344	GM-1343M	GM-A16	GM-A17	
PARK AVENUE	95-02	GM-K9210P/GM-K9210DD<<	GM-1346	GM-1347M	GM-A16	GM-A17	
PARK AVENUE	03-05	GM-K9210P/GM-K9210DD<<	GM-1346R	GM-1346RM	VW-A16L	VW-A17	
RAINIER (w/o OnStar or amp)	04-07	GM-K9210P/GM-K9210DD<<			GM-A16	GM-A17	
RAINIER (w/ OnStar)	04-07	GM-K9210P/GM-K9210DD<<			GM-A16	GM-A17	
RAINIER (w/ OnStar & Bose)	04-07	GM-K8204			GM-A16	GM-A17	
REATA	90-91	N/R	GM-1344	GM-1343M	GM-A16	GM-A17	
REGAL	73-77	GM-K8204			N/R	N/R	SS-10
REGAL	78-87		GM-1342	GM-1341M	N/R	N/R	
REGAL	88-94	GM-K9210P/GM-K9210DD<<	GM-1344	GM-1343M	GM-A16	GM-A17	
REGAL	95-04	GM-K9210P/GM-K9210DD<<	GM-1346	GM-1347M	GM-A16	GM-A17	
RENDEZVOUS (w/o OnStar or amp)	02-08	GM-K9210P/GM-K9210DD<<			GM-A16	GM-A17	
RENDEZVOUS (w/ OnStar)	02-08	GM-K9210P/GM-K9210DD<<			GM-A16	GM-A17	
RENDEZVOUS (w/ OnStar & Bose)	02-08	N/R			GM-A16	GM-A17	
RIVIERA	71-77	N/R			N/R	N/R	SS-10
RIVIERA	78-83	GM-K8204	GM-1342	GM-1341M	N/R	N/R	SS-10
RIVIERA	84-85		GM-1342	GM-1341M	N/R	N/R	SS-10
RIVIERA	86-91	GM-K8204	GM-1344	GM-1343M	GM-A16	GM-A17	SS-10
RIVIERA	92-95	GM-K9210P/GM-K9210DD<<	GM-1344	GM-1343M	GM-A16	GM-A17	SS-10
RIVIERA	96-99	GM-K8204	GM-1346	GM-1347M	GM-A16	GM-A17	
ROADMASTER	91-94	GM-K9210P/GM-K9210DD<<	GM-1344	GM-1343M	GM-A16	GM-A17	SS-10
ROADMASTER	95-96	N/R	GM-1346	GM-1347M	GM-A16	GM-A17	USPA-5060/SS-10
SKYHAWK	75-77				N/R	N/R	SS-10
SKYHAWK	78-81	N/R	GM-1342	GM-1341M	N/R	N/R	SS-10
SKYHAWK	82-89	GM-K8204	GM-1342	GM-1341M	GM-A16	GM-A17	SS-10
SKYLARK	73-77	N/R			N/R	N/R	SS-10
SKYLARK	78-82	N/R	GM-1342	GM-1341M	N/R	N/R	SS-10
SKYLARK	83-88	GM-K8204	GM-1342	GM-1341M	GM-A16	GM-A17	
SKYLARK	89-91	GM-K8204	GM-1344	GM-1343M	GM-A16	GM-A17	
SKYLARK	92-95	GM-K8204	GM-1344	GM-1343M	GM-A16	GM-A17	SS-10
SKYLARK	96-98	GM-K9210P/GM-K9210DD<<	GM-1346	GM-1347M	GM-A16	GM-A17	
SOMERSET	85-87				N/R	N/R	
TERRAZA (w/o OnStar & no Amp)	05-07				GM-A16	GM-A17	
TERRAZA (w/o OnStar & w/o Bose)	05-07				GM-A16	GM-A17	
TERRAZA (w/OnStar & Bose)	05-07				GM-A16	GM-A17	

\* This harness works on standard wiring only. Not for amplified, JBL, or premium sound systems.  
 \*\* Works on standard wiring systems only. Not for vehicles with Bose or On-Star systems.

< Requires factory mounting bracket.  
 << Fits Double Din or two Single ISO mount radios.  
 ^ Requires locating a switched 12v< power source for after-market radios.

# CADILLAC

MAKE/MODEL	YEARS	INSTALLATION KITS	WIRE HARNESS	WIRE HARNESS	ANTENNA ADAPTER	ANTENNA ADAPTER	SPKR ACCESSORIES
		INSTALLER PREFERRED	PLUGS INTO FACTORY HARNESS	PLUGS INTO FACTORY RADIO	AFTER MARKET ANTENNA TO ANTENNA RADIO	AFTER MARKET ANTENNA TO FACTORY RADIO	GRILLS, BRACKETS & ADAPTERS
ALLANTE	87-93				GM-A16	GM-A17	
CATERA	97-99		GM-1346	GM-1347M	GM-A16	GM-A17	
CATERA	00-01				N/R	N/R	
CIMARRON	82-88	GM-K8204	GM-1342	GM-1341M	N/R	N/R	SS-10
COUPE DEVILLE	73-76	N/R			N/R	N/R	SS-10
COUPE DEVILLE	1977	N/R			N/R	N/R	SS-10
COUPE DEVILLE	78-83		GM-1342	GM-1341M	N/R	N/R	SS-10
COUPE DEVILLE	84-87		GM-1342	GM-1341M	GM-A16	GM-A17	SS-10
COUPE DEVILLE	88-93	GM-K8204-1E	GM-1344	GM-1343M	GM-A16	GM-A17	
COUPE DEVILLE	94-95		GM-1346	GM-1347M	VW-A16L	VW-A17	
CTS	03-07				EURO-A106	EURO-A107	
CTS (w/standard Bose system)	08-09				GM-A16	GM-A17	
DEVILLE	96-99		GM-1346*	GM-1347M	GM-A16	GM-A17	
DEVILLE	00-05				CHR-A16	CHR-A17	
DTS (w/o OnStar or Bose)	06-09				CHR-A16	CHR-A17	
DTS (w/ OnStar or Bose)	06-09				N/R	N/R	
ELDORADO	78-83	N/R	GM-1342	GM-1341M	N/R	N/R	
ELDORADO	84-85	GM-K8204	GM-1342	GM-1341M	N/R	N/R	
ELDORADO	86-87	GM-K8204	GM-1342	GM-1341M	GM-A16	GM-A17	SS-10
ELDORADO	88-89	GM-K8204	GM-1342	GM-1341M	GM-A16	GM-A17	
ELDORADO	90-91	GM-K8204	GM-1344*	GM-1343M	GM-A16	GM-A17	
ELDORADO	92-95	GM-K9210P/GM-K9210DD<<	GM-1344*	GM-1343M	GM-A16	GM-A17	
ELDORADO	96-99				GM-A16	GM-A17	
ELDORADO	00-02				GM-A16	GM-A17	
ESCALADE (w/ OnStar)	99-02	GM-K9505	GM-1344*	GM-1343M	GM-A16	GM-A17	USPA-5060
ESCALADE (w/ OnStar & Bose)	99-02	GM-K9505	GM-1344*	GM-1343M	CHR-A16	CHR-A17	
ESCALADE (w/o OnStar & Bose)	07-09				CHR-A16	CHR-A17	
ESCALADE (w/ OnStar & Bose)	07-09				GM-A16	GM-A17	
ESCALADE ESV	04-06	GM-K9210P/GM-K9210DD<<			GM-A16	GM-A17	
ESCALADE (w/o OnStar)	03-06	GM-K9210P/GM-K9210DD<<			GM-A16	GM-A17	
ESCALADE (w/o OnStar or Bose)	03-06	GM-K9210P/GM-K9210DD<<			N/R	N/R	
FLEETWOOD	73-76	N/R			N/R	N/R	SS-10
FLEETWOOD	1977	N/R			N/R	N/R	SS-10
FLEETWOOD	78-84	N/R	GM-1342	GM-1341M	N/R	N/R	SS-10
FLEETWOOD	85-89	GM-K8204	GM-1342	GM-1341M	GM-A16	GM-A17	
FLEETWOOD	90-93	GM-K8204	GM-1344*	GM-1343M	GM-A16	GM-A17	
FLEETWOOD	94-96		GM-1344*	GM-1343M	GM-A16	GM-A17	
LSE	1996				N/R	N/R	
SEVILLE	1977	N/R			N/R	N/R	
SEVILLE	78-79	N/R	GM-1342	GM-1341M	N/R	N/R	
SEVILLE	76-77	N/R	GM-1342	GM-1341M	N/R	N/R	SS-10
SEVILLE	84-85	GM-K8204	GM-1342	GM-1341M	N/R	N/R	
SEVILLE	86-87	GM-K8204	GM-1342	GM-1341M	GM-A16	GM-A17	
SEVILLE	88-89	GM-K8204	GM-1342	GM-1341M	GM-A16	GM-A17	
SEVILLE	90-91	GM-K8204	GM-1344*	GM-1343M	GM-A16	GM-A17	
SEVILLE	92-95	GM-K9210P/GM-K9210DD<<	GM-1346*	GM-1347M	GM-A16	GM-A17	
SEVILLE (All Models)	96-99		GM-1346*	GM-1347M	GM-A16	GM-A17	
SEVILLE (All Models)	00-05				VW-A16L	VW-A17	
SRX	04-06				CHR-A16	CHR-A17	
SRX	07-09						
STS	06-07						
XLR	04-07				GM-A16	GM-A17	
XLR	08-09						

# CHEVROLET

MAKE/MODEL	YEARS	INSTALLATION KITS	WIRE HARNESS	WIRE HARNESS	ANTENNA ADAPTER	ANTENNA ADAPTER	SPKR ACCESSORIES
		INSTALLER PREFERRED	PLUGS INTO FACTORY HARNESS	PLUGS INTO FACTORY RADIO	AFTER MARKET ANTENNA TO ANTENNA RADIO	AFTER MARKET ANTENNA TO FACTORY RADIO	GRILLS, BRACKETS & ADAPTERS
ASTRO	85-90	GM-K8204-1E	GM-1342	GM-1341M	GM-A16	GM-A17	
ASTRO	91-95	GM-K8204-1E	GM-1344	GM-1343M	GM-A16	GM-A17	USPA-5060
ASTRO	96-05	GM-K9505 / GM-K8205P	GM-1344	GM-1343M	GM-A16	GM-A17	USPA-5060
AVALANCHE (w/o OnStar)	2002	GM-K9505 / GM-K8205P	GM-1344*	GM-1343M*	GM-A16	GM-A17	GSA-FT5465
AVALANCHE (w/OnStar & Bose)	2002	GM-K9505 / GM-K8205P		GM-1343M*	GM-A16	GM-A17	GSA-FT5465
AVALANCHE (w/o OnStar or Bose)	03-06	GM-K9210P/GM-K9210DD<<			GM-A16	GM-A17	GSA-FT5465

\* This harness works on standard wiring only. Not for amplified JBL or premium sound systems.

\*\* Works on standard wiring systems only. Not for vehicles with Bose or On-Star systems.

< Requires factory mounting bracket.

<< Fits Double Din or two Single ISO mount radios.

^ Requires locating a switched 12v< power source for after-market radios.

# CHEVROLET cont.

MAKE/MODEL	YEARS	INSTALLATION KITS	WIRE HARNESS	WIRE HARNESS	ANTENNA ADAPTER	ANTENNA ADAPTER	SPKR ACCESSORIES
		INSTALLER PREFERRED	PLUGS INTO FACTORY HARNESS	PLUGS INTO FACTORY RADIO	AFTER MARKET ANTENNA TO FACTORY ANTENNA	AFTER MARKET ANTENNA TO FACTORY RADIO	GRILLS, BRACKETS & ADAPTERS
AVALANCHE (w/OnStar & Bose)	03-06	GM-K9210P/GM-K9210DD<<			GM-A16	GM-A17	GSA-FT5465
AVALANCHE (w/o OnStar & no Amp)	03-06	GM-K9210P/GM-K9210DD<<			GM-A16	GM-A17	GSA-FT5465
AVALANCHE (w/o OnStar)	07-10	GM-K0610DDP / GM-K0610DD<<			CHR-A16	CHR-A17	
AVALANCHE (w/OnStar or Bose)	07-10	GM-K0610DDP / GM-K0610DD<<			CHR-A16	CHR-A17	
AVEO	09-10		GM-1410	GM-1411M	CHR-A16	CHR-A17	
AVEO/AVEO 5	04-08		DAE-1664	DAE-1663M	N/R	N/R	
AVEO LT	07-08		GM-1410	GM-1411M	CHR-A16	CHR-A17	
AVEO LT SEDAN	07-08		GM-1410	GM-1411M	CHR-A16	CHR-A17	
AVEO WAGON	04-06		DAE-1664	DAE-1663M	N/R	N/R	
BERETTA (w/AC)	88-90		GM-1344	GM-1343M	GM-A16	GM-A17	
BERETTA	91-96	GM-K8204	GM-1344	GM-1343M	GM-A16	GM-A17	SS-10
BLAZER	98-01	GM-K9505 / GM-K8205P	GM-1344	GM-1343M	GM-A16	GM-A17	
BLAZER (standard radio)	2002	GM-K9505 / GM-K8205P	GM-1344	GM-1343M	GM-A16	GM-A17	
BLAZER (oversized radio)	02-04	GM-K9210P/GM-K9210DD<<	GM-1416	GM-1416-1M	GM-A16	GM-A17	
BLAZER (fullsize)	73-77				N/R	N/R	
BLAZER (fullsize)	78-87		GM-1342	GM-1341M	N/R	N/R	
BLAZER (fullsize)	88-91	GM-K8204	GM-1342	GM-1341M	N/R	N/R	
BLAZER (fullsize)	92-94		GM-1344	GM-1343M	GM-A16	GM-A17	
BLAZER S10	82-91	GM-K8204-1E	GM-1342	GM-1341M	N/R	N/R	
BLAZER S10	92-94	GM-K8204-1E	GM-1344	GM-1343M	GM-A16	GM-A17	
BLAZER S10	95-97		GM-1344	GM-1343M	GM-A16	GM-A17	
CABALLERO	78-85		GM-1342	GM-1341M	N/R	N/R	
CAMARO	67-77	N/R			N/R	N/R	
CAMARO	78-81	N/R	GM-1342	GM-1341M	N/R	N/R	
CAMARO	82-89	GM-K8204-1E	GM-1342	GM-1341M	N/R	N/R	
CAMARO	90-92	GM-K8204-1E	GM-1344	GM-1343M	GM-A16	GM-A17	
CAMARO	93-96		GM-1344	GM-1343M	GM-A16	GM-A17	USPA-5060
CAMARO	97-02	GM-K9505 / GM-K8205P	GM-1344	GM-1343M	GM-A16	GM-A17	USPA-5060
CAMARO	2010						
CAMARO BERLINETTA	82-86		GM-1342	GM-1341M	N/R	N/R	
CAPRICE	73-76				N/R	N/R	
CAPRICE	1977				N/R	N/R	SS-10
CAPRICE	78-84		GM-1342	GM-1341M	N/R	N/R	SS-10
CAPRICE	85-86		GM-1342	GM-1341M	N/R	N/R	SS-10
CAPRICE	87-90		GM-1342	GM-1341M	N/R	N/R	SS-10
CAPRICE	91-93	GM-K8204	GM-1344	GM-1343M	GM-A16	GM-A17	
CAPRICE	94-96	GM-K8204 / GM-K8204-1E	GM-1344	GM-1343M	GM-A16	GM-A17	
CAVALIER	82-87	GM-K8204	GM-1342	GM-1341M	N/R	N/R	SS-10
CAVALIER	88-90	GM-K8204	GM-1344	GM-1343M	GM-A16	GM-A17	
CAVALIER	91-94	GM-K8204	GM-1344	GM-1343M	GM-A16	GM-A17	
CAVALIER	95-99	GM-K8204-1E	GM-1344	GM-1343M	GM-A16	GM-A17	
CAVALIER (w/o OnStar)	00-05	GM-K9210P/GM-K9210DD<<			GM-A16	GM-A17	
CAVALIER (w/ OnStar)	00-05	GM-K9210P/GM-K9210DD<<			GM-A16	GM-A17	
CELEBRITY	82-89	GM-K8204-1E	GM-1342	GM-1341M	N/R	N/R	SS-10
CELEBRITY	1990	GM-K8204-1E	GM-1344	GM-1343M	GM-A16	GM-A17	SS-10
CHEVELLE	69-77	N/R			N/R	N/R	
CHEVELLE	1978	N/R			N/R	N/R	SS-10
CHEVETTE	76-77	N/R			N/R	N/R	
CHEVETTE	78-87	N/R	GM-1342	GM-1341M	N/R	N/R	
CITATION	80-84		GM-1342	GM-1341M	N/R	N/R	
CITATION II	1985	GM-K8204	GM-1342	GM-1341M	N/R	N/R	
CLASSIC	2004	GM-K9210P/GM-K9210DD<<			GM-A16	GM-A17	USPA-5060
COBALT (w/o OnStar)	05-06	GM-K0410DDP/GM-K0410DD<<	GM-1404		GM-A16	GM-A17	
COBALT (w/ OnStar & Bose)	05-06	GM-K0410DDP/GM-K0410DD<<			GM-A16	GM-A17	
COBALT (w/o OnStar)	07-10	GM-K0410DDP/GM-K0410DD<<	GM-1406PIO <sup>^</sup>		CHR-A16	CHR-A17	
COBALT (w/o OnStar & Bose)	07-10	GM-K0410DDP/GM-K0410DD<<			CHR-A16	CHR-A17	
COLORADO (w/o OnStar & Bose)	04-10	GM-K9210P/GM-K9210DD<<			GM-A16	GM-A17	
COLORADO (w/ OnStar w/o Bose)	04-10	GM-K9210P/GM-K9210DD<<			GM-A16	GM-A17	
COLORADO (w/ OnStar & Bose)	04-10	GM-K9210P/GM-K9210DD<<			GM-A16	GM-A17	
CORSICA (w/AC)	88-90		GM-1344	GM-1343M	GM-A16	GM-A17	SS-10
CORSICA	91-96	GM-K8204	GM-1344	GM-1343M	GM-A16	GM-A17	SS-10
CORVETTE	68-76				N/R	N/R	
CORVETTE	1977	N/R			N/R	N/R	
CORVETTE	78-83	N/R	GM-1342	GM-1341M	N/R	N/R	
CORVETTE	84-89	GM-K8204	GM-1342	GM-1341M	GM-A16	GM-A17	
CORVETTE	90-96		GM-1344*	GM-1343M	GM-A16	GM-A17	
CORVETTE	97-04	GM-K9505 / GM-K8205P	GM-1344*	GM-1343M	GM-A16	GM-A17	
CORVETTE (w/o OnStar)	05-08				GM-A16	GM-A17	
CORVETTE (w/ OnStar w/o Bose)	05-08				GM-A16	GM-A17	
CORVETTE (w/ OnStar & Bose)	05-10				GM-A16	GM-A17	

\* This harness works on standard wiring only. Not for amplified, JBL, or premium sound systems.

\*\* Works on standard wiring systems only. Not for vehicles with Bose or On-Star systems.

< Requires factory mounting bracket.

<< Fits Double Din or two Single ISO mount radios.

^ Requires locating a switched 12v< power source for after-market radios.

# CHEVROLET cont.

MAKE/MODEL	YEARS	INSTALLATION KITS	WIRE HARNESS	WIRE HARNESS	ANTENNA ADAPTER	ANTENNA ADAPTER	SPKR ACCESSORIES
		INSTALLER PREFERRED	PLUGS INTO FACTORY HARNESS	PLUGS INTO FACTORY RADIO	AFTER MARKET ANTENNA TO ANTENNA	AFTER MARKET ANTENNA TO FACTORY RADIO	GRILLS, BRACKETS & ADAPTERS
CORVETTE	2009				GM-A16	GM-A17	
CRUZE	2011						
EL CAMINO	69-77	N/R			N/R	N/R	
EL CAMINO	78-85		GM-1342	GM-1341M	N/R	N/R	
EL CAMINO	86-88	GM-K8204/GM-K8204-1E<	GM-1342	GM-1341M	N/R	N/R	
EQUINOX (w/o OnStar)	05-06	GM-K0410DDP/GM-K0410DD<<	GM-1404	GM-1417M	GM-A16	GM-A17	
EQUINOX (w/ OnStar & Bose)	05-06	GM-K0410DDP/GM-K0410DD<<			GM-A16	GM-A17	
EQUINOX	07-09	GM-K0610DDP / GM-K0610DD<<			CHR-A16	CHR-A17	
EQUINOX	2011						
EXPRESS VAN (fullsize)	96-00	GM-K9505	GM-1344	GM-1343M	GM-A16	GM-A17	USPA-5060
EXPRESS VAN (fullsize)	01-02	GM-K9210P/GM-K9210DD<<	GM-1416	GM-1416-1M	GM-A16	GM-A17	USPA-5060
EXPRESS VAN (fullsize) (w/o OnStar)	03-07	GM-K9210P/GM-K9210DD<<			GM-A16	GM-A17	
EXPRESS VAN (fullsize) (w/ OnStar)	03-07	GM-K9210P/GM-K9210DD<<			GM-A16	GM-A17	
EXPRESS VAN (w/o OnStar)	08-10	GM-K0610DDP / GM-K0610DD<<			CHR-A16	CHR-A17	
EXPRESS VAN (w/ OnStar & Bose)	08-10	GM-K0610DDP / GM-K0610DD<<			CHR-A16	CHR-A17	
HHR (w/o OnStar)	06-10	GM-K0410DDP/GM-K0410DD<<	GM-1406PIO**	GM-1405M**	CHR-A16	CHR-A17	
HHR (w/ OnStar)	06-10	GM-K0410DDP/C298GM-K0410DD<<			CHR-A16	CHR-A17	
IMPALA	71-77	N/R			N/R	N/R	SS-10
IMPALA	78-84	N/R	GM-1342	GM-1341M	N/R	N/R	SS-10
IMPALA	85-86		GM-1342	GM-1341M	N/R	N/R	SS-10
IMPALA	87-90		GM-1342	GM-1341M	N/R	N/R	SS-10
IMPALA	94-96	GM-K8204/GM-K8204-1E	GM-1344	GM-1343M	GM-A16	GM-A17	
IMPALA (w/o OnStar)	00-05	GM-K9210P/GM-K9210DD<<			GM-A16	GM-A17	
IMPALA (w/ OnStar w/o Bose)	00-05	GM-K9210P/GM-K9210DD<<			GM-A16	GM-A17	
IMPALA (w/ OnStar w/ Bose)	00-05	GM-K9210P/GM-K9210DD<<			GM-A16	GM-A17	
IMPALA (w/o OnStar)	06-09	GM-K0610DDP / GM-K0610DD<<	GM-1406**	GM-1405M**	CHR-A16	CHR-A17	
IMPALA w/OnStar	06-09	GM-K0610DDP / GM-K0610DD<<			CHR-A16	CHR-A17	
KODIAK	94-96		GM-1344	GM-1343M	GM-A16	GM-A17	
LUMINA	90-94	GM-K8204	GM-1344	GM-1343M	GM-A16	GM-A17	SS-10
LUMINA	95-01	GM-K8204 / GM-K8204-1E	GM-1344	GM-1343M	GM-A16	GM-A17	
LUMINA VAN	90-96	GM-K8204	GM-1344	GM-1343M	GM-A16	GM-A17	
LUV TRUCK	73-84				N/R	N/R	
MALIBU	73-77				N/R	N/R	SS-10
MALIBU	78-84		GM-1342	GM-1341M	N/R	N/R	SS-10
MALIBU	97-00	GM-K8204/GM-K8204-1E	GM-1344	GM-1343M	GM-A16	GM-A17	
MALIBU (w/o OnStar w/o Bose)	01-03	GM-K9210P/GM-K9210DD<<	GM-1404	GM-1417M	GM-A16	GM-A17	
MALIBU (w/ OnStar w/o Bose)	01-03	GM-K9210P/GM-K9210DD<<			GM-A16	GM-A17	
MALIBU (w/ OnStar & w/ Bose)	01-03	GM-K9210P/GM-K9210DD<<			GM-A16	GM-A17	
MALIBU (w/o OnStar)	04-07	GM-K0410DDP/GM-K0410DD<<	GM-1404	GM-1417M	GM-A16	GM-A17	
MALIBU (w/ OnStar)	04-07	GM-K0410DDP/GM-K0410DD<<			GM-A16	GM-A17	
MALIBU Classic (w/o OnStar)	2008	GM-K0410DDP/GM-K0410DD<<			GM-A16	GM-A17	
MALIBU Classic (w/ OnStar)	2008	GM-K0410DDP/GM-K0410DD<<			GM-A16	GM-A17	
MALIBU (w/o OnStar)	08-10	GM-K0410DDP/GM-K0410DD<<			CHR-A16	CHR-A17	
MALIBU (w/ OnStar)	08-10	GM-K0410DDP/GM-K0410DD<<			CHR-A16	CHR-A17	
MALIBU MAXX (w/o OnStar)	04-07	GM-K0410DDP/GM-K0410DD<<	GM-1404	GM-1417M	GM-A16	GM-A17	
MALIBU MAXX (w/ OnStar)	04-07	GM-K0410DDP/GM-K0410DD<<			GM-A16	GM-A17	
METRO	98-99	GM-K9210P	ISU-1974	ISU-1975M	N/R	N/R	
METRO	00-01	GM-K9210P	GM-1416	GM-1416-1M	GM-A16	GM-A17	
MONTE CARLO	69-72	N/R			N/R	N/R	SS-10
MONTE CARLO	73-77	N/R			N/R	N/R	
MONTE CARLO	78-85		GM-1342	GM-1341M	N/R	N/R	SS-10
MONTE CARLO	86-88	GM-K8204	GM-1342	GM-1341M	N/R	N/R	
MONTE CARLO	95-99	GM-K8204/GM-K8204-1E	GM-1344	GM-1343M	GM-A16	GM-A17	
MONTE CARLO (w/o OnStar)	00-05	GM-K9210P/GM-K9210DD<<			GM-A16	GM-A17	
MONTE CARLO (w/ OnStar w/o Bose)	00-05	GM-K9210P/GM-K9210DD<<			GM-A16	GM-A17	
MONTE CARLO (w/ OnStar & w/ Bose)	00-05	GM-K9210P/GM-K9210DD<<			GM-A16	GM-A17	
MONTE CARLO (w/o OnStar)	06-08	GM-K0610DDP / GM-K0610DD<<	GM-1406**	GM-1405M**	CHR-A16	CHR-A17	
MONTE CARLO (w/ OnStar)	06-08	GM-K0610DDP / GM-K0610DD<<			CHR-A16	CHR-A17	
MONZA	75-77	N/R			N/R	N/R	
MONZA	78-81	N/R	GM-1342	GM-1341M	N/R	N/R	
NOVA	67-77	N/R			N/R	N/R	SS-10
NOVA	78-80	N/R	GM-1342	GM-1341M	N/R	N/R	SS-10
NOVA	85-88	GM-K8204	GM-1342	GM-1341M	N/R	N/R	
PICKUP (fullsize)	73-77				N/R	N/R	
PICKUP (fullsize)	78-87		GM-1342	GM-1341M	N/R	N/R	
PICKUP (fullsize)	88-94		GM-1344	GM-1343M	GM-A16	GM-A17	
PRISM	98-99		ISU-1974	ISU-1975M	N/R	N/R	
PRISM	00-02		GM-1416	GM-1416-1M	GM-A16	GM-A17	
SILVERADO (w/o OnStar)	95-02	GM-K9505	GM-1344*	GM-1343M	GM-A16	GM-A17	GSA-FT5465
SILVERADO (w/ OnStar)	95-02	GM-K9505	GM-1344*	GM-1343M	GM-A16	GM-A17	GSA-FT5465

\* This harness works on standard wiring only. Not for amplified, JBL, or premium sound systems.  
 \*\* Works on standard wiring systems only. Not for vehicles with Bose or On-Star systems.

< Requires factory mounting bracket.  
 << Fits Double Din or two Single ISO mount radios.  
 ^ Requires locating a switched 12v< power source for after-market radios.



# CHEVROLET cont.

MAKE/MODEL	YEARS	INSTALLATION KITS	WIRE HARNESS	WIRE HARNESS	ANTENNA ADAPTER	ANTENNA ADAPTER	SPKR ACCESSORIES
		INSTALLER PREFERRED	PLUGS INTO FACTORY HARNESS	PLUGS INTO FACTORY RADIO	AFTER MARKET ANTENNA TO FACTORY ANTENNA	AFTER MARKET ANTENNA TO FACTORY RADIO	GRILLS, BRACKETS & ADAPTERS
SILVERADO (w/ OnStar & w/ Bose)	95-02	GM-K9505	GM-1344*	GM-1343M	GM-A16	GM-A17	GSA-FT5465
SILVERADO (w/o OnStar)	03-06	GM-K9210P/GM-K9210DD<<			GM-A16	GM-A17	GSA-FT5465
SILVERADO (w/ OnStar)	03-06	GM-K9210P/GM-K9210DD<<			GM-A16	GM-A17	GSA-FT5465
SILVERADO (w/ OnStar & w/ Bose)	03-06	GM-K9210P/GM-K9210DD<<			GM-A16	GM-A17	GSA-FT5465
SILVERADO CLASSIC	2007	GM-K9210P/GM-K9210DD<<			GM-A16	GM-A17	
SILVERADO (w/ OnStar)	2007	GM-K9210P/GM-K9210DD<<			GM-A16	GM-A17	
SILVERADO (w/ OnStar & w/ Bose)	2007	GM-K9210P/GM-K9210DD<<			GM-A16	GM-A17	
SILVERADO (w/o OnStar or amp)	07-10	GM-K0610DDP / GM-K0610DD<<	GM-1406**	GM-1405M**	CHR-A16	CHR-A17	
SILVERADO (w/o OnStar)	07-10	GM-K0610DDP / GM-K0610DD<<			CHR-A16	CHR-A17	
SILVERADO (w/ OnStar & w/ Bose)	07-10	GM-K0610DDP / GM-K0610DD<<			CHR-A16	CHR-A17	
SPECTRUM	85-88		ISU-1974	ISU-1975M	N/R	N/R	
SPRINT	85-88	DIN MOUNT	ISU-1974	ISU-1975M	N/R	N/R	
SSR	03-06	GM-K9210P/GM-K9210DD<<			GM-A16	GM-A17	
SSR (w/ OnStar & w/o Bose)	03-06	GM-K9210P/GM-K9210DD<<			GM-A16	GM-A17	
SSR (w/ OnStar & w/ Bose)	03-06	GM-K9210P/GM-K9210DD<<			GM-A16	GM-A17	
SUBURBAN	73-77				N/R	N/R	
SUBURBAN	78-88		GM-1342	GM-1341M	N/R	N/R	
SUBURBAN	89-91	GM-K8204	GM-1344	GM-1343M	GM-A16	GM-A17	
SUBURBAN	92-94		GM-1344	GM-1343M	GM-A16	GM-A17	
SUBURBAN (w/o OnStar)	95-02	GM-K9505	GM-1344**	GM-1343M	GM-A16	GM-A17	GSA-FT5465
SUBURBAN (w/ OnStar)	95-02	GM-K9505		GM-1343M	GM-A16	GM-A17	GSA-FT5465
SUBURBAN (w/ OnStar & w/ Bose)	95-02	GM-K9505		GM-1343M	GM-A16	GM-A17	GSA-FT5465
SUBURBAN (w/o OnStar)	03-06	GM-K9210P/GM-K9210DD			GM-A16	GM-A17	GSA-FT5465
SUBURBAN (w/ OnStar & w/o Bose)	03-06	GM-K9210P/GM-K9210DD<<			GM-A16	GM-A17	GSA-FT5465
SUBURBAN (w/ OnStar & w/ Bose)	03-06	GM-K9210P/GM-K9210DD<<			GM-A16	GM-A17	GSA-FT5465
SUBURBAN (w/o OnStar)	07-10	GM-K0610DDP / GM-K0610DD<<	GM-1406**	GM-1405M**	CHR-A16	CHR-A17	
SUBURBAN (w/ OnStar)	07-10	GM-K0610DDP / GM-K0610DD<<			CHR-A16	CHR-A17	
S-10 pickup	82-89	GM-K8204-1E	GM-1342	GM-1341M	N/R	N/R	
S-10 pickup	90-93	GM-K8204-1E	GM-1344	GM-1343M	GM-A16	GM-A17	
S-10 pickup	94-97		GM-1344	GM-1343M	GM-A16	GM-A17	
S-10 pickup	98-01	GM-K8204 / GM-K8204-1E	GM-1344	GM-1343M	GM-A16	GM-A17	
S-10 pickup (standard radio)	2002	GM-K8204 / GM-K8204-1E	GM-1344	GM-1343M	GM-A16	GM-A17	
S-10 pickup (oversized radio) w/o OnStar	02-04	GM-K9210P/GM-K9210DD<<	GM-1416	GM-1415M	GM-A16	GM-A17	
S-10 pickup (w/ OnStar)	02-04	GM-K9210P/GM-K9210DD<<	GM-1416	GM-1415M	GM-A16	GM-A17	
S-10 pickup (w/ OnStar & w/ Bose)	02-04	GM-K9210P/GM-K9210DD<<	GM-1416	GM-1415M	GM-A16	GM-A17	
TAHOE (w/o OnStar or amp)	95-02	GM-K9505/GM-K8205P	GM-1344**	GM-1343M	GM-A16	GM-A17	GSA-FT5465
TAHOE (w/ OnStar & w/o Bose)	95-02	GM-K9505/GM-K8205P	GM-1344**	GM-1343M	GM-A16	GM-A17	GSA-FT5465
TAHOE (w/ OnStar & w/ Bose)	95-02	GM-K9505/GM-K8205P	GM-1344**	GM-1343M	GM-A16	GM-A17	GSA-FT5465
TAHOE (w/o OnStar)	03-06	GM-K9210P/GM-K9210DD<<			GM-A16	GM-A17	GSA-FT5465
TAHOE (w/ OnStar & w/o Bose)	03-06	GM-K9210P/GM-K9210DD<<			GM-A16	GM-A17	GSA-FT5465
TAHOE (w/ OnStar & w/ Bose)	03-06	GM-K9210P/GM-K9210DD<<			GM-A16	GM-A17	GSA-FT5465
TAHOE (w/o OnStar)	07-10	GM-K0610DDP / GM-K0610DD<<	GM-1406**	GM-1405M**	CHR-A16	CHR-A17	
TAHOE (w/OnStar)	07-10	GM-K0610DDP / GM-K0610DD<<			CHR-A16	CHR-A17	
TRACKER	1998	GM-K9210P	ISU-1974	ISU-1975M	N/R	N/R	
TRACKER	1999	GM-K9210P	ISU-1974	ISU-1975M	N/R	N/R	USPA-5060
TRACKER	00-04	GM-K9210P	GM-1416	GM-1406-1M	N/R	N/R	USPA-5060
TRAILBLAZER (w/o OnStar)	02-09	GM-K9210P/GM-K9210DD<<			GM-A16	GM-A17	
TRAILBLAZER (w/ OnStar & w/o Bose)	02-09	GM-K9210P/GM-K9210DD<<			GM-A16	GM-A17	
TRAILBLAZER (w/ OnStar & w/ Bose)	02-09	GM-K9210P/GM-K9210DD<<			GM-A16	GM-A17	
TRAVERSE (w/o OnStar)	09-10	GM-K0610DDP / GM-K0610DD<<			CHR-A16	CHR-A17	
TRAVERSE (w/ OnStar)	09-10	GM-K0610DDP / GM-K0610DD<<			CHR-A16	CHR-A17	
UPLANDER (w/o OnStar)	05-08				GM-A16	GM-A17	
UPLANDER (w/ OnStar)	05-08				GM-A16	GM-A17	
VAN (fullsize)	71-77	N/R			N/R	N/R	
VAN (fullsize)	78-87	N/R	GM-1342	GM-1341M	N/R	N/R	
VAN (fullsize)	88-95	GM-K8204	GM-1344	GM-1343M	GM-A16	GM-A17	
VEGA	71-77	N/R			N/R	N/R	
VENTURE VAN (w/o OnStar)	97-99	GM-K8204 / GM-K8204-1E	GM-1344	GM-1343M	GM-A16	GM-A17	USPA-5060
VENTURE VAN (w/ OnStar)	97-99	GM-K8204 / GM-K8204-1E	GM-1344	GM-1343M	GM-A16	GM-A17	USPA-5060
VENTURE VAN (w/ OnStar & w/ Bose)	97-99	GM-K8204 / GM-K8204-1E	GM-1344	GM-1343M	GM-A16	GM-A17	USPA-5060
VENTURE VAN	01-02	GM-K9210P/GM-K9210DD<<	GM-1416	GM-1406-1M	GM-A16	GM-A17	USPA-5060
VENTURE VAN (w/o OnStar)	2000	GM-K9210P/GM-K9210DD<<	GM-1416	GM-1406-1M	GM-A16	GM-A17	USPA-5060
VENTURE VAN (w/ OnStar & w/ Bose)	2000	GM-K9210P/GM-K9210DD<<			GM-A16	GM-A17	USPA-5060
VENTURE VAN (w/o OnStar)	03-05	GM-K9210P/GM-K9210DD<<	GM-1416	GM-1406-1M	GM-A16	GM-A17	USPA-5060
VENTURE VAN (w/ OnStar)	03-05	GM-K9210P/GM-K9210DD<<	GM-1416	GM-1406-1M	GM-A16	GM-A17	USPA-5060
VENTURE VAN (w/ OnStar & w/ Bose)	03-05	GM-K9210P/GM-K9210DD<<			GM-A16	GM-A17	USPA-5060

\* This harness works on standard wiring only. Not for amplified, JBL, or premium sound systems.

\*\* Works on standard wiring systems only. Not for vehicles with Bose or On-Star systems.

< Requires factory mounting bracket.

<< Fits Double Din or two Single ISO mount radios.

^ Requires locating a switched 12v< power source for after-market radios.

# CHRYSLER

MAKE/MODEL	YEARS	INSTALLATION KITS	WIRE HARNESS	WIRE HARNESS	ANTENNA ADAPTER	ANTENNA ADAPTER	SPKR ACCESSORIES
		INSTALLER PREFERRED	PLUGS INTO FACTORY HARNESS	PLUGS INTO FACTORY RADIO	AFTER MARKET ANTENNA TO FACTORY ANTENNA	AFTER MARKET ANTENNA TO FACTORY RADIO	GRILLS, BRACKETS & ADAPTERS
300 Limited/Touring (non amplified)	05-07	CHR-K0410P	CHR-1638*	CHR-1637M	CHR-A16	CHR-A17	
300 Limited/Touring (w/o amp)	05-07	CHR-K0410P			CHR-A16	CHR-A17	
300 (w/FACTORY amp)	08-10	CHR-K0710B	CHR-1642*	CHR-1641M	EURO-A106	EURO-A107	
300C (w/Nav)	05-07	CHR-K0408DD	CHR-1638*	CHR-1637M	CHR-A16	CHR-A17	
300-M	99-01	CHR-K9807	CHR-1634	CHR-1633M	N/R	N/R	USPA-5060
300-M	02-05	CHR-K9807	CHR-1638	CHR-1637M	CHR-A16	CHR-A17	
ASPEN	76-80	CHR-K7401/CF-K7401			N/R	N/R	USPA-6090
ASPEN (w/oFACTORY amp)	07-08	CHR-K0410P	CHR-1638*		CHR-A16	CHR-A17	
ASPEN (w/Nav)	07-08	CHR-K0408DD	CHR-1638*	CHR-1637M	CHR-A16	CHR-A17	
ASPEN (w/oFACTORY amp)	08-09	CHR-K0710B	CHR-1642*		EURO-A106	EURO-A107	
ASPEN (w/FACTORY amp)	08-09	CHR-K0710B	CHR-1642*		EURO-A106	EURO-A107	
CONCORDE	93-97	CHR-K7401	CHR-1634	CHR-1633M	N/R	N/R	USPA-6090
CONCORDE	98-01	CHR-K9807	CHR-1634	CHR-1633M	N/R	N/R	USPA-5060
CONCORDE	02-04	CHR-K9807	CHR-1638	CHR-1637M	CHR-A16	CHR-A17	
CONQUEST	84-86		UI-1990		N/R	N/R	USPA-6090
CONQUEST	87-89		CI-1610		N/R	N/R	
CROSSFIRE	04-08	DIN MOUNT	VW-11004	VW-12000M	EURO-A108	EURO-A107	
FIFTH AVE	79-93	CHR-K7401/CF-K7401			N/R	N/R	USPA-6090
LEBARON	77-81	CHR-K7401/CF-K7401			N/R	N/R	USPA-6090
LEBARON	82-86	CHR-K7401/CF-K7401			N/R	N/R	USPA-6090
LEBARON	87-95	CHR-K7401/CF-K7401	CHR-1634	CHR-1633M	N/R	N/R	USPA-6090
LEBARON GTS	85-89	CHR-K7401/CF-K7401	CHR-1634	CHR-1633M	N/R	N/R	USPA-6090
MASERATI TC	89-91	CHR-K7401/CF-K7401	CHR-1634	CHR-1633M	N/R	N/R	USPA-6090
NEW YORKER	69-74	N/R			N/R	N/R	USPA-6090
NEW YORKER	75-78	CHR-K7401/CF-K7401			N/R	N/R	USPA-6090
NEW YORKER	79-93	CHR-K7401/CF-K7401			N/R	N/R	USPA-6090
NEW YORKER	94-97	CHR-K7401/CF-K7401	CHR-1634	CHR-1633M	N/R	N/R	
PACIFICA	04-08		CHR-1638**	CHR-1637M	CHR-A16	CHR-A17	
PT CRUISER	2001	CHR-K9807	CHR-1634	CHR-1633M	N/R	N/R	
PT CRUISER	02-05	CHR-K9807	CHR-1638	CHR-1637M	CHR-A16	CHR-A17	
PT CRUISER (w/oFACTORY amp)	06-10	CHR-K0410P	CHR-1638	CHR-1637M	CHR-A16	CHR-A17	
PT CRUISER (w/FACTORY amp)	06-10	CHR-K0410P	CHR-1638	CHR-1637M	CHR-A16	CHR-A17	
SEBRING	95-00	CHR-K7401/CF-K7401	CHR-1634	CHR-1633M	N/R	N/R	USPA-5060/USPA-6090
SEBRING	2001	CHR-K9807	CHR-1634	CHR-1633M	CHR-1633M		USPA-5060
SEBRING	02-06	CHR-K9807	CHR-1638*	CHR-1637M	CHR-A16	CHR-A17	
SEBRING / CONVERTIBLE	07-10	CHR-K0710B	CHR-1642*	CHR-1641M	EURO-A106	EURO-A107	
TOWN & COUNTRY	90-95	CHR-K7401/CF-K7401	CHR-1634	CHR-1633M	N/R	N/R	
TOWN & COUNTRY	96-00	CF-K7401/CHR-K7401	CHR-1634	CHR-1633M	N/R	N/R	
TOWN & COUNTRY	2001	CHR-K9807	CHR-1634	CHR-1633M	N/R	N/R	
TOWN & COUNTRY	02-07	CHR-K9807	CHR-1638*	CHR-1637M	CHR-A16	CHR-A17	
TOWN & COUNTRY	08-10	CHR-K0710B	CHR-1642*	CHR-1641M	EURO-A106	EURO-A107	
VOYAGER	2001	CHR-K9807	CHR-1634	CHR-1633M	N/R	N/R	
VOYAGER	02-03	CHR-K9807	CHR-1638	CHR-1637M	CHR-A16	CHR-A17	

# DODGE

MAKE/MODEL	YEARS	INSTALLATION KITS	WIRE HARNESS	WIRE HARNESS	ANTENNA ADAPTER	ANTENNA ADAPTER	SPKR ACCESSORIES
		INSTALLER PREFERRED	PLUGS INTO FACTORY HARNESS	PLUGS INTO FACTORY RADIO	AFTER MARKET ANTENNA TO FACTORY ANTENNA	AFTER MARKET ANTENNA TO FACTORY RADIO	GRILLS, BRACKETS & ADAPTERS
24	81-82	CHR-K7401/CF-K7401	CHR-1634	CHR-1633M	N/R	N/R	
400K	82-83	CHR-K7401/CF-K7401			N/R	N/R	USPA-6090
600K	1983	CHR-K7401/CF-K7401			N/R	N/R	USPA-6090
600K	84-87	CHR-K7401/CF-K7401	CHR-1634	CHR-1633M	N/R	N/R	USPA-6090
ARIES K	81-83	CHR-K7401/CF-K7401			N/R	N/R	USPA-6090
ARIES K	84-89	CHR-K7401/CF-K7401	CHR-1634	CHR-1633M	N/R	N/R	USPA-6090
AVENGER	95-00	CF-K7401	CHR-1634	CHR-1633M	N/R	N/R	USPA-5060/USPA-6090
AVENGER	07-10	CHR-K0710B	CHR-1642*	CHR-1641M*	EURO-A106	EURO-A107	
BARRACUDA	67-72	N/R			N/R	N/R	USPA-6090
CALIBER (w/oFACTORY amp)	05-08	CHR-K0410P	CHR-1638*	CHR-1637M	CHR-A16	CHR-A17	
CALIBER (w/FACTORY amp)	05-08	CHR-K0410P		CHR-1637M	CHR-A16	CHR-A17	
CALIBER (w/FACTORY Nav)	06-07	CHR-K0408DD	CHR-1638**		CHR-A16	CHR-A17	
CALIBER	09-10	CHR-K0710B			EURO-A106	EURO-A107	
CARAVAN	84-95	CHR-K7401/CF-K7401	CHR-1634	CHR-1633M	N/R	N/R	USPA-6090

\* This harness works on standard wiring only. Not for amplified, JBL, or premium sound systems.  
 \*\* Works on standard wiring systems only. Not for vehicles with Bose or On-Star systems.

< Requires factory mounting bracket.  
 << Fits Double Din or two Single ISO mount radios.  
 ^ Requires locating a switched 12v< power source for after-market radios.

# DODGE cont.

MAKE/MODEL	YEARS	INSTALLATION KITS	WIRE HARNESS	WIRE HARNESS	ANTENNA ADAPTER	ANTENNA ADAPTER	SPKR ACCESSORIES
		INSTALLER PREFERRED	PLUGS INTO FACTORY HARNESS	PLUGS INTO FACTORY RADIO	AFTER MARKET ANTENNA TO FACTORY ANTENNA	AFTER MARKET ANTENNA TO FACTORY RADIO	GRILLS, BRACKETS & ADAPTERS
CARAVAN	96-00	CF-K7401/CHR-K7401	CHR-1634	CHR-1633M	N/R	N/R	USPA-6090
CARAVAN	2001	CHR-K9807	CHR-1634	CHR-1633M	N/R	N/R	
CARAVAN	02-07	CHR-K9807	CHR-1638*	CHR-1637M	CHR-A16	CHR-A17	
CARAVAN	08-10	CHR-K0710B	CHR-1642*	CHR-1641M*	EURO-A106	EURO-A107	
CHALLENGER	69-72	N/R			N/R	N/R	USPA-6090
CHALLENGER	81-84	N/R	UI-1990		N/R	N/R	USPA-6090
CHALLENGER	09-10	CHR-K0710B			EURO-A106	EURO-A107	
CHARGER	71-73	N/R			N/R	N/R	USPA-6090
CHARGER	74-78	CHR-K7401/CF-K7401			N/R	N/R	USPA-6090
CHARGER	79-87	CHR-K7401/CF-K7401			N/R	N/R	
CHARGER (w/FACTORY Nav)	06-07	CHR-K0408DD	CHR-1638**		CHR-A16	CHR-A17	
CHARGER (w/oFACTORY amp)	06-07	CHR-K0410P	CHR-1638**		CHR-A16	CHR-A17	
CHARGER (w/FACTORY amp)	06-07	CHR-K0410P			CHR-A16	CHR-A17	
CHARGER	08-10	CHR-K0710B	CHR-1642		EURO-A106	EURO-A107	
CIRRUS	95-00	CHR-K7401/CF-K7401	CHR-1634	CHR-1633M	N/R	N/R	USPA-5060
COLT	76-84	N/R	UI-1990		N/R	N/R	
COLT	85-86	N/R	UI-1990		N/R	N/R	
COLT	87-92		CI-1610		N/R	N/R	USPA-5060
COLT	93-94		CI-1610		N/R	N/R	USPA-6090
COLT VISTA	92-94		CI-1610		N/R	N/R	USPA-6090
CORDOBA	75-83	CHR-K7401/CF-K7401			N/R	N/R	USPA-6090
CORONET	71-74	N/R			N/R	N/R	USPA-6090
DAKOTA P/U	87-96	CHR-K7401/CF-K7401	CHR-1634	CHR-1633M	N/R	N/R	
DAKOTA P/U	97-00	CHR-K7401/CF-K7401	CHR-1634	CHR-1633M	N/R	N/R	USPA-5060
DAKOTA P/U	2001	CHR-K9807	CHR-1634	CHR-1633M	N/R	N/R	
DAKOTA P/U	02-04	CHR-K9807	CHR-1638	CHR-1637M	CHR-A16	CHR-A17	
DAKOTA P/U (w/oFACTORY amp)	05-07	CHR-K0410P	CHR-1638^	CHR-1637M	CHR-A16	CHR-A17	
DAKOTA P/U (w/FACTORY amp)	05-07	CHR-K0410P		CHR-1637M	CHR-A16	CHR-A17	
DAKOTA	08-10	CHR-K0710B	CHR-1642*		EURO-A106	EURO-A107	
D-50 P/U	79-80	N/R	CI-1610		N/R	N/R	
D-50 P/U	81-86	N/R	CI-1610		N/R	N/R	
D-50 RAM P/U	87-91		CI-1610		N/R	N/R	
DART	69-76	N/R			N/R	N/R	USPA-6090
DAYTONA	84-94	CHR-K7401/CF-K7401	CHR-1634	CHR-1633M	N/R	N/R	USPA-6090
DEMON	69-76	N/R			N/R	N/R	USPA-6090
DIPLOMAT	77-89	CHR-K7401/CF-K7401			N/R	N/R	USPA-6090
DURANGO	98-00	CHR-K7401/CF-K7401	CHR-1634	CHR-1633M	N/R	N/R	USPA-5060
DURANGO	2001	CHR-K9807	CHR-1634	CHR-1633M	N/R	N/R	USPA-5060
DURANGO	02-03	CHR-K9807	CHR-1638	CHR-1637M	CHR-A16	CHR-A17	USPA-5060
DURANGO (w/oFACTORY amp)	04-07	CHR-K0410P	CHR-1638**	CHR-1637M	CHR-A16	CHR-A17	
DURANGO (w/FACTORY amp)	04-07	CHR-K0410P		CHR-1637M	CHR-A16	CHR-A17	
DURANGO (w/factory Nav)	04-07	CHR-K0408DD	CHR-1638**	CHR-1637M	CHR-A16	CHR-A17	
DURANGO LIMITED	2008	CHR-K0410P		CHR-1637M	CHR-A16	CHR-A17	
DURANGO	08-10	CHR-K0710B	CHR-1642*	CHR-1641M*	EURO-A106	EURO-A107	
DUSTER	69-76	N/R			N/R	N/R	USPA-6090
DYNASTY	88-93	CHR-K7401/CF-K7401	CHR-1634	CHR-1633M	N/R	N/R	USPA-6090
ECLASS	84-90	CHR-K7401/CF-K7401	CHR-1634	CHR-1633M	N/R	N/R	USPA-6090
FURY	75-78	CHR-K7401/CF-K7401			N/R	N/R	USPA-6090
GRAND CARAVAN	08-10	CHR-K0710B	CHR-1642*		EURO-A106	EURO-A107	
GRAND FURY	75-89	CHR-K7401/CF-K7401			N/R	N/R	USPA-6090
IMPERIAL	69-78	N/R			N/R	N/R	USPA-6090
IMPERIAL	79-83	CHR-K7401/CF-K7401			N/R	N/R	USPA-6090
IMPERIAL	90-94	CHR-K7401/CF-K7401	CHR-1634	CHR-1633M	N/R	N/R	USPA-6090
INTREPID	93-97	CHR-K7401/CF-K7401	CHR-1634	CHR-1633M	N/R	N/R	USPA-6090
INTREPID	98-01	CHR-K9807	CHR-1634	CHR-1633M	N/R	N/R	USPA-5060/USPA-6090
INTREPID	02-04	CHR-K9807	CHR-1638	CHR-1637M	CHR-A16	CHR-A17	
JOURNEY	09-10	CHR-K0710B	CHR-1642*	CHR-1641M*	EURO-A106	EURO-A107	
LHS	94-97	CHR-K7401/CF-K7401	CHR-1634	CHR-1633M	N/R	N/R	
LHS	98-01	CHR-K9807	CHR-1634	CHR-1633M	N/R	N/R	USPA-5060
LANCER	1984	CHR-K7401/CF-K7401			N/R	N/R	USPA-6090
LANCER	85-89	CHR-K7401/CF-K7401	CHR-1634	CHR-1633M	N/R	N/R	USPA-6090
MAGNUM	78-79	CHR-K7401/CF-K7401			N/R	N/R	USPA-6090
MAGNUM (w/factory Nav)	05-07	CHR-K0408DD	CHR-1638**	CHR-1637M	CHR-A16	CHR-A17	
MAGNUM (w/oFACTORY amp)	05-07	CHR-K0410P	CHR-1638**	CHR-1637M	CHR-A16	CHR-A17	
MAGNUM (w/FACTORY amp)	05-07	CHR-K0410P			CHR-A16	CHR-A17	
MAGNUM	08-10	CHR-K0710B	CHR-1642*		EURO-A106	EURO-A107	
MIRADA	80-83	CHR-K7401/CF-K7401			N/R	N/R	USPA-6090
MONACO	74-78	CHR-K7401/CF-K7401			N/R	N/R	USPA-6090

\* This harness works on standard wiring only. Not for amplified, JBL, or premium sound systems.  
 \*\* Works on standard wiring systems only. Not for vehicles with Bose or On-Star systems.

< Requires factory mounting bracket.  
 << Fits Double Din or two Single ISO mount radios.  
 ^ Requires locating a switched 12v< power source for after-market radios.

# DODGE cont.

MAKE/MODEL	YEARS	INSTALLATION KITS	WIRE HARNESS	WIRE HARNESS	ANTENNA ADAPTER	ANTENNA ADAPTER	SPKR ACCESSORIES
		INSTALLER PREFERRED	PLUGS INTO FACTORY HARNESS	PLUGS INTO FACTORY RADIO	AFTER MARKET ANTENNA TO ANTENNA	AFTER MARKET ANTENNA TO FACTORY RADIO	GRILLS, BRACKETS & ADAPTERS
MONACO	90-92		JP-1622	JP-1623M	N/R	N/R	USPA-6090
NEON	95-99	CHR-K7401/CF-K7401	CHR-1634	CHR-1633M	N/R	N/R	USPA-5060
NEON	00-01	CHR-K9807	CHR-1634	CHR-1633M	N/R	N/R	USPA-5060
NEON	02-01	CHR-K9807	CHR-1638	CHR-1637M	CHR-A16	CHR-A17	USPA-5060
NITRO	07-10	CHR-K0710B	CHR-1642*	CHR-1641M*	EURO-A106	EURO-A107	
NEWPORT	69-74	N/R			N/R	N/R	USPA-6090
NEWPORT	75-83	CHR-K7401/CF-K7401			N/R	N/R	USPA-6090
OMNI	78-83	CHR-K7401/CF-K7401			N/R	N/R	
OMNI	84-90	CHR-K7401/CF-K7401	CHR-1634	CHR-1633M	N/R	N/R	
PICKUP (fullsize)	74-93	CHR-K7401/CF-K7401	CHR-1634	CHR-1633M	N/R	N/R	
RAIDER	87-89		CI-1610		N/R	N/R	
RAM 50	87-94		CI-1610		N/R	N/R	
RAM CHARGER	74-80	CHR-K7401/CF-K7401			N/R	N/R	
RAM CHARGER	81-83	CHR-K7401/CF-K7401			N/R	N/R	
RAM CHARGER	84-93	CHR-K7401/CF-K7401			N/R	N/R	
RAM PICKUP	94-01	CHR-K7401/CF-K7401	CHR-1634	CHR-1633M	N/R	N/R	USPA-6090
RAM PICKUP	02-05	CHR-K9807	CHR-1638*	CHR-1637M	CHR-A16	CHR-A17	
RAM PICKUP (w/factory Nav)	06-08	CHR-K0408DD	CHR-1638**	CHR-1637M	CHR-A16	CHR-A17	
RAM PICKUP (w/oFACTORY amp)	06-08	CHR-K0410P	CHR-1638**	CHR-1637M	CHR-A16	CHR-A17	
RAM PICKUP (w/FACTORY amp)	06-08	CHR-K0408DD		CHR-1637M	CHR-A16	CHR-A17	
RAM PICKUP (w/oFACTORY amp)	09-10	CHR-K0710B	CHR-1642*	CHR-1641M	EURO-A106	EURO-A107	
RAM PICKUP (w/FACTORY amp)	09-10	CHR-K0710B			EURO-A106	EURO-A107	
RAMPAGE	82-83	CHR-K7401/CF-K7401			N/R	N/R	
RAMPAGE	84-87	CHR-K7401/CF-K7401			N/R	N/R	
RELIANT K	77-80	N/R			N/R	N/R	USPA-6090
RELIANT K	81-83	CHR-K7401/CF-K7401			N/R	N/R	USPA-6090
RELIANT K	84-89	CHR-K7401/CF-K7401			N/R	N/R	USPA-6090
SHADOW	87-94	CHR-K7401/CF-K7401	CHR-1634	CHR-1633M	N/R	N/R	USPA-6090
SPIRIT	89-95	CHR-K7401/CF-K7401	CHR-1634	CHR-1633M	N/R	N/R	USPA-6090
SPRINTER	03-06				VW-A18	VW-A17	
SPRINTER (w/base model radio)	07-10		EURO-11010	EURO-11009M	EURO-A106	EURO-A107	
SPRINTER (w/factory Nav)	07-10						
STEALTH	91-96		CI-1610		N/R	N/R	USPA-6090
STRATUS	95-00	CHR-K7401/CF-K7401	CHR-1634	CHR-1633M	N/R	N/R	USPA-5090
STRATUS	2001	CHR-K9807	CHR-1634	CHR-1633M	N/R	N/R	
STRATUS	02-06	CHR-K9807	CHR-1638	CHR-1637M	CHR-A16	CHR-A17	
ST. REGIS	79-81	CHR-K7401/CF-K7401			N/R	N/R	USPA-6090
SUNDANCE	87-94	CHR-K7401/CF-K7401	CHR-1634	CHR-1633M	N/R	N/R	
RAM VAN (fullsize)	78-83	CHR-K7401			N/R	N/R	
RAM VAN (fullsize)	84-89	CHR-K7401			N/R	N/R	
RAM VAN (fullsize)	90-93	CHR-K7401/CF-K7401	CHR-1634	CHR-1633M	N/R	N/R	
RAM VAN (fullsize)	94-01	CHR-K7401/CF-K7401	CHR-1634	CHR-1633M	N/R	N/R	USPA-6090
RAM VAN (fullsize)	02-03	CHR-K9807	CHR-1638	CHR-1637M	CHR-A16	CHR-A17	
VIPER	93-01	CHR-K7401	CHR-1634	CHR-1633M	N/R	N/R	
VIPER	02-08	CHR-K9807	CHR-1638	CHR-1637M	CHR-A16	CHR-A17	

# EAGLE

MAKE/MODEL	YEARS	INSTALLATION KITS	WIRE HARNESS	WIRE HARNESS	ANTENNA ADAPTER	ANTENNA ADAPTER	SPKR ACCESSORIES
		INSTALLER PREFERRED	PLUGS INTO FACTORY HARNESS	PLUGS INTO FACTORY RADIO	AFTER MARKET ANTENNA TO ANTENNA	AFTER MARKET ANTENNA TO FACTORY RADIO	GRILLS, BRACKETS & ADAPTERS
MEDALLION	88-89				N/R	N/R	
PREMIER	88-92		JP-1622	JP-1623M	N/R	N/R	USPA-6090
SUMMIT	89-92		CI-1610		N/R	N/R	
SUMMIT	93-96		CI-1610		N/R	N/R	USPA-5090
SUMMIT WAGON	92-94		CI-1610		N/R	N/R	
TALON	90-94		CI-1610		N/R	N/R	USPA-5090
TALON	95-98		CI-1612	CI-1613M	N/R	N/R	USPA-5090/USPA-6090
VISION	93-97	CHR-K7401/CF-K7401	CHR-1634	CHR-1633M	N/R	N/R	USPA-6090

\* This harness works on standard wiring only. Not for amplified, JBL, or premium sound systems.  
 \*\* Works on standard wiring systems only. Not for vehicles with Bose or On-Star systems.

< Requires factory mounting bracket.  
 << Fits Double Din or two Single ISO mount radios.  
 ^ Requires locating a switched 12v< power source for after-market radios.

# FORD

MAKE/MODEL	YEARS	INSTALLATION KITS	WIRE HARNESS	WIRE HARNESS	ANTENNA ADAPTER	ANTENNA ADAPTER	SPKR ACCESSORIES
		INSTALLER PREFERRED	PLUGS INTO FACTORY HARNESS	PLUGS INTO FACTORY RADIO	AFTER MARKET ANTENNA TO FACTORY ANTENNA	AFTER MARKET ANTENNA TO FACTORY RADIO	GRILLS, BRACKETS & ADAPTERS
AEROSTAR	85-91	CF-K7401	FD-1594	FD-1593M	N/R	N/R	
AEROSTAR	92-97	DIN MOUNT	FD-1594	FD-1593M	N/R	N/R	
ASPIRE	94-97	DIN MOUNT	FD-1594	FD-1593M	N/R	N/R	
BRONCO	73-79				N/R	N/R	
BRONCO	80-82				N/R	N/R	
BRONCO	83-86		FD-1592		N/R	N/R	
BRONCO	87-91		FD-1594*	FD-1593M	N/R	N/R	
BRONCO	92-96	DIN MOUNT	FD-1594	FD-1593M	N/R	N/R	USPA-6090
BRONCO II	83-85	CF-K7401	FD-1592		N/R	N/R	USPA-6090
BRONCO II	86-88	CF-K7401	FD-1594	FD-1593M	N/R	N/R	USPA-6090
BRONCO II	89-92	DIN MOUNT	FD-1594*	FD-1593M	N/R	N/R	USPA-6090
CONTOUR	95-00	DIN MOUNT	FD-1594*	FD-1593M	N/R	N/R	USPA-6090
COURIER	73-82	N/R			N/R	N/R	
CROWN VICTORIA	79-82	CF-K7401			N/R	N/R	USPA-6090
CROWN VICTORIA	83-85	CF-K7401	FD-1592		N/R	N/R	
CROWN VICTORIA	86-89	CF-K7401	FD-1594	FD-1593M	N/R	N/R	
CROWN VICTORIA	90-94	DIN MOUNT	FD-1594	FD-1593M	N/R	N/R	USPA-6090
CROWN VICTORIA	95-97	FM-K9510P	FD-1596	FD-1595M	FD-A16	FD-A17	USPA-6090
CROWN VICTORIA	98-02	FM-K9510P	FD-1598	FD-1597M	FD-A16	FD-A17	USPA-6090
CROWN VICTORIA	03-09	FM-K9510P	FD-5520	FD-5521M			USPA-6090
ECONOLINE VAN	71-74	N/R			N/R	N/R	
ECONOLINE VAN	75-86		FD-1592		N/R	N/R	
ECONOLINE VAN	87-91	FD-K5510	FD-1594	FD-1593M	N/R	N/R	
ECONOLINE VAN/CLUBWGN	92-96	DIN MOUNT	FD-1594	FD-1593M	N/R	N/R	USPA-6090
ECONOLINE VAN/CLUBWGN	1997	FM-K9510P/FM-K9510DD<<	FD-1594	FD-1593M	N/R	N/R	USPA-6090
ECONOLINE VAN/CLUBWGN	98-08	FM-K9510P/FM-K9510DD<<	FD-1598	FD-1597M	N/R	N/R	USPA-6090
ECONOLINE	09-10	FM-K0411P/FM-K0411DD<<	FD-5520	FD-5521M	CHR-A16	CHR-A17	
EDGE	07-10	FM-K0411P/FM-K0411DD<<	FD-5520*	FD-5521M	CHR-A16	CHR-A17	USPA-6090
ESCAPE	01-07	FM-K9510P/FM-K9510DD<<	FD-1598	FD-1597M	N/R		USPA-6090
ESCAPE flatblack (FB)	08-10		FD-45520*	FD-5521M	CHR-A16	CHR-A17	USPA-6090
ESCAPE silver (S)	08-10		FD-45520*	FD-5521M	CHR-A16	CHR-A17	USPA-6090
ESCAPE (w/Nav)	06-07	FM-K9510P/FM-K9510DD<<	FD-1594	FD-1593M			USPA-6090
ESCORT	81-83				N/R	N/R	
ESCORT	84-85		FD-1592		N/R	N/R	
ESCORT	86-90		FD-1594	FD-1593M	N/R	N/R	
ESCORT	91-96	DIN MOUNT	FD-1594	FD-1593M	N/R	N/R	USPA-6090
ESCORT	97-03			FD-1593M	FD-A16	FD-A17	USPA-6090
EXCURSION	00-05	FM-K9510P/FM-K9510DD<<	FD-1598	FD-1597M	N/R	N/R	USPA-6090
EXPEDITION	1997		FD-1596	FD-1595M	FD-A16	FD-A17	USPA-6090
EXPEDITION	98-02	FM-K9510P	FD-1598*	FD-1597M	N/R	N/R	USPA-6090
EXPEDITION (early production)	2003	FM-K9510P/FM-K0106DD<<	FD-1600*	FD-1597M	N/R	N/R	USPA-6090
EXPEDITION	03-06	FM-K9510P/FM-K0106DD<<	FD-5520*		N/R	N/R	USPA-6090
EXPEDITION (w/FACTORY Nav)	07-10	FM-K0411P/FM-K0411DD<<	FD-45520*		CHR-A16	CHR-A17	USPA-6090
EXPLORER	91-94	DIN MOUNT	FD-1594	FD-1593M	N/R	N/R	USPA-6090
EXPLORER	95-97	FM-K9510P	FD-1596*		FD-A16	FD-A17	USPA-6090
EXPLORER 2 door	98-01	FM-K9510P/FM-K9510DD<<	FD-1598*	FD-1597M	FD-A16	FD-A17	USPA-6090
EXPLORER 2 door	02-05	FM-K9510P/FM-K0106DD<<	FD-1598*	FD-1597M	FD-A16	FD-A17	USPA-6090
EXPLORER 4 door	2005	FM-K9510P/FM-K0106DD<<	FD-45520		N/R	N/R	USPA-6090
EXPLORER	06-10	FM-K0411P/FM-K0411DD<<	FD-45520		CHR-A16	CHR-A17	USPA-6090
EXPLORER SPORT TRAC	00-06	FM-K9510P/FM-K0106DD<<	FD-1598*	FD-1597M	N/R	N/R	USPA-6090
EXPLORER SPORT TRAC	07-09	FM-K0411P/FM-K0411DD<<	FD-45520		CHR-A16	CHR-A17	USPA-6090
FAIRMONT	78-81				N/R	N/R	
FAIRMONT	82-83		FD-1592		N/R	N/R	
FESTIVA	88-93				N/R	N/R	
FIESTA	78-83				N/R	N/R	
FLEX	09-10				CHR-A16	CHR-A17	USPA-6090
FOCUS	00-04		FD-1594	FD-1593M	VW-A16L	VW-A17	USPA-6090
FOCUS (w/Blaupunkt radio)	03-04		VW-11000	VW-12000M	VW-A18	VW-A17	USPA-6090
FOCUS	05-07	FM-K0411P/FM-K0411DD<<	FD-5520	FD-5521M	N/R	N/R	USPA-6090
FOCUS	08-10				CHR-A16	CHR-A17	USPA-6090
FUSION	06-09	FM-K0411P/FM-K0411DD<<	FD-5520	FD-5521M	CHR-A16	CHR-A17	USPA-6090
FUSION	2010				CHR-A16	CHR-A17	USPA-6090
500	05-07	FM-K0411P/FM-K0411DD<<	FD-5520		N/R	N/R	USPA-6090
FREESTAR	04-07	FM-K0411P/FM-K0411DD<<	FD-45520		N/R	N/R	USPA-6090
FREESTYLE	05-07	FM-K0411P/FM-K0411DD<<	FD-45520		N/R	N/R	
FUTURA	82-83				N/R	N/R	USPA-6090
GALAXY	73-78	N/R			N/R	N/R	
GRANADA	81-82				N/R	N/R	

\* This harness works on standard wiring only. Not for amplified, JBL, or premium sound systems.  
 \*\* Works on standard wiring systems only. Not for vehicles with Bose or On-Star systems.

< Requires factory mounting bracket.  
 << Fits Double Din or two Single ISO mount radios.  
 ^ Requires locating a switched 12v< power source for after-market radios.

# FORD cont.

MAKE/MODEL	YEARS	INSTALLATION KITS	WIRE HARNESS	WIRE HARNESS	ANTENNA ADAPTER	ANTENNA ADAPTER	SPKR ACCESSORIES
		INSTALLER PREFERRED	PLUGS INTO FACTORY HARNESS	PLUGS INTO FACTORY RADIO	AFTER MARKET ANTENNA TO ANTENNA	AFTER MARKET ANTENNA TO FACTORY RADIO	GRILLS, BRACKETS & ADAPTERS
LTD	71-78				N/R	N/R	
LTD	79-82	FD-K5510			N/R	N/R	
LTD	83-85	FD-K5510	FD-1592		N/R	N/R	
LTD	86-89		FD-1594	FD-1593M	N/R	N/R	
LTD	90-91	DIN MOUNT	FD-1594	FD-1593M	N/R	N/R	USPA-6090
LTD II	72-79	N/R			N/R	N/R	
MAVERICK	69-77	N/R			N/R	N/R	
MUSTANG	71-73	N/R			N/R	N/R	
MUSTANG	74-78				N/R	N/R	
MUSTANG	79-82				N/R	N/R	
MUSTANG	83-84		FD-1592		N/R	N/R	
MUSTANG	85-86		FD-1592		N/R	N/R	
MUSTANG	87-93		FD-1594*	FD-1593M	N/R	N/R	
MUSTANG	94-00	DIN MOUNT	FD-1594*	FD-1593M	N/R	N/R	USPA-6090
MUSTANG	01-04	FM-K9510P/FM-K0106DD<<	FD-1598*	FD-1597M	N/R	N/R	USPA-6090
MUSTANG	05-09	FM-K0411P/FM-K0411DD<<	FD-5520*		N/R	N/R	USPA-6090
MUSTANG (w/ Shaker System)	05-09	FM-K0411P/FM-K0411DD<<	FD-45520		N/R	N/R	USPA-6090
MUSTANG	2010				CHR-A16	CHR-A17	
PICKUP	73-79				N/R	N/R	
PICKUP	80-82				N/R	N/R	
PICKUP F-SERIES	83-86		FD-1592		N/R	N/R	
PICKUP F-SERIES	87-91		FD-1594	FD-1593M	N/R	N/R	
PICKUP F-SERIES	92-96	DIN MOUNT	FD-1594	FD-1593M	N/R	N/R	USPA-6090
PICKUP F-SERIES	97-98		FD-1594*		N/R	N/R	USPA-6090
PICKUP F-SERIES	99-03	FM-K9510P/FM-K9510DD<<	FD-1598*	FD-1597M	N/R	N/R	USPA-6090
PICKUP F-SERIES Superduty	2004	FM-K9510P/FM-K9510DD<<	FD-1598*	FD-1597M	N/R	N/R	USPA-6090
PICKUP F-SERIES Superduty	05-10	FM-K0411P/FM-K0411DD<<	FD-45520		N/R	N/R	USPA-6090
PICKUP F-150 (all new)	04-08	FM-K0411P/FM-K0411DD<<	FD-45520		N/R	N/R	USPA-6090
PICKUP 150 Heritage Model Only	2004	FM-K9510P/FM-K0106DD<<	FD-1598*	FD-1597M	N/R	N/R	USPA-6090
PICKUP F-150 base models	09-10	FM-K0411P/FM-K0411DD<<	FD-5520		CHR-A16	CHR-A17	USPA-6090
PICKUP F-150 all other models	09-10				CHR-A16	CHR-A17	USPA-6090
PINTO	71-80				N/R	N/R	
PROBE	89-92		FD-1594	FD-1593M	N/R	N/R	
PROBE	93-97	DIN MOUNT	FD-1594*	FD-1593M	N/R	N/R	
RANGER	83-85		FD-1592		N/R	N/R	USPA-6090
RANGER	86-88		FD-1594	FD-1593M	N/R	N/R	USPA-6090
RANGER	89-92	DIN MOUNT	FD-1594*	FD-1593M	N/R	N/R	USPA-6090
RANGER	93-94	DIN MOUNT	FD-1594*	FD-1593M	N/R	N/R	USPA-6090
RANGER	95-97	FM-K9510P/FM-K9510DD<<	FD-1596*	FD-1595M	N/R	N/R	USPA-6090
RANGER	98-10	FM-K9510P/FM-K9510DD<<	FD-1598*	FD-1597M	N/R	N/R	USPA-6090
TAURUS	86-89		FD-1594	FD-1593M	N/R	N/R	
TAURUS	90-95	DIN MOUNT	FD-1594*	FD-1593M	N/R	N/R	USPA-6090
TAURUS (w/rotary climate controls)	96-99				FD-A16	FD-A17	USPA-6090
TAURUS (w/electronic climate controls)	96-99				FD-A16	FD-A17	USPA-6090
TAURUS (w/rotary climate controls)	00-07				FD-A16	FD-A17	USPA-6090
TAURUS (w/electronic climate controls)	00-07				FD-A16	FD-A17	USPA-6090
TAURUS	08-09	FM-K0411P/FM-K0411DD<<	FD-45520	FD-5521-IM	CHR-A16	CHR-A17	USPA-6090
TAURUS X	08-09	FM-K0411P/FM-K0411DD<<	FD-45520	FD-5521-IM	CHR-A16	CHR-A17	USPA-6090
TAURUS	2010						
TAURUS SHO	2010						
TEMPO	83-85		FD-1592		N/R	N/R	USPA-6090
TEMPO	86-87		FD-1594	FD-1593M	N/R	N/R	USPA-6090
TEMPO	88-94	DIN MOUNT	FD-1594	FD-1593M	N/R	N/R	USPA-6090
THUNDERBIRD	73-79	N/R			N/R	N/R	USPA-6090
THUNDERBIRD	80-82	CF-K7401			N/R	N/R	
THUNDERBIRD	83-85	CF-K7401	FD-1592		N/R	N/R	USPA-6090
THUNDERBIRD	86-88		FD-1594*	FD-1593M	N/R	N/R	USPA-6090
THUNDERBIRD	89-97	DIN MOUNT	FD-1594*	FD-1593M	N/R	N/R	USPA-6090
THUNDERBIRD	02-05		FD-1600*		N/R	N/R	USPA-6090
TORINO/ELITE	72-76	N/R			N/R	N/R	
TRANSIT CONNECT	2010						
WINDSTAR	95-98	DIN MOUNT	FD-1594*	FD-1593M	N/R	N/R	USPA-6090
WINDSTAR	99-03	FM-K9510P/FM-K9510DD<<	FD-1598*	FD-1597M	N/R	N/R	USPA-6090
ZX-2	97-03			FD-1593M	N/R	N/R	USPA-6090

\* This harness works on standard wiring only. Not for amplified, JBL, or premium sound systems.  
 \*\* Works on standard wiring systems only. Not for vehicles with Bose or On-Star systems.

< Requires factory mounting bracket.  
 << Fits Double Din or two Single ISO mount radios.  
 ^ Requires locating a switched 12v< power source for after-market radios.

MAKE/MODEL	YEARS	INSTALLATION KITS	WIRE HARNESS	WIRE HARNESS	ANTENNA ADAPTER	ANTENNA ADAPTER	SPKR ACCESSORIES
		INSTALLER PREFERRED	PLUGS INTO FACTORY HARNESS	PLUGS INTO FACTORY RADIO	AFTER MARKET ANTENNA TO FACTORY ANTENNA	AFTER MARKET ANTENNA TO FACTORY RADIO	GRILLS, BRACKETS & ADAPTERS
ACADIA (w/o OnStar)	07-10	GM-K0610DDP/GM-K0610DD<<	GM-1406**		CHR-A16	CHR-A17	
ACADIA (w/ OnStar)	07-10	GM-K0610DDP/GM-K0610DD<<					
CANYON (w/o OnStar & no amp)	04-10	GM-K9210P/GM-K9210DD<<			GM-A16	GM-A17	
CANYON (w/o OnStar)	04-10	GM-K9210P/GM-K9210DD<<			GM-A16	GM-A17	
CANYON (w/ OnStar)	04-10	GM-K9210P/GM-K9210DD<<			GM-A16	GM-A17	
CREW CAB DUALY	89-91	GM-K8204	GM-1342	GM-1341M	N/R	N/R	
CREW CAB DUALY	92-94		GM-1344	GM-1343M	GM-A16	GM-A17	
ENVOY	98-01	GM-K8204	GM-1344	GM-1343M	GM-A16	GM-A17	
ENVOY (w/o OnStar & no amp)	02-08	GM-K9210P/GM-K9210DD<<			GM-A16	GM-A17	
ENVOY (w/ OnStar & w/ amp)	02-08	GM-K9210P/GM-K9210DD<<			GM-A16	GM-A17	
ENVOY (w/ OnStar & w/ Bose amp)	02-08	GM-K9210P/GM-K9210DD<<			GM-A16	GM-A17	
JIMMY (fullsize)	73-77				N/R	N/R	
JIMMY (fullsize)	78-87		GM-1342	GM-1341M	N/R	N/R	
JIMMY (fullsize)	89-91	GM-K8204	GM-1344	GM-1343M	GM-A16	GM-A17	
JIMMY (S-15)	82-89	GM-K8204-1E	GM-1342	GM-1341M	N/R	N/R	
JIMMY (S-15)	90-93	GM-K8204-1E	GM-1344	GM-1343M	GM-A16	GM-A17	
JIMMY (S-15)	1994	GM-K8204	GM-1344	GM-1343M	GM-A16	GM-A17	
JIMMY (S-15)	95-97		GM-1344	GM-1343M	GM-A16	GM-A17	
JIMMY	98-01	GM-K8204/GM-K8204-1E	GM-1344	GM-1343M	GM-A16	GM-A17	
JIMMY (standard radio)	2002	GM-K8204/GM-K8204-1E	GM-1344	GM-1343M	GM-A16	GM-A17	
JIMMY (oversized radio)	02-03	GM-K9210P/GM-K9210DD<<	GM-1416	GM-1416-1M	GM-A16	GM-A17	
PICKUP SIERRA (fullsize)	73-77				N/R	N/R	
PICKUP SIERRA (fullsize)	78-87		GM-1342	GM-1341M	N/R	N/R	
PICKUP SIERRA (fullsize)	88-94		GM-1344	GM-1343M	GM-A16	GM-A17	
PICKUP SIERRA (w/o OnStar & w/o amp)	95-02	GM-K9505	GM-1344	GM-1343M	GM-A16	GM-A17	GSA-FT5465
PICKUP SIERRA (w/ OnStar)	95-02	GM-K9505	GM-1344	GM-1343M	GM-A16	GM-A17	GSA-FT5465
PICKUP SIERRA (w/ OnStar & w/o Bose)	95-02	GM-K9505	GM-1344	GM-1343M	GM-A16	GM-A17	GSA-FT5465
PICKUP SIERRA (w/o OnStar)	03-06	GM-K9210P/GM-K9210DD<<			GM-A16	GM-A17	GSA-FT5465
PICKUP SIERRA (w/ OnStar)	03-06	GM-K9210P/GM-K9210DD<<			GM-A16	GM-A17	
PICKUP SIERRA (w/ OnStar & w/ Bose)	03-06	GM-K9210P/GM-K9210DD<<			GM-A16	GM-A17	
PICKUP SIERRA (Classic)(w/o OnStar)	2007	GM-K9210P/GM-K9210DD<<			GM-A16	GM-A17	GSA-FT5465
PICKUP SIERRA (Classic)(w/ OnStar)	2007	GM-K9210P/GM-K9210DD<<			GM-A16	GM-A17	
PICKUP SIERRA (Classic)(w/ OnStar/Bose)	2007				GM-A16	GM-A17	
PICKUP SIERRA (w/o OnStar w/o amp)	07-10	GM-K0610DDP / GM-K0610DD<<			CHR-A16	CHR-A17	
PICKUP SIERRA (w/ OnStar w/ Bose)	07-10	GM-K0610DDP / GM-K0610DD<<			CHR-A16	CHR-A17	
SAFARI VAN	85-89	GM-K8204-1E	GM-1342	GM-1341M	N/R	N/R	
SAFARI VAN	90-91	GM-K8204-1E	GM-1342	GM-1341M	N/R	N/R	USPA-5060
SAFARI VAN	92-95	GM-K8204-1E	GM-1344	GM-1343M	GM-A16	GM-A17	USPA-5060
SAFARI VAN	96-05	GM-K9505	GM-1344	GM-1343M	GM-A16	GM-A17	USPA-5060
S-15 PICKUP	82-90	GM-K8204-1E	GM-1342	GM-1341M	N/R	N/R	
SONOMA	1991	GM-K8204-1E	GM-1342	GM-1341M	N/R	N/R	
SONOMA	92-93	GM-K8204-1E	GM-1344	GM-1343M	GM-A16	GM-A17	
SONOMA	94-97		GM-1344	GM-1343M	GM-A16	GM-A17	
SONOMA	98-01	GM-K8204/GM-K8204-1E	GM-1344	GM-1343M	GM-A16	GM-A17	
SONOMA (oversized radio)	2002	GM-K9210P/GM-K9210DD<<	GM-1416	GM-1416-1M	GM-A16	GM-A17	
SONOMA (standard radio)	2002	GM-K8204/GM-K8204-1E	GM-1344	GM-1343M	GM-A16	GM-A17	
SONOMA	03-04	GM-K9210P/GM-K9210DD<<	GM-1416	GM-1416-1M	GM-A16	GM-A17	
SAVANA VAN	96-00	GM-K9505	GM-1344	GM-1343M	GM-A16	GM-A17	USPA-5060
SAVANA VAN	01-02	GM-K9210P/GM-K9210DD<<	GM-1416	GM-1416-1M	GM-A16	GM-A17	USPA-5060
SAVANA VAN (w/o OnStar or amp)	03-07	GM-K9210P/GM-K9210DD<<			GM-A16	GM-A17	
SAVANA VAN (w/ OnStar)	03-07	GM-K9210P/GM-K9210DD<<			GM-A16	GM-A17	
SAVANA VAN (w/ OnStar & Bose)	03-07	GM-K9210P/GM-K9210DD<<			GM-A16	GM-A17	
SAVANA VAN (w/o OnStar or Amp)	08-10	GM-K0610DDP / GM-K0610DD<<			CHR-A16	CHR-A17	
SAVANA VAN (w/ OnStar & Bose)	08-10	GM-K0610DDP / GM-K0610DD<<			CHR-A16	CHR-A17	
SUBURBAN	73-77				N/R	N/R	
SUBURBAN	78-87		GM-1342	GM-1341M	N/R	N/R	
SUBURBAN	88-91	GM-K8204	GM-1342	GM-1341M	GM-A16	GM-A17	
SUBURBAN	92-94		GM-1344	GM-1343M	GM-A16	GM-A17	
SUBURBAN	95-99	GM-K9505	GM-1344	GM-1343M	GM-A16	GM-A17	GSA-FT5465
TERRAIN	2010						
TERRAIN	2010						
VAN (fullsize)	71-77	N/R			N/R	N/R	
VAN (fullsize)	78-87	N/R	GM-1342	GM-1341M	N/R	N/R	
VAN (fullsize)	88-95	GM-K8204	GM-1344	GM-1343M	GM-A16	GM-A17	
YUKON	92-94		GM-1344	GM-1343M	GM-A16	GM-A17	
YUKON (w/o OnStar or Amp)	95-02	GM-K9505	GM-1344*	GM-1343M	GM-A16	GM-A17	
YUKON (w/ OnStar)	95-02	GM-K9505	GM-1344*	GM-1343M	GM-A16	GM-A17	
YUKON (w/ OnStar & w/ Bose)	95-02	GM-K9505	GM-1344*	GM-1343M	GM-A16	GM-A17	

\* This harness works on standard wiring only. Not for amplified, JBL, or premium sound systems.

\*\* Works on standard wiring systems only. Not for vehicles with Bose or On-Star systems.

< Requires factory mounting bracket.

<< Fits Double Din or two Single ISO mount radios.

^ Requires locating a switched 12v< power source for after-market radios.

# GMC cont.

MAKE/MODEL	YEARS	INSTALLATION KITS	WIRE HARNESS	WIRE HARNESS	ANTENNA ADAPTER	ANTENNA ADAPTER	SPKR ACCESSORIES
		INSTALLER PREFERRED	PLUGS INTO FACTORY HARNESS	PLUGS INTO FACTORY RADIO	AFTER MARKET ANTENNA TO FACTORY ANTENNA RADIO	AFTER MARKET ANTENNA TO FACTORY RADIO	GRILLS, BRACKETS & ADAPTERS
YUKON (w/o OnStar or Amp)	03-06	GM-K9210P/GM-K9210DD<<			GM-A16	GM-A17	
YUKON (w/ OnStar)	03-06	GM-K9210P/GM-K9210DD<<			GM-A16	GM-A17	
YUKON (w/ OnStar & Bose)	03-06	GM-K9210P/GM-K9210DD<<			GM-A16	GM-A17	
YUKON (w/o OnStar or Amp)	07-10	GM-K0610DDP / GM-K0610DD<<			CHR-A16	CHR-A17	
YUKON (w/ OnStar)	07-10	GM-K0610DDP / GM-K0610DD<<			CHR-A16	CHR-A17	
YUKON (w/ OnStar & Bose)	07-10	GM-K0610DDP / GM-K0610DD<<			CHR-A16	CHR-A17	
YUKON XL (w/o OnStar or Amp)	95-02	GM-K9505	GM-1344*	GM-1343M	GM-A16	GM-A17	
YUKON XL (w/ OnStar)	95-02	GM-K9505	GM-1344*	GM-1343M	GM-A16	GM-A17	
YUKON XL (w/ OnStar & Bose)	95-02	GM-K9505	GM-1344*	GM-1343M	GM-A16	GM-A17	
YUKON XL (w/o OnStar or Amp)	03-06	GM-K9210P/GM-K9210DD<<			GM-A16	GM-A17	
YUKON XL (w/ OnStar)	03-06	GM-K9210P/GM-K9210DD<<			GM-A16	GM-A17	
YUKON XL (w/ OnStar & Bose)	03-06	GM-K9210P/GM-K9210DD<<			GM-A16	GM-A17	

# HUMMER

MAKE/MODEL	YEARS	INSTALLATION KITS	WIRE HARNESS	WIRE HARNESS	ANTENNA ADAPTER	ANTENNA ADAPTER	SPKR ACCESSORIES
		INSTALLER PREFERRED	PLUGS INTO FACTORY HARNESS	PLUGS INTO FACTORY RADIO	AFTER MARKET ANTENNA TO FACTORY ANTENNA RADIO	AFTER MARKET ANTENNA TO FACTORY RADIO	GRILLS, BRACKETS & ADAPTERS
H1	03-06	GM-K9210P/GM-K9210DD<<	GM-1416	GM-1416-1M	GM-A16	GM-A17	
H2 / SUT (w/o OnStar or Amp)	03-07	GM-K9210P/GM-K9210DD<<			GM-A16	GM-A17	
H2 / SUT (w/ OnStar)	03-07	GM-K9210P/GM-K9210DD<<			GM-A16	GM-A17	
H2 / SUT (w/ OnStar & Bose)	03-07	GM-K9210P/GM-K9210DD<<			GM-A16	GM-A17	
H2 (w/o OnStar or Bose)	08-09	GM-K0610DDP / GM-K0610DD<<			CHR-A16	CHR-A17	
H2 (w/ OnStar or Bose)	08-09	GM-K0610DDP / GM-K0610DD<<			CHR-A16	CHR-A17	
H3 (w/o OnStar)	05-09				GM-A16	GM-A17	
H3 (w/ OnStar)	05-09				GM-A16	GM-A17	
H3 (w/ OnStar & Bose)	05-09				GM-A16	GM-A17	
H3T	2009						

# JEEP

MAKE/MODEL	YEARS	INSTALLATION KITS	WIRE HARNESS	WIRE HARNESS	ANTENNA ADAPTER	ANTENNA ADAPTER	SPKR ACCESSORIES
		INSTALLER PREFERRED	PLUGS INTO FACTORY HARNESS	PLUGS INTO FACTORY RADIO	AFTER MARKET ANTENNA TO FACTORY ANTENNA RADIO	AFTER MARKET ANTENNA TO FACTORY RADIO	GRILLS, BRACKETS & ADAPTERS
CHEROKEE	73-83	N/R					
XJCHEROKEE	84-87						
XJCHEROKEE	88-96		JP-1622	JP-1623M			
CHEROKEE	97-01	CHR-K7401/CF-K7401	CHR-1634	CHR-1633M			
CJ-5	72-77	N/R					
CJ-5	78-85	N/R					
CJ-7	72-77	N/R					
CJ-7	78-85	N/R					
COMANCHEE P/U	86-87						
COMANCHEE P/U	88-92		JP-1622	JP-1623M			
COMMANDER (w/oFACTORY Amp)	06-07	CHR-K0410P	CHR-1638**	CHR-1637M	CHR-A16	CHR-A17	
COMMANDER (w/FACTORY Amp)	06-07	CHR-K0410P		CHR-1637M	CHR-A16	CHR-A17	
COMMANDER (w/factory Nav)	06-07	CHR-K0408DD	CHR-1638*	CHR-1637M	CHR-A16	CHR-A17	
COMMANDER	08-10	CHR-K0710B	CHR-1642*	CHR-1641M	EURO-A106	EURO-A107	
COMPASS (w/oFACTORY Amp)	07-08	CHR-K0410P	CHR-1638*	CHR-1637M	CHR-A16	CHR-A17	
COMPASS (w/FACTORY Amp)	07-08	CHR-K0410P		CHR-1637M	CHR-A16	CHR-A17	
COMPASS (w/factory Nav)	07-08	CHR-K0408DD	CHR-1638**	CHR-1637M	CHR-A16	CHR-A17	
COMPASS	09-10	CHR-K0710B			EURO-A106	EURO-A107	
GRAND CHEROKEE	86-92		JP-1622	JP-1623M			
GRAND CHEROKEE	93-94	CF-K7401	CHR-1634	CHR-1633M			USPA-5060
GRAND CHEROKEE	95-98	CF-K7401	CHR-1634	CHR-1633M			
GRAND CHEROKEE	99-01	CHR-4640	CHR-1634	CHR-1633M			USPA-5060

\* This harness works on standard wiring only. Not for amplified JBL or premium sound systems.

\*\* Works on standard wiring systems only. Not for vehicles with Bose or On-Star systems.

< Requires factory mounting bracket.

<< Fits Double Din or two Single ISO mount radios.

^ Requires locating a switched 12v< power source for after-market radios.



# JEEP cont.

MAKE/MODEL	YEARS	INSTALLATION KITS	WIRE HARNESS	WIRE HARNESS	ANTENNA ADAPTER	ANTENNA ADAPTER	SPKR ACCESSORIES
		INSTALLER PREFERRED	PLUGS INTO FACTORY HARNESS	PLUGS INTO FACTORY RADIO	AFTER MARKET ANTENNA TO FACTORY ANTENNA	AFTER MARKET ANTENNA TO FACTORY RADIO	GRILLS, BRACKETS & ADAPTERS
GRAND CHEROKEE	02-04	CHR-4640	CHR-1638*	CHR-1637M	CHR-A16	CHR-A17	
GRAND CHEROKEE (w/oFACTORY Amp)	05-07	CHR-K0410P	CHR-1638*	CHR-1637M	CHR-A16	CHR-A17	
GRAND CHEROKEE (w/FACTORY Amp)	05-07	CHR-K0410P		CHR-1637M	CHR-A16	CHR-A17	
GRAND CHEROKEE (w/factory Nav)	05-07	CHR-K0408DD	CHR-1638*	CHR-1637M	CHR-A16	CHR-A17	
GRAND CHEROKEE	08-10	CHR-K0710B	CHR-1642*	CHR-1641M	EURO-A106	EURO-A107	
LIBERTY	02-07	CHR-4640	CHR-1638	CHR-1637M	CHR-A16	CHR-A17	
LIBERTY	08-10	CHR-K0710B	CHR-1642*	CHR-1641M	EURO-A106	EURO-A107	
PATRIOT (w/oFACTORY Amp)	2007	CHR-K0410P	CHR-1638*	CHR-1637M	CHR-A16	CHR-A17	
PATRIOT (w/FACTORY Amp)	2007	CHR-K0410P		CHR-1637M	CHR-A16	CHR-A17	
PATRIOT	08-10	CHR-K0710B	CHR-1642*	CHR-1637M	EURO-A106	EURO-A107	
PICKUP	73-85	N/R					
WAGONEER	73-83	N/R					
GRAND WAGONEER	86-87						
GRAND WAGONEER	88-92		JP-1622	JP-1623M			
WRANGLER	84-87						
WRANGLER	88-96		JP-1622	JP-1623M			
WRANGLER	97-02	CHR-K7401/CF-K7401	CHR-1634	CHR-1637M			
WRANGLER	03-06	CHR-4640	CHR-1638	CHR-1637M	CHR-A16	CHR-A17	
WRANGLER/UNLIMITED	07-10	CHR-K0710B	CHR-1642*	CHR-1641M	EURO-A106	EURO-A107	

# LINCOLN

MAKE/MODEL	YEARS	INSTALLATION KITS	WIRE HARNESS	WIRE HARNESS	ANTENNA ADAPTER	ANTENNA ADAPTER	SPKR ACCESSORIES
		INSTALLER PREFERRED	PLUGS INTO FACTORY HARNESS	PLUGS INTO FACTORY RADIO	AFTER MARKET ANTENNA TO FACTORY ANTENNA	AFTER MARKET ANTENNA TO FACTORY RADIO	GRILLS, BRACKETS & ADAPTERS
AVIATOR	2003	FM-K9510P	FD-1600				USPA-6090
AVIATOR	04-06	FM-K9510P/FM-K0106DD<<	FD-45520	FD-5521M			USPA-6090
BLACKWOOD	2002	FM-K9510P/FM-K9510DD<<	FD-1600				USPA-6090
CONTINENTAL	78-82	N/R					
CONTINENTAL	83-86	CF-K7401	FD-1592				
CONTINENTAL	87-94		FD-146/FD-446				
CONTINENTAL	95-97	FM-K9510P	FD-1596*	FD-1595M	FD-A16	FD-A17	
CONTINENTAL	98-02		FD-1598*	FD-1597M	FD-A16	FD-A17	USPA-6090
LS	00-06		FD-1600	FD-1597M			USPA-6090
MARK IV	73-79	N/R	FD-1600				
MARK V	73-79	N/R					
MARK LT	06-08	FM-K0411P/FM-K0411DD<<	FD-45520	FD-5521M			USPA-6090
MARK VI	80-83	N/R	FD-1592				
MARK VII	84-85		FD-1592				
MARK VII	86-89		FD-1594	FD-1593M			
MARK VII	90-93	DIN MOUNT	FD-146/FD-446				
MARK VIII	93-94	DIN MOUNT	FD-146/FD-446				USPA-6090
MARK VIII	95-98	FM-K9510P	FD-1596*		FD-A16	FD-A17	USPA-6090
MKS	2009						
MKT	2010						
MKX (w/factory Nav)	07-10	FM-K0411P/FM-K0411DD<<	FD-45520	FD-5521M	CHR-A16	CHR-A17	USPA-6090
MKX (w/o Nav)	07-10			FD-5521M	CHR-A16	CHR-A17	USPA-6090
MKZ (w/oFACTORY Nav)	08-10	FM-K0411P/FM-K0411DD<<	FD-45520	FD-5521M	CHR-A16	CHR-A17	USPA-6090
MKZ (w/oFACTORY Nav)	07-10			FD-5521M	CHR-A16	CHR-A17	USPA-6090
NAVIGATOR	1998		FD-1596		FD-A16	FD-A17	USPA-6090
NAVIGATOR	99-02	FM-K9510P	FD-1598*	FD-1597M	FD-A16	FD-A17	USPA-6090
NAVIGATOR	03-06	FM-K9510P/FM-K0106DD<<	FD-1600				USPA-6090
NAVIGATOR (w/o THX system)	07-10	FM-K0411P/FM-K0411DD<<	FD-45520	FD-5521M	CHR-A16	CHR-A17	USPA-6090
NAVIGATOR (w/THX system)	07-10	FM-K0411P/FM-K0411DD<<	FD-45520	FD-5521M	CHR-A16	CHR-A17	USPA-6090
TOWNCAR	85-86						USPA-6090
TOWNCAR	87-89		FD-1594*	FD-1593M			USPA-6090
TOWNCAR	90-94		FD-1594*	FD-1593M			USPA-6090
TOWNCAR	95-97	FM-K9510P	FD-1596*		FD-A16	FD-A17	USPA-6090
TOWNCAR	98-02	FM-K9510P	FD-1598*	FD-1597M	FD-A16	FD-A17	USPA-6090
TOWNCAR	03-09		FD-45520	FD-5521M			USPA-6090
ZEPHYR (Select Models)	06-08	FM-K0411P/FM-K0411DD<<	FD-45520	FD-5521M	CHR-A16	CHR-A17	

\* This harness works on standard wiring only. Not for amplified, JBL, or premium sound systems.  
 \*\* Works on standard wiring systems only. Not for vehicles with Bose or On-Star systems.

< Requires factory mounting bracket.  
 << Fits Double Din or two Single ISO mount radios.  
 ^ Requires locating a switched 12v< power source for after-market radios.

# MERCURY

MAKE/MODEL	YEARS	INSTALLATION KITS	WIRE HARNESS	WIRE HARNESS	ANTENNA ADAPTER	ANTENNA ADAPTER	SPKR ACCESSORIES
		INSTALLER PREFERRED	PLUGS INTO FACTORY HARNESS	PLUGS INTO FACTORY RADIO	AFTER MARKET ANTENNA TO ANTENNA	AFTER MARKET ANTENNA TO FACTORY RADIO	GRILLS, BRACKETS & ADAPTERS
BOBCAT	71-80						
CAPRI	71-78						
CAPRI	79-84						USPA-6090
CAPRI	85-86						
CAPRI	91-94		FD-1594	FD-1593M			
COMET	69-77						
COUGAR	71-73						
COUGAR	74-79						USPA-6090
COUGAR	81-82						
COUGAR	83-85						
COUGAR	86-88		FD-1594	FD-1593M			
COUGAR	89-97		FD-1594*	FD-1593M			USPA-6090
COUGAR	98-00		FD-1594	FD-1593M	VW-A16L	VW-A17	USPA-6090
COUGAR	01-02	FM-K9510P	FD-1600		VW-A16L	VW-A17	USPA-6090
GRAND MARQUIS	83-85						
GRAND MARQUIS	86-89		FD-1594	FD-1593M			
GRAND MARQUIS	90-91		FD-1594	FD-1593M			
GRAND MARQUIS	92-94		FD-1594*	FD-1593M			USPA-6090
GRAND MARQUIS	95-97	FM-K9510P	FD-1596*		FD-A16	FD-A17	USPA-6090
GRAND MARQUIS	98-02	FM-K9510P	FD-1598*	FD-1597M			USPA-6090
GRAND MARQUIS	03-10	FM-K9510P	FD-5520	FD-5521M			USPA-6090
LN-7	81-83						
LYNX	81-83						
LYNX	84-85						
LYNX	86-87		FD-1594	FD-1593M			
MARAUDER	03-05	FM-K9510P	FD-5520*	FD-5521M			USPA-6090
MARINER	05-07	FM-K9510P/FM-K9510DD<<	FD-1598*	FD-1597M			USPA-6090
MARINER(w/Factory Nav)	08-10	FM-K0411P/FM-K0411DD<<			CHR-A16	CHR-A17	USPA-6090
MARINER(w/oFactory Nav)	08-10	FM-K0411P/FM-K0411DD<<	FD-45520*		CHR-A16	CHR-A17	USPA-6090
MARINER SILVER(w/oFACTORY Nav)	08-10		FD-45520*		CHR-A16	CHR-A17	USPA-6090
MARQUIS	73-78						
MARQUIS	79-82						
MARQUIS	83-85						USPA-6090
MARQUIS	86-89		FD-1594	FD-1593M			
MERKUR SCORPIO	88-89						
MERKUR XR4-TI	85-89						
MILAN	06-09	FM-K0411P/FM-K0411DD<<	FD-5520*	FD-5521M	CHR-A16	CHR-A17	USPA-6090
MILAN	2010						
MONARCH	74-80						USPA-6090
MONARCH	81-82						USPA-6090
MONARCH	83-84						
MONTEREY	73-84						
MONTEREY	04-06	FM-K0411P/FM-K0411DD<<	FD-5520*	FD-5521M			USPA-6090
MONTEGO	73-76						
MONTEGO	05-07	FM-K0411P/FM-K0411DD<<	FD-5520*	FD-5521M			USPA-6090
MOUNTAINEER	1997	FM-K9510P	FD-1596*		FD-A16	FD-A17	USPA-6090
MOUNTAINEER	98-01	FM-K9510P/FM-K9510DD<<	FD-1598*	FD-1597M			USPA-6090
MOUNTAINEER	02-05	FM-K9510P/FM-K0106DD<<	FD-1598*	FD-1597M			USPA-6090
MOUNTAINEER(Nav only)	06-10	FM-K0411P/FM-K0411DD<<	FD-45520		CHR-A16	CHR-A17	USPA-6090
MYSTIQUE	95-00		FD-1594*	FD-1593M			USPA-6090
SABLE	86-89		FD-1594	FD-1593M			USPA-6090
SABLE	90-95		FD-1594*	FD-1593M			USPA-6090
SABLE(w/rotary climate control)	96-99						USPA-6090
SABLE(w/rotary climate control)	00-07						USPA-6090
SABLE	08-09	FM-K0411P/FM-K0411DD<<	FD-45520	FD-5521M	CHR-A16	CHR-A17	USPA-6090
TOPAZ	84-85				N/R	N/R	USPA-6090
TOPAZ	86-87		FD-1594	FD-1593M	N/R	N/R	USPA-6090
TOPAZ	88-94		FD-1594	FD-1593M	N/R	N/R	USPA-6090
TRACER	87-90				N/R	N/R	
TRACER	91-96		FD-1594	FD-1593M	N/R	N/R	USPA-6090
TRACER	97-99						USPA-6090
VERSAILLES	78-80				N/R	N/R	
VILLAGER	93-95		NIS-1700	NIS-1701M			USPA-6090
VILLAGER	96-98		FD-1594*		N/R	N/R	USPA-6090
VILLAGER	99-02		FD-1598*	FD-1597M	N/R	N/R	USPA-6090
XR-7	81-82				N/R	N/R	
ZEPHYR	78-83				N/R	N/R	USPA-6090

\* This harness works on standard wiring only.  
Not for amplified JBL or premium sound systems.  
\*\* Works on standard wiring systems only.  
Not for vehicles with Bose or On-Star systems.

< Requires factory mounting bracket.  
<< Fits Double Din or two Single ISO mount radios.  
^ Requires locating a switched 12v< power source for after-market radios.

# OLDSMOBILE

MAKE/MODEL	YEARS	INSTALLATION KITS	WIRE HARNESS	WIRE HARNESS	ANTENNA ADAPTER	ANTENNA ADAPTER	SPKR ACCESSORIES
		INSTALLER PREFERRED	PLUGS INTO FACTORY HARNESS	PLUGS INTO FACTORY RADIO	AFTER MARKET ANTENNA TO FACTORY ANTENNA	AFTER MARKET ANTENNA TO FACTORY RADIO	GRILLS, BRACKETS & ADAPTERS
ACHIEVA	92-95	GM-K8204	GM-1344	GM-1343M	GM-A16	GM-A17	
ACHIEVA	96-98	GM-K9210P/GM-K9210DD<<	GM-1346	GM-1347M	GM-A16	GM-A17	
ALERO	99-00	GM-K9210P/GM-K9210DD<<	GM-1346	GM-1347M	GM-A16	GM-A17	
ALERO(w/o OnStar orAmp)	01-04	GM-K9210P/GM-K9210DD<<			GM-A16	GM-A17	
ALERO(w/ OnStar)	01-04	GM-K9210P/GM-K9210DD<<			GM-A16	GM-A17	
ALERO(w/o OnStar &Bose)	01-04	GM-K9210P/GM-K9210DD<<			GM-A16	GM-A17	
AURORA	95-00	GM-K9210P/GM-K9210DD<<	GM-1346	GM-1347M	GM-A16	GM-A17	USPA-5060
AURORA	01-03	GM-K9210P/GM-K9210DD<<					
BRAVADA	91-94	GM-K9210P	GM-1344	GM-1343M	GM-A16	GM-A17	
BRAVADA	96-97		GM-1344	GM-1343M	GM-A16	GM-A17	
BRAVADA	98-01	GM-K9210DD	GM-1346	GM-1347M	GM-A16	GM-A17	
BRAVADA(w/o OnStar&Amp)	02-04	GM-K9210P/GM-K9210DD<<			GM-A16	GM-A17	
BRAVADA(w/ OnStar)	02-04	GM-K9210P/GM-K9210DD<<			GM-A16	GM-A17	
BRAVA(w/ OnStar &Bose)	02-04	GM-K9210P/GM-K9210DD<<			GM-A16	GM-A17	
CALAIS	82-87	GM-K8204	GM-1342	GM-1341M	N/R	N/R	SS-10
CALAIS	88-91	GM-K8204	GM-1344	GM-1343M	GM-A16	GM-A17	SS-10
CIERA	82-87	GM-K8204	GM-1342	GM-1341M		N/R	SS-10
CIERA	88-96	GM-K8204	GM-1344	GM-1343M	GM-A16	GM-A17	SS-10
CUTLASS	69-72	N/R			N/R	N/R	
CUTLASS	73-77				N/R	N/R	
CUTLASS SUPREME	78-83		GM-1342	GM-1341M	N/R	N/R	
CUTLASS SUPREME	84-88	GM-K8204	GM-1342	GM-1341M	N/R	N/R	
CUTLASS SUPREME	89-94	GM-K8204	GM-1344	GM-1343M	GM-A16	GM-A17	SS-10
CUTLASS SUPREME	95-97	GM-K9210P/GM-K9210DD<<	GM-1346	GM-1347M	GM-A16	GM-A17	SS-10
CUTLASS	98-99	GM-K9210P/GM-K9210DD<<	GM-1346	GM-1347M	GM-A16	GM-A17	
DELTA 88	74-81				N/R	N/R	SS-10
DELTA 88	82-85		GM-1342	GM-1341M	N/R	N/R	SS-10
DELTA 88	86-88	GM-K8204	GM-1342	GM-1341M	N/R	N/R	SS-10
EIGHTY-EIGHT ROYALE	89-93	GM-K8204	GM-1344	GM-1343M	GM-A16	GM-A17	
EIGHTY-EIGHT	94-99	GM-K9210P/GM-K9210DD<<	GM-1346	GM-1347M	GM-A16	GM-A17	
FIRENZA	82-88	GM-K8204-1E	GM-1342	GM-1341M	N/R	N/R	
INTRIGUE	98-02	GM-K9210P/GM-K9210DD<<	GM-1346	GM-1347M	GM-A16	GM-A17	
LSS	96-99	GM-K9210P/GM-K9210DD<<	GM-1346	GM-1347M	GM-A16	GM-A17	
NINETY-EIGHT	71-73	N/R			N/R	N/R	
NINETY-EIGHT	74-77				N/R	N/R	SS-10
NINETY-EIGHT	78-88		GM-1342	GM-1341M	N/R	N/R	SS-10
NINETY-EIGHT	89-93	GM-K8204	GM-1344	GM-1343M	GM-A16	GM-A17	SS-10
NINETY-EIGHT	94-96	GM-K9210P/GM-K9210DD<<	GM-1346	GM-1347M	GM-A16	GM-A17	
OMEGA	73-79	N/R			N/R	N/R	
OMEGA	80-82	N/R	GM-1342	GM-1341M	N/R	N/R	
OMEGA	83-84	GM-K8204-1E	GM-1342	GM-1341M	N/R	N/R	
SILHOUETTE	90-96	GM-K8204	GM-1344	GM-1343M	GM-A16	GM-A17	
SILHOUETTE	97-99	GM-K8204/GM-K8204-1E	GM-1344	GM-1343M	GM-A16	GM-A17	USPA-5060
SILHOUETTE(w/o OnStar&Amp)	00-04	GM-K9210P/GM-K9210DD<<	GM-1416	GM-1416-1M	GM-A16	GM-A17	USPA-5060
SILHOUETTE(w/ OnStar)	00-04	GM-K9210P/GM-K9210DD<<		GM-1416-1M	GM-A16	GM-A17	USPA-5060
SILHOUETTE(w/ OnStar&Bose)	00-04	GM-K9210P/GM-K9210DD<<		GM-1416-1M	GM-A16	GM-A17	USPA-5060
STARFIRE	71-81	N/R			N/R	N/R	
TORONADO	71-77	N/R			N/R	N/R	SS-10
TORONADO	1978	N/R	GM-1342	GM-1341M	N/R	N/R	SS-10
TORONADO	79-81	N/R	GM-1342	GM-1341M	N/R	N/R	
TORONADO	82-85	GM-K8204	GM-1342	GM-1341M	N/R	N/R	
TORONADO	86-89	GM-K8204	GM-1342	GM-1341M	N/R	N/R	SS-10
TORONADO	90-92		GM-1344	GM-1343M	GM-A16	GM-A17	SS-10

# PLYMOUTH

MAKE/MODEL	YEARS	INSTALLATION KITS	WIRE HARNESS	WIRE HARNESS	ANTENNA ADAPTER	ANTENNA ADAPTER	SPKR ACCESSORIES
		INSTALLER PREFERRED	PLUGS INTO FACTORY HARNESS	PLUGS INTO FACTORY RADIO	AFTER MARKET ANTENNA TO FACTORY ANTENNA	AFTER MARKET ANTENNA TO FACTORY RADIO	GRILLS, BRACKETS & ADAPTERS
ACCLAIM	89-95	CHR-K7401/CF-K7401	CHR-1634	CHR-1633M	N/R	N/R	USPA-6090
ARROW	76-79	N/R			N/R	N/R	
ARROW P/U	80-86	N/R	UI-1990		N/R	N/R	
BREEZE	96-00	CHR-K7401/CF-K7401	CHR-1634	CHR-1633M	N/R	N/R	USPA-5060
CARAVELLE SEDAN	85-88	CHR-K7401/CF-K7401	CHR-1634	CHR-1633M	N/R	N/R	USPA-6090
CHAMP	81-84	N/R	UI-1990		N/R	N/R	

\* This harness works on standard wiring only. Not for amplified, JBL, or premium sound systems.  
 \*\* Works on standard wiring systems only. Not for vehicles with Bose or On-Star systems.

< Requires factory mounting bracket.  
 << Fits Double Din or two Single ISO mount radios.  
 ^ Requires locating a switched 12v< power source for after-market radios.

# PLYMOUTH cont.

MAKE/MODEL	YEARS	INSTALLATION KITS	WIRE HARNESS	WIRE HARNESS	ANTENNA ADAPTER	ANTENNA ADAPTER	SPKR ACCESSORIES
		INSTALLER PREFERRED	PLUGS INTO FACTORY HARNESS	PLUGS INTO FACTORY RADIO	AFTER MARKET ANTENNA TO ANTENNA	AFTER MARKET ANTENNA TO FACTORY RADIO	GRILLS, BRACKETS & ADAPTERS
HORIZON	78-90	CHR-K7401/CF-K7401	CHR-1634	CHR-1633M	N/R	N/R	
LASER	84-86	CHR-K7401/CF-K7401	CHR-1634	CHR-1633M	N/R	N/R	USPA-6090
LASER	90-94		CI-1610		N/R	N/R	
PROWLER	92-01	CHR-K7401/CF-K7401	CHR-1634	CHR-1633M	N/R	N/R	
ACCLAIM	89-95	CHR-K7401/CF-K7401	CHR-1634	CHR-1633M	N/R	N/R	USPA-6090
SAPPORO	78-83	CHR-K7401/CF-K7401			N/R	N/R	USPA-6090
SCAMP	83-84	CHR-K7401/CF-K7401			N/R	N/R	
TC3	78-90	CHR-K7401/CF-K7401	CHR-1634	CHR-1633M	N/R	N/R	
TOURISMO	74-82	N/R			N/R	N/R	
TOURISMO	83-87	CHR-K7401/CF-K7401			N/R	N/R	
TRAILDUSTER	74-75	CHR-K7401/CF-K7401			N/R	N/R	
TRAILDUSTER	76-81	CHR-K7401/CF-K7401			N/R	N/R	
VOLARE	76-80	CHR-K7401/CF-K7401			N/R	N/R	
VOYAGER	84-95	CHR-K7401/CF-K7401	CHR-1634	CHR-1633M	N/R	N/R	
VOYAGER	96-00	CHR-K7401/CF-K7401	CHR-1634	CHR-1633M	N/R	N/R	

# PONTIAC

MAKE/MODEL	YEARS	INSTALLATION KITS	WIRE HARNESS	WIRE HARNESS	ANTENNA ADAPTER	ANTENNA ADAPTER	SPKR ACCESSORIES
		INSTALLER PREFERRED	PLUGS INTO FACTORY HARNESS	PLUGS INTO FACTORY RADIO	AFTER MARKET ANTENNA TO ANTENNA	AFTER MARKET ANTENNA TO FACTORY RADIO	GRILLS, BRACKETS & ADAPTERS
A6000	82-89	GM-K8204	GM-1342	GM-1341M	N/R	N/R	SS-10
A6000	90-91	GM-K8204	GM-1344	GM-1343M	GM-A16	GM-A17	SS-10
ASTRE	74-77	N/R			N/R	N/R	
AZTEK (w/o OnStar)	01-05	GM-K9210P/GM-K9210DD<<	GM-1416	GM-1416-1M	GM-A16	GM-A17	
BONNEVILLE	71-77	N/R			N/R	N/R	SS-10
BONNEVILLE	78-81	N/R	GM-1342	GM-1341M	N/R	N/R	SS-10
BONNEVILLE	82-86		GM-1342	GM-1341M	N/R	N/R	
BONNEVILLE	87-91	GM-K8204	GM-1342	GM-1341M	N/R	N/R	SS-10
BONNEVILLE	92-95	GM-K8204	GM-1344	GM-1343M	GM-A16	GM-A17	SS-10
BONNEVILLE	96-99	GM-K8204/GM-K8204-1E	GM-1344	GM-1343M	GM-A16	GM-A17	
BONNEVILLE	00-04	GM-K9210P/GM-K9210DD<<	GM-1346R		VW-A16L	VW-A17	
CATALINA	71-77	N/R			N/R	N/R	SS-10
CATALINA	78-81	N/R	GM-1342	GM-1341M	N/R	N/R	SS-10
FIERO	84-88	GM-K8204	GM-1342	GM-1341M	N/R	N/R	
FIREBIRD	69-71	N/R			N/R	N/R	
FIREBIRD	72-77				N/R	N/R	
FIREBIRD	78-81		GM-1342	GM-1341M	N/R	N/R	SS-10
FIREBIRD TRANS AM	82-89	GM-K8204	GM-1342	GM-1341M	N/R	N/R	
FIREBIRD TRANS AM	90-92	GM-K8204	GM-1344	GM-1343M	GM-A16	GM-A17	
FIREBIRD TRANS AM	93-96		GM-1344*	GM-1343M	GM-A16	GM-A17	USPA-5060
FIREBIRD TRANS AM	97-02	GM-K8204	GM-1344*	GM-1343M	GM-A16	GM-A17	
G3	2009		GM-1410	GM-1409M	CHR-A16	CHR-A17	
G3 HATCHBACK	07-08		DAE-1664	DAE-1663M	N/R	N/R	
G5 (w/o OnStar & w/o amp)	07-08	GM-K0410DDP/GM-K0410DD<<	GM-1406		CHR-A16	CHR-A17	
G5 (w/o OnStar & w/o Bose)	07-08	GM-K0410DDP/GM-K0410DD<<			CHR-A16	CHR-A17	
G6 (w/o OnStar)	05-09	GM-K0410DDP/GM-K0410DD<<	GM-1404		GM-A16	GM-A17	
G6 (w/ OnStar & w/Bose)	05-09	GM-K0410DDP/GM-K0410DD<<			GM-A16	GM-A17	
G8	08-09		EURO-11010		EURO-A106	EURO-A107	
GRAND AM	85-89	GM-K8204	GM-1342	GM-1341M	N/R	N/R	SS-10
GRAND AM	90-91	GM-K8204	GM-1344	GM-1343M	GM-A16	GM-A17	SS-10
GRAND AM	92-95	GM-K8204	GM-1344	GM-1343M	GM-A16	GM-A17	
GRAND AM	96-00	GM-K8204/GM-K8204-1E	GM-1344	GM-1343M	GM-A16	GM-A17	
GRAND AM (w/o OnStar & w/o amp)	01-05	GM-K9210P/GM-K9210DD<<			GM-A16	GM-A17	
GRAND AM (w/ OnStar)	01-05	GM-K9210P/GM-K9210DD<<			GM-A16	GM-A17	
GRAND AM (w/ OnStar & w/ Bose)	01-05	GM-K9210P/GM-K9210DD<<			GM-A16	GM-A17	
GRAND PRIX	73-77	N/R			N/R	N/R	
GRAND PRIX	78-87		GM-1342	GM-1341M	N/R	N/R	SS-10
GRAND PRIX	88-89	N/R	GM-1344	GM-1343M	GM-A16	GM-A17	SS-10
GRAND PRIX	90-95	GM-K8204	GM-1344	GM-1343M	GM-A16	GM-A17	SS-10
GRAND PRIX	96-03	GM-K8204/GM-K8204-1E	GM-1344*	GM-1343M	GM-A16	GM-A17	
GRAND PRIX (w/o OnStar & w/o amp)	04-08	GM-K0410DDP			GM-A16	GM-A17	
GRAND PRIX (w/ OnStar)	04-08	GM-K0410DDP			GM-A16	GM-A17	
GRAND PRIX (w/ OnStar & w/ Bose)	04-08	GM-K0410DDP			GM-A16	GM-A17	
GRANVILLE	71-77	N/R			N/R	N/R	

\* This harness works on standard wiring only. Not for amplified JBL or premium sound systems.

\*\* Works on standard wiring systems only. Not for vehicles with Bose or On-Star systems.

< Requires factory mounting bracket.

<< Fits Double Din or two Single ISO mount radios.

^ Requires locating a switched 12v< power source for after-market radios.

# PONTIAC cont.

MAKE/MODEL	YEARS	INSTALLATION KITS	WIRE HARNESS	WIRE HARNESS	ANTENNA ADAPTER	ANTENNA ADAPTER	SPKR ACCESSORIES	
			PLUGS INTO FACTORY HARNESS	PLUGS INTO FACTORY RADIO	AFTER MARKET ANTENNA TO FACTORY ANTENNA	AFTER MARKET ANTENNA TO FACTORY RADIO	GRILLS, BRACKETS & ADAPTERS	
GTO	04-06			VW-11000		VW-A16L	VW-A17	
J-2000	82-84	GM-K8204		GM-1342*	GM-1341M	N/R	N/R	SS-10
LEMANS	69-77	N/R				N/R	N/R	
LEMANS	78-81			GM-1342	GM-1341M	N/R	N/R	SS-10
LEMANS	88-93			UI-1990		N/R	N/R	
MONTANA (w/o OnStar & w/o amp)	97-98	GM-K8204/GM-K8204-1E		GM-1344	GM-1343M	GM-A16	GM-A17	
MONTANA (w/ OnStar & w/o Bose)	1999	GM-K8204/GM-K8204-1E		GM-1344	GM-1343M	GM-A16	GM-A17	
MONTANA (w/ OnStar & w/ Bose)	1999	GM-K8204/GM-K8204-1E		GM-1344	GM-1343M	GM-A16	GM-A17	
MONTANA (w/o OnStar & w/o amp)	00-04	GM-K9210P/GM-K9210DD<<		GM-1416		GM-A16	GM-A17	
MONTANA (w/ OnStar & w/o Bose)	00-04	GM-K9210P/GM-K9210DD<<				GM-A16	GM-A17	
MONTANA (w/ OnStar & w/ Bose)	00-04	GM-K9210P/GM-K9210DD<<				GM-A16	GM-A17	
MONTANA SV6 (w/o OnStar & w/o amp)	05-06					GM-A16	GM-A17	
MONTANA SV6 (w/ OnStar)	05-06					GM-A16	GM-A17	
MONTANA SV6 (w/ OnStar & w/ Bose)	05-06					GM-A16	GM-A17	
PARISIENNE	83-84			GM-1342	GM-1341M	N/R	N/R	
PARISIENNE	85-86	GM-K8204		GM-1342	GM-1341M	N/R	N/R	
PHOENIX	73-79	N/R				N/R	N/R	
PHOENIX	80-84	N/R		GM-1342	GM-1341M	N/R	N/R	
SOLSTICE (w/o OnStar)	06-10	GM-K0410DDP/GM-K0410DD<<		GM-1406PIO**		CHR-A16	CHR-A17	
SOLSTICE (w/ OnStar & w/o Bose)	06-10	GM-K0410DDP/GM-K0410DD<<				CHR-A16	CHR-A17	
SUNBIRD	75-77	N/R				N/R	N/R	
SUNBIRD	78-81	N/R				N/R	N/R	
SUNBIRD	82-88	GM-K8204		GM-1342	GM-1341M	N/R	N/R	SS-10
SUNBIRD	89-94			GM-1344	GM-1343M	GM-A16	GM-A17	SS-10
SUNFIRE	95-96	GM-K8204		GM-1344	GM-1343M	GM-A16	GM-A17	
SUNFIRE	97-99	GM-K8204/GM-K8204-1E		GM-1344*	GM-1343M	GM-A16	GM-A17	
SUNFIRE (w/o OnStar & w/o amp)	00-05	GM-K9210P/GM-K9210DD<<				GM-A16	GM-A17	
SUNFIRE (w/ OnStar)	00-05	GM-K9210P/GM-K9210DD<<				GM-A16	GM-A17	
SUNFIRE (w/ OnStar & w/ Bose)	00-05	GM-K9210P/GM-K9210DD<<				GM-A16	GM-A17	
T-1000	81-87	N/R				N/R	N/R	
TORRENT	2006	GM-K0410DDP/GM-K0410DD<<		GM-1404		GM-A16	GM-A17	
TORRENT (w/o OnStar & w/o Bose)	07-08	GM-K0610DDP / GM-K0610DD<<				CHR-A16	CHR-A17	
TORRENT (w/ OnStar & w/ Bose)	07-08	GM-K0610DDP / GM-K0610DD<<				CHR-A16	CHR-A17	
TRANSPORT VAN	90-96	GM-K8204		GM-1344	GM-1343M	GM-A16	GM-A17	USPA-5060
TRANSPORT VAN	97-99	GM-K8204/GM-K8204-1E		GM-1344*	GM-1343M	GM-A16	GM-A17	USPA-5060
VENTURA	73-79	N/R				N/R	N/R	SS-10
VIBE	03-08	GM-K9210P/GM-K9210DD<<		GM-1416	GM-1416-1M	GM-A16	GM-A17	
VIBE	09-10			TOY-1950	TOY-1951M	N/R	N/R	

# SATURN

MAKE/MODEL	YEARS	INSTALLATION KITS	WIRE HARNESS	WIRE HARNESS	ANTENNA ADAPTER	ANTENNA ADAPTER	SPKR ACCESSORIES	
			PLUGS INTO FACTORY HARNESS	PLUGS INTO FACTORY RADIO	AFTER MARKET ANTENNA TO FACTORY ANTENNA	AFTER MARKET ANTENNA TO FACTORY RADIO	GRILLS, BRACKETS & ADAPTERS	
ALL MODELS	91-94	GM-K8204		GM-1344	GM-1343M	GM-A16	GM-A17	USPA-5060
ALL MODELS	95-99			GM-1344	GM-1343M	GM-A16	GM-A17	USPA-5060
ASTRA	08-09			EURO-11010		EURO-A106	EURO-A107	
AURA (w/o OnStar)	07-09	GM-K0410DDP/GM-K0410DD<<		GM-1406PIO**		GM-A16	GM-A17	
AURA (w/ OnStar & w/o Bose)	08-09	GM-K0410DDP/GM-K0410DD<<		GM-1406PIO**		GM-A16	GM-A17	
ION	2003			GM-1348		N/R	N/R	
ION	04-05			GM-1354*		N/R	N/R	
ION	06-08	GM-K0410DDP/GM-K0410DD<<		GM-1406PIO**		CHR-A16	CHR-A17	
L300	04-05			GM-1354*		N/R	N/R	
L SERIES	00-03			GM-1348		N/R	N/R	
OUTLOOK (w/o OnStar & w/o amp)	07-08	GM-K0610DDP / GM-K0610DD<<				CHR-A16	CHR-A17	
OUTLOOK (w/ OnStar)	07-08	GM-K0610DDP / GM-K0610DD<<				CHR-A16	CHR-A17	
OUTLOOK (w/ OnStar & w/ Bose)	07-08	GM-K0610DDP / GM-K0610DD<<				CHR-A16	CHR-A17	
RELAY (w/o OnStar or amp)	05-07					GM-A16	GM-A17	
RELAY (w/ OnStar)	05-07					GM-A16	GM-A17	
RELAY (w/o OnStar & Bose)	05-07					GM-A16	GM-A17	
S SERIES	00-03			GM-1348		N/R	N/R	
SKY (w/o OnStar & w/o Bose)	07-08	GM-K0410DDP/GM-K0410DD<<		GM-1406PIO**		CHR-A16	CHR-A17	
SKY (w/ OnStar & w/o Bose)	07-08	GM-K0410DDP/GM-K0410DD<<				CHR-A16	CHR-A17	
SKY (w/O OnStar)	2009	GM-K0410DDP/GM-K0410DD<<				CHR-A16	CHR-A17	

\* This harness works on standard wiring only. Not for amplified, JBL, or premium sound systems.  
 \*\* Works on standard wiring systems only. Not for vehicles with Bose or On-Star systems.

< Requires factory mounting bracket.  
 << Fits Double Din or two Single ISO mount radios.  
 ^ Requires locating a switched 12v< power source for after-market radios.

# SATURN cont.

MAKE/MODEL	YEARS	INSTALLATION KITS	WIRE HARNESS	WIRE HARNESS	ANTENNA ADAPTER	ANTENNA ADAPTER	SPKR ACCESSORIES
		INSTALLER PREFERRED	PLUGS INTO FACTORY HARNESS	PLUGS INTO FACTORY RADIO	AFTER MARKET ANTENNA TO FACTORY ANTENNA RADIO	AFTER MARKET ANTENNA TO FACTORY RADIO	GRILLS, BRACKETS & ADAPTERS
SKY (w/ OnStar)	2009	GM-K0410DDP/GM-K0410DD<<			CHR-A16	CHR-A17	
VUE	02-03		GM-1348		N/R	N/R	
VUE	04-05		GM-1354*		N/R	N/R	
VUE	07-06	GM-K0410DDP/GM-K0410DD<<	GM-1406PIO**		CHR-A16	CHR-A17	
VUE (w/o OnStar & w/o Bose)	08-09	GM-K0610DDP / GM-K0610DD<<	GM-1406PIO**		CHR-A16	CHR-A17	
VUE (w/ OnStar & w/o Bose)	08-09	GM-K0610DDP / GM-K0610DD<<			CHR-A16	CHR-A17	
VUE (w/ OnStar & w/ Bose)	08-09	GM-K0610DDP / GM-K0610DD<<			CHR-A16	CHR-A17	

# ACURA

MAKE/MODEL	YEARS	INSTALLATION KITS	WIRE HARNESS	WIRE HARNESS	ANTENNA ADAPTER	ANTENNA ADAPTER	SPKR ACCESSORIES
		INSTALLER PREFERRED	PLUGS INTO FACTORY HARNESS	PLUGS INTO FACTORY RADIO	AFTER MARKET ANTENNA TO FACTORY ANTENNA RADIO	AFTER MARKET ANTENNA TO FACTORY RADIO	GRILLS, BRACKETS & ADAPTERS
CL	97-99	HON-K8610P/HON-K8610DD<<	HON-1804	HON-1805M	N/R	N/R	
CL	01-03		HON-1806	HON-1807M	N/R	N/R	
INTEGRA	86-89		HON-1804	HON-1805M	N/R	N/R	
INTEGRA	90-98	HON-K8610P/HON-K8610DD<<	HON-1804	HON-1805M	N/R	N/R	
INTEGRA	99-01	HON-K8610P/HON-K8610DD<<	HON-1806	HON-1807M	N/R	N/R	
LEGEND	86-90	HON-K8610P/HON-K8610DD<<	HON-1804	HON-1805M	N/R	N/R	
LEGEND	91-96	HON-K8610P/HON-K8610DD<<	HON-1804	HON-1805M	N/R	N/R	
MDX	01-06		HON-1806	HON-1807M	N/R	N/R	
MDX	07-09				HON-A106	HON-107	
NSX	91-99		HON-1804	HON-1805M	N/R		
NSX	00-05						
RDX	07-09						
RL	96-98		HON-1804	HON-1805M	N/R	N/R	
RL	99-04		HON-1806	HON-1807M	N/R	N/R	
RL	05-09						
RSX non S-type	02-06		HON-1806	HON-1807M	N/R	N/R	
RSX S-type	02-06		HON-4808	HON-1807M	N/R	N/R	
SLX	96-99		ISU-1976	ISU-1977M	N/R	N/R	
TSX	04-08		HON-1806	HON-1807M			
TSX	2009						
TL	96-98	HON-K8610P/HON-K8610DD<<	HON-1804	HON-1805M	N/R	N/R	
TL	99-03		HON-1806	HON-1807M	N/R	N/R	
TL	04-05		HON-1806	HON-1807M			
TL	06-08						
TL	09-10						
VIGOR	92-94	HON-K8610P/HON-K8610DD<<	HON-1804	HON-1805M	N/R	N/R	

# ALFA ROMEO

MAKE/MODEL	YEARS	INSTALLATION KITS	WIRE HARNESS	WIRE HARNESS	ANTENNA ADAPTER	ANTENNA ADAPTER	SPKR ACCESSORIES
		INSTALLER PREFERRED	PLUGS INTO FACTORY HARNESS	PLUGS INTO FACTORY RADIO	AFTER MARKET ANTENNA TO FACTORY ANTENNA RADIO	AFTER MARKET ANTENNA TO FACTORY RADIO	GRILLS, BRACKETS & ADAPTERS
164	91-94				N/R	N/R	
77 SEDAN	86-89				N/R	N/R	
2000	73-89				N/R	N/R	
GTV-6	80-86				N/R	N/R	
MILANO	87-89				N/R	N/R	
SEDAN	73-85				N/R	N/R	
SPIDER	73-94				N/R	N/R	
SPIDER SPRINT	73-94				N/R	N/R	
SPIDER VELOCE	77-84				N/R	N/R	
SPORT SEDAN	79-82				N/R	N/R	

\* This harness works on standard wiring only. Not for amplified JBL, or premium sound systems.  
 \*\* Works on standard wiring systems only. Not for vehicles with Bose or On-Star systems.

< Requires factory mounting bracket.  
 << Fits Double Din or two Single ISO mount radios.  
 ^ Requires locating a switched 12v< power source for after-market radios.

# AUDI

MAKE/MODEL	YEARS	INSTALLATION KITS	WIRE HARNESS	WIRE HARNESS	ANTENNA ADAPTER	ANTENNA ADAPTER	SPKR ACCESSORIES
		INSTALLER PREFERRED	PLUGS INTO FACTORY HARNESS	PLUGS INTO FACTORY RADIO	AFTER MARKET ANTENNA TO ANTENNA	AFTER MARKET ANTENNA TO FACTORY RADIO	GRILLS, BRACKETS & ADAPTERS
80	88-95				N/R	N/R	
90	88-95				N/R	N/R	
100	89-94				N/R	N/R	
100 LS	73-82				N/R	N/R	
200	87-95				N/R	N/R	
4000	86-88				N/R	N/R	
5000	80-83				N/R	N/R	
5000S	84-89				N/R	N/R	
5000CS	85-89				N/R	N/R	
A3 w/oFACTORY Nav	06-10		EURO-11010	EURO-11009M	EURO-A108	EURO-A107	
A4	96-99		VW-11004		VW-A18	VW-A17	
A4	00-01		VW-11004		VW-A16L	VW-A17	
A4	02-08		EURO-11010	EURO-11009M	EURO-A106	EURO-A107	
A5	2008						
A6	96-99		VW-11004		VW-A18	VW-A17	
A6	00-01		EURO-11010	EURO-11009M	VW-A16L	VW-A17	
A6	02-08		EURO-11010	EURO-11009M	EURO-A106	EURO-A107	
A8	96-99		VW-11004		VW-A18	VW-A17	
A8	00-01		EURO-11010	EURO-11009M	VW-A16L	VW-A17	
A8	02-07		EURO-11010	EURO-11009M	EURO-A106	EURO-A107	
CABRIOLET	96-98				VW-A16L	VW-A17	
FOX	73-75				N/R	N/R	
FOX	76-79				N/R	N/R	
Q7	07-08						
R8	07-08						
S4	87-95				N/R	N/R	
S4	00-01		EURO-11010	EURO-11009M	VW-A16L	VW-A17	
S4	02-07		EURO-11010	EURO-11009M	EURO-A106	EURO-A107	
S5	07-08						
S6	87-95				N/R	N/R	
S6	00-01		EURO-11010	EURO-11009M	VW-A16L	VW-A17	
S6	02-07		EURO-11010	EURO-11009M	EURO-A106	EURO-A107	
S8	00-01		EURO-11010	EURO-11009M	VW-A16L	VW-A17	
S8	02-07		EURO-11010	EURO-11009M	EURO-A106	EURO-A107	
TT COUPE	00-06		VW-11004		VW-A18	VW-A17	
TT COUPE	07-10						

# BERTONE

MAKE/MODEL	YEARS	INSTALLATION KITS	WIRE HARNESS	WIRE HARNESS	ANTENNA ADAPTER	ANTENNA ADAPTER	SPKR ACCESSORIES
		INSTALLER PREFERRED	PLUGS INTO FACTORY HARNESS	PLUGS INTO FACTORY RADIO	AFTER MARKET ANTENNA TO ANTENNA	AFTER MARKET ANTENNA TO FACTORY RADIO	GRILLS, BRACKETS & ADAPTERS
SPORT COUPE	85-89						

# BMW

MAKE/MODEL	YEARS	INSTALLATION KITS	WIRE HARNESS	WIRE HARNESS	ANTENNA ADAPTER	ANTENNA ADAPTER	SPKR ACCESSORIES
		INSTALLER PREFERRED	PLUGS INTO FACTORY HARNESS	PLUGS INTO FACTORY RADIO	AFTER MARKET ANTENNA TO ANTENNA	AFTER MARKET ANTENNA TO FACTORY RADIO	GRILLS, BRACKETS & ADAPTERS
128i	2008						
135i	2008						
318i	84-98		BMW-1470	BMW-1471M	VW-A16L	VW-A17	
318	1999		BMW-1470	BMW-1471M	VW-A16L	VW-A17	
319i	1991		BMW-1470	BMW-1471M	VW-A16L	VW-A17	
320i	77-83				N/R	N/R	
323i	97-01		BMW-1470	BMW-1471M	VW-A16L	VW-A17	
325E	84-91				N/R	N/R	

\* This harness works on standard wiring only. Not for amplified, JBL, or premium sound systems.  
 \*\* Works on standard wiring systems only. Not for vehicles with Bose or On-Star systems.

< Requires factory mounting bracket.  
 << Fits Double Din or two Single ISO mount radios.  
 ^ Requires locating a switched 12v< power source for after-market radios.

# BMW cont.

MAKE/MODEL	YEARS	INSTALLATION KITS	WIRE HARNESS	WIRE HARNESS	ANTENNA ADAPTER	ANTENNA ADAPTER	SPKR ACCESSORIES
		INSTALLER PREFERRED	PLUGS INTO FACTORY HARNESS	PLUGS INTO FACTORY RADIO	AFTER MARKET ANTENNA TO FACTORY ANTENNA	AFTER MARKET ANTENNA TO FACTORY RADIO	GRILLS, BRACKETS & ADAPTERS
325i	92-97		BMW-1470	BMW-1471M	VW-A16L	VW-A17	
325	2001		BMW-1470	BMW-1471M	VW-A16L	VW-A17	
325	02-05		EURO-11010	EURO-11009M	EURO-A106	EURO-A107	
328E	84-85				N/R	N/R	
328i	97-01		BMW-1470	BMW-1471M	VW-A16L	VW-A17	
328i	06-07				EURO-A106	EURO-A107	
328xi	06-07				EURO-A106	EURO-A107	
330i	2001		BMW-1470	BMW-1471M	VW-A16L	VW-A17	
330	02-08		EURO-11010	EURO-11009M	EURO-A106	EURO-A107	
524	1986				N/R	N/R	
525	89-96		BMW-1470	BMW-1471M	VW-A16L	VW-A17	
5 SERIES	97-01	BMW-K9706P	BMW-1470	BMW-1471M	VW-A16L	VW-A17	
5 SERIES	02-03	BMW-K9706P	EURO-11010	EURO-11009M	EURO-A106	EURO-A107	
5 SERIES	04-09						
528E	75-86				N/R	N/R	
528E	87-88				N/R	N/R	
528i	77-86				N/R	N/R	
533i	82-86				N/R	N/R	
535i	82-86				N/R	N/R	
535i	87-88				N/R	N/R	
633CSI	77-84				N/R	N/R	
635CSI	85-86				N/R	N/R	
645	04-09						
733CSI	78-84				N/R	N/R	
735i	85-86				N/R	N/R	
735i	87-98		BMW-1470	BMW-1471M	VW-A16L	VW-A17	
740i	93-98		BMW-1470	BMW-1471M	VW-A16L	VW-A17	
FOX	99-01		BMW-1470	BMW-1471M	VW-A16L	VW-A17	
745	02-09						
750i	88-97		BMW-1470	BMW-1471M	VW-A16L	VW-A17	
850i	91-97		BMW-1470	BMW-1471M	VW-A16L	VW-A17	
L6	87-89				N/R	N/R	
L7	86-87				N/R	N/R	
M COUPE	99-01		BMW-1470	BMW-1471M	VW-A16L	VW-A17	
M3	89-98		BMW-1470	BMW-1471M	VW-A16L	VW-A17	
M3	99-01		BMW-1470	BMW-1471M	VW-A16L	VW-A17	
M3	02-06		EURO-11010	EURO-11009M	EURO-A106	EURO-A107	
M5	88-93				VW-A16L	VW-A17	
M5	00-01		BMW-1470	BMW-1471M	VW-A16L	VW-A17	
M5	02-03	BMW-K9706P	EURO-11010	EURO-11009M	EURO-A106	EURO-A107	
M6	87-90				VW-A16L	VW-A17	
X3	04-07						
X5	00-01						
X5 (w/o Nav)	02-06	BMW-K9706P	EURO-11010	EURO-11009M	EURO-A106	EURO-A107	
X5 (w/Factory Nav)	04-06		EURO-11010	EURO-11009M	EURO-A106	EURO-A107	
X5	07-08						
X6	2008						
Z3	96-01		BMW-1470	BMW-1471M	VW-A16L	VW-A17	
Z4	03-08		EURO-11010	EURO-11009M	EURO-A106	EURO-A107	
Z8	00-03						

# DAEWOO

MAKE/MODEL	YEARS	INSTALLATION KITS	WIRE HARNESS	WIRE HARNESS	ANTENNA ADAPTER	ANTENNA ADAPTER	SPKR ACCESSORIES
		INSTALLER PREFERRED	PLUGS INTO FACTORY HARNESS	PLUGS INTO FACTORY RADIO	AFTER MARKET ANTENNA TO FACTORY ANTENNA	AFTER MARKET ANTENNA TO FACTORY RADIO	GRILLS, BRACKETS & ADAPTERS
LANOS HATCHBACK	99-02		DAE-1664	DAE-1663M	N/R	N/R	
LANOS 4 Door	99-02		DAE-1664	DAE-1663M	N/R	N/R	
LEGANZA	99-02		DAE-1664	DAE-1663M	N/R	N/R	
NUBIRA SEDAN	99-02		DAE-1664	DAE-1663M	N/R	N/R	
NUBIRA WAGON	99-02		DAE-1664	DAE-1663M	N/R	N/R	

\* This harness works on standard wiring only.  
Not for amplified JBL, or premium sound systems.  
\*\* Works on standard wiring systems only.  
Not for vehicles with Bose or On-Star systems.

< Requires factory mounting bracket.  
<< Fits Double Din or two Single ISO mount radios.  
^ Requires locating a switched 12v< power source for after-market radios.



# DAIHATSU

MAKE/MODEL	YEARS	INSTALLATION KITS	WIRE HARNESS	WIRE HARNESS	ANTENNA ADAPTER	ANTENNA ADAPTER	SPKR ACCESSORIES
		INSTALLER PREFERRED	PLUGS INTO FACTORY HARNESS	PLUGS INTO FACTORY RADIO	AFTER MARKET ANTENNA TO FACTORY ANTENNA	AFTER MARKET ANTENNA TO FACTORY RADIO	GRILLS, BRACKETS & ADAPTERS
CHARADE	89-93				N/R	N/R	
ROCKY	90-92	N/R			N/R	N/R	

# FIAT

MAKE/MODEL	YEARS	INSTALLATION KITS	WIRE HARNESS	WIRE HARNESS	ANTENNA ADAPTER	ANTENNA ADAPTER	SPKR ACCESSORIES
		INSTALLER PREFERRED	PLUGS INTO FACTORY HARNESS	PLUGS INTO FACTORY RADIO	AFTER MARKET ANTENNA TO FACTORY ANTENNA	AFTER MARKET ANTENNA TO FACTORY RADIO	GRILLS, BRACKETS & ADAPTERS
131L	75-78						
2000 SPIDER	70-89						
BRAVA	78-83						
STRADA	79-83						
X1/9	75-78						
X1/9	79-88						

# GEO

MAKE/MODEL	YEARS	INSTALLATION KITS	WIRE HARNESS	WIRE HARNESS	ANTENNA ADAPTER	ANTENNA ADAPTER	SPKR ACCESSORIES
		INSTALLER PREFERRED	PLUGS INTO FACTORY HARNESS	PLUGS INTO FACTORY RADIO	AFTER MARKET ANTENNA TO FACTORY ANTENNA	AFTER MARKET ANTENNA TO FACTORY RADIO	GRILLS, BRACKETS & ADAPTERS
METRO	89-91		ISU-1974	ISU-1975M	N/R	N/R	
METRO	92-94		ISU-1974	ISU-1975M	N/R	N/R	
METRO	95-97	GM-K9210P	ISU-1974	ISU-1975M	N/R	N/R	USPA-5060
PRISM	89-92	TOY-K8004P	TOY-1950	TOY-1951M	N/R	N/R	
PRISM	93-94		ISU-1974	ISU-1975M	N/R	N/R	
PRISM	95-97		ISU-1974	ISU-1975M	N/R	N/R	
STORM	90-93		ISU-1974	ISU-1975M	N/R	N/R	
TRACKER	89-91		ISU-1974	ISU-1975M	N/R	N/R	
TRACKER	92-94		ISU-1974	ISU-1975M	N/R	N/R	
TRACKER	1995		ISU-1974	ISU-1975M	N/R	N/R	
TRACKER	96-97		ISU-1974	ISU-1975M	N/R	N/R	

# HONDA

MAKE/MODEL	YEARS	INSTALLATION KITS	WIRE HARNESS	WIRE HARNESS	ANTENNA ADAPTER	ANTENNA ADAPTER	SPKR ACCESSORIES
		INSTALLER PREFERRED	PLUGS INTO FACTORY HARNESS	PLUGS INTO FACTORY RADIO	AFTER MARKET ANTENNA TO FACTORY ANTENNA	AFTER MARKET ANTENNA TO FACTORY RADIO	GRILLS, BRACKETS & ADAPTERS
ACCORD	76-81				N/R	N/R	
ACCORD	82-85				N/R	N/R	
ACCORD	86-89		HON-1804	HON-1805M	N/R	N/R	
ACCORD	90-97	HON-K8610P/HON-K8610DD<<	HON-1804	HON-1805M	N/R	N/R	
ACCORD	98-02	HON-K8610P/HON-K8610DD<<	HON-1806	HON-1807M	N/R	N/R	
ACCORD (relocation kit)	03-07			HON-1820	N/R	N/R	
ACCORD (Atlas Grey)	08-10		HON-1812	HON-1813M	HON-A106	HON-A107	
ACCORD (Earth Taupe)	08-10		HON-1812	HON-1813M	HON-A106	HON-A107	
CIVIC	74-79				N/R	N/R	
CIVIC	80-81				N/R	N/R	
CIVIC	82-85				N/R	N/R	
CIVIC	86-95		HON-1804	HON-1805M	N/R	N/R	
CIVIC	96-98		HON-1804	HON-1805M	N/R	N/R	
CIVIC (w/factory alarm)	96-98			HON-1805M	N/R	N/R	

\* This harness works on standard wiring only. Not for amplified, JBL, or premium sound systems.  
 \*\* Works on standard wiring systems only. Not for vehicles with Bose or On-Star systems.

< Requires factory mounting bracket.  
 << Fits Double Din or two Single ISO mount radios.  
 ^ Requires locating a switched 12v< power source for after-market radios.

# HONDA cont.

MAKE/MODEL	YEARS	INSTALLATION KITS	WIRE HARNESS	WIRE HARNESS	ANTENNA ADAPTER	ANTENNA ADAPTER	SPKR ACCESSORIES
		INSTALLER PREFERRED	PLUGS INTO FACTORY HARNESS	PLUGS INTO FACTORY RADIO	AFTER MARKET ANTENNA TO FACTORY ANTENNA	AFTER MARKET ANTENNA TO FACTORY RADIO	GRILLS, BRACKETS & ADAPTERS
CIVIC	99-00	HON-K8610P/HON-K8610DD<<	HON-1806	HON-1807M	N/R	N/R	
CIVIC SPECIAL EDITION	2005	HON-K8610P/HON-K8610DD<<	HON-1806	HON-1807M	N/R	N/R	
CIVIC	01-05		HON-1806	HON-1807M	N/R	N/R	
CIVIC (graphite black dash color)	06-10		HON-1812	HON-1813M	HON-A106	HON-A107	
CIVIC (gun metal dash color)	06-10		HON-1812	HON-1813M	HON-A106	HON-A107	
CIVIC SI	02-05		HON-1806	HON-1807M	N/R	N/R	
CRV	97-98	HON-K8610P/HON-K8610DD<<	HON-1804	HON-1805M	N/R	N/R	
CRV	99-06	HON-K8610P/HON-K8610DD<<	HON-1806	HON-1807M	N/R	N/R	
CRV	07-09	HON-K0710DDP<< / HON-K0710DD	HON-1812	HON-1813M	HON-A106	HON-A107	
CRX	84-85				N/R	N/R	
CRX	86-87		HON-1804	HON-1805M	N/R	N/R	
CRX	88-91		HON-1804	HON-1805M	N/R	N/R	
DELSOL	93-97		HON-1804	HON-1805M	N/R	N/R	
ELEMENT	03-06	HON-K8610P/HON-K8610DD<<	HON-1806	HON-1807M	N/R	N/R	
ELEMENT LX	07-10	HON-K8610P/HON-K8610DD<<	HON-1806	HON-1807M	HON-A106	HON-A107	
ELEMENT SE	07-10	HON-K8610P/HON-K8610DD<<	HON-1806	HON-1807M	HON-A106	HON-A107	
FIT	07-08		HON-1812	HON-1813M	HON-A106	HON-A107	
FIT	09-10		HON-1812	HON-1813M	HON-A106	HON-A107	
INSIGHT	01-06		HON-1806	HON-1807M	N/R	N/R	
INSIGHT	2010						
ODYSSEY	95-98	HON-K8610P/HON-K8610DD<<	HON-1804	HON-1805M	N/R	N/R	
ODYSSEY	99-04	HON-K8610P/HON-K8610DD<<	HON-1806	HON-1807M	N/R	N/R	
ODYSSEY	05-07		HON-1806	HON-1807M	HON-A106	HON-A107	
ODYSSEY	08-10		HON-1812	HON-1813M	HON-A106	HON-A107	
PASSPORT	94-95		ISU-1974	ISU-1975M	N/R	N/R	
PASSPORT	96-97		ISU-1976	ISU-1977M	N/R	N/R	
PASSPORT	98-02	GM-K9210P/GM-K9210DD<<	ISU-1976	ISU-1977M	N/R	N/R	
PILOT (upper dash)	03-05		HON-1806	HON-1807M	N/R	N/R	
PILOT EXL (upper dash)	06-08		HON-1806	HON-1807M	HON-A106	HON-A107	
PILOT LX (upper dash)	06-08	HON-K8610DD<<	HON-1806	HON-1807M	HON-A106	HON-A107	
PILOT	09-10		HON-1810	HON-1813M	HON-A106	HON-A107	
PRELUDE	79-80				N/R	N/R	
PRELUDE	81-82				N/R	N/R	
PRELUDE	83-85				N/R	N/R	
PRELUDE	86-91		HON-1804	HON-1805M	N/R	N/R	
PRELUDE	92-96	HON-K8610P/HON-K8610DD<<	HON-1804	HON-1805M	N/R	N/R	
PRELUDE	97-98	HON-K8610P/HON-K8610DD<<	HON-1804	HON-1805M	N/R	N/R	
PRELUDE	99-01	HON-K8610P/HON-K8610DD<<	HON-1806	HON-1807M	N/R	N/R	
RIDGELINE	06-10		HON-1806	HON-1807M	HON-A106	HON-A107	
S2000	00-07		HON-1806	HON-1807M	N/R	N/R	

# HYUNDAI

MAKE/MODEL	YEARS	INSTALLATION KITS	WIRE HARNESS	WIRE HARNESS	ANTENNA ADAPTER	ANTENNA ADAPTER	SPKR ACCESSORIES
		INSTALLER PREFERRED	PLUGS INTO FACTORY HARNESS	PLUGS INTO FACTORY RADIO	AFTER MARKET ANTENNA TO FACTORY ANTENNA	AFTER MARKET ANTENNA TO FACTORY RADIO	GRILLS, BRACKETS & ADAPTERS
ACCENT	95-99	UNI-K8208	HYU-11100	HYU-11101M	N/R	N/R	
ACCENT	00-01		HYU-11102	HYU-11103M	N/R	N/R	
ACCENT	02-05		HYU-11102	HYU-11103M	N/R	N/R	
ACCENT	06-08		HYU-11106	HYU-11107M	N/R	N/R	
ACCENT	09-10		HYU-11110		HYU-A106	HYU-A107	
ACCENT (w/ radio delete)	09-10		HYU-11110		N/R	N/R	
AZERA	06-08		HYU-11106*	HYU-11107M	N/R	N/R	
AZERA	2009		HYU-11110		KIA-A106	KIA-A107	
ELANTRA	92-95		HYU-11100	HYU-11101M	N/R	N/R	
ELANTRA	96-00		HYU-11100	HYU-11101M	N/R	N/R	
ELANTRA (w/factory pocket)	01-06		HYU-11102	HYU-11103M	N/R	N/R	
ELANTRA (oversized radio)	01-06		HYU-11102*	HYU-11103M	N/R	N/R	
ELANTRA	07-08		HYU-11106	HYU-11107M	N/R	N/R	
ELANTRA (w/radio delete)	09-10		HYU-11106	HYU-11107M	N/R	N/R	
ELANTRA (w/FACTORY radio)	09-10		HYU-11110		HYU-A106	HYU-A107	
ELANTRA TOURING	09-10		HYU-11110		HYU-A106	HYU-A107	
ENTOURAGE	07-09		HYU-11106	HYU-11107M	N/R	N/R	
EXCEL	86-89		UI-1990		N/R	N/R	

\* This harness works on standard wiring only.  
Not for amplified, JBL, or premium sound systems.

\*\* Works on standard wiring systems only.  
Not for vehicles with Bose or On-Star systems.

< Requires factory mounting bracket.

<< Fits Double Din or two Single ISO mount radios.

^ Requires locating a switched 12v< power source for after-market radios.

# HYUNDAI cont.

MAKE/MODEL	YEARS	INSTALLATION KITS	WIRE HARNESS	WIRE HARNESS	ANTENNA ADAPTER	ANTENNA ADAPTER	SPKR ACCESSORIES
			PLUGS INTO FACTORY HARNESS	PLUGS INTO FACTORY RADIO	AFTER MARKET ANTENNA TO FACTORY ANTENNA	AFTER MARKET ANTENNA TO FACTORY RADIO	GRILLS, BRACKETS & ADAPTERS
EXCEL	90-94		HYU-11100	HYU-11101M	N/R	N/R	
GENESIS SEDAN	2009		HYU-11110		KIA-A106	KIA-A107	
GENESIS COUPE	2010		HYU-11110				
SANTA FE (w/FACTORY pocket)	01-05		HYU-11102	HYU-11103M	N/R	N/R	
SANTA FE (oversized radio)	01-06		HYU-11102*	HYU-11103M	N/R	N/R	
SANTA FE (w/ monsoon system)	03-06		GM-1416	GM-1416-1M	N/R	N/R	
SANTA FE	07-08		HYU-11108	HYU-11109M	N/R	N/R	
SANTA FE	09-10		HYU-11110	HYU-11101M	HYU-A106	HYU-A107	
SCOUBE	91-95		HYU-11100	HYU-11101M	N/R	N/R	
SONATA	89-94		HYU-11100	HYU-11101M	N/R	N/R	USPA-5060
SONATA	95-98		HYU-11100	HYU-11101M	N/R	N/R	USPA-5060
SONATA	99-01		HYU-11102	HYU-11103M	N/R	N/R	USPA-5060
SONATA (non amplified)	02-05		HYU-11102*	HYU-11103M	N/R	N/R	
SONATA	07-08		FD-5520	FD-5521M	N/R	N/R	
SONATA	2009		HYU-11110		HYU-A106	HYU-A107	
SONATA (w/ Infinity System)	09-10		HYU-11110		HYU-A106	HYU-A107	
SONATA (w/FACTORY Nav)	09-10		HYU-11110		HYU-A106	HYU-A107	
TIBURON (single ISO only)	97-02		HYU-11100	HYU-11101M	N/R	N/R	
TIBURON (oversized radio)	99-02		HYU-11102*	HYU-11103M	N/R	N/R	
TIBURON	03-08		HYU-11102*	HYU-11103M	N/R	N/R	
TUCSON	05-08		HYU-11102*	HYU-11103M	N/R	N/R	
TUCSON	09-10		HYU-11110		HYU-A106	HYU-A107	
VERACRUZ	07-08		HYU-11106	HYU-11107M	N/R	N/R	
VERACRUZ	09-10		HYU-11110				
XG 300	2001		HYU-11102	HYU-11103M	N/R	N/R	
XG 350	02-05		HYU-11102	HYU-11103M	N/R	N/R	

# INFINITI

MAKE/MODEL	YEARS	INSTALLATION KITS	WIRE HARNESS	WIRE HARNESS	ANTENNA ADAPTER	ANTENNA ADAPTER	SPKR ACCESSORIES
			PLUGS INTO FACTORY HARNESS	PLUGS INTO FACTORY RADIO	AFTER MARKET ANTENNA TO FACTORY ANTENNA	AFTER MARKET ANTENNA TO FACTORY RADIO	GRILLS, BRACKETS & ADAPTERS
EX35	2009						
FX	2009						
FX35	03-08						
FX45	03-09						
G20	91-96	UNI-K8208<	NIS-1700	NIS-1701M	NIS-A115	NIS-A17	USPA-5060
G20	99-03	UNI-K8208<	NIS-1702	NIS-1703M	NIS-A115	NIS-A17	
G35	03-06		NIS-4702	NIS-1703M	NIS-A110	NIS-A120	
G35	07-08						
G37	09-10		NIS-1704	NIS-1704	NIS-A106	NIS-A107	
G75	2008						
I30	96-99	UNI-K8208<	NIS-1702	NIS-1703M	NIS-A115	NIS-A17	USPA-5060
I30	00-03		NIS-4702	NIS-1703M	NIS-A115	NIS-A17	USPA-5060
I35	02-04		NIS-4702	NIS-1703M	NIS-A110	NIS-A120	
J30	93-97		NIS-4700		NIS-A110	NIS-A120	
M30	90-93	UNI-K8208<	NIS-1700	NIS-1701M	NIS-A115	NIS-A17	
M45	03-06				NIS-A110	NIS-A120	
QX4	97-01	UNI-K8208<	NIS-4702	NIS-1703M	NIS-A115	NIS-A17	USPA-5060
QX4	02-03		NIS-1702	NIS-1703M	NIS-A115	NIS-A17	
Q45	90-93	UNI-K8208<	NIS-1700	NIS-1701M	NIS-A115	NIS-A17	
Q45	94-96	UNI-K8208<	NIS-1702	NIS-1703M	NIS-A115	NIS-A17	
Q45	97-00	UNI-K8208<	NIS-1702	NIS-1703M	NIS-A115	NIS-A17	
Q45	01-06		NIS-4702	NIS-1703M			
QX56	04-09				NIS-A110	NIS-A120	

\* This harness works on standard wiring only. Not for amplified, JBL, or premium sound systems.  
 \*\* Works on standard wiring systems only. Not for vehicles with Bose or On-Star systems.

< Requires factory mounting bracket.  
 << Fits Double Din or two Single ISO mount radios.  
 ^ Requires locating a switched 12v< power source for after-market radios.

# ISUZU

MAKE/MODEL	YEARS	INSTALLATION KITS	WIRE HARNESS	WIRE HARNESS	ANTENNA ADAPTER	ANTENNA ADAPTER	SPKR ACCESSORIES
		INSTALLER PREFERRED	PLUGS INTO FACTORY HARNESS	PLUGS INTO FACTORY RADIO	AFTER MARKET ANTENNA TO ANTENNA	AFTER MARKET ANTENNA TO FACTORY RADIO	GRILLS, BRACKETS & ADAPTERS
AMIGO	89-94		ISU-1974	ISU-1975M	N/R	N/R	
AMIGO	98-00	GM-K9210P/GM-K9210DD<<	ISU-1976		N/R	N/R	
ASCENDER	03-08	GM-K9210P/GM-K9210DD<<			GM-A16	GM-A17	
AXIOM	02-03						
HOMBRE	96-97		GM-1344	GM-1343M	GM-A16	GM-A17	
HOMBRE	98-01	GM-K8204	GM-1344	GM-1343M	GM-A16	GM-A17	
i-280	06-07	GM-K9210P/GM-K9210DD<<		GM-1416M	GM-A16	GM-A17	
i-290	07-09	GM-K9210P/GM-K9210DD<<		GM-1416M	GM-A16	GM-A17	
i-350	07-07	GM-K9210P/GM-K9210DD<<		GM-1416M	GM-A16	GM-A17	
i-370	07-09	GM-K9210P/GM-K9210DD<<		GM-1416M	GM-A16	GM-A17	
I-MARK	80-81				N/R	N/R	
I-MARK	82-85		ISU-1974	ISU-1975M	N/R	N/R	
I-MARK	86-89		ISU-1974	ISU-1975M	N/R	N/R	
IMPULSE	83-89				N/R	N/R	
IMPULSE	90-92		ISU-1974	ISU-1975M	N/R	N/R	
OASIS	96-99	HON-K8610P/HON-K8610DD<<	HON-1804	HON-1805M	N/R	N/R	
PICKUP	81-87		UI-1990	ISU-1975M	N/R	N/R	
PICKUP	88-95		ISU-1974	ISU-1975M	N/R	N/R	
RODEO	91-95		ISU-1974	ISU-1975M	N/R	N/R	
RODEO	96-97		ISU-1976		N/R	N/R	
RODEO	98-04	GM-K9210P/GM-K9210DD<<	ISU-1976		N/R	N/R	
STYLUS	91-93		ISU-1974	ISU-1975M	N/R	N/R	
TROOPER	84-91		ISU-1974	ISU-1975M	N/R	N/R	
TROOPER	92-94		ISU-1974	ISU-1975M	N/R	N/R	
TROOPER	95-97		ISU-1976		N/R	N/R	
TROOPER	98-02		ISU-1976		N/R	N/R	
VEHICROSS	99-01		ISU-1976		N/R	N/R	

# JAGUAR

MAKE/MODEL	YEARS	INSTALLATION KITS	WIRE HARNESS	WIRE HARNESS	ANTENNA ADAPTER	ANTENNA ADAPTER	SPKR ACCESSORIES
		INSTALLER PREFERRED	PLUGS INTO FACTORY HARNESS	PLUGS INTO FACTORY RADIO	AFTER MARKET ANTENNA TO ANTENNA	AFTER MARKET ANTENNA TO FACTORY RADIO	GRILLS, BRACKETS & ADAPTERS
ALL MODELS	01-05						
S3.0	2000						
S4.0	2000						
S-TYPE	2007						
XJ6	72-83						
XJ6	88-97						
XJ12	72-83						
XJ12	84-97						
XJ8	98-00						
XJR6	96-00						
XJS	75-89						
XJS	96-97						
XJ	2007						
XK	2007						
XK6	84-87						
XK8	1997						
XK8	98-00						
XKR	1999						
X-TYPE	2007						

# KIA

MAKE/MODEL	YEARS	INSTALLATION KITS	WIRE HARNESS	WIRE HARNESS	ANTENNA ADAPTER	ANTENNA ADAPTER	SPKR ACCESSORIES
		INSTALLER PREFERRED	PLUGS INTO FACTORY HARNESS	PLUGS INTO FACTORY RADIO	AFTER MARKET ANTENNA TO ANTENNA	AFTER MARKET ANTENNA TO FACTORY RADIO	GRILLS, BRACKETS & ADAPTERS
AMANTI	04-06		HYU-111102*	HYU-111103M	N/R	N/R	
AMANTI	07-09				KIA-A106	KIA-A107	

\* This harness works on standard wiring only. Not for amplified JBL, or premium sound systems.  
 \*\* Works on standard wiring systems only. Not for vehicles with Bose or On-Star systems.

< Requires factory mounting bracket.  
 << Fits Double Din or two Single ISO mount radios.  
 ^ Requires locating a switched 12v< power source for after-market radios.

# KIA cont.

MAKE/MODEL	YEARS	INSTALLATION KITS	WIRE HARNESS	WIRE HARNESS	ANTENNA ADAPTER	ANTENNA ADAPTER	SPKR ACCESSORIES
			PLUGS INTO FACTORY HARNESS	PLUGS INTO FACTORY RADIO	AFTER MARKET ANTENNA TO FACTORY ANTENNA	AFTER MARKET ANTENNA TO FACTORY RADIO	GRILLS, BRACKETS & ADAPTERS
BORREGO	09-10		HYU-11110		KIA-A106	KIA-A107	
FORTE	10-11		HYU-11110		HYU-A106	HYU-A107	
FORTE KOUP	10-11		HYU-11110		HYU-A106	HYU-A107	
OPTIMA	01-05		HYU-11102	HYU-11103M	N/R	N/R	
OPTIMA	06-08		HYU-11106	HYU-11107M	N/R	N/R	
OPTIMA	09-10		HYU-11110		KIA-A106	KIA-A107	
RIO	01-02		KIA-1832	KIA-1833M	N/R	N/R	
RIO	03-05		HYU-11102	HYU-11103M	N/R	N/R	
RIO	06-08		HYU-11106	HYU-11107M	N/R	N/R	
RIO	09-10		HYU-11110		HYU-A106	HYU-A107	
RIO 5	06-08		HYU-11106	HYU-11107M	N/R	N/R	
RIO 5	09-10		HYU-11110		HYU-A106	HYU-A107	
RONDO	07-08		HYU-11106	HYU-11107M			
RONDO	09-10		HYU-11110		HYU-A106	HYU-A107	
SEDONA	02-05		KIA-1832	KIA-1833M	N/R	N/R	
SEDONA	06-08		HYU-11106	HYU-11107M	N/R	N/R	
SEPHIA	95-98		KIA-1832	KIA-1833M	N/R	N/R	
SEPHIA	99-02		KIA-1832	KIA-1833M	N/R	N/R	
SORENTO EX	03-06		GM-1416	GM-1416-IM	GM-A16	GM-A16	
SORENTO LX	03-06		HYU-11102	HYU-11103M	N/R	N/R	
SORENTO	07-09		HYU-11108	HYU-11109M	N/R	N/R	
SOUL	2010		HYU-11110		HYU-A106	HYU-A107	
SPECTRA	00-03		KIA-1832	KIA-1833M	N/R	N/R	
SPECTRA	04-06		HYU-11102	HYU-11103M	N/R	N/R	
SPECTRA	07-09		HYU-11102	HYU-11103M			
SPECTRA 5	05-06		HYU-11102	HYU-11103M	N/R	N/R	
SPECTRA 5	07-08		HYU-11102	HYU-11103M			
SPORTAGE	96-97		KIA-1832	KIA-1833M	N/R	N/R	
SPORTAGE	98-02		KIA-1832	KIA-1833M	N/R	N/R	
SPORTAGE	05-08		HYU-11106	HYU-11107M	N/R	N/R	

# LANDROOVER

MAKE/MODEL	YEARS	INSTALLATION KITS	WIRE HARNESS	WIRE HARNESS	ANTENNA ADAPTER	ANTENNA ADAPTER	SPKR ACCESSORIES
			PLUGS INTO FACTORY HARNESS	PLUGS INTO FACTORY RADIO	AFTER MARKET ANTENNA TO FACTORY ANTENNA	AFTER MARKET ANTENNA TO FACTORY RADIO	GRILLS, BRACKETS & ADAPTERS
DEFENDER	87-94						
DISCOVERY	94-98						
DISCOVERY	99-04						
FREELANDER	02-05						
LR2	07-08						
LR3	05-07						
RANGE ROVER	87-05						
RANGE ROVER	06-07						

# LEXUS

MAKE/MODEL	YEARS	INSTALLATION KITS	WIRE HARNESS	WIRE HARNESS	ANTENNA ADAPTER	ANTENNA ADAPTER	SPKR ACCESSORIES
			PLUGS INTO FACTORY HARNESS	PLUGS INTO FACTORY RADIO	AFTER MARKET ANTENNA TO FACTORY ANTENNA	AFTER MARKET ANTENNA TO FACTORY RADIO	GRILLS, BRACKETS & ADAPTERS
ES250	90-91	UNI-K8208	TOY-1950	TOY-1951M	N/R	N/R	
ES300	92-96				N/R	N/R	
ES300	97-03		TOY-4960				
ES330	04-06						
ES350	07-09						
GS HYBRID	2007						
GS300	93-97						
GS300 (w/oFACTORY Nav)	98-05						

\* This harness works on standard wiring only. Not for amplified, JBL, or premium sound systems.  
 \*\* Works on standard wiring systems only. Not for vehicles with Bose or On-Star systems.

< Requires factory mounting bracket.  
 << Fits Double Din or two Single ISO mount radios.  
 ^ Requires locating a switched 12v< power source for after-market radios.

# LEXUS cont.

MAKE/MODEL	YEARS	INSTALLATION KITS	WIRE HARNESS	WIRE HARNESS	ANTENNA ADAPTER	ANTENNA ADAPTER	SPKR ACCESSORIES
		INSTALLER PREFERRED	PLUGS INTO FACTORY HARNESS	PLUGS INTO FACTORY RADIO	AFTER MARKET ANTENNA TO FACTORY ANTENNA	AFTER MARKET ANTENNA TO FACTORY RADIO	GRILLS, BRACKETS & ADAPTERS
GS300	2006						
GS350	07-09						
GS400	98-03						
GS430	01-07						
GS450h	07-09						
GS460	08-09						
GX470	04-09						
IS250	06-09						
IS300	01-05				N/R	N/R	
IS350	06-09						
IS500	2008						
IS F	08-09						
LS400	90-00						
LS430	03-06						
LS460	07-09						
LS500	2008						
LS600	08-09						
LX450	96-97	UNI-K8208<	TOY-1950	TOY-1951M	N/R	N/R	
LX470	98-05				N/R	N/R	
LX470	06-07						
RX300	99-03						
RX330	04-06						
RX350	07-09						
RX400h	06-09						
SC300	92-00						
SC400	92-00						
SC430	01-09						

# MAZDA

MAKE/MODEL	YEARS	INSTALLATION KITS	WIRE HARNESS	WIRE HARNESS	ANTENNA ADAPTER	ANTENNA ADAPTER	SPKR ACCESSORIES
		INSTALLER PREFERRED	PLUGS INTO FACTORY HARNESS	PLUGS INTO FACTORY RADIO	AFTER MARKET ANTENNA TO FACTORY ANTENNA	AFTER MARKET ANTENNA TO FACTORY RADIO	GRILLS, BRACKETS & ADAPTERS
3	04-09	MAZ-K0409DDP / MAZ-K0409DD	MAZ-1858	MAZ-1859M	N/R	N/R	USPA-6090
3	2010		MAZ-1858	MAZ-1859M			USPA-6090
323	86-89				N/R	N/R	
323	90-94		MAZ-1856	MAZ-1857M	N/R	N/R	
5	06-07						USPA-6090
5	08-10		MAZ-1858	MAZ-1859M	N/R	N/R	
6	03-05		MAZ-1858	MAZ-1859M	N/R	N/R	USPA-6090
6	06-08						USPA-6090
6	09-10						
626	79-80				N/R	N/R	
626	81-82				N/R	N/R	
626	83-85				N/R	N/R	
626	86-87		MAZ-1856	MAZ-1857M	N/R	N/R	
626	88-92		MAZ-1856	MAZ-1857M	N/R	N/R	
626	93-00	UNI-K8208	MAZ-1858	MAZ-1859M	N/R	N/R	USPA-6090
626	01-02		MAZ-1856	MAZ-1857M	N/R	N/R	USPA-6090
929	88-91		MAZ-1856	MAZ-1857M	N/R	N/R	
929	92-96	UNI-K8208			N/R	N/R	USPA-6090
B-SERIES TRUCK	71-81				N/R	N/R	
B-SERIES TRUCK	82-85				N/R	N/R	
B-SERIES TRUCK	86-93		FD-1594	FD-1593M	N/R	N/R	
B-SERIES TRUCK	1994		FD-1594*	FD-1593M	N/R	N/R	USPA-6090
B-SERIES TRUCK	95-97	FM-K9510P/FM-K9510DD	FD-1598*	FD-1597M	N/R	N/R	USPA-6090
B-SERIES TRUCK	98-10	FM-K9510P/FM-K9510DD<<	MAZ-1858	MAZ-1859M	N/R	N/R	USPA-6090
CX-7	07-09		MAZ-1858	MAZ-1859M	N/R	N/R	
CX-9	07-10				N/R	N/R	
GLC	77-80				N/R	N/R	
GLC	81-85		MAZ-1856	MAZ-1857M	N/R	N/R	
MIATA	89-97		MAZ-1856	MAZ-1857M	N/R	N/R	
MIATA	99-00	UNI-K8208	MAZ-1858	MAZ-1859M	N/R	N/R	USPA-6090
MIATA	01-05		MAZ-1858	MAZ-1859M	N/R	N/R	
MIATA MX5	06-09		MAZ-1856	MAZ-1857M	N/R	N/R	

\* This harness works on standard wiring only. Not for amplified JBL, or premium sound systems.  
 \*\* Works on standard wiring systems only. Not for vehicles with Bose or On-Star systems.

< Requires factory mounting bracket.  
 << Fits Double Din or two Single ISO mount radios.  
 ^ Requires locating a switched 12v< power source for after-market radios.

# MAZDA cont.

MAKE/MODEL	YEARS	INSTALLATION KITS	WIRE HARNESS	WIRE HARNESS	ANTENNA ADAPTER	ANTENNA ADAPTER	SPKR ACCESSORIES
		INSTALLER PREFERRED	PLUGS INTO FACTORY HARNESS	PLUGS INTO FACTORY RADIO	AFTER MARKET ANTENNA TO FACTORY ANTENNA	AFTER MARKET ANTENNA TO FACTORY RADIO	GRILLS, BRACKETS & ADAPTERS
MILLENNIA	95-99	UNI-K8208	MAZ-1858	MAZ-1859M	N/R	N/R	
MILLENNIA	00-02		MAZ-1856	MAZ-1857M	N/R	N/R	USPA-6090
MPV	89-95		MAZ-1856	MAZ-1857M	N/R	N/R	
MPV	96-99	UNI-K8208	MAZ-1856	MAZ-1857M	N/R	N/R	
MPV	00-02		MAZ-1858	MAZ-1859M	N/R	N/R	
MPV	03-06		MAZ-1856	MAZ-1857M	N/R	N/R	
MX-3	92-97	UNI-K8208			N/R	N/R	
MX-6	1988		MAZ-1856	MAZ-1857M	N/R	N/R	
MX-6	89-92		MAZ-1856	MAZ-1857M	N/R	N/R	
MX-6	93-97	UNI-K8208	FD-1594	FD-1593M	N/R	N/R	USPA-6090
NAVAJO	91-94		MAZ-1856	MAZ-1857M	N/R	N/R	USPA-6090
PROTÉGÉ	90-94		MAZ-1856	MAZ-1857M	N/R	N/R	
PROTÉGÉ	95-00	UNI-K8208	MAZ-1858	MAZ-1859M	N/R	N/R	
PROTÉGÉ	01-03		MAZ-1858	MAZ-1859M	N/R	N/R	
PROTÉGÉ 5	01-03				N/R	N/R	
RX-7	79-82				N/R	N/R	
RX-7	83-85				N/R	N/R	
RX-7	86-88		MAZ-1856	MAZ-1857M	N/R	N/R	
RX-7	89-92		MAZ-1856	MAZ-1857M	N/R	N/R	
RX-7	93-96	UNI-K8208	MAZ-1858	MAZ-1859M	N/R	N/R	
RX-8	04-09		MAZ-1856	MAZ-1857M	N/R	N/R	USPA-6090
TRIBUTE	01-02		MAZ-1858	MAZ-1859M	N/R	N/R	USPA-6090
TRIBUTE	03-07				N/R	N/R	USPA-6090
TRIBUTE (Flat Black)	08-10				CHR-A16	CHR-A17	USPA-6090
TRIBUTE (Silver)	08-10				CHR-A16	CHR-A17	USPA-6090

# MERCEDES

MAKE/MODEL	YEARS	INSTALLATION KITS	WIRE HARNESS	WIRE HARNESS	ANTENNA ADAPTER	ANTENNA ADAPTER	SPKR ACCESSORIES
		INSTALLER PREFERRED	PLUGS INTO FACTORY HARNESS	PLUGS INTO FACTORY RADIO	AFTER MARKET ANTENNA TO FACTORY ANTENNA	AFTER MARKET ANTENNA TO FACTORY RADIO	GRILLS, BRACKETS & ADAPTERS
190 SERIES	84-93				N/R	N/R	
300 SERIES	86-96				VW-A16L	VW-A17	
C-CLASS	01-04				VW-A16L	VW-A17	
C-CLASS	05-07				EURO-A106	EURO-107	
C-CLASS	08-09						
CLK-320	95-01				VW-A16L	VW-A17	
MOST MODELS (w/o Nav)	73-01				VW-A16L	VW-A17	

# MG

MAKE/MODEL	YEARS	INSTALLATION KITS	WIRE HARNESS	WIRE HARNESS	ANTENNA ADAPTER	ANTENNA ADAPTER	SPKR ACCESSORIES
		INSTALLER PREFERRED	PLUGS INTO FACTORY HARNESS	PLUGS INTO FACTORY RADIO	AFTER MARKET ANTENNA TO FACTORY ANTENNA	AFTER MARKET ANTENNA TO FACTORY RADIO	GRILLS, BRACKETS & ADAPTERS
MGB	73-81						
MGB GT	73-80						
MIDGET	70-81						

# MINI

MAKE/MODEL	YEARS	INSTALLATION KITS	WIRE HARNESS	WIRE HARNESS	ANTENNA ADAPTER	ANTENNA ADAPTER	SPKR ACCESSORIES
		INSTALLER PREFERRED	PLUGS INTO FACTORY HARNESS	PLUGS INTO FACTORY RADIO	AFTER MARKET ANTENNA TO FACTORY ANTENNA	AFTER MARKET ANTENNA TO FACTORY RADIO	GRILLS, BRACKETS & ADAPTERS
COOPER / COOPER S / CONVERTIBLE	02-08	MC-K0208	EURO-11010	EURO-11009M	EURO-A106	EURO-107	
COOPER CLUBMAN S	08-09				EURO-A106	EURO-107	
COOPER	09-10						

\* This harness works on standard wiring only. Not for amplified, JBL, or premium sound systems.  
 \*\* Works on standard wiring systems only. Not for vehicles with Bose or On-Star systems.

< Requires factory mounting bracket.  
 << Fits Double Din or two Single ISO mount radios.  
 ^ Requires locating a switched 12v< power source for after-market radios.

# MITSUBISHI

MAKE/MODEL	YEARS	INSTALLATION KITS	WIRE HARNESS	WIRE HARNESS	ANTENNA ADAPTER	ANTENNA ADAPTER	SPKR ACCESSORIES
		INSTALLER PREFERRED	PLUGS INTO FACTORY HARNESS	PLUGS INTO FACTORY RADIO	AFTER MARKET ANTENNA TO ANTENNA	AFTER MARKET ANTENNA TO FACTORY RADIO	GRILLS, BRACKETS & ADAPTERS
3000GT	91-94	UNI-K9108<	CI-1610		N/R	N/R	USPA-5060
3000GT	95-99	UNI-K9108<	CI-1612	CI-1613M	N/R	N/R	USPA-5060
CORDIA	83-91		CI-1610		N/R	N/R	
DIAMANTE	92-94		CI-1610		N/R	N/R	
DIAMANTE	95-96		CI-1612	CI-1613M	N/R	N/R	
DIAMANTE	97-03	UNI-K9108<	CI-1612	CI-1613M	N/R	N/R	USPA-5060
ECLIPSE	89-94		CI-1610		N/R	N/R	USPA-5060
ECLIPSE	95-99		CI-1612	CI-1613M	N/R	N/R	USPA-5060
ECLIPSE (w/factory amp)	95-99		DODG-462A	CI-1613M	N/R	N/R	USPA-5060
ECLIPSE	00-05		CI-1612*	CI-1613M	N/R	N/R	
ECLIPSE (w/factory amp)	00-05		DODG-462A	CI-1613M	N/R	N/R	USPA-5060
ECLIPSE	06-09		CI-1612*	CI-1613M	N/R	N/R	
EXPO LRV	92-95		CI-1610		N/R	N/R	
ENDEAVOR	04-10		CI-1612	CI-1613M			
GALANT	84-88		CI-1610		N/R	N/R	
GALANT	89-93		CI-1610		N/R	N/R	USPA-5060
GALANT	94-98	UNI-K9108<	CI-1612	CI-1613M	N/R	N/R	USPA-5060
GALANT	99-03		CI-1612	CI-1613M	N/R	N/R	
GALANT	04-10		CI-1612	CI-1613M	N/R	N/R	
LANCER	02-07		CI-1612	CI-1613M	N/R	N/R	
LANCER	08-10		MIT-1644?	MIT-1645M?	N/R	N/R	
MIGHTY MAX P/U	87-96		CI-1610		N/R	N/R	
MIRAGE	85-86				N/R	N/R	
MIRAGE	87-88		CI-1610		N/R	N/R	
MIRAGE	89-94		CI-1610		N/R	N/R	
MIRAGE	95-96		CI-1612	CI-1613M	N/R	N/R	
MIRAGE	97-02	UNI-K8208	CI-1612	CI-1613M	N/R	N/R	
MONTERO	87-96		CI-1610		N/R	N/R	
MONTERO (fullsize)	97-04	UNI-K9108<	CI-1612*	CI-1613M	N/R	N/R	
MONTERO SPORT	97-99	UNI-K9108<	CI-1612	CI-1613M	N/R	N/R	
MONTERO SPORT	00-04		CI-1612	CI-1613M	N/R	N/R	
OUTLANDER	03-06		CI-1612	CI-1613M	N/R	N/R	
OUTLANDER	07-10		MIT-1644				
PICK-UP	83-86				N/R	N/R	
PRECIS	87-89		UI-1990		N/R	N/R	
PRECIS	90-94		UI-1990		N/R	N/R	
RAIDER	06-07		CHR-1638**	CHR-1637M	CHR-A16	CHR-A17	
RAIDER (w/Nav)	06-07	CHR-K0408DD	CHR-1638**	CHR-1637M	CHR-A16	CHR-A17	
RAIDER	08-09	CHR-K0710B	CHR-1642		VW-A16L	VW-A17	
SIGMA	89-91		CI-1610		N/R	N/R	
STARION	83-89		UI-1990		N/R	N/R	
TREDIA	83-88		UI-1990		N/R	N/R	
VANWAGON	87-90		CI-1610		N/R	N/R	

# NISSAN

MAKE/MODEL	YEARS	INSTALLATION KITS	WIRE HARNESS	WIRE HARNESS	ANTENNA ADAPTER	ANTENNA ADAPTER	SPKR ACCESSORIES
		INSTALLER PREFERRED	PLUGS INTO FACTORY HARNESS	PLUGS INTO FACTORY RADIO	AFTER MARKET ANTENNA TO FACTORY ANTENNA	AFTER MARKET ANTENNA TO FACTORY RADIO	GRILLS, BRACKETS & ADAPTERS
200SX	80-83				N/R	N/R	
200SX	84-88		NIS-1700	NIS-1701M	N/R	N/R	USPA-5060
200SX	95-98	NIS-K9504P	NIS-1702	NIS-1703M	NIS-A115	NIS-A17	USPA-5060
210	79-82				N/R	N/R	
240SX	89-91	NIS-K8997P	NIS-1700	NIS-1701M	N/R	N/R	
240SX	92-94	NIS-K8997P	NIS-1700	NIS-1701M	N/R	N/R	
240SX	95-98		NIS-1702	NIS-1703M	NIS-A115	NIS-A17	
240Z	71-73				N/R	N/R	
260Z	74-78				N/R	N/R	
280Z	79-83				N/R	N/R	
300ZX	84-89		NIS-1700	NIS-1701M	N/R	N/R	
300ZX (non Bose system)	90-94		NIS-1700*	NIS-1701M	NIS-A115	NIS-A17	
300ZX (non Bose system)	95-96		NIS-1702*	NIS-1703M	NIS-A115	NIS-A17	
310	79-82				N/R	N/R	
350Z	03-05		NIS-1702*	NIS-1703M	N/R	N/R	USPA-5060
350Z	06-08		NIS-1702*	NIS-1703M	N/R	N/R	USPA-5060
370Z	09-10		NIS-1704		NIS-A106	NIS-A107	USPA-6090

\* This harness works on standard wiring only. Not for amplified JBL or premium sound systems.  
 \*\* Works on standard wiring systems only. Not for vehicles with Bose or On-Star systems.

< Requires factory mounting bracket.  
 << Fits Double Din or two Single ISO mount radios.  
 ^ Requires locating a switched 12v< power source for after-market radios.



# NISSAN cont.

MAKE/MODEL	YEARS	INSTALLATION KITS	WIRE HARNESS	WIRE HARNESS	ANTENNA ADAPTER	ANTENNA ADAPTER	SPKR ACCESSORIES
		INSTALLER PREFERRED	PLUGS INTO FACTORY HARNESS	PLUGS INTO FACTORY RADIO	AFTER MARKET ANTENNA TO FACTORY ANTENNA	AFTER MARKET ANTENNA TO FACTORY RADIO	GRILLS, BRACKETS & ADAPTERS
510	78-81				N/R	N/R	
620 PICKUP	73-79				N/R	N/R	
710	74-77				N/R	N/R	
720 PICKUP	80-86				N/R	N/R	
810	77-80				N/R	N/R	
ALTIMA	93-94	NIS-K8997P	NIS-1700	NIS-1701M	NIS-A115	NIS-A17	USPA-5060
ALTIMA	95-97	NIS-K8997P	NIS-1702	NIS-1703M	NIS-A115	NIS-A17	
ALTIMA	98-01	NIS-K9504P	NIS-1702	NIS-1703M	NIS-A115	NIS-A17	
ALTIMA	02-04		NIS-1702	NIS-1703M	N/R	N/R	
ALTIMA	05-06		NIS-1702	NIS-1703M	N/R	N/R	
ALTIMA (non digital climate controls)	07-10		NIS-1704		NIS-A106	NIS-A107	
ALTIMA COUPE (w/digital climate controls)	07-10		NIS-1704	NIS-1703M	NIS-A106	NIS-A107	
ARMADA	05-07		NIS-1702*	NIS-1703M	N/R	N/R	
ARMADA	08-10		NIS-1704		NIS-A106	NIS-A107	
AXXESS	87-90		NIS-1700	NIS-1701M	N/R	N/R	
B210	74-78				N/R	N/R	
CUBE	10-11	NIS-K0710P<<	NIS-1704		NIS-A106	NIS-A107	
FRONTIER	98-04	NIS-K9504P	NIS-1702	NIS-1703M	N/R	N/R	
FRONTIER	05-08	UNI-K8208<	NIS-1702	NIS-1703M	NIS-A115	NIS-A17	
FRONTIER	09-10		NIS-1704		NIS-A106	NIS-A107	
GT-R	09-10						
HARDBODY TRUCK	86-93		NIS-1700	NIS-1701M	N/R	N/R	
HARDBODY TRUCK	1994		NIS-1700	NIS-1701M	N/R	N/R	
HARDBODY TRUCK	95-97		NIS-1702	NIS-1703M	N/R	N/R	
MAXIMA	81-84				N/R	N/R	
MAXIMA	85-87		NIS-1700	NIS-1701M	NIS-A115	NIS-A17	
MAXIMA	88-94	UNI-K8208	NIS-1700	NIS-1701M	NIS-A115	NIS-A17	
MAXIMA	95-99	NIS-K9504P	NIS-1702	NIS-1703M	NIS-A115	NIS-A17	USPA-5060
MAXIMA (w/o Nav)	00-03		NIS-1702	NIS-1703M	NIS-A115	NIS-A17	
MAXIMA	04-06		NIS-1702	NIS-1703M	NIS-A115	NIS-A17	
MAXIMA	07-08		NIS-1704		NIS-A106	NIS-A107	
MAXIMA	09-10		NIS-1704		NIS-A106	NIS-A107	
MURANO	03-08		NIS-1702	NIS-1703M	N/R	N/R	
MURANO	09-10		NIS-1704		NIS-A106	NIS-A107	
NX	91-93		NIS-1700	NIS-1701M	N/R	N/R	
PATHFINDER	86-93		NIS-1700	NIS-1701M	NIS-A115	NIS-A17	
PATHFINDER	1994		NIS-1700	NIS-1701M	NIS-A115	NIS-A17	
PATHFINDER	95-97		NIS-1702	NIS-1703M	NIS-A115	NIS-A17	USPA-5060
PATHFINDER	98-02	NIS-K9504P	NIS-1702*	NIS-1703M	NIS-A115	NIS-A17	USPA-5060
PATHFINDER ARMADA	2004		NIS-1702*	NIS-1703M	N/R	N/R	
PATHFINDER SE	03-04	NIS-K9504P	NIS-1702	NIS-1703M	NIS-A115	NIS-A17	
PATHFINDER LE (w/o DVD)	03-04		NIS-1702	NIS-1703M	NIS-A115	NIS-A17	
PATHFINDER	05-09	UNI-K8208<	NIS-1702	NIS-1703M	NIS-A115	NIS-A17	
PULSAR	83-86				N/R	N/R	
PULSAR NX	87-91		NIS-1700	NIS-1701M	N/R	N/R	
QUEST	93-95		FD-1594	FD-1593M	N/R	N/R	
QUEST	96-98		FD-1594*	FD-1593M	N/R	N/R	
QUEST	99-02	NIS-K9504P	FD-1598*	FD-1597M	N/R	N/R	
QUEST	04-06		NIS-1702	NIS-1703M	NIS-A115	NIS-A17	
QUEST	07-10		NIS-1702	NIS-1703M	NIS-A115	NIS-A17	
ROGUE	08-10		NIS-1704		NIS-A106	NIS-A107	
SENTRA	82-86		NIS-1700	NIS-1701M	N/R	N/R	
SENTRA	87-90		NIS-1700	NIS-1701M	N/R	N/R	USPA-5060
SENTRA	91-94		NIS-1700	NIS-1701M	N/R	N/R	
SENTRA	95-99	NIS-K9504P	NIS-1702	NIS-1703M	N/R	N/R	
SENTRA	00-06	NIS-K0006	NIS-1702	NIS-1703M	N/R	N/R	
SENTRA	07-10		NIS-1704	NIS-1705M	NIS-A106	NIS-A17	
SKYLINE	08-09						
STANZA	82-86		NIS-1700	NIS-1701M	N/R	N/R	
STANZA	87-89		NIS-1700	NIS-1701M	N/R	N/R	
STANZA	90-92	NIS-K8997P	NIS-1700	NIS-1701M	N/R	N/R	USPA-5060
STANZA WAGON	85-89		NIS-1700	NIS-1701M	N/R	N/R	
TITAN	04-05		NIS-1702*	NIS-1703M	N/R	N/R	
TITAN	06-07		NIS-1702	NIS-1703M	NIS-A115	NIS-A17	
TITAN	08-10		NIS-1704		NIS-A106	NIS-A107	
TITAN (base model only)	08-10		NIS-1704		NIS-A106	NIS-A107	
VERSA 5 DOOR	07-10	NIS-K0710P	NIS-1704	NIS-1705M	NIS-A106	NIS-A107	
VERSA SEDAN	07-10	NIS-K0710P	NIS-1704	NIS-1705M	NIS-A106	NIS-A107	
XTERRA	00-04	NIS-K9504P	NIS-1702	NIS-1703M	N/R	N/R	
XTERRA	05-08	UNI-K8208<	NIS-1702	NIS-1703M	NIS-A115	NIS-A17	
XTERRA	09-10		NIS-1704	NIS-1705M	NIS-A106	NIS-A107	

\* This harness works on standard wiring only.  
Not for amplified, JBL, or premium sound systems.

\*\* Works on standard wiring systems only.  
Not for vehicles with Bose or On-Star systems.

< Requires factory mounting bracket.

<< Fits Double Din or two Single ISO mount radios.

^ Requires locating a switched 12v< power source for after-market radios.

# OPEL

MAKE/MODEL	YEARS	INSTALLATION KITS	WIRE HARNESS	WIRE HARNESS	ANTENNA ADAPTER	ANTENNA ADAPTER	SPKR ACCESSORIES
		INSTALLER PREFERRED	PLUGS INTO FACTORY HARNESS	PLUGS INTO FACTORY RADIO	AFTER MARKET ANTENNA TO FACTORY ANTENNA	AFTER MARKET ANTENNA TO FACTORY RADIO	GRILLS, BRACKETS & ADAPTERS
GT	69-73						
MANTA	75-80						

# PEUGEOT

MAKE/MODEL	YEARS	INSTALLATION KITS	WIRE HARNESS	WIRE HARNESS	ANTENNA ADAPTER	ANTENNA ADAPTER	SPKR ACCESSORIES
		INSTALLER PREFERRED	PLUGS INTO FACTORY HARNESS	PLUGS INTO FACTORY RADIO	AFTER MARKET ANTENNA TO FACTORY ANTENNA	AFTER MARKET ANTENNA TO FACTORY RADIO	GRILLS, BRACKETS & ADAPTERS
405	89-93						
504	75-83						
504	84-93						
505	84-93						
604	84-93						

# PORSCHE

MAKE/MODEL	YEARS	INSTALLATION KITS	WIRE HARNESS	WIRE HARNESS	ANTENNA ADAPTER	ANTENNA ADAPTER	SPKR ACCESSORIES
		INSTALLER PREFERRED	PLUGS INTO FACTORY HARNESS	PLUGS INTO FACTORY RADIO	AFTER MARKET ANTENNA TO FACTORY ANTENNA	AFTER MARKET ANTENNA TO FACTORY RADIO	GRILLS, BRACKETS & ADAPTERS
911	73-95	DIN MOUNT			N/R	N/R	
911 CARRERA	96-03	DIN MOUNT			VW-A16L	VW-A17	
912	73-86	DIN MOUNT			N/R	N/R	
914	73-76	DIN MOUNT			N/R	N/R	
924	77-89	DIN MOUNT			N/R	N/R	
928	78-83	DIN MOUNT			N/R	N/R	
928	84-95	DIN MOUNT			VW-A16L	VW-A17	
944	83-91	DIN MOUNT			N/R	N/R	
968	92-95	DIN MOUNT			VW-A16L	VW-A17	
996	1997	DIN MOUNT			VW-A16L	VW-A17	
BOXSTER	97-03	DIN MOUNT			VW-A16L	VW-A17	
CARRERA	73-76	DIN MOUNT			N/R	N/R	
CAYENNE	03-09				EURO-106	EURO-A107	
CAYMAN	07-09						
TARGA	73-76	DIN MOUNT			N/R	N/R	

# RENAULT

MAKE/MODEL	YEARS	INSTALLATION KITS	WIRE HARNESS	WIRE HARNESS	ANTENNA ADAPTER	ANTENNA ADAPTER	SPKR ACCESSORIES
		INSTALLER PREFERRED	PLUGS INTO FACTORY HARNESS	PLUGS INTO FACTORY RADIO	AFTER MARKET ANTENNA TO FACTORY ANTENNA	AFTER MARKET ANTENNA TO FACTORY RADIO	GRILLS, BRACKETS & ADAPTERS
18i	79-83	DIN MOUNT					
FUEGO	82-85	DIN MOUNT					
LE CAR	76-83	DIN MOUNT					
MEDALLION	1988						
SPORT WAGON	84-86	DIN MOUNT					

\* This harness works on standard wiring only. Not for amplified, JBL, or premium sound systems.  
 \*\* Works on standard wiring systems only. Not for vehicles with Bose or On-Star systems.

< Requires factory mounting bracket.  
 << Fits Double Din or two Single ISO mount radios.  
 ^ Requires locating a switched 12v< power source for after-market radios.

# SAAB

MAKE/MODEL	YEARS	INSTALLATION KITS	WIRE HARNESS	WIRE HARNESS	ANTENNA ADAPTER	ANTENNA ADAPTER	SPKR ACCESSORIES
		INSTALLER PREFERRED	PLUGS INTO FACTORY HARNESS	PLUGS INTO FACTORY RADIO	AFTER MARKET ANTENNA TO FACTORY ANTENNA	AFTER MARKET ANTENNA TO FACTORY RADIO	GRILLS, BRACKETS & ADAPTERS
900	78-94	DIN MOUNT					
9000	86-99	DIN MOUNT					
9-2X	05-06						
9.3	99-07						
9.5	99-07						
9-7X	05-06	GM-K9210P/GM-K9210DD			GM-A16	GM-A17	
9-7X	07-08	GM-K0410DDP/GM-K0410DD<<					

# SCION

MAKE/MODEL	YEARS	INSTALLATION KITS	WIRE HARNESS	WIRE HARNESS	ANTENNA ADAPTER	ANTENNA ADAPTER	SPKR ACCESSORIES
		INSTALLER PREFERRED	PLUGS INTO FACTORY HARNESS	PLUGS INTO FACTORY RADIO	AFTER MARKET ANTENNA TO FACTORY ANTENNA	AFTER MARKET ANTENNA TO FACTORY RADIO	GRILLS, BRACKETS & ADAPTERS
tC	05-10	TOY-K0011B<<	TOY-1950	TOY-1951M		N/R	
xA	04-06	TOY-K0011B<<	TOY-1950	TOY-1951M	N/R	N/R	
xB	04-07	TOY-K0011B<<	TOY-1950	TOY-1951M	N/R	N/R	
xB	08-10	TOY-K0011B<<	TOY-1950	TOY-1951M	N/R	N/R	
xD	08-10	TOY-K0011B<<	TOY-1950	TOY-1951M	N/R	N/R	

# SMART

MAKE/MODEL	YEARS	INSTALLATION KITS	WIRE HARNESS	WIRE HARNESS	ANTENNA ADAPTER	ANTENNA ADAPTER	SPKR ACCESSORIES
		INSTALLER PREFERRED	PLUGS INTO FACTORY HARNESS	PLUGS INTO FACTORY RADIO	AFTER MARKET ANTENNA TO FACTORY ANTENNA	AFTER MARKET ANTENNA TO FACTORY RADIO	GRILLS, BRACKETS & ADAPTERS
FORTWO	08-10		SMA-22100	SMA-22101M	VW-A16L	VW-A17	
FORTWO (includes pocket)	08-10		SMA-22100	SMA-22101M	VW-A16L	VW-A17	

# STERLING

MAKE/MODEL	YEARS	INSTALLATION KITS	WIRE HARNESS	WIRE HARNESS	ANTENNA ADAPTER	ANTENNA ADAPTER	SPKR ACCESSORIES
		INSTALLER PREFERRED	PLUGS INTO FACTORY HARNESS	PLUGS INTO FACTORY RADIO	AFTER MARKET ANTENNA TO FACTORY ANTENNA	AFTER MARKET ANTENNA TO FACTORY RADIO	GRILLS, BRACKETS & ADAPTERS
825	87-91	DIN MOUNT			N/R	N/R	USPA-5060
827	87-92	DIN MOUNT			N/R	N/R	USPA-5060

# SUBARU

MAKE/MODEL	YEARS	INSTALLATION KITS	WIRE HARNESS	WIRE HARNESS	ANTENNA ADAPTER	ANTENNA ADAPTER	SPKR ACCESSORIES
		INSTALLER PREFERRED	PLUGS INTO FACTORY HARNESS	PLUGS INTO FACTORY RADIO	AFTER MARKET ANTENNA TO FACTORY ANTENNA	AFTER MARKET ANTENNA TO FACTORY RADIO	GRILLS, BRACKETS & ADAPTERS
BAJA	03-07	UNI-K9108	SUB-1924		N/R	N/R	
BRAT	80-84				N/R	N/R	
BRAT	85-89		UI-1990		N/R	N/R	
B9 TRIBECA	06-10		SUB-1924				
DL	77-79				N/R	N/R	
DL	80-81				N/R	N/R	

\* This harness works on standard wiring only. Not for amplified, JBL, or premium sound systems.  
 \*\* Works on standard wiring systems only. Not for vehicles with Bose or On-Star systems.

< Requires factory mounting bracket.  
 << Fits Double Din or two Single ISO mount radios.  
 ^ Requires locating a switched 12v< power source for after-market radios.

# SUBARU cont.

MAKE/MODEL	YEARS	INSTALLATION KITS	WIRE HARNESS	WIRE HARNESS	ANTENNA ADAPTER	ANTENNA ADAPTER	SPKR ACCESSORIES
		INSTALLER PREFERRED	PLUGS INTO FACTORY HARNESS	PLUGS INTO FACTORY RADIO	AFTER MARKET ANTENNA TO FACTORY ANTENNA	AFTER MARKET ANTENNA TO FACTORY RADIO	GRILLS, BRACKETS & ADAPTERS
DL	82-89				N/R	N/R	
GF	77-79				N/R	N/R	
GL	80-84				N/R	N/R	
GL	85-89		UI-1990		N/R	N/R	
FORESTER	98-04	UNI-K9108<	SUB-1924		N/R	N/R	
FORESTER	05-08						
FORESTER (w/oFACTORY Nav)	09-10		NIS-1704	NIS-1705M	SUB-A106	SUB-A107	
FORESTER (w/FACTORY Nav)	09-10		SUB-1924	SUB-1925M	SUB-A106	SUB-A107	
IMPREZA	93-07	UNI-K9108<	SUB-1924		N/R	N/R	
IMPREZA (w/FACTORY Nav)	09-10		SUB-1924	SUB-1925M	SUB-A106	SUB-A107	
IMPREZA (w/oFACTORY Nav)	09-10		NIS-1704	NIS-1705M	SUB-A106	SUB-A107	
IMPREZA WRX	02-07	UNI-K9108<	SUB-1924		N/R	N/R	
IMPREZA WRX (w/oFACTORY Nav)	08-10		NIS-1704	NIS-1705M	SUB-A106	SUB-A107	
IMPREZA WRX (w/FACTORY Nav)	08-10		NIS-1702	NIS-1703M			
JUSTY	87-94		UI-1990 (2 req.)		N/R	N/R	
LEGACY	90-94		UI-1990 (2 req.)		N/R	N/R	
LEGACY	95-04	UNI-K9108<	SUB-1924		N/R	N/R	
LEGACY	05-09		SUB-1924		SUB-A106	SUB-A107	
LEGACY	2010		NIS-1704				
LEGACY WAGON	90-94		UI-1990 (2 req.)		N/R	N/R	
LEGACY WAGON	95-96		SUB-1924		N/R	N/R	
LOYALE WAGON	90-94		UI-1990		N/R	N/R	
OUTBACK	95-04	UNI-K9108<	SUB-1924		N/R	N/R	
OUTBACK	05-09		SUB-1924		SUB-A106	SUB-A107	
OUTBACK	2010		NIS-1704				
RX	85-89		UI-1990		N/R	N/R	
SVX	92-97				N/R	N/R	USPA-5060
XT COUPE	85-89		UI-1990		N/R	N/R	

# SUZUKI

MAKE/MODEL	YEARS	INSTALLATION KITS	WIRE HARNESS	WIRE HARNESS	ANTENNA ADAPTER	ANTENNA ADAPTER	SPKR ACCESSORIES
		INSTALLER PREFERRED	PLUGS INTO FACTORY HARNESS	PLUGS INTO FACTORY RADIO	AFTER MARKET ANTENNA TO FACTORY ANTENNA	AFTER MARKET ANTENNA TO FACTORY RADIO	GRILLS, BRACKETS & ADAPTERS
AERIO	02-04	GM-K9210P/GM-K9210DD<<	HON-1806	HON-1807M	N/R	N/R	
AERIO	05-07		HON-1806	HON-1807M	N/R		
EQUATOR	10-Sep		NIS-1702	NIS-1703M			
ESTEEM	95-97	DIN MOUNT	SUZ-1960	SUZ-1961M	N/R	N/R	
ESTEEM	98-02	GM-K9210P/GM-K9210DD<<	SUZ-1960	SUZ-1961M	N/R	N/R	
FORENZA	04-08		DAE-1664	DAE-1663M	N/R	N/R	
GRAND VITARA	99-02	GM-K9210P/GM-K9210DD<<	SUZ-1960	SUZ-1961M	N/R	N/R	
GRAND VITARA	03-05		HON-1806	HON-1807M	N/R	N/R	
GRAND VITARA	06-09		HON-1806	HON-1807M	N/R	N/R	
RENO	05-09		DAE-1664	DAE-1663M	N/R	N/R	
SAMURAI	86-88	DIN MOUNT			N/R	N/R	
SAMURAI	89-94				N/R	N/R	
SAMURAI	1995		SUZ-1960	SUZ-1961M	N/R	N/R	
SIDEKICK	89-91	DIN MOUNT			N/R	N/R	
SIDEKICK	92-95	GM-K9210P/GM-K9210DD<<	ISU-1974	ISU-1975M	N/R	N/R	
SIDEKICK	96-98	GM-K9210P/GM-K9210DD<<	SUZ-1960	SUZ-1961M	N/R	N/R	
SWIFT	89-91	DIN MOUNT	TWH-940		N/R	N/R	
SWIFT	92-94		ISU-1974	ISU-1975M	N/R	N/R	
SWIFT	95-01	GM-K9210P/GM-K9210DD<<	ISU-1974	ISU-1975M	GM-A16	GM-A17	USPA-5060
SX4	07-10		HON-1806	HON-1807M	N/R	N/R	
VITARA	99-04	GM-K9210P/GM-K9210DD<<	GM-1416	GM-1416-1M	GM-A16	GM-A17	USPA-5060
VERONA	04-05		DAE-1664	DAE-1663M	N/R	N/R	
X-90	96-99	DIN MOUNT	SUZ-1960	SUZ-1961M	N/R	N/R	
XL-7	01-02	GM-K9210P/GM-K9210DD<<	SUZ-1960	SUZ-1961M	N/R	N/R	USPA-5060
XL-7	03-06		HON-1806	HON-1807M	N/R	N/R	
XL-7 (w/ Bose)	07-09	GM-K0610DDP / GM-K0610DD<<			CHR-A16	CHR-A17	
XL-7 (w/ Bose)	07-09	GM-K0610DDP / GM-K0610DD<<	GM-1406**	GM-1405M**	CHR-A16	CHR-A17	

\* This harness works on standard wiring only. Not for amplified JBL, or premium sound systems.  
 \*\* Works on standard wiring systems only. Not for vehicles with Bose or On-Star systems.

< Requires factory mounting bracket.  
 << Fits Double Din or two Single ISO mount radios.  
 ^ Requires locating a switched 12v< power source for after-market radios.

# TOYOTA

MAKE/MODEL	YEARS	INSTALLATION KITS	WIRE HARNESS	WIRE HARNESS	ANTENNA ADAPTER	ANTENNA ADAPTER	SPKR ACCESSORIES
		INSTALLER PREFERRED	PLUGS INTO FACTORY HARNESS	PLUGS INTO FACTORY RADIO	AFTER MARKET ANTENNA TO FACTORY ANTENNA	AFTER MARKET ANTENNA TO FACTORY RADIO	GRILLS, BRACKETS & ADAPTERS
4RUNNER	84-86	UNI-K8208~/TOY-K8004P	TWH-940		N/R	N/R	
4RUNNER	87-95	UNI-K8208~/TOY-K8004P	TOY-1950	TOY-1951M	N/R	N/R	
4RUNNER	96-02	UNI-K8208<	TOY-1950	TOY-1951M	N/R	N/R	USPA-5060
4RUNNER SR5	03-09	TOY-K0011B<<<	TOY-1950	TOY-1951M	N/R	N/R	
4RUNNER Limited Edition	03-09		TOY-4940**	TOY-1951M	N/R	N/R	
4RUNNER Sport Edition w/RDS	03-09		TOY-4940**		N/R	N/R	
4RUNNER Base Sport Edition	03-09	TOY-K0011B<<<	TOY-1950	TOY-1951M	N/R	N/R	
4RUNNER	2010						
AVALON	95-99	UNI-K8208<	TOY-1950	TOY-1951M	N/R	N/R	
AVALON	00-04		TOY-1950	TOY-1951M	N/R	N/R	
AVALON	05-10		TOY-4940	TOY-1951M			
CAMRY	83-86	UNI-K8208~/TOY-K8004P	TWH-940		N/R	N/R	
CAMRY	87-91	UNI-K8208~/TOY-K8004P	TOY-1950	TOY-1951M	N/R	N/R	USPA-5060
CAMRY	92-97	UNI-K8208~/TOY-K8004P	TOY-1950	TOY-1951M	N/R	N/R	USPA-5060
CAMRY	98-01	UNI-K8208<	TOY-1950*	TOY-1951M*	N/R	N/R	
CAMRY	02-06		TOY-1950*	TOY-1951M	N/R	N/R	
CAMRY	07-10		TOY-1950*	TOY-1951M	N/R	N/R	
CAMRY w/JBL System	07-10				N/R	N/R	
CAMRY SOLARA	2007	TOY-K0011B<<	TOY-1950	TOY-1951M	N/R	N/R	
CELICA	78-81				N/R	N/R	
CELICA	82-85	UNI-K8208~/TOY-K8004P	TWH-940		N/R	N/R	
CELICA	1986	UNI-K8208~/TOY-K8004P	TWH-940		N/R	N/R	
CELICA	87-89	UNI-K8208~/TOY-K8004P	TOY-1950	TOY-1951M	N/R	N/R	
CELICA	90-93	UNI-K8208~/TOY-K8004P	TOY-1950	TOY-1951M	N/R	N/R	
CELICA	94-99	UNI-K8208~/TOY-K8004P	TOY-1950	TOY-1951M	N/R	N/R	USPA-5060
CELICA	00-05	TOY-K0011B<<<	TOY-1950*	TOY-1951M*	N/R	N/R	
COROLLA	78-80				N/R	N/R	
COROLLA	81-83	TOY-K8004P	TWH-940		N/R	N/R	
COROLLA	84-86	UNI-K8208~/TOY-K8004P	TWH-940		N/R	N/R	
COROLLA	1987	UNI-K8208~/TOY-K8004P	TOY-1950	TOY-1951M	N/R	N/R	
COROLLA	88-92	UNI-K8208~/TOY-K8004P	TOY-1950	TOY-1951M	N/R	N/R	
COROLLA	93-97		TOY-1950	TOY-1951M	N/R	N/R	
COROLLA	98-02		TOY-1950	TOY-1951M	N/R	N/R	
COROLLA	03-08	TOY-K0308P/TOY-K0308DD<<	TOY-1950	TOY-1951M	N/R	N/R	
COROLLA	10-11		TOY-1950	TOY-1951M	N/R	N/R	
COROLLA SR-5	86-87	UNI-K8208~/TOY-K8004P	TOY-1950	TOY-1951M	N/R	N/R	
CRESSIDA	81-84	TOY-K8004P			N/R	N/R	
CRESSIDA	85-86	UNI-K8208~/TOY-K8004P	TWH-940		N/R	N/R	
CRESSIDA	87-88	UNI-K8208~/TOY-K8004P	TOY-1950	TOY-1951M	N/R	N/R	
CRESSIDA	89-92	UNI-K8208~/TOY-K8004P	TOY-1950	TOY-1951M	N/R	N/R	USPA-5060
ECHO	00-05	TOY-K0011B<<<	TOY-1950	TOY-1951M	N/R	N/R	
FJ CRUISER	07-10	TOY-K0011B<<<	TOY-1950*	TOY-1951M*	N/R	N/R	
FJ CRUISER w/JBL System	07-10	TOY-K0011B<<<		TOY-1951M*	N/R	N/R	
HIGHLANDER	01-04	TOY-K0011B<<<	TOY-1950*	TOY-1951M*	N/R	N/R	
HIGHLANDER	08-10		TOY-1950*	TOY-1951M*	N/R	N/R	
LANDCRUISER	73-81				N/R	N/R	
LANDCRUISER	82-86				N/R	N/R	
LANDCRUISER	87-90	UNI-K8208<	TOY-1950	TOY-1951M	N/R	N/R	
LANDCRUISER	91-96	UNI-K8208~/TOY-K8004P	TOY-1950	TOY-1951M	N/R	N/R	
LANDCRUISER	97-02	UNI-K8208<			N/R	N/R	
MATRIX	03-04	GM-K9210P/GM-K9210DD<<	GM-1416	GM-1416-1M	GM-A16	GM-A17	
MATRIX	05-08	TOY-K0011B<<<	TOY-1950	TOY-1951M	N/R	N/R	
MATRIX	09-10		TOY-1950	TOY-1951M	N/R	N/R	
MATRIX w/JBL System	09-10				N/R	N/R	
MR2	85-86	TOY-K8004P			N/R	N/R	
MR2	87-90	UNI-K8208~/TOY-K8004P	TOY-1950	TOY-1951M	N/R	N/R	
MR2	91-95	UNI-K8208~/TOY-K8004P	TOY-1950	TOY-1951M	N/R	N/R	
MR2 SPYDER	00-05	TOY-K0011B<<<	TOY-1950	TOY-1951M			
PASEO	92-95	UNI-K8208~/TOY-K8004P	TOY-1950	TOY-1951M	N/R	N/R	USPA-5060
PASEO	96-97	UNI-K8208~/TOY-K8004P	TOY-1950	TOY-1951M	N/R	N/R	USPA-5060
PRIUS	01-03		TOY-1950	TOY-1951M	N/R	N/R	
PRIUS	04-08		TOY-1950	TOY-1951M			
PRIUS	09-10						
PREVIA	91-97	UNI-K8208~/TOY-K8004P	TOY-1950	TOY-1951M	N/R	N/R	
RAV4	96-00	UNI-K8208<	TOY-1950	TOY-1951M	N/R	N/R	
RAV4	01-04	TOY-K0011B<<<	TOY-1950	TOY-1951M	N/R	N/R	
RAV4	06-10		TOY-1950*	TOY-1951M*	N/R	N/R	
RAV4 w/JBL System	06-10				N/R	N/R	
SEQUOIA	01-02	UNI-K8208<		TOY-1951M	N/R	N/R	
SEQUOIA	03-07		TOY-1950*	TOY-1951M*	N/R	N/R	

\* This harness works on standard wiring only.  
Not for amplified, JBL, or premium sound systems.

\*\* Works on standard wiring systems only.  
Not for vehicles with Bose or On-Star systems.

< Requires factory mounting bracket.

<< Fits Double Din or two Single ISO mount radios.

^ Requires locating a switched 12v< power source for after-market radios.

# TOYOTA cont.

MAKE/MODEL	YEARS	INSTALLATION KITS	WIRE HARNESS	WIRE HARNESS	ANTENNA ADAPTER	ANTENNA ADAPTER	SPKR ACCESSORIES
		INSTALLER PREFERRED	PLUGS INTO FACTORY HARNESS	PLUGS INTO FACTORY RADIO	AFTER MARKET ANTENNA TO ANTENNA	AFTER MARKET ANTENNA TO FACTORY RADIO	GRILLS, BRACKETS & ADAPTERS
SEQUOIA	08-10		TOY-1950*		N/R	N/R	
SEQUOIA w/JBL System	08-10				N/R	N/R	
SIENNA VAN	98-03	UNI-K8208~/TOY-K8004P	TOY-1950*	TOY-1951M*	N/R	N/R	
SIENNA VAN	04-10		TOY-1950*	TOY-1951M*	N/R	N/R	
SIENNA VAN w/JBL System	04-10				N/R	N/R	
SOLARA	98-03	UNI-K8208<	TOY-1950*	TOY-1951M*	N/R	N/R	
SOLARA	04-10		TOY-1950*	TOY-1951M*	N/R	N/R	
SOLARA w/JBL System	04-10				N/R	N/R	
STARLET	81-85				N/R	N/R	
SUPRA	82-85	UNI-K8208~/TOY-K8004P			N/R	N/R	
SUPRA	86-93	UNI-K8208~/TOY-K8004P	TOY-1950	TOY-1951M	N/R	N/R	
SUPRA	94-97	UNI-K8208<	TOY-1950	TOY-1951M	N/R	N/R	USPA-5060
SUPRA	1998	UNI-K8208<	TOY-1950	TOY-1951M	N/R	N/R	
T-100 PICKUP	93-94	UNI-K8208<	TOY-1950	TOY-1951M	N/R	N/R	USPA-5060
T-100 PICKUP	95-98	UNI-K8208<	TOY-1950	TOY-1951M	N/R	N/R	USPA-5060
TACOMA	95-04	UNI-K8208~/TOY-K8004P	TOY-1950*	TOY-1951M*	N/R	N/R	
TACOMA (Silver)	05-10		TOY-1950*	TOY-1951M*	N/R	N/R	
TACOMA (Black)	05-10		TOY-1950*	TOY-1951M*	N/R	N/R	
TACOMA (w/JBL System)	05-10				N/R	N/R	
TERCEL COUPE	81-87	UNI-K8208~/TOY-K8004P			N/R	N/R	
TERCEL WAGON	88-90	UNI-K8208~/TOY-K8004P	TOY-1950	TOY-1951M	N/R	N/R	
TERCEL	91-94	UNI-K8208~/TOY-K8004P	TOY-1950	TOY-1951M	N/R	N/R	
TERCEL	95-98	UNI-K8208~/TOY-K8004P	TOY-1950	TOY-1951M	N/R	N/R	
TRUCK SR5	79-83				N/R	N/R	
TRUCK	84-86	TOY-K8004P			N/R	N/R	
TRUCK	87-88	TOY-K8004P	TOY-1950	TOY-1951M	N/R	N/R	
TRUCK	89-94	UNI-K8208<	TOY-1950	TOY-1951M	N/R	N/R	
TUNDRA	00-02	UNI-K8208<	TOY-1950*	TOY-1951M*	N/R	N/R	
TUNDRA	03-06		TOY-1950*	TOY-1951M*	N/R	N/R	
TUNDRA	07-10		TOY-1950*	TOY-1951M	N/R	N/R	
TUNDRA (w/JBL System)	07-10				N/R	N/R	
VAN	84-86	UNI-K8208~/TOY-K8004P			N/R	N/R	
VAN	87-90	UNI-K8208~/TOY-K8004P	TOY-1950	TOY-1951M	N/R	N/R	
VENZA	09-10		TOY-1950	TOY-1951M	N/R	N/R	
VENZA (w/JBL System)	09-10				N/R	N/R	
YARIS LIFTBACK	07-10	TOY-K0011B<<<	TOY-1950	TOY-1951M	N/R	N/R	
YARIS SEDAN (w/o 3" radio display)	07-09	TOY-K0011B<<<	TOY-1950	TOY-1951M	N/R	N/R	

# VOLKSWAGEN

MAKE/MODEL	YEARS	INSTALLATION KITS	WIRE HARNESS	WIRE HARNESS	ANTENNA ADAPTER	ANTENNA ADAPTER	SPKR ACCESSORIES
		INSTALLER PREFERRED	PLUGS INTO FACTORY HARNESS	PLUGS INTO FACTORY RADIO	AFTER MARKET ANTENNA TO ANTENNA	AFTER MARKET ANTENNA TO FACTORY RADIO	GRILLS, BRACKETS & ADAPTERS
BEETLE	65-79				N/R	N/R	
BEETLE (non-Aktiv)	98-04	VW-K9810	VW-11000	VW-12000M	VW-A18	VW-A17	
BEETLE (Aktiv system)	98-07	VW-K9810	VW-11004		VW-A18	VW-A17	
BEETLE	03-10	VW-K9810	VW-11004		VW-A18	VW-A17	
CABRIOLET	86-93	DIN MOUNT			N/R	N/R	
CABRIO	95-01	DIN MOUNT	VW-11000	VW-12000M	VW-A16L	VW-A17	
CABRIO	2002	UNI-K9108	EURO-11010	EURO-11009M	EURO-A106	EURO-A107	
CC	09-10	VW-K0510DDP	EURO-11010	EURO-11009M			
CORRADO	90-94	DIN MOUNT	VW-11004		VW-A16L	VW-A17	
DASHER	74-75				N/R	N/R	
DASHER	76-81	DIN MOUNT			N/R	N/R	
EOS	07-10	VW-K0510DDP<<	EURO-11010	EURO-11009M	EURO-A106	EURO-A107	
EUROVAN	93-03	DIN MOUNT	VW-11000	VW-12000M	VW-A16L	VW-A17	
FOX	87-93	DIN MOUNT	VW-11000	VW-12000M	N/R	N/R	
GOLF	85-92	DIN MOUNT	VW-11004		VW-A16L	VW-A17	
GOLF	93-98	DIN MOUNT	VW-11000	VW-12000M	VW-A16L/VW-A18	VW-A17	
GOLF (single DIN radio)	99-02	DIN MOUNT	VW-11000	VW-12000M	VW-A18	VW-A17	
GOLF (double DIN radio)	2002	UNI-K9108	EURO-11010	EURO-11009M	EURO-A106	EURO-A107	
GOLF	03-07	UNI-K9108	EURO-11010	EURO-11009M	EURO-A106	EURO-A107	
GOLF	08-10	VW-K0510DDP	EURO-11010	EURO-11009M			

\* This harness works on standard wiring only. Not for amplified JBL, or premium sound systems.

\*\* Works on standard wiring systems only. Not for vehicles with Bose or On-Star systems.

< Requires factory mounting bracket.

<< Fits Double Din or two Single ISO mount radios.

^ Requires locating a switched 12v< power source for after-market radios.

# VOLKSWAGEN cont.

MAKE/MODEL	YEARS	INSTALLATION KITS	WIRE HARNESS	WIRE HARNESS	ANTENNA ADAPTER	ANTENNA ADAPTER	SPKR ACCESSORIES
		INSTALLER PREFERRED	PLUGS INTO FACTORY HARNESS	PLUGS INTO FACTORY RADIO	AFTER MARKET ANTENNA TO FACTORY ANTENNA	AFTER MARKET ANTENNA TO FACTORY RADIO	GRILLS, BRACKETS & ADAPTERS
GTI	85-92	DIN MOUNT	VW-11004		VW-A16L	VW-A17	
GTI	93-98	DIN MOUNT	VW-11000	VW-12000M	VW-A16L/VW-A18	VW-A17	
GTI (single DIN radio)	99-02	UNI-K9108	VW-11000	VW-12000M	VW-A18	VW-A17	
GTI (double DIN radio)	03-05	UNI-K9108	EURO-11010	EURO-11009M	EURO-A106	EURO-A107	
GTI	06-10	VW-K0510DDP<<	EURO-11010	EURO-11009M	EURO-A106	EURO-A107	
JETTA	80-84	DIN MOUNT			N/R	N/R	
JETTA	85-92	DIN MOUNT	VW-11000	VW-12000M	VW-A16L	VW-A17	
JETTA	94-98	DIN MOUNT	VW-11000	VW-12000M	VW-A16L	VW-A17	
JETTA (single DIN radio)	99-02	UNI-K9108	VW-11004		VW-A18	VW-A17	
JETTA (double DIN radio)	2002	UNI-K9108	EURO-11010	EURO-11009M	EURO-A106	EURO-A107	
JETTA	03-05	UNI-K9108	EURO-11010	EURO-11009M	EURO-A106	EURO-A107	
JETTA A5	05-08	VW-K0510DDP<<	EURO-11010	EURO-11009M	EURO-A106	EURO-A107	
JETTA TDI	05-09	VW-K0510DDP<<	EURO-11010	EURO-11009M	EURO-A106	EURO-A107	
PASSAT	90-97	DIN MOUNT	VW-11004		VW-A16L	VW-A17	
PASSAT (single DIN radio)	98-02	DIN MOUNT	VW-11004		VW-A16L/VW-A18	VW-A17	
PASSAT (double DIN radio)	2002	UNI-K9108	EURO-11010	EURO-11009M	EURO-A106	EURO-A107	
PASSAT	03-05	UNI-K9108	EURO-11010	EURO-11009M	EURO-A106	EURO-A107	
PASSAT	06-09	VW-K0510DDP<<	EURO-11010	EURO-11009M	EURO-A106	EURO-A107	
PHAETON	04-08						
PICKUP	80-88	DIN MOUNT			N/R	N/R	
QUANTUM	82-85	DIN MOUNT			N/R	N/R	
QUANTUM	86-88	DIN MOUNT		VW-12000M	N/R	N/R	
RABBIT	75-79	DIN MOUNT			N/R	N/R	
RABBIT	80-84		EURO-11010	EURO-11009M	N/R	N/R	
RABBIT	06-09	VW-K0510DDP<<			EURO-A106	EURO-A107	
RABBIT CONVERTIBLE	80-91	DIN MOUNT			N/R	N/R	
ROUTAN	09-10	CHR-K0710B	CHR-1642		EURO-A106	EURO-A107	
SCIROCCO	75-86	DIN MOUNT	VW-11000		N/R	N/R	
SCIROCCO	87-89	DIN MOUNT		VW-12000M	N/R	N/R	
SUPERBEETLE	73-79				N/R	N/R	
THING	80-82				N/R	N/R	
TIGUAN	09-10	VW-K0510DDP	EURO-11010	EURO-11009M	EURO-A108	EURO-A107	
TOUAREG	04-07		EURO-11010	EURO-11009M	EURO-A106	EURO-A107	
TOUAREG 2	08-10		EURO-11010	EURO-11009M	EURO-A108	EURO-A107	
VANBUS	65-79	DIN MOUNT			N/R	N/R	
VANAGON	80-92	DIN MOUNT			N/R	N/R	

# VOLVO

MAKE/MODEL	YEARS	INSTALLATION KITS	WIRE HARNESS	WIRE HARNESS	ANTENNA ADAPTER	ANTENNA ADAPTER	SPKR ACCESSORIES
		INSTALLER PREFERRED	PLUGS INTO FACTORY HARNESS	PLUGS INTO FACTORY RADIO	AFTER MARKET ANTENNA TO FACTORY ANTENNA	AFTER MARKET ANTENNA TO FACTORY RADIO	GRILLS, BRACKETS & ADAPTERS
142	73-75				N/R	N/R	
164	73-75				N/R	N/R	
200 SERIES (lower dash)	73-93				N/R	N/R	
200 SERIES (lower dash)	75-93				N/R	N/R	
740	83-92				N/R	N/R	
760	85-92				N/R	N/R	
780	89-96	UNI-K8208			N/R	N/R	
850	93-98	UNI-K8208			N/R	N/R	
940	92-95	UNI-K8208			N/R	N/R	
960	92-97	UNI-K8208			N/R	N/R	
C30	08-09						
C70	98-99	UNI-K8208	VO-11054		N/R	N/R	
C70	00-03	UNI-K8208	VO-11054		N/R	N/R	
C70	06-09						
S40	00-03	UNI-K8208	VO-11054		VOL-A106	VOL-A107	
S40	04-09						
S60	98-00						
S60	01-04		VO-11058	VO-11059M	VOL-A106	VOL-A107	
S60	05-07						
S70	95-02	UNI-K8208	VO-11054				
S80	99-06		VO-11058	VO-11059M	VOL-A106	VOL-A107	
S90	97-98				N/R	N/R	

\* This harness works on standard wiring only.  
Not for amplified, JBL, or premium sound systems.

\*\* Works on standard wiring systems only.  
Not for vehicles with Bose or On-Star systems.

< Requires factory mounting bracket.

<< Fits Double Din or two Single ISO mount radios.

^ Requires locating a switched 12v< power source for after-market radios.

# VOLVO

MAKE/MODEL	YEARS	INSTALLATION KITS	WIRE HARNESS	WIRE HARNESS	ANTENNA ADAPTER	ANTENNA ADAPTER	SPKR ACCESSORIES
		INSTALLER PREFERRED	PLUGS INTO FACTORY HARNESS	PLUGS INTO FACTORY RADIO	AFTER MARKET ANTENNA TO FACTORY ANTENNA	AFTER MARKET ANTENNA TO FACTORY RADIO	GRILLS, BRACKETS & ADAPTERS
V40	00-03	UNI-K8208		VO-11054	VOL-A106	VOL-A107	
V50	05-10						
V70	98-00	UNI-K8208		VO-11054	N/R	N/R	
V70	01-04			VO-11054	VOL-A106	VOL-A107	
V70	05-08				VOL-A106	VOL-A107	
V90	97-98				N/R	N/R	
XC60	09-10						
XC70 Cross Country	01-04			VO-11058	VO-11059M	VOL-A106	VOL-A107
XC70	05-07						
XC90	03-09						

# YUGO

MAKE/MODEL	YEARS	INSTALLATION KITS	WIRE HARNESS	WIRE HARNESS	ANTENNA ADAPTER	ANTENNA ADAPTER	SPKR ACCESSORIES
		INSTALLER PREFERRED	PLUGS INTO FACTORY HARNESS	PLUGS INTO FACTORY RADIO	AFTER MARKET ANTENNA TO FACTORY ANTENNA	AFTER MARKET ANTENNA TO FACTORY RADIO	GRILLS, BRACKETS & ADAPTERS
GV CABRIO							

# APPLICATION GUIDE

\* This harness works on standard wiring only. Not for amplified, JBL, or premium sound systems.  
 \*\* Works on standard wiring systems only. Not for vehicles with Bose or On-Star systems.

< Requires factory mounting bracket.  
 << Fits Double Din or two Single ISO mount radios.  
 ^ Requires locating a switched 12v< power source for after-market radios.



# PRODUCT LOCATOR & VEHICLE APPLICATION REFERENCE

## BMW-K9706P

(See Pg 106)

### BMW

2001-03 525  
1997-00 528  
2001-03 530  
1997-03 540  
2002-03 M5  
2002-06 X5 (Non NAV Only)

## CF-K7401

(See Pg 106)

### CHRYSLER

1995-00 CIRRUS  
1993-97 CONCORDE  
1975-83 CORDOBA  
1984-90 E CLASS  
1994-97 LHS  
1979-94 IMPERIAL  
1984-86 LASER  
1977-81 LE BARON  
1987-95 LE BARON SEDAN  
1985-89 LE BARON GTS  
1982-95 LEBARON COUPE/CONV.  
1975-83 NEWPORT  
1975-97 NEW YORKER  
1995-00 SEBRING  
1996-00 SEBRING CONV.  
1990-00 TOWN & COUNTRY

### DODGE

1981-82 024  
1982-83 400K  
1983-87 600K  
1981-89 ARIES  
1976-80 ASPEN  
1995-00 AVENGER  
1984-00 CARAVAN  
1975-91 CHARGER  
1987-00 DAKOTA TRUCK  
1984-94 DAYTONA  
1977-89 DIPLOMAT  
1998-00 DURANGO  
1988-93 DYNASTY  
1993-97 INTREPID  
1984-89 LANCER  
1978-79 MAGNUM XE  
1980-83 MIRADA  
1974-78 MONACO  
1995-99 NEON  
1978-90 OMNI  
1974-01 RAM P/U  
1974-93 RAMCHARGER  
1982-87 RAMPAGE  
1987-94 SHADOW  
1989-95 SPIRIT  
1979-81 ST. REGIS  
1995-00 STRATUS  
1978-00 VAN  
1993-00 VIPER

### EAGLE

1993-97 VISION

### FORD

1985-91 AEROSTAR  
1979-89 CROWN VICTORIA  
1987-91 ECONOLINE VAN  
1979-89 LTD  
1983-88 RANGER/BRONCO II

1980-88 THUNDERBIRD

### JEEP

1997-01 CHEROKEE  
1993-98 GRAND CHEROKEE  
1997-02 WRANGLER

### LINCOLN

1983-87 CONTINENTAL  
1985-89 TOWN CAR

### MERCURY

1980-82 COUGAR  
1979-89 GRAND MARQUIS

### PLYMOUTH

1989-95 ACCLAIM  
1996-00 BREEZE  
1985-88 CARAVELLE SE  
1975-78 FURY  
1975-89 GRAND FURY  
1978-90 HORIZON  
1995-99 NEON  
1981-89 RELIANT  
1983-84 SCAMP  
1987-94 SUNDANCE  
1982 TC3  
1983-87 TOURISMO, DUSTER  
1974-81 TRAILDUSTER  
1981-92 VAN  
1976-80 VOLARE  
1984-00 VOYAGER  
1992-00 PROWLER

## CHR-K0408DD

(See Pg 106)

### CHRYSLER

2007 ASPEN  
2005-07 300  
DODGE  
2006-08 CALIBER  
2006-07 CHARGER  
2005-07 DAKOTA  
2004-07 DURANGO  
2004-07 MAGNUM  
2006-08 RAM P/U  
2005-07 300

### JEEP

2006-07 COMMANDER  
2007-08 COMPASS  
2006-07 GRAND CHEROKEE  
2007-08 PATRIOT

## CHR-K0410P

(See Pg 107)

### CHRYSLER

2007 ASPEN  
2006-10 PT CRUISER  
2005-07 300

### DODGE

2006-08 CALIBER  
2006-07 CHARGER  
2005-07 DAKOTA  
2004-07 DURANGO  
2004-07 MAGNUM  
2006-08 RAM P/U

### JEEP

2006-07 COMMANDER  
2007-08 COMPASS  
2006-07 GRAND CHEROKEE  
2007-08 PATRIOT

## CHR-K0710B

(See Pg 107)

### CHRYSLER

2008-09 ASPEN  
2008-10 300  
2007-10 SEBRING  
2008-10 TOWN & COUNTRY

### DODGE

2007-10 AVENGER  
2009-10 CALIBER  
2008-09 CARAVAN  
2009-10 CHALLENGER  
2008-10 CHARGER  
2008-10 DAKOTA  
2008-09 DURANGO  
2008-10 GRAND CARAVAN  
2009-10 JOURNEY  
2008-09 MAGNUM  
2007-10 NITRO  
2009-10 RAM P/U

### JEEP

2008-10 COMMANDER  
2009-10 COMPASS  
2008-10 GRAND CHEROKEE  
2008-10 LIBERTY  
2009-10 PATRIOT  
2007-10 WRANGLER  
2007-10 WRANGLER UNLIMITED

### VOLKSWAGEN

2009-10 ROUTAN

## CHR-K7401

(See Pg 107)

### CHRYSLER

1995-00 CIRRUS  
1993-97 CONCORDE  
1975-83 CORDOBA  
1984-90 E CLASS  
1994-97 LHS  
1979-94 IMPERIAL  
1984-86 LASER  
1977-81 LE BARON  
1987-95 LE BARON SEDAN  
1985-89 LE BARON GTS  
1982-95 LEBARON COUPE, CONV.  
1975-83 NEWPORT  
1975-97 NEW YORKER  
1995-00 SEBRING  
1996-00 SEBRING CONV.  
1990-00 TOWN & COUNTRY

### DODGE

1981-82 024  
1982-83 400  
1983-87 600  
1981-89 ARIES  
1976-80 ASPEN  
1984-00 CARAVAN  
1975-91 CHARGER  
1987-00 DAKOTA TRUCK  
1984-94 DAYTONA  
1977-89 DIPLOMAT  
1998-00 DURANGO  
1988-93 DYNASTY  
1993-97 INTREPID  
1984-89 LANCER  
1978-79 MAGNUM XE  
1980-83 MIRADA

# PRODUCT LOCATOR & VEHICLE APPLICATION REFERENCE

1974-78 MONACO  
 1995-99 NEON  
 1978-90 OMNI  
 1974-01 RAM P/U  
 1974-93 RAM CHARGER  
 1982-87 RAMPAGE  
 1987-94 SHADOW  
 1989-95 SPIRIT  
 1979-81 ST. REGIS  
 1995-00 STRATUS  
 1978-00 VAN  
 1993-00 VIPER

## EAGLE

1993-97 VISION

## JEEP

1997-01 CHEROKEE  
 1996-98 GRAND CHEROKEE  
 1997-02 WRANGLER

## PLYMOUTH

1989-95 ACCLAIM  
 1996-00 BREEZE  
 1985-88 CARAVELLE SE  
 1975-78 FURY  
 1975-89 GRAND FURY  
 1978-90 HORIZON  
 1995-99 NEON  
 1992-00 PROWLER  
 1981-89 RELIANT  
 1983-84 SCAMP  
 1987-94 SUNDANCE  
 1982 TC3  
 1983-87 TOURISMO, DUSTER  
 1974-81 TRAILDUSTER  
 1981-92 VAN  
 1976-80 VOLARE  
 1984-00 VOYAGER

## CHR-K9807

(See Pg 108)

## CHRYSLER

1998-04 CONCORD  
 2001-05 PT CRUISER  
 1998-01 LHS  
 1999-04 300M  
 2001-06 SEBRING  
 2001-07 TOWN & COUNTRY  
 2001-03 VOYAGER

## DODGE

2001-07 CARAVAN  
 2001-04 DAKOTA P/U  
 2001-03 DURANGO  
 1998-04 INTREPID  
 2000-05 NEON  
 2002-05 RAM P/U  
 2001-04 STRATUS

## JEEP

1999-04 GRAND CHEROKEE  
 2002-07 LIBERTY  
 2003-06 WRANGLER

## FM-K0106DD

(See Pg 108)

## FORD

2003-06 EXPEDITION  
 2002-05 EXPLORER  
 2001-04 MUSTANG

## LINCOLN

2003-06 AVIATOR  
 2003-06 NAVIGATOR  
 MERCURY  
 2003-05 MOUNTAINEER

## FM-K0411DD

(See Pg 108)

## FORD

2005-07 500  
 2009-10 ECONOLINE VAN  
 2007-10 EXPEDITION  
 2004-08 F-150 (Excludes Heritage)  
 2009-10 F-150 (Base Model)  
 2007-10 EDGE  
 2006-10 EXPLORER  
 2007-10 EXPLORER Sport Trac  
 2005-06 FOCUS  
 2006-09 FUSION  
 2004-07 FREESTAR  
 2005-07 FREESTYLE  
 2005-09 MUSTANG  
 2008-09 TAURUS  
 2005-11 SUPERDUTY P/U's

## LINCOLN

2006-08 MARK LT  
 2007-10 MKX (w/factory NAV)  
 2007-10 NAVIGATOR  
 2006-08 ZEPHYR

## MERCURY

2004-09 MILAN  
 2004-07 MONTEREY  
 2005-07 MONTEGO  
 2006-10 MOUNTAINEER

## FM-K0411P

(See Pg 109)

## FORD

2005-07 500  
 2009-10 ECONOLINE VAN  
 2007-10 EXPEDITION  
 2004-08 F-150 (Excludes Heritage)  
 2009-10 F-150 (Base Model)  
 2007-10 EDGE  
 2008-10 ESCAPE (w/factory NAV)  
 2006-10 EXPLORER  
 2007-10 EXPLORER Sport Trac  
 2005-07 FOCUS  
 2006-09 FUSION  
 2004-07 FREESTAR  
 2005-06 FREESTYLE  
 2005-09 MUSTANG  
 2008-09 TAURUS  
 2005-11 SUPERDUTY P/U

## LINCOLN

2007-08 MARK LT  
 2007-08 ZEPHYR  
 2007-10 NAVIGATOR  
 2007-10 MKX (w/factory NAV)

## MAZDA

2008-10 TRIBUTE (w/factory NAV)

## MERCURY

2008-10 MARINER (w/factory NAV)  
 2004-09 MILAN  
 2004-07 MONTEREY  
 2005-07 MONTEGO  
 2006-10 MOUNTAINEER

## FM- K9510DD

(See Pg 109)

## FORD

1997-08 ECONOLINE VAN (Club Wagon)  
 2001-07 ESCAPE  
 2000-06 EXCURSION  
 1995-01 EXPLORER (All Models)  
 1999-03 F-SERIES TRUCKS (All Models)  
 2004 F-150 (Heritage/Superduty)  
 1995-10 RANGER  
 1999-03 WINDSTAR

## MAZDA

1995-10 B-SERIES P/U

## MERCURY

2001-02 COUGAR  
 2005-07 MARINER  
 1997-01 MOUNTAINEER

## FM-K9510P

(See Pg 109)

## FORD

1995-08 CROWN VICTORIA  
 1997-08 ECONOLINE VAN (Club Wagon)  
 2001-07 ESCAPE  
 2000-06 EXCURSION  
 1997-06 EXPEDITION  
 1995-05 EXPLORER (All Models)  
 2004 F150 (Heritage/Superduty)  
 1999-03 F-SERIES TRUCKS  
 2001-04 MUSTANG  
 1995-10 RANGER  
 1999-03 WINDSTAR

## LINCOLN

2003-06 AVIATOR  
 1995-97 CONTINENTAL  
 1996-98 MARK VIII  
 1999-06 NAVIGATOR  
 1998-02 TOWNCAR

## MAZDA

1995-10 B-SERIES P/U

## MERCURY

1995-09 GRAND MARQUIS  
 2003-04 MARAUDER  
 2005-07 MARINER  
 1997-05 MOUNTAINEER  
 2001-02 COUGAR

## GM-K0410DD

(See Pg 110)

## CHEVROLET

2005-10 COBALT  
 2005-06 EQUINOX  
 2006-10 HHR  
 2004-10 MALIBU  
 2004-07 MALIBU MAXX

## PONTIAC

2007-09 G5  
 2005-09 G6  
 2006-10 SOLSTICE  
 2006 TORRENT

## SATURN

2007-09 AURA  
 2006-08 ION  
 2007-09 SKY  
 2006-07 VUE

# PRODUCT LOCATOR & VEHICLE APPLICATION REFERENCE

## GM-K0410DDP

(See Pg 110)

### CHEVROLET

2005-10 COBALT  
2005-06 EQUINOX  
2006-10 HHR  
2004-10 MALIBU  
2004-07 MALIBU MAXX

### PONTIAC

2007-09 G5  
2005-09 G6  
2006-10 SOLSTICE  
2006 TORRENT

### SATURN

2007-09 AURA  
2006-08 ION  
2007-09 SKY  
2006-07 VUE

## GM-K0410P

(See Pg 110)

### CHEVROLET

2005-10 COBALT  
2005-06 EQUINOX  
2006-10 HHR  
2004-10 MALIBU  
2004-07 MALIBU MAXX

### PONTIAC

2007-09 G5  
2005-09 G6  
2006-10 SOLSTICE  
2006 TORRENT

### SATURN

2007-09 AURA  
2006-08 ION  
2007-09 SKY  
2006-07 VUE

## GM-K0610DD

(See Pg 111)

### BUICK

2006-10 LUCERNE  
2007-10 ENCLAVE

### CHEVROLET

2007-10 AVALANCHE  
2007-09 EQUINOX  
2008-10 EXPRESS VAN  
2006-10 IMPALA  
2006-07 MONTE CARLO  
2007-10 SILVERADO (New Bodystyle)  
2007-10 SUBURBAN  
2007-10 TAHOE

### GMC

2007-10 ACADIA  
2008-10 SAVANNAH VAN  
2007-10 SIERRA (New Bodystyle)  
2007-10 YUKON

### PONTIAC

2007-09 TORRENT

### SATURN

2007-09 OUTLOOK  
2008-09 VUE

### SUZUKI

2007-09 XL-7

## GM-K0610DDP

(See Pg 111)

### BUICK

2006-10 LUCERNE  
2007-10 ENCLAVE

### CHEVROLET

2007-10 AVALANCHE  
2007-09 EQUINOX  
2008-10 EXPRESS VAN  
2006-10 IMPALA  
2006-07 MONTE CARLO  
2007-10 SILVERADO (New Bodystyle)  
2007-10 SUBURBAN  
2007-10 TAHOE

### GMC

2007-10 ACADIA  
2008-10 SAVANNAH VAN  
2007-10 SIERRA (New Bodystyle)  
2007-10 YUKON

### PONTIAC

2007-09 TORRENT

### SATURN

2007-09 OUTLOOK  
2008-09 VUE

### SUZUKI

2007-09 XL-7

## GM-K8204

(See Pg 111)

### BUICK

1982-96 CENTURY  
1974-90 ELECTRA  
1980-94 LE SABRE  
1985-94 PARK AVENUE  
1990-91 REATTA  
1978-87 REGAL  
1984-85 RIVIERA  
1992-95 RIVIERA  
1991-94 ROADMASTER  
1982-89 SKYHAWK  
1983-95 SKYLARK

### CADILLAC

1982-88 CIMARRON  
1990-93 DEVILLE/COUPE  
1984-91 EL DORADO  
1985-93 FLEETWOOD  
1984-91 SEVILLE

### CHEVROLET

1985-95 ASTRO VAN  
1991-96 BERETTA/CORSICA  
1982-92 CAMARO/Z-28  
1997-02 CAMARO  
1991-96 CAPRICE  
1982-99 CAVALIER  
1982-90 CELEBRITY  
1985 CITATION II  
1984-89 CORVETTE  
1997-04 CORVETTE  
1978-88 EL CAMINO/CABALLERO  
1994-96 IMPALA  
1990-01 LUMINA  
1990-96 LUMINA VAN  
1997-00 MALIBU  
1986-89 MONTE CARLO  
1985-88 NOVA  
1989-91 BLAZER (FULL SIZE)  
1982-93 S-10 BLAZER  
1998-01 BLAZER  
2002 BLAZER

### CHEVROLET

1985-95 ASTRO VAN  
1991-96 BERETTA/CORSICA  
1982-92 CAMARO/Z-28  
1997-02 CAMARO  
1991-96 CAPRICE  
1982-99 CAVALIER  
1982-90 CELEBRITY  
1985 CITATION II  
1984-89 CORVETTE  
1997-04 CORVETTE  
1978-88 EL CAMINO/CABALLERO  
1994-96 IMPALA  
1990-01 LUMINA  
1990-96 LUMINA VAN  
1997-00 MALIBU  
1986-89 MONTE CARLO  
1985-88 NOVA  
1989-91 BLAZER (FULL SIZE)  
1982-93 S-10 BLAZER  
1998-01 BLAZER  
2002 BLAZER

(Standard Radio Opening)

1982-93 S-10 TRUCK  
1998-01 S-10 TRUCK  
2002 S-10 TRUCK

(Standard Radio Opening)

1988-91 SUBURBAN  
1988-95 VAN (FULL SIZE)  
1997-99 VENTURE VAN

### GMC

1985-95 SAFARI VAN  
1982-94 JIMMY  
1998-01 JIMMY (ENVOY)  
1982-93 S-15/S-10 TRUCK  
1998-01 SONOMA PICK UP  
2002 SONOMA (Standard Radio Opening)

### OLDSMOBILE

1992-95 ACHIEVA  
1991-94 BRAVADA  
1982-91 CALAIS  
1982-96 CIERA  
1984-94 CUTLASS/SUPREME  
1986-91 DELTA 88  
1982-88 FIRENZA  
1989-93 NINETY-EIGHT  
1983-84 OMEGA  
1990-99 SILHOUETTE  
1982-89 TORONADO

### PONTIAC

1982-91 A 6000  
1987-99 BONNEVILLE  
1984-88 FIERO  
1982-92 FIREBIRD  
1998-02 FIREBIRD  
1985-00 GRAND AM  
1990-03 GRAND PRIX  
1982-84 J 2000  
1999 MONTANA  
1985-86 PARISIENNE  
1982-88 SUNBIRD  
1995-99 SUNFIRE  
1990-99 TRANS SPORT VAN

### SATURN

1991-94 SC COUPE, WAGON  
1991-94 SL, SL1, SL2, SEDAN

## GM-K8204-1E

(See Pg 112)

### BUICK

1982-96 CENTURY  
1974-90 ELECTRA  
1980-94 LE SABRE  
1985-94 PARK AVENUE  
1990-91 REATTA  
1978-87 REGAL  
1984-85 RIVIERA  
1992-95 RIVIERA  
1991-94 ROADMASTER  
1982-89 SKYHAWK  
1983-95 SKYLARK

### CADILLAC

1982-88 CIMARRON  
1990-93 DEVILLE/COUPE  
1984-91 EL DORADO  
1985-93 FLEETWOOD  
1984-91 SEVILLE

### CHEVROLET

# PRODUCT LOCATOR & VEHICLE APPLICATION REFERENCE

1985-95 ASTRO VAN  
1991-96 BERETTA/CORSICA  
1982-92 CAMARO/Z-28  
1997-02 CAMARO  
1991-96 CAPRICE  
1982-99 CAVALIER  
1982-90 CELEBRITY  
1985 CITATION II  
1984-89 CORVETTE  
1997-04 CORVETTE  
1978-88 EL CAMINO/CABALLERO  
1994-96 IMPALA  
1990-01 LUMINA  
1990-96 LUMINA VAN  
1997-00 MALIBU  
1986-89 MONTE CARLO  
1985-88 NOVA  
1989-91 BLAZER (FULL SIZE)  
1982-93 S-10 BLAZER  
1998-01 BLAZER  
2002 BLAZER (Standard Radio  
Opening)  
1982-93 S-10 TRUCK  
1998-01 S-10 TRUCK  
2002 S-10 TRUCK (Standard Radio  
Opening)  
1988-91 SUBURBAN  
1988-95 VAN (FULL SIZE)  
1997-99 VENTURE VAN

## GMC

1985-95 SAFARI VAN  
1982-94 JIMMY  
1998-01 JIMMY (ENVOY)  
1982-93 S-15/S-10 TRUCK  
1998-01 SONOMA PICK UP  
2002 SONOMA (Standard Radio  
Opening)

## OLDSMOBILE

1992-95 ACHIEVA  
1991-94 BRAVADA  
1982-91 CALAIS  
1982-96 CIERA  
1984-94 CUTLASS/SUPREME  
1986-91 DELTA 88  
1982-88 FIRENZA  
1989-93 NINETY-EIGHT  
1983-84 OMEGA  
1990-99 SILHOUETTE  
1982-89 TORONADO

## PONTIAC

1982-91 A 6000  
1987-99 BONNEVILLE  
1984-88 FIERO  
1982-92 FIREBIRD  
1998-02 FIREBIRD  
1985-00 GRAND AM  
1990-03 GRAND PRIX  
1982-84 J 2000  
1999 MONTANA  
1985-86 PARISIENNE  
1982-88 SUNBIRD  
1995-99 SUNFIRE  
1990-99 TRANS SPORT VAN

## SATURN

1991-94 SC COUPE, WAGON  
1991-94 SL, SL1, SL2, SEDAN

## GM-K8205P

(See Pg 112)

## BUICK

1982-96 CENTURY  
1974-90 ELECTRA  
1980-94 LE SABRE  
1985-94 PARK AVENUE  
1990-91 REATTA  
1978-87 REGAL  
1984-85 RIVIERA  
1992-95 RIVIERA  
1991-94 ROADMASTER  
1982-89 SKYHAWK  
1983-95 SKYLARK

## CADILLAC

1982-88 CIMARRON  
1990-93 DEVILLE/COUPE  
1984-91 EL DORADO  
1999-02 ESCALADE  
1985-93 FLEETWOOD  
1984-91 SEVILLE

## CHEVROLET

1985-05 ASTRO VAN  
1991-96 BERETTA/CORSICA  
1982-92 CAMARO/Z-28  
1997-02 CAMARO  
1991-96 CAPRICE  
1982-99 CAVALIER  
1982-90 CELEBRITY  
1985 CITATION II  
1984-89 CORVETTE  
1997-04 CORVETTE  
1978-88 EL CAMINO/ CABALLERO  
1996-00 EXPRESS VAN  
1995-02 FULL SIZE PICKUPS  
1994-96 IMPALA  
1990-01 LUMINA  
1990-96 LUMINA VAN  
1997-00 MALIBU  
1986-99 MONTE CARLO  
1985-88 NOVA  
1989-91 BLAZER (FULL SIZE)  
1982-93 S-10 BLAZER  
1998-01 BLAZER  
2002 BLAZER  
(Standard Radio Opening)  
1982-93 S-10 TRUCK  
1998-01 S-10 TRUCK  
2002 S-10 TRUCK  
(Standard Radio Opening)  
1988-91 SUBURBAN  
1995-02 SUBURBAN  
1995-02 TAHOE  
1988-95 VAN (FULL SIZE)  
1997-99 VENTURE VAN

## GMC

1982-94 JIMMY  
1998-01 JIMMY (ENVOY)  
1982-93 S-15/S-10 TRUCK  
1985-05 SAFARI VAN  
1996-00 SAVANA VAN  
1995-02 SIERRA FULL SIZE P/U  
1998-01 SONOMA P/U  
2002 SONOMA P/U  
(Standard Radio Opening)  
1995-02 SUBURBAN  
1995-02 YUKON (Denali/XL)

## OLDSMOBILE

1992-95 ACHIEVA  
1991-94 BRAVADA  
1982-91 CALAIS  
1982-96 CIERA  
1984-94 CUTLASS/SUPREME  
1986-91 DELTA 88  
1982-88 FIRENZA  
1989-93 NINETY-EIGHT  
1983-84 OMEGA  
1990-99 SILHOUETTE  
1982-89 TORONADO

## PONTIAC

1982-91 A 6000  
1987-99 BONNEVILLE  
1984-88 FIERO  
1982-92 FIREBIRD  
1998-02 FIREBIRD  
1985-00 GRAND AM  
1990-03 GRAND PRIX  
1982-84 J 2000  
1999 MONTANA  
1985-86 PARISIENNE  
1982-88 SUNBIRD  
1995-99 SUNFIRE  
1990-99 TRANS SPORT VAN

## SATURN

1991-94 SC COUPE, WAGON  
1991-94 SL, SL1, SL2, SEDAN

## GM-K9210DD

(See Pg 112)

## BUICK

1997-05 CENTURY  
1995-05 LA SABRE  
1995-05 PARK AVE  
2004-07 RAINIER  
1995-04 REGAL  
2002-08 RENDEZVOUS  
1996-99 RIVIERA  
1995-96 ROADMASTER  
1996-98 SKYLARK

## CADILLAC

1990-96 FLEETWOOD (Brougham)  
1992-95 EL DORADO  
2003-06 ESCALADE  
1992-95 SEVILLE

## CHEVROLET

2003-06 AVALANCHE  
2002 BLAZER  
(Required for Oversized Delco radio only)  
2003-04 BLAZER  
2000-05 CAVALIER  
2004-10 COLORADO  
2001-07 EXPRESS VAN  
2000-05 IMPALA  
2001-03 MALIBU  
1998-01 METRO  
2000-05 MONTE CARLO  
2004-06 SSR  
2002 S-10 P/U  
(Required for Oversized Delco radio only)  
2002-04 S-10 P/U  
2003-06 SILVERADO  
2007 SILVERADO (Classic)  
2003-06 SUBURBAN  
2003-06 TAHOE

# PRODUCT LOCATOR & VEHICLE APPLICATION REFERENCE

1998-04 TRACKER  
2002-08 TRAILBLAZER  
2000-05 VENTURE

## GEO

1995-97 METRO

## GMC

2004-10 CANYON  
2002-08 ENVOY  
2002-04 JIMMY  
(Required for Oversized Delco radio only)  
2001-04 SAVANA VAN  
2003-06 SIERRA  
2007 SIERRA CLASSIC  
2002 SONOMA  
(Required for Oversized Delco radio only)  
2003-04 SONOMA  
2003-06 YUKON  
2003-06 XL

## HONDA

1998-02 PASSPORT

## HUMMER

2003-07 H2

## ISUZU

1998-00 AMIGO  
2003-07 ASCENDER  
1998-02 RODEO  
2006 i280  
2006 i350  
2007-08 i290  
2007-08 i370

## OLDSMOBILE

1996-98 ACHIEVA  
1999-04 ALEGRO  
1995-03 AURORA  
1998-04 BRAVADA  
1995-99 CUTLASS/SUPREME  
1994-99 DELTA 88/ROYALE  
1998-02 INTRIGUE  
1996-99 LSS  
1994-96 NINETY-EIGHT  
2000-04 SILHOUETTE

## PONTIAC

2001-05 AZTEK  
2000-04 BONNEVILLE  
2001-03 GRAND AM  
2000-05 SUNFIRE  
2000-04 MONTANA  
2003-08 VIBE

## SUZUKI

2002 AERIO  
1998-02 ESTEEM  
1992-98 SIDEKICK  
1995-01 SWIFT  
1999-02 GRAND VITARA  
1999-03 VITARA  
2001-02 XL7

## TOYOTA

2003-04 MATRIX

## GM-K9210P

(See Pg 113)

## BUICK

1997-05 CENTURY  
1995-05 LA SABRE  
1995-05 PARK AVE  
2004-07 RAINIER  
1995-04 REGAL

2002-08 RENDEZVOUS  
1996-99 RIVIERA  
1995-96 ROADMASTER  
1996-98 SKYLARK

## CADILLAC

1990-96 FLEETWOOD (Brougham)  
1992-95 EL DORADO  
2003-06 ESCALADE  
1992-95 SEVILLE

## CHEVROLET

2003-06 AVALANCHE  
2002 BLAZER  
(Required for Oversized Delco radio only)  
2003-04 BLAZER  
2000-05 CAVALIER  
2004-10 COLORADO  
2001-07 EXPRESS VAN  
2000-05 IMPALA  
2001-03 MALIBU  
1998-01 METRO  
2000-05 MONTE CARLO  
2004-06 SSR  
2002 S-10 P/U

(Required for Oversized Delco radio only)

2002-04 S-10 P/U  
2003-06 SILVERADO  
2007 SILVERADO (Classic)  
2003-06 SUBURBAN  
2003-06 TAHOE  
1998-04 TRACKER  
2002-08 TRAILBLAZER  
2000-05 VENTURE

## GEO

1995-97 METRO

## GMC

2004-10 CANYON  
2002-08 ENVOY  
2002-04 JIMMY  
(Required for Oversized Delco radio only)  
2001-04 SAVANA VAN  
2003-06 SIERRA  
2007 SIERRA CLASSIC  
2002 SONOMA  
(Required for Oversized Delco radio only)  
2003-04 SONOMA  
2003-06 YUKON  
2003-06 XL

## HONDA

1998-02 PASSPORT

## HUMMER

2003-07 H2

## ISUZU

1998-00 AMIGO  
2003-07 ASCENDER  
1998-02 RODEO  
2006 i280  
2006 i350  
2007-08 i290  
2007-08 i370

## OLDSMOBILE

1996-98 ACHIEVA  
1999-04 ALEGRO  
1995-03 AURORA  
1998-04 BRAVADA  
1995-99 CUTLASS/SUPREME  
1994-99 DELTA 88/ROYALE  
1998-02 INTRIGUE

1996-99 LSS  
1994-96 NINETY-EIGHT  
2000-04 SILHOUETTE

## PONTIAC

2001-05 AZTEK  
2000-04 BONNEVILLE  
2001-03 GRAND AM  
2000-05 SUNFIRE  
2000-04 MONTANA  
2003-08 VIBE

## SUZUKI

2002 AERIO  
1998-02 ESTEEM  
1992-98 SIDEKICK  
1995-01 SWIFT  
1999-02 GRAND VITARA  
1999-03 VITARA  
2001-02 XL7

## TOYOTA

2003-04 MATRIX

## GM-K9505

(See Pg 113)

## CHEVROLET

1996-05 ASTRO VAN  
1996-00 EXPRESS VAN  
1995-02 FULL SIZE PICKUPS  
1995-02 SUBURBAN  
1995-02 TAHOE

## GMC

1995-02 SIERRA FULL SIZE P/U  
1996-05 SAFARI VAN  
1996-00 SAVANA VAN  
1995-99 SUBURBAN  
1995-02 YUKON (Denali/XL)

## CADILLAC

1999-02 ESCALADE

## HON-K0710DD

(See Pg 113)

## HONDA

2007-10 CRV

## HON-K0710DDP

(See Pg 114)

## HONDA

2007-10 CRV

## HON-K8610DD

(See Pg 114)

## ACURA

1997-99 CL  
1996-98 TL  
1990-01 INTEGRA  
1986-96 LEGEND  
1992-94 VIGOR

## HONDA

1990-02 ACCORD  
1999-00 CIVIC  
1997-06 CRV  
2003-10 ELEMENT LX  
1995-04 ODYSSEY  
2005-08 PILOT LX  
1992-01 PRELUDE

## HON-K8610P

(See Pg 114)

# PRODUCT LOCATOR & VEHICLE APPLICATION REFERENCE

## ACURA

1997-99 CL  
1996-98 TL  
1990-01 INTEGRA  
1986-96 LEGEND  
1992-94 VIGOR

## HONDA

1990-02 ACCORD  
1999-00 CIVIC  
1997-06 CRV  
2003-10 ELEMENT LX  
1995-04 ODYSSEY  
1992-01 PRELUDE

## MAZ-K0409DD

(See Pg 115)

## MAZDA

2004-09 3 (ALL MODELS)

## MAZ-K0409DDP

(See Pg 115)

## MAZDA

2004-09 3 (ALL MODELS)

## MC-K0208

(See Pg 115)

## MINI

2002-07 COOPER  
2002-07 COOPER S  
2008 COOPER (Convertible Only)

## NIS-K0006

(See Pg 116)

## NISSAN

2000-06 SENTRA

## NIS-K8997P

(See Pg 116)

## NISSAN

1989-94 240 SX  
1993-97 ALTIMA  
1990-92 STANZA

## NIS-K9504P

(See Pg 116)

## NISSAN

1998-01 ALTIMA  
1998-04 FRONTIER  
1995-99 MAXIMA  
1998-02 PATHFINDER (All Models)  
2003-04 PATHFINDER SE  
1999-02 QUEST  
1995-98 200 SX  
1995-99 SENTRA  
2000-04 XTERRA

## MERCURY

1999-02 VILLAGER

## NVC-K0710P

(See Pg 117)

## NISSAN

2010 CUBE  
2007-10 VERSA

## TOY-K0011B

(See Pg 117)

## TOYOTA

2003-09 4-RUNNER SR 5

2000-05 CELICA  
2000-05 ECHO  
2007-10 FJ CRUISER  
2003-07 HIGHLANDER  
2000-05 MR2 SPYDER  
2001-05 RAV4  
2007-10 YARIS (3&4 Door)

## SCION

2003-08 XA  
2003-10 XB  
2005-11 TC  
2008-10 XD

## TOY-K0308DD

(See Pg 117)

## TOYOTA

2003-08 COROLLA

## TOY-K0308P

(See Pg 118)

## TOYOTA

2003-08 COROLLA

## TOY-K8004P

(See Pg 118)

## TOYOTA

1983-97 CAMRY  
1982-99 CELICA  
1980-92 COROLLA  
1981-92 CRESSIDA  
1991-96 LANDCRUISER  
1985-95 MR-2  
1992-97 PASEO  
1991-97 PREVIA VAN  
1986-93 SUPRA  
1995-04 TACOMA  
1981-98 TERCEL  
1984-02 TRUCK/4 RUNNER  
1993-98 T-100

## UNI-K8208

(See Pg 118)

## FORD

1994-00 MUSTANG  
1986-89 TAURUS

## INFINITI

1991-96 G 20  
1999-00 G 20  
1996-00 I 30  
1990-93 M 30  
1990-00 Q 45

## LEXUS

1996-97 LX 450

## MERCURY

1986-89 SABLE

## MAZDA

1993-00 626  
1992-96 929  
1996-99 MPV  
1992-97 MX3  
1993-97 MX6  
1995-99 MIATA  
1995-99 MILLENIA  
1995-00 PROTEGE  
1993-96 RX-7  
2001-04 TRIBUTE

## NISSAN

2005-08 FRONTIER  
2009 FRONTIER  
(XE + SE w/no options)  
2005-07 PATHFINDER  
2005-08 XTERRA

## TOYOTA

1984-02 4 RUNNER  
1985-92 CRESSIDA  
1983-01 CAMRY  
1982-99 CELICA  
1984-02 COROLLA  
1987-96 LAND CRUISER  
1987-95 MR-2  
1992-97 PASEO  
1996-00 RAV 4  
1982-98 SUPRA  
1998-03 SIENNA VAN  
1993-98 T-100  
1995-04 TACOMA  
1981-98 TERCEL  
2000-02 TUNDRA  
1984-94 PICKUP

## VOLVO

1989-96 780  
1993-98 850  
1992-95 940  
1992-97 960  
1998-03 C70  
2000-03 S40/V40

## UNI-K9108

(See Pg 119)

## MITSUBISHI

1997-03 DIAMANTE  
1995-05 ECLIPSE  
1994-03 GALANT  
1996-04 MONTERO  
1997-03 MONTERA SPORT  
1991-99 3000 GT

## SUBARU

2003-07 BAJA  
1998-08 FORESTER  
1993-07 IMPREZA/WRX  
1995-04 LEGACY  
1995-04 OUTBACK  
2004-06 OUTBACK SPORT

## VOLKSWAGEN

2001-05 GOLF  
2001-04 JETTA  
2001-05 PASSAT

## VW-K0510DDP

(See Pg 119)

## VOLKSWAGEN

2009-10 CC  
2007-10 EOS  
2006-10 GTI/GOLF  
2005-10 JETTA A5/GLI  
2006-09 PASSAT  
2007-09 RABBIT  
2009-10 TIGUAN

## VW-K9810

(See Pg 119)

## VOLKSWAGEN

1998-10 BEETLE  
2003-10 BEETLE CABRIO

# CAR STEREO MOUNTING DASH KITS

## FEATURING:

MAZ-K0409DDP

2004-09

MAZDA 3

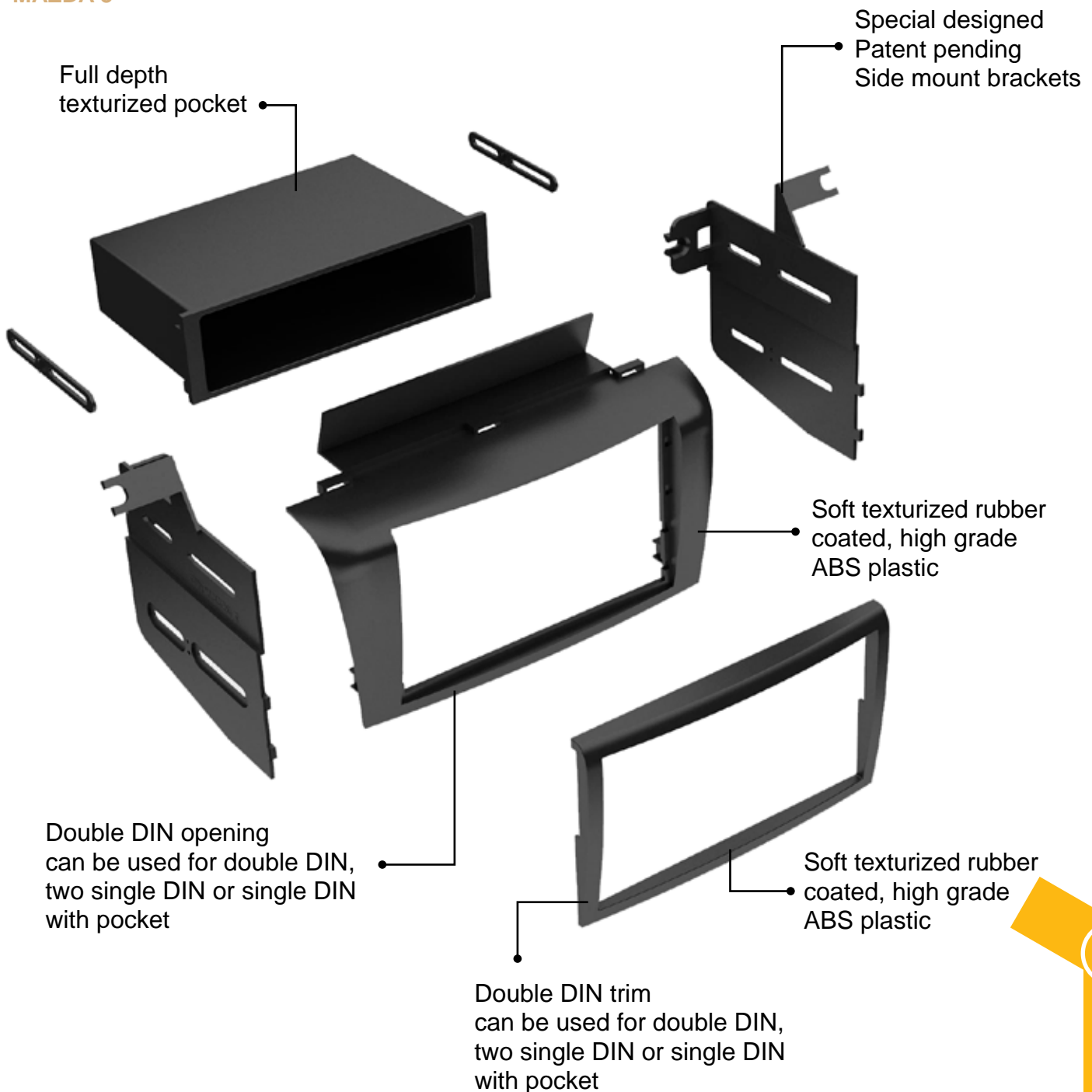

# CAR STEREO MOUNTING DASH KITS



## BMW-K9706P 1997-2006

**BMW**  
(5 Series Models)  
(For Vehicle Specifics See Pg 99)

S # 4

- Soft texturized rubber coated High Grade ABS Plastic
- Specially designed patent pending side mount brackets
- Precise contour to match factory dashboard
- Provides custom radio install appearance
- Accommodates single DIN size unit
- Illustrated instructions for easy installation
- All Necessary hardware included

### Harness:

BMW-1470 / EURO--11010

### Antenna Adapter:

VW-A16L / VW-A16S / VW-A17  
EURO-A106 / EURO-A107



## CF-K7401 1974-2001

**Ford**  
**Lincoln**  
**Mercury**  
**Chrysler**  
**Dodge**  
**Jeep**  
**Eagle**  
**Plymouth**

(For Vehicle Specifics See Pg 99)

S # 6

- Soft texturized rubber coated High Grade ABS Plastic
- Accommodates single DIN size unit
- Illustrated instructions for easy installation
- All Necessary hardware included

### Harness:

CHR-1634 / CHR-4634 / FD-1594  
FD-14 / FD-15



## CHR-K0408DD 2004-2008

**Chrysler**  
**Dodge**  
**Jeep**

(For Vehicle Specifics See Pg 99)

S # 66

- Soft texturized rubber coated High Grade ABS Plastic
- Specially designed patent pending side mount brackets
- Provides custom radio install appearance
- Illustrated instructions for easy installation
- All Necessary hardware included
- Designed to accommodate double DIN units

### Harness:

CHR-1638 / CHR-1637 / CHR-1642  
CHR-1641M / CHR-4644 / CHR-1634  
CHR-4634

### Antenna Adapter:

CHR-A16 / CHR-A17 / EURO-A106  
EURO-A107



# CAR STEREO MOUNTING DASH KITS



CHR-K0410P

2004-2010

Chrysler  
Dodge  
Jeep

(For Vehicle Specifics See Pg 99)

S # 3

- Soft texturized rubber coated High Grade ABS Plastic
- Custom molded full size texturized pocket
- Specially designed patent pending side mount brackets
- Precise contour to match factory dashboard
- Provides custom radio install appearance
- Accommodates single DIN size unit
- Illustrated instructions for easy installation
- All Necessary hardware included

**Harness:**

CHR-1638 / CHR-4644

**Antenna Adapter:**

CHR-A16 / CHR-A17



CHR-K0710B

2007-2010

Chrysler  
Dodge  
Jeep

VW

(For Vehicle Specifics See Pg 99)

S # 67

- Soft texturized rubber coated High Grade ABS Plastic
- Precise contour to match factory dashboard
- Illustrated instructions for easy installation
- All Necessary hardware included

**Harness:**

CHR-1642 / CHR-1641M

**Antenna Adapter:**

CHR-A16 / CHR-A17 / EURO-A106  
EURO-A107



CHR-K7401

1974-2001

Chrysler  
Plymouth  
Dodge  
Jeep

Eagle

(For Vehicle Specifics See Pg 99)

S # 1

- Soft texturized rubber coated High Grade ABS Plastic
- Accommodates single DIN size unit
- Illustrated instructions for easy installation
- Precise contour to match factory dashboard

**Harness:**

CHR-1634 / CHR-4634

Your Source of Ultimate Technology

# CAR STEREO MOUNTING DASH KITS

# CAR STEREO MOUNTING DASH KITS



CHR-K9807

1998-2007

Jeep  
Chrysler  
Dodge

(For Vehicle Specifics See Pg 100)

S # 2

- Soft texturized rubber coated High Grade ABS Plastic
- Accommodates single DIN size unit
- Precise contour to match factory dashboard
- Illustrated instructions for easy installation
- All Necessary hardware included

**Harness:**

CHR-1634 / CHR-1638 / CHR-4634  
CHR-4644

**Antenna Adapter:**

CHR-A16 / CHR-A17

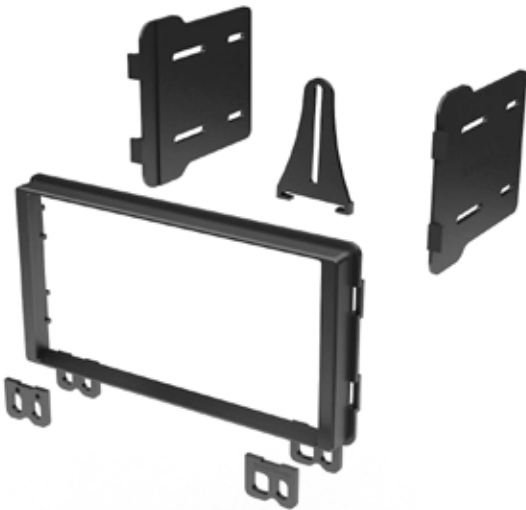

FM-K0106DD

2001-2006

Ford  
Lincoln  
Mercury

(For Vehicle Specifics See Pg 100)

S # 69

- Soft texturized rubber coated High Grade ABS Plastic
- Illustrated instructions for easy installation
- All Necessary hardware included
- Desined specifically to accommodate double Din units

**Harness:**

FD-1594 / FD-1598 / FD-1600  
FD-5520 / FD-5521-M / FD-5521-1M  
FD-4508 / FD-4506 / FD-4502  
FD-45520 / FD-4508 / FD-1596  
FD-14 / FD-15

**Antenna Adaptor:**

FD-A16 / FD-A17 / CHR-A16  
CHR-A17



FM-K0411DD

2004-2011

Ford  
Lincoln  
Mercury  
Mazda

(For Vehicle Specifics See Pg 100)

S # 8

- Soft texturized rubber coated High Grade ABS Plastic
- Specially designed patent pending side mount brackets
- Precise contour to match factory dashboard
- Illustrated instructions for easy installation
- All Necessary hardware included
- Specifically designed for double DIN or two single DIN units

**Harness:**

FD-5520 / FD-45520

**Antenna Adapter:**

CHR-A16 / CHR-A17

# CAR STEREO MOUNTING DASH KITS

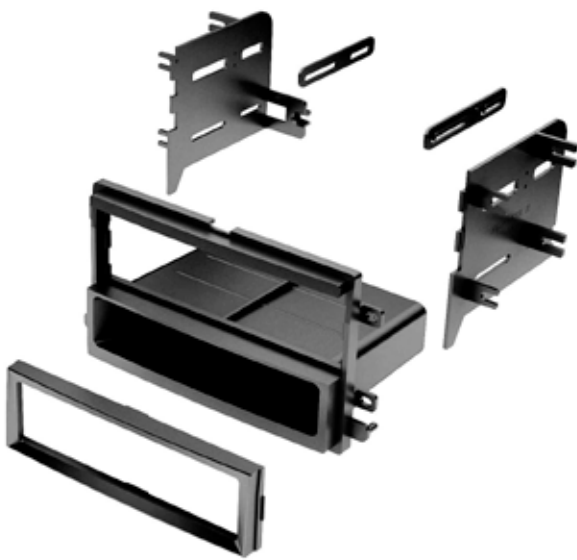

**FM-K0411P**

**2004-2011**

**Ford**  
**Mercury**  
**Lincoln**  
**Mazda**

(For Vehicle Specifics See Pg 100)

S # 7

- Soft texturized rubber coated High Grade ABS Plastic
- Custom Molded full Size Texturized Pocket
- Specially designed patent pending side mount brackets
- Precise contour to match factory dashboard
- Provides custom radio install appearance
- Accommodates single DIN size unit
- Illustrated instructions for easy installation
- All Necessary hardware included

**Harness:**

FD-5520 / FD-45520

**Antenna Adapter:**

CHR-A16 / CHR-A17

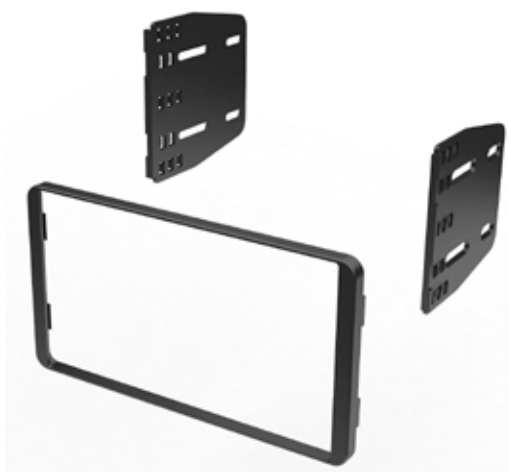

**FM-K9510DD**

**1995-2010**

**Ford**  
**Lincoln**  
**Mercury**  
**Mazda**

(For Vehicle Specifics See Pg 100)

S # 68

- Soft texturized rubber coated High Grade ABS Plastic
- Illustrated instructions for easy installation
- All Necessary hardware included
- Designed specifically to accommodate double Din units

**Harness:**

FD-1598 / FD-1597 / FD-1596  
FD-1600 / FD-1594 / FD-1595M  
FD-5520 / FD-5521 / FD-5521-1M  
FD-4596 / FD-45520 / FD-4508  
FD-14 / FD-15 / FD-4502

**Antenna Adapter:**

FD-A16 / FD-A17 / CHR-A16  
CHR-A17



**FM-K9510P**

**1995-2010**

**Ford**  
**Lincoln**  
**Mazda**  
**Mercury**

(For Vehicle Specifics See Pg 100)

S # 9

- Soft texturized rubber coated High Grade ABS Plastic
- Specially designed patent pending side mount brackets
- Precise contour to match factory dashboard
- Provides custom radio install appearance
- Accommodates single DIN size unit
- Illustrated instructions for easy installation
- All Necessary hardware included

**Harness:**

FD-14 / FD-15 / FD-4502 / FD-1594  
FD-1596 / FD-1598 / FD-1600  
FD-5520 / FD-45520 / FD-4508

**Antenna Adapter:**

FD-A16 / FD-A17

Your Source of Ultimate Technology

CAR STEREO  
MOUNTING DASH KITS

# CAR STEREO MOUNTING DASH KITS



GM-K0401DD

2004-2010

**Chevrolet**

**Pontiac**

**Saturn**

(For Vehicle Specifics See Pg 100)

S # 11

- Soft texturized rubber coated High Grade ABS Plastic
- Specially designed patent pending side mount brackets
- Precise contour to match factory dashboard
- Provides custom radio install appearance
- Specifically designed for double DIN or two single DIN units

**Harness:**

GM-1406 / GM-1406 PIO

**Antenna Adapter:**

GM-A36 / GM-A16 / GM-A17

CHR-A16 / CHR-A17



GM-K0410DDP

2004-2010

**Chevrolet**

**Pontiac**

**Saturn**

(For Vehicle Specifics See Pg 101)

S # 13

- Soft texturized rubber coated High Grade ABS Plastic
- Specially designed patent pending side mount brackets
- Precise contour to match factory dashboard
- Illustrated instructions for easy installation
- All Necessary hardware included
- Specifically designed for double DIN or Two / One single DIN units
- Includes full size pocket for single DIN application
- Includes one double Din trim & One single Din trim

**Harness:**

GM-1406 / GM-1406P10 / GM-1404

**Antenna Adapter:**

GM-A36 / Gm-A16 / GM-A17

CHR-A16 / CHR-A17



GM-K0410P

2004-2010

**Chevrolet**

**Pontiac**

**Saturn**

(For Vehicle Specifics See Pg 101)

S # 12

- Soft texturized rubber coated High Grade ABS Plastic
- Specially designed patent pending side mount brackets
- Precise contour to match factory dashboard
- Provides custom radio install appearance
- Accommodates single DIN size unit
- Illustrated instructions for easy installation
- All Necessary hardware included
- Full Depth Texturized Pocket

**Harness:**

GM-1406 / GM-1406PIO

**Antenna Adapter:**

GM-A36 / GM-A16 / GM-A17

CHR-A16 / CHR-A17

# CAR STEREO MOUNTING DASH KITS



## GM-K0610DD

2006-2010

**Buick**  
**Chevrolet**  
**GMC**  
**Pontiac**  
**Saturn**  
**Suzuki**

(For Vehicle Specifics See Pg 101)

S # 70

- Soft texturized rubber coated High Grade ABS Plastic
- Specially designed patent pending side mount brackets
- Illustrated instructions for easy installation
- Desined specifically to accommodate double Din units

### Harness:

GM-1406 / GM-1406PIO

### Antenna Adapter:

CHR-A16 / CHR-A17

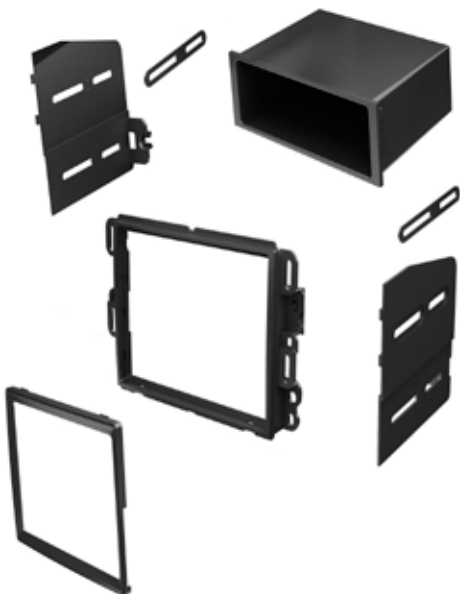

## GM-K0610DDP

2006-2010

**Buick**  
**Chevrolet**  
**GMC**  
**Pontiac**  
**Saturn**  
**Suzuki**

(For Vehicle Specifics See Pg 101)

S # 71

- Soft texturized rubber coated High Grade ABS Plastic
- Specially designed patent pending side mount brackets
- Provides custom radio install appearance
- Accommodate a double DIN or single DIN with a pocket
- Illustrated instructions for easy installation
- All Necessary hardware included

### Harness:

GM-1406 / GM-1406PIO

### Antenna Adapter:

CHR-A16 / CHR-A17

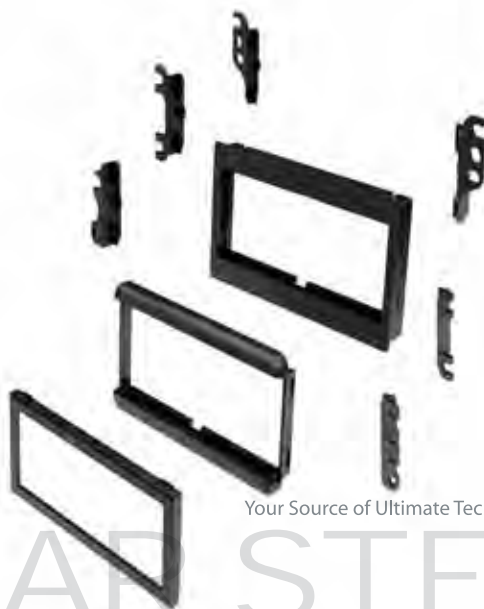

## GM-K8204

1982-2004

**Buick**  
**Cadillac**  
**Chevrolet**  
**GMC**  
**Oldsmobile**  
**Pontiac**  
**Saturn**

(For Vehicle Specifics See Pg 101)

S # 16

- Soft texturized rubber coated High Grade ABS Plastic
- Accommodates single DIN size unit
- Illustrated instructions for easy installation
- All Necessary hardware included
- Include 1 / 2 " nose extension for the vehicles with dept restrictions
- Easy Snap self locking brackets

### Harness:

GM-1342, GM-1344

### Antenna Adapter:

GM-A16, GM-A17, GM-A36

Your Source of Ultimate Technology

# CAR STEREO MOUNTING DASH KITS

# CAR STEREO MOUNTING DASH KITS



GM-K8204-1E

1982-2004

**Buick**  
**Cadillac**  
**Chevrolet**  
**GMC**  
**Oldsmobile**  
**Pontiac**  
**Saturn**

(For Vehicle Specifics See Pg 101)

S # 65

- Soft texturized rubber coated High Grade ABS Plastic
- Accommodates single DIN size unit
- Illustrated instructions for easy installation
- All Necessary hardware included
- Includes 1 / 2" & 1" nose extensions for vehicles with depth restrictions
- Includes E-Z snap in self-locking brackets
- for radios w / non-removable brackets.

**Harness:**

GM-1342 / GM-1343M / GM-1344  
GM-1346 / GM-1346R / GM-1348  
GM-1350 / GM-1354 / GM-1404  
GM-1351M / GM-1347M

**Antenna Adapter:**

GM-A16 / GM-A17 / GM-A36



GM-K8205P

1982-2005

**General Motors**

**Buick**  
**Cadillac**  
**Chevrolet**  
**GMC**  
**Oldsmobile**  
**Pontiac**  
**Saturn**

(For Vehicle Specifics See Pg 102)

S # 17

- Soft texturized rubber coated High Grade ABS Plastic
- Specially designed patent pending side mount brackets
- Precise contour to match factory dashboard
- Provides custom radio install appearance
- Accommodates single DIN size unit
- Illustrated instructions for easy installation
- All Necessary hardware included

**Harness:**

GM-1342 / GM-1343M / GM-1344  
GM-1346 / GM-1346R / GM-1348  
GM-1350 / GM-1354 / GM-1404  
GM-1351M / GM-1347M

**Antenna Adapter:**

GM-A16, GM-A17, GM-A36



GM-K9210DD

1992-2010

**General Motors**

**Buick**  
**Cadillac**  
**Geo**  
**GMC**  
**Honda**  
**Hummer**  
**Isuzu**  
**Oldsmobile**  
**Pontiac**  
**Toyota**

(For Vehicle Specifics See Pg 102)

S # 15

- Soft texturized rubber coated High Grade ABS Plastic
- Specially designed patent pending side mount brackets
- Illustrated instructions for easy installation
- All Necessary hardware included
- Specifically designed for double DIN or two single DIN units

**Harness:**

GM-1344, GM-1346, GM-1346R  
GM-1416, ISU-1974

**Antenna Adapter:**

GM-A36, GM-A16, GM-A17, VW-A16L,  
VW-A16S, VW-A17

# CAR STEREO MOUNTING DASH KITS



GM-K9210P

1992-2010

GM

Buick

Cadillac

Chevrolet

Geo

GMC

Hummer

Oldsmobile

Pontiac

Honda

Isuzu

Suzuki

Toyota

(For Vehicle Specifics See Pg 103)

S # 14



GM-K9505

1995-2005

Cadillac

Chevrolet

GMC

(For Vehicle Specifics See Pg 103)

S # 10

- Soft texturized rubber coated High Grade ABS Plastic
- Specially designed patent pending side mount brackets
- Precise contour to match factory dashboard
- Provides custom radio install appearance
- Accommodates single DIN size unit
- Illustrated instructions for easy installation
- All Necessary hardware included

**Harness:**

GM-1344

**Antenna Adapter:**

GM-A36 / GM-A16 / GM-A17



HON-K0710DD

2007-2010

Honda CRV

(For Vehicle Specifics See Pg 103)

S # 72

- Soft texturized rubber coated High Grade ABS Plastic
- Specially designed patent pending side mount brackets
- Precise contour to match factory dashboard
- Precise contour to match factory dashboard
- Accommodates single DIN size unit
- Illustrated instructions for easy installation
- All Necessary hardware included
- Designed specifically to accommodate double Din units

**Harness:**

HON-1812 / HON-1813M

**Antenna Adapter:**

HON-A106 / HON-A107

# CAR STEREO MOUNTING DASH KITS



## HON-K0710DDP 2007-2010

**Honda CRV**  
(For Vehicle Specifics See Pg 103)

S # 73

- Soft texturized rubber coated High Grade ABS Plastic
- Specially designed patent pending side mount brackets
- Provides custom radio install appearance
- Accommodate a double DIN or single DIN with a pocket
- Illustrated instructions for easy installation
- All Necessary hardware included

### **Harness:**

HON-1812 / HON-1813M

### **Antenna Adapter:**

HON-A106 / HON-A107



## HON-K8610DD 1986-2010

**Honda  
Acura  
Isuzu**  
(For Vehicle Specifics See Pg 103)

S # 19

- Soft texturized rubber coated High Grade ABS Plastic
- Specially designed patent pending side mount brackets
- Provides custom radio install appearance
- Illustrated instructions for easy installation
- All Necessary hardware included
- Specifically designed for double DIN or two single DIN units

### **Harness:**

Hon-1804 / Hon-1806 / Hon-1807M  
Hon-1805M / Hon-1820 / Hon-190  
Hon-4802 / Hon-4808



## HON-K8610P 1986-2010

**Honda  
Acura  
Isuzu**  
(For Vehicle Specifics See Pg 103)

S # 18

- Soft texturized rubber coated High Grade ABS Plastic
- Specially designed patent pending side mount brackets
- Precise contour to match factory dashboard
- Provides custom radio install appearance
- Accommodates single DIN size unit
- Illustrated instructions for easy installation
- All Necessary hardware included
- Custom molded Full Size texturized rubber coated pocket

### **Harness:**

Hon-1804 / Hon-1806 / Hon-1807M  
Hon-1805M / Hon-1820 / Hon-190  
Hon-4802 / Hon-4808



# CAR STEREO MOUNTING DASH KITS



## MAZ-K0409DD

2004-2009

**Mazda 3**

(For Vehicle Specifics See Pg 104)

S # 75

- Soft texturized rubber coated High Grade ABS Plastic
- Designed specifically to accommodate double DIN units
- Provides custom radio install appearance
- Illustrated instructions for easy installation
- All Necessary hardware included

**Harness:**

MAZ-1858 / MAZ-1859M



## MAZ-K0409DDP

2004-2009

**Mazda 3**

(For Vehicle Specifics See Pg 104)

S # 74

- Soft texturized rubber coated High Grade ABS Plastic
- Specially designed patent pending side mount brackets
- Precise contour to match factory dashboard
- Accommodate a double DIN or single DIN with a pocket
- Illustrated instructions for easy installation
- All Necessary hardware included

**Harness:**

MAZ-1858 / MAZ-1859M



## MC-K0208

2002-2008

**Mini Cooper**

(For Vehicle Specifics See Pg 104)

S # 76

- Soft texturized rubber coated High Grade ABS Plastic
- Provides custom radio install appearance
- Accommodates single DIN size unit
- Illustrated instructions for easy installation
- All Necessary hardware included

**Harness:**

EURO-11010 / EURO-11009

**Antenna Adapter:**

EURO-A106 / EURO-A107

Your Source of Ultimate Technology

# CAR STEREO MOUNTING DASH KITS

# CAR STEREO MOUNTING DASH KITS



## NIS-K0006

2000-2006

**Nissan**

(For Vehicle Specifics See Pg 104)

S # 21

- Soft texturized rubber coated High Grade ABS Plastic
- Precise contour to match factory dashboard
- Illustrated instructions for easy installation
- All Necessary hardware included

**Harness:**

Nis-1702 / Nis-4702 / Nis-1703M



## NIS-K8997P

1989-1997

**Nissan**

(For Vehicle Specifics See Pg 104)

S # 20

- Soft texturized rubber coated High Grade ABS Plastic
- Provides custom radio install appearance
- Illustrated instructions for easy installation
- All Necessary hardware included
- Custom molded Full Size texturized rubber coated pocket
- Accommodates single DIN size unit

**Harness:**

Nis-1700 / Nis-1701M / Nis-1702  
Nis-1703M / Nis-4700 / Nis-4702

**Antenna Adapter:**

Nis-A17 / Nis-A19 / Nis-A110 / Nis-A97  
Nis-a115 / Nis-A120



## NIS-K9504P

1995-2004

**Nissan**

(For Vehicle Specifics See Pg 104)

S # 22

- Soft texturized rubber coated High Grade ABS Plastic
- Provides custom radio install appearance
- Illustrated instructions for easy installation
- All Necessary hardware included
- Precise contour to match factory dashboard
- Accommodates single DIN size unit
- Custom molded Full Size texturized rubber coated pocket
- Specially designed patent pending side mount brackets

**Harness:**

Nis-1702 / FD-1598 / Nis-1703M  
Nis-4702

**Antenna Adapter:**

Nis-A17 / Nis-A19 / Nis-A110 / Nis-A19  
Nis-A110 / Nis-A115 / Nis-A120

# CAR STEREO MOUNTING DASH KITS



**NVC-K0710P**  
**2007-2010**

**Nissan**  
**Versa & Cube**

(For Vehicle Specifics See Pg 104)

S # 77

- Soft texturized rubber coated High Grade ABS Plastic
- Specially designed patent pending side mount brackets
- Illustrated instructions for easy installation
- All Necessary hardware included
- Custom molded full size texturized rubber coated pocket

**Harness:**

NIS-1708 / NIS-1705M

**Antenna Adapter:**

NIS-A106 / NIS-A107



**TOY-K0011B**  
**2000-2011**

**Toyota**  
**Scion**

(For Vehicle Specifics See Pg 104)

S # 23

- Soft texturized rubber coated High Grade ABS Plastic
- Double DIN trim brackets
- Secured mounting systems to aftermarket units
- Mounts to Aftermarket
- double DIN using
- factory mounting brackets

**Harness:**

TOY-1950 / TOY-1951 / TOY-1960  
 TOY-1961 / TOY-4940

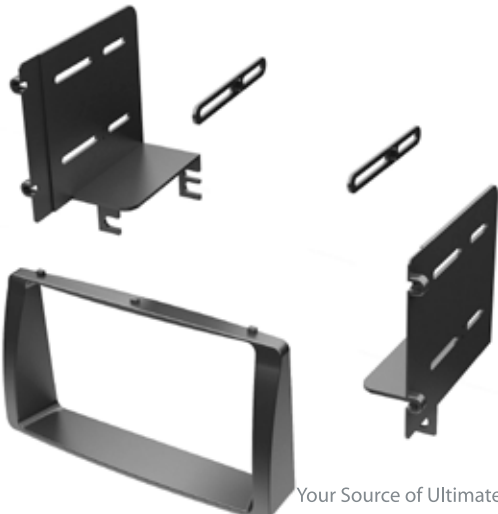

**TOY-K0308DD**  
**2003-2008**

**Toyota Corolla**

(For Vehicle Specifics See Pg 104)

S # 78

- Soft texturized rubber coated High Grade ABS Plastic
- Specially designed patent pending side mount brackets
- Provides custom radio install appearance
- Accommodates single DIN size unit
- Illustrated instructions for easy installation
- All Necessary hardware included
- Designed specifically to accommodate double Din units

**Harness:**

TOY-1950 / TOY-1951M

Your Source of Ultimate Technology

CAR STEREO  
 MOUNTING DASH KITS

# CAR STEREO MOUNTING DASH KITS



## TOY-K0308P

2003-2008

**Toyota Corolla**

(For Vehicle Specifics See Pg 104)

S # 79

- Soft texturized rubber coated High Grade ABS Plastic
- Specially designed patent pending side mount brackets
- Precise contour to match factory dashboard
- Accommodates single DIN size unit
- Illustrated instructions for easy installation
- All Necessary hardware included

**Harness:**

TOY-1950 / TOY-1951M



## TOY-K8004P

1980-2004

**Toyota**

(For Vehicle Specifics See Pg 104)

S # 24

- Soft texturized rubber coated High Grade ABS Plastic
- Precise contour to match factory dashboard
- Accommodates single DIN size unit
- Illustrated instructions for easy installation
- All Necessary hardware included
- Custom molded Full Size texturized rubber coated pocket

**Harness:**

TOY-1950 / TOY-1960 / TOY-1951M  
TOY-1961M / TOY-4940 / TOY-4960



## UNI-K8208

1982-2008

**Ford**

**Infiniti**

**Lexus**

**Mercury**

**Mazda**

**Nissan**

**Toyota**

**Volvo**

(For Vehicle Specifics See Pg 104)

S # 37

- Full size pocket designed for replacing factory double din unit or when factory pocket iso din unit are not available
- Includes three factory custom trim ring
- Specially designed slide side lock bracket
- Provides custom radio install appearance
- Precise contour to match factory dashboard
- Works with OEM brackets.
- Illustrated instructions for easy installation
- All Necessary hardware included

# CAR STEREO MOUNTING DASH KITS



## UNI-K9108

1991-2008

Mitsubishi

Subaru

Volkswagen

(For Vehicle Specifics See Pg 104)

S # 38

- Full size pocket designed for replacing factory double din unit or when factory pocket iso din unit are not available
- Includes three factory custom trim ring
- Specially designed slide side lock bracket
- Provides custom radio install appearance
- Precise contour to match factory dashboard
- Works with OEM brackets.
- Illustrated instructions for easy installation
- All Necessary hardware included



## VW-K0510DDP

2005-2010

Volkswagen

CC

GTI

JETTA

PASSAT

RABBIT

TIJUAN

(For Vehicle Specifics See Pg 104)

S # 80

- Soft texturized rubber coated High Grade ABS Plastic
- Specially designed patent pending side mount brackets
- Accommodate a double DIN or single DIN with a pocket
- Precise contour to match factory dashboard
- Illustrated instructions for easy installation
- All Necessary hardware included

### Harness:

EURO-11010 / EURO-11099  
VW-11004

### Antenna Adapter:

EURO-A106 / EURO-107  
EURO-A108 / EURO-A666  
EURO-A777



## VW-K9810

1998-2010

VW Beetle

(For Vehicle Specifics See Pg 104)

S # 5

- Soft texturized rubber coated High Grade ABS Plastic
- Specially designed patent pending side mount brackets
- Precise contour to match factory dashboard
- Provides custom radio install appearance
- Accommodates single DIN size unit
- Illustrated instructions for easy installation
- All Necessary hardware included

### Harness:

VW-11000 / VW-11004

### Antenna Adapter:

VW-A16L / VW-A16S / VW-A17

Your Source of Ultimate Technology

# CAR STEREO MOUNTING DASH KITS

# EQ & DIN TRIM. HOUSING. ADAPTERS. EXTENSIONS

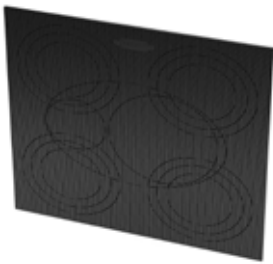

**CAS-1212SGP**  
12"x12"x1/8"  
Custom ABS Speaker Grid Plate  
Speaker Adapter Templet Scored  
for: Tweeters, 3", 4", 5", 5 1/4",  
6 1/2" and 6x9 Speakers  
S # 41



**DT-3434**  
DIN TRIM RING  
with 3/4" BORDER  
S # 47



**DDT-1515**  
Double Din Trim Ring  
with 1 1/2" Border  
Scored Back for EZ Cutting  
for Custom Feeting  
S # 42



**EQT-1212**  
EQ TRIM RING  
with 1/2" BORDER  
S # 48



**DT-1212**  
DIN TRIM RING  
with 1/2" BORDER  
S # 43



**EQT-1414**  
EQ TRIM RING  
with 1/4" BORDER  
S # 49

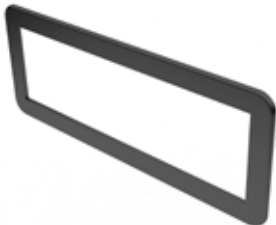

**DT-1414**  
DIN TRIM RING  
with 1/4" BORDER  
S # 44



**GSA-FT5465**  
1995-UP  
Gm Full Size Truck & Suv's  
Front Speaker Adapters  
S # 50



**HSA-6554**  
2003-UP (Select models)  
Honda Accord  
5 1/4"-6 1/2" Front Door  
Speaker Adapter / bracket  
S # 51



**DT-1818**  
DIN TRIM RING  
with 1/8" BORDER  
S # 45



**SP-AD6054.12**  
Universal Speaker Adapter  
5 1/4" to 6 1/2"  
1/2" Stackable Depth Extender  
S # 53



**DT-2020**  
DIN TRIM RING  
with 2" BORDER  
Scored Back for Easy Cutting  
for Customer Feeting  
S # 46



**SP-AD6054.14**  
Universal Speaker Adapter  
5 1/2" to 6 1/2"  
1/4" Stackable Depth Extender  
S # 54

# HOUSING. ADAPTERS. EXTENSIONS. BRACKETS



**SP-AD6957**  
 Ford / Mercury / Chrysler  
 Plymouth / Dodge Speaker  
 Adapter  
 Adapters: 6x9 Speaker to  
 5x7 or 6x8 Location  
 S # 55



**URH-8275**  
 Universal  
 Underdash / Overhead  
 Radio Housing  
 S # 61

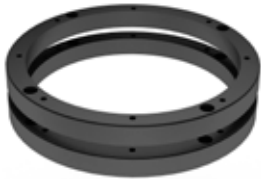

**SP-DE65**  
 Stackable 6 1/2" Speaker  
 Depth Extender  
 (1/2" Depth-Up)  
 S # 56



**USDX-SP69**  
 6 x 9 Speaker Extender  
 3/4" Stackable Depth Extender  
 S # 57



**UABP-1212**  
 12"x12"x1/8"  
 Universal ABS Black Panel  
 ABS Black Panel for Custom  
 Installation  
 Texture Front, Smooth Back  
 S # 40

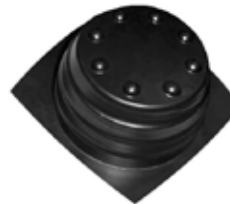

**USP-5465**  
 Universal 5 1/4" & 6 1/2" Speaker  
 Protector  
 Prevents water damage, High  
 Volum Distrotion, Blow Out from  
 Slaming Door or Trunk Lids  
 S # 59



**UB-107**  
 Universal Mounting Bracket  
 For Double Din, ISO Din, EQ,  
 CB's and ETC.  
 Scored for easy Breakaway  
 S # 62



**USP-69**  
 Universal 6x9 Speaker Protector  
 Prevents water damage, High  
 Volum Distrotion, Blow Out from  
 Slaming Door or Trunk Lids  
 S # 60



**UMB-555**  
 Universal Mounting Bracket  
 Designed to Mount:  
 Portable GPS Devices, Satellite  
 Radios, MP3 Players, Cell  
 Phones, RF Modulated Display,  
 XM Radio/CD Changer Display  
 S # 63



**USPA-5060**  
 5 1/4"-6 1/2" Speaker Adapter  
 1/2" Depth Extender  
 To Over Sized OEM Speaker  
 Mounting Location (Front Door)  
 S # 52



**UMRH-888W(white)**  
**UMRH-888B(Black)**  
 Universal Marine Radio Housing  
 Water Proof  
 UV Coated Tinted Cover  
 Multiple Stop Stage  
 Available in Black & White  
 S # 64



**USPA-6090**  
 Universal Speaker Adapter  
 6x9 to 5" through 6 1/2"  
 6x8 to 5" through 6"  
 5x7 to 5"  
 S # 58



### BMW-1470

BMW  
90-02  
• Plugs into factory harness  
Power / 4 Speakers  
S # H437



### BMW-4470

BMW  
• BMW 3 series / 7 series 92-01  
• M coupe 98-00 / M3 coupe 98  
• Z3 97-02  
• Amplifier integration harness  
S # H484



### CHR-1634

CHRYSLER / DODGE / PLYMOUTH / JEEP  
84-02  
• Plugs into factory harness  
Power / 4 Speakers  
S # H431



### CHR-1633M

CHRYSLER / DODGE / PLYMOUTH / JEEP  
84-02  
• Plugs into factory radio  
Power / 4 Speakers (MALE PLUG)  
S # H432



### CHR-1637M

CHRYSLER / DODGE / JEEP  
02-UP (male plug)  
• Plugs into Factory Radio  
S #



### CHR-1638

CHRYSLER / DODGE / JEEP  
2002-UP  
• Plugs into factory harness  
Power / 4 Speakers  
S # H446



### CHR-1641M

CHRYSLER / DODGE / PLYMOUTH / JEEP  
07-UP (male plug)  
• Plugs into Factory Radio  
S #



### CHR-1642

CHRYSLER / DODGE / JEEP  
2007-UP  
• Plugs into Factory Harness  
S # H615



### CHR-4634

CHRYSLER / DODGE / PLYMOUTH / JEEP  
84-02  
• Amplifier integration harness  
• For all Infinity systems when using a 35 watt or (greater) radio  
• Plugs into car harness  
S # H482



### CHR-4644

CHRYSLER / DODGE / PLYMOUTH / JEEP  
02-UP  
• Amplifier integration harness with RCAS  
S # H481



### CHR-5622

CHRYSLER / DODGE / JEEP  
84-05  
• Grand Cherokee Bypass Jumper  
• Power / Amp bypass harness  
• Includes Chrysler / Plymouth / Dodge / Jeep  
84-05 harness and an amplifier bypass jumper  
harness to eliminate the factory amplifier  
S # H480



### CI-1610

CHRYSLER IMPORTS / MITSUBISHI  
87-96  
• Plugs into factory harness  
Power / 4 Speakers  
S # H429



### CI-1612

CHRYSLER IMPORTS / MITSUBISHI 92-UP  
DODGE STEALTH 94-96  
• Plugs into factory harness  
Power / 4 Speakers  
S # H428



### CI-1613M

CHRYSLER IMPORTS / MITSUBISHI 92-UP  
DODGE STEALTH 94-96  
• Plugs into factory radio  
Power / 4 Speakers (MALE PLUG)  
S # H430



### DAE-1664

DAEWOO  
99-UP  
• Plugs into factory harness  
Power / 4 Speakers  
S # H426





**DODG-462A**  
DODGE / MITSUBISHI  
94-05  
• Amplifier Integration Harness  
S #



**EURO-412A**  
VW / AUDI  
93-04  
• Amplifier Integration Harness  
• Plugs into Factory Harness  
S #



**EURO-11009M**  
BMW 5 SERIES / AUDI / VW  
DOUBLE DIN  
02-UP (male plug)  
• Plugs into Factory Radio  
S #



**EURO-11010**  
BMW / VW / AUDI  
BMW 5 SERIES / AUDI 02-UP / VW DOUBLE DIN  
• Plugs into factory harness  
S # H445



**EURO-4460**  
MERCEDES  
91-99 (all models)  
• Amplifier integration harness  
S # H485



**EURO-1460**  
MERCEDES / VW / LAND ROVER  
• Mercedes C-Class (94-04)  
• Land Rover Discovery (99-04)  
• Dodge Sprinter (03-06)  
S # H483



**EURO-1414**  
MERCEDES / BMW / VW  
• European speaker harness  
S # H486



**FD-14**  
FORD / LINCOLN / MERCURY  
88-01  
(SELECT VEHICLES)  
• Premium sound high level input harness  
S # H401



**FD-15**  
FORD / LINCOLN / MERCURY  
91-96  
(SELECT VEHICLES)  
• Amp jumper for by-passing Factory amplifier  
S # H404



**FD-146**  
FORD / LINCOLN / MERCURY  
(SELECT VEHICLES)  
• Amplifier integrator system for premium  
sound systems • High level input  
S # H403



**FD-446**  
FORD / LINCOLN / MERCURY  
• Amplifier integration harness  
• For all amplified systems using a 35 watt  
(or greater) radio  
S # H453



**FD-1593M**  
FORD / LINCOLN / MERCURY / MAZDA  
85-UP  
• Plugs into factory radio (MALE PLUG)  
Power / 4 Speakers  
S # H407



**FD-1594**  
FORD / LINCOLN / MERCURY / MAZDA  
85-UP  
• Plugs into factory harness  
Power / 4 Speakers  
S # H402



**FD-1595M**  
FORD / LINCOLN / MERCURY  
95-98 (male plug)  
• Plugs into Factory Radio  
S #



**FD-1596**  
FORD / LINCOLN / MERCURY  
95-98  
• Plugs into factory harness  
Power / 4 Speakers  
S # H405



**FD-1597M**  
 FORD / LINCOLN / MERCURY / MAZDA  
 98-UP (MALE PLUG)  
 • Plugs into factory radio  
 Power / 4 Speakers  
 S # H406



**FD-1598**  
 FORD / LINCOLN / MERCURY / MAZDA  
 98-UP  
 • Plugs into factory harness  
 Power / 4 Speakers  
 S # H400



**FD-1600**  
 FORD / LINCOLN / MERCURY / MAZDA  
 98-UP  
 • Premium sound, plugs into Factory harness  
 S # H408



**FD-4456**  
 FORD / LINCOLN / MERCURY  
 • Factory radio integration  
 • Bypass the amplifier to replace new factory radio  
 S # H459



**FD-4502**  
 FORD / LINCOLN / MERCURY  
 2003-UP (sub plug only)  
 • For amplified sound system  
 • For use in application that already has the FD-5520 and is being installed into an amplified vehicle  
 S # H458



**FD-4506**  
 Ford amplifier integrator plug  
 • 98-03 Grand Marquis • 01-03 Escape  
 • 98-03 Continental • 98-01 Town Car  
 • 98-01 Crown Victoria  
 • Plugs into car harness  
 S # H455



**FD-4508**  
 Ford amplifier integrator plug  
 • 01-03 Mustang with 460 x Mach 1000  
 • 02-03 Lincoln LS  
 • Plugs into car harness  
 S # H456



**FD-4592**  
 FORD / LINCOLN / MERCURY  
 86-92  
 • Amplifier integration harness  
 • Designed for Ford vehicles with the common ground amplified system, not for JBL or LUX systems  
 S # H452



**FD-4594**  
 FORD / LINCOLN / MERCURY / MAZDA  
 88-94  
 • Amplifier integration harness  
 • Ford Aerostar with EQ under the radio  
 S # H457



**FD-4596**  
 FORD / LINCOLN / MERCURY  
 95-98  
 • Amplifier integration harness  
 • For all amplified systems using a 35 watt (or greater) radio  
 S # H451



**FD-5520**  
 FORD MARAUDER / CROWN VICTORIA  
 GRAND MARQUIS 2003 & UP  
 EXPEDITION (Late Production 2003)  
 • Plugs into factory harness  
 S # H448



**FD-5521M**  
 FORD / LINCOLN / MERCURY  
 2003-UP (24 pin, male plug)  
 • Plugs into Factory Radio  
 • Power and 4 Speakers  
 S #



**FD-5521-1M**  
 FORD / LINCOLN / MERCURY  
 03-UP (male plug)  
 • Plugs into Factory Radio  
 S #



**FD-45520**  
 FORD / LINCOLN / MERCURY  
 • Amplifier integration harness  
 2003-UP  
 S # H454



**GM-122**  
 2000-UP  
 CHEVY / GMC / PONTIAC / OLDSMOBILE  
 • Radio data retention / relocation harness  
 • Incorporated relays retain factory door chime  
 S # H449

WIRING HARNESS

124

XSCORPION



**GM-1341**  
**GENERAL MOTORS**  
 73-93 (12 PIN)  
 • Plugs into factory radio  
 • Power / 4 Speakers  
 S # H462



**GM-1342**  
**GENERAL MOTORS**  
 73-93 (12 PIN)  
 • Plugs into factory harness  
 Power / 4 Speakers  
 S # H412



**GM-1343M**  
**GENERAL MOTORS**  
 88-UP (21 Pin)  
 Plugs into factory radio  
 Power / 4 Speakers (MALE PLUG)  
 S # H413



**GM-1344**  
**GENERAL MOTORS**  
 88-UP (21 Pin)  
 • Plugs into factory harness  
 S # H410



**GM-1346**  
**GENERAL MOTORS**  
 94-UP (32 Pin)  
 • Plugs into factory harness  
 Power / 4 Speakers  
 S # H411



**GM-1346R**  
**BUICK / OLDS MOBILE / PONTIAC**  
 2000-05  
 • Plugs into Factory Harness  
 S #



**GM-1347M**  
**GENERAL MOTORS**  
 94-UP (32 Pin)  
 • Plugs into factory radio  
 Power / 4 Speakers (MALE PLUG)  
 S # H414



**GM-1348**  
**SATURN (ALL MODELS)**  
 2000-UP (24 Pin)  
 • Plugs into factory harness  
 Power / 4 Speakers  
 S # H409



**GM-1350**  
**GENERAL MOTORS**  
 04-UP  
 • Saturn non-amplified harness  
 • Plugs into factory harness  
 S # H465



**GM-1351M**  
**GM (SATURN)**  
 04-UP (male plug)  
 • Saturn Harness into OEM Radio  
 • Plugs into Factory Radio  
 S #



**GM-1354**  
**GM (SATURN)**  
 04-05 (Non Amplified Systems)  
 • Plugs into Factory Harness  
 S #



**GM-1404**  
**GENERAL MOTORS**  
 04-UP  
 CHEVY MALIBU  
 • Plugs into factory harness  
 S # H466



**GM-1405M**  
**GENERAL MOTORS**  
 06-UP (male plug)  
 06 Chevrolet HHR & 06 Pontiac Solstice  
 • Plugs into Factory Radio  
 S #



**GM-1406**  
**GENERAL MOTORS**  
 06-UP  
 • Plugs into factory harness  
 S # H464



**GM-1406PIO**  
**GENERAL MOTORS**  
 06-UP  
 Vehicles Equipped or Configure with  
 Pioneer Audio System  
 • Plugs into Factory Harness  
 S #



**GM-1409M**  
 GENERAL MOTORS  
 07-UP (male plug)  
 (Select Vehicles)  
 • Plugs into Factory Radio  
 S #



**GM-1410**  
 GENERAL MOTORS  
 07-UP (Select Vehicles)  
 • Plugs into Factory Harness  
 S #



**GM-1411M**  
 SATURN ION / VUE  
 06-UP (male plug)  
 • Plugs into Factory Radio  
 S #



**GM-1412**  
 SATURN ION / VUE  
 06-UP  
 • Plugs into Factory Harness  
 S #



**GM-1415M**  
 CHEVY / PONTIAC / TOYOTA  
 00-UP (24 Pin)  
 • Plugs into factory radio (MALE PLUG)  
 S # H415



**GM-1416**  
 General Motors 98-UP  
 KIA Sorrento EX 2003, Toyota Matrix 2003,  
 Hyundai Santa Fe with Monsoon 2003  
 Power / 4 Speakers  
 • Plugs into factory harness  
 S # H444



**GM-1417M**  
 GENERAL MOTORS  
 98-UP (24 PIN)  
 • Plugs into factory radio (male plugs)  
 S # H461



**GM-1419M**  
 GENERAL MOTORS  
 Chevy Cobalt & Equinox 05  
 Malibu & Malibuamax 04-05  
 Pontiac G6 05 (male plug)  
 • Plugs into Factory Radio  
 S #



**GM-1466**  
 GENERAL MOTORS  
 2003-UP  
 • Installs aftermarket radio when no factory  
 radio is present  
 S # H463



**GM-4344**  
 PONTIAC GRAND PRIX 00-03  
 CHEVROLET CORVETTE 99-03  
 • Amplifier integration harness  
 S # H471



**GM-4436**  
 OLDSMOBILE CUTLASS SUPREME  
 96-97  
 • Amplifier integration harness  
 S # H469



**GM-4446**  
 OLDSMOBILE AURORA 95-99  
 INTRIGUE 98-01  
 • Amplifier integration harness  
 S # H468



**GM-4466**  
 OLDSMOBILE / BRAVADA  
 98-03  
 • Amplifier integration harness  
 S # H470



**GM-4488**  
 IMPALA / MONTE CARLO JUMPER  
 2000-2001  
 • AMP bypass jumper  
 • Bypasses AMP and creates a loop  
 S # H460



**GM-4556**  
 GM TRUCKS  
 99-02  
 • On-Star pre-amp 9 pin harness  
 • Can be used with an amplifier and speaker  
 and amplified speaker  
 S # H467



**HON-190**  
**HONDA**  
 03-UP  
 • Honda dual zone to single zone harness  
 S # H472



**HON-1804**  
**HONDA / ACURA**  
 86-98  
 • Plugs into factory harness  
 Power / 4 Speakers  
 S # H417



**HON-1805M**  
**HONDA / ACURA**  
 86-98  
 • Plugs into factory radio  
 Power / 4 Speakers (MALE PLUG)  
 S # H419



**HON-1806**  
**HONDA / ACURA / SUZUKI**  
 98 UP  
 • Plugs into factory harness  
 Power / 4 Speakers  
 S # H416



**HON-1807M**  
**HONDA / ACURA / SUZUKI**  
 98 UP  
 • Plugs into factory radio  
 Power / 4 Speakers (MALE PLUG)  
 S # H418



**HON-1810**  
**HONDA**  
 08-UP  
 • Plugs into Factory Harness  
 S #



**HON-1811M**  
**HONDA**  
 08-UP (male plug)  
 • Plugs into Factory Radio  
 S #



**HON-1812**  
**HONDA / CIVIC / CRV / PILOT**  
 06-UP  
 • Plugs into Factory Harness  
 S #



**HON-1813M**  
**HONDA**  
 06-UP (male plug)  
 • Plugs into Factory Radio  
 S #



**HON-1820**  
**HONDA**  
 03-UP  
 • Plugs into factory harness  
 S # H473



**HON-4802**  
**HONDA ACORD**  
 93-94  
 • Amplifier integration harness  
 S # H474



**HON-4808**  
**ACURA RSX**  
 02-03  
 • Amplifier integration harness  
 S # H475



**HYU-2200**  
**HYUNDAI**  
 SONATA 89-91  
 HYUNDAI EXCEL 86-94  
 • Plugs into factory harness-Power / 4 Speakers  
 S # H425



**HYU-11100**  
**HYUNDAI**  
 91-02  
 • Plugs into factory harness  
 Power / 4 Speakers  
 S # H424



**HYU-11101M**  
**HYUNDAI**  
 91-99 (male plug)  
 • Plugs into Factory Radio  
 S #



**HYU-111102**  
 HYUNDAI / KIA  
 99-UP  
 • Plugs into Factory Harness  
 S # H616



**HYU-111103M**  
 HYUNDAI / KIA  
 99-UP (male plug)  
 • Plugs into Factory Radio  
 S #



**HYU-111106**  
 HYUNDAI / KIA  
 06-UP  
 • Plugs into car factory harness  
 S # H488



**HYU-111107M**  
 HYUNDAI / KIA  
 05-UP (male plug)  
 • Plugs into Factory Radio  
 S #



**HYU-111108**  
 HYUNDAI SANTA FE  
 07-UP  
 • Plugs into Factory Harness  
 S #



**HYU-111109M**  
 HYUNDAI SANTA FE  
 07-UP (male plug)  
 • Plugs into Factory Radio  
 S #



**ISU-1974**  
 ISUZU 85-95  
 HONDA PASSPORT 94-95  
 • Plugs into factory harness  
 Power / 4 Speakers  
 S # H443



**ISU-1975M**  
 GEO / ISUZU  
 86-97 (male plug)  
 • Plugs into Factory Radio  
 S #



**ISU-1976**  
 ISUZU 95-UP  
 HONDA PASSPORT 96-UP  
 • Plugs into factory harness  
 S # H447



**ISU-1977M**  
 HONDA PASSPORT / ISUZU  
 95-UP (male plug)  
 • Plugs into Factory Radio  
 S #



**ISU-1978**  
 ISUZU  
 03-UP  
 • Amplifier Integration Harness  
 S #



**JP-1622**  
 JEEP  
 88-96  
 Plugs into factory harness  
 Power / 4 Speakers  
 S # H439



**JP-1623M**  
 JEEP  
 88-96 (male plug)  
 • Plugs into Factory Radio  
 S #



**KIA-1832**  
 KIA  
 95-UP  
 • Plugs into factory harness  
 Power / 4 Speakers  
 S # H427



**MAZ-1856**  
 MAZDA  
 89-02  
 • Plugs into factory harness  
 Power / 4 Speakers  
 S # H441



**MAZ-1857M**  
MAZDA  
89-02 (male plug)  
• Plugs into Factory Radio  
S #



**MAZ-1858**  
MAZDA  
01-UP  
• Plugs into Factory Harness  
S #



**MAZ-1859M**  
MAZDA  
01-UP (male plug)  
• Plugs into Factory Radio  
S #



**MIT-1644**  
MITSUBISHI  
07-UP  
• Plugs into Factory Harness  
S #



**MIT-1645M**  
MITSUBISHI  
07-UP (male plug)  
• Plugs into Factory Radio  
S #



**NIS-1700**  
NISSAN  
84-94  
• Plugs into factory harness  
Power / 4 Speakers  
S # H420



**NIS-1701M**  
NISSAN  
84-94  
• Plugs into factory radio  
Power / 4 Speakers (MALE PLUGS)  
S # H423



**NIS-1702**  
NISSAN  
95-UP  
• Plugs into factory harness  
Power / 4 Speakers  
S # H421



**NIS-1703M**  
NISSAN  
95-UP  
• Plugs into factory radio  
Power / 4 Speakers (MALE PLUG)  
S # H422



**NIS-1705M**  
NISSAN  
07-UP (male plug)  
• Plugs into Factory Radio  
S #



**NIS-1708**  
NISSAN  
07-UP  
• Plugs into Factory Harness  
S #



**NIS-4700**  
NISSAN / INFINITY  
87-94 (premium sound)  
• Plugs into car harness at radio  
S # H476



**NIS-4702**  
NISSAN / INFINITY  
95-UP (premium sound)  
• Plugs into factory harness  
S # H477



**SMA-22100**  
SMART CAR  
08-UP  
• Plugs into Factory Harness  
S #



**SUB-1924**  
SUBARU  
90-UP  
• Plugs into factory harness  
Power / 4 Speakers  
S # H442



### SUZ-1960

SUZUKI  
95-03  
• Plugs into Factory Harness  
S #



### SUZ-1961M

SUZUKI  
95-03 (male plug)  
• Plugs into Factory Radio  
S #



### TOY-1950

TOYOTA  
87-UP  
• Plugs into factory harness  
Power / 4 Speakers  
S # H433



### TOY-1951M

TOYOTA  
87-UP  
• Plugs into factory radio  
Power / 4 Speakers (MALE PLUG)  
S # H434



### TOY-1960

TOYOTA / LEXUS  
2000-04  
• Plugs into Factory Harness  
S #



### TOY-1961M

TOYOTA  
2000-04 (male plug)  
• Plugs into Factory Radio  
S #



### TOY-4940

TOYOTA  
84-87  
• Amplifier integration harness  
S # H478



### TOY-4960

TOYOTA / LEXUS  
92-UP (premium amplifier integration harness)  
• Integrates aftermarket radio with factory amplifier  
• Plugs into factory harness  
S # H479



### VOL-11054

VOLVO  
2000-04 (Select Vehicles)  
• Plugs into Factory Harness  
S #



### VOL-11058

VOLVO  
• S-60 01-UP • S-80 99-UP  
• V70 / XC / CROSS COUNTRY 01-UP  
• Plugs into factory harness • Power / 4 Speakers  
S # H438



### VOL-11059M

VOLVO  
• S-60 01-UP • S-80 99-UP  
• V70 / XC / CROSS COUNTRY 01-UP  
• Plugs into factory radio • Power / 4 Speakers  
(Male Plugs)  
S # H450



### VW-11000

VOLKSWAGEN  
87-02  
• Plugs into factory harness  
S # H435



### VW-11004

VW  
87-02  
• Plugs into Factory Harness (Active System)  
S #



### VW-12000M

VOLKSWAGEN  
87-02 (MALE PLUG)  
• Plugs into factory radio  
S # H436



### VW-41000

VOLKSWAGEN  
87-02  
• Amplifier integration harness  
• Plugs into car harness  
S # H487

WIRING HARNESS





**AL 16-000**  
ALPINE 16 PIN  
S # H504



**AL 16-04**  
ALPINE 16 PIN  
2004-UP  
CDE-9845 / CDE-9843  
S # H518



**CL 12-000**  
CLARION 12 PIN  
S # H511



**CL 16-000**  
CLARION 16 PIN  
S # H501



**CL 16-02**  
CLARION 16 PIN  
2002-UP  
S # H515



**JVC 16-000**  
JVC 16 PIN  
S # H508



**JVC16-009**  
JVC 16PIN  
2009-UP  
S # H524



**KN 12-000**  
KENWOOD 12 PIN  
S # H510



**KN 16-000**  
KENWOOD 16 PIN  
S # H509



**PA 16-000**  
PANASONIC 16 PIN  
S # H502



**PA 16-04**  
PANASONIC 16 PIN  
2004-UP  
S # H517



**PI 16-001**  
PIONEER 16 PIN  
2001  
S # H513



**PI 16-002**  
PIONEER 16 PIN  
2002  
S # H514



**PI 16-10**  
Pioneer 2010-up Car Stereo  
Harness  
S #



**PI 2003-4**  
PIONEER 16 PIN  
2003-04  
S # H516



**PI 2006-UP**  
Pioneer 2006-up Car  
Stereo Harness  
S #



**SY 16-000**  
SONY 16 PIN  
S # H503



**UI-1990**  
UNIVERSAL IMPORT  
• Plugs into factory harness  
Power / 4 Speakers  
S # H440

CHRYSLER. FORD. GM. HONDA. ISUZU. JEEP. MAZDA. NISSAN. TOYOTA  
**EXTERNAL POWER HARNESSES**



**CHR-2634**  
 CHRYSLER / DODGE / PLYMOUTH / JEEP  
 85-UP  
 • Plugs into car factory radio & harness  
 S # H610



**CI-2612**  
 CHRYSLER IMPORTS / MITSUBISHI  
 92-UP  
 DODGE STEALTH 94-96  
 • Plugs into factory radio & harness  
 S # H611



**FD-2594**  
 FORD / LINCOLN / MERCURY / MAZDA  
 85-UP  
 • Plugs into factory radio & harness  
 S # H600



**FD-2598**  
 FORD / LINCOLN / MERCURY / MAZDA  
 98-UP  
 • Plugs into factory radio & harness  
 S # H601



**GM-2344**  
 GENERAL MOTORS  
 88-UP  
 • Plugs into factory radio & harness  
 S # H602



**GM-2342**  
 GENERAL MOTORS  
 73-93  
 • Plugs into factory radio & harness  
 S # H603



**HON-2804**  
 HONDA / ACURA  
 86-UP  
 • Plugs into factory radio & harness  
 S # H604



**HON-2806**  
 HONDA / ACURA  
 98-UP  
 • Plugs into factory radio & harness  
 S # H605



**ISU-2974**  
 GEO 89-UP  
 HONDA PASSPORT 94-95  
 ISUZU 85-95  
 • Plugs into factory radio & harness  
 S # H613



**ISU-2976**  
 ISUZU 95-UP  
 HONDA PASSPORT 96-UP  
 ISUZU AMIGO 98-00 / RODEO 95-UP  
 TROOPER 96-UP / VEHICROSS 99-UP  
 • Plugs into factory radio & harness  
 S # H614



**JP-2622**  
 JEEP EAGLE  
 84-UP  
 • Plugs into factory radio & harness  
 S # H612



**MAZ-2856**  
 MAZDA  
 89-UP  
 • Plugs into factory radio & harness  
 S # H608



**NIS-2700**  
 NISSAN  
 84-94  
 • Plugs into factory radio & harness  
 S # H606



**NIS-2702**  
 NISSAN  
 95-UP  
 • Plugs into factory radio & harness  
 S # H607



**TOY-2950**  
 TOYOTA  
 87-UP  
 • Plugs into factory radio & harness  
 S # H609

EXTERNAL POWER HARNESSES

### Stereo to IPOD



**AL-IP8**  
Alpine Stereo to IPOD Adapter  
2007-Up



**ALA-IP**  
ALPINE AI-NET to IPOD  
• Connects Alpine AI-NET stereo aux audio input to IPOD



**ALM-IP**  
ALPINE M-BUS to IPOD  
• Connects Alpine M-BUS stereo aux audio input to IPOD



**KEN-IP**  
KENWOOD to IPOD  
• Connects KenwoodT stereo aux audio input to IPOD



**KEN-IP8**  
Kenwood Stereo To IPOD Adapter 2007-Up



**PIO-IP**  
PIONEER to IPOD  
• Connects Pioneer stereo aux audio input to IPOD



**PIO-IP8**  
Pionner Stereo To IPOD Adapter  
2007-Up



**RCA-IP**  
RCA to IPOD / UNIVERSAL  
• Connects any stereo with RCA audio input to IPOD  
(RCA to 3.5mm phone plug is included)

## DIN to RCA adapters



**ALAIXR**  
ALPINE AI-NET  
& JVC AND SONY AUXILIARY  
INPUT ADAPTER



**KN13XR**  
KENWOOD AUXILIARY INPUT  
ADAPTER (13 PIN)



**PIPBXR**  
PIONEER XM SATELLITE  
RADIO INTERFACE  
IP-BUS to RCA ADAPTER



**ALMBXR**  
ALPINE M-BUS INPUT  
ADAPTER

## Extensions



**AL8PX**  
ALPINE 8 PIN AUXILIARY  
CONNECTING  
CABLE EXTENSION  
(16.5 FT / 5M)



**ALSJX**  
ALPINE AI-NET / SONY / JVC  
DIN TO DIN AUXILIARY  
CONNECT CABLE / EXTENSION  
(16.5 FT / 5M)



**KN13PX**  
KENWOOD 13 PIN DIN TO DIN  
AUXILIARY  
CONNECTING CABLE / EXTENTION  
(16.5 FT / 5M)



**PIPDX**  
PIONEER FOR ALL P-DEVICES  
DIN TO DIN AUXILIARY  
CONNECTING CABLE / EXTENSION  
(16.5 FT / 5M)



**CLCNX**  
CLARION (CE-NET)  
DIN TO DIN AUXILIARY  
CONNECTING CABLE / EXTENTION  
(16.5 FT / 5M)



**PACX**  
PANASONIC AUXILIARY  
CONNECTING CABLE  
(16.5 FT / 5M)



### CHR-A16

CHRYSLER / DODGE / JEEP / FORD /  
LINCOLN / MERCURY / GM  
2002-UP

- Converts factory Chrysler antenna to standard Motorola male use when replacing factory radio  
S # A141



### CHR-A17

CHRYSLER / DODGE / JEEP / FORD /  
LINCOLN / MERCURY / GM  
2002 UP

- Converts factory Chrysler radio to standard Motorola female use when replacing factory antenna  
S # A142



### CHR-A67

CHRYSLER / DODGE / JEEP / FORD /  
LINCOLN / MERCURY / GM  
2002-UP

- use when adding FM modulated CD charger, satellite tuner, video or DVD to existing systems.  
S # A143



### EURO-A67

BMW / VW / CHRYSLER / DODGE / JEEP  
2002-UP

- Use when adding a FM-Modulated CD charger to non-amplified antenna systems.  
S # A121



### EURO-A106

BMW / VW / CHRYSLER / DODGE / JEEP  
2002-UP

- Converts antenna lead to standard Motorola male. Use when replacing factory radios  
S # A119



### EURO-A107

BMW / VW / CHRYSLER / DODGE / JEEP  
2002-UP

- Converts standard Motorola female to OEM antenna male. Use when replacing factory non-amplified antenna  
S # A120



### EURO-A108

BMW / VW  
2002-UP

- Converts BMW / VW amplified antenna to standard male. Use when replacing factory OEM radio vehicles with amplified antennas  
S # A144



### EURO-A666

VW / AUDI / MOST EUROPEAN  
1950-UP

- Aftermarket Radio to Screw On Antenna  
S #



### EURO-A777

VW / AUDI / MOST EUROPEAN  
1950-UP

- Aftermarket Antenna to Antenna Cable  
S #



### FD-A16

FORD / LINCOLN / MERCURY  
95-UP

- Converts Factory Ford Antenna To Standard Motorola Male use when replacing factory radio  
S # A137



### FD-17

FORD / LINCOLN / MERCURY  
95-UP

- Converts Factory Ford Radio To Standard Motorola Female use when replacing factory antenna  
S # A138



### FD-A67

FORD / LINCOLN / MERCURY  
95-UP

- use when adding FM modulated CD changer, satellite tuner, video or DVD to existing systems.  
S # A139



### GM-A36

General Motors  
88-UP

- (Short version of GMA16)  
S # A117



### GM-A16

General Motors  
88-UP

- Converts mini GM to standard Motorola male Use when replacing factory Radio  
S # A115



### GM-A17

General Motors  
88-UP

- Converts standard Motorola to GM radios Use when replacing factory antenna with aftermarket Radios  
S # A116

# ANTENNA ADAPTERS

GM. HONDA. HYUNDAI. KIA. LEXUS. NISSAN



## GM-A67

General Motors  
88-UP

• Use when adding a FM-Modulated CD changer, Satellite Tuner or Video or DVD to Existing Systems  
S # A118



## HON-A106

HONDA  
2005-UP

Use When Replacing Factory Radio  
S # A156



## HON-A107

HONDA  
2005-UP

Use When Replacing Factory Antenna  
S # A157



## HON-A1067

HONDA  
2005-UP

Use when Adding an RF Modulated CD Changer, Satellite Tuner, Video or DVD to Existing System.  
S # A158



## HYU-A106

KIA  
07-UP

Use When Replacing Factory Radio  
S #



## HYU-A107

KIA  
07-UP

Use When Replacing Factory Antenna  
S #



## HYU-A1067

KIA  
07-UP

Use When Adding an RF Modulated, CD Changer, Satellite Tuner or Video to Existing System.  
S #



## KIA-A106

KIA  
2007-UP

Use When Replacing Factory Radio  
S # A159



## KIA-A107

KIA  
2007-UP

Use When Replacing Factory Antenna  
S # A160



## KIA-A1067

KIA  
2007-UP

Use when Adding an RF Modulated CD Changer, Satellite Tuner, Video or DVD to Existing System.  
S # A161



## LEX-A106

LEXUS  
2002-UP

Use When Replacing Factory Radio  
S # A153



## LEX-A107

LEXUS  
2002-UP

Use When Replacing Factory Antenna  
S # A154



## LEX-A1067

LEXUS  
2002-UP

Use when Adding an RF Modulated CD Changer, Satellite Tuner, Video or DVD to Existing System.  
S # A155



## NIS-A106

NISSAN  
2006-UP

Use When Replacing Factory Radio  
S # A162



## NIS-A107

NISSAN  
2006-UP

Use When Replacing Factory Antenna  
S # A163



## NIS-A1067

NISSAN  
2006-UP

Use when Adding an RF Modulated CD Changer, Satellite Tuner, Video or DVD to Existing System.  
S # A164



## NIS-A17

NISSAN  
87-UP

• Converts standard Motorola female to OEM Nissan male use when replacing factory antenna  
S # A132



## NIS-A19

NISSAN  
87-UP

• Converts OEM Nissan antenna to standard Motorola male use when replacing factory radio  
S # A131

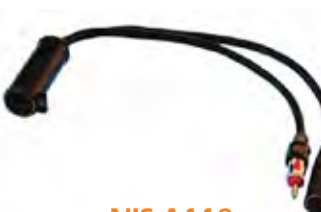

## NIS-A110

NISSAN  
87-UP

• Nissan Diversity Antenna Adapter Plug to aftermarket radio  
S # A134



## NIS-A97

NISSAN  
87-UP

• use when adding FM modulated CD charger, satellite tuner or video or DVD to existing systems.  
S # A133



## NISS-A115

NISSAN  
87-UP

• Single male plug to after market radio  
S # A135



## NIS-A120

NISSAN  
87-UP

• Nissan Diversity Antenna Adapter Plug to aftermarket antenna  
S # A136



## NIS-A1020

NISSAN  
87-UP

• Nissan Diversity Antenna Adapter for adding CD with FM modulated, video, DVD or satellite tuner to existing systems  
S # A140



## SUB-A106

SUBARU  
2005-UP

Use When Replacing Factory Radio  
S # A150



## SUB-A107

SUBARU  
2005-UP

Use When Replacing Factory Antenna  
S # A151



## SUB-A1067

SUBARU  
2005-UP

Use when Adding an RF Modulated CD Changer, Satellite Tuner, Video or DVD to Existing System.  
S # A152



## UNI-Y2FM

UNIVERSAL

1 Male to 2 Female Adapter  
S # A111



## UNI-Y2M

UNIVERSAL

1 Female to 2 Male Adapter  
S#A112



## UNI-A45

1 FT Universal  
Male to Male Adapter  
S # A108



## UNI-A46

1 FT Universal  
Female to Female Adapter  
S # A109



**UNI-A47**  
1 FT Universal  
Right angle extension  
S #A110



**VW-A16S**  
BMW / MERCEDES / VW / AUDI  
90-UP  
• Converts antenna lead to standard Motorola male. Use when replacing factory radios.  
S #A122



**VW-A16L**  
BMW / MERCEDES / VW / AUDI  
90-UP  
• Converts antenna lead to standard Motorola male. Use when replacing factory radios.  
Long version of VW-A16S  
S #A123



**VW-A17**  
BMW / MERCEDES / VW / AUDI  
90-UP  
• Converts standard Motorola female to OEM antenna male Use when replacing factory non-amplified antenna systems  
S #A124



**VW-A18**  
VW / AUDI  
96-UP  
• Converts VW / AUDI amplified antenna to standard Motorola male Use when replacing factory OEM radio on vehicles with amplified antennas  
S #A125



**VW-A67**  
BMW / MERCEDES / VW / AUDI  
90-UP  
• Use when adding a FM-Modulated CD changer, satellite tuner or Video or DVD to existing system.  
S #A126



**VW-A121**  
BMW / MERCEDES / VW / AUDI  
90-UP  
• Euro reverse antenna adapter radio to aftermarket flat antenna.  
S #A127



**VOL-A106**  
VOLVO  
99-UP  
(Factory antenna to aftermarket radio)  
• Converts antenna lead to standard motorola male  
Use when replacing factory radio  
S #A128



**VOL-A107**  
VOLVO  
99-UP  
(Volvo Factory Radio to universal antenna)  
Converts standard Motorola female to OEM antenna male. Use when replacing factory non-amplified antenna systems  
S #A129



**VOL-A67**  
VOLVO  
99-UP  
Use when adding a FM-Modulated CD changer to non-amplified antenna systems.  
S #A130



**AMP-55**  
UNIVERSAL ANTENNA  
MALE PLUG (5 pcs)  
S #



**AFP-99**  
UNIVERSAL ANTENNA  
FEMALE PLUG (5 pcs)  
S #

## Universal Antenna Extension

<b>EXT 1</b>	1 ft. Extension	S #A101
<b>EXT 3</b>	3 ft. Extension	S #A102
<b>EXT 6</b>	6 ft. Extension	S #A103
<b>EXT 12</b>	12 ft. Extension	S #A104
<b>EXT 18</b>	18 ft. Extension	S #A105
<b>EXT 25</b>	25 ft. Extension	S #A106





# TABLE OF CONTENT

<b>Staple Guns</b>	<b>4</b>
<b>Mini Air Tools</b>	<b>5</b>
<b>Air Tools</b>	<b>6</b>
<b>Hole Saws, Drill Bits, Step Drills</b>	<b>7</b>
<b>Wire Cutters, Crimpers &amp; Strippers</b>	<b>8-11</b>
<b>Aviation Snips</b>	<b>12</b>
<b>Shears</b>	<b>13</b>
<b>Fiber Glass Tools</b>	<b>14</b>
<b>Brushes, Rollers</b>	<b>15</b>
<b>File Sets</b>	<b>16</b>
<b>Soldering-Torch-Heat Gun, Glue Gun, Caulking Gun</b>	<b>17</b>
<b>Buffing Wheels</b>	<b>18</b>
<b>Hex Keys</b>	<b>19</b>
<b>Window &amp; Door Clip Remover, Door Panel Fastener Remover Tape Measure, Screw Drivers, Drill Bit, Pry &amp; Chisel Tools</b>	<b>20</b>
<b>Radio Removal Keys</b>	<b>21</b>
<b>Safety Glasses and Respirators</b>	<b>22</b>

# STAPLE GUNS

## Upholstery Air Stapler

### US-2258

Air Upholstery Stapler 22 gauge  
Leg Length 3/8" to 5/8"  
Magazine Capacity 156  
Pressure Range 70 to 100 psi  
Firing Mode Automatic  
Swivel Connector



 1/4" — 5/8" (6mm — 16mm)  
Crown: 3/8" (9mm)  
22 Gauge 0.03" X 0.0215" (0.76mm X 0.55mm)



 3/4" — 2" (20mm — 50mm)  
18 Gauge 0.05" X 0.039" (1.25mm X 1.00mm)

## Brad Air Nailer

### BN-182

Drives a range of 18 gauge brad nails, from 5/8" to 2", into hard or soft wood applications; magazine application is up to 100 nails.

Quick release cam-lock opens nail guide assembly to easily clear jammed nails; efficient design minimizes downtime

Easy to use "tool-less" depth adjustment dial for a wide variety of finish applications

Non-marring rubber nose and bumpers protect the wood's surface from being scratched or damaged

Tool hook can be rotated 180° and attached on either left or right side so tool can remain close by, but never in the way

Multi-directional exhaust port rotates 360° to direct exhaust air away from user Rubber covered hand grip for non-slip, comfortable contact

Swivel Connector

## Narrow Crown Air Stapler

### NCS-158

Air Finishing Stapler, Narrow Crown  
Leg Length 1/2 to 1-5/8"  
18 gauge  
Magazine Capacity 100  
CFM per Shot 0.047  
Pressure Range 70 to 120 psi  
Swivel Connector



 5/8" — 1-9/16" (16mm — 40mm)  
Crown: 1/4" (5.7mm)  
18 Gauge 0.05" X 0.039" (1.25mm X 1.00mm)



## 1/4" Mini Angle Die Grinder

### MAG-14

1/4" Mini Air Angle Die Grinder

- Collect Size: 6mm or 1/4"
- Free Speed: 22,000rpm
- Motor: 0.3hp
- Air Inlet: 1/4"
- Length 120mm
- Swivel Connector



## 2" Mini Angle Grinder

### MG-2

2" Mini Air Angle Grinder

- Grinding Wheel Size: 2"
- Free Speed: 22,000rpm
- Motor: 0.3hp
- Air Inlet: 1/4"
- Length 120mm
- Swivel Connector



## 2" Mini Angle Sander

### MAS-2

2" Mini Air Angle Sander

- Pad Size: 2"
- Free Speed: 22,000rpm
- Motor: 0.3hp
- Air Inlet: 1/4"
- Length 120mm
- Swivel Connector



## Mini Air Ratchet

### MSR-38

3/8" Mini Air Ratchet Wrench/Screw Driver

- Torque: 20ft-lb
- Ratchet Anvil: 3/8"
- Screwdriver Shank: 1/4"
- Free Speed: 280rpm
- Air Inlet: 1/4"
- Length 140mm
- Swivel Connector



## Mini Air Grinder

### MSDG-14

1/4" Mini Straight Air Die Grinder

- Collect Size: 6mm or 1/4"
- Free Speed: 30,000rpm
- Motor: 0.3hp
- Air Inlet: 1/4"
- Length 120mm
- Swivel Connector



## Reciprocating Air Body Saw

### LVBS-1

Low Vibration & Low Noise Air Body Saw

- Stroke: 3/8" (10mm)
- Speed: 10,000rpm
- Cutting Capacity: 2mm Steel Sheet
- Vibration: 3 m/s<sup>2</sup>
- Total Length 260mm
- 2.5 Average CFM @ 15 Second Run Time, 9.0 CFM @ Full Load
- Required Pressure 90 psi
- Air Inlet 1/4 In. NPT
- Min. Hose Size 3/8 In.
- Housing Material Aluminum
- Lock Off Lever Throttle
- No Variable Speed
- Cuts Flat and Curved Surfaces
- High Speed Steel Cutting Blade



## Air Blow Gun

### TABG-2

Turbo Venturi Pistol Grip Blow Gun features a Venturi nozzle that makes it ideal for cleaning debris from a work space, drying wet surfaces, blowing up balloons and more.

The pistol grip trigger provides a nonslip surface for ease of use and helps you control the precise amount of airflow at the tip. With Swivel Connector.



4" EXTENSION NOZZLE



## Narrow Crown Staples

Collation Type Adhesive, Chisel Point Type, Smooth Shank, Steel, Galvanized Finish



XSNC1834	3/4" Length	1/4" Crown	18ga.	2,500pcs
XSNC18100	1" Length	1/4" Crown	18ga.	2,500pcs
XSNC18118	1 1/8" Length	1/4" Crown	18ga.	2,500pcs
XSNC18114	1 1/4" Length	1/4" Crown	18ga.	2,500pcs
XSNC18112	1 1/2" Length	1/4" Crown	18ga.	2,500pcs

## Brad Nails

T-Shape Head Style, Collation Type Adhesive, Chisel Point Type, Smooth Shank, Steel, Galvanized Finish



XSBN1834	3/4" Length		18ga.	5,000pcs
XSBN1858	5/8" Length		18ga.	5,000pcs
XSBN18100	1" Length		18ga.	5,000pcs
XSBN18118	1 1/8" Length		18ga.	5,000pcs
XSBN18114	1 1/4" Length		18ga.	5,000pcs
XSBN16112	1 1/2" Length	Galvanized Finish Nails	16ga.	2,500pcs
XSBN16200	2 Length	Galvanized Finish Nails	16ga.	2,500pcs

## Staples

71 Series Collated Staple, Chisel Point type, Steel, Galvanized Finish

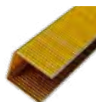

XS-7118 (71 Series)	1/8" Length	3/8" Crown	22ga.	10,000pcs
XS-7114 (71 Series)	1/4" Length	3/8" Crown	22ga.	10,000pcs
XS-7138 (71 Series)	3/8" Length	3/8" Crown	22ga.	10,000pcs
XS-7112 (71 Series)	1/2" Length	3/8" Crown	22ga.	10,000pcs
XS-7158 (71 Series)	5/8" Length	3/8" Crown	22ga.	10,000pcs

# HOLE SAWS



## Hole Saw Set

### HSS-14

14pc M42 Material Hole Saw Set

- 11pcs Hole Saw: 3/4" (19mm) - 3" (76mm)
- 2pcs Arbors: 3/8" Hex, fit 14-30mm  
7/16" Hex, fit 32-216mm
- 1pc Adapter: 1/2" - 20 UNF

Unique tooth design/set pattern for improved metal cutting performance and increased durability.

Improved backing plate prevents warping at holes and increases cycles.

Includes 3/4", 7/8", 1", 1-1/8", 1-3/8", 1-1/2", 1-3/4", 2", 2-1/8", 2-1/4", 2-1/2"



# DRILL BITS



## 21 pcs Drill Bit Set

### TDB-21

21pcs Titanium Finish Drill Bits, M2 HSS Material

- Bit Range: 1/16" - 3/8"
- Tip Type: Double Conoid TW Angle
- Shank: Over 3/16" with three flat shanks

# STEP DRILLS

## Step Drills

M2 HSS STEP DRILL STRAIGHT FLUTE  
THREE-FLATTED SHANK, TIN COATED

### SD18-12

1/8" - 1/2" - 13 Position Titanium Step Drill, 1/4" Shank, M2 HSS Material

### SD14-34

1/4" - 3/4" - 9 Position Titanium Step Drill, 3/8" Shank, M2 HSS Material

### SD916-1

9/16" - 1 - 8 Position Titanium Step Drill, 3/8" Shank, M2 HSS Material



# WIRE CRIMPERS, CUTTERS & STRIPPERS



## Telephone & Data Crimper, Stripper & Cutter

### TCSC-68

Cat3, Cat5e, Cat6

All-in-one crimper for WE/SS-style data and phone cable provides multi-function cutting, stripping and crimping

Crimps RJ45, RJ11/12 and RJ22 handset plugs; cuts and strips round UTP/STP phone and data cable

Advanced ratchet mechanism with emergency release for effortless terminations

Ergonomic handle for reliable grip and all-day comfort

## Quick Wire Stripper, Crimper & Cutter

### QWS-108

Strips & cuts 10-24 AWG (2.6-0.51mm) wire, crimper 10-22 AWG (2.6-0.64mm).

Compound-action tool crimps 10-22 AWG insulated terminals to meet or exceed MIL-SPEC pull-out tests.

Built-in ratchet with safety release assures uniform crimps every time.

Compound lever-action of narrow-span handles puts more crimping power into each squeeze.

Special locator quickly positions terminal for double crimp.

Comfort-grip plastic handles



## Quick Wire Stripper & Cutter

### QWSC-104

Strips 10-24 AWG (2.6-0.51mm) & cuts 24-14 AWG (0.5-1.6mm) wire

Automatically adjusts to wire size.

Easily strips insulation from 10-24 AWG soft wire.

Simply insert amount of wire to be stripped and squeeze handle.

## Automatic Wire Stripper

### AWS-106

Strips 10-18 AWG (2.6-1.02mm) wire

Compound action wire stripping: grip and strip via single action squeezing motion.

Precision machined stripping holes easily remove jacket insulation without damaging the wire.

Remove up to 1" (24 mm) in length of the insulation layer (jacket layer) in a single step.

Tension loaded wire-grip gently holds the wire in place while retaining the cable geometry.

Recoil spring design returns tool to ready position upon cycle completion.

Cast alloy chassis with heavy-duty Ecoat finish for corrosion resistance and durability.



## HD Cable Cutter & Stripper

### CC-06WS

Heavy Duty Electrical Wire & Cable Cutter/Stripper

Cuts any thickness wire up to 1/0 AWG

Strips any wire from 8 to 14 AWG

Curved blade cuts wire up to 8.25mm

Innovative patented design provides greater cutting power and the option for easy repetitive cutting.

Unique design can be used to cut thicker wire using a repetitive cutting process.

Forged from heavy duty Chrome Vanadium steel for greater strength.



## Heavy Duty Cable Cutter

### CC-06

Cuts any thickness wire up to 1/0 AWG (10mm with side knife strip up to 8 AWG)

Innovative patented design provides greater cutting power and the option for easy repetitive cutting.

Unique design can be used to cut thicker wire using a repetitive cutting process.

Compact size is convenient to carry and use in confined work areas.

High transmission ratio results in less strain on hand muscles and reduces hand fatigue.

Forged from heavy duty Chrome Vanadium steel for greater strength.



## Mini Cable Cutter

### MCC-5

Cuts 4-24 AWG (5.19-0.5mm) wire.

Angular offset cutting blades provide a clean cut of coated or uncoated wire rope and steel cable. Will not crush or damage wire ends.

Internal spring mechanism opens the tools in the hand and makes repetitive cutting much easier.

Forged from oil-hardened chrome vanadium electric steel for greater strength and lighter weight.



## Flush Mini Cutter

### FMC-5

Cuts Copper, Metal & Hard Plastic.

Micro-Shear Wire Cutter/ Flush Cut.

These micro-shear flush cutters give you a way to cut leads very cleanly and close to the solder joint.

# WIRE CUTTERS & STRIPPERS



## Adjustable Stripper & Cutter

### AWSC-105

Strips & cuts 10-24 AWG (2.6-0.51mm) wire  
A handy, light, compact tool for stripping insulation.  
Convenient hole for looping or bending wire.  
Cuts, strips, and loops 10-24 solid and stranded wire.



## Wire Stripper & Cutter

### WSC-106

Cuts & strips 10-20 AWG (2.6-0.812mm) wire  
Cuts, strips, loops and bends stranded wire.  
Shear-type cutting blades for clean cuts.  
Spring-loaded action for self-opening.  
Comfortable, plastic-covered handles.



## Wire Stripper & Cutter

### WSC-107C

Cuts & strips 10-20 AWG (2.6-0.812mm) wire  
Precision shear-type blades for clean cuts on solid and stranded copper wire.  
Easy-to-read markings on both sides.  
Curved handles help reach into confined areas.  
Wire looping and bending holes.  
Coil spring provides fast self-opening action.  
Precision-ground stripping holes.  
Strong-gripping serrated nose; for easy bending, shaping, and pulling of wire.  
Screw-shearing holes.  
Handy closure lock for convenient storage.  
Double-dipped comfort grips.



## Mini Wire Stripper

### MWS-105

Strips 10-22 AWG (2.6-0.644mm) wire  
Stripping slots quickly remove outer jacket of Type NM-B non-metallic-sheathed cable.  
Precision staggered blades for square, clean cuts on solid copper wire.  
Narrow nose fits into tight places.  
Precision shear-type blades for square, clean cuts on solid copper wire.  
Curved handles help reach into confined areas.  
Strong-gripping serrated nose; for easy bending, shaping and pulling of wire.  
Wire looping and bending holes.  
Screw-shearing holes.  
Coil spring provides fast self-opening action.  
Handy closure lock for convenient storage.  
Double-dipped comfort grips.





## Mini Crimper

### MC-5

Crimps 10-22 AWG (2.6-0.644mm) insulated terminal.

Angular offset provides a clean crimp every time.

Internal spring mechanism opens the tools in the hand and makes repetitive crimping much easier.

Forged from oil-hardened chrome vanadium electric steel for greater strength and lighter weight.



## Cable Tie Gun

### CTG-6

Tightens & cuts Nylon cable tie 0.09"-0.18" (2.2-4.8mm)

This lightweight tool efficiently tightens and trims cable ties for neat, clean-looking installations.

These ergonomic cable tie guns increase production, and cut ties flush to eliminate sharp edges.



## Crimping Tools

### MGCT-24

24" Heavy Duty Multi-Guage Crimping Tools  
Crimps 8-4/0 AWG (10-120mm)

- Features Ident Crimping
- Longer handles minimise the effort required to produce a perfect crimp
- Crimp size easily selected using screw adjustment



# AVATION SNIPS

- Meets and Exceeds Federal Specifications ANSI/ASME, B107.16 and German Standard DIN6438/11.71
- Cuts all Sheet Metal up to 16 Gauge Cold-Rolled Sheet Metal & 20 Gauge Stainless-Steel Metal.
- 3 Cutting Patterns
- Drop Forged Chrome-Molybdenum Alloy Steel Blades
- Serated Edge Blades, Induction Hardened



**Left Snip**



**ATS-L**  
Aviation Tin Snips (left)



**Sraight Snip**



**ATS-S**  
Aviation Tin Snips (Straight)



**Right Snip**



**ATS-R**  
Aviation Tin Snips (right)

# SHEARS



- 4mm SUS 4202 Japanese Stainless Steel
- Precision-Ground and Hardened for Lasting
- One Blade serrated for Material Control

- Soft Mold Non-Slip Comfort Ergonomic Grips
- Adjustable to Fit Hand
- Patent Pending Handel Design for Left and Right-handed users.



## 8" Heavy-Duty Shears

### HDS-8

8" Heavy Duty Stainless Steel Shears with Wire Cutting Notch

## 8" Heavy-Duty Angled Shears

### HDS-8A

8" Heavy Duty Angled Shears with Wire Cutting Notch



## Kevlar Shears

### KS-8

8" HD Utility/Kevlar Shears (Serrated Blade)

- Right & Left Handed Design Patent
- Cutting Length 2-1/2"
- Handle Type Bent w/Large Bottom Bow

## 8" PRO Stainless-Steel Shears

### SCS-8

8" Professional Grade Stainless Steel Shears



## 5" Stainless-Steel Shears

### SCS-5

5" Stainless Steel Shears



# FIBER GLASS TOOLS



**1/2" Plastic Roller**

**FPR-12.3**  
1/2" x 3" Fiberglass Plastic Roller

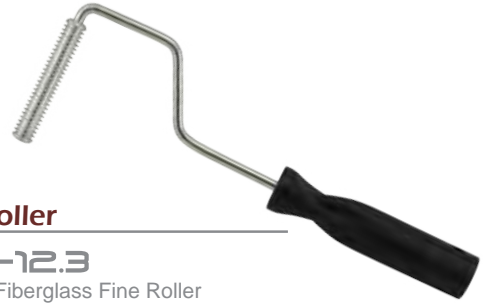

**Fine Roller**

**FFR-12.3**  
1/2" x 3" Fiberglass Fine Roller



**3/4" Plastic Roller**

**FPR-34.3**  
3/4" x 3" Fiberglass Plastic Roller

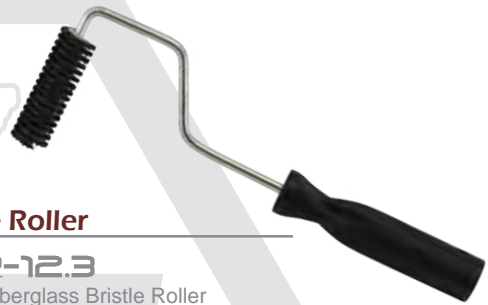

**Bristle Roller**

**FBR-12.3**  
1" x 3" Fiberglass Bristle Roller



**1" Plastic Roller**

**FPR-1.3**  
1" x 3" Fiberglass Plastic Roller

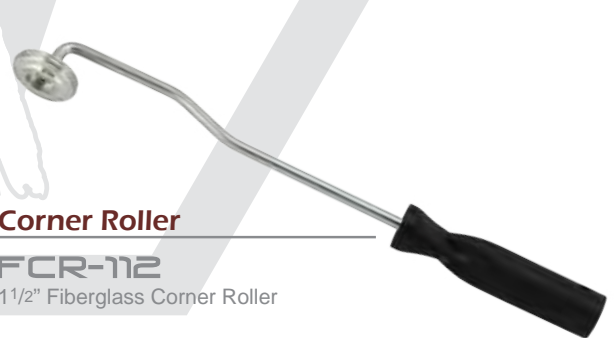

**Corner Roller**

**FCR-112**  
1 1/2" Fiberglass Corner Roller

## Shaver Set

**FGSTS**

5pc compact and light weight molded body works on the pull stroke for efficiency and ease of use.



# ROLLERS



## Rattle Block Rollers (PU)

### **RBR-1P**

1" Roller

### **RBR-2P**

2" Roller

#### **RATTLE BLOCK HEAVY DUTY SOLID PU ROLLER**

- Solid rubber roller that will not scratch surface
- Thick, plated steel frame
- Contoured handle
- Water and rust resistant
- Designed for applying Rattle Block to get the strongest bond possible. Additionally, the roller will help adhere any mounted or glued material.



## Rattle Block Roller (Rubber)

### **RBR-6P**

6" Rattle Block Heavy Duty Roller Tool

- Thick Plated Steel Frame
- 6" Rolling area making it the industries Largest and most effeciant

# BRUSHES



## Chip Brushes

### **CB-1**

1" Chip Brush

### **CB-2**

2" Chip Brush

### **CB-4**

4" Chip Brush

## Wire Brushes

### **3B-NBS**

3 Mini Wire Brushes

Nylon, Brass & Stainless-Steel

Steel Wire Brush is a medium brush for general-purpose cleaning. It is also good for delicate or finish work and can be used to clean aluminum.



# FILE SETS



ROUND

SQUARE

FLAT

HALF-ROUND

HAND



## Bastard Cut File Set

### BSCF-5

10" Bastard Cut 5pc File Set for All Purpose Professional use.

- Ergonomic handles for comfort use and control.
- Includes, 10" Round, 10" Square, 10" Flat, 10" Half-Round, and 10" Hand

## Second Cut File Set

### SCCF-5

10" Second Cut 5pc File Set for All Purpose Professional use.

- Ergonomic handles for comfort use and control.
- Includes, 10" Round, 10" Square, 10" Flat, 10" Half-Round, and 10" Hand

## Smooth Cut File Set

### SMCF-5

10" Smooth Cut 5pc File Set for All Purpose Professional use.

- Ergonomic handles for comfort use and control.
- Includes, 10" Round, 10" Square, 10" Flat, 10" Half-Round, and 10" Hand

# SOLDERING, TORCH & HEAT GUN



## Butane Powered Self-Igniting Multi-Functional Soldering Tool

### BPS13

Soldering Iron, Heat Gun and Blow Torch

- Standard Tip, 3mm Diagonal, 3.5mm Chisel, Hot Knife, Hot Blower, Reflector Tips are included.
- 480F to 1,000F
- 30 to 125Watts
- Temperature Controlled
- Refillable
- The 3-in-1 XScorpion Butane Blow Torch/Soldering Iron/heat gun is lightweight, compact, easy to handle, and is great for a variety of jobs.
- The package features a continuous working lock, and child safety lock.
- Flow control knob makes for convenient operation, and comes with everything else you need to get started (minus butane gas).



# GLUE GUN



## Butane Gas Glue Gun with Automatic Temperature Control

### BGG-2

Hot Melt Butane-Gas Glue Gun

- Portable / cordless
- Hi-Tech PIEZO Electronic Self-ignition
- Easy to Re-fill
- Each Re-fill continuously use up to 2-3 hours
- Automatic Temperature Control  
Off ON 180deg (356F) - ON under 120deg (248F)
- Quick warm up Time in 2 to 3 minutes with and Impressive glue output of over 5-1/2 lbs./hour.

# CAULKING GUN

## Caulking Gun

### CG-9

Heavy-Duty Clauking Gun (Standard Tube)

- Use to caulk around trim giving you a clean air-tight seal
- Use with glue for all various types of wood working applications
- Swinging barrel design keeps the point flush at all times
- Built in paker in shaft
- Fits all standard size caulk and glue tubes



# BUFFING WHEELS



*Feature:*  
Both wheels feature a loose 40ply cotton construction with stitching around the arbor hole, but with looser construction toward the outer edge.



## 8" Buffing Wheel

### CSBW-8

8" x 1/2" x 5/8"  
Cotton stitch Mop

## 8" Buffing Wheel

### LFBW-8

8" x 40P x 5/8"  
Loosefold Border  
Flannel Polishing Mop

## 6" Buffing Wheel

### CSBW-6

6" x 1/2" x 5/8"  
Cotton stitch Mop

## 6" Buffing Wheel

### LFBW-6

6" x 40P x 5/8"  
Loosefold Border  
Flannel Polishing Mop

## SMC Buffers

### SPM-2

2 x 1/2" Shank Polishing Mop

### SPM-4

4 x 1/2" Shank Polishing Mop



## Cylinder Buffer

### CPM-1.5

1 1/2" Cylinder Polishing Mop



## Mushroom Buffers

### MPM-2.5

2 1/2" Mushroom Polishing Mop

### MPM-4.5

4 1/2" Mushroom Polishing Mop



## Taper Buffer

### TPM-2.2

2" x 2" Tapered Polishing Mop



## Compound

### PCR-2W

2 pounds ROUGH polishing compound (white) - specifically for Acrylic surfaces.

### PCF-2W

2 pounds FINE polishing compound (white) - specifically for Acrylic surfaces.

### PC-2R-2

2 pounds Buffing compound for Aluminum (red)

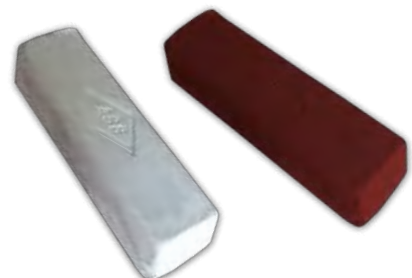



# HEX KEYS



## TX Star Hex Keys

### SKS-8TF

8pcs Trox Star Key Folding-Set  
T9 - T10 - T15 - T20 - T25 - T27 - T30 - T40



## US (SAE) Hex Keys

### HKS-9UF

9pcs Hex Key Folding-Set  
5/64" - 3/32" - 7/64" - 1/8" - 9/64"  
5/32" - 3/16" - 7/32" - 1/4"



## Metric Hex Keys

### HKS-8MF

8pcs Hex Key Folding-Set  
1.5 - 2 - 2.5 - 3 - 4 - 5 - 6 - 8MM



## US (SAE) Hex Keys

### HKS-9UL

9pcs Hex Key Set (L-Shape)  
US (inches)  
5/64" - 3/32" - 1/8" - 5/32"  
3/16" - 7/32" - 1/4" - 5/16" - 3/8"



## Metric Hex Keys

### HKS-9ML

9pcs Hex Key Set (L-Shape)  
Metric  
1.5 - 2 - 2.5 - 3 - 4 - 5 - 6 - 8 - 10MM

## 20pcs Hex Key Set

### HKS-20MU

20pcs Hex Key Set (L-Shape)

Metric (MM)  
1.5 - 2 - 2.5 - 3 - 4 - 5 - 6 - 8 - 10

Imperial (inches)  
1/16" - 5/64" - 3/32" - 1/8" - 5/32"  
3/16" - 7/32" - 1/4" - 5/16" - 3/8"



# CLIP & FASTENER REMOVERS, PRYS & CHISELS



## Window & Door Clip Remover

**WDCR2**

Removes and installs door handel and window crank clips. Works on GM, Ford and others, using "C-Type" clips



## Tape Measure

**TM16**

Self Lock Tape Measure  
16FT (5 Meters) x 3/4" (19mm)

## Philip Screw-driver Bit. PH2

Torsion Bit with Magnetic Tip

**PTB-1**

1 inch

**PTB-2**

2 inch



## Screw Driver

Highly Alloyed CRV Material with Oil Slip Resistance Handle and Magnetized Tip.

**PSD246**

#2 Philips, 4 Inch (102mm) long, 6mm thickness, Satin Finish.

**PSD266**

#2 Philips, 6 Inch (152mm) long, 6mm thickness, Satin Finish.

## Door Panel Fastener Remover

**DPFR6**

Removes door panel, plastic fastener, CRV Hardner material with oil & slip resistance handel.



## Pry & Chisel Tool

Door Panel, Gasket, Dash Kit, Trim Removal and Chisel Set (9 pcs)

**PCT9**

Durable Nylon Plastic (Dark Blue)  
Hard set- This kit is designed to satisfy any and every installers needs. Always have the proper tool for any type of job.

**PCT9S**

Sylacone Type Plastic (Clear)  
Soft set- The soft set is made specifically for high-end vehicle, eliminating the possibility of scratches and chips.

Applications:

- Automotive Interior & Exterior
- Stereo Installation
- Dash & Trim Removal
- Door Panel Removal
- Emblem Removal
- Trim Removal
- Rubber Grommet Removal



# RADIO REMOVAL KEYS



## Radio Removal Keys (38pcs)

**RRK-38**

Keys for:

- Clarion
- JVC
- Kenwood
- Panasonic
- Pioneer
- Sony
  
- Audi
- Becker
- Blaupunkt
- BMW
- Ford
- Grundig
- Mercedes
- Opel
- Porsche
- Skoda
- VW



## Head Unit Removal Keys

**EURO-KEY333**

Mercedes, Audi, Passat and VW (Jetta-Beetle)

1950-UP (1set / 2pcs)



## Head Unit Removal Keys

**RRK-EU7**

VW, Audi, Most European (1set / 2pcs)



## Head Unit Removal Keys

**RRK-FD4**

Head Unit Removal Keys (1set / 2pcs)



## Mercedes Radio

**RRK-MB6**

Mercedes Radio Removal Keys (3sets / 6pcs)

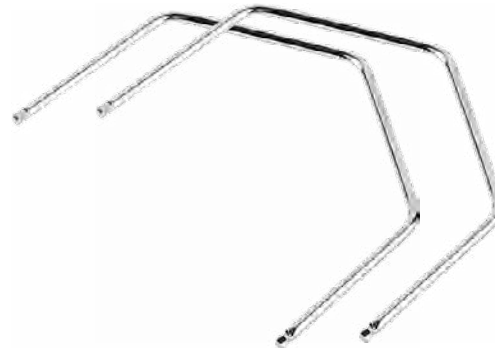

## General Motors - Double DIN

**GM-KEY222DD**

Double-Din Head Unit Removal Keys  
(1set / 2pcs)

# SAFETY GLASSES AND RESPIRATORS



## Safety Glasses - Expert Series

### SG-EXPERT

- Strong Lightweight Nylon Frame
- Scratch-Resistant Blue Mirror Poly-Carbonate Lens
- Adjustable Temple Length
- Extra Clear Poly-Carbonate Lenses
- Travelling Hard Case



## Safety Glasses - PRO Series

### SG-PRO

- Nylon Frame
- Scratch-Resistant Blue Mirror PC Lens
- Blister Package



## Safety Glasses - Installer Series

### SG-INST

- Scratch-Resistant Clear Lens
- Blister Package



## Safety Respirator

### PPR-1E

N95 Approved Protection Particulate Respirator with Ear Loop.

### PPR-1EF

N95 Approved Protection Particulate Respirator Filtering Face piece.